

electronics

MID-MONTH
JUNE 1951

Annual
**BUYERS'
GUIDE
ISSUE**

PRICE • TWO DOLLARS

A MCGRAW-HILL PUBLICATION • 330 WEST 42nd ST. • NEW YORK 18, N. Y.



COMPONENTS FOR EVERY APPLICATION



LINEAR STANDARD
High Fidelity Ideal



HIPERM ALLOY
High Fidelity . . . Compact

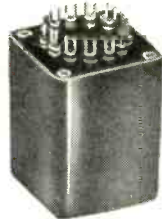

ULTRA COMPACT
Portable . . . High Fidelity



OUNCER
Wide Range . . . 1 ounce

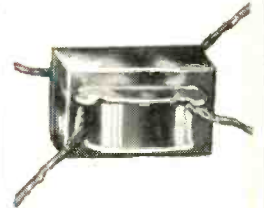

SUB OUNCER
Weight 1/3 ounce



COMMERCIAL GRADE
Industrial Dependability



SPECIAL SERIES
Quality for the "Ham"



POWER COMPONENTS
Rugged . . . Dependable



VARITRAN
Voltage Adjustors



MODULATION UNITS
One watt to 100KW



VARIABLE INDUCTOR
Adjust like a Trimmer



TOROID HIGH Q COILS
Accuracy . . . Stability



TOROID FILTERS
Any type to 300KC



MU-CORE FILTERS
Any type 1/2 - 10,000 cyc.



EQUALIZERS
Broadcast & Sound



PULSE TRANSFORMERS
For all Services



HERMETIC COMPONENTS
Ceramic Terminals



PLUG IN ADAPTER
Impedance Matching



FOSTERITE
Grade 3 JAN Components



CABLE TYPE
For mike cable line

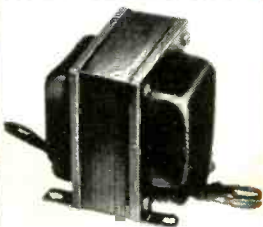

VERTICAL SHELLS
Husky . . . Inexpensive

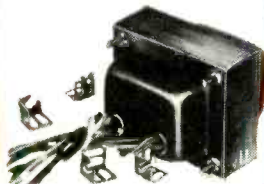

REPLACEMENT
Universal Mounting

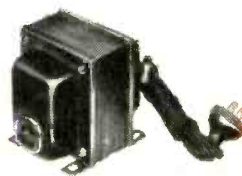

STEP-DOWN
Up to 2500W . . . Stock



LINE ADJUSTORS
Match any line voltage



CHANNEL FRAME
Simple . . . Low cost

United Transformer Co.
150 VARICK STREET NEW YORK 13, N. Y.

EXPORT DIVISION: 13 EAST 40th STREET, NEW YORK 16, N. Y., CABLES: "ARLAB"

electronics BUYERS' GUIDE

JUNE MID-MONTH • 1951

CUMULATIVE INDEX C-1 to C-36

Articles published in **ELECTRONICS** from April 1930 to December 1939

Exact title of each article is listed in alphabetical order.
Each article is also listed alphabetically by the subject
or subjects it represents

AUTHOR INDEX C-28

Name and initials for every author, together with the exact title of the article

DIRECTORY SECTION

ALPHABETICAL PRODUCT LISTING D-1
REGISTERED TRADE NAMES D-133
INDEX OF MANUFACTURERS D-153
DISTRIBUTORS OF ELECTRONIC COMPONENTS AND EQUIPMENT D-165

INDEX TO ADVERTISERS III

A McGRAW-HILL
PUBLICATION

DONALD G. FINK, Editor; **W. W. MacDONALD**, Managing Editor; John Markus, Vin Zeluff, A. A. McKenzie, Associate Editors; William P. O'Brien, James D. Fahnestock, Ronald K. Jurgen, Assistant Editors, John M. Carroll (on Military Leave), Ann Mastropolo, Marilyn Wood, Editorial Assistants; Gladys T. Montgomery, Washington Editor; Harry Phillips, Art Director; Eleanor Luke, Art Assistant

KEITH HENNEY, Consulting Editor

H. W. MATEER, Publisher; **WALLACE B. BLOOD**, Manager; **R. S. Quint**, Buyers' Guide Manager; **D. H. Miller**, James Girdwood, New York; **Wm. S. Hodgkinson**, New England; **Warren W. Shew**, Philadelphia; **C. D. Wardner**, Chicago; **J. L. Phillips**, Cleveland; **J. W. Otterson**, San Francisco; **Carl W. Dysinger**, Los Angeles; **Ralph C. Maultsby**, Atlanta; **Bernard H. Butler**, London, England



June, 1951—Mid-Month

ELECTRONICS
Member ABC and ABP

Vol. 24, No. 6A



Published monthly with an additional issue in June by McGraw-Hill Publishing Company, Inc., James H. McGraw (1860-1948), Founder. Publication Office, 99-129 North Broadway, Albany 1, N. Y.

Executive, Editorial and Advertising Offices: McGraw-Hill Building, 330 W. 42nd St., New York 18, N. Y. Curtis W. McGraw, President; Willard Chevallier, Executive Vice-President; Joseph A. Gerardi, Vice-President and Treasurer; John J. Cooke, Secretary; Paul Montgomery, Senior Vice-President, Publications Division; Ralph B. Smith, Editorial Director; Nelson Bond, Vice-President and Director of Advertising; J. E. Blackburn, Jr., Vice-President and Director of Circulation.

Subscriptions: Address correspondence to **Electronics**—Subscription service, 99-129 N. Broadway, Albany 1, N. Y., or 330 W. 42nd St., New York 18, N. Y. Allow ten days for change of address. Please indicate position and company connection on all subscription orders.

Single copies 75¢ for United States and possessions, and Canada; \$1.50 for Latin America; \$2.00 for all other foreign countries. Buyers' Guide \$2.00. Subscription rates—United States and possessions, \$6.00 a year; \$9.00 for two years; \$12.00 for three years. Canada, \$10.00 a year; \$15.00 for two years; \$20.00 for three years. Pan American countries, \$15.00 a year; \$25.00 for two years; \$30.00 for three years. All other countries, \$20.00 a year; \$30.00 for two years; \$40.00 for three years. Entered as second class matter August 29, 1936, at the Post Office at Albany, N. Y., under act of Mar. 3, 1879. Printed in U. S. A. Copyright 1951 by McGraw-Hill Publishing Co., Inc.—All Rights Reserved. BRANCH OFFICES: 520 North Michigan Avenue, Chicago 11, Ill.; 68 Post Street, San Francisco 4; Aldwych House, Aldwych, London, W.C. 2; Washington, D. C. 4; Philadelphia 3; Cleveland 15; Detroit 26; St. Louis 8; Boston 16; Atlanta 3, Ga.; 1111 Wilshire Blvd., Los Angeles 17; 738-9 Oliver Building, Pittsburgh 22. **ELECTRONICS** is indexed regularly in The Engineering Index.

FOREWORD

This is *your* Buyers' Guide—its contents and format determined by extensive survey among the subscribers to ELECTRONICS.

It is an *extra*—a bonus edition designed for service at your elbow throughout the next twelve months.

In it we are publishing the most complete directory, as to diversity of products, which has yet been presented.

In addition we have done an earnest job of preparing editorial reference material designed to help you repeatedly in your work.

Many advertisers have seen fit to utilize these pages to describe and catalog their products. It is our hope that this combination of buying-source listings, product advertising and reference material constitutes a service which will further strengthen our position with you, the subscriber.

Advertising In This Issue

Abalon Precision Mfg. Corp.	318
Accurate Paper Tube Co.	413
Ace Engineering & Machine Co., Inc.	318
Acme Electric Corporation	90
Acme Electronics, Inc.	182
Advance Electric & Relay Co.	284
Advance Electronics Co.	224
Aerolite Electronic Hardware Corp.	355
Aerovox Corporation	352
Air Associates, Incorporated	211
Air Marine Motors, Inc.	376
Aircraft-Marine Products, Inc.	307
Aircraft Radio Corporation	400, 401
Airdesign, Inc.	368
Airpax Products Company	289
Airtron, Inc.	317
Alden Products Company	327
Allen Manufacturing Company	252
Allied Control Co., Inc.	62, 63
Allied Radio Corp.	238
Allison Radar Corporation	411
American Brass Company	330
American Chronoscope Corporation	316
American Electronic Engineering Corporation	136
American Electronics	418
American Gas Accumulator Company	76
American Lava Corporation	143
American Molded Products Co.	382
American Phenolic Corporation	61
American Platinum Works, The	76
American Television & Radio Co.	226
American Time Products, Inc.	226
Amperite Co., Inc.	323
Anchor Metal Company	270
Ansonia Electrical Company	124
Antara Products Div. of General Dyestuff Corporation	268
Art-Lloyd Metal Products Corp.	364
Art Wire & Stamping Co.	38
Astron Corporation	137
Atlantic India Rubber Works, Inc.	323
Atomic Instrument Company	410
Audio Devices, Inc.	77

Ballantine Laboratories, Inc.	125
Barker & Williamson, Inc.	292
Barry Corp.	240, 241
Bart Laboratories Co., Inc.	148
Bead Chain Mfg. Co.	136
Beam Instruments Corporation	412
Beck Instrument Corporation	371
Bendix Aviation Corporation	
Eclipse-Pioneer Division	198, 199
Red Bank Division	197
Bentley, Harris Mfg. Co.	269
Beta Electric Corp.	399
Bird & Co., Inc., Richard H.	60
Bird Electronic Corporation	331
Bishop Manufacturing Corporation	224
Bivax Corporation	380
Blake & Johnson Company	279
Bliley Electric Company	311, 407
Bogue Electric Manufacturing Company	155
Bond Electronics Corp.	403
Boonton Radio Corporation	96
Borg Corporation, Geo. W.	390, 397
Borthing Co., Inc., George C.	322
Bowser, Inc.	132, 133
Bracke-Sieb X Ray Company, Inc.	390
Bradley Laboratories, Inc.	349
Braunlin Co., C. S.	142
Brand and Company, Inc., William	248, 249
Branson Instruments, Inc.	90
Breeze Corporations, Inc.	193
British Electronic Group	336
Browning Laboratories, Inc.	257
Brush Development Co.	228, 229
Buchanan Electrical Products Corp.	332
Buck Engineering Co., Inc.	374
Burgess Battery Company	295
Burnell & Company	75
Bussmann Mfg. Co.	210

C.G.S. Laboratories, Inc.	389
Cadell-Burns Mfg. Co.	234
Callidyne Co.	239
Cambridge Thermionic Corporation	37
Carboloy Department of General Electric Company	23
Carter Motor Co.	332
Centralab Division of Globe-Union, Inc.	85-88
Centronics Co.	364
Chatham Electronics, Inc.	46
Chester Cable Corp.	207
Chicago Condenser Corporation	60
Chicago Telephone Supply Corporation	78, 79
Chicago Transformer, Div. of Essex Wire Corp.	205
Churchill Corp.	408
Ciba Company, Inc.	276
Cima Corp.	388
Cinch Manufacturing Corp.	186, 187
Cinema Engineering Company	204
Citation Products Co.	388

Clark Crystal Company	366
Clarostat Mfg. Co., Inc.	100, 101
Cleveland Container Company	89
Cohan-Epner Co., Inc.	406
Cohn Corp., Sigmund	278
Coilcraft Incorporated	360
Coil Winding Equipment Co.	415
Columbia Wire & Supply Company	396
Comar Electric Company	335
Communication Accessories Company	168
Communication Measurements Laboratory, Inc.	290
Conn. Ltd., C. G.	302
Continental-Diamond Fibre Company	25-32
Continental Electric Co.	182
Cornell-Dublier Electric Corp.	146
Corning Glass Works	373
Cornish Wire Co., Inc.	71
Craft Manufacturing Co.	128
Cramer Co., Inc., R. W.	202
Crosby Laboratories, Inc.	186
Cross Co., H.	231
Crowley & Company, Inc., Henry L.	231
Cruetite Steel Company of America	225
Curtis Development & Mfg. Co.	407

Dage Electric Company	405
Dalis, Inc., H. L.	122
Daniels, Inc., C. R.	342
Dano Electric Co.	266
Daven Co.	157
DeCoursey Engineering Laboratory	174
Dee Electric Company	384
DeJur Amco Corporation	377
Dial Light Company of America	60
Dietz Design and Manufacturing Company	323
Dollar Company, Robert, Communications Equipment Div.	301
Heintz and Kaufman Division	301
Driver-Harris Company	131
Driver Company, Wilbur B.	189
Dumont Electric Corp.	375
Duofone Company, Inc.	307

Ebert Electronics Co.	413
Eby, Inc., Hugh H.	214
Edu Company, Inc.	285
Edison Incorporated, Thomas A., Instrument Division	212, 213
Eisler Engineering Co., Inc.	378
Electra Mfg. Company	174
Electric Indicator Co.	338
Electric Soldering Iron Co., Inc.	68
Electrical Industries, Inc.	94
Electrical Reactance Corp.	56, 57
Electro Development Corp.	408
Electro Products Laboratories	199
Electro-Seal Corporation	222
Electro-Tec Corporation	399
Electro-Voice, Inc.	345
Electronic Coils, Inc.	400
Electronic Designs, Inc.	332
Electronic Engineering Associates, Ltd.	393
Electronic Instrument Co., Inc.	129
Electronic Measurements Company	312
Electronic Mechanics, Inc.	309
Electronic Transformer Company, Inc.	278
Electronic Tube Corporation	335
Electrons Incorporated	174
El-Tronics, Inc.	299
Emeloid Co., Inc.	102
Emerson & Cuming Co.	389
Engineering Co.	370
Erie Resistor Corp.	91

Fairchild Camera and Instrument Corporation	244, 245
Falstrom Company	196
East & Co., John E.	368
Federal Manufacturing & Engineering Corporation	344
Federal Screw Products, Inc.	76
Federal Telecommunication Laboratories, Inc.	164
Federal Telephone and Radio Corporation	161-163
Federated Purchaser, Inc.	183
Ferranti Electric, Inc.	159
Flock Process Company, Inc.	196
Franklin Airloop Corporation	45
Franklin Mfg. Corp., A. W.	44
Freed Transformer Co., Inc.	149
Fugle-Miller Laboratories	418

Gamewell Company	306
General Ceramics and Steatite Corp.	126, 127
General Chemical Division, Allied Chemical & Dye Corporation	84
General Electric Company	1-22

General Electronics, Inc.	326
General Precision Laboratory, Inc.	58, 59
General Radio Company	48, 49
Glaser Lead Co., Inc.	416
Glaser-Stead Corp.	359
G-M Laboratories, Inc.	392
Gramer Transformer Corp.	383
Grant Pulley & Hardware Co.	158
Graphite Metallizing Corporation	192
Gray Research and Development Co., Inc.	363
Grayhill	380
Green Instrument Co.	224
Grieve-Hendry Co., Inc.	346
Guardian Electric Mfg. Co.	147

Hansell, Inc., U.	376
Haruett Electric Corporation	399
Harrison Radio Corporation	247
Harvey Radio Company Inc.	339
Haydon Company, A. W.	402
Haydon Manufacturing Co., Inc.	216, 217
Haydu Brothers	55
Heath Company	264
Helland Research Corporation	401
Heinemann Electric Company	274
Heinze Electric Co.	314
Heinzel Manufacturing Company	242
Helipot Corporation	153
Hemlinway & Bartlett Mfg. Co.	266
Heppner Mfg. Co.	413
Hermaseal Company, Inc.	294
Hermetic Seal Products Co.	175
Hewlett-Packard Company	33-36
Heyman Manufacturing Co.	381
Hickok Electrical Instrument Co.	333
Highland Engineering Co.	360
Hillburn Electronic Products	362
Hi-Test Chemical Corporation	376
Hobson Bros.	322
Houlihan Company, T. J.	336
Hudson Wire Company	106
Hunt Corporation	413
Hycron Mfg. Co.	404

Illinois Condenser Co.	47
Improved Seamless Wire Company	314
Indiana Steel Products Company	154
Inductograph Products, Inc.	326
Industrial Control Company	130
Industrial Electronics, Incorporated	234, 235
Industrial Hardware Manufacturing Co., Inc.	360
Inst-X Company, Inc.	386
Instrument Resistors Co.	392, 393
Instrument Specialties Co., Inc.	320
International Instruments Incorporated	322
International Resistance Company	134, 135
Irrington Varnish & Insulator Co.	92, 93

J-B-T Instruments, Inc.	351
JFD Manufacturing Co., Inc.	407
Jeffers Electronics Inc.	406
Jelliff Manufacturing Corporation, C. O.	405
Jennings Radio Manufacturing Company	194, 195
Johnson Co., E. F.	118-121
Johnson & Hoffman, Inc.	353
Jones Div., Howard B. Cinch Mfg. Corp.	186, 187
Jones Electronics Company, M. C.	384

Kable Engineering Co.	369
Karp Metal Products Co., Inc.	105
Kay Electric Company	340
Keithley Instruments	337
Keller Products, Inc.	397
Kellogg Switchboard and Supply Company	294
Kenyon Transformer Co., Inc.	325
Kepeco Laboratories, Inc.	54
Kester Solder Company	357
Keystone Carbon Company	308
Kings Electronics	180, 181
Kings Laboratories, Inc.	395
Kings Microwave Co., Inc.	178, 179
Kinney Manufacturing Company	160
Knights Company, James	328
Kobzy Tool Co.	343
Kollsman Instrument Corporation	304
Kroh-Hite Instrument Company	43
Kulka Electric Mfg. Co., Inc.	317
Kurman Electric Co., Inc.	196

Lambda Electronics Corporation	374
Lampkin Laboratories, Inc.	418
Langevin Manufacturing Corporation	348
LaPointe-Plascomold Corporation	297
Lavole Laboratories, Inc.	206

Lee Mechanical Laboratories, Div. of Lee Spring Company, Inc.	303
Leland Inc., G. H.	394, 395
Lenkurt Electric Co.	412
Lenz Electric Manufacturing Co.	236
Lewis Spring & Manufacturing Co.	293
Liston-Folb Instrument Co., Inc.	276
Littelfuse, Inc.	285
LoJack Precision Corp.	415
Lord Manufacturing Company	71
Louthan Manufacturing Company	284
Lukko Sales Corporation	409
Lundey Associates	410
Lust, Henry B.	418

McIntosh Engineering Laboratories, Inc.	148
MB Manufacturing Company, Inc.	365
Machlett Laboratories, Inc.	265
Magnecord, Inc.	40
Magnetic Amplifiers, Inc.	346
Magnetic Core Corp.	414
Magnetics, Inc.	381
Makepeace Company, D. E.	72
Malco Tool & Manufacturing Company	335
Marconi Instruments, Ltd.	270
Marion Electrical Instrument Company	200
Markem Machine Company	238
Measurements Corporation	99
Mepeco, Inc.	138
Mercold Corporation	192
Metal Textile Corporation	40
Metals & Controls Corp., General Plate Division	300
Method Manufacturing Corp.	347
Micamold Radio Corporation	275
Mico Instrument Co.	381
Micro-Circuits Co.	50
Mid-West Coil & Transformer Co.	165
Miles Reproducer Co., Inc.	322
Milvaco Instrument Corp.	402
Milo Radio & Electronic Corp.	74
Miniature Precision Bearings, Inc.	83
Minneapolis-Honeywell Regulator Co., Industrial Division	208, 209
Mitchell Industries, Inc.	298
Mitchell-Rand Insulation Co., Inc.	219
Model Rectifier Corp.	409
Model Electric Products Corp.	204
Molding Corporation of America	385
Muckle Manufacturing Co.	370
Multicore Solders, Ltd.	39
Multi-Metal Co.	221
Mycalex Corporation of America	258, 259
Mycalex Tube Socket Corp.	258, 259

National Capacitor Company	323
National Carbon Company a Div. of Union Carbide & Carbon Corp.	42
National Company, Inc.	280, 281
National Electronics, Inc.	218
National Moldite Company	232
National Union Radio Corp.	296
National Varnished Products Corp.	152
National Vulcanized Fibre Company	251
Neo-Sit Corporation	253
Newark Electric Company	411
New Hampshire Ball Bearings, Inc.	305
New Hermes, Inc.	411
New York Transformer Co., Inc.	288
Ney Company, J. M.	246
Norran Laboratories, Ernest	346
Northern Radio Company, Inc.	262, 263

Ohmite Mfg. Co.	41
Ohmweve Company	380
Olympic Metal Products Company, Inc.	358
Opad-Green Company	314
Orthon Corp.	156
Oster Manufacturing Co., John	90

Pan American Trade Development Corp.	266
Panoramic Radio Products, Inc.	383
Paramount Paper Tube Corp.	348
Patent Button Co. of Tennessee, Inc.	246
Patton-MacGuyer Company	390
Pennsylvania Testing Laboratory	350
Perfection Electric Co.	102, 142, 256, 405
Peralo Plastics Corporation	321
Philamon Laboratories	282
Phillips Control Corporation	302
Pickering & Co., Inc.	387
Pix Manufacturing Co., Inc.	284
Planet Manufacturing Corporation	336
Plastoid Corporation	117
Polarad Electronics Corp.	184, 185
Polytechnic Research & Development Company, Inc.	172, 173
Potter & Brumfield	220
Potter Instrument Company, Inc.	318
Precise Measurements Company	401
Precision Metal Products Co. of Malden	341
Precision Paper Tube Co.	156
Precision Rectifier Corp.	370
Presto Recording Corporation	52, 53
Product Development Company, Inc.	322
Pyroferic Co.	287

Quaker City Gear Works	166
------------------------	-----

Radio Cores, Inc.	396
Radio Corporation of America	177, Third Cover, Fourth Cover
Radio Materials Corporation	223
Radio Receptor Company, Inc.	250
Radio Shack Corporation	404
Rahm Instruments, Inc.	354
Raytheon Manufacturing Company	Power Tube Division 81 Special Tube Section 80
Reeves-Hoffman Corporation	286
Reeves Instrument Corporation	315
Reeves Soundcraft Corporation	372
Republic Foll & Metal Mills Incorporated	370
Resistance Products Co.	379
Richardson-Alten Corporation	414
Richardson Company	310
Roanwell Corporation	403
Robinson Aviation, Inc.	267
Robinson Incorporated, Edward E.	398
Rogan Brothers	261
Rohden Manufacturing Co.	406
Rome Cable Corporation	215
Rotron Mfg. Co.	410
Rush Wire Stripper Division Eraser Company, Inc.	398
Russell & Stoll	337

Samuel & Co., Inc., J. A.	413
Sanborn Company	391
Scientific Electric Div. of "S" Corrugated Quenched Gap Co.	95
Servo Corporation of America	150, 151
Servomechanisms, Inc.	188
Servo-Tek Products Co.	356
Sessions Clock Co.	Timer Division 123 Tyniswitch Division 122
Set Screw & Mfg. Co.	406
Shallicross Manufacturing Co.	261
Shaw Insulator Co.	358
Sherman Mfg. Co., H. B.	156
Sherron Electronics Co.	145
Shure Brothers, Inc.	230
Shurite Meters	390
Sigma Instruments, Inc.	319
Signal Engineering & Mfg. Co.	256
Sola Electric Co.	312
Sorensen and Company Inc.	66, 67
Specialty Battery Company	364
Speer Resistor Corp.	406
Spellman Television Co., Inc.	277
Spencer-Kennedy Laboratories, Inc.	166
Sperry Gyroscope Company	103, 104
Stackpole Carbon Company	170, 171
Stainless, Inc.	387
Standard Coil Products Co., Inc.	97
Standard Crystal Company	156
Standard Electric Time Co.	40
Standard Transformer Corporation	144
Stayer Company Incorporated	232
Stelner-Ives Company	136
Stevens Arnold Incorporated	295
Stevens Manufacturing Company, Inc.	334
Stewart Mfg. Corp., F. W.	176
Stupakoff Ceramic and Manufacturing Co.	167
Sun Radio & Electronics Co., Inc.	293
Superior Electric Co.	190, 191
Superior Tube Company	64, 65
Switchcraft, Inc.	354
Sylvania Electric Products, Inc.	Electronics Division 434, 435, 436 Radio Division 432, 433
Synco Products Co.	405

Taylor Tubes Inc.	260
Technical Appliance Corp.	378
Technicraft Laboratories Incorporated	342
Telechron, Inc.	34
Teletronics Laboratory, Inc.	418
Telex, Electric-Acoustic Division	237
Tel-O-Tube Corporation of America	142
Tel-Rad Mfg. Co., Inc.	412
Tenny Engineering, Inc.	98
Tensollite Insulated Wire Co., Inc.	316
Terminal Radio Corporation	271
Thomas & Skinner Steel Products Company	403
Thompson Products, Inc.	82
Thor Ceramics, Inc.	378
Times Facsimile Corporation	288
Titeflex, Inc.	68
Trad Television Corp.	355
Transicoil Corporation	116
Truscon Steel Company	329
Tung-Sol Lamp Works, Inc.	169
Turner Company, The	73

Unimax Switch Div. of the Maxson Corporation, W. L.	227
Union Carbide & Carbon Corporation, National Carbon Division	42
Union Electric Products Co.	60

United Condenser Corp.	404
United Electronics	139-141
United Manufacturing & Service Co.	324
United States Electronics Corporation	76
United States Gasket Co.	176
United States Testing Company, Inc.	400
United Transformer Co.	Second Cover
Universal Manufacturing Company, Inc.	385
University Loudspeakers, Incorporated	38

Vector Electronic Company	283
Vectron, Inc.	214
Victoreen Instrument Co.	272, 273
Victory Engineering Corporation	208
Volkert Metal Stampings, Inc., John	313
Vulcan Electric Company	50

Walker Company, George	368
Waltham Horological Corporation	409
Ward Leonard Electric Co.	69, 70
Waterman Products Co., Inc.	254, 255
Webster Spring Corporation	394
Westinghouse Electric Corporation	107-113
Westinghouse Electric Corp. Electronic Tube Division	114, 115
Weston Electrical Instrument Corporation	243
White Dental Mfg. Company, S. S.	291
Wildor Mfg. Co., Inc.	264
Wilkor Products Inc.	361
Winchester Electronics Incorporated	201
Workshop Associates, Inc.	233

York Co., Inc., Otto H.	174
-------------------------	-----

Zophar Mills, Inc.	397
--------------------	-----

PROFESSIONAL SERVICES..... 417

SEARCHLIGHT SECTION
(Classified Advertising)

EQUIPMENT (Used or Surplus New) For Sale.....	418-431
---	---------

ADVERTISERS INDEX

Avnet Electronics Corp.	427
Barry Electronics Corp.	426
Chase Electronic Supply Co.	426
Communications Equipment Co.	418
Compass Communications Co.	429
Electro-Impulse Labs.	421
Empire Electronics Co.	426-430
Green, Gould	430
Greenberg, David	426
Instrument Associates	419
Lectronic Research Laboratories	428
Legri S. Company	422
Leru Laboratories, Inc.	431
Liberty Electronics, Inc.	425
Life Electronic Sales	424
Long Island Radio Co.	430
Maritime Switchboard	428
Metropolitan Overseas Supply	429
Mogull Co., Inc., Alexander	429
P J Sales	431
Powell, Harold N.	428
Red Arrow Sales Co.	430
Reliance Merchandizing Co.	428
Sagal Co., Leo	431
Stanley Engr. & Mfg. Co.	431
TAB	431
Wells Sales, Inc.	420
Wilgreen	423

This index is published as a convenience to the readers. Every care is taken to make it accurate, but The Electronics Buyers' Guide assumes no responsibility for errors or omissions.

GENERAL ELECTRIC

ELECTRONIC COMPONENTS, EQUIPMENT AND ALLIED PRODUCTS FOR ALL COMMUNICATION AND INDUSTRIAL APPLICATIONS

General Electric has been building high-quality electronic components and equipments for many years. The components are available not only for communication equipment but also for industrial electronic equipment such as high-frequency heating, radar, controls, etc. The same is true of the equipment.

Each component line manufactured by General Electric is backed up by capable design engineers, finest manufacturing facilities, and our renowned development and research laboratories. Components and equipment listed below are but representative. For further information on the complete line, please get in touch with the nearest General Electric Sales Office.

INDEX

PRODUCT	PAGE NO.	PRODUCT	PAGE NO.
Amplidyne	4	Pulse Transformers	5
Arc-back Indicators	3	Push Button Stations	11
Broadcast Modulation Transformers	5	Radio Dial Lamp	19
Capacitors	1-2-3	Rectifiers	5
Control and Transfer Switches	6	Regulated Power Supplies	22
Delay Lines	9	Relays	11
Electronic Timer	9	Resistance Welding Controls	8
Electronic Tubes	13-14	Resistors	9
Filament Transformers	5	Resonant Reactors	5
Fused Quartz	19	Saturable Reactors	4
Germanium Diodes	21	Silicone Rubber	17
Glass Bushings	5	Selsyns	10
Indicating Lamps	5	Solenoids	10
Inductrols	4	Solenoid Operated Valves	10
Industrial Test Equipment	22	Specialty Transformers	3
Instrument Transformers	7	Switchboard Accessories	6
Insulating Finishes	17	Switchboard Instruments	6
Kon-Nec-Tors	15	Switchettes	10
Kon-Nec-Tor Mountings	15	TV Components	20
Laminated Plastics	17	TV Test Instruments	22
Limit Switches	10	Terminal Boards	9
Loudspeakers	20	Thy-Mo-Trol	12
Neon Glow Lamps	19	Thyrite	9
Magnetic Amplifiers	4	Time Meter	7
Magnet Wire	18	Time Switches	7
Metallic Rectifiers	8	Tube Sockets	15
Mycalex	16	Variable Reluctance Cartridges	20
Nuclear Instruments	22	Varnished Cloths & Tapes	16
Oscilloscopes	22	Varnishes & Compounds	16
Panel Instruments	6	Voltage Regulators	4
Permanent Magnets	23	Voltage Stabilizers	4
Photoelectric Recorder	7	Water Jackets	15
Photoelectric Relays	11		
Portable & Recording Instruments	7		

FOR INFORMATION ON G-E APPARATUS PRODUCTS LISTED IN THE DIRECTORY SECTION BUT NOT SHOWN ABOVE, PLEASE TURN TO PAGE 12

CAPACITORS

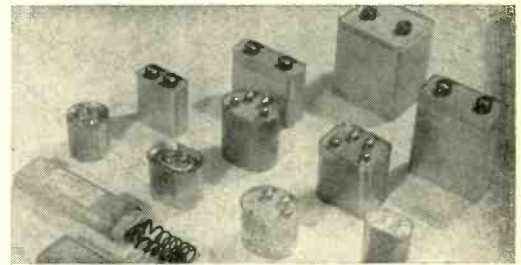

For General-purpose A-c Applications

Small a-c Pyranol* capacitors are recommended for use with motors, industrial controls, transformers, and other equipment. Use of Pyranol as a treating material because of its high dielectric strength, high dielectric constant, and exceptional stability, has made possible a marked reduction in size, as well as a far superior capacitor. Two styles of mounting are available and supplied separately. All seams hermetically sealed and all bushings provide permanent, liquid-tight seal. Write for Bulletin GEC-615.

Rated Voltage 60 Cycles	Fabricated Rectangular	Cylindrical
236	1-20 mu f
330	1-50 mu f	125-12 mu f
440	1-28 mu f
660	1-15 mu f

JAN-C-25 Specifications

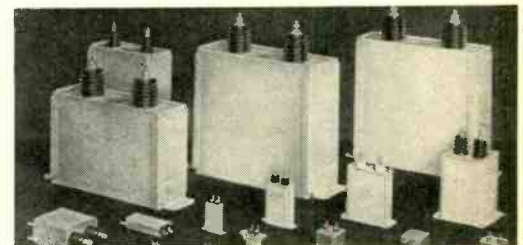

Primarily for filter, by-pass, and blocking purposes. Qualified for application where the alternating-current component of the impressed voltage is small with respect to the direct-current rating. Write for Bulletin GEC-616.

STANDARD RATINGS		
Case Styles	Voltage	Capacitance
CP53, -54	100-1000	0.05-4 mu f
CP61, -63, -65	400-1500	0.01-1 mu f
CP67, -69	600-1000	0.05-50 mu f
CP70	600-12500	0.1-15 mu f

*Registered trade-mark of General Electric Co.

CAPACITORS

HFP Capacitors: These high-frequency, liquid-filled parallel-plate capacitors are specifically designed for use in the resonant circuit of high-frequency electronic oscillators, such as those used in electronic-heater applications. They may be operated at relatively high voltages and will carry heavy currents continuously at frequencies of 50 kilocycles to several megacycles. Write for Bulletin GEA-4365

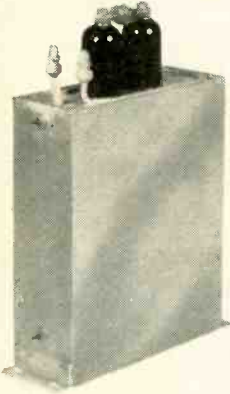

Tantalytic Capacitors



Tantalytic capacitors are suggested for low-voltage, d-c applications where performance and size are the major factors.

The Tantalytic capacitor was designed to fit certain d-c, low-voltage applications where aluminum electrolytic and paper capacitors have not been entirely satisfactory. Designed also to get more capacitance per unit of volume, Tantalytic capacitors, in comparison with conventional electrolytics, have longer shelf-life, longer operating life, and superior capacitance-temperature characteristics. Tantalytic capacitors are available in sample quantities in a variety of 150-volt d-c polar and nonpolar types, ranging from 0.04 to 12 mu f. For information, write Capacitor Sales, Pittsfield, Mass.

Steatite-tube Capacitors



These capacitors are designed for commercial electronic applications, such as electronic precipitators and high-voltage grading, where metal container capacitors have been costly, and unsatisfactory from a size and conducting-case standpoint.

Steatite-tube capacitors are suggested for high-voltage, low-capacitance, direct-current applications where cost, size, weight, sturdy construction, and dependability are the major factors. These units are also suitable for light-duty discharge pulsing and a-c service. Designed to get more capacitance per unit of volume, steatite tube capacitors have long operating life, extended foil construction and are designed for minimum resistance and inductance. These units are ideally suited for series or series-parallel connections and may be mounted in any direction by using fuse clips or similar attachments. For information write Capacitor Sales, Pittsfield, Mass.

Mu f Rating	D-c Voltage Rating	Characteristic	Watt-Second Rating
0.03	7,500	F	0.844
0.005	10,000	E	0.250
0.0075	10,000	F	0.375
0.01	10,000	F	0.500
0.001	15,000	E	0.1125
0.0005	30,000	F	0.225

Max. Permissible RMS Working Voltage	Microfarad Rating	Max. Permissible RMS Working Current in Amp at 540 Kc
2500	.027	229
3000	.0215	219
4000	.017	231
4500	.014	214
5500	.0105	196
6000	.008	163
7800	.0076	201
7800	.006	159
9000	.0054	165
9000	.0042	128
11,000	.0037	139
11,000	.0029	109
13,500	.0017	106

All listed ratings are maximum, continuous operating levels, and not test levels.

D-c Capacitors

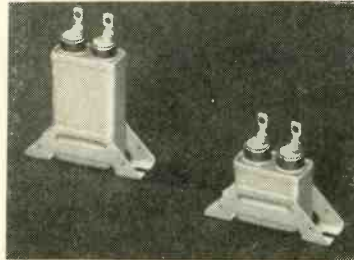

These Pyranol capacitors designed for electronic commercial applications, ranging from a small unit for blocking and by-pass service to large capacitance units for power-supply filters, and high-voltage units for use in heavy-duty x-ray equipment. They are hermetically sealed and their small size allows fitting in restricted panel surface. Kraft paper is used as solid dielectric and aluminum foil for the plates. Bushing construction provides for short internal leads, thus preventing possible grounds and shorts. Silicone-gasketed bushings provide a permanent, liquid-tight seal, adequately designed to provide generous air strike and creepage distance. Write for Bulletin GEC-605.



Pulse-forming Network

These capacitor pulse-forming networks, Type E, are for applications in radar and industrial equipment where the normal (exponential) capacitor discharge shape is not suitable and where an impulse having a definite energy content and duration is required. Write for Bulletin GEA-4996.

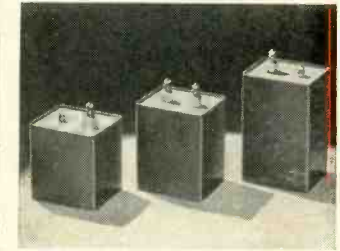

Energy Storage: These d-c Pyranol capacitors for phototube and similar light-duty energy-storage applications are the result of years of experience in the design and manufacture of capacitors for this type of service. They are relatively lightweight, small, stable capacitors having a life consistent with the application involved. Write for Bulletin GEA-4646.

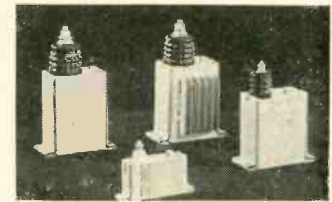

High-frequency Capacitors

Fixed-paper-dielectric capacitors developed primarily for grid and plate blocking service in the electronic oscillator circuits of high-frequency induction-heating equipments. Also used to advantage in other high-frequency oscillator circuits of a similar nature. G-E high-voltage paper-dielectric capacitors are of relatively high capacitance (0.01 mu f) for high-frequency units, and yet they are more economical than conventional high-frequency units of considerably smaller capacitance values. They provide savings in cost as well as reduced losses and lower voltage drop across the capacitor. Write for Bulletin GEA-4388.

D-c Voltage Rating	Microfarad Rating
5000	0.01
15,000	0.01
20,000	0.01
20,000*	0.01

*With cooling fins for higher current-carrying capacity. Capacitance tolerance ± 10%.

CAPACITORS

Permafil Capacitors: Permafil high-temperature capacitors are designed to meet the performance requirements of JAN-C-25 characteristic "E" (mineral oil) capacitors, and in addition, are suitable for operation in ambient temperatures from -55 to $+125$ C at full rated voltage.

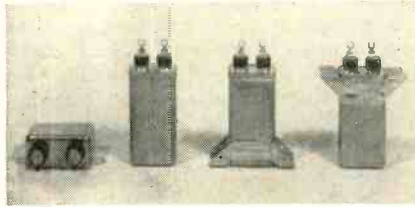

Ratings	D-c Voltage	Mu f
Case Style 53	400	.05-1
Case Styles 61, 63, 65	400	.10-1

Permafil, used as the impregnant instead of mineral oil, is a solid resinous material having excellent electrical characteristics over a wide temperature range. Since it is a compound, the processing and manufacture of Permafil capacitors can be controlled to exacting specifications and results in units that are reliable at elevated temperatures. Because the impregnant is solid, it eliminates possibilities of leaks. For information, write Capacitor Sales, Pittsfield, Mass.

Single-bushing
Case Style 70

These paper-dielectric capacitors are designed for d-c electronic applications where it is desirable to obtain high voltage and low capacitance in a minimum of space.

For information, write Capacitor Sales, Pittsfield, Mass.



Mu f Rating $\pm 20\%$	D-c Voltage Rating	Watt-seconds
0.01	30,000	4.5
0.03	30,000	13.5
0.05	30,000	22.5
0.01	20,000	2
0.1	20,000	20

SPECIALTY TRANSFORMERS FOR ELECTRONIC EQUIPMENT



Compound-filled Particularly suitable for applications where moisture or humidity is excessive. For such applications, they are far superior to core-and-coil units. If immersion-proof unit is not required, they are more economical than hermetically sealed transformers. They have wide application in the electronics field, such as in frequency-modulation, carrier-current, and speech-input equipment. An especially useful feature is the universal mounting—the units can be top or bottom mounted for open or underdeck wiring.

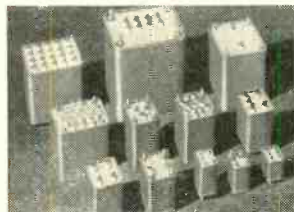

Hermetically Sealed Protected, internally, from the effects of changing atmospheric pressure, and insulation breakdown due to humidity, and, externally, from corrosion caused by salt-water vapor. Withstands successfully the rigorous salt-water immersion and salt-water spray tests as specified by the Signal Corps, the Air Forces, and the Navy. The hermetically sealed units are specified as standard iron-core components for such apparatus as aircraft receivers and transmitters, UHF equipments, and landing-boat receivers. Furnished with terminals and mounting studs located either on the top or bottom.



Core-and-coil Usually applied where moisture resistance is not an important factor, and where size and weight must be kept to a minimum. Composed of automatically wound coils imposed on finest-grade silicon-steel core laminations, they are the same uniform, high quality as our encased transformers. Made to exacting tolerances to provide excellent electrical characteristics. Terminal boards top or bottom mounted, or with leads, and with mounting studs or brackets to meet special requirements.



Permafil Type For electronic applications. They utilize a special core-and-coil construction which permits size and weight advantage comparable to, and in many instances, better than conventional core-and-coil unit. Completely protected by a tough coating of permafil (a synthetic resin developed by G.E.) which makes them highly moisture resistant. Particularly adaptable to aircraft use where size and weight requirements are extremely critical.

Aircraft Transformers

General Electric manufactures a complete line of standard 400-cycle aircraft transformers which includes general-purpose transformers, phase-changing transformers, high-temperature silicone transformers, ballasts for fluorescent lamps, ignition transformers for cabin heaters, de-icers, and jet engines. General Electric builds transformers to individual specifications, both military and commercial. Write for Bulletin GEA-4866.

Control & Signal
Transformers

Designed in standard sizes from 0.0075 to 0.200 kva to supply low-voltage circuits (usually 30 v or less), for most economical operation of numerous industrial, commercial, and household equipments. A complete standard line of normal-reactance, high-reactance, and warp-stop transformers is available to meet most applications. However, special units built from standard parts can be designed for special applications. A complete line of transformers is available for specific use with machine tools. Designed so that 23 ratings will meet requirements of most foreign, as well as unusual domestic, applications. All units have front-mounted terminal boards and built-in circuit protectors. Write for Bulletins GEA-1358 and GEA-4887.

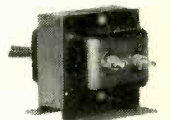

Arc-back Indicators

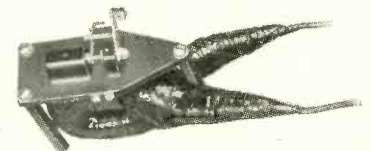

Designed for use with tube rectifiers to indicate a reversal of direct current. When an arc-back occurs, and the direct current flows in the opposite direction, the magnetic field which ordinarily holds the indicator in a horizontal position is neutralized. This permits the indicator to spring to a vertical position, thus indicating a reversal in the direction of the direct current. The indicator can be connected to a switch for audible indication rather than visual, to fit certain applications.

Gooseneck Filament Transformers

Are used as components of radar and transmitter equipment, and allied devices which require high operating voltages above ground. Construction type shown in the photograph permits a substantial reduction in size and weight—critical factors in many installations. A cost savings is also effected over similar ratings of enclosed-type construction.

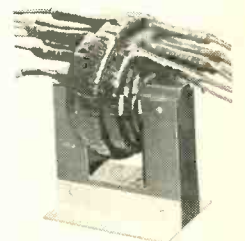

VOLTAGE REGULATORS

Automatic Voltage Stabilizers



For equipment that requires stable a-c input or for stable output of 115 or 230 volts in sizes from 15 to 5000 va, standard G-E stabilizers can be used to cut costs, save space.

Guarding a rated load at unity power factor, they maintain output within $\pm 1\%$ against line variations of 95 to 130 volts. Quiet, automatic, they provide quick recovery when subject to simultaneous line and load variations, and voltage surges.

If your product is composed of one of the following items, it will pay you to investigate stabilizers: Television and radio equipment; Telephone apparatus; Sound equipment; Lighting circuits; Photometers; X-ray equipment; Rectifiers (full-wave); Electrochemical apparatus; Test equipment and precision processes; Photographic equipment; Electronic circuits; Calibration devices; Color comparators.

INDUCTROLS (Hand or Automatic)

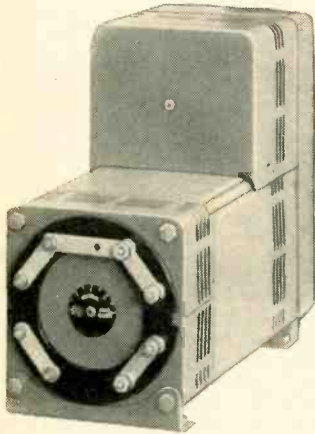

Single-phase, 60 Cycles, Indoor Service, Automatic									
Volt-amperes, Cont, 55 C Rise	Raise and Lower Regulation				Net Wt in Lb*	Approximate Over-all Dimensions in Inches			
	Per Cent	Per Amp	Per Cent	Per Amp					
120 Volts									
300	10	25	43	12½ by 6 by 10⅞			
300	15	16.7					
600	10	50	57	14 by 6 by 10⅞			
600	15	33.4					
240 Volts									
300	10	12.5	5	25	43	12½ by 6 by 10⅞			
300	15	8.3	7.5	16.7					
600	10	25	5	50	57	14 by 6 by 10⅞			
600	15	16.7	7.5	33.4					
Hand-operated									
120/240 Volts									
300	120	20	12.5	10	25	32	10¼ by 6 by 7⅞		
300	240	10	12.5	5	25				
300	120	30	8.3	15	16.6	46	11¾ by 6 by 7⅞		
300	240	15	8.3	7.5	16.6				
600	120	20	25	10	50	46	11¾ by 6 by 7⅞		
600	240	10	25	5	50				
600	120	30	16.7	15	33.4	46	11¾ by 6 by 7⅞		
600	240	15	16.7	7.5	33.4				
1200*	120	200†	5	100	10	46	11¾ by 6 by 7⅞		
1200*	240	100	5	50	10				

*Weights do not include control panel which is mounted separately from the regulator. Control panel weighs approximately 30 lb net.

To meet the increasing demand for smooth voltage regulation in smaller electric apparatus, G.E. has extended its line of induction voltage regulators to include the 300- and 600-volt-ampere ratings. With these new inductrols, smaller laboratory, industrial, and communications applications are now afforded smooth control, high efficiency, and dependability. They can be automatically or hand operated.



SATURABLE REACTORS

Their features are: 1. provide control in an a-c circuit by means of a direct current. 2. provide a wide range of control with smooth adjustment over entire range. 3. d-c control power required is small, obtainable from any reasonable combination of available current and voltage. 4. very efficient, even at light loads. 5. voltage drop in reactor at full saturation is small, permitting 93% or more of the voltage to be applied to load. 6. compact, sturdy, no moving parts. 7. control power readily obtained from electronic rectifier. 8. conveniently installed in least crowded part of the building for remote control operation. 9. provide a means of insulating the d-c control from the a-c circuit. These units are for use as control devices for numerous automatic and manual control applications. Write for Bulletin GEC-341.



AMPLISTAT

Magnetic Amplifier

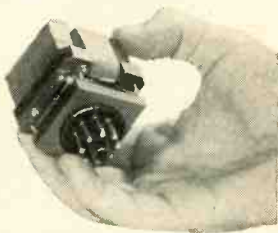

This amplistat is a complete d-c to d-c magnetic amplifier of the self-saturating type. It is complete with reactors and rectifiers mounted in a metal enclosure on a standard tube-type octal plug base. The plug feature permits convenience

of connection and ease of removal for testing the rest of the circuit. Features include: *High Gain-Isolation*-Input windings electrically isolated from output. *Reliable*-Rugged construction, little, if any, maintenance. *Static*-No moving parts. *No warm-up time*-Has no tubes. *Compact*-2-in. cube fits easily on control panels and chassis.

Application: This amplistat is a complete packaged d-c amplifier applicable to a wide range of control and instrumentation purposes. The following are a few of the many possible combinations of SIGNAL SOURCES (Thermocouples, Strain Gages, Thermistors, Photocells, Phototube amplifiers, Transistor amplifiers, Cobalt-wire magnetic-field sensitive resistors, Shunts, Resistance-type temperature bulbs, Other Amplistats) with CONTROLLED DEVICES (Relays, Solenoids, Small-motor fields, Generators, Amplidyne fields, Power Rectifiers, Lamps, Heating elements, Other Amplistats).

ELECTRONIC AMPLIDYNE
Adjustable-speed Control

An extremely responsive amplifier combined with a motor amplidyne set, useful in many types of motor control where precise regulation of current, voltage and speed is necessary or desirable.

APPLICATION-Control speed, limit loads, hold tension, speed up acceleration, position precisely, assure quick stopping, and readily adaptable to programming and processing control.

RATED-As a regulated adjustable-voltage power supply for d-c motors up to 1½ hp. As regulated exciter for large adjustable-voltage drives up to 200 hp. The unit has an output of 1½ kw, 250 volts. Can be arranged for use on 220- or 440-volt, 3-phase, 60-cycle power supply.

The G-E electronic amplidyne is applied as a part of a complete control system. Write for Bulletin GEA-4053.



High-precision Rectifiers

These d-c power-supply units are especially built for precision work. Hermetically sealed, they have a number of highly desirable features which make them suitable for supplying the high potential necessary for cathode-ray tubes, television-camera tubes, radar-indicator scopes, electron microscopes, and other jobs where unusually low regulation, light-weight, and small size are primary considerations. Illustrated is a unit rated 7000 volts, 0.1 ma, d-c. It is manufactured for 215 volts, 2000 to 20,000 cycles, a-c input. An additional pair of terminals, supplying 45 volts a-c when 215 volts are applied to the input terminals, makes the unit especially suitable for use as the tank circuit of an audio oscillator.

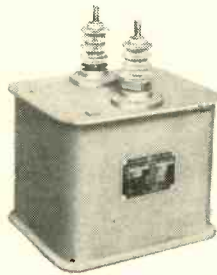

HIGH VOLTAGE COMPONENTS

Oil-filled, Hermetically Sealed, Resonant Reactors

Precision reactors of the type required by resonant charging, line-type, radar modulator circuits. Designed to operate at full d-c load with an a-c current superimposed. Insulated to withstand test voltages of 2 times normal operating voltage. Currently available in peak-operating-voltage ratings of from 5 to 45 kv, and current ratings up to 2.25 amperes, these sturdy units have a wide range of inductance ratings from .25 to 300 henrys, which remains constant within 5% from full to 50% full-load current. Certain small- and medium-size designs are provided with continuous adjustment of inductance over a wide range of 3:1.

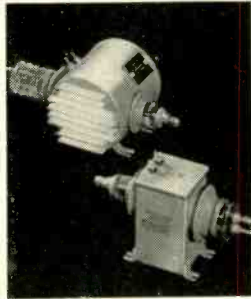

Oil-filled, Hermetically Sealed Pulse Transformers

Oil-insulated, hermetically sealed pulse transformers in peak-voltage ratings of from 10 to 100 kv or higher and in peak-power ratings up to 30,000 kva or more, are now available for use with either hard-tube or line-type modulators.

These compact units, designed for operation on pulse durations ranging from 0.1 to 20 microseconds—with repetition rates up to 4000 P.P.S.—will be found ideal for such applications as: Pulse voltage step-up or -down, Impedance matching, Phase reversing, Measuring plate current of transmitter tubes.



Filament Transformers: Oil-insulated filament transformers for special applications or for use with any of the standard high-voltage rectifier tubes. These compact units can be provided with or without tube socket mounted integral with the high-voltage terminal. Illustrated is a hermetically sealed, low-capitance filament transformer rated 5 volts, 11 amperes, and insulated to the 18-kv level.

Cascade-type Rectifiers: In laboratory or factory testing and power-supply applications where smooth high d-c voltages are required, cascade connections of from one to four conventional 35-kv, 32-ma rectifiers can be furnished for single-phase operation from 115—230-v, 50- and 60-cycle power supply. Output-voltage ripple peak to peak not to exceed 0.1% per ma. Control panel furnished which provides smooth output-voltage control over complete range from zero to max. Panel also contains overload relays and meters to indicate output voltage and current and filament voltage.



CAST GLASS BUSHINGS

In ratings up to the 15-kv power-transformer impulse level and for currents up to 800 amp, permit the successful design of hermetically sealed electric apparatus. Heatproof, leakproof, shockproof bushings for use in vital communication and commercial application where severe operating conditions are continually encountered. Available in a wide variety of sizes and shapes in both single- and multi-conductor designs, they offer the following advantages. 1. Attached directly to apparatus, making gaskets unnecessary and providing a hermetic seal. Designers may utilize all the advantages of present-day insulating materials without fear of reduced dielectric strength caused by the entrance of moisture. 2. Make possible design of more compact, lighter-weight apparatus at lower cost for airborne and other specialized equipment uses. 3. Thermal characteristics of the glass used have been co-ordinated with those of the metal parts which are directly sealed into the bushing to produce strain-free seals which are capable of withstanding thermal shocks far in excess of operating conditions.

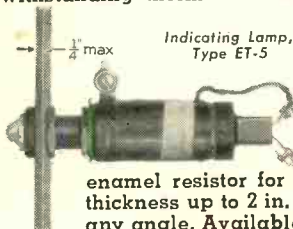

INDICATING LAMPS

Type ET-5, offers high visibility, low wattage, and long life. Consists of telephone-type lamp with contacts mounted within an insulated metal tube and with a vitreous-enamel resistor for any voltage up to 660 v. For any panel thickness up to 2 in. Color cap provides excellent vision from any angle. Available in 6 colors. Write for Bulletin GEA-3643.

BROADCAST MODULATION TRANSFORMERS

High-fidelity, low-phase-shift, Pyranol or oil modulation transformers and reactors for high-power AM broadcast transmitters are available either as integral or separate units. Highly developed transformer designs in ratings from 3.5 to 500 kw provide wider transmission frequency range and minimize harmonic voltage insertion. Low phase-shift provides more flexibility and range for amplifier feed-back circuits. Overvoltage spark gaps add to the reliability of these units.



For information on these and other high-voltage components, write Power Transformer Sales Division, Pittsfield, Mass., giving full details of application involved.

SWITCHBOARD COMPONENTS

Panel Instruments: 3 1/2-inch Types:



General-purpose, small panel instruments for use in radio and communications equipment where compactness (particularly minimum depth behind the panel) is essential. Internal-pivot design construction with pivots solidly mounted to the inside of the shell moving coil. Element assembly is a self-contained unit supported by a high-coercive cast magnet. A strong, compact instrument with fast response and excellent damping.

Available in a variety of ratings, in round and square cases: Type DO-71 voltmeters, ammeters, milliammeters, and microammeters for measuring d-c voltage and current. Type AO-72 voltmeters, ammeters, and milliammeters for measuring a-c voltage and current.

2 1/2-inch types:

Same construction and appearance design as the 3 1/2-inch types. Type DW-71 for d-c measurements: ammeters (1 to 300 amp), milliammeters (1 to 500 ma), microammeters (50 to 750 ua), and voltmeters (1 v to 5 kv); Type AW-72 for a-c measurements, ammeters, milliammeters, and voltmeters.

1 1/2-inch types:

Extremely small, compact indicating instruments embodying fine quality and workmanship. Type DN-4 d-c microammeters, milliammeters, and ammeters up to and including 10 amp, and voltmeters from 25 mv up to 150 v can be supplied self-contained.

Long-scale Panel Instruments, Type DO-81

This long-scale panel instrument is designed for applications where greater ease and accuracy of reading are required and instrument space is limited. 250-degree, 4.92-inch scale gives maximum legibility in a 3 1/2-inch instrument. Long scale and small size make this line especially suited to use with auxiliary apparatus for the measurement of nonelectrical quantities, such as speed and pressure. Applications for standard electrical ratings include electronic apparatus, industrial testing equipment, and testing equipment for electronic circuits. Available as d-c microammeters, milliammeters, and ammeters from 200 ua to 300 amp; d-c voltmeters from 1 to 300 v.



DIRECT-CURRENT, TYPE DO-71			ALTERNATING-CURRENT, TYPE AO-72		
Type	Rating Range	Approx. Resist. Range Ohms	Type	Rating Range	Approx. Resist. Range Ohms
Ammeter	1 to 50 amp	.001 to .05	Ammeter	1 to 500 amp	.00031 to .138
Milliammeter	1 to 500 ma	.10 to 68	Milliammeter	10 to 500 ma	.43 to 1060
Microammeter	20 to 500 ua	70 to 2030	Voltmeter	1 to 500 v	2 to 100,000
Voltmeter	1 to 500 v	1000 to 500,000			
Kilovoltmeter	1 to 5 kv	1,000,000 to 5,000,000			

Switchboard Instruments

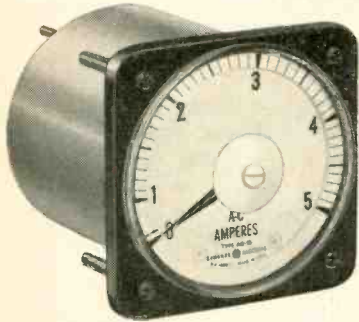

Types AB-18 (a-c) and DB-18 (d-c) AMMETERS VOLTMETERS WATTMETERS

Long-scale, compact instruments intended for general switchboard service on large and small equipments. Excellent for control stations, test equipment, and other installation in limited space. 5 instruments can be mounted side-by-side on a 24-in. panel. Drawn-steel, dustproof covers for semiflush mounting. New convex glass cover, with scale mounted flush with case front, reduces shadows to minimum and results in greater readability. Antiparallax scale and pointer, magnetic dampening, and external zero adjusters.

General Electric switchboard instruments include voltmeters, ammeters, wattmeters, frequency meters, power-factor meters, varmeters, synchrosopes, temperature meters, and ground detectors. Pertinent data and listings for the more common devices are presented in this publication, although instruments of other ratings and constructions are also available: for example, thermocouple types for the measurement of h-f current or rectifier types for high-sensitivity a-c measurements.

WATTMETERS: 25-125 cycle; Accuracy—±1%; Scale Length and Dimensions same as single instruments; Operating Principle—Electrodynamometer; Single-phase and Polyphase types.

VARMETERS: 3-phase, 3-wire, 2-phase, 3-wire; 2-phase, 4-wire; 3-phase, 4-wire; 5 amp; 120-208 v; 25 cycles to all commercial frequencies; Accuracy—±1%; Operating Principle—Electrodynamometer with autotransformer.

FREQUENCY METERS: 120 v; 60 cycles; Accuracy—22.5-27.5 cy—0.08 cy, 45-55 cy—0.15 cy, 55-65 cy—0.15 cy, 40-65 cy—0.25, 20-90 cy—1.00 cy, 350-450 cy—1.50 cy; Operating Principle—Resonant-circuit.

POWER-FACTOR METERS: 3-wire, 3-phase, 25-125 cycles; 4-wire, 3-phase, 25-125 cycles; 5 amp, 120-600 v; Accuracy—±.01 power factor for rated current, voltage, and frequency; Operating Principle—Polarized-vane.

SYNCHROSCOPES: 25 cycles with external impedor; 50 and 60 cycles, self-contained; 120 v; 360° rotation; Operating Principle—Polarized-vane.

A-C TYPES	RANGE	OPERATING PRINCIPLE	CYCLES	ACCURACY
VOLTMETER	10-750 v	Attraction-Repulsion	25-125	± 1 per cent
AMMETER	1-10 amp self-contained, otherwise limit is limit of C.T.	Attraction-Repulsion	25-125	± 1 per cent
D-C TYPES				
VOLTMETER	1-750 v	Perm. Magnet, Moving Coil		± 1 per cent
AMMETER	1-3000 amp	Perm. Magnet, Moving Coil		± 1 per cent
MILLIAMMETER	1-750 ma	Perm. Magnet, Moving Coil		± 1 per cent
MICROAMMETER	100-750 mu a	Perm. Magnet, Moving Coil		± 1 per cent

Control and Transfer Switches

Type SB-1 design is extremely flexible and can be applied to meet special requirements. Features include: square operating shaft with cams to provide positive contact operation; silver-to-silver contacts; complete protection of live parts; compact design; ample space for connecting leads; choice of operating handles; permanent-finish Textolite* escutcheons; wide range of stages and contact positions, the number of circuits to be controlled determining the number of stages and contacts needed. Switches having up to 16 stages are commonly furnished. The maximum number of positions, or throws, is twelve. Switches with spring return are limited to three positions.

Rating of Type SB-1 switches is 600 v, 20 amp continuous, 250 amps for 3 seconds. Interrupting rating depends upon voltage and character of circuit, as well as number of contacts in series. Write for Bulletin GEA-4746.

*Registered trade-mark of General Electric Co.

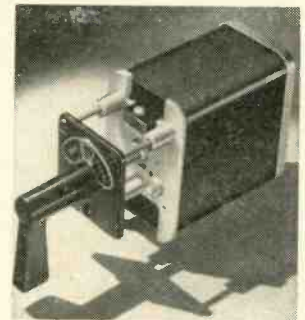

PORTABLE & RECORDING INSTRUMENTS

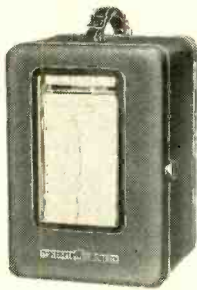

Photoelectric Recorder, Type CE: For special temperature measurements, developmental testing, high-speed recording, laboratory investigations, physiological research, and equipment tests. Provides direct ink records, and is ideal for any test where only a small amount of energy is available for the operation of the recorder. Sensitivities obtained as low as $1.0 \mu a$, full scale. Response periods as fast as $\frac{1}{5}$ second. 4 different motor arrangements provide chart speeds from $\frac{1}{2}$ inch per hour to 72 inches per minute. Write for Bulletin GEC-254.

Portable Test Instruments (A-c and D-c): 4.1 in. scale length for general-utility testing. Useful for checking motor loads, checking power circuits, measuring power consumption, trouble shooting, and similar purposes. The high initial and sustained accuracy of these instruments is due to their lightweight moving element, a magnetic shield, high torque, and large clearances. The accuracy of the Type AP-9 is $\frac{3}{4}$ of 1 per cent of full-scale value; that of the Type DP-9 is $\frac{1}{2}$ of 1 per cent of full-scale value. The line includes ammeters, milliammeters, voltmeters, and wattmeters in all standard ratings. Contained in molded compound case $2\frac{7}{16}$ by $6\frac{3}{16}$ by $4\frac{13}{16}$ in. Write for Bulletin GEA-1784.

Strip-chart Recording Instruments, Type CD: Available for switchboards, surface or semiflush mounting, or in portable form. There is a complete line for a-c or d-c circuits, including ammeters, voltmeters, wattmeters, frequency meters, and power-factor meters. Standard chart speeds are 3 in. per hour for switchboard instruments. Portable instruments have a gearshift that permits chart speeds of either 3 in. per hour or per minute. Driving mechanism may be either an 8-day, spring-operated clock, or a synchronous motor. Available with provision for inkless recording at a slight increase in price. Type CF inkless recording instruments are designed as recording voltmeters, ammeters, milliammeters, microammeters, wattmeters, and tachometers where reliability and maximum convenience to the user are important. Write for Bulletin GEC-216.



Hook-on Instruments: Type AK-1 volt-ammeter measures a-c and voltage quickly; Type AK-2 wattmeter measures power on single-phase and polyphase a-c circuits; and Type AK-3 power-factor meter measures power factor directly without interrupting service. These instruments are useful for spotting overloaded or underloaded motors, locating power losses and overloaded circuits, checking circuits for excess voltage drop, measuring actual voltage applied to electric equipment, and many similar applications. Write for Bulletins GEC-475 (AK-1), GEC-591 (AK-2), GEC-775 (AK-3).

INSTRUMENT TRANSFORMERS

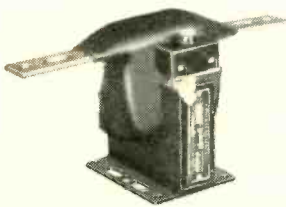

Current Type — Type JKR-2: A small-size indoor current transformer suitable for operating meters, relays, etc. Rated 2500 volts, and supplied in primary-current ratings ranging from 10 to 800 amp inclusive. Mounting feet arranged for either flat-surface or pipe mounting. Primary terminals have uniform distance between boltholes in all ampere ratings, thus facilitating replacement of one transformer with another of higher or lower current rating. Secondary terminals are fixed studs on a terminal block, and are provided with a manually operated short-circuiting switch and a sealable cover. Write for Bulletin GEC-329.



Potential Type — Type JE-1: For operating meters, instruments, relays, and control devices. Mount in any position. Normally rated at 200 va. Core-and-coils thoroughly impregnated with an asphalt-base compound that is moisture-resisting and has a high insulation strength. Write for Bulletin GEA-3166.

Operating
Time
Meter,
Type KT

Type KT time meters provide an accurate, inexpensive method of measuring the life of electron tubes, record total operating time of the machines or devices to which they are connected. They are available in three forms; for panel or switchboard mounting, portable, and for conduit mounting. They also can be furnished to match the operating characteristics of various machines, and are available to measure operating time in hours, tenths of hours, or minutes. These time meters are designed for applications on electron-tube life tests, punch presses, molding machines, etc. For use on 60-, 50-, or 25-cycle a-c circuits. Voltage rating is from 11 to 460 volts for the three available forms of this meter. Write for Bulletin GEC-472.

General-
purpose
Automatic
Time Switch,
Type T-27

Employs Telechron* synchronous motor and is equipped with removable and adjustable riders. Can be furnished with the skip-a-day omitting device and with plain or astronomic dial. These instruments can be supplied with external knob for either "on" or "off" or for both "on" and "off." Can be furnished with 6-watt motors for operation in temperature ranges of $-20F$ to $+110F$. Can also be supplied for 460-volt service in single-pole, single-throw construction only. Dimensions are $7\frac{1}{2} \times 5\frac{1}{2} \times 4\frac{1}{4}$ in. Write for Bulletin GEA-535. *Registered Trade-mark

RECTIFIERS

Selenium Rectifiers for Electronic Applications

They "UP" quality. They "CUT" costs. They provide dependable performance. They save space. Special construction provides constant and uniform contact pressure on all cells, regardless of temperature variations. A moisture-resistant finish gives protection against humidity, condensation, and dampness.

G-E selenium rectifier stacks are available

for use in radio, television, and other electronic circuits requiring 117-volt input with output loads ranging from 80 ma to 350 ma. Thus G-E rectifier stacks may be used in amplifier circuits, voltage-doubler circuits, to eliminate tubes, etc. Made by the G-E evaporation process, these selenium rectifiers have a long life with minimum aging and a stabilized output.

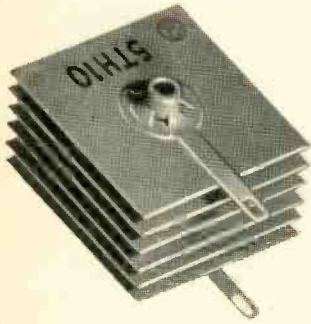

K-type Rectifier Cells for Electronic Circuits

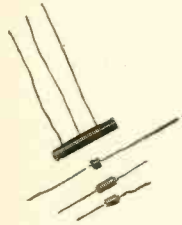

G-E miniature K-type cells can be used to replace tubes in many electronic circuits. Their small size makes them ideal for many applications where space is a problem. Low forward resistance, low back leakage, and minimum aging assure satisfactory service under normal conditions. Typical applications are: Dual-diode circuits • Voltage-doubler circuits • Blocking. Advantages are: Longlife • Stability • Less replacements (under normal conditions expected to outlast tubes) • Uniformity • Save space • Lower cost (No sockets, minimum installation expense).

	K-1	K-2	K-3	K-4
MAX. RMS VOLTS	18	18	40	18
MAX. INVERSE PEAK VOLTS	25	25	56.5	25
H. W. MAX. PEAK CURRENT M.A.	0.14	3.5	7.0	7.0
H. W. MAX. D.C.M.A.	0.10	2.5	5.0	5.0
F. W. MAX. D.C.M.A.	0.20	5.0	10.0	10.0

The above cells can be assembled into stacks to meet specific requirements.

General-purpose Rectifiers, CR7501

Provide a convenient and reliable source of direct current for numerous applications. Are ideally suited for use with such devices as magnetic chucks, magnets, and to supply power for direct-current motors when properly applied.

A typical rectifier consists of a metal panel on which are assembled the electronic tubes, anode contactor, anode fuses, and cathode protective relay, together with the necessary circuit components. The panel is housed in a standard sheet-metal enclosure suitable for wall or floor mounting, depending upon size and rating. Write for Bulletin GEC-206.

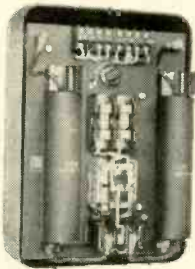

Copper-oxide Rectifiers

The General Electric copper-oxide rectifier; Model No. 6RC8Y3, specially constructed for "self-charging" portable radio receivers. Its advantages include: 1. OCCUPIES LESS SPACE. 2. EASY TO INSTALL. 3. COOL OPERATION. 4. LONG LIFE. 5. AMPLE CURRENT CAPACITY. 6. ALL-METAL CONSTRUCTION. For further information, write to Section 640-284, General Electric Company, Schenectady, New York.

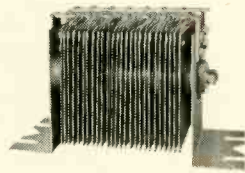

Copper-oxide Rectifier Stacks: offer the following advantages. They . . . Cost less per cell • Stop "aging" after a few months • Are more efficient at high current densities • Will stand short-time voltage (as well as current) overloads. Used for such applications as . . . Circuit-breaker operations • Blocking relays in control circuits • Exciter circuits for ignitrons, etc.

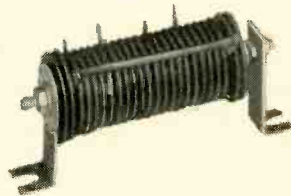

Selenium Rectifier Stacks: are made from the highest-quality selenium cells. Because of their low forward resistance and low back leakage, G-E selenium rectifiers are recognized as the leader in quality at competitive prices. Used for such applications as . . . Control circuits — Power supplies — Arc suppressors — Testing equipment — Relay and solenoid power supplies — Magnetic amplifiers — Business machines — and many special electronic circuits.

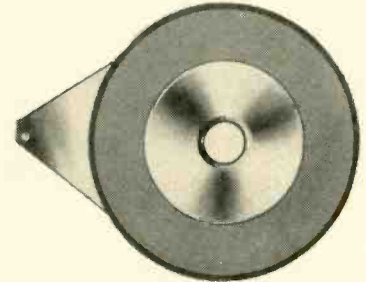

RESISTANCE-WELDING CONTROLS

Resistance welding, a means of uniting metals or alloys. Some of the most striking examples of cost-saving by using resistance welding are in the manufacture of electronic tubes, auto mufflers, spark plugs, milk cans, transformer tanks, automobile bodies, box-cars, etc. This method is especially effective in welding together dissimilar metals.

Production costs go down because no weight is added to the material; speed of manufacture is high; quality is more consistent, and a minimum of operator skill is required. Resistance welding is versatile; foil as thin as 70

millionths of an inch can be spot-welded to leads, or two pieces of heavy steel one-half inch or more in thickness can be welded together.

Good welding requires fast, accurate control. G-E electronic control applied to resistance welding increased by 400-500 per cent the speed of forming liquid-tight and gastight joints. A complete line of G-E electronic resistance-welding controls is available; such as ignitron contactors, synchronous and nonsynchronous spot-welding controls, frequency converters, synchronous seam-welding controls, and sequence and sequence-weld timers.



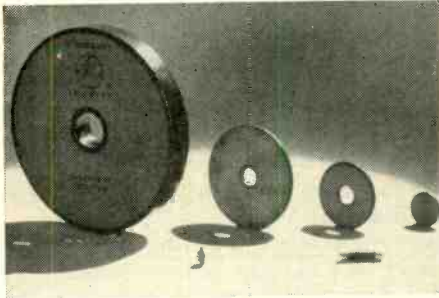

DELAY LINES: provide a means for delaying electrical signals by desired and definite amounts of time, (10 microseconds). The limitations are allowable attenuation and wave-length distortion. They are most frequently employed, however, in lengths which give a delay ranging from 0.25 to 3.00 microseconds. Lines may be obtained in bulk form up to 100-ft.

Specific applications include: Rendering receivers insensitive for a definite time-interval immediately following a transmitter signal. Generation of pulsed signals of predetermined and definite width. Oscilloscope applications — to delay signals with respect to the servo sweep and for single pulse transients. Radar delay-line circuits.

The delay line has a small-diameter core of insulating material covered with numerous turns of insulating wire covered with insulation and a shielded braid or conducting sleeve. A protective covering is wound over the shielded braid. One end of the wire and the braid represents input terminals; the other end represents output terminals. The delay is equal to approximately $\frac{1}{2}$ microsecond for each foot of delay line.

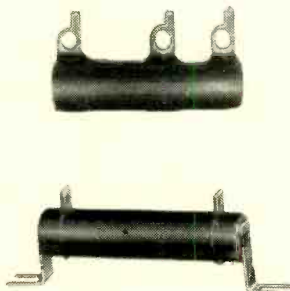

*Registered trade-mark of General Electric Co.

THYRITE* is a nonlinear resistance material possessing the unique electrical property whereby the current varies approximately as a fourth power of the applied voltage.

APPLICATION: To limit voltage surges • As a stabilizing influence on circuits supplied by rectifiers • As a potentiometer • For the control of voltage-selective circuits, either independent of, or in combination with, electronic devices.

SHAPES & SIZES: Usually in disk form, with or without central mounting holes. Dia 0.25 to 6 in. Min thicknesses approx. 0.03 in. for dia of 1 in. or less; 0.06 in. for dia of 3 in.; 0.25 in. for dia of 6 in. Smaller sizes may be furnished with wire leads.

POWER RATINGS: CONTINUOUS: 0.25 watt per sq in. of Thyrite surface for separated disks, with the plane surfaces vertical in still air. Rating may be increased by the use of special provision for cooling, such as radiating fins, forced-air draft, or immersion under oil or Pyranol. **SHORT-TIME:** dependent upon volume of disk; assuming no time for radiation, a temperature rise of 80 C results from energy input of 2000 watt-seconds per cubic in. of Thyrite.

TERMINAL BOARDS: For use where leads are brought to any part for permanent or temporary connection, especially if many wires are involved.

Type EB-5 are fabricated terminal boards. Each is equipped with the necessary washer-head binding screws for circuit-wire connections.

Type EB-6 are fabricated terminal boards of the same construction and dimensions as the Type EB-5, except that clamp-type connectors are furnished for circuit-wire connections.

Boards will accommodate wire sizes from No. 18 to No. 10 inclusive. Where more than 12 poles are required for a particular application, combinations of the standard boards may be used. Write for Bulletin GEA-1497.



Typical EB-5 board with short-circuit strips



Typical EB-6 board with hinged cover



ELECTRONIC TIMER, CR7504A 142: For 60- and 50-cycle, 115- or 230-volt, a-c circuits; 20:1 timing range, with selection from 0.06 to 120 seconds. For uses requiring a short time delay for rapidly repeating cycles, such as the timing of photographic printing, rivet-spinning machines, etc. A number of these relays can be used in circuits for the sequencing of a whole process, such as the filling, heating, and curing operation in an injection-molding machine, the timing of grinding and heat-treating operations, or for sequencing the various stages of industrial processes.

The timing elements are a resistor and a capacitor. The only moving part is the relay armature. The time setting is adjusted by a potentiometer calibrated directly in seconds. Resetting is quick and positive, since this requires only the charging of the capacitor. Write for Bulletin GEA-5255.

RESISTORS

Enameled Resistors, CR9006

Employ a strong, high-heat-resisting, silicate-compound body developed to withstand sudden and extreme temperature changes. Enamel is moistureproof, extremely durable, and forms a mechanically airtight casing for the resistor windings.

Made up in four forms: band terminals and porcelain bushings; band terminals connected to the metal ferrules for fuse-clip mounting; screw base for mounting in lamp socket; band terminals and brackets for mounting feet.

FORM L UNIT

Continuous watt rating (open)	Approx. dimensions (inches)	
	Body diam.	Length
25	$\frac{3}{4}$	$1\frac{1}{2}$
55	$\frac{3}{4}$	4
85	1	$4\frac{1}{2}$
130	1	$6\frac{1}{2}$
200	$1\frac{1}{4}$	$7\frac{1}{2}$

CR9158			
(Enclosed rating)	High	Wide	Deep
85	$9\frac{1}{8}$	2	$2\frac{3}{8}$
170	$9\frac{1}{8}$	2	$4\frac{1}{8}$
255	$9\frac{1}{8}$	$3\frac{1}{2}$	$3\frac{3}{8}$
340	$9\frac{1}{8}$	$3\frac{1}{2}$	$3\frac{3}{8}$

CONTROL ACCESSORIES

A-c or D-c Solenoids, CR9503



Simplify Complex Installations: In direct or remote control requiring short powerful thrusts. Wide Selection: 32 different sizes of solenoids of uniform construction are available for push- or pull-type operation and for use on a-c or

d-c circuits up to and including 550 volts. To push or pull in a straight line, or to provide mechanical motion at a remote or inaccessible location. They may be operated remotely from a push-button station, or, automatically by limit switches, pressure switches, float switches, or other pilot circuit devices. Cut-out switches are available for use on d-c circuits. Write for Bulletin GEA-5163.

Industrial-type Solenoids, CR9503

Type of Solenoid	Pounds Pull or Push		Wt of Plunger in Lb	Max. Stroke in In.
	At 85 Per Cent Voltage	At 100 Per Cent Voltage		
Pull	0.65	0.9	0.12	3/4
Pull	0.9	1.3	0.15	1
Pull	3.2	4.5	0.31	1
Push	3.2	4.5	0.5	1
Pull	4.0	6.0	0.5	1 1/4
Push	4.0	6.0	0.8	1 1/4
Pull	10.2	14	0.9	1 1/4
Push	10.2	14	1.2	1 1/4
Pull	22.7	30	2.5	1 3/4
Push	22.7	30	3.3	1 3/4
Pull	21.7	30.2	3.3	2
Push	21.7	30.2	4.0	2
Pull	42	57	5	2
Push	42	57	7.0	2
Pull	51	73	10	3
Push	51	73	16	3
Pull	70	97	13	3
Push	70	97	19	3

Solenoid operated Valves, CR9507



Sizes 1/4- and 3/8-inch pipe tap-sizes are standard, pressure ranges to 150 lb per sq in.; maximum temperature 135 C. 3/32-in. orifice is std; 1/8-inch orifice can be furnished. This small self-contained solenoid valve is ideally suited for automatic control of water, light oils, steam, and refrigerants.

It is simple in design, having only two moving parts and no stuffing box, thus assuring long life and low maintenance. To permit regulation of flow through the valve, a conveniently located metering pin is provided. The metering pin may be omitted if desired. This valve is supplied with cadmium-plated finish.

Selsyns, CR9890: Indicating or control selsyns are a reliable, accurate, and rapid means of communication. They are being used successfully in such applications as indicating the positions of valves, governors, bridges, turntables, dampers, etc. These selsyns have been very successful in servo systems where the selsyns operate to guide the action of the power units.

Two types of selsyns are available—the high-accuracy type which has an accuracy of ± 1 degree and the general-purpose type which has an accuracy of ± 5 degrees. Selection can be made from a variety of sizes suited for each application. Selsyns are also available in a variety of complete indicators and transmitters. Write for Bulletin GEA-2176.

Solenoid Valve, CR9508-A100B

The CR9508-A100B solenoid valve is a small, inexpensive fluid-control device, particularly adapted to the requirements of the heating and air-conditioning industry as well as to general applications for the control of air, oil, water, and gas. Because it is designed to be incorporated into an assembly that has its own enclosure, no coil cover, conduit plate, or similar accessories, have been provided.

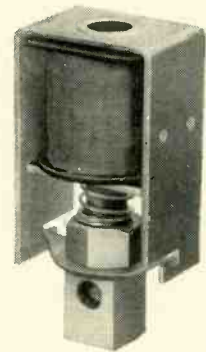

APPLICATIONS: Water control for humidifiers. Water control for laundry and dish-washer equipment. Oil shutoff for oil-burner service. Pilot-gas control for gas burners. Air control for compressed-air devices. Evaporative cooling equipment control (dessert coolers).

Limit Switches

G.E. has a complete line of switches to make or break control or indicating circuits when a part of the mechanism comes in contact with a lever arm. Available for operation by roller lever, plunger, or push rod and may have a combination of circuits.

Switchettes, CR1070: These midget devices have snap action and double-break construction. They are especially applicable where space is limited and long life is desired. They are used wherever a manually or mechanically operated switch is required, such as: in automatic washing machines; in temperature or pressure limits for domestic oil burners and stokers; in juke boxes, vending machines; and to time industrial processes and operations. A large variety of forms is available to meet any requirements. Rating at 50,000 feet on 12 and 24 volts. Single-circuit forms or 2-circuit form with electrically separate circuits . . . Size 1, 10 amp. Size 2, 25 amp. Wired to provide

single-pole, single-throw . . . Size 1, 3.5 amp. Size 2, 4 amp. Contact structures available: Single-circuit, normally closed; Single-circuit, normally opened; Two-circuit—one normally open, and one normally closed. Write for Bulletin GEA-4888 (Size 1) and GEC-207 (Size 2).

	Size 1	Size 2
Weight	0.02 lb	0.125 lb
Plunger travel differential	0.020 in.	0.040 in.*
	—0.007 in.	
Travel to trip	0.037 in.
	—0.012 in.	

*Approximately same as contact air gap.

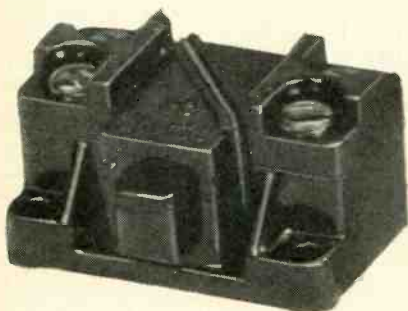

RELAYS

Current-sensitive Relays, CR2791C

For electronic applications where switching functions must be performed by small amounts of power, a line of current-sensitive, d-c relays is available. Withstand shock and vibration and operate in ambient temperature from -70°F to 200°F . Cover range from 40 mw to 50 mw; 1.6 ma to 765 ma; 0.059 ohms to 14,000 ohms coil resistance; and weigh from 0.22 lb. Contact ratings from 12 v d-c (a-c) with a contact rating at 24 v (d-c) of 2.0 amp noninductive and 0.5 amp inductive. Installation easy with plug-in base or solder-type terminals. Write for Bulletin GEA-3819D.

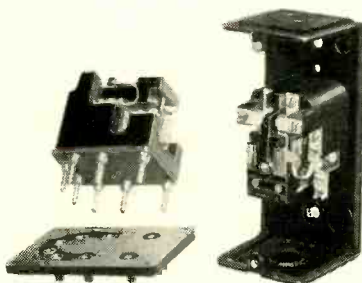

General-purpose Relay, CR2790E

This relay is used to control pilot circuits in response to remote control switch or thermostat, or for direct control of small motors driving pumps, fans, etc. It is also used as a fractional-horsepower motor starter, or in conjunction with a magnetic switch controlling larger motors, heating or lighting circuits, and signal systems. This sturdy, general-purpose relay comes in 7 open or enclosed forms: enclosed in general-purpose case, or in explosion-proof and watertight case; open relays may be front-connected or back-connected; or for mounting on a metal base or an insulated base, or with plug-in jacks. 3 contact arrangements are available: double-pole, double-throw; double-pole, single-throw; single-pole, single-throw. Protection against hazard from restarts after power failures can be provided with the double-pole form when one pole is used as a holding interlock in the coil circuit together with a momentary-contact push-button station. The relay can be mounted on either insulated or non-insulated bases. The enclosed forms have convenient conduit entrances at both top and bottom. Write for Bulletin GEC-257.

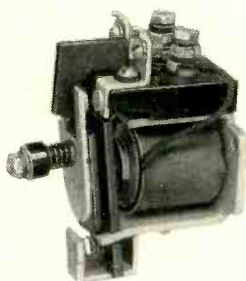

15-amp Contactor, CR2810-1265: For small motors; this normally open, single-pole, single-throw contactor is small, self-contained, and inexpensive. The coil is of the layer-wound type, requires only a few watts of power, and is connected directly across the line. The connections are easily made: all terminals are in the top molded part. A form is available which includes a noninsulated interlock, permitting the use of a momentary-contact push button for operating the contactor; the combination provides under-voltage protection.

Hp Rating,
Single-phase

Type	110 v	220 v
Open	$\frac{1}{2}$	$\frac{1}{2}$
Enclosed	$\frac{1}{2}$	1

Push-button Stations: For control circuits of magnetic controllers designed for push-button control. Standard- and heavy-duty stations available which may consist of various combinations of momentary-contact buttons, maintaining-contact buttons, selector switches, indicating lights, for surface or flush mounting. Standard-duty station recommended for use with contactors rated up to and including 150 amp. Heavy-duty push-button stations handle higher control currents. Large, double-break contacts and substantial construction of heavy-duty stations withstand frequent operation and rough usage on machine-tool and similar applications. General-purpose, watertight, dust-tight, and explosion-proof inclosures.

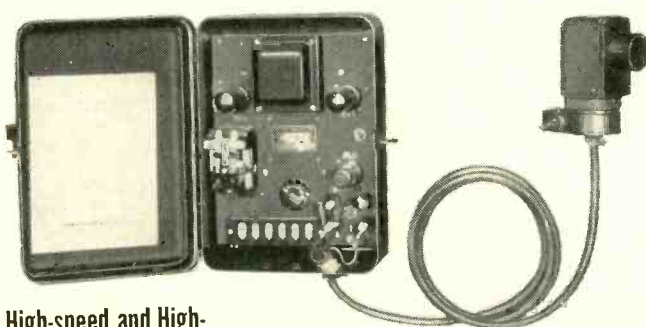

High-speed and High-sensitivity Photoelectric Relays: Designed for high-speed operation, with adjustable sensitivity to meet various conditions of phototube illumination. Adjusts to close or open circuit upon suitable light change. Relay operates from an a-c power supply. A rectifier and filter circuit supply d-c voltages to the phototube and amplifier tubes, making the response time independent of the frequency of the power supply. Operates between 1 and 10 foot-candles; a light change of $\frac{1}{2}$ ft-c will pick up or drop out the relay. The photoelectric amplifier can be adjusted to respond to a signal as short as 0.001 second where the signal may be a light flash or a light interruption, but the light intensity should be well over $\frac{1}{2}$ ft-c and the light interruption should be complete, producing total darkness at the phototube. Write for Bulletin GEC-279.



General-purpose Photoelectric Relay

This general-purpose, photoelectric relay kit, CR7505-K100G3, including a double-pole, double-throw magnetic relay, operates from the interruption of a beam of light making it simple for items on a production line to be counted easily and quickly. The relay also makes possible automatic weighing with a beam scale and automatic signaling for elevators or doors which saves valuable time. Relay operates without a lens in front of the phototube, on a minimum of 40 foot-candles at the aperture, and will reset when light intensity is reduced to 30 foot-candles or less. Write for Bulletin GEA-3533C.



THY-MO-TROL DRIVE*

Electronically Operated, Adjustable-speed Drive; Full-range, Stepless Speed Control
Standard Ratings from Fractional- to 30-hp — Larger Sizes Available

A complete equipment consisting of an anode transformer as required, control and rectifier panel, a control station, and a suitable d-c motor. It operates from an a-c power line. Starting, stopping, reversing, and adjustment of speed are all controlled from the single compact control station. Acceleration is automatic, and motor is protected against overload.

Operating Features

1. FULL RANGE—A single dial—small as a radio volume control, mounted in the push-button control station—gives complete adjustment of motor speed, from low to maximum, without steps. Gives exact speed wanted.

2. HOLDS SPEED—Regardless of ordinary line-voltage or load fluctuations, Thy-mo-trol electronic circuits hold speed constant within extremely narrow limits. Provides both full speed-range and flat speed-load characteristics.

3. FULL TORQUE—Although motor may be scarcely turning over, it can deliver full torque right up to the current-limit point. This means maximum machine output.

4. CURRENT-LIMIT ACCELERATION—Regardless of the speed-control setting when the START button is pushed, full-wave Thy-mo-trol acceleration is smooth because of electronic current limiting. Starting is extremely fast because of sustained maximum torque during acceleration. No sudden application of excessive torque; therefore, no shock to the machine. No current peaks on the line.

5. OTHER THY-MO-TROL ADVANTAGES—Speed can be preset before starting; saves space; no stop for speed change; easy to control automatically; operates direct from a-c line, no d-c supply needed.

Applications

Drill presses, to increase speed range and variety of work handled. Grinders, for precise speed selection and improved finish. Milling machines, to increase work range handled, and to simplify design. Propeller testing, for accurate, smooth speed control. Cable reelers, to maintain constant tension. Conveyors, to match speeds, and many other applications.

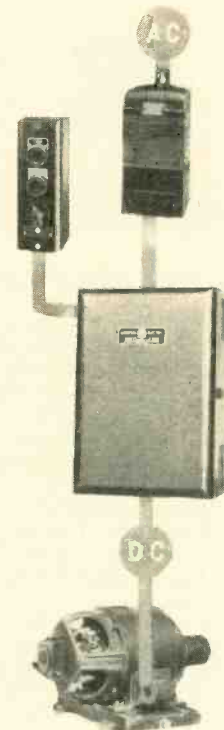

*Registered trade-mark of General Electric Co.

FOR INFORMATION ON G-E APPARATUS PRODUCTS NOT SHOWN IN THESE PAGES

Space does not permit description of all G-E products related to the electronic field. Listed below are those not shown in preceding pages. For full details and bulletins write G-E at Schenectady, New York.

- | | | | |
|--|--|--|--|
| <ul style="list-style-type: none"> Amplifiers Photocell Write for details Servo Write for details Strain Gage Write for details Ultrasonic GEC-544 Analizers Noise GEC-665 Spectrum GEC-307 Surface Analyzers and Comparators GEC-311 Vibration GEA-4140 Wave Write for details Arrestors, Lightning GEA-2975 Battery Chargers Hdbk. 9172 Bearings, Jewel GEC-378 Bearings, Miniature GEC-378 Blowers, Small Write for details Breakers, Circuit GEA-3642, GEA-4951 Bridges, Capacitance GEA-4610 Bridges, Electrical GEC-251 Brushes, Carbon and Graphite Hdbk. 3896 Cameras, Cathode Ray Oscillograph GEC-593 Chokes Audio Filter Power GEC-481 Colorimeters Photoelectric GEC-800 Communication Systems 3. Carrier Current GEA-4691 Comparators Automatic Resistance GEC-466 Controls Chemical Hdbk. 2760, 2765 Counting and Sorting Hdbk. 2310 Door GEA-5034 Elevator Leveling GEA-5043 Frequency GEC-491 Heat Treating GEA-3301 Humidity Hdbk. 3312 Illumination Hdbk. 2361 Inspection GEC-279 Liquid Level GEC-411 Loop Regulation. Write for details Machine Safety Write for details Material Thickness GEC-485 Mechanical Switch GEA-4371 Package Wrapping GEA-4371 Photographic Exposure GEC-287 Positioning GEA-2176 Pressure Hdbk. 2230 Printing GEA-4683 Refrigeration Defrosting Write for details | <ul style="list-style-type: none"> Register GEA-4371, GEA-5079 Register Cutter GEA-4371 Smoke & Combustion GEA-5254 Temperature GEC-1005 Vacuum Hdbk. 2232 Ventilating Control System Hdbk. 2750 Converters High Frequency GEA-4903, Low Frequency } GEA-5551 Rotary Cyclotrons Write for details Detectors Alpha } GEA-693 Beta } Flaw and Defect GEC-706 Leak GEC-233 Vibration GEA-4140 Dynamometers Electrodynamometers } GEC-342 Fluxmeter } Furnaces High Frequency GEC-1005 Gages Comparator GEC-466 Ionization Hdbk. 3362 Paint Depth GEC-319 Pressure Hdbk. 3362 Strain GEA-3673 Vacuum GEA-4313 Galvanometers GEC-694 Generators Gas-engine-driven GEA-5299, GEC-499 Harmonic Frequency GEC-582 High Frequency Hdbk. 6118 Induction and Dielectric Heating Hdbk. 2608 Motor GEC-302 Pulse GEC-792 Ultrasonic GEC-544 Heating Electronic—Accessories & Associated Equipment GEA-4348, GEA-4989 Electronic Induction GEA-4945 Indicators Antenna Position GEA-2176 Broadcast Volume Hdbk. 8041 Dew Point GEC-588 Film Thickness GEC-319 Humidity Hdbk. 3312 Illumination GEA-4926 Liquid Level GEA-3833 Material Thickness GEC-485 Moisture Hdbk. 3312 Nuclear Radiation Hdbk. 3330RL Photographic Exposure GEA-4926 | <ul style="list-style-type: none"> Positioning GEA-2176 Power Level Write for details Pressure Hdbk. 2230 Shorted Turn GEA-4539 Smoke & Combustion GEA-5254 Sound Level GEC-536, GEC-665 Strain GEA-3673 Telemetering GEA-5233 Temperature GEC-565 Timing GEA-5108 Torque GEA-4441 Turbidity GEA-4173 Vacuum GEA-4313 Inverters Hdbk. 1545 Irons, Electric Soldering GEC-1005 Jewels, Glass Hdbk. 8048 Machines, Vibration Fatigue Testing GEC-309 Magnetic Analysis Equipment GEC-342 Magnetizers and Demagnetizers GEC-589 Magnetometers GEA-4648 Meters d'Arsonval GEC-377 Decibel GEC-665 Distortion and Noise GEC-665 Field Intensity GEC-238 Field Strength GEC-238 Footcandle GEA-4926 Light GEA-4926 Phase Angle GEC-308 RF Power GEC-403 Sound Level GEC-665 Tension Hdbk. 3337 Thermocouple GEC-714 Vibration GEC-285 Viscosity GEC-339 Motors Fractional hp GEC-188 Servo GEA-2176 Synchronous GEA-4248, GEA-5426, GEC-344 Oscillators, Ultrasonic GEC-544 Oscillographs Multi-element } GEC-449 Recording } Ovens, Electric Hdbk. 3625 Photoflash Equipment, Electronic GEC-337 Photometers GEC-412 Pilots, Automatic Write for details Pots, Soldering GEC-1005 Pots and Tanks, Heating GEC-1005 Power Supplies High Voltage GEC-751, GEC-752 Regulated Hdbk. 3357RL | <ul style="list-style-type: none"> Pyrometers and Potentiometer Pyrometers GEA-5534, GEC-713 Recorders Material Thickness Write for details Moisture GEC-588 Potentiometer GEC-367 Temperature GEA-5534 Regulators Current Hdbk. 2415 Frequency GEA-2150 Rheostats GEA-1979 Shunts, Meter Hdbk. 8029 Spectrometers, Mass } GEC-587 Spectrometers and Spectrographs } Spectrophotometers GEC-307 Speedometers, Electric Write for details Switches Float Type Hdbk. 2237 Knife Hdbk. 7123, 7125 Lever Hdbk. 2260 Pressure Operated Hdbk. 2232 Snap Action GEA-4643 Toggle and Pushbutton GEA-1522 Vacuum Hdbk. 2232 Synchros GEC-218 Tachometers, Electronic GEC-224 Telemetering Systems, Electronic GEA-5233 Terminal Strips GEC-400 Testers Coating Thickness GEC-319 Coil GEA-4539 Insulation GEC-612 Meter GEC-373 Thermocouples, Pyrometric GEC-714 Thermometers, Resistance GEC-565 Timers Automatic Cycle GEC-452 Automatic Interval GEA-5108 Automatic Reset GEC-452 Motor Operated GEC-525 Sequence GEA-3318 Tubes, Vacuum Thermocouple Vacuum Indicating, Recording, and Control Equipment } GEC-385 Varistors GEC-484 Vibration Analysis Equipment GEC-285, GEA-4140 Equipment, Electronic Balancing GEC-320 |
|--|--|--|--|

THERE'S A G-E ELECTRONIC TUBE FOR EVERY PURPOSE

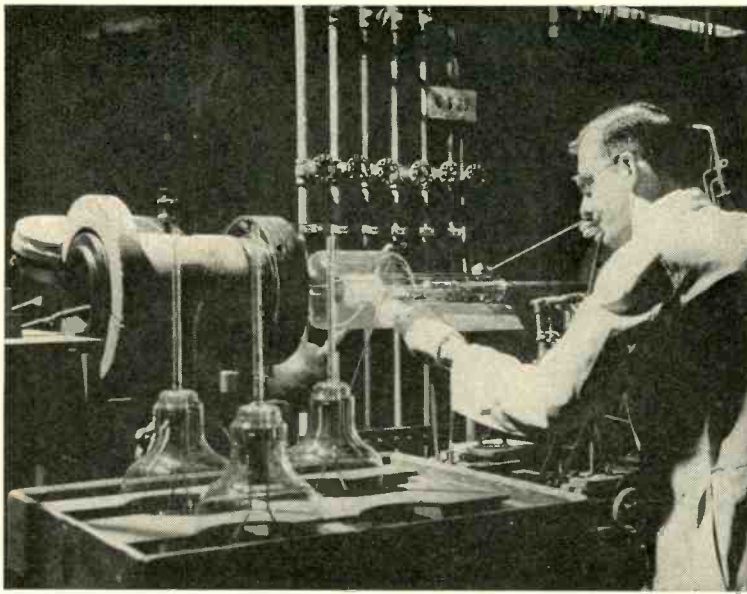

G-E Electronic Tubes are accurately designed to meet the exacting requirements of electronic circuits—whether for communications or industrial use. They are manufactured under rigid material and process controls to assure lasting performance within their ratings. New applications in communications and industrial equipment constantly demand new tube types—G-E designs tubes to meet every need.

**A Complete Listing of
G-E TRANSMITTING AND INDUSTRIAL TUBES**

The following list illustrates the completeness of the G-E Line —
An Electronic Tube for Every Purpose

For complete data send for the G-E Tube Manual shown on the opposite page.

GL-2C39-A
GL-2C40
GL-2C43
GL-2E24
GL-2E26

GL-2E30
GL-3C22
GL-1000T
GL-4C21
GL-4D21/4-125A

4X150A
GL-5C24
4-250A/5D-22
GL7C29
GL-7D21

8D-21
GL-9C21
GL-9C22
GL-9C24
GL-35T

GL-100TH
GL-146
GL-152
GL-159
GL-169

GL-203-A
GL-204-A
GL-207
GL-211
GL-242-C

FP-265
FP-285
GL-473
GL-592
GL-800
GL-801-A

PLIOTRONS

GL-802
GL-803
GL-805
GL-806
GL-807

GL-809
GL-810
GL-811-A
GL-812-A
GL-813

GL-814
GL-815
GL-826
GL-828
GL-829-B

GL-830-B
GL-832-A
GL-833-A
GL-835
GL-837

GL-838
GL-842
GL-843
GL-845
GL-849

GL-851
GL-858
GL-862-A
GL-880
GL-889-A
GL-889R-A
GL-891
GL-891-R

GL-892
GL-892-R
GL-893-A
GL-893A-R
GL-895

GL-895-R
GL-898-A
GL-954
GL-955
GL-956

GL-957
GL-959
GL-1000T
GL-1603
GL-1612

GL-1613
GL-1614
GL-1619
GL-1620
GL-1621

GL-1622
GL-1623
GL-1624
GL-1625
GL-1629

GL-1633
GL-1851
GL-5513
GL-5516
GL-5518
GL-5549
GL-5556/PJ-8
GL-5588

GL-5610
GL-5648
GL-5654
GL-5670

GL-5674
GL-5680
GL-5686
GL-5691
GL-5692

GL-5693
GL-5725
GL-5726
GL-5739/FP-62
GL-5740/FP-54

GL-5742/PJ-7
GL-5743/PJ-21
GL-5749
GL-5750
GL-5763

GL-5814
GL-5824
GL-5844
GL-5963
GL-6005

GL-6019
GL-6039
GL-6046
GL-8000
GL-8002

GL-8002-R
GL-8005
GL-8025-A
GL-9001
GL-9002
GL-9003

THYRATRONS

GL-C1J
GL-C1K
GL-2D21
GL-3C23
FG-27-A

FG-81-A
FG-97
FG-98-A
FG-105
FG-154

FG-172
FG-178-A
GL-393-A
GL-414
GL-502-A

GL-627
GL-627-A

GL-678
GL-884
GL-885

GL-2050
GL-5544
GL-5545
GL-5557/FG-17
GL-5559/FG-57

GL-5560/FG-95
GL-5632
GL-5662
GL-5663
GL-5720/FG-33

GL-5728/FG-67
GL-5830/FG-41
GL-5855
GL-6044

VACUUM CAPACITORS

GL-1L21
GL-1L22
GL-1L23
GL-1L24
GL-1L25

GL-1L31
GL-1L32
GL-1L33
GL-1L36
GL-1L38

CATHODE RAY TUBES • KENOTRONS • PHOTOTUBES

GL-2AP1-A
GL-2BP1
GL-3AP1-A
GL-3BP1-A
GL-3KP1

GL-3MP1
GL-5BP1-A
GL-5CP1-A
GL-5CP7-A
GL-5FP14

GL-5UP1
GL-7BP1
GL-7BP7-A
GL-12DP7-A

GL-914-A

GL-2B22
GL-2B23
2X2-A
5R4-GY

GL-217-C
GL-218
GL-3B24
FP-400
GL-411

GL-836
GL-1616
GL-1641
GL-5625/KC-4
GL-5741/FP-85-A
GL-5973

GL-8013-A
GL-8020
GL-9004
GL-9005
GL-9006

GL-1P21
GL-1P29/FJ-401
GL-1P37
GL-1P39
GL-1P40
PJ-22
GL-441
GL-868/PJ-23
GL-917
GL-918
GL-919
GL-920
GL-921
GL-922
GL-923
GL-927
GL-929
GL-930
GL-931-A
GL-935
GL-5581

PHANOTRONS • GLOW TUBES • BALLAST TUBES

FG-166
GL-266-B
FG-280

GL-575-A
GL-673
GL-816
GL-857-B
GL-866-A

GL-869-B
GL-870-A
GL-872-A
GL-5558/FG-32
GL-5561/FG-104
GL-8008

GL-OA2
GL-OA3
GL-OB2
GL-OB3
GL-OC3

GL-OD3
GL-874

GL-5620/FB-50
GL-5621/B-6
GL-5622/B-25
GL-5623/B-47
GL-5624/B-46

VACUUM SWITCHES • PHASITRONS • VACUUM GAGES

GL-5626/FA-15
GL-5627/FA-6

GL-2H21
GL-5593

GL-5628/FA-13
GL-5629/FA-14

IGNITRONS

GL-5550/GL-415
GL-5551/FG-271

GL-5552/FG-235-A
GL-5553/FG-258-A
GL-5822

GL-506
GL-5779
GL-5554/FG-259-B
GL-5555/FG-238-B
GL-5630



GL-813

PIOTRON



GL-592

PIOTRON



GL-7D21

PIOTRON



GL-502A

THYRATRON



GL-5545

THYRATRON



GL-5560/FG95

THYRATRON



GL-872-A

PHANOTRON



GL-8020

KENOTRON



IGNITRON
GL-5552/FG-235-A



IGNITRON
GL-5551/FG-271

Welding Control Types*	MAXIMUM RATINGS			
	Kva Demand	Corresponding Average Anode Current, Amp	Maximum Average Anode Current, Amp	Corresponding Kva Demand
GL-5550/GL-415	300	12.1	22.4	100
GL-5551/FG-271	600	30.2	56.0	200
GL-5552/FG-235-A	1200	75.6	140	400
GL-5553/FG-258-A	2400	192.0	355	800
GL-5822†	424	20	70	188

*Ratings are for voltages of 600 volts rms and below. Ignitor requirements for all welding-control types are 200 volts and 30 amperes.
†For frequency-changer welding control.

GENERAL ELECTRIC

ELECTRONIC TUBE MANUALS . . .



. . . complete data available on every G-E tube! Designed for and by technical men, the new G-E Electronic Tube Manuals pictured to the left are complete in every detail. They contain comprehensive data on the electrical, mechanical, and performance characteristics of every G-E tube type. Let their easy-to-read graphs and tube outlines help to solve your application problems. For prices and further information write Electronics Department, General Electric Company, Schenectady 5, N. Y.

KON-NEC-TOR MERCURY SWITCHES

Most KON-NEC-TORS are made of heat resisting Pyrex brand glass with current conducted to mercury by tungsten lead-in wires. The small force necessary to tilt a KON-NEC-TOR, wherever available, will cause it to operate positively and silently. Types are also available which are operated by a magnetic field from either a permanent or an electro magnet. Chart on their characteristics is given below and engineering service is available to all users.

GENERAL INFORMATION

Type	Switching Action	Max. Height	Max. Length	Max. Diam.	Lead Length (Inches)	Holder Clip #	Average Weight in Grams	Internal Resistance in Ohms*	Total Movement Required in Degrees
1-1KR1	SPST N. Open	—	2¼	0.562	5¾	4839	10	0.25	} Magnetically Actuated
1-2KR1	SPST N. Closed	—	2¼	0.562	5¾	4839	10	0.25	
1-15KRO	SPST	—	1½	0.300	—	—	2.5	0.022	14
2-25KR1	SPST	—	2⅞	0.656	8	4839	14	0.003	14
2-33KR1	SPST	—	1⅞	0.531	8	6601	8	0.006	15
2-36KR1	SPDT without neutral	—	2¾	0.625	8	6602	30	0.007	14
2-52KR1	SPST	—	1½	0.406	8	6601	5	0.05	15
4-19KR1	SPDT without neutral	1⅜	1½	0.480	8	4838	41	0.006	30
4-21KR1	SPST	1⅜	1½	0.480	8	4838	28	0.006	20
4-24KR1	SPDT with neutral	1⅜	2⅜	0.480	8	4838	41	0.007	20
4-40KR1	SPST	1⅜	2¾	0.625	8	4839	28	0.008	15
7-19KR1	SPDT without neutral	1⅜	2⅜	0.550	8	4839	86	0.004	20
7-21KR1	SPST	1⅜	2½	0.550	8	4839	57	0.004	15
7-24KR1	SPDT with neutral	1⅜	3⅞	0.550	8	4839	71	0.005	20

The type number ending designates type of lead attached to the Kon-Nec-Tor. KR1 means standard (8" long, cotton covered) leads are attached. KRO means the Kon-Nec-Tor is furnished without leads.
*Excluding flexible leads.

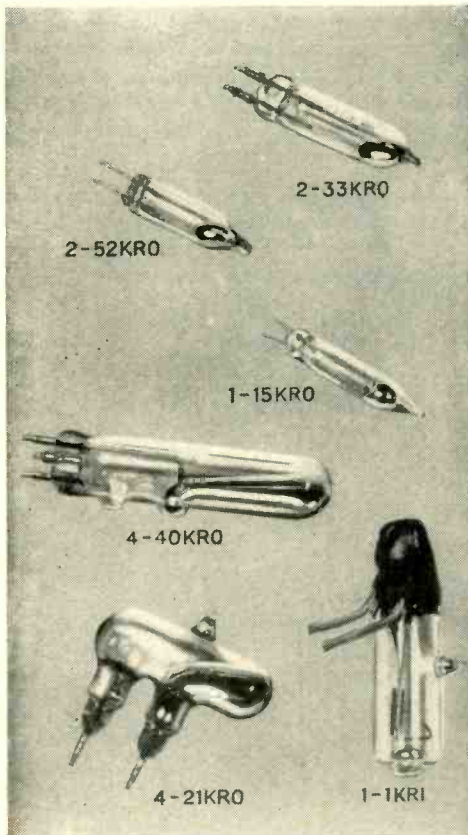

ELECTRICAL RATINGS

TYPE	VOLTAGE MAXIMUM CURRENT RATING—AMPERES								MOTOR RATINGS—HORSEPOWER			
	Non-Inductive Circuit			Inductive Circuit		Incandescent Lamp Circuit		D-C	A-C 60 Cycles			
	A-C	D-C		A-C	D-C	A-C	D-C		Split-Phase	Capacitor	Repulsion-Induction	2 and 3 Phase
1-1KR1 1-2KR1	125 250	0.3 0.15	0.15 0.08	—	—	—	—	—	—	—	1/60 1/60	—
1-15KRO	8 125	5 0.100	5 0.100	—	—	—	—	—	—	—	—	—
2-25KR1 2-36KR1	125 250 550	5 3 1	3 1.5 **	5 3 1	* * **	1 1 1	1 1 **	** ** **	1/12 1/6 —	1/12 1/6 —	1/6 1/4 —	** ** —
2-33KR1	125 250	3 2	2 1	3 2	* *	1 1	1 1	** **	1/20 1/10	—	1/12 1/8	** **
2-52KR1	8 125 250	5 2 1	5 1 0.5	—	—	—	—	—	—	—	—	—
4-19KR1 4-21KR1 4-24KR1 4-40KR1	125 250 550	15 10 8	10 5 **	15 10 8	* * **	10 10 5	10 5 **	1/4 1/4 **	1/4 1/4 —	1/2 1	3/4 1 1/2 —	3/4 1 1/2 3
7-19KR1 7-21KR1 7-24KR1	125 250 550	25 20 15	20 10 **	25 20 15	* * **	20 20 15	20 10 **	1/2 1/2 **	1/4 1/4 —	1 2	1 1/2 3 —	1 2 5

*No specified rating can be stated. Capacity is lower than on noninductive circuits.
†Ratings following this bracket apply to all types listed in this individual group.

**Not recommended for this service.

MOUNTINGS

Because proper mounting is essential to the satisfactory performance of these KON-NEC-TORS, clips of tempered cadmium plated steel are provided. These are sufficiently flexible to securely hold the somewhat variable diameters characteristic of glass tubes. The use of a drop of adhesive at each clip contact is recommended, to insure the KON-NEC-TOR remaining in the correct mounting plane.



TUBE SOCKETS AND WATER JACKETS

Designed and built for G-E Tubes, they have the same high quality and performance characteristics. Specify them for increased assurance of superior performance and tube life. Available in all popular types.





G-E MYCALEX is particularly advantageous where the requirements demand (a) high-mechanical strength; (b) high-dielectric strength and insulation resistance; (c) low losses at high frequencies; (d) arc resistance; (e) heat resistance well beyond the critical temperature for molded or sheet materials; and (f) a compact construction with metal inserts securely molded in place. Metal parts can be inserted or combined with G-E mycalex during the process of molding. Not only is a tighter and stronger bond between the insulating material and metal components thus obtained, but also economies can be realized by eliminating or simplifying subsequent assembly operations.

G-E mycalex while a hard, stone-like product, can be subjected to all the usual machining operations. Mechanically, G-E mycalex can be used with other essential components in combinations that are impossible with other inorganic insulating materials, such as mica, porcelain, and steatite. In this feature alone it offers unusual advantages from the standpoint of redesigning.

The molding process is used for the production of more intricate shapes, with or without metal inserts. Molded parts conform exactly to the contours of the mold cavity with no mold shrinkage. Parts with close, precise dimensions, with no variation between individual pieces, can therefore be produced in large quantity.

No. 1360 G-E MYCALEX: Used principally for the manufacture of molded parts with or without metal inserts, such as brush-holder studs and similar units used on apparatus other than electronic.

No. 2802 G-E MYCALEX: Adapted to applications, such as in electronic devices, where low-dielectric power loss at high frequencies is of primary importance. It conforms to Joint Army-Navy Specs JAN-I-10, Grade L-4.

No. 2803 G-E MYCALEX: Suitable for general use where very low-dielectric power loss is not an essential requirement. Where weight is an important factor, this grade should be considered, as its specific gravity is approximately 27 per cent less than that of No. 2802.

IMPORTANT PROPERTIES OF G-E MYCALEX

PROPERTY	TEST*	No. 1360	No. 2802	No. 2803
Power factor (PF)	A		0.0014	0.0022
Dielectric constant (K)	A		9.20	6.9
Dielectric strength volts/mil (Thickness — 1/8 in.)	B	340	320	400
Arc resistance — Sec.	C	320	250	240
Tensile strength (lb/sq in.)	C	5000 to 7000	5000 to 7000	5000 to 7000
Compressive strength (lb/sq in.)	C	22,000 to 30,000	22,500 to 27,500	27,500 to 30,000
Resistance to impact (Ft.-lb./in. of notch)	D		0.7	0.6
Hardness	C	22-L	80-105K	80-105K
Coef. of linear expansion (In./In./°C)	E	8 x 10 ⁻⁶	10.9 x 10 ⁻⁶	11.7 x 10 ⁻⁶
Specific heat (Cal./gm/°C)			0.13	0.24
Specific gravity		3.44	3.6	2.64
Surface		Slightly Rough	Very Smooth	Very Smooth

*A—1 mc at 25°C (dry) B—60c at 25°C short time C—At 25°C
D—Izod test at 25°C E—Temp. range 20° to 350°C
METHOD OF TEST: ASTM Color: Gray

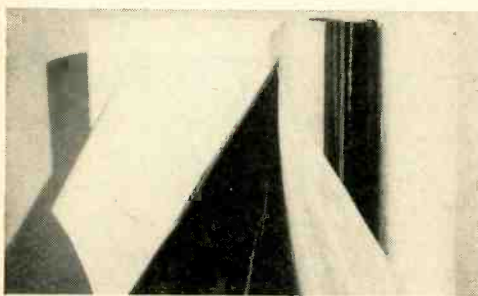

G-E VARNISHED CLOTHS AND TAPES:

G-E varnished cloth has many advantages which make it particularly desirable for insulating various forms of electrical apparatus. Because of its high degree of flexibility and high mechanical strength, varnished cloth may be wound or wrapped tightly in place on many different devices such as cables, armature field, transformer, and various other types of coils. It is preferred to untreated fabric because of its higher dielectric strength, greater resistance to moisture, and better heat-aging characteristics. Generally speaking, cloths treated with black varnish possess higher dielectric strength than those treated with yellow varnish. However, the latter have greater resistance to abrasion and to oil.

G-E VARNISHES and COMPOUNDS:

G-E insulating and finishing varnishes offer suitable characteristics for practically every purpose. This complete line consists of clear and black air-drying varnishes, clear and black baking varnishes, finishing and sticking varnishes.

G-E insulating compounds are not injurious to any of the materials with which they are commonly used, and will maintain their properties under normal working conditions. G-E sealing and filling compounds have a great number of uses. Their applications include filling of field coils, treating of high voltage paper-insulated cables, filling of porcelain parts, filling of cable end bells, cable joints and coupler sockets, and sealing of transformer terminal bushings. Send for the bulletin, "G-E Insulating Materials."

CHEMICAL & ELECTRICAL CHARACTERISTICS

E—Excellent G—Good F—Fair P—Poor

PROPERTY	G-E Number			
	457	9564	9574	9466
Type	Black Air-Drying	Clear Air-Drying	Clear Baking	Black Baking
Dielectric strength Volts mil	1160	1540	2200	3000
Dielectric strength after 24 hours water immersion	400	570	1400	1200
Build relative	E	G	E	G
Adhesion	G	G	E	G
Toughness	P	G	E	F
Hardness	P	G	E	F
Flexibility	F	G	E	G
Penetration	F	G	E	G
Bonding	F	G	E	G
Bonding high temp	P	P	E	F
Through-cure (Cup Test)	G	F	E	P
Aging flexibility (100°C)	P	G	E	E
Aging static test (150°F) (Reds)	P	G	E	E
Water	E	E	E	G
Acid	E	E	E	G
Alkali	E	G	E	G
Oil	P	G	E	E
Salt water	E	E	E	E

SILICONE RUBBER

PROPERTIES: Continuous exposure of all grades to temperatures of 300-325 F shows little increase in surface hardness • Remains flexible at very low temperatures • The mechanical properties after exposure at temperatures in excess of 275 F, generally far excel those of conventional rubber stocks • Hardness, flexibility, and elongation properties are nearly constant with changes in temperature • Has excellent compression set, even at high temperatures • Possesses excellent electrical properties under wide ranges of temperature and frequency • Is characterized by little change in dielectric strength or surface conductivity with temperature or humidity • Loss factor remains at a low value at frequencies as great as 10^8 cycles per second • Arc and corona resistance is remarkably good as well as non-tracking characteristics • Possesses resistance to a wide variety of industrial solvents and chemicals and is almost unaffected by continuous service at high ozone concentrations.

ELECTRONIC APPLICATIONS: Can be used in electrical circuits where mechanical properties together with high dielectric strength and low loss factor are necessary over a wide temperature range • G-E silicone rubber finds ready application in contact with organic insulating liquids, for it contains no plasticizer to leach out and contaminate the liquid • An important application has been in the sealing of small liquid filled capacitors and transformers against leakage or contamination. This type of operation makes use of silicone's excellent compression set characteristics, good chemical resistance, good dielectric properties, and excellent temperature resistance.

SILICONE RUBBER PARTS: The Plastics Department of General Electric Company offers the product designer a specialized fabricating service on silicone rubber parts. Your job is handled by specialists — men who are concerned solely with

the engineering and production of silicone rubber parts to customers' specifications. This service includes the following: application engineering, compound section, manufacturing facilities, tool making facilities.

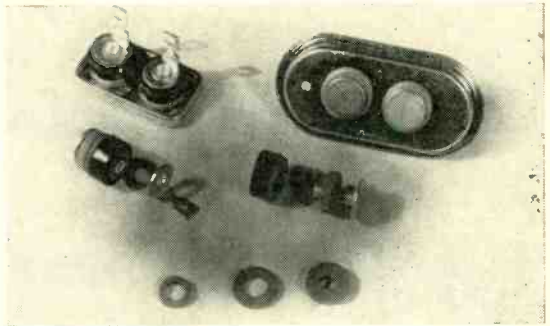

G-E Silicone Rubber washers provide a permanent insulating seal for terminal leads.

FORMS AND GRADES AVAILABLE:

Can be molded, extruded, laminated, or coated, using techniques and equipment not materially different from those encountered in conventional rubber processing. Fabrication of parts from standard forms is generally simple and involves little material waste. Several grades are available for molded or extruded parts as well as adhesives which will attach any silicone rubber to itself, to glass, metal, ceramic, etc., with a tough flexible, heat-resistant bond. Following table gives physical properties of 4 most widely used grades of G-E silicone rubber. Other types are available. Send for technical report CDP-584.

Grade Number	Applications	Hardness Durometer Shore "A" Scale	Specific Gravity	Tensile Strength Lb./sq. in.	Elongation %	Compression Set % 22 Hours at 350 F	Dielectric Strength Volts/Mil at 100° C in Oil		Power Factor 1 MC Dry	Dielectric Constant 1 MC Dry	Volume Resistivity Megohm/CC
							Step by Step	Short Time			
12650	General Purpose Extruded Products, Low Durometer	50±5	1.2	600	240	75±5					
12660	General Purpose Molded Products, Low Durometer	60±5	2.00	450	150	80±5	250	330	.005	7.40	1.5 x 10 ⁵
12670	Molded or Extruded Products, Special Electrical Properties	70±5	1.40	650	110	60±5	510	560	.003	3.10	1.5 x 10 ⁵
12680	Molded or Extruded Products, Special Chemical Resistance	80±5	1.50	500	100	60±5	380	500	.004	3.10	1.5 x 10 ⁵

G-E LAMINATED PLASTICS

There is a correct grade of G-E laminated plastics for almost any set of requirements. More than fifty grades are manufactured and each has an individual combination of properties — electrical, mechanical, chemical and thermal. G-E laminates can be fabricated into the most intricate shapes, and the various grades of G-E laminates lend themselves to many kinds of fabricating operations — punching, machining, sawing, stripping and shearing. These laminates are manufactured by modern methods to insure a rigid quality control; all grades meet or exceed NEMA industry requirements. Write for the Bulletin, "G-E Industrial Laminates."

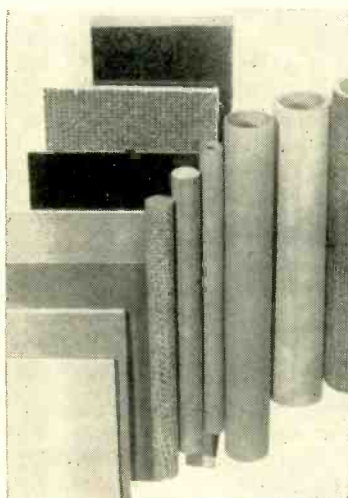

Molded Products: G-E offers a complete custom molding service — design, engineering, mold making and molding. All types of molding processes are utilized — compression, injection transfer, and extrusion. An unbiased recommendation of correct material for your application will be given. Write for "Design Data on Plastics for Product Designers."

Mica: Mica, when properly selected and processed, has exceptionally good electrical properties, high dielectric strength, very low power factor, and stability under varying weather conditions and over a wide range of temperatures. G-E Mica is supplied in a segment plate, molding plate, heater plate, flexible plate, mica tapes, washers, composite insulation, and mica tubing. The insulating value of mica is largely determined by the bonding material and manufacturing process, since its oil, water, and alkali resistance depends on the bonding material used. Send for the bulletin, "Insulating Materials."

G-E GLYPTAL* Alkyd Resin Insulating Finishes: G-E Glyptal Alkyd Resin coating materials are especially noted for their rapid-drying, hard, glossy, durable surfaces that withstand oil spray and splash, and weak acid and saline conditions. They are most widely used in the three following general types: No. 1201 Glyptal Alkyd Resin Red is a red coating material for brushing, dipping or spraying. It has excellent dielectric strength and arc resistance. No. 1201-B is of heavier consistency than No. 1201 and is unexcelled for sealing joints, gasket assemblies, pipe connections, screw plugs, etc., to prevent leakage of oil, gas, water, or air. No. 1202 Glyptal Alkyd Resin is a clear, general purpose varnish with good heat and oil resisting qualities. It is applied by brushing or spraying. No. 7815 Glyptal Alkyd Resin is a black coating material resistant to corrosive conditions of moisture, acid vapors, and alkalis. It can be applied by brushing or spraying. Write for the bulletin, "G-E Insulating Materials."

*Reg. U.S. Pat. Off.

MAGNET WIRE

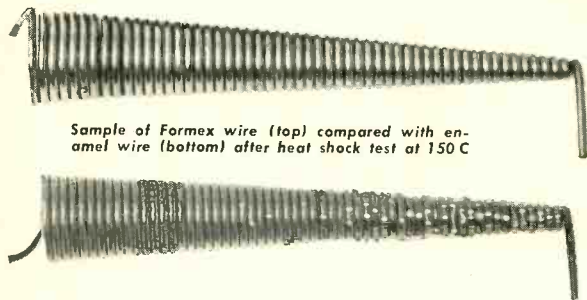

Sample of Formex wire (top) compared with enamel wire (bottom) after heat shock test at 150 C

Formex*: Formex Magnet Wire because of the physical properties of its insulating film maintains its dielectric strength throughout normal service longer than oleo-resinous enameled wires. Its abrasion resistance, flexibility, resistance to heat shock and film adhesion are superior features of Formex and enable it to retain its electrical properties under severe usage and service. Formex wire is outstanding in its resistance to moisture absorption and is highly resistant to commonly used solvents. These and many other special features make Formex magnet wire ideally suited for electronic applications.

FEATURES OF FORMEX MAGNET WIRE:

TAKES LESS SPACE: Because of its construction, the winding-space factor of Formex wire is considerably higher than for other types, thereby making appreciable savings by getting the same amount of energy out of a smaller machine.

EASY TO WIND: Its thin film makes Formex wire easy to bend and its smoothness permits the turns of the coil to fall readily into place.

MORE FEET PER POUND: Because there are more feet of wire in a pound of Formex wire than in a fibrous-insulated type, important savings are effected.

FACILITATES MANUFACTURE: With its tough and abrasion-resistant covering, Formex will stand up under the severe treatment of high-speed winding and assembly operations. Thus, it is possible to accelerate production, reduce factory rejects, and realize over-all lower manufacturing costs.

PROPERTIES OF FORMEX MAGNET WIRE

DIELECTRIC STRENGTH: Formex, because of the physical properties of the insulating film, maintains its dielectric strength during winding, assembly, varnish treatment, and life of the apparatus in which the wire is used.

POWER FACTOR: The power loss in a radio-frequency coil depends in part on the dielectric power loss in the insulation. Reliable tests show the improvement which Formex wire represents over conventional enameled wire in this respect.

TOUGHNESS: Film toughness is the property which enables magnet wire to maintain its electrical properties under the severe treatments incidental to its application to electric machines and operation in service. Formex rates high in the following related properties: Abrasion Resistance, Flexibility, Resistance to Heat Shock, and Adhesion of Film.

HEAT AND SHELF AGING: Comparative heat-aging tests produce less effect on Formex than on other types of magnet wire, Formex wires have been subjected to shelf aging for more than four years with no measurable effect on the film.

TEMPERATURE RATING: The film on Formex wire is organic and, as such, falls under AIEE Standards for Class A insulating materials which have a temperature rating of 105 C.

MOISTURE RESISTANCE: In moisture absorption, there is little difference between the performance of Formex wire and that of conventional enameled wire. In continuity, however, the physical make-up and properties of Formex wire assure continuity after the apparatus is wound and ready for service.

SOLVENT RESISTANCE: Formex wire is resistant to deleterious action from practically all commonly used solvents.

Varnish Treatments: Because Formex wire is highly resistant to the action of varnish solvents and heat shock, Formex wire wound assemblies may be subjected successfully to varnish solvents, to baking temperatures, and to baking cycles which must be avoided or used only with extreme caution on assemblies that are wound with conventional types of enameled wire.

Deltabeston*: Deltabeston Magnet Wire insulated with glass or asbestos is unsurpassed in performance where extreme heat, grease, oil, corrosive vapors, and other severe operating conditions exist. This feature makes Deltabeston extremely valuable in certain communications equipment and gear and in industrial electronic equipment. It has great flexibility, exceptional dielectric strength, heat resistance, abrasion and shock resistance.

Formex Wire Types Available

ROUND FORMEX WIRE: Range of sizes includes all those covered by the NEMA General Standards for Vinyl-acetal-insulated Magnet Wire, comprising 4 Awg (0.204 in.) to .001".

RECTANGULAR AND SQUARE FORMEX WIRE: Rectangular and square Formex also available in a complete range of sizes.

COLORS FORMEX WIRE: To permit a positive, quick identification of circuits, Formex is available with color in the Formex enamel. One solid color (not a tracer) is always provided. Standard colors are green and yellow.

Deltabeston Types Available

Asbestos Insulated... Class B-125 C max.
Glass Insulated... Class B-125 C max.

Both types available for Class H applications by use of silicone adhesives and impregnating compounds.

Round Deltabeston
No. 4/0 Awg to No. 25 Awg

Square Deltabeston
No. 2 Awg to No. 14 Awg

Rectangular Deltabeston
Full range of sizes available

*Registered Trade Mark
of General Electric Company

DATA ON FINE FORMEX WIRE Dimension in inches

Awg	Bare Diam.	Tolerance	Ft/lb Bare	F			HF			Ohms/ Ft	
				Min Ins.	Max Ins.	Ft/lb	Min Ins.	Max Ins.	Ft/lb	Ft Nom	Ft Max
41	.0028	±.0001	42100	.0002	.0032	40800	.0005	.0007	40000	1.32	1.42
42	.0025	±.0001	52900	.0002	.0029	51400	.0004	.0006	50400	1.66	1.800
43	.0022	±.0001	68200	.00015	.0025	66000	.0004	.0006	64500	2.14	2.35
44	.0020	±.0001	82500	.0001	.0023	79600	.0004	.0006	77600	2.59	2.87
	.00175	±.00005	108000	.0001	.00205	104000	.0003	.0005	102000	3.39	3.59
	.00150	±.00005	147000	.0001	.00180	142000	.0003	.0005	138000	4.61	4.93
	.00125	±.00005	211000	.0001	.00145	203000	.0002	.0004	199000	6.64	7.20
	.0010	±.00005	330000	.0001	.00125	319000	.0002	.0004	306000	10.37	11.53

RADIO DIAL LAMPS

designed and engineered for the job

BECAUSE of the vibration conditions under which General Electric radio dial lights must operate, General Electric devotes special care to their design and manufacture. Filaments are designed to vibrate without damage and are secured by a shake-proof joint.

General Electric research is constantly at work to assure the quality and serviceability of G-E radio dial lamps. Shock tests, vibration tests and base torsion tests are used in the laboratory to make certain customers will get good service from General Electric lamps.

Features like these make it worthwhile to use and install G-E lamps:

1. Dependable, trouble-free performance.
2. High level of maintained light output.
3. Low current consumption.
4. Long life.
5. Preferred by both dealers and customers.



T-3/4
Miniature
Bayonet



T-3/4
Miniature
Screw



G-3 1/2
Miniature
Bayonet



G-4 1/2
Miniature
Bayonet

SPECIFICATIONS				
LAMP NUMBER	VOLTS	AMPS	BULB	BASE
40	6-8	0.15	T-3 1/4	Min. Screw
41	2.5	0.50	T-3 1/4	Min. Screw
42	3.2	0.35	T-3 1/4	Min. Screw
43	2.5	0.50	T-3 1/4	Min. Bay.
44	6-8	0.25	T-3 1/4	Min. Bay.
45	3.2	0.35	T-3 1/4	Min. Bay.
46	6-8	0.25	T-3 1/4	Min. Screw
47	6-8	0.15	T-3 1/4	Min. Bay.
48	2	0.06	T-3 1/4	Min. Screw
49	2	0.06	T-3 1/4	Min. Bay.
51	6-8	Max. 0.25	G-3 1/2	Min. Bay.
55	6-8	Max. 0.45	G-4 1/2	Min. Bay.
1490	3.2	0.16	T-3 1/4	Min. Bay.

General Electric makes a complete line of neon glow lamps—including NE-51, NE-2, NE-45, NE-48, NE-16, NE-17—for radio and other electronic applications.

GENERAL ELECTRIC FUSED QUARTZ

Made in standard sizes of ingots, plates, tubing and rods.

Fused quartz has unique electrical properties. High resistivity (approximately 1×10^{19} ohm-Cm³), low dielectric losses (.0009 Dielectric loss factor), and ability to withstand wide and sudden tem-

perature changes make fused quartz a superior material as an electrical insulator. It has less affinity for moisture than any of the other highly refractory materials.

LAMP DEPARTMENT DISTRICT SALES OFFICES

Pittsburgh 19, Pa.	238 W. Carson St.	Detroit 2, Mich.	820 Fisher Building	Oakland 7, Calif.	1614 Campbell Street
New York 22, N. Y.	570 Lexington Avenue	Kansas City, Mo.	200 E. 16th Ave., N. Kas. City 16	Seattle 4, Wash.	202 Hoge Building
Cleveland 14, O.	215 Euclid Avenue	St. Louis 1, Mo.	710 N. Twelfth Blvd.	Denver 2, Colo.	1863 Wazee Street
Charlotte 2, N. C.	514 Johnston Building	Albany 7, N. Y.	8 Elk Street	Memphis 7, Tenn.	1179 Morehead Street
Baltimore 2, Md.	Court Square Bldg.	Boston 10, Mass.	50 High Street	Atlanta 3, Ga.	187 Spring Street, N.W.
Chicago 4, Ill.	230 So. Clark Street	Newark 2, N. J.	Room 606, 744 Broad Street	Los Angeles 13, Cal.	601 West Fifth Street
New Haven 10, Conn.	185 Church Street	Buffalo 2, N. Y.	1 West Genesee Street	Dallas 2, Tex.	1801 N. Lamar Street
Philadelphia 2, Pa.	1405 Locust Street	Minneapolis 13, Minn.	500 Stinson Boulevard	Houston 2, Texas	1811 Nat'l Standard Bldg.
Tampa 2, Florida	505 Twiggs St.	Portland 9, Oregon	1238 N.W. Glisan Street	Richmond 19, Va.	627 E. Main Street
Indianapolis 4, Ind.	1115 Circle Tower	Cincinnati 2, Ohio	36 East Fourth Street	Milwaukee 3, Wisc.	161 W. Wisconsin Ave.
Davenport, Iowa	301 Davenport Bank Bldg.				

General Office: Nela Park, Cleveland 12, Ohio. GLenville 1-6600

G-E TELEVISION COMPONENTS

Deflection Yokes

For use with picture tubes having scanning angles up to and including 70°. Provide efficient uniform deflection. Available with ribbon type laminated core or ferrite core.

ELECTRICAL RATINGS:

Available in horizontal and vertical winding inductances of 15 to 40 mh. Mechanically interchangeable with other leading makes of yokes.

G-E Television Components feature Focus-Deflection Assembly, and Horizontal Output Transformer. The result of many years of research and experimentation, these G-E Television Components play a vitally important part in providing clearly-focused, precise television reproduction.

Width and Linearity Controls

A complete line of width and linearity controls for use with the other General Electric scanning components. Models with pulse windings available. Also may be used with other leading makes of scanning components.

Focus Coils

Combine effects of Alnico 6 permanent magnet and an electromagnet to provide uniform focus with a minimum of circuit power.

This type of focus coil compensates partially for variations in focus caused by line voltage fluctuation.

A complete line of models available to focus all standard picture tubes.

Horizontal Sweep Transformers

Ferrite core high efficiency transformers for all designs of economical, high quality picture tube scanning circuits. When used with General Electric high efficiency yokes, these transformers provide 70° deflection at 15 kv utilizing the new small tubes such as 6Av5, 1x2 or 1B3 and 6W4.

Available complete with 1x2 socket and wiring for compact economical installation.

GENERAL ELECTRIC VARIABLE RELUCTANCE CARTRIDGES with the famous REPLACEABLE BATON STYLI



General Electric Variable Reluctance Cartridges, operating on a magnetic principle, virtually eliminate mechanical noise and provide quality reproduction for the most critical ear. They feature low needle talk and needle scratch, low record wear, minimum distortion, and a retracting stylus which will protect both records and itself in case of accidental dropping.

All diamond and sapphire styli are now built to the "Baton" design, a new G-E achievement affording unusually high fidelity. The double twist feature of the "Baton" Stylus makes possible new heights in compliance while dual damping blocks filter out spurious vibrations.

NEW G-E PLUG-IN HEAD with the famous TRIPLE PLAY CARTRIDGE



Catalog No. UPX-111

Specially adapted to Webster Changers, the UPX-111 features the General Electric Triple Play Cartridge in an attractive plug-in head. The Triple Play Cartridge, RPX-050, is equipped with the famous Baton Stylus. Now you don't have to change heads in order to play different speeds. A simple twist of the handy positioning knob selects the proper stylus for any of the three commercially available record speeds. Constant stylus pressure of 6 to 8 grams for all three types of records and the low mass reduce record wear to a minimum. Retains the unexcelled quality of previous G-E Variable Reluctance Cartridges.



GENERAL ELECTRIC ALNICO 5 LOUDSPEAKERS WITH THE ALUMINUM BASE VOICE COIL

Cat. No.	Speaker Size Inches	Watts Output	Alnico 5 Mag. Wt. Oz.	VC Imp. Ohms.	Response Cycles	Cat. No.	Speaker Size Inches	Watts Output	Alnico 5 Mag. Wt. Oz.	VC Imp. Ohms.	Response Cycles
400D	4	4	1.3	3.2	140-7000	810D	8	12	6.8	3.2	80-10000
402D	4	4	1.0	3.2	140-7000	818D	8	12	6.8	8	80-10000
403D	4	4	.68	3.2	140-7000	1000D*	10	12	6.8	3.2	60-8000
500D*	5	4	1.3	3.2	125-8000	1001D*	10	25	14.5	8	60-9000
503D*	5	4	.68	3.2	125-8000	1003D*	10	25	9.0	8	60-9000
525D	5 1/4	4	1.3	3.2	120-7000	1012D*	10	12	3.16	3.2	60-8000
526D	5 1/4	4	1.0	3.2	120-7000	1018D*	10	12	6.8	8	60-8000
527D	5 1/4	4	.68	3.2	120-7000	1200D*	12	12	6.8	3.2	60-9000
625D	6 1/2	4	1.3	3.2	110-9000	1201D*	12	25	14.5	8	50-13000
626D	6 1/2	4	1.0	3.2	110-9000	1203D*	12	25	9.0	8	50-13000
650D	6 1/2	8	2.98	3.2	100-10000	1212D*	12	12	3.16	3.2	60-9000
703D	6 x 9	8	1.47	3.2	70-13000	1218D*	12	12	6.8	8	60-9000
800D	8	8	2.98	3.2	80-11000						

Special Construction for Drive-in Theatre Application

400C22	4	4	1.3	3.2	180-7000	525C18	5 1/4	4	1.3	3.2	160-7000
--------	---	---	-----	-----	----------	--------	-------	---	-----	-----	----------

Chassis mounting brackets—at no additional cost—with all 4", 5", and 5 1/4" G.E. speakers. *Round speakers.

G-E WELDED GERMANIUM DIODES

WELDED CONTACT

LOW SHUNT CAPACITY

INSULATING CASE

1. WELDED CONTACT provides greater shock resistance, improved electrical stability.
2. LOW SHUNT CAPACITY: .8 MMFD. average for all types.
3. INSULATING CASE simplifies mounting. Mechanically sturdy.
4. SMALL SIZE for "close fits."

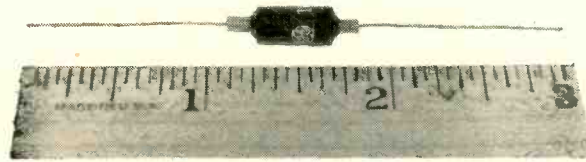

5. LONG LIFE: an estimated minimum average life of 10,000 hours.
6. NO HUM—no heater connections—no heating power.

7. IMPROVED RECTIFICATION CHARACTERISTICS—Has much sharper bend in current/voltage curve than Thermionic Tube.
8. HIGH MOISTURE RESISTANCE.
9. SELF-HEALING under temporary over-voltage conditions.

ELECTRICAL CHARACTERISTICS — (at 25° C.)

DESIGNATION	MAX. INVERSE CURRENT (MA)	MAX. INVERSE CURRENT (MA)	MINIMUM FORWARD CURRENT (MA)	AVERAGE SHUNT CAP.
RMA GE	AT -50V	AT -10V	AT +1V	(MMFD)
GENERAL PURPOSE				
1N48 G5C	.833		4.0	0.8
1N51 G5C	1.667		2.5	0.8
1N52 G5D	.15		4.0	0.8
1N63 G5E	.05		4.0	0.8
1N75 G5M	.05		2.5	0.8
TELEVISION				
1N64 G5F	Min. 100 microamps dc load current in specific 44 MC second detector circuit.			
1N65 G5G	.20		2.5	0.8
UHF				
1N72 G7	Noise figure 14 to 19 db in specific 500 MC converter circuit.			
JAN				
1N69 G5K	.85	.05	5.0	0.8
1N70 G5L	.41	.01	3.0	0.8

MAXIMUM RATINGS

DESIGNATION	PEAK INVERSE VOLTAGE AT 25°C	CONTINUOUS REVERSE WORKING VOLTAGE AT 25°C	AVERAGE RECTIFIED CURRENT (MA) AT 25°C	PEAK RECTIFIED CURRENT (MA) AT 25°C	MAXIMUM SURGE CURRENT (MA) AT 25°C	AMBIENT TEMPERATURE RANGE
RMA GE						
GENERAL PURPOSE						
1N48 G5	85	70	50	150	400	-50 to +75°C
1N51 G5C	50	40	25	100	300	-50 to +75°C
1N52 G5D	85	70	50	150	400	-50 to +75°C
1N63 G5E	125	100	50	150	400	-50 to +75°C
1N75 G5M	125	100	50	150	400	-50 to +75°C
TELEVISION						
1N64 G5F	20					
1N65 G5G	85	70	50	150	400	-50 to +75°C
UHF						
1N72 G7			25	75		-50 to +75°C
JAN						
1N69 G5K	75	60	40	125	400	70°C Max.
1N70 G5L	125	100	30	90	350	70°C Max.

- ALSO:** MATCHED PAIRS of general purpose types — forward currents within 10% of smaller current at + 1 volt
- QUADS — Type 1N73 & 1N74 — Four carefully matched diodes for ring or bridge modulators mounted and hermetically sealed in 6H6 tube shell
- TRANSISTORS — Tested for 13 to 20 db power gain at 5 kc, also for reverse current characteristics suitable for trigger circuits

1951 EDITION . . . 4th PRINTING

Germanium Diode Handbook



New charts, complete specifications on G-E germanium diode products—all in this 100-page loose-leaf leatherette book. Contains diode characteristics and applications, curves on resistance, voltage, temperature, efficiency, circuit diagrams covering AM, FM and TV receivers, radar, carrier current. Supplementary sheets include data on Types 1N69 and 1N70 diodes to JAN-1A specifications . . . reprints of new literature on the application of diodes and design of UHF converters.

This book is worth many times its cost to electronics designers, engineers, and manufacturers. We will send it to you for \$1.25 postpaid. Send check or money order to: General Electric Company, Section 861, Electronics Park, Syracuse, New York.

WELDED CONTACT
For
Stability
—It's the
POINT
That
Counts

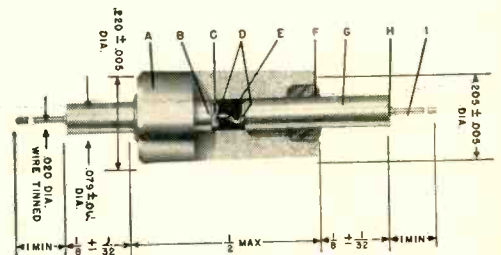

- A. Mineral-filled molded plastic case
- B. Solder
- C. Germanium
- D. Welds
- E. Platinum-Ruthenium Whisker
- F. Thermosetting Cement
- G. Nickel Pin
- H. Weld
- I. Leaded Copper Clad Wire

In a General Electric diode, the use of a platinum whisker permits actual welding of the fine contact point to the germanium. This results in a mechanically secure contact free from shock or vibration variations. Wax filling is not necessary in this type of construction; no impurities can touch the most vital point of a semiconductor diode.

ACCURATE, DEPENDABLE *Telechron* MOTORS

*for automatic timing,
switching, controlling
and recording instruments*

All Telechron Timing Motors are instantly . . . constantly synchronous. They will start full load and reach synchronous speed instantly and remain in synchronism throughout their life. Slippage or "drift" is absolutely impossible within rated load.

INHERENT LONG LIFE

The replaceable, high-speed rotor unit is sealed to keep dust out and lubrication in. The lubricating system keeps all moving parts lubricated for years . . . meters correct amount of oil to the terminal shaft bearing . . . causes the rotor shaft to spin on a film of oil. *No Telechron motor rotor shaft bearing has ever worn out.*

COMPLETE LINE

Telechron motors come in many different types, torque ratings and terminal shaft speeds. All Telechron motors are Underwriters' Laboratories approved.

APPLICATION ENGINEERING SERVICE

Whatever your requirements . . . standard or special . . . you can get complete satisfaction from Telechron, world's largest producer of synchronous electric timing motors. Here, application engineers offer you the benefits of the longest engineering and manufacturing experience in the field. Address Application Engineering Service, Telechron Inc., 60 Union St., Ashland, Massachusetts. A General Electric Affiliate.

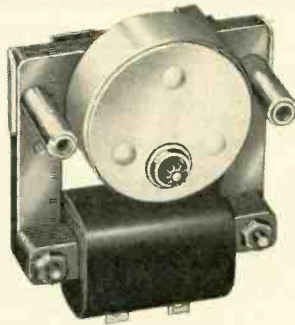

Light-duty motor, type H3
Torque rating .018 pound-inch at 3.6 rpm at 60 cycles 115 volts.

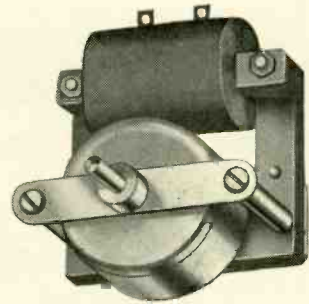

Medium-duty motor, type H7
Torque rating, .375 pound-inch at 1 to 6 rph at 60 cycles 115 volts.

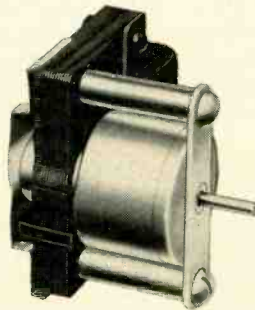

Medium-duty motor, type B
Torque rating of various models from .015 pound-inch at 60 rpm to .375 pound-inch at 1/2 or 1 rpm at 60 cycles 115 volts.

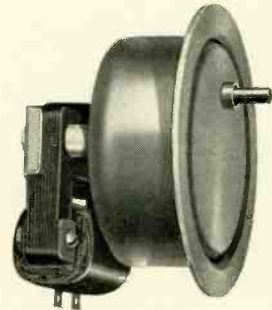

Heavy-duty motors, C types
Torque ratings of various C types range from .25 pound-inch at 4 rpm to 2 pound-inches at 1 rpm at 60 cycles 115 volts.

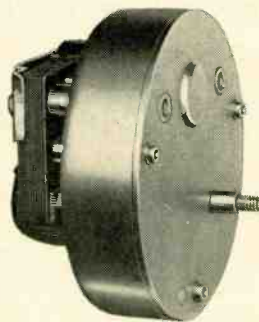

Type IM9 instrument movement
Designed especially for chart drives, but adaptable to most instruments. Terminal shaft speeds from one revolution in 15 minutes to 1 revolution in 30 days. Terminal shaft rotation counter-clockwise.

Telechron

ALL TELECHRON TIMING MOTORS ARE

INSTANTLY...CONSTANTLY SYNCHRONOUS

C-D 5 high-strength plastics

DIAMOND
Vulcanized Fibre

VULCOID
a C-D dielectric material

DILECTO
a laminated
thermosetting plastic

CELORON
a fabric-base
molded plastic

MICABOND
mica in most usable form.

Continental-Diamond

C-D

Engineered Products

Continental - Diamond

F I B R E C O M P A N Y

Established 1895

Manufacturers of Laminated Plastics since 1911

NEWARK 100 • DELAWARE

STANDARD GRADES and SIZES

GRADE	THICKNESS	SIZE	COLORS
Abrasive	.010" to .040" inc.	47" to 52" wide In rolls up to 1,000 lbs. each	Blue, chocolate, natural gray, olive, and combinations
Bobbin	1/8" to 3/8" inc.	45" to 50" wide, approx. 84" long	Black, natural gray, and red
Bone	1/32" to 3/16" inc. Over 3/16" to 1/2"	40" to 46" wide, approx. 80" long 42" to 48" wide, approx. 80" long	Natural gray
Commercial	.004" to .060" inc. Over .060" to 2 1/8" inc.	Rolls approx. 48" wide or Sheets approx. 84" long 46" to 52" wide, approx. 84" long	Natural gray, red and black
Diamond Insulation	.004" to 1/16" inc. .004" to 1/8" inc.	Rolls approx. 48" wide Sheets 47" to 52" wide, approx. 84" long	Natural gray
Flexible	1/32" to 1/4" inc.	48" to 54" wide, approx. 84" long	Natural gray, red and black
Forming	.045" to 3/32" inc.	46" to 52" wide, approx. 84" long	Natural gray, red and black
Pattern	1/32" to 3/64" inc.	48" to 54" wide, approx. 84" long	Red
Rubber Backing	.010"	In rolls approx. 54" wide or Sheets approx. 54" wide, 84" long	Black, tan and white
Shuttle	3/32" to 7/64" inc	Approx. 48" x 84"	Natural, red and black
3 BT	.005" to 1/16" inc.	Approx. 50" x 84" or rolls	High white
Tag	.005" to .020" inc.	Approx. 50" x 84" rolls	High white
Trunk and Case	.015" to 1/8" inc.	47" to 52" wide, approx. 84" long	Russet, black, chocolate, mahogany, olive, walnut, red, light granite and natural gray
Built-up	3/4" to 4"	Approx. 38" to 40" wide, 43" to 46" long	Natural gray, red and black
Diamond Fibre Rods	1/8" to 1" diam. 1" to 2" diam.	5 to 6 ft. long 3 to 6 ft. long	Natural gray, red and black
Diamond Fibre Tubes	1/32" to 1/4" inc. wall to 1/2" by telescoping	1/8" to 4 3/8" I. D. 22" to 36" long (3/8" to 2" I. D. by 60" length) on special order	Natural gray, red and black

C O N T I N E N T A L - D I A M O N D F I B R E C O .

o f D I A M O N D V U L C A N I Z E D F I B R E

DESCRIPTION AND APPLICATION

A medium density fibre possessing high tensile strength ratio, high tearing strength combined with flexibility, and a good penetrating characteristic for glues used in abrasive coating, primarily for abrasive discs.

A dense, hard, high impact product possessing excellent machining properties. Used widely for bobbin spool heads and similar applications.

A high density, hard material possessing high mechanical strength, resistance to wear and Compressibility. Clutch discs, gears, track insulation, slot sticks, rubbing blocks, and numerous other uses are ideal for this versatile material.

A medium density material possessing good mechanical properties and high dielectric strength under dry conditions along with excellent punching and machining characteristics. This grade of fibre is for general use.

A low to medium density material as required possessing best mechanical properties, excellent bendability, forming and punching qualities. This grade finds wide usage as slot cell insulation, coil insulation, etc. Known widely as "Fish Paper" in the lesser thicknesses.

A medium density, flexible (glycerine or glycol plasticized) fibre produced in various degrees of flexibility as required. Used for washers—all types, last tops, and other parts requiring a softened flexible type of product.

A medium density, lightly calendered to uncalendered fibre possessing good mechanical and electrical properties in line with "commercial grade", but having outstanding forming quality, and high impact. Used widely for forming welders' helmets, athletic guards, and many similar applications.

A low density, smooth but very lightly calendered material tending to remain relatively flat. Used widely for patterns.

A low density, porous, uncalendered fibre possessing good flexibility and resistance to tear. Particularly suited to laminating to rubber for heel backing, etc.

A medium density, high ply adhesion product possessing high mechanical properties and good abrasion resistance. Particularly suitable for surfacing of wood shuttles, and similar parts.

A medium density, high brightness, clean grade possessing a nice balance of mechanical properties and limited forming. Used primarily where a clean, white appearance is required such as for spoons, forks, instrument parts, and for similar sanitary requirements.

A medium density, high white, exceptionally smooth, clean fibre especially treated for printing and non-feathering when written on with pen and ink. Application is for tags of all kinds.

A medium density, tough, high mechanical strength product possessing good bending, punching, and piercing qualities. Possesses a surface finish particularly adaptable to varnishing and lacquering. Obtainable in smooth as well as embossed grain finishes. Used exclusively for trunks, suitcases, laundry cases, box and truck sidings, etc.

A laminated fibre consisting of a build-up of the required number of sheets of thinner fibre well bonded under heat and pressure. Various grades of fibre as required may be used in the build-up. The resulting product is dense, tough and possesses good mechanical and electrical properties. It has less tendency to warp than regular fibre of the equivalent overall thickness and shows better dimensional stability than regular fibre. Its applications are much the same as those of heavy fibre although care must be exercised in selecting the applications.

Rods are lathe turned from sheet stock bars. Since the plies of rod stock are parallel, machined surfaces on edges cannot be expected to be uniformly smooth as is the case with parts made from tubing. Principally used for screw machine specialties, insulating handles or spacers.

A high density product of excellent strength and uniform machining qualities. Used as electrical lead cord plug insulators, fuse tube housings and liners, bushings, grommets, and in production of innumerable screw machine fabricated specialties.

C O N T I N E N T A L - D I A M O N D F I B R E C O .

SPECIFIC PROPERTIES OF DIAMOND VULCANIZED FIBRE

SPECIFIC GRAVITY Density

Thickness in Inches	Commercial	Bone
Under .010	.90	-
.010 to 3/32 incl.	1.15	} 1/32" to 1/2" Minimum 1.30
Over 3/32 to 3/8 incl.	1.20	
Over 3/8 to 1 incl.	1.10	
Over 1 to 1 1/4 incl.	1.05	
Over 1 1/4	1.01	

NEMA minimum Adopted Standard 1-7-1943

MOISTURE ABSORPTION % Change in Weight

Thickness in Inches	Bone		Commercial	
	2 hr.	24 hr.	2 hr.	24 hr.
1/32 to 1/8	50	60	55	65
Over 1/8 to 3/8	20	50	25	60
Over 3/8 to 1	10	25	15	35
Over 1	5	15	8	20

NEMA maximum Adopted Standard 1-7-1943

TENSILE STRENGTH Pounds Per Sq. In.

Thickness in Ins.	Bone		Commercial	
	Crosswise	Lengthwise	Crosswise	Lengthwise
Up to 1/8 incl.	6500	8500	6000	8000
1/8 to 1/2	6000	8000	5500	7500
Over 1/2			5000	7000

NEMA minimum Adopted Standard 1-7-1943

COMPRESSIVE STRENGTH

Pounds Per Sq. In.

	Bone	Commercial
All thicknesses	30,000	20,000

NEMA minimum Adopted Standard 1-7-1943

IMPACT STRENGTH

Izod Method (Lbs. per 1" width at notch)

		Commercial	Bone
		Flatwise } Machine Direction	5.5 to 8.0
	Cross Direction	3.5 to 6.5	3.0 to 4.0
Edgewise } Machine Direction		1.5 to 3.0	1.0 to 2.0
	Cross Direction	1.0 to 2.5	.8 to 1.5

Specimens from sheets 3/4", 1", 1 1/4" thick preconditioned 48 hrs. at 50° C.

COEFFICIENT OF FRICTION

(Static and Dynamic)

	Fibre Dry	
Brass		.19—.21
Cast Iron	" "	.12—.16
Copper	" "	.19—.21
Steel	" "	.13—.21

FLEXURAL STRENGTH Pounds Per Sq. In.

Load Applied On	Commercial Grade	
	Crosswise Face or Edge	Lengthwise Face or Edge
1/2" thick and over	11,000	13,000

NEMA minimum Adopted Standard 10-29-1943

DIELECTRIC STRENGTH Volts Per Mil.

Thickness in Inches	Commercial	Diamond Insulation
.004 to .005 incl.	175	200
Over .005 to .015 incl.	175	300
Over .015 to .040 incl.	175	250
Over .040 to 1/16 incl.	175	175
Over 1/16 to 1/8 incl.	150	175
Over 1/8 to 3/8 incl.	100	...
Over 3/8 to 1/2 incl.	50	...
Over 1/2, total at least	25,000 volts	

NEMA minimum Adopted Standard 1-7-1943

SHRINKAGE in air of normally dried fibre (4-6% moisture) when dried for 24 hours at 100-105° C.:

In	Commercial and Bone Grades
Thickness	1.0-4.5%
Length	0.8-2.5%
Width	1.0-3.5%

NOTE: Fibre shrinkage can be reduced to lower limits by redrying fibre prior to test so that its moisture content is reduced to 2-3%.

HEAT RESISTANCE :

	Commercial and Bone Grades
Suggested Maximum Working Temperature	225° F.
Blistering Temperature	460° F.
Charring Temperature	650° F.

CHEMICAL PROPERTIES :

Moisture Content	4 to 8%	
Ash	7% max.	
	Other colors	3% max.
Zinc Chloride Content	.2% max.	

HARDNESS :

Bone grade—Rockwell (minimum) R-80 Mechanical and Electrical grade—Rockwell (minimum) R-50

NEMA Adopted Standard 6-9-1947

ARC RESISTANCE :

Vulcanized fibre possesses excellent arc extinguishing and non-tracking characteristics which render it particularly suitable for high and low voltage fuses of all types, lightning arrestors, arc chutes for circuit breakers, and other applications requiring superior arc resistance. Representative values for fibre are 110 to 150 seconds.

VULCOID a C-D electrical insulating material

SHEETS . . . TUBES . . . RODS . . . PARTS

VULCOID should be classified as intermediate between vulcanized fibre and laminated phenolic plastics. It is approved by the Underwriter's Laboratories for insulation of current-carrying parts in electrical equipment. Has excellent machining properties.

VULCOID is supplied in its natural color—a brownish gray. Made in standard size sheets, tubes and rods.

properties

The numerical values for some of the properties of VULCOID decrease as the thickness increases. For a given thickness there is a variation in all properties due to normal variation in manufacturing conditions and in the properties of the ingredients.

Vulcoid applications . . .

- Arc Deflector Spacer Bushings — arc resistance — mechanical strength.
- Motor Lead Bushings — moisture and arc resistance.
- Circuit Breaker Barriers — arc quenching.
- Transformer Barriers — dielectric strength, rigidity.
- Transformer Lead Bushings — moisture and arc resistance.
- Knife Switch Guides — arc resistance; mechanical strength.
- Transformer Coil Separators — dielectric strength; non-compressibility.
- Trolley Wire Insulators — mechanical strength; moisture and arc resistance, weathering.
- Instrument Panels — strength; rigidity; arc resistance.
- Contact Panels — arc resistance; mechanical strength.
- Switch Yokes (low voltage) — dielectric strength.
- Wiring Devices — attachment plugs, base board receptacles — dielectric strength, moisture resistance.
- Electrical Fixture Insulation — dielectric strength, moisture resistance.

VULCOID PROPERTIES

COMPARATIVE PROPERTIES

Property	Normal Deviation	1/32"	1/16"	3/32"	1/8"	3/16"	1/4"	5/16"	3/8"	7/16"	1"	Commercial Grade Vulcanized Fibre 1/16"	Paper Base (xx) Laminated Phenolic 1/16"
Arc Resistance in seconds	± 25	110	110	110	110	110	110	110	110	110	110	140	4
Specific Gravity	± 10	1.35	1.35	1.35	1.35	1.30	1.30	1.20	1.20	1.15	1.10	1.25	1.35
Moisture Absorption (% wt. gain in 24 hours)	± 25	35	30	15	6	5	4	4	4	4	4	60	.9
Tensile Strength MD } (Thousands of psi) CD }	± 25	{ 13 8	{ 12.5 7.5	{ 12 7.5	{ 11 7	{ 10 7	{ 9 6.5	{ 8.5 6.5	{ 8.5 6	{ 8 6	{ 8 5.5	11	{ 12 10
Flexural Strength . . . MD } (Thousands of psi) CD }	± 25	{ 25 20	{ 24 19	{ 23 17	{ 20 16	{ 17 13	{ 16 13	{ 15 13	{ 14 11	{ 13 10	{ 12 9	16	{ 19 17
Shearing Strength . . . MD } (Thousands of psi) CD }	± 20	{ 14 12	{ 14 12	{ 12.5 11	{ 12 10								
Compressive Strength (Thousands of psi)	± 20	36			36							25	34
Izod Impact Strength MD (Edgewise) Ft. lbs./in. of notch	± 20						1.0					2.00*	0.50*
Dielectric Strength (Volts per Mil.)	± 20	575	475	425	275	200	170	150	100	90	60	175	700

NOTE: ASTM test methods used for Specific Gravity, Moisture Absorption, Arc Resistance, Tensile, Flexural, Compressive and Dielectric Strength.

*This test value based on 3/8" thickness.

Standard Sizes	Sheets	Rods	Tubes
Approx. Size or Length	38" x 43" & 40" x 45"	Random Lengths about 36"	Random Lengths 22" to 36" I. D. 3/16" to 4 3/8" inc.
Thickness	1/32" to 3/8" to 1" inc.	3/32" to 3/8" inc.	1/16" to 5/16" wall with diameter limitations as follows: 3/32" wall over 3/4" I. D. 3/16" wall over 3/4" I. D. 1/8" wall over 3/8" I. D. 7/32" wall over 1" I. D. 5/32" wall over 7/16" I. D. 9/32" wall over 2" I. D.

COLOR—The natural greenish-tan resulting from the standard production process. Surface containing occasional red and blue threads as characteristic Underwriter's Laboratories identification markings in thicknesses from 1/32" to 1/2" inc.

C O N T I N E N T A L - D I A M O N D F I B R E C O .

DILECTO

DILECTO is made by impregnating paper, cotton or asbestos fabric, fiberglass, felted asbestos, nylon, or other base material with synthetic resin, then pressing these laminations together under heat and pressure. Standard finished forms are sheets, rods and tubes, all of which are readily fabricated. There is also a grade of DILECTO sheet which may, after pressing, be formed to permanent shape. This type of sheet is known as "POST FORMING" Dilecto and is made in grade CF, XF, and MEC-1F.

fabricated
Dilecto
parts

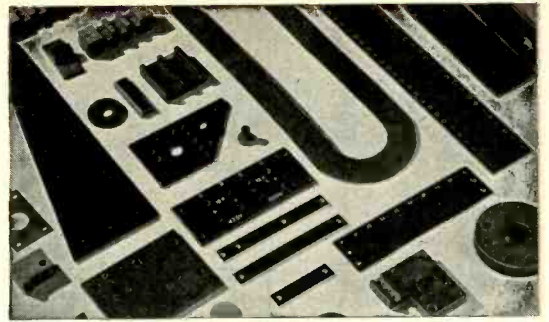

ELECTRICAL AND MECHANICAL PROPERTIES OF DILECTO SHEET GRADES, APPROXIMATE AVERAGE VALUES

NEMA Grade	Continental-Diamond Grade (sheets) DILECTO	Lbs./cu. in.	Specific Gravity	Water Absorptions % 24 hrs.	Rockwell Hardness "M"	Tensile Strength Thousands of psi				Flexural Strength Thousands of psi		Compression Strength, thousands psi (Flg.)	Bonding Strength, lbs. (1)	(1) Impact Strength (Izod) Notched in ft. lbs. per 1" of Notch				Dielectric Strength in Volts per Mil		(2) Power Factor 10 ⁶ cycles /seconds		Dielectric Constant 10 ⁶ cycles /seconds		Loss Factor 10 ⁶ cycles /seconds				
						LW	CW	LW	CW	LW	CW			LW	CW	LW	CW	Short Time	Step by Step	As Recd.	Wet	As Recd.	Wet	As Recd.	Wet			
																										Flatwise		Edgewise
						LW	CW	LW	CW																			
X	X-13	.0497	1.38	2.0	110	15	12	30	22	42	1100																	
P	XP-13	.0497	1.38	1.5	100	11	10	20	16	26	900																	
	XP-90	.0476	1.31	2.5	45	9.7	7.2	12	10	19																		
XXP	XXP-13	.0497	1.38	0.9	110	10	8	17	14	27	1000																	
XXXP	XXXP-13	.0497	1.38	0.5	110	9	7.5	16	13	27	1100																	
	XXXP-22	.0466	1.29	0.3	115	12	10.5	13.5	12	27.5																		
XXS	XXS	.0497	1.38	1.5	100	12	10	19	17	34	950	1.1	1.0	0.50	0.45	700	500	0.038	0.042	5.2	5.4	0.20	0.23					
	XX-13	.0497	1.38	0.9	110	12	10	19	17	34	950	1.1	1.0	0.50	0.45	700	500	0.038	0.039	5.2	5.3	0.20	0.21					
XXX	XXX-13	.0497	1.38	0.7	115	11	10	19	16	36	1200	0.9	0.85	0.45	0.40	650	470	0.034	0.035	4.8	4.9	0.16	0.17					
	XXARC	.0497	1.38	3.0	100																							
XXHV	XXHV	.0497	1.38	1.3	110	10	8	17	15	27	950					600	450	0.033	0.039	4.7	4.8	0.16	0.19					
	CBW	.0497	1.38	1.9	100	12	10	19	18																			
A	A-13	.0614	1.70	0.8	100	10	7	18	16	38	900	1.9	1.8	0.9	0.8	200	120	0.115		5.2		0.60						
AA	AA-13	.0560	1.55	0.7	110	10	6.5	19	15	40	1800	5.0	4.1	4.5	4.0	75	45	0.44		6.8		2.99						
	MAA	.0639	1.77	5.3	108	7.4	6.5	13	12	45	1300	6.0		4.0		35	27	0.57		13.4		7.7						
FA-72	FA-72	.0578	1.60	0.7	115	21	17	38	27	48	1400	5.0	4.0	2.5	2.0	70	50											
	MA	.0650	1.80	1.2	115	10	6	17	13	40	900	1.3	1.1	0.85	0.75	150	80	0.11		8.2		0.90						
CF	CF	.0497	1.38	0.8	100	11.5	9.5	22	22	38.5																		
C	C-813*	.0497	1.38	1.0	110	11	9	21	19	40	2000	3.6	3.5	2.4	2.1	200	120	0.065		6.0		0.36						
	MC	.0524	1.45	3.0	107	9.5	7.9	17	16.6	39					300	200	0.07	0.17	8.4	15.5	0.59	2.70						
	CV	.0497	1.38	0.8	115	9	8	20	18	40	2200	2.4	2.3	1.5	1.4													
CE	CE-800	.0497	1.38	0.8	115	9	8	20	18	38	2200	2.4	2.3	1.5	1.4	380	265	0.050	0.058	5.2	5.6	0.26	0.33					
L	L-400*	.0497	1.38	0.9	110	12	9.5	23	18	39	1900	3.3	3.0	1.4	1.3	200	120	0.065	0.072	6.0	6.3	0.39	0.45					
	ML	.0524	1.45	2.0	110	13.5	9.1	22	15	39					325	230	0.07	0.20	8.4	8.95	0.59	1.79						
LE	LE-13	.0497	1.38	0.7	115	10	8	21	17	40	2000	2.5	2.0	1.5	1.1	450	290	0.045	0.050	4.8	5.2	0.22	0.26					
	LDC	.0497	1.38	0.6	115	9	7.5	20	16	40	2000	2.5	2.0	1.5	1.1													
GB-112-M†	GB-112-M†	.061	1.69	3.0	114	22	20			45					600	400	0.018		7.0		0.126							
	GB-112-D†	.060	1.65	2.5	110	33	30			38					900	700	0.018		5.0		0.090							
G5	GB-128-M	.0686	1.90	2.2	110	25	22	40	38	50	1700	17.5	16.5	14.0	13.0	500	330	0.013		7.2		0.094						
G3	GB-128-D	.0578	1.60	0.6	95	24	15	21	19	44	1500	10.0	7.0	8.0	7.0	600	390	0.025	0.04	4.9	5.3	0.13	0.21					
G1 & G2	GB-261-D	.0542	1.50	0.6	105	15	11	22	19	39	1200	9.0	5.5	8.0	5.0	425	360	0.011	0.02	4.2	4.3	0.046	0.086					
	Diamond Dilecto	.0506	1.40	11.0	90	15	9	24	20	38	1000	7.0	5.5	1.5	1.4	600	390	0.055	0.080	6.0	6.5	0.33	0.52					
N1	MEC-5	.0423	1.17	0.2	100	6.7	5.7	11	9.5	48	850	5.5	4.0	3.0	2.0	370	340	0.016		4.43		0.071						
G7	GB-112-S	.0614	1.70	.15		19		27		31	960			7.2	5.5	325	300	0.002	0.013	3.9	4.6	0.008	0.060					
	GB-128-S	.0614	1.70	.15		18		23		46	800			12	10	250		0.002		3.9		0.008						
G6	GB-261-S	.0614	1.70	.20		22		24			990			9.5	8.0	150		0.002		3.9		0.008						

NOTES: All tests, except "blistering temperature," were conducted in accordance with American Society for Testing Materials Methods for Sheet Electrical Insulation.

*These Grades approximate the physical properties of Celoron.

†These grades are made principally in the thicknesses from .010" to .025". The data shown is for .025" thick sheet.

(1) Flatwise impact test and bonding strength values are based on 1/2"

thick material. All other tests are based on 1/8" thick material except the values for grade XXARC, which are based on 1/32" thickness.

(2) Wet power factor, dielectric constant, and loss factor values are based on samples which had been immersed in fresh water for 24 hours at 25° ± 2° C.

(3) Insulation Resistance values were determined on samples conditioned for 96 hours at 90% ± 2% relative humidity at 35° ± 1° C.

post
formed
shapes

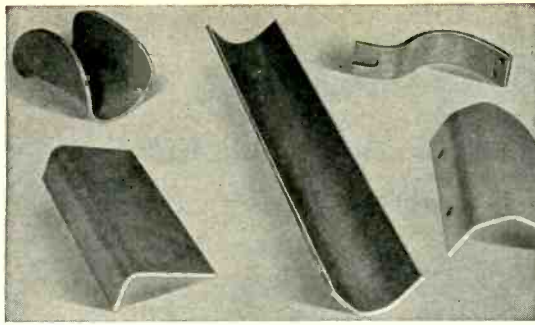

sheets
rods
tubes

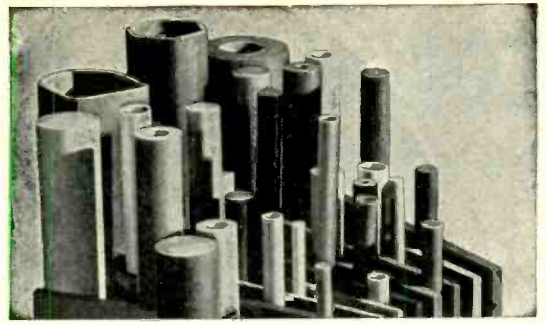

STANDARD SIZES OF DILECTO SHEETS . . . TUBES . . . RODS

Blistering Temp. °C.	Blistering Temp. °F.	Arc Resistance in Seconds	Insulation Resistance, Megohms (3)	Deformation under Load in %	Colors (4) and Finish (5)	TUBES										MOLDED RODS Lengths Approx. 38" to 46"	Continental-Diamond Grade (sheets) DILECTO
						SHEETS		MOLDED Lengths Approx. 18" to 144" (8)			ROLLED Lengths Approx. 18" to 96"			Diameter in Inches Inclusive			
						Thickness in Inches Inclusive	Approximate Size in Inches	Min. (7) Wall Thickness, Inches	I. D. in Inches Inclusive	O. D. in Inches Inclusive	Min. (7) Wall Thickness, Inches	I. D. in Inches Inclusive	O. D. in Inches Inclusive				
220	428	10	90		Black, Natural, Nat. core with Black surfaces	.010-2	36 x 42 38 x 38	1/16	1/8-9	1/4-9-1/2	1/32 (6)	1/8-48	3/16-50	not made	X-13		
240	464	10	100		Black, Natural, Nat. core with Choc. surfaces	.010-1/4	38 x 43 38 x 96	not made			not made			not made	XP-13		
240	464	7	35		Natural	.010-1/4	46 x 70	not made			not made			not made	XP-90		
220	428		500		Blk., Nat. Choc., Nat. core with Brown surfaces	1/64-1/4	except thicknesses under 1/32" made only in 38 x 38 and 38 x 43 sizes	not made			not made			not made	XXP-13		
220	428	4	2000		Black, Natural	1/64-1/4	1/32" made only in 38 x 38 and 38 x 43 sizes	not made			not made			not made	XXXXP-13		
240	464	9	9400		Natural	1/64-1/4	38 x 38	not made			not made			not made	XXXXP-22		
250	482	4			Black only	1/32-2	38 x 43	not made			not made			not made	XXS		
250	482	4	500	0.77	Black, Natural	.010-2	XXARC-38 x 38 and 38 x 43 only	1/16	1/8-9	1/4-9-1/2	1/32 (6)	1/8-48	3/16-50	1/8-2 (9)	XX-13		
240	464	4	800	0.65		1/64-2		1/16	1/8-9	1/4-9-1/2	1/32 (6)	1/8-48	3/16-50	1/8-2 (9)	XXX-13		
		10	159		Olive Green	1/64-1/4		not made			not made			not made	XXARC		
		10	100		Black, Natural	1/64-2		not made			not made			not made	XXHV		
					White core, Bll. surfaces; alternating Blk. and White layer or Blk. surfaces	1/32-1/4	38 x 38	not made			not made			not made	CBW		
220	428	4			Natural	.025-2	38 x 38 and 38 x 43 except Grade A	1/16	3/16-9	5/16-9-1/2	1/16	3/16-48	5/16-50	1/4-2 (10)	A-13		
270+	518+	4				1/16-2	36 x 38	1/8	3/8-9	5/8-9-1/2	1/8	1-48	1-1/4-50	1/2-2	AA-13		
300+	572+	75	.25	.90	Gray	1/16-2	36 x 38	1/8	3/8-9	5/8-9-1/2	1/8	1-48	1/4-50	1/2-2	MAA		
		4			Natural	.025-2	36 x 43	1/16	3/16-9	5/16-9-1/2	1/16	3/16-48	5/16-50	1/4-2 (9)	FA-72		
230	446	80	5		Gray	.025-2	36 x 36	1/16	3/16-9	5/16-9-1/2	1/16	3/16-48	5/16-48	1/4-2 (9) (10)	MA		
200	392	4	10	1.3		1/32-3/8	38 x 38 38 x 43 39 x 46 39 x 70 46 x 70	not made			not made			not made	CF		
					Natural												
230	446	4	25	1.3		.025-10	38 x 38 38 x 43 39 x 46 39 x 70	1/16	1/4-9	3/8-9-1/2	1/16	3/8-48	1/2-50	1/4-4	C-813*		
215	419	80	1.4	1.7	Gray	.025-2	38 x 43	1/16	1/4-9	3/8-9-1/2	1/16	3/8-48	1/2-50	1/4-4	MC		
240	464	4				1/32-2	36 x 42 38 x 38	not made			not made			not made	CV		
240	464	4	100	0.90	Black, Natural, except CV-Natural only	1/32-2	38 x 43 38 x 96	1/16	1/4-9	3/8-9-1/2	1/16	3/8-48	1/2-50	1/4-4	CE-800		
220	428	4	25	1.3		.010-2	38 x 96 39 x 46	1/32	1/8-9	3/16-9-1/2	1/32	3/16-48	1/4-50	3/16-4	L-400*		
		95	9.7	1.4	Gray	.015-2									ML		
	446	4	100		Black, Natural	.015-2	38 x 38 38 x 43	1/32	1/8-9	3/16-9-1/2	1/32	3/16-48	1/4-50	3/16-4	LE-13		
230	446	4			Natural	.015-2		1/32	1/8-9	3/16-9-1/2				3/16-4	LDC		
270+		185	50	0.90	Brown	.010-.025	38 x 38 38 x 43								GB-112-M†		
270+		4	20	0.50	Natural	.010-.025	38 x 38 38 x 43								GB-112-D†		
270+	518+	185	50		Brown	.015-2		1/16	1/4-9	3/8-9-1/2	1/16	1/2-48	5/8-50	1/2-2 (10)	GB-128-M		
270+	518+	4	25	0.30		.025-2	38 x 38 and 38 x 43	1/16	1/4-9	3/8-9-1/2	1/16	3/8-9	1/2-11	1/4-2	GB-128-D		
270+	518+	4	500	0.58	Natural	1/32-2		1/8	3/8-9	5/8-9-1/2	not made			1/2-2 (10)	GB-261-D		
250+	482+	100	10		Gray	1/32-2	39 x 46	1/16	1/2-9	5/8-9-1/2	1/16	1-48	1-1/8-50	not made	Diamond Dilecto		
		7	10000	1.13	Natural	.010-1	38 x 38 38 x 43	1/32	1/8-4	3/16-5	not made			3/16-2	MEC-5		
300+	572+	275	3000	0.14	Natural	.010-1/2	36 x 36 36 x 42								GB-112-S		
300+	572+	275	800	0.25	Natural (Sanded)	1/32-1/2	36 x 36 36 x 42								GB-128-S		
300+	572+	275	5.7	0.27	Natural	1/16-1/2	36 x 36 36 x 42								GB-261-S		

(4) Natural Color varies from golden yellow to dark brown.

(5) Standard finishes are dull, semi-gloss or polished.

(6) The above specifications cover standard sizes regularly in production. Where your design requirements dictate, and our production facilities permit, other sizes can usually be made on special order.

(7) Maximum wall thickness is determined by inside diameter. Correspondence is invited on sizes where wall thickness is abnormally great.

(8) Lengths over 40 inches are available in a limited range of sizes.

(9) Diameters of 1" and over may have annular cracks.

(10) 36" lengths.

CELORON

a fabric-base molded phenolic plastic

Celoron Gear stock is furnished in standard sheets, cut pieces, blanks and rings, and such other shapes as may be cut from the standard sheet stock as well as various special molded blanks and parts. Properties of this stock are indicated by the * in the Dilecto table.

Celoron molded plastic products are made from phenolic resin impregnated fabric. C-D has developed a technique for molding shapes from this material which makes available to designers and engineers parts molded to close dimensions and requiring a minimum of machining.

An unusual combination of mechanical, electrical and chemical properties is provided in Celoron molded plastic parts. Celoron is for most practical purposes chemically inert, insoluble and infusible. It is little affected by moderate concentrations of acids. It is practically unaffected by water and is insoluble in ordinary solvents such as alcohol, benzene, turpentine.

Celoron has good electrical insulating properties. It is practically unaffected by rapid temperature changes. It may be used continuously at temperatures as high as 250° F. and intermittently at temperatures as high as 350° F.

In Celoron, designers find a combination of light weight (about half that of aluminum) and great strength that accounts for many of the uses made of Celoron parts to improve product performance or lengthen useful life.

Celoron molded plastic parts are made in two colors; black and natural. Natural is a golden brown—usually with a mottled effect.

Celoron molded parts are usually furnished in fabric base materials, although it is possible to supply paper base stock in molded forms as well as a limited number of other grades of material. These molded parts, depending upon the size and specific applications, may be supplied in all laminated construction, all macerated construction, or a combination of laminated and macerated construction.

approximate average properties of Molded CELORON

Specific Gravity	1.35
Tensile Strength	6,500 psi
Flexural Strength	10,000 psi
Compression Strength	25,000 psi
Shearing Strength	8,500 psi
Impact Strength (Izod) (per inch of notch)	2.3 Ft. Lbs.
Brinell Hardness— 500 kg. load (10 mm diameter ball—30 seconds)	38
Rockwell Hardness	M-95
Water Absorption— 24 hrs.	1.25%
Coefficient of Linear Expansion	2.5×10^{-5} C.
Dielectric Strength— Short Time	200 V.P.M.

MICABOND

mica in its most usable form

SHEETS • TUBES • TAPES • RINGS • PARTS

MICABOND is a bonded mica product which makes available the highly desirable properties of natural Mica in the forms of sheets, tubes, rings, segments and specially designed parts.

Micabond Tapes—Used extensively for insulating armature coils, turbogenerator coils and all applications where a thin flexible insulation, having high electrical insulating properties and heat resistance, is required.

The special insulating binders used, together with the thin films of mica, provide uniform quality and pliable tapes which assure maximum protection against heat and electricity.

Grades of Micabond—Made in many grades to meet specific electrical insulating, heat resistance and moisture resistance problems. Micabond is also available in combination with insulating papers and cloths, cellophane, fish paper, etc. Write for the complete data bulletin M-51.

uses of MICABOND

Practically the entire output of the world's production of sheet mica is, today, used in the electrical industry. Most types of electrical apparatus or equipment employ Mica insulation in some shape or form. Among the more important types of MICABOND insulation for electrical purposes are:

1. MICABOND segments used for separating and insulating copper commutator bars; MICABOND rings and bushings for insulating other commutator members.
2. For insulators in electrical heating apparatus such as cookers, irons, toasters, etc.
3. Insulating discs, washers, bushings, bands and the many varied shapes used in all types of electric power and lighting equipment.
4. Tubes for induction coils, commutator sleeves, rheostat rods and other general high potential insulating applications.
5. Separator plates in electrical condensers and transformers of practically every type.
6. Armature slot insulation, solenoid insulation and many forms of winding wrappers such as transformer coil insulation.

C O N T I N E N T A L - D I A M O N D F I B R E C O .
NEWARK 100, DELAWARE



OFFERS

COMPLETE COVERAGE in electronic test instrumentation

Choose the exact electronic test equipment you need from the -hp- line — the world's most complete line of over 200 test instruments. Enjoy the engineering economies of fast, accurate measurements, sturdy dependability, broad application. Enjoy, too, the "family characteristics" of -hp- instruments—simple operation, minimum adjustment, independence of line voltage and tube changes, generous overload protection, trouble-free performance.

These pages give brief details of major -hp- instruments. For specific data or catalogs, write to factory on your letterhead or see your local -hp- representative.

hp Oscillators — Generators — .01 to 10,000,000 cps

-hp- 200 SERIES AUDIO OSCILLATORS



Six standard models. 200A, 200B have transformer-coupled output, deliver 1 watt into matched load. 200C, 200D and 202D (for sub-audio, audio, super-

sonic and carrier measurements) have resistance-coupled output, supply constant voltages over their entire frequency ranges. 200I, spread-scale oscillator for interpolation or where frequency must be known precisely.

-hp- 650A TEST OSCILLATOR



Highly stable, wide band (10 cps to 10mc) multi-purpose test oscillator for audio, super-sonic, video and rf measurements. Output flat within 1 db.

Range 0.00003 to 3 v. Output impedance 600 ohms or 6 ohms with voltage divider. \$475.00

Instrument	Primary Uses	Frequency Range	Output	Price
-hp- 200A	Audio tests	35 cps to 35 kc	1 watt/22.5v	\$120.00
-hp- 200B	Audio tests	20 cps to 20 kc	1 watt/22.5v	\$120.00
-hp- 200C	Audio and supersonic tests	20 cps to 200 kc	100 mw/10v	\$150.00
hp- 200D	Audio and supersonic tests	7 cps to 70 kc	100 mw/10v	\$175.00
-hp- 200H	Carrier current, telephone tests	60 cps to 600 kc	10 mw/1v	\$350.00
-hp- 200I	Interpolation and frequency measurements	6 cps to 6 kc	100 mw/10v	\$225.00
-hp- 201B	High quality audio tests	20 cps to 20 kc	3w/42.5v	\$250.00
-hp- 202A	Low frequency measurements	.01 cps to 1 kc.	20 mw/10v	\$450.00
-hp- 202B	Low frequency measurements	1/2 cps to 50 kc	100 mw/10v	\$350.00
-hp- 202D	Low frequency measurements	2 cps to 70 kc	100 mw/10v	\$275.00
-hp- 204A	Portable, battery operated	2 cps to 20 kc	2.5 mw/5v	\$175.00
-hp- 205A	High power audio tests	20 cps to 20 kc	5 watts	\$390.00
-hp- 205AG	High power tests, gain measurements	20 cps to 20 kc	5 watts	\$425.00
-hp- 205AH	High power supersonic tests	1 kc to 100 kc	5 watts	\$550.00
-hp- 206A	High quality high accuracy audio tests	20 cps to 20 kc	+15 dbm	\$550.00
-hp- 650A	Wide range video tests	10 cps to 10 mc	15 mw/3v	\$475.00

hp Vacuum Tube Voltmeters — 2 to 700,000,000 cps

-hp- 410B VACUUM TUBE VOLTMETER



Wide range, flat response performance 20 cps to 700 mc. Convenient, simple to use, occupies minimum bench space. Handy compartment for detachable probe and leads. Diode probe design places approxi-

mately 1.3 μ fd capacity across circuit under test. This, plus high shunt impedance (10 megohms at low frequencies) means circuits under test are not disturbed, and true voltage readings are assured. 1 db accuracy, 20 cps to 700 mc. Also measures dc voltage to 1000 v and resistances to 500 megohms. \$245.00

Instrument	Primary Uses	Frequency Range	Voltage Range	Input Impedance	Price
-hp- 400A	General purpose ac measurements	10 cps to 1 mc	.005 to 300 v 9 ranges	1 megohm 24 μ fd shunt	\$185.00
-hp- 400B	Low frequency ac measurements	2 cps to 100 kc	.005 to 300 v 9 ranges	10 megohms 24 μ fd shunt	\$195.00
-hp- 400C	Wide range ac measurements High sensitivity	20 cps to 2 mc	.0001 to 300 v 12 ranges	10 megohms 15 μ fd shunt	\$200.00
-hp- 404A	Portable, battery operated	2 cps to 50 kc	.0005 to 300 v 11 ranges	10 megohms 20 μ fd shunt	\$185.00
-hp- 410B	Audio, rf, VHF measurements; dc voltages; resistances	20 cps to 700 mc	.1 to 300 v 7 ranges	10 megohms 1.3 μ fd shunt	\$245.00

-hp- Voltmeter Accessories (not listed) include voltage dividers, connectors, shunts and multipliers to extend useful range of your equipment.

Data Subject to Change Without Notice. Prices f. o. b. Factory.

HEWLETT-PACKARD



INSTRUMENTS

hp Signal Generators—10 to 7,600 mc

-hp- 618A SHF SIGNAL GENERATOR

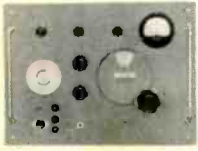

3,800 to 7,600 mc. Provides a 1 mw signal into a 50-ohm coaxial load (zero dbm). Output attenuator directly calibrated in dbm and volts, reduces output level to less than -100 dbm. Frequency dial directly calibrated, accuracy 1/2 of 1%. Repellor voltage automatically tracked. No adjustment during operation. CW, pulsed and FM output. \$2,250.00

Instrument	Frequency	Characteristics	Price
-hp- 608A	10 to 500 mc	Output 1 v to .1 μ v. Amplitude modulated, pulsed and CW output. Direct reading.	\$850.00
-hp- 610B	450 to 1,200 mc	Calibrated output, .1 v to .1 μ v. Internal pulse modulation. Direct calibration	\$925.00
-hp- 614A	800 to 2,100 mc	Direct reading. Pulse modulation, CW & FM. Output 1 mw or .223 v to .1 μ v	\$1,950.00
-hp- 616A	1,800 to 4,000 mc	Direct reading. Pulse modulation, CW & FM. Output 1 mw or .223 v to .1 μ v	\$1,950.00
-hp- 618A	3,800 to 7,600 mc	Direct reading. External pulse modulation, C W & FM. Output .223 v to 2.23 μ v	\$2,250.00

hp Distortion, Wave Form Analyzers—20 cps to 20 kc

-hp- 330B DISTORTION ANALYZER



Measures distortions as low as 0.1% at any frequency, 20 cps to 20 kc. Measures noise voltages as low as 100

μ v. High sensitivity, high stability, broad applicability for broadcast, laboratory or production problems. Wide band 20 db gain input amplifier. Built-in vacuum tube voltmeter usable separately. \$395.00

FM, AM-FM MODELS

-hp- 330C, for FM broadcasters, includes VU meter meeting F. C. C. requirements. -hp- 330D, for AM-FM broadcasters, includes AM detector to rectify AM carrier, plus VU meter employed in model 330C. 330C, \$425.00. 330D, \$440.00

Analyzer	Primary Uses	Frequency Range	Characteristics	Price
-hp- 300A	Wave form analyzer	30 cps to 16 kc	Variable selectivity; measuring range 1 mv to 500 v.	\$625.00
-hp- 320A	Measures total distortion	400 cps and 5 kc	Requires external detector	\$ 75.00
-hp- 320B	Measures total distortion	50, 100, 400 cps, 1, 5 and 7.5 kc	Same as above	\$150.00
-hp- 330B	Measures total distortion	20 cps to 20 kc	Includes input amplifier, VTVM	\$395.00
-hp- 330C	For FM measurements	20 cps to 20 kc	Special VU meter to meet F. C. C. requirements	\$425.00
-hp- 330D	For AM, FM measurements	20 cps to 20 kc	AM detector and VU meter to meet F. C. C. requirements	\$440.00
SQUARE WAVE GENERATOR				
-hp- 210A	Transient and frequency response	20 cps to 10 kc	Output 50 v. peak-to-peak. 1,000 ohm impedance	\$150.00

hp Frequency Measuring Equipment—.01 cps to 10 mc



-hp- 524A FREQUENCY COUNTER

Instantly, automatically, directly measures unknown frequencies, 0.01 cps to 10 mc!

One instrument combines functions of frequency standard, interpolating system and detector! Amazingly simple operation—just connect unknown to input terminal, and exact frequency appears automatically on front panel. High speed decade scalers count unknown frequency over measured, crystal-controlled time interval. Accuracy of measurement ± 1 count \pm crystal stability (2/1,000,000 per week). External higher accuracy standard usable if desired. Minimum of unknown, 1 v peak. \$2,000.00

-hp- 100D SECONDARY FREQUENCY STANDARD



Swift, sure frequency comparison, new convenience in standardizing with minimum external equipment.

100 μ sec time markers, built-in oscilloscope, sine or rectangular waves. Low output impedance, short-time stability 1/1,000,000. Performs most functions of expensive primary standards in audio, rf or supersonic ranges. \$600.00

Instrument	Primary Uses	Frequency Range	Characteristics	Price
-hp- 524 Frequency Counter	Frequency, interval, time measurements	.01 cps to 10 mc	Direct reading, no interpolation, accuracy about 2/1,000,000	\$2,000.00
-hp- 100D Secondary Standard	Frequency, time measurements	100 kc, 10 kc, 1 kc, 100 cps, 10 cps	Stability 1/1,000,000 (short-time). Sine or rectangular output. Marker pips.	\$ 600.00
-hp- 100C Secondary Standard	Audio, supersonic calibration	100 kc, 10 kc, 1 kc, 100 cps	Accurate within $\pm .001$ %. Sine waves only.	\$ 450.00
-hp- 500A Frequency Meter	Rapid frequency measurements	5 cps to 50 kc	10 ranges ± 2 % accuracy. Input 0.5 to 200 volts.	\$ 210.00
-hp- 505A Tachometer	Measurements of high speed machinery	300 to 3,000,000 rpm	10 ranges ± 2 % accuracy.	\$ 300.00
-hp- 505B Tachometer	Same as above	5 to 50,000 rps	Same as 505A except calibrated in rps.	\$ 300.00

Frequency monitors available for FM broadcast, 88 to 108 mc, TV aural broadcast 59.75 to 215.75 mc; and for communications systems, 30 to 175 mc.

Data Subject to Change Without Notice. Prices f.o.b. Factory.

Complete Coverage! HEWLETT-PACKARD

Microwave Test Equipment—10 to 18,000 mc!

Basic, low cost elements offer utmost flexibility for assembly of exact instrumentation required. Each unit covers entire range of its waveguide size. Simple, sturdy mechanical design; accurate, multi-purpose operation.

Instrument	Coaxial Type N. Conn.	"S" 3" x 1 1/4" 2.6 - 3.95 kmc.	"G" 2" x 1" 3.95 - 5.85 kmc.	"J" 1 1/2" x 3/4" 5.85 - 8.2 kmc.	"H" 1 1/4" x 3/8" 7.05 - 10.0 kmc.	"X" 1" x 1/2" 8.2 - 12.4 kmc.	"P" .702" x .391" 12.4 - 18.0 kmc.
Adaptors, Waveguide to Coax		S281A \$75.00	G281A \$55.00	J281A \$50.00	H281A \$45.00	X281A \$35.00	
Cover to choke flange		S290A \$40.00	G290A \$30.00	J290A \$25.00	H290A \$20.00	X290A \$15.00	P290A \$20.00
Attenuators, Fixed 6, 10, 20 db		S370 \$75.00	G370 \$65.00	J370 \$65.00	H370 \$60.00	X370 \$55.00	P370 \$60.00
Flap, 25 db max.		S375A \$75.00	G375A \$65.00	J375A \$60.00	H375A \$55.00	X375A \$50.00	P375A \$55.00
Calibrated		S380A \$225.00					
Detector Mounts	440A† \$85.00	S485A* \$125.00	G-485B† \$95.00	J485B† \$90.00	H485B† \$85.00	X485B† \$75.00	
Frequency Meters, Reaction				J530A \$120.00	H530A \$120.00	X530A \$120.00	
Slotted Sections	806B§ \$200.00	S810A* \$450.00	G810B§ \$90.00	J810B§ \$90.00	H810B§ \$90.00	X810B§ \$90.00	
Waveguide Tees, Series		S840A \$60.00	G840A \$50.00	J840A \$40.00	H840A \$35.00	X840A \$30.00	P840A \$35.00
Shunt		S841A \$60.00	G841A \$50.00	J841A \$40.00	H841A \$35.00	X841A \$30.00	P841A \$35.00
Hybrid		S845A \$90.00	G845A \$75.00	J845A \$60.00	H845A \$55.00	X845A \$45.00	P845A \$55.00
Transformers, Slide-screw		S870A \$150.00	G870A \$140.00	J870A \$135.00	H870A \$130.00	X870A \$125.00	P870A \$130.00
E-H		S880A \$175.00	G880A \$155.00	J880A \$145.00	H880A \$135.00	X880A \$130.00	P880A \$135.00
Adjustable Shorts		S920A \$80.00	G920A \$70.00	J920A \$65.00	H920A \$60.00	X920A \$50.00	P920A \$55.00
Terminations, Low Power		S910A \$45.00	G910A \$40.00	J910A \$35.00	H910A \$30.00	X910A \$25.00	P910A \$30.00
Terminations, High Power		S912A \$125.00				X912A \$75.00	
Broad Band Probe	442A \$75.00				All Frequencies		
Broad Band Probe, Untuned	444A \$50.00				All Frequencies		

* For use with bolometer only.

† For use with bolometer or crystal.

• Complete assembly including carriage.

§ Mounts in 809B carriage

-hp- 809B UNIVERSAL PROBE CARRIAGE

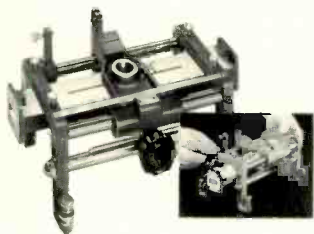

Now—a single all-purpose probe carriage operates with 5 different -hp- slotted sections—waveguide and coaxial. Mounts sections covering frequencies 3,000 to 12,400 mc—sections can be interchanged in 30 seconds! Carriage calibrated in mm. to 0.1 mm.; dial gauge may be mounted for more accurate readings. Operates with -hp- 442A

Broad Band Probe and -hp- 440A Coaxial Detector in combination; or with -hp- 444A Untuned Probe. -hp- 809B, \$160.00

-hp- COAXIAL SLOTTED SECTIONS

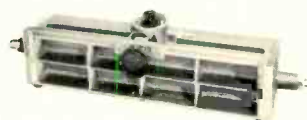

-hp- 805A/B. 500 to 4,000 mc. High accuracy, high stability, negligible slope, minimum leakage. Exclusive parallel plane design with non-bowing central conductor. VSWR of basic section and connectors less than 1.04. -hp- 805A, 50 ohms, Type N connector, for flexible cables. -hp- 805B, 46.3 ohms, for 3/8" rigid transmission lines. \$475.00

-hp- 806B. 3,000 to 12,000 mc. Same parallel plane design as 805A/B. For use with 809B Carriage. VSWR of section and connectors 1.06 to 10,000 mc. 50 ohm impedance, negligible slope. Type N connectors for flexible cable. \$200.00



-hp- 803A VHF Bridge reads impedance magnitude and phase direct, 10 to 500 mc. Rapid operation, for comparative measurements 5 to 1,000 mc. Impedance range 2 to 2,000 ohms. Phase angle -90° to +90° at 52 mc and above. \$495.00



-hp- 417A VHF Detector, for use with 803A Bridge; or general laboratory readings. Super-regenerative receiver, 10 to 500 mc, 5 bands. Approx. 5 μv sensitivity over entire band. Direct reading frequency control, thoroughly shielded. \$200.00

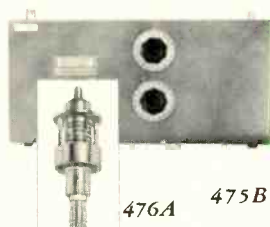

New -hp- 476A Universal Bolometer Mount measures rf power 10 to 1,000 mc. No tuning or adjustment. VSWR less than 1.15, 20 to 500 mc; 1.25, 10 to 1,000 mc. \$125.00. -hp- 475B Tunable Mount, continuous 1,000 to 4,000 mc. \$200.



-hp- 430A Microwave Power Meter provides instantaneous rf power readings direct in db or mw at all bolometer mount frequencies. No calculations, no adjustment except zero set. For -hp- bolometer mounts: 475B, 476A, 485. \$250.00



-hp- 415A Standing Wave Indicator for all waveguide or coaxial slotted sections. Gives direct readings in VSWR or db. Single frequency operation; 300 to 2,000 cps. Low noise level, 0.3 μv sensitivity, 60 db calib. attenuator. \$200.00

Data Subject to Change Without Notice. Prices f. o. b. Factory.



INSTRUMENTS Complete Coverage!

-hp- AMPLIFIERS



Complete instrumentation for distortion-free, fast pulse measurement. *-hp-460A Wide Band Amplifiers*, in cascade with *-hp-460B Fast-Pulse Amplifiers* offer up to 90 db gain, 125 volts open circuit output. This permits full deflection of 5XP CRT, or

2-inch deflection of 5CP tubes. Rise time 0.0026 μ sec; can amplify milli-microsecond pulses; gives over 100 mc bandwidth to your standard oscilloscope. 460A, \$185.00; 460B, \$225.00. Connecting cables, plugs, accessories—prices on request.

-hp- 450A Amplifier—general purpose instrument, 20 db or 40 db gain, for use wherever wide frequency range and high stability are needed. 10 cps to 1 mc. Negligible phase shift, no spurious responses. \$140.00

-hp- 520A NUCLEAR SCALER



-hp-520A is a new, high-speed 10 mc scaler offering utmost reliability in nuclear counting and frequency measurements. Capable of scaling pulses at rates up to 10,000,000 pps. Has double-pulse resolving time of 0.1 μ sec; triple-pulse resolving time of

0.2 μ sec. Two-decade circuit gives scaling factor of 100; residual counts are indicated by two panel meters with combined capacity of 100 counts. Instrument may be used with existing low speed scalers to provide any desired count capacity. \$600.00

-hp- POWER SUPPLIES

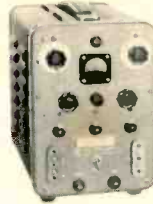

-hp-715A (illustrated) is a versatile source of regulated beam and reflector voltage for operating most test bench klystron tubes. Beam voltage 250 to 400 v; reflector voltage 10 to 900 v; 6.3 v filament. Internal, 1,000 cps square wave modulation, also 60 cps FM modulation, both on reflector voltage. \$300.00

-hp-710A—Highly stable regulated dc supply, output variable 180 to 360 v at 75 ma., 6.3 v filament. Either terminal may be grounded. Total hum and noise less than 5 mv. \$85.00

-hp-712A. Stabilized, variable power supply providing 0 to 500 v at 200 ma and 1/2% regulation. Also variable bias voltages, 0 to 150 v at 5 ma, and 6.3 v filament at 10 amps. Main supply completely metered. Either terminal may be grounded. Hum less than 8 mv. For laboratory, production or general use. \$350.00

-hp- 212A PULSE GENERATOR



Provides continuously variable, high power "fast pulses" of superior wave form. Combines broad general usefulness with 0.02 μ sec rise and decay time to meet requirements of radar, TV and nuclear work. Pulse length variable 0.07 to 10 μ sec;

minimum overshoot; 50 watt peak power (50 v to 50 ohms loads). Low impedance means accurate pulses can be delivered at a distance from the instrument. Repetition rate variable 50 to 5,000 pps; controlled internally or externally. Synchronizing pulses available in advance of, or following, output pulse. \$550.00

Data Subject to Change Without Notice. Prices f. o. b. Factory.



offers COMPLETE COVERAGE

in convenient "next door" service!

-hp- has selected the best independent organizations in America to give you personal help with measuring problems. Electronics specialists—men trained by Hewlett-Packard—save you time by helping select exact *-hp-* instrumentation you need. These men are located in major business centers—as near as your telephone. Call them when you need personal help—in your plant—today!

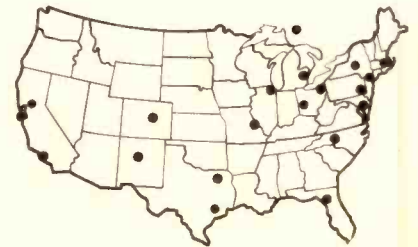

Albuquerque, New Mexico
Neely Enterprises
107 S. Washington St.
Albuquerque 5-8731

Boston 16, Massachusetts
Burlingame Associates
270 Commonwealth Ave.
KENmore 6-8100

Chicago 40, Illinois
Alfred Crossley & Associates
4501 Ravenswood Ave.
UPTown 8-1141

Cleveland 15, Ohio
M. P. Odell Co.
2536 Euclid Ave.
PRespect 1-6171

Dallas 5, Texas
Earl Lipscomb Associates
3561 Marquette St.
P. O. Box 8042
EMerson 6-7989

Dayton 2, Ohio
Alfred Crossley & Associates
410 W. First St.
Michigan 8721

Denver 3, Colorado
Ronald G. Bowen
852 Broadway
AComa 5211

Detroit 5, Michigan
S. Sterling Company
13331 Linwood Ave.
TOWnsend 8-3130

Fort Myers, Florida
Arthur Lynch & Associates
P. O. Box 466
Fort Myers 5-6762

Houston 5, Texas
Earl Lipscomb Associates
2420-B Rice Blvd.
P. O. Box 6573
LInden 9303

High Point, North Carolina
Bivins & Caldwell
Room 807, Security Bank Bldg.
High Point 3672

Los Angeles 46, California
Neely Enterprises
7422 Melrose Ave.
WHitney 1147

New York 13, New York
Burlingame Associates
103 Lafayette St.
DIGby 9-1240

Philadelphia 44, Penn.
Burlingame Associates
422 West Coulter St.
TENnessee 9-2006

Sacramento, California
Neely Enterprises
309 Ochsner Bldg.
GILbert 3-7461

San Francisco 18, California
Neely Enterprises
2830 Geary Blvd.
WAlnut 1-3960

St. Louis 3, Missouri
Harris-Hanson Company
208 North 22nd St.
MAIn 5464

Syracuse 2, New York
Burlingame Associates
712 State Tower Bldg.
SYracuse 2-0194

Toronto 2-B Ontario, Canada
Atlas Radio Corporation, Ltd.
560 King St., West
WAverley 4761

Washington 9, D. C.
Burlingame Associates
2017 S Street N. W.
DEcatur 8000

HEWLETT-PACKARD COMPANY

2310 PAGE MILL ROAD • PALO ALTO, CALIFORNIA, U. S. A.
Export: Frazar & Hansen, Ltd., San Francisco, New York, Los Angeles

HEWLETT-PACKARD



INSTRUMENTS

Electrical and Electronic Components

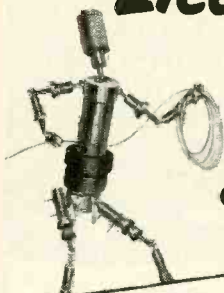

BY
**CAMBRIDGE
THERMIONIC
CORPORATION**

*custom or standard the
guaranteed components*

SILVER-PLATED BRASS TERMINAL LUGS



Short Lugs. For low "headroom" applications. Mounted heights from $\frac{3}{32}$ ". In shank lengths for 6 board thicknesses, starting with $\frac{1}{64}$ ".



Turret Lugs. With 2 soldering spaces for 2 or more connections. Sizes range from $\frac{1}{32}$ " to $\frac{1}{4}$ " terminal board thicknesses. Mounted heights from $\frac{1}{32}$ ".



Split Lugs. For potted units where later soldering is advisable. Also standard applications. Hole through shaft allows top or bottom wiring. Fit standard board thicknesses from $\frac{1}{64}$ " through $\frac{1}{4}$ ". Mounted heights from $\frac{3}{32}$ ".



Double End Lugs. Provide terminal posts on both sides of board. Through connection for easy wiring. For board thicknesses from $\frac{1}{32}$ " to $\frac{1}{4}$ ". Mounted heights from $\frac{3}{32}$ ".



Combination Lug. Removable screw permits mounting components directly to screw end. Also provides removable link connections at screw end. 3 sizes, $\frac{5}{16}$ ", $\frac{11}{32}$ ", $\frac{3}{8}$ " diameter. Bright alloy plated for easy soldering.

SWAGERS



Pressure Swagers. Supplied with dies for one type terminal on loan basis. Extra dies or unit with dies can be bought from C.T.C.

Hand Swagers for any C.T.C. terminal also available.

INSULATED TERMINALS

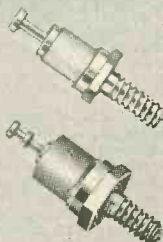

Phenolic. $\frac{1}{4}$ " diameter, in rivet or screw stud type. Voltage breakdown from 4800 — 11,000 V at 60 cycles RMS.

Ceramic. Silicone impregnated. 5 lengths of dielectric. Voltage breakdown ratings up to 5800 V. Over-all heights range from $\frac{3}{8}$ ", including lug. For high electrical stresses over a broad humidity range. Cadmium plated studs. Bright alloy plated brass terminals.

INSULATED FEED THROUGHs



Phenolic. Approved XXX material. Brass bushings, nickel plated. Brass through-terminals, silver plated for easy soldering. Rugged, withstand shock and vibration. Two sizes: for $\frac{1}{4}$ " and $\frac{3}{8}$ " mounting holes.

Ceramic. Silicone impregnated. Threaded for $\frac{1}{4}$ " hole mounting. O.A. length $\frac{7}{8}$ ". Voltage breakdown 4800 RMS at 60 cycles.

TERMINAL BOARDS

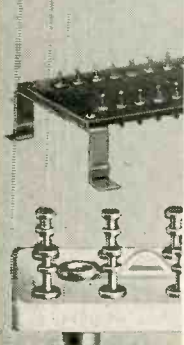

Phenolic. Available in various widths and terminal arrangements from $\frac{1}{2}$ " wide to 3" wide. Thicknesses: $\frac{3}{32}$ "; $\frac{1}{8}$ "; $\frac{3}{16}$ ". All boards in 5 sections scribed for easy separation. Special boards made to your specifications.

Ceramic. Silicone impregnated. Type X1986 with 8 lugs staked in two rows. Standoffs riveted and soldered to ground strap for good grounding at R.F. frequencies. $1\frac{1}{4}$ " long, $\frac{3}{8}$ " wide. All metal parts plated. O.A. mounted height: $\frac{35}{64}$ ".

SLUG TUNED COILS



Phenolic. 3 sizes: $2\frac{7}{32}$ "; $1\frac{1}{8}$ ", and 2" high. 5 standard windings — also special windings or as high-quality phenolic coil forms.

Ceramic. Silicone impregnated. 5 sizes, mounted heights from $1\frac{9}{32}$ " to $1\frac{15}{16}$ ", diameters from $\frac{3}{16}$ " to $\frac{1}{2}$ ". Spring lock for slug. Cadmium plated mounting studs. Complete with mounting hardware and high, medium or low frequency slug.

R. F. CHOKES



LHC. High Q iron core with 6-32 mounting stud. 8 values from 2.5 mh to 125.0 mh. Wax impregnated.

LAB. Pie wound on phenolic core with cotter pin terminals. 8 windings .75 mh to 15.0 mh. Current rating 125 ma.

CUSTOM ENGINEERING

to your specifications or standard government specifications. C.T.C. Engineers will design all types of Boards, Coils, and Terminal Lugs for production in quantity to fill your needs. No extra charge for this service.

WRITE FOR NEW CATALOG

For complete data and engineering drawings or these and other C.T.C. Electrical and Electronic Components and Hardware. No obligation.

MISCELLANEOUS HARDWARE

Shaft Locks • Dial Locks • Panel Screws
Thumbscrews • Handles • Stand Offs • Binding Posts
Mounting Brackets • Jacks • Tube Clamps

CAMBRIDGE THERMIONIC CORPORATION, 438 CONCORD AVE., CAMBRIDGE 38, MASS.

West Coast Stock Maintained by: E. V. Roberts, 5068 West Washington Blvd., Los Angeles, California

There's a *University* Loudspeaker

RUGGED!

DEPENDABLE!

VERSATILE!

FOR EVERY COMMERCIAL AND INDUSTRIAL APPLICATION



TRUMPETS Model 7102 exemplifies the rugged construction and progressive engineering behind every University product. Model 7102 is the only loudspeaker ever approved by Underwriters' Labs for Class II Groups E, F, & G hazardous area duty. Features include re-entrant trumpet (pioneered by University) for compactness and greater efficiency, heavy duty 25 watt driver unit with exclusive University "W" shaped Alnico V magnet, and built-in line matching transformer with impedances of 16, 45, 500, 1000, 1500 and 2000 ohms. See general catalog for trumpets of all sizes.

BREAKDOWN-PROOF DRIVER UNITS Model PA-30 embodies features developed by University and never successfully imitated. Ratings are conservative, and construction is to well known University standards which have made our drivers famous for their dependable performance. PA-30 is rated at 30 watts, with response 80-10,000 cps, and is the first to have a multi-tap built-in line matching transformer. Exclusive "rim centering" construction of mechanism and use of University "W" shaped Alnico V magnet insures high conversion efficiency, permanent voice coil alignment regardless of shock or vibrations. Weatherproofed throughout.

PAGING AND INTERCOM SPEAKERS These feature reflex air columns with hermetically sealed driver units. They are widely used for intercommunication and paging of all types. Efficiency is high and reproduction exceptional at any volume level. Directional, radial, or bi-directional types available. Weather-proof finishes permit use anywhere. Typical of University pace-setting design is the Cobra-12 illustrated, which provides optimum area coverage with minimum power input. Power rating is 12 watts, frequency response 250-10,000 cps, dispersion angle 60° x 120°. Swivel mounting bracket provides full flexibility.



SUBMERGENCE-PROOF SPEAKERS These types are designed for use where extreme ruggedness and immunity to spray, gases, live steam or dust are essential. Function even under water, drain automatically, operate continuously regardless of exposure. Models available for directional or radial projection, wall or bulkhead mounting, swivel mount and with or without built-in line matching transformer and attenuator. Design is ideal for railroad use, shipboard, industries, docks, rough mobile work, etc. Model MM-2, illustrated, is rated at 15 watts continuous IPM, frequency 300-6000 cps, impedance 16 ohms.

FOR ALL HIGH FIDELITY REPRODUCTION REQUIREMENTS

WIDE RANGE CONE SPEAKERS Model 6201 comprises a superb 12" cone speaker with a driver type tweeter mounted coaxially. The cone speaker features a 24 oz. "W" shaped Alnico magnet and edge treated cone for distortion-free low frequency response. Tweeter has wide angle horn. A built-in LC crossover network and external high frequency attenuator are included. Capacity is 25 watts, response 45-15,000 cps, impedance 8 ohms. Other cone speakers for high fidelity, as well as submergence-proof or blastproof service for commercial and military applications.

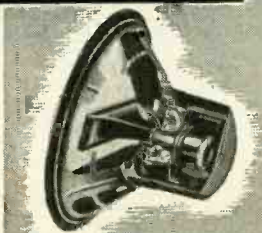

HI-FREQUENCY TWEETERS University offers a complete line of single and double tweeter units for both 2000 and 600 cycle crossover. Exclusive University "reciprocating flare" horn construction assures uniform wide angle dispersion. A complete line of accessories are included—crossover networks, adapter for mounting tweeter on a standard cone speaker, etc. These tweeters may be added to any standard amplifier and speaker to provide the finest in high fidelity reproduction—and at a very low cost.



WRITE DEPT. G TODAY FOR YOUR FREE COPY OF THE NEW 24-PAGE UNIVERSITY TECHNI-LOGUE—A COMBINED TECHNICAL MANUAL AND CATALOG—INVALUABLE FOR YOUR FILES.



University LOUDSPEAKERS
INCORPORATED
80 SOUTH KENSICO AVE., WHITE PLAINS, NEW YORK

Wizardry in WIRE FORMS

Small diameter wire formed in any shape you need!



IMMEDIATE CAPACITY FOR DEFENSE SUB-CONTRACTS

STRAIGHTENING & CUTTING

Perfect straight lengths to 12 ft.
.0015 to .125 diameter

WIRE FORMS

.0015 to .080 diameter

SMALL METAL STAMPINGS

.0025 to .035 thickness
.062 to 3 inches wide

★

Specializing in Production of Parts for Electronic and Cathode Ray Tubes

Write for Illustrated Folder
Send Blueprints or Samples for Estimate

ART WIRE & STAMPING CO.
227 High Street Newark 2, N. J.

this BOOK tells you
the MANUFACTURERS
of over 1400 types of
ELECTRONIC and
ALLIED PRODUCTS
from . . ABRASIVES
to . . YOKES, Deflection
and this year . . .



tells you where they are in production or available in a reasonable time and unrestricted for general industrial use.

electronics BUYERS' GUIDE

Please mention this book when buying or inquiring from it.

**Finest Cored Solder
in the World**

ERSIN

Multicore



The only 3 core solder made with ERSIN FLUX...the original non-corrosive, extra-active flux

TECHNICAL ADVANTAGES

Multicore Solder

- Three separate cores of flux eliminate possibility of no flux in a portion of the wire, which may occur in single cored solder. Guaranteed continuity of the flux stream prevents "dry" joints, i.e. those having high electrical resistance.
- Although there are three cores of flux in Multicore, the total percentage of flux to solder is no greater than in single cored solder.
- Very rapid melting results from the multiple core construction which provides thinner walls of solder than are found in same gauge single cored solder.
- Multicore's unique properties make perfect joints possible on difficult metals and alloys, even if oxidized.
- Ability to tin rapidly produces perfect joints with less solder. Greater coverage per pound.

Ersin Flux

- Ersin Flux is an exclusive product of Multicore Solders Limited, and is only supplied as part of Multicore Solder. It is a high grade, water white rosin, homogeneously activated.
- Confers on rosin a vigorous fluxing action without affecting the non-corrosive and protected features of the original rosin.
- Soldered joints made with Ersin Flux do not corrode even after prolonged exposure to a degree of humidity.
- Reduces the surface tension of molten solder, causing it to wet metals rapidly, increasing speed of operation with resultant production economies.
- Free from objectionable odor. Non-toxic in use.
- Leaves nothing but pure rosin on the work after soldering, and may be used wherever plain rosin is specified.

ALLOY AND MELTING POINTS OF ERSIN MULTICORE SOLDER

Alloy Tin/Lead	Multicore Color Code	Solidus °C.	Liquidus °C.	Recommended bit temperature °C.	USES
60/40	Red	183°	190°	230°	High quality work requiring low melting point alloy.
50/50	Yellow	183°	212°	252°	Hand soldering. Radio, telephone and electrical equipment; batteries.
45/55	Crimson/Buf	183°	227°	267°	
40/60	Green	183°	238°	278°	Fuses, motors, dynamos.
30/70	White	183°	257°	297°	
20/80	Purple	183°	276°	316°	

STANDARD GAUGES

Standard Wire Gauge	Diameter in Inches	Diameter in Millimeters	Approximate Number of Feet per lb.					
			ALLOY					
			60/40	50/50	45/55	40/60	30/70	20/80
10	1.128	3.251	25.2	24.1	23.5	23.0	21.9	20.8
12	0.104	2.642	38.1	36.5	35.2	34.9	33.1	31.5
13	0.092	2.337	48.7	46.6	45.3	44.5	42.3	40.3
14	0.080	2.032	64.4	61.7	59.2	58.6	56.0	53.3
16	0.064	1.626	100.5	96.4	94.3	92.1	87.5	83.3
18	0.048	1.219	178.5	171.0	167.8	163.5	155.5	148.0
19	0.040	1.016	257.5	246.5	240.4	235.5	224.0	213.0
20	0.036	0.914	318.0	304.5	302.5	291.0	276.5	263.0
22	0.028	0.711	526.0	503.0	492.0	481.0	457.0	435.0

ERSIN MULTICORE SOLDER is made in a wide range of gauges, as shown. It can also be supplied in any intermediate size. For general radio and electronic production 13, 14, 16 and 18 S.W.G. are the most widely-used gauges.

FEDERAL SPECIFICATIONS

ERSIN Multicore Solder meets all requirements of Federal Specification QQ-S-571-b September, 1947 entitled "Solders Soft Tin Lead" as certified by the New York Testing Laboratory Incorporated.

ALL GAUGES AND ALLOYS READILY AVAILABLE FROM NEW YORK STOCK

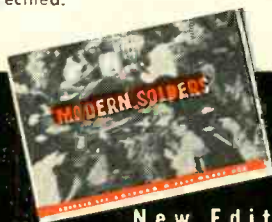

New Edition! FREE—
Valuable booklet "Modern Solders" and testing samples available on request.

Address U. S. A. and Canadian inquiries to

MULTICORE SALES CORP.
164 Duane Street • New York 13, N. Y.

Inquiries regarding other territories to

MULTICORE SOLDERS LTD.
Mellier House, Albemarle Street • London, W. 1, England

Standard TIMERS



AN ECONOMICAL INVESTMENT IN LONG-LIFE PERFORMANCE AND EXTREME ACCURACY. RUGGED, FOR HEAVY-DUTY SERVICE: FLEXIBLE IN APPLICATION.

Model	Scale Divisions	Totalizes	Accuracy
S-100	1/5 sec.	6000 sec.	±.1 sec.
S-60	1/5 sec.	60 min.	±.1 sec.
SM-60	1/100 min.	60 min.	±.002 min.
S-10	1/10 sec.	1000 sec.	±.02 sec.
S-6	1/1000 min.	10 min.	±.0002 min.
S-1	1/100 sec.	60 sec.	±.01 sec.
MST	1/1000 sec.	.360 sec.	±.001 sec.
MST-500	1/1000 sec.	30 sec.	±.002 sec.

The clutch coil can be connected directly in the plate circuit of electronic tubes. For this use the coil has a resistance of 2000 ohms and requires 50 to 60 milliamperes. When ordering for this purpose, always specify 120V DC clutch coil. Write for Bulletin 153. T-1E

THE Standard Electric Time Co.
97 Logan Street  Springfield, Mass.

FOR POSITIVE AND INEXPENSIVE SHIELDING

— use Metex "Electronic Weather Strips"

Because they combine exceptional *resiliency* with good *conductivity*, Metex Electronic Products made of knitted wire mesh offer an unusually effective means of sealing and shielding a wide variety of types of electronic equipment.

As closures for sheet metal cabinets, for instance, the resiliency of "Metex" assures positive conductive contact *at every point* between cover and cabinet — eliminating costly machining for close tolerances. Metex Gaskets also assure resilient metal-to-metal contact between flanges, and can be combined with rubber com-

pounds to function both as a shield and as a seal.

Applications in which "Electronic Weather Strips" have already proved their effectiveness include pulse modulator shields, wave-guide choke-flange gaskets, replacement of beryllium-copper fingers and springs on TR and ATR tubes.

We will be glad to put our experience at your disposal. A letter to Mr. R. L. Hartwell, outlining your problem, will receive immediate study.

For preliminary information, write for bulletin "Metex 'Electronic Weather Strips.'"



METAL TEXTILE CORPORATION

641 EAST FIRST AVENUE, ROSELLE, N. J.

WORLD'S MOST POPULAR PROFESSIONAL TAPE RECORDERS

Magnecorders

FIRST FOR FIDELITY

50 to 15,000 cps ± 2 db at 15"/sec. tape speed. Signal-to-noise ratio—50 db. Maximum flutter—0.3%. Harmonic distortion—2%. Broadcast quality!

FIRST FOR FLEXIBILITY

Exclusive Magnecord unit construction lets you use Magnecord recorders, amplifiers, and other units interchangeably for portable, rack, or console — add other units at will — record from one to four microphones.

FIRST FOR FEATURES

Now 3 separate heads permit monitoring from tape. Three speeds: 15, 7½, 3¾ inches per second. Up to one hour on 7" NAB reels — will take 10½" reels on portable, too. New POSITIVE TIMING DRIVE. Can be remotely controlled.

THERE'S A MAGNECORDER
FOR EVERY PURPOSE . . .
. . . EVERY PURSE



See the PT6-A portable — only \$300. World's most widely used professional tape recorder.



PT7, PT63, and PT6 also rack mount.



PT7 Console — \$950 complete

See your distributor or write for specifications on PT6, PT63, and PT7 series Magneorders.

Magnecord INC.

360 North Michigan Avenue
Chicago 1, Illinois

Mr. Manufacturer:

To get the best delivery on **OHMITE** resistance components, tailor your needs to these "standard" **OHMITE** items...



RHEOSTATS

The Ohmite series of standard, close control rheostats is the most extensive available—so it is easy to select a size to fit your application. There are ten sizes, ranging from 25 to 1000 watts, with many standard resistance values in each size. All models have the Ohmite all-ceramic construction, with winding permanently locked in vitreous enamel, and smoothly gliding metal-graphite brush.

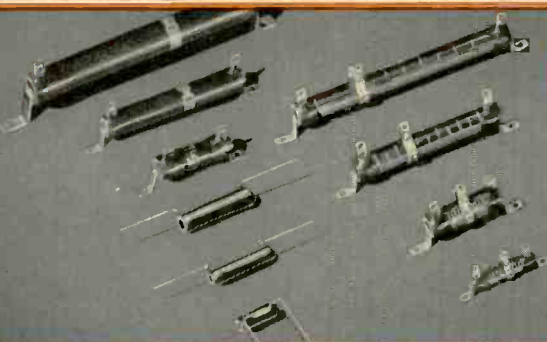

RESISTORS

The extensive range of Ohmite types and sizes makes possible an almost endless variety of standard resistors to meet your needs. The Ohmite line includes more than 60 core sizes, in a wide range of wattage and resistance values. There are also 18 types of resistor terminals available. Included in the standard Ohmite line are fixed, adjustable, tapped, non-inductive, and precision resistors. Specially developed vitreous enamel provides years of un failing performance.

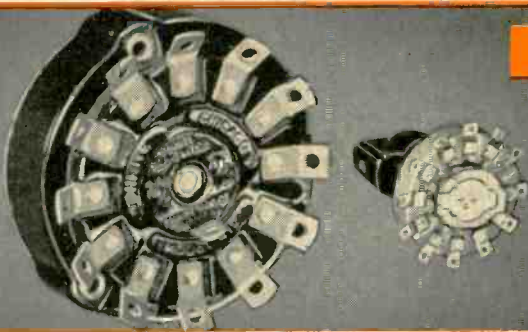

TAP SWITCHES

Ohmite tap switches are supplied in five standard models, rated at 10, 15, 25, 50, and 100 amperes, a.c. They combine high current capacity and a large number of taps with unusual compactness. Their sturdy, one-piece ceramic bodies provide permanent non-arcing insulation. Their heavy silver-to-silver contacts have a self-cleaning action and provide continuous, dependable contact with low resistance. Ohmite tap switches are supplied in enclosed or open, shorting or non-shorting types.

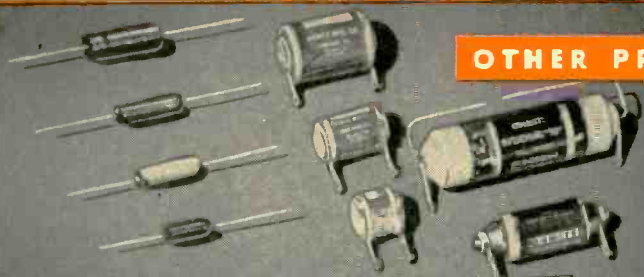

OTHER PRODUCTS

Ohmite offers an extensive line of standard precision, non-inductive resistors in $\frac{1}{2}$ - and 1-watt sizes, in the standard type, vitreous-enameled type, or hermetically sealed in glass. They have an accuracy of $\pm 1\%$. Ohmite non-inductive vitreous-enameled resistors are also available in standard 50-, 100-, and 160-watt sizes in a wide range of resistance values. In addition, Ohmite provides radio-frequency plate chokes, power line chokes, and dummy antennas.



Write ON COMPANY
LETTERHEAD FOR CATALOG
AND ENGINEERING
MANUAL NO. 40

OHMITE MFG. CO.,
4973 Flournoy St.,
Chicago 44, Ill.



Be Right with

OHMITE[®]

RHEOSTATS • RESISTORS • TAP SWITCHES

"EVEREADY" RADIO BATTERIES

BRAND

TYPES	VOLTAGE	LENGTH	WIDTH	HEIGHT	TERMINALS	SUGGESTED CURRENT RANGE	WEIGHT BATTERY
"A-B" PACKS FOR HOME RECEIVERS							
758	1.5 A	10 $\frac{1}{8}$ "	4 $\frac{1}{8}$ "	6 $\frac{1}{8}$ "	Socket —, +1.5	A :200-300 m.a.	14 lb. 4 oz.
	90 B				Socket —, +90	B :7.0-12.0 m.a.	
759	1.5 A	15 $\frac{1}{8}$ "	4 $\frac{3}{8}$ "	6 $\frac{1}{8}$ "	Socket —, +1.5	A :200-300 m.a.	17 lb. 9 oz.
	90 B				Socket —, +90	B :7.0-12.0 m.a.	
"A-B" PACKS FOR PORTABLE RECEIVERS							
753	7.5 & 9 A	9 $\frac{7}{8}$ "	2 $\frac{3}{8}$ "	4 $\frac{5}{8}$ "	Socket —, +7.5 & 9	A :50 m.a.	4 lb. 12 oz.
	90 B				Socket —, +90	B :5.0-12.0 m.a.	
754	7.5 & 9 A	10 $\frac{1}{8}$ "	3 $\frac{1}{4}$ "	4"	Socket —, +7.5 & 9	A :50 m.a.	6 lb. 1 oz.
	90 B				Socket —, +90	B :5.0-15.0 m.a.	
755	6 & 7 $\frac{1}{2}$ A	8 $\frac{3}{8}$ "	2 $\frac{7}{8}$ "	3 $\frac{3}{4}$ "	Socket —, +6 & 7 $\frac{1}{2}$	A :50 m.a.	3 lb. 9 oz.
	75 B				Socket —, +75	B :5.0-12.0 m.a.	
756	7.5 & 9 A	8 $\frac{7}{8}$ "	2 $\frac{1}{8}$ "	3 $\frac{3}{8}$ "	Socket —, +7 $\frac{1}{2}$ +9	A :50 m.a.	2 lb. 14 oz.
	90 B				Socket —, +90	B :5.0-12.0 m.a.	
"A" BATTERIES FOR HOME RECEIVERS							
A-1300*	1.25	5 $\frac{5}{8}$ "	4 $\frac{1}{2}$ "	8 $\frac{5}{8}$ "	Socket —, +1.25	100-600 m.a.	5 lb. 12 oz.
740	1.5	4 $\frac{1}{8}$ "	3 $\frac{7}{8}$ "	7 $\frac{3}{4}$ "	Socket —, +1.5	100-350 m.a.	6 lb.
#6 Dry Cell	1.5	2 $\frac{5}{8}$ " D		6 $\frac{5}{8}$ "	Screw —, +1.5	100-250 m.a.	2 lb. 2 oz.
"B" BATTERY FOR HOME RECEIVERS							
487	45	5 $\frac{1}{8}$ "	2 $\frac{1}{8}$ "	7 $\frac{1}{4}$ "	Socket —, +22.5, +45	7.0-12.0 m.a.	4 lb. 2 oz.
"A" BATTERIES FOR PORTABLE RECEIVERS							
717	7 $\frac{1}{2}$	2 $\frac{7}{8}$ "	1 $\frac{1}{8}$ "	3 $\frac{3}{8}$ "	Socket —, +7 $\frac{1}{2}$	50 m.a.	8 oz.
726	4.5	3 $\frac{1}{8}$ "	1 $\frac{5}{8}$ "	2 $\frac{1}{8}$ "	Socket —, +4.5	50-100 m.a.	10 $\frac{1}{2}$ oz.
736	4 $\frac{1}{2}$	3 $\frac{1}{8}$ "	1 $\frac{1}{8}$ "	4 $\frac{3}{8}$ "	Socket —, +4.5	50-100 m.a.	1 lb.
742	1.5	2 $\frac{9}{8}$ "	2 $\frac{9}{8}$ "	3 $\frac{3}{8}$ "	Socket —, +1.5	100-250 m.a.	1 lb. 5 oz.
744	6	2 $\frac{3}{4}$ "	2 $\frac{3}{4}$ "	3 $\frac{3}{4}$ "	Socket —, +6	50 m.a.	1 lb. 5 oz.
745	1.5	3 $\frac{7}{8}$ "	1 $\frac{1}{8}$ "	10 $\frac{3}{8}$ "	Socket —, +1.5	100-350 m.a.	2 lb. 10 $\frac{1}{2}$ oz.
746	4.5	3 $\frac{1}{8}$ "	1 $\frac{1}{8}$ "	4 $\frac{3}{8}$ "	Socket —, +4.5	50-100 m.a.	1 lb. 3 $\frac{3}{8}$ oz.
747	6	3 $\frac{7}{8}$ "	1 $\frac{1}{8}$ "	10 $\frac{3}{8}$ "	Socket —, +6	50 m.a.	2 lb. 11 oz.
"B" BATTERY FOR PORTABLE RECEIVERS							
482	45	3 $\frac{1}{8}$ "	1 $\frac{3}{8}$ "	5 $\frac{1}{2}$ "	Socket —, +45	5.0-15.0 m.a.	1 lb. 15 oz.
"A" BATTERY FOR PERSONAL RECEIVERS							
720	1.5	2 $\frac{3}{8}$ "	1 $\frac{3}{8}$ "	3 $\frac{3}{8}$ "	Socket —, +1.5	25-250 m.a.	6 $\frac{1}{2}$ oz.
724	6	1 $\frac{3}{2}$ "	1 $\frac{3}{2}$ "	2 $\frac{3}{8}$ "	Flat Contact —, +6	50 m.a.	2 $\frac{1}{2}$ oz.
950	1.5	1 $\frac{1}{64}$ " D		2 $\frac{3}{4}$ "	Flat Contact —, +1.5	25-250 m.a.	3 oz.
"B" BATTERIES FOR PERSONAL RECEIVERS							
455	45	2 $\frac{3}{8}$ "	1"	3 $\frac{1}{8}$ "	Snap Type —, +45	1.0-10.0 m.a.	7 $\frac{1}{2}$ oz.
457	67.5	2 $\frac{1}{8}$ "	1 $\frac{3}{8}$ "	2 $\frac{1}{2}$ "	Snap Type —, +67.5	1.0-8.0 m.a.	7 $\frac{1}{2}$ oz.
467	67.5	2 $\frac{1}{8}$ "	1 $\frac{3}{8}$ "	3 $\frac{1}{4}$ "	Snap Type —, +67.5	1.0-10.0 m.a.	12 oz.
490	90	3 $\frac{3}{8}$ "	1 $\frac{3}{8}$ "	3 $\frac{1}{4}$ "	Snap Type —, +90	1.0-10.0 m.a.	15 oz.
"A" BATTERIES FOR POCKET RECEIVERS							
915	1.5	3 $\frac{5}{64}$ " D		1 $\frac{3}{8}$ "	Flat Contact —, +1.5	25-100 m.a.	$\frac{3}{8}$ oz.
935	1.5	1 $\frac{1}{64}$ " D		2"	Flat Contact —, +1.5	25-100 m.a.	1 $\frac{2}{3}$ oz.
1016	1.5	1 $\frac{9}{64}$ "	$\frac{1}{8}$ "	2 $\frac{3}{64}$ "	Flat Contact —, +1.5	25-100 m.a.	1 $\frac{1}{10}$ oz.
"B" BATTERIES FOR POCKET RECEIVERS AND SPECIAL EQUIPMENT							
411	15	1 $\frac{1}{32}$ "	$\frac{5}{8}$ "	1 $\frac{29}{64}$ "	Flat Contact —, +15	0.3-1.0 m.a.	$\frac{4}{5}$ oz.
412	22.5	1 $\frac{1}{32}$ "	$\frac{5}{8}$ "	2"	Flat Contact —, +22.5	0.3-1.0 m.a.	1 $\frac{1}{2}$ oz.
413	30	1 $\frac{1}{32}$ "	$\frac{5}{8}$ "	2 $\frac{1}{8}$ "	Flat Contact —, +30	0.3-1.0 m.a.	1 $\frac{3}{8}$ oz.
417	15	1 $\frac{1}{8}$ "	$\frac{3}{4}$ "	1 $\frac{1}{8}$ "	Flat Contact —, +15	0.5-2.0 m.a.	1 $\frac{1}{4}$ oz.
420	22.5	1 $\frac{1}{8}$ "	$\frac{3}{4}$ "	2 $\frac{1}{8}$ "	Flat Contact —, +22.5	0.5-2.0 m.a.	2 $\frac{1}{2}$ oz.
430	30	1 $\frac{1}{8}$ "	1"	2 $\frac{1}{8}$ "	Flat Contact —, +30	0.5-2.0 m.a.	3 $\frac{1}{2}$ oz.
493	300	2 $\frac{1}{8}$ "	2 $\frac{3}{2}$ "	3 $\frac{3}{8}$ "	Pin Jacks —, +300	.05-0.5 m.a.	14 $\frac{1}{2}$ oz.

*"Air Cell" Battery

These Battery Engineering Bulletins are available on request: 1. Batteries for portable electronic equipment. 2. "Mini-Max" "A-B" packs for 1.4 volt receivers. 3. Batteries for vacuum tube hearing aids. 4. High voltage batteries. 5. Flash photography... and the "B-C" photoflash system.



The registered trade-marks "Eveready," "Mini-Max," and "Air Cell" distinguish products of NATIONAL CARBON COMPANY

a Division of UNION CARBIDE AND CARBON CORPORATION
30 East 42nd Street, New York 17, N. Y.



MODEL 410-A ULTRA-LOW FREQUENCY OSCILLATOR

with frequency range of
0.02 to 20,000 cps.

FEATURING:

1. BOTH SINE AND SQUARE WAVE • 2. COMPLETELY ELECTRONIC OPERATION • 3. EXCELLENT AMPLITUDE CONSTANCY • 4. LOW DRIFT AND DISTORTION

DESCRIPTION: Model 410-A covers the sub-audio and the entire audio range. It provides both sine and square wave at any frequency range between 0.02 and 20,000 cps.

Precisely engineered and constructed, the Model 410-A is ideal for medical research, geophysical and seismological studies, and design and development of servo-mechanisms and vibration controls.

SPECIFICATIONS:

FREQUENCY RANGE:
0.02 to 20,000 cps, continuously variable in six decade bands.

SINE WAVE AMPLITUDE:
Varies less than ± 0.25 db (3%) over the entire frequency range.

DISTORTION & HUM:
Less than 0.25% over the entire frequency range.

NEW
KROHN-HITE
INSTRUMENTS

FOR PRODUCTION TESTING
FOR DEVELOPMENT
FOR RESEARCH



DERIVATIVE-INTEGRAL MODEL 340-A SERVO-DESIGN FILTER

0.01 to 100 cps.

FEATURING

1. ULTRA-LOW FREQUENCY COVERAGE CONTINUOUS FROM 0.01 TO 100 CPS. • 2. DIRECT READING FREQUENCY AND ATTENUATION DIALS • 3. FOUR DECADE BANDS • 4. SINGLE SCALE LOGARITHMIC DIALS • 5. ATTENUATION RATIO ADJUSTABLE FROM 2 TO 50

DESCRIPTION: Used in the dc path of a servo loop to obtain optimum filter characteristic for any feed-back control system. The Model 340A represents a compensating function which approximates either proportional-plus-derivative or proportional-plus-integral correction.



MODEL 420-A

LOW FREQUENCY OSCILLATOR

0.35 cps. to 52 kc.

7" high—12" wide—
8" deep

SPECIFICATIONS:

FREQUENCY RANGE:
0.35 to 52,000 cps, continuously variable in five decade bands.

SINE WAVE AMPLITUDE:
Varies less than ± 1 db over the entire frequency range from 0.35 to 52,000 cps.

DISTORTION: Less than 1% at any frequency.

HUM & NOISE: Less than 0.2% at any output level.

FEATURING

1. EXCELLENT AMPLITUDE CONSTANCY • 2. LOW DISTORTION • 3. LOW POWER CONSUMPTION • 4. SINGLE SCALE LOGARITHMIC DIAL

DESCRIPTION: A low distortion constant amplitude sine wave oscillator in the range from 0.35 to 52,000 cps. is available in a compact novel design.

Especially useful for servomechanism, geophysical and seismological studies, vibration checks and electro-medical research, as well as for audio frequency measurements.



MODEL 350-A ULTRA-LOW FREQUENCY REJECTION FILTER

variable from **0.02 to 2,000 cps.**

FEATURING

1. ADJUSTABLE CENTER FREQUENCY AND BAND WIDTH • 2. BAND REJECTION OR SHARP NULL FILTERING • 3. 24 DB/OCTAVE SLOPE • 4. CORNER FREQUENCY PEAKING • 5. LOW INTERNAL NOISE

DESCRIPTION: Provides either a rejection band in which the gain falls at a rate of 24 db/octave or a sharp single frequency null. Especially useful for vibration studies, for electro-medical research, and for geophysical and ac servo instrumentation.

SPECIFICATIONS:

BAND WIDTH: Sharp null, or continuously variable to maximum width, from 0.02 to 2,000 cps.

FREQUENCY RANGE: High and low cut-off frequencies independent, from 0.02 to 2,000 cps.

NULL: Continuous from 0.1 to 500 cps.

SLOPE: 24 db/octave with peaking at cut-off frequencies.

INTERNAL NOISE: Less than 100 microvolts.



MODEL 330-A ULTRA-LOW FREQUENCY BAND-PASS FILTER

variable from **0.02 to 2,000 cps.**

FEATURING

1. ADJUSTABLE CENTER FREQUENCY • 2. ADJUSTABLE BAND WIDTH • 3. UNITY PASS BAND GAIN • 4. 24 DB/OCTAVE SLOPE • 5. CORNER FREQUENCY PEAKING • 6. LOW INTERNAL NOISE

DESCRIPTION: Unity pass band gain and 24 db/octave slope outside the pass band. Both high and low cut-off frequencies independently adjustable from 0.02 to 2,000 cps.

Especially useful for vibration studies, for electro-medical research, and for geophysical and seismological instrumentation.

SPECIFICATIONS:

BAND WIDTH: Variable to maximum width, from 0.02 to 2,000 cps.

FREQUENCY RANGE: High and low cut-off frequencies independent, from 0.02 to 2,000 cps.

SLOPE: 24 db/octave with peaking at cut-off frequencies.

INTERNAL NOISE: Less than 100 microvolts.



MODEL 360-A VARIABLE REJECTION FILTER

20 cps. to 200 kc.

- FEATURING:** 1. ADJUSTABLE CENTER FREQUENCY • 2. ADJUSTABLE BAND WIDTH • 3. BAND REJECTION OR SHARP NULL FILTERING • 4. 24 DB/OCTAVE SLOPE

DESCRIPTION: Provides either a rejection band in which the gain falls at a rate of 24db/octave or a sharp single frequency null. Both the high and low cut-off frequencies are independently adjustable.

Especially useful for any audio or ultra-sonic work requiring selective amplification and for stabilization of ac servos.

SPECIFICATIONS:

BAND WIDTH: Sharp null, or continuously variable to maximum width, covering entire range from 20 cps. to 200 kc.

FREQUENCY RANGE: High and low cut-off frequencies independent, from 20 cps. to 200 kc.

NULL: Continuous from 100 cps. to 50 kc.

SLOPE: 24 db/octave with peaking at cut-off frequencies.



MODEL 310-A VARIABLE BAND-PASS FILTER

20 cps. to 200 kc.

- FEATURING:** 1. ADJUSTABLE CENTER FREQUENCY • 2. ADJUSTABLE BAND WIDTH • 3. UNITY PASS BAND GAIN • 4. 24 DB/OCTAVE SLOPE • 5. CORNER FREQUENCY PEAKING

DESCRIPTION: Unity pass band gain and 24 db/octave slope outside the pass band. Both high and low cut-off frequencies are independently adjustable from 20 cps. to 200 kc. Especially useful in audio and ultra-sonic frequency range for noise measurements, for harmonic and frequency analysis of audio instruments and for psycho-acoustics, and electro-medical research.

SPECIFICATIONS:

BAND WIDTH: Variable to maximum width from 20 cps. to 200 kc.

FREQUENCY RANGE: High and low cut-off frequencies independent, from 20 cps. to 200 kc.

SLOPE: 24 db/octave with peaking at cut-off frequencies.



KROHN-HITE INSTRUMENT COMPANY
580 MASSACHUSETTS AVE.
CAMBRIDGE 39, MASS., U.S.A.

Franklin's

MINIATURE SOCKET

PATENT NO. 2,109,770—MARCH 1938

- THE IDEAL CONTACT FOR OCTAL AND MINIATURE TUBE SOCKETS
- GREATER SPRING RESILIENCY. VERY LOW CONTACT RESISTANCE
- STRAIGHT WIPING SURFACES
- POSITIVE ELECTRICAL CONTACT UNDER EXTREME CONDITIONS

Universally used in octal sockets, the Franklin patented "kidney bean" contact has shown such great value that early standardization for miniature sockets can readily be expected.

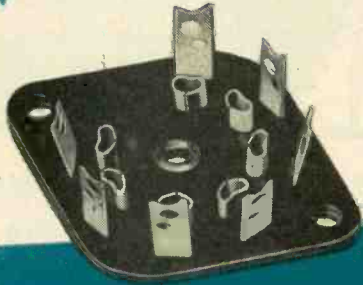

**THIS PATENTED
FEATURE ASSURES
BEST PERFORMANCE
ON ALL SOCKET
CONTACTS**

Laminated wafers, punched with precision tools and available in either x, xx, xxx or x2b for high voltage breakdown and high leakage resistance. The patented contacts, providing full floating, self-aligning bow action, are made of special temper brass, phosphor bronze or beryllium copper, cadmium or silver plated for easy soldering. Rugged and dependable, these sockets may be wax impregnated.

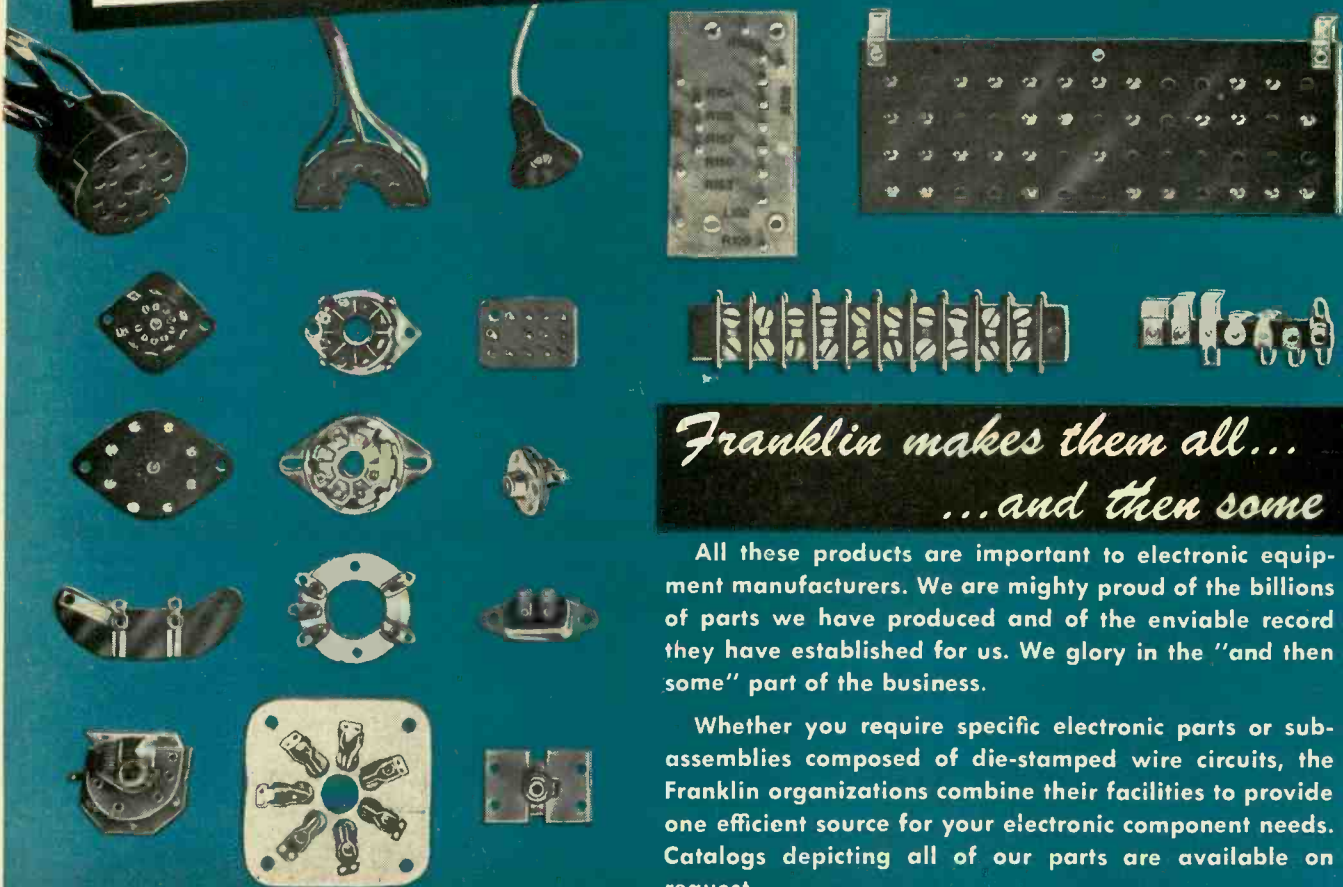

*Franklin makes them all...
...and then some*

All these products are important to electronic equipment manufacturers. We are mighty proud of the billions of parts we have produced and of the enviable record they have established for us. We glory in the "and then some" part of the business.

Whether you require specific electronic parts or sub-assemblies composed of die-stamped wire circuits, the Franklin organizations combine their facilities to provide one efficient source for your electronic component needs. Catalogs depicting all of our parts are available on request.

ELECTRONIC
COMPONENTS



A. W. FRANKLIN MFG. CORP.

43-20 34th STREET · LONG ISLAND CITY 1, NEW YORK

WHAT DIE-STAMPED CIRCUITS CAN MEAN TO YOUR PRODUCTS

Stamping circuits by means of dies has decided advantages over the conventional methods of circuit production. The DIE-STAMPING method consists of a single stamping operation that permanently bonds a complete electronic circuit to a sheet of insulating material, including inductances, capacitance and contacts.

Franklin Airloop Corporation invites you to check the following benefits that flow from use of this technique.

LOW COST PRODUCTION. The manual labor in circuit making is almost entirely eliminated. Complete mechanization of component assembly becomes a reality.

REDUCTION IN WEIGHT AND SIZE OF PRODUCT. Stamped circuits can be made paper thin and in miniature proportions.

BETTER QUALITY CONTROL. With the elimination of soldering in whole or in part, many types of assembly faults are avoided. The inherent perfection of die stamping assures circuit uniformity.

There is an application for the Franklin process in the electronic equipment you produce. At your request a Franklin engineer will survey your operation and give you facts and figures on what this technique can do for you. A booklet describing this process and present applications can be obtained by writing on your company letterhead. There is no obligation.

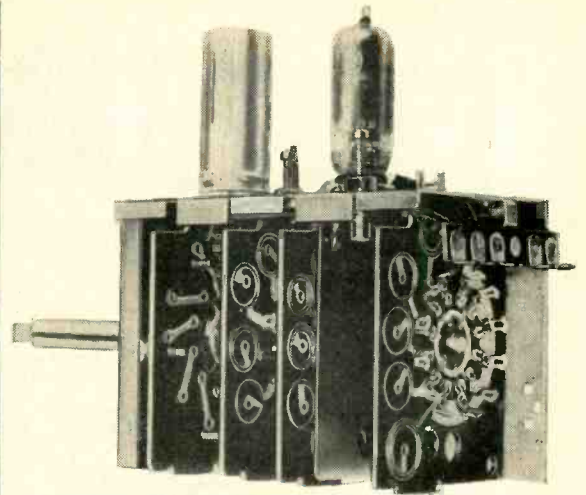

FRANKLIN DIE-STAMPED TELEVISION TUNER

The die-stamping method used to produce this Franklin circuit television tuner provides high quality with absolute uniformity in a low cost tuner. Available with frequency outputs of 21.25 to 25.75 and 41.25 to 45.75 megacycles. Among the products under development in the Franklin laboratory is a stamped, continuous tuner and a stamped ultra high frequency tuner for the upper video channels.

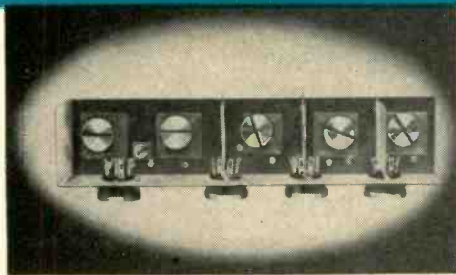

FRANKLIN TELEVISION I-F AMPLIFIER

Use of this precision die-stamped 44 mc i-f amplifier assures television receiver manufacturers that their sets will give high gain, immunity to noise impulses, good selectivity and symmetry of response . . . all at low cost. Designed for use with the Franklin Die Stamped Tuner, this packaged unit is compact, easily accessible for adjustment and effects considerable savings in space. Available with or without the Franklin Stamped Tuner.



FRANKLIN AIRLOOPS

Standard equipment with the radio set builders, Franklin Airloops provide clear dependable reception in over 5,000,000 homes. Here is another example of the great economies made possible by the Franklin stamping method.

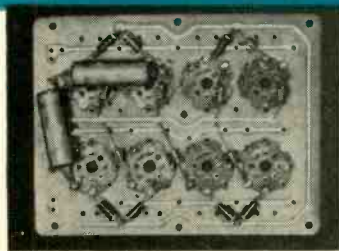

This typical commercial application of the patented Franklin Die-Stamping Process is an 8 channel d-c amplifier built for the International Business Machines Corporation.

Many advantages obtained through the use of Franklin's remarkable stamping technique are:

Elimination of terminal boards, strips, wire insulation, expensive screw machine products, hardware, etc.

Zero tolerance r-f inductances! • Absolute wiring uniformity! • Dependability! • Reduced production cost! • Decreased maintenance! • Reduction of assembling time!

Here is an example of coordinated facilities; the sockets and components being supplied by the A. W. Franklin Manufacturing Corp. and the Franklin Airloop Corporation providing the stamped circuit.

OTHER APPLICATIONS OF THE FRANKLIN DIE-STAMPING TECHNIQUE

Among far reaching developments which enhance the possible applications of the Franklin circuit stamping process are miniaturized conductors (.012 inch wide with .010 inch spacing to adjacent conductors), use of thermo-setting adhesives in conjunction with melamine and silicone impregnated fiber glass base material for withstanding extremes of humidity, temperature, vibration, mechanical and thermal shock. Such stampings guarantee adherence far beyond military requirements.

Connections of subminiature tubes by various soldering techniques or socketing of subminiatures permitting ready removal, is simply accomplished with stamped circuits.

FRANKLIN CORPORATION

43-20—34th ST., LONG ISLAND CITY 1, N. Y.

CHATHAM

ELECTRONIC TUBES and EQUIPMENT

**TUBES LISTED ON THIS PAGE CAN BE
SUPPLIED DIRECT FROM STOCK — MOST OF THESE
TUBES ARE TO JAN SPECIFICATIONS**

Many other types are also available for immediate delivery. Write for the completely illustrated catalog today. CHATHAM also designs, develops and manufactures special tubes to exact customer specification. Inquiries regarding this service are invited.

RUGGEDIZED TUBES

2050W
2D21W

5R4WGY
6AL5W

OD3W
OC3W

25Z6WGT
6H6WGT

HYDROGEN THYRATRONS

VC1257

VC1258

VC1754

VC1907

CONVENTIONAL TUBES

3B28
4B32

395A
1Z2

BS101
338A

1B46
323B

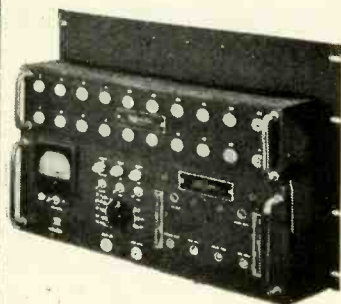

● Pulse life test equipment built by CHATHAM checks receiver type tubes under pulse operating conditions.

CUSTOM BUILT ELECTRONIC EQUIPMENT

CHATHAM specializes in the development, design, and construction of custom-built electronic equipment to exactly meet customers' requirements. Our capable staff of engineers will furnish prompt estimates or, if desired, will call to discuss your problem personally. Call or write today for complete information.

Write today for the informative CHATHAM catalog. For free copy address requests on company letterhead — no obligation.

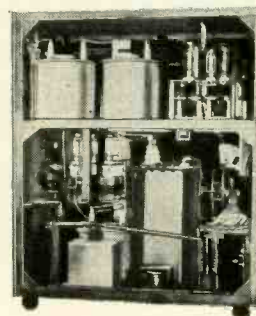

● 5 Megawatts radar modulator built by CHATHAM to rigid government standards.



CHATHAM ELECTRONICS • INC

475 WASHINGTON STREET, NEWARK 2, NEW JERSEY

THERE'S AN ILLINOIS CONDENSER OF
Time Tested Quality
FOR EVERY ELECTRONIC APPLICATION

Seventeen years of successful production experience, making millions of quality capacitors, has created this complete, outstanding line.

This engineering and manufacturing experience has enabled ILLINOIS CONDENSER COMPANY to meet every demand for new capacitor types, whether for peace or defense applications, with components of exceptional value and dependability.

Illustrated are but a few of the many capacitor types now manufactured by ILLINOIS CONDENSER. There is a guaranteed ILLINOIS Condenser for every electronic application. Whatever your requirement—specify ILLINOIS CONDENSER. Benefit by the years of engineering and manufacturing experience behind these condensers of "Time Tested Quality".

IHT This popular pigtail type in aluminum can features internal riveted construction that assures immunity to shock and vibration. Available with or without outer cardboard insulating sleeve, with brass-tinned wire leads or solder lugs in capacity ranges from 1 to 2,000 MFD and from 3 to 700 W.V.D.C.

IHC Ideal for replacement or original equipment, this type has flexible wire leads, is sealed with high temperature compound; has electrolytic grade cardboard tubes and has radial or tangential clamps attached. Supplied in common negative, four section types or dual negatives with separate cathodes. Available in capacity ranges from 25 to 250 MFD and from 5 to 500 W.V.D.C.

LN Has screw neck type mounting, extruded aluminum cans and is available in 1" to 1½" diameters. Capacity ranges from 8 to 80 MFD and from 450 to 600 W.V.D.C.

UMP Ideal for communication, radio and TV. Standard twist prong mounting. Uses recently developed molded capacitor construction and will operate efficiently under wide temperature ranges. Remains stable under all operating conditions. Available in capacity ranges from 40 to 3,000 MFD and from 10 to 525 W.V.D.C.

BT (Bathtub) Developed for military, fixed and portable communication equipment. Has hermetically sealed, drawn metal case with corrosion resistant finish. Will stand shock and vibration. Fully meets government JAN specifications. Available in any capacity range required and from 25 to 600 W.V.D.C.

PE For use in all communication equipment, fixed and mobile. Plug-in octal base, hermetically sealed. Features new molded through pin design. Available in types to meet all government JAN specifications.

UMT Specifically designed for use in high quality equipment. Complete line meets all government JAN specifications. Hermetically sealed, shock resistant. Newly designed molded capacitor design and terminal construction.

UMS Inverted screw mounting, hermetically sealed. Entire line fully meets all government JAN specifications.

UMC Popular for use in telephone equipment, power factor correction voltage stabilization, high current energy sources, motor starting and other types of phase shifting networks. Available in capacity ranges up to 10,000 MFD and from 5 to 500 W.V.D.C.

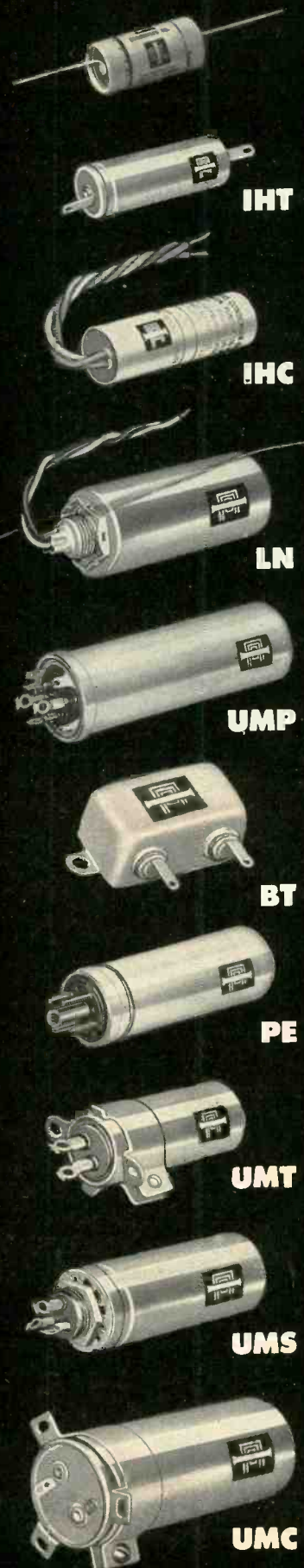

ILLINOIS CONDENSER CO.
 1616 N. THROOP ST., CHICAGO 20, ILLINOIS

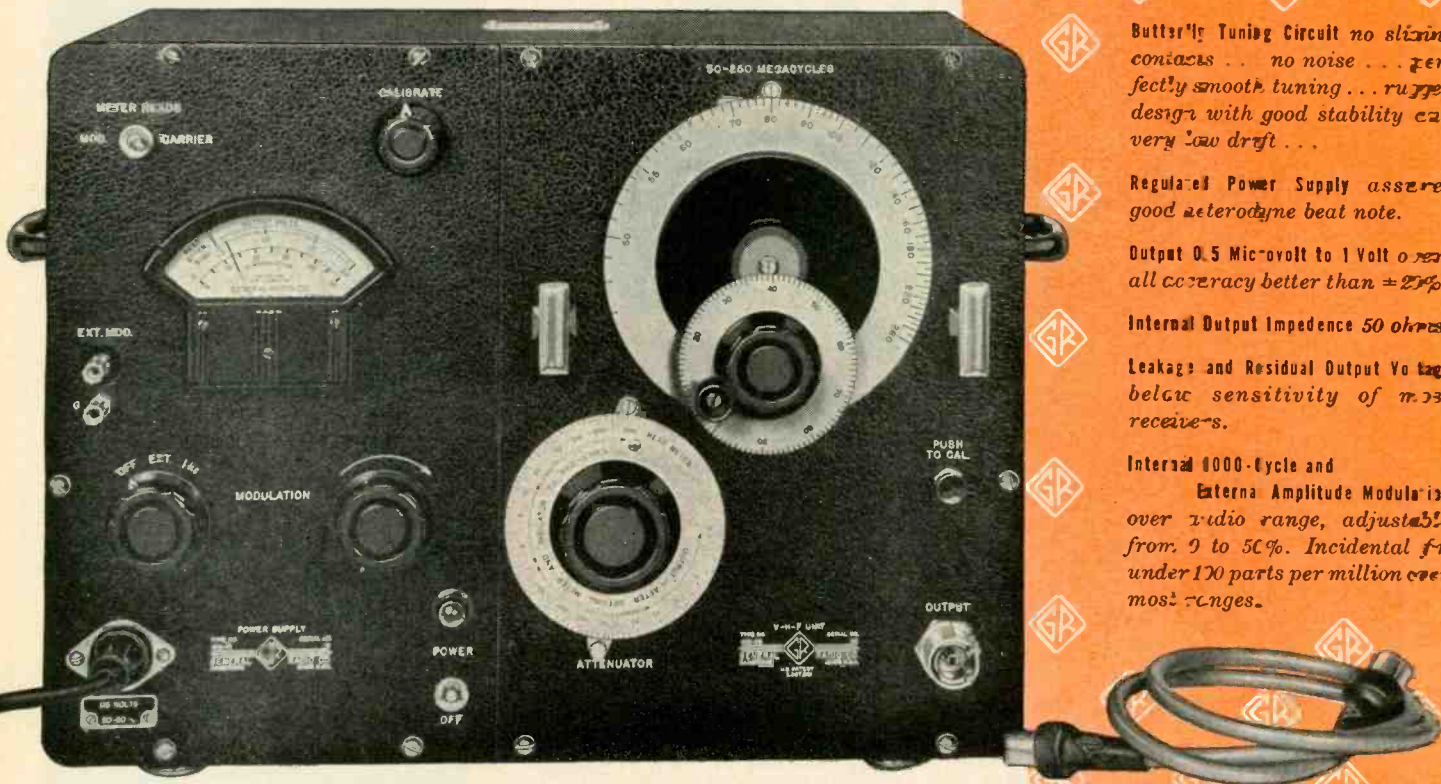

Butterfly Tuning Circuit no sliding contacts... no noise... perfectly smooth tuning... rugged design with good stability and very low drift...

Regulated Power Supply assures good heterodyne beat note.

Output 0.5 Microvolt to 1 Volt overall accuracy better than $\pm 2\%$

Internal Output Impedance 50 ohms.

Leakage and Residual Output Voltage below sensitivity of most receivers.

Internal 1000-Cycle and External Amplitude Modulation over radio range, adjustable from 0 to 50%. Incidental f_n under 100 parts per million over most ranges.

Standard Signal Generator

for Television, V-H-F Video, and U-H-F Channels

50 to 920 Mc.

The General Radio Type 1021-A Standard-Signal Generator operates at frequencies between 50 and 920 Mc with the same convenience and reliability found in other G-R generators in the broadcast frequencies.

Its main use is the determination of radio receiver and circuit characteristics. With an inexpensive diode modulator, television picture modulation can be produced for overall testing of television receivers.

It is a convenient and well-shielded source of power for measurements with bridges, imped-

ance comparators, and slotted lines. For these uses internal modulation is provided.

With the G-R Type 874 line of Coaxial Elements, this generator provides a very complete and flexible system for measurements of voltage, power and standing-wave ratio from 50 to 920 Mc.

Two separate oscillators are available. They are mechanically and electrically interchangeable and are sold as separate units to convert the range of one standard signal generator to that of the other.

To cover the complete range of 50 to 920 Mc., the following units are required
 Type 1021-P1 Power Supply, Type 1021-P2 U-H-F Oscillator (250-920) Mc and
 Type 1021-P3 V-H-F Oscillator (50-250 Mc.) - Total Price . . . \$1015.00
 Type 1021-AV V-H-F Standard-Signal Generator (50-250 Mc) . . . \$595.00
 Type 1021-AJ U-H-F Standard-Signal Generator (250-920 Mc) . . . \$615.00

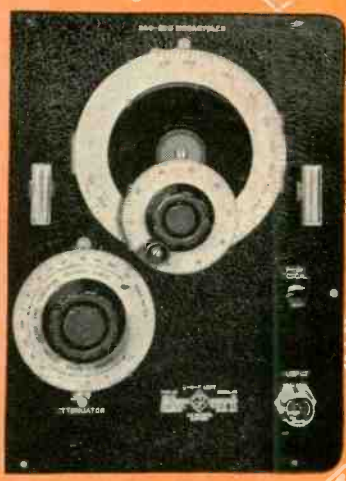

Type 1021-P1 Power Supply and 1000 cycle modulation source . . . \$125.00
 Type 1021-P2 U-H-F Oscillator Unit only (250-920 Mc.) . . . \$520.00
 Type 1021-P3 V-H-F Oscillator Unit only (50-250 Mc.) . . . \$370.00



GENERAL RADIO Company

275 Massachusetts Avenue, Cambridge 39, Mass.

for Bridge and Slotted Line Measurements

High output voltage of one volt across 50 ohms makes possible measurements over high noise levels. Filter characteristics may be taken over wider frequency ranges for given noise level.

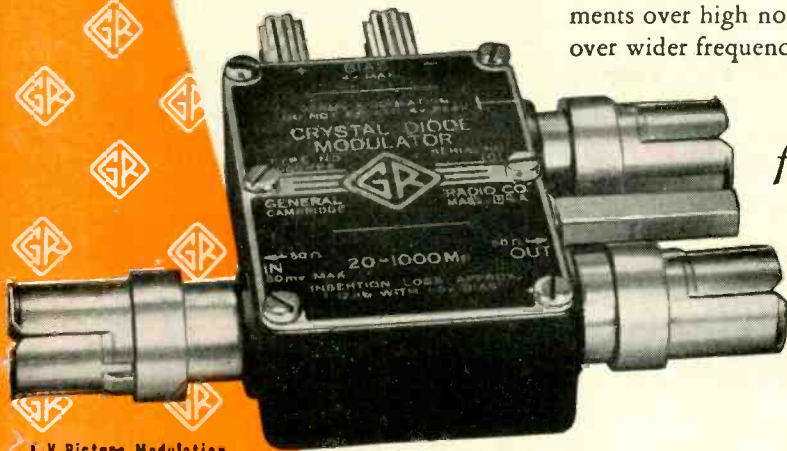

for Pulse Modulation

and for T-V picture modulation, the Type 1000-P6 Crystal Diode Modulator provides the means to obtain it with *no* accompanying frequency modulation. Plugs into Signal Generator output externally. Video or pulse modulation is applied from any convenient source. Note these characteristics in charts below.

I-V Picture Modulation
on all Channels

Type 1000-P6
Crystal Diode Modulator — \$35.00

from 50 to 920 Mc with *no* incidental FM, when Type 1000-P-6 Crystal-Diode Modulator and source of video signals are used. The power requirements for modulation are so low, video output from a standard T-V receiver can be used.

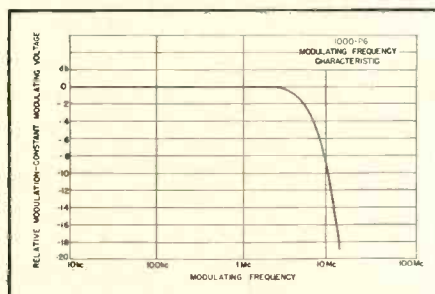
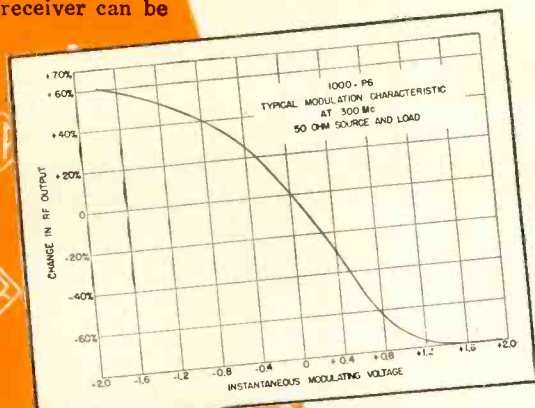

above Typical Modulation Characteristic at 300 Mc. Up to 30% modulation there is no significant difference in characteristic from 20 to 1000 Mc.

at left Frequency Characteristic of Type 1000-P6 Diode Modulator.

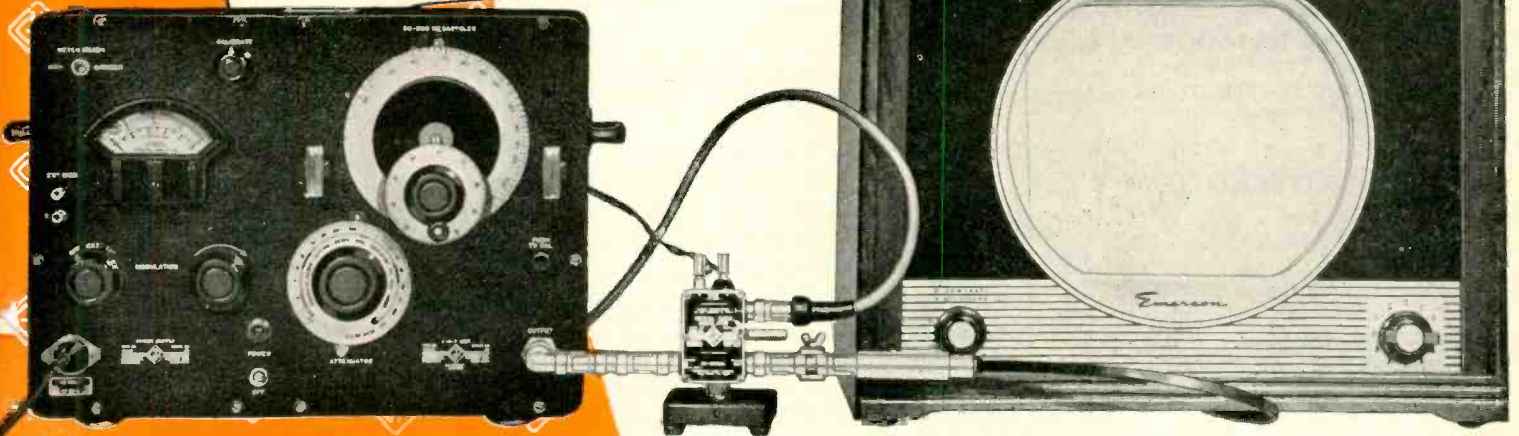

Type 1021-AV V-H-F Standard-Signal generator with Type 1000-P6 Crystal Diode Modulator, set up for tests on a television receiver.

90 West Street NEW YORK
920 S. Michigan Ave. CHICAGO
1000 N. Seward St. LOS ANGELES

Since 1915 — Designers and Manufacturers of Electronic Test Equipment
STROBOSCOPES • VARIACS • SOUND-LEVEL METERS • VIBRATION METERS

IMPEDANCE BRIDGES • SIGNAL GENERATORS • OSCILLATORS • WAVE ANALYZERS • DISTORTION METERS • IMPEDANCE STANDARDS • VACUUM-TUBE VOLTMETERS • FREQUENCY STANDARDS • BROADCAST MONITORS • PARTS AND ACCESSORIES

LOOK TO PRINTED CIRCUITS

AND
PRINTED CIRCUIT
MATERIALS

OO FOR BETTER DEFENSE PRODUCTS
OO FOR ABUNDANT CIVILIAN PRODUCTS

A New Answer to Problems in
DESIGN • COST • WEIGHT • SPACE

FOR EXAMPLE

Could you buy one million ¼-watt resistors for fifteen dollars? It has been done with Micropaint, and the entire million resistors weighed about one pound after application.

• • • •

Characteristics of SILVER and RESISTANCE types

APPLICATION: Brushing, dipping, spraying, silk screening.

TYPES: Air drying, baking, firing.

RESISTANCE VALUES: From conductors to insulators.

SILVER TYPES: Hundredths of an ohm per square and up.

RESISTOR TYPES: Some stock values are 125 ohms, 500 ohms, 12,500 ohms, 0.313 megohms, and 3.13 megohms per square.

RESISTANCE TOLERANCE: As close as 5 per cent if necessary.

OPERATING TEMPERATURE: As high as 500° F. continuous.

• • • •

LITERATURE

Here Is The Story	Free
Industrial Electronic Coatings	Free
Printed Circuit Design Outline	Free
SC11 and SC12 Silver Micropaints	Free
SCT-Series Silver Micropaints	Free
Aircraft Anti-Static Paints	Free
Shielding Paints Summary	Free
Resistor Paints Summary	Free
Printed Circuit Techniques (National Bureau of Standards)	Postpaid—32c

FOR EXAMPLE

Do you have a control circuit or meter circuit requiring resistors with special resistance-temperature characteristics (negative, flat, positive, or unusual combination)?

• • • •

SOME BASIC USES:

- METER SHIELDS
 - TV TUBE COATING¹
 - FUSE BLOCK PARTS
 - STABLE RESISTORS
 - CIRCUIT SHIELDING
 - CONDUCTING CEMENT
 - PRINTED CIRCUIT WIRING
 - LAMP SOCKETS & BASES
 - CRYSTAL HOLDER PARTS
 - ELECTROPLATING BASE²
 - VACUUM TUBE SHIELDS³
 - DE-ICING ELEMENTS⁴
 - AIRCRAFT Anti-Static COATINGS⁵
1. For the new electrostatic tube.
 2. Exceptional hardness and adhesion.
 3. The only answer for subminiatures.
 4. Terminals and heating elements.
 5. Optimum Bureau of Aeronautics resistance for antenna housings on military aircraft.

• • • •

FOR RESEARCH DEVELOPMENT EXPERIMENTATION

Order the S21 Kit of five air-drying silver, copper, and resistance paints (covering the resistance range of 0.05 ohm to 2.5 megohms per square); plus solvent, lacquer, and design manual. \$7.27 postpaid in U.S.A. or from your distributor.

EVERY INDUSTRIAL AND
COLLEGE LABORATORY
SHOULD HAVE ONE.

MICRO-CIRCUITS CO.

Industrial Coatings Dept.
NEW BUFFALO, MICHIGAN

Make BETTER
Soldering EASIER

VULCAN ELECTRIC SOLDERING TOOLS

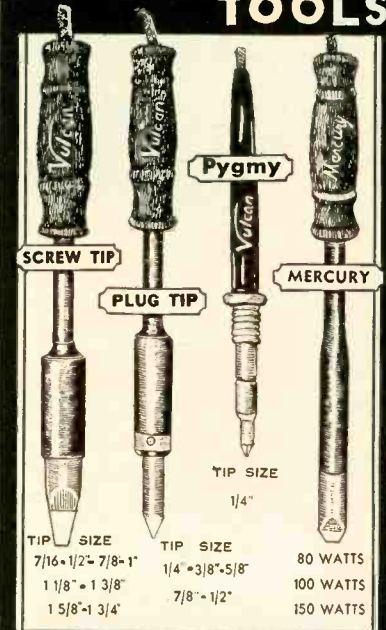

ELECTRIC HEATING ELEMENTS

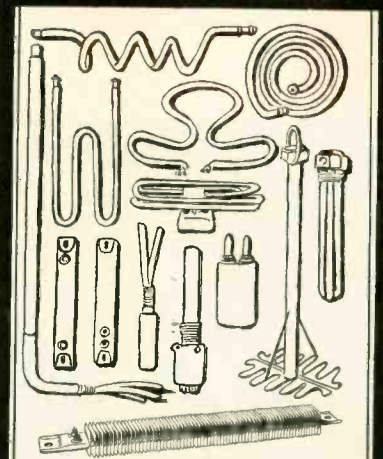

Tubular • Cartridge
Flat • Immersion • Band

VULCAN
ELECTRIC COMPANY
DANVERS 101 MASS.



How LORD MOUNTINGS improve product performance



MULTIPLANE MOUNTINGS—

isolate vibration from all directions. Light in weight, small in size, they are widely used to mount electronic units.



PLATE FORM MOUNTINGS—

Standard— isolate steady vibration. Stable, compact— easily installed. Loads $\frac{1}{2}$ to 120 pounds per mount.



PLATE FORM VERTICAL SNUBBING MOUNTINGS—

isolate steady vibration plus severe shock. Loads up to 610 pounds per mount.



METER MOUNTINGS—

protect small meters and instruments from destructive vibration. One piece construction, easily installed . . . many sizes for most commonly used models.

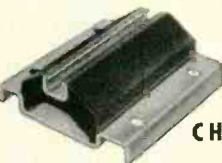

CHAN-L-MOUNTS—

Ready to use—easy to install. Isolate steady vibration and occasional shock. Extremely soft and sturdy, they give superior isolation.



*TEMPROOF MOUNTINGS—

For Airborne Electronic Equipment

- Designed for use with JAN-C-172A cases.
- Exceed AN-E-19 drop test requirements.
- Maintain efficiency from -80° to $+250^{\circ}$ F.

*Temperature-proof



TUBE FORM MOUNTINGS—

Standard—for steady vibration and severe shock. Have great radial stability. Loads from $\frac{1}{2}$ to several thousand pounds.



TUBE FORM VERTICAL SNUBBING MOUNTINGS—

isolate steady vibration . . . cushion shock. Good for mobile equipment.



F.H.P. FLEXIBLE COUPLINGS—

have exceptional torsional flexibility . . . accommodate parallel and angular misalignment. Ratings from $\frac{1}{5}$ to 1 hp.



RADIOFOCAL MOUNTING BASES—

Maximum Protection for Airborne Equipment

- Insure protection at steep inclinations.
- Dampers prevent excessive motion.
- Equipment does not sag or droop.
- Made to fit JAN-C-172A cases.



IF YOU SUPPLY EQUIPMENT TO THE ARMED FORCES . . .

Lord engineers will assist you to select the type of shock and vibration protection which meets the requirements of applicable specifications. As the major supplier of flexible mountings during World War II, Lord's knowledge and experience will enable you to supply approved equipment protection which is economical, efficient and easily installed.

LORD MANUFACTURING COMPANY, ERIE, PA.

New York • Philadelphia • Washington • Dallas • Dayton • Detroit • Los Angeles • Chicago

which of these

famous PRESTO instruments meets your precision recording needs?

disc recorders



PRESTO STUDIO CONSOLE 8 D-G

A precision instrument, custom-built to the very highest specifications. Dual motor, direct gear drive: 78 and 33 $\frac{1}{3}$ rpm, without deviation. 1-D cutting head (response to 10,000 cps.) Seven feed platters inside-out and outside-in.



PRESTO PORTABLE 6-N

World's most popular portable disc recorder... also available in cabinet for economical studio use. Equipped with 1-D cutting head. Cutting speeds 78 and 33 $\frac{1}{3}$ rpm. Microgroove available at additional cost.



PRESTO TRANSCRIPTION TURNTABLE 64-A

Broadcasters' preference because of ease of operation and low maintenance. Direct gear drive from dual motors at 78 and 33 $\frac{1}{3}$ rpm. Full speed reached within $\frac{1}{8}$ revolution. Low mechanical disturbance, maximum speed accuracy.

PRESTO PORTABLE 90-B

Recommended amplifier for the 6-N recorder. Portable, but with high fidelity studio performance. Three pre-amps, mixer, master gain control and recording amplifier. High and low frequency equalizers. Response to 15,000 cps.

PRESTO 97-B

One of the most popular recording amplifiers for rack mounting. Power: 60 watts. Frequency response: 20 to 17,000 cps. within 1 db. Four push-buttons to select recording characteristics. Chassis vertically mounted. Front panel removable.



recording amplifiers

tape recorders



PRESTO COMMUNICATIONS TAPE ASSEMBLY

Complete monitoring unit. Ideal for air traffic control, police radio and other communication systems. Operates at tape speed of 1 1/2" per second. Can record continuously up to 8 hours. Unit consists of 2 tape transport mechanisms, 2 amplifiers, switch and relay panel, speaker panel.

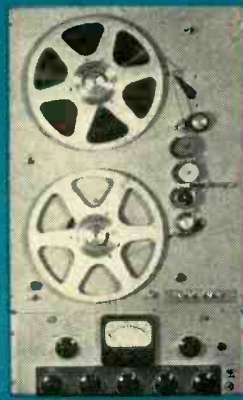

PRESTO RACK MODEL RC-10/74

Unsurpassed recorder for rack mounting. Three magnetic heads; push-button controls; response up to 15,000 cps. 3-panel size 19" x 24 1/2"; accommodates 10 1/2" reels. Shown with 900-A2 amplifier. Also available in console unit.



PRESTO STUDIO CONSOLE SR-950

Precision tape recorder... finest available at any price. Three motors; three separate heads for recording, playback and erasing; two speeds; push-button control. All parts readily accessible.

PRESTO TAPE REPRODUCER TL-10

New and revolutionary low-cost method of tape reproduction. Fits on any standard 16" turntable. Turntable acts as motor. Speed of 7 1/2" and 15" per second. Response to 15,000 cps. Plugs into studio speech input equipment.



PRESTO PORTABLE RC-10/14

Portable version of the RC-10/24 with smaller panel size (19" x 14") and rotary switch selector. Weighs only 68 lbs. Superb audio quality, speed control and reliability.

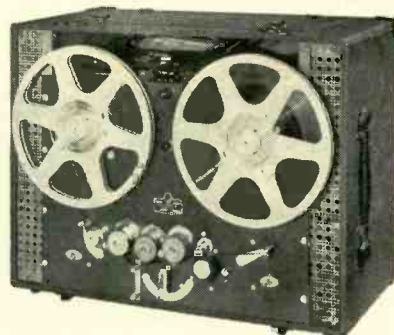

PRESTO PORTABLE PT-920

Newest member of the PRESTO tape family; successor to the famous PT-900, but greatly improved. Three motors. No friction clutch or tension adjustments. Fast forward and rewind speeds. Instantaneous monitoring from the tape. One case contains 10 watt amplifier, two speakers and power supply.



Here are eleven of the most popular, most-wanted units in PRESTO's complete line of professional recording equipment. Each is precision designed to combine faithful sound reproduction with long, dependable service and simple maintenance. Write direct or contact the PRESTO distributor in your community for additional data, or for assistance in meeting your specialized requirements.

PRESTO RECORDING CORPORATION

PARAMUS, NEW JERSEY

Export Division: 25 Warren St., New York 7, N. Y.

Canadian Division: Walter P. Downs, Ltd., Dominion Square Bldg., Montreal

WORLD'S LARGEST MANUFACTURER OF PRECISION RECORDING EQUIPMENT AND DISCS

VOLTAGE REGULATED POWER SUPPLIES

For Industrial and Research Use

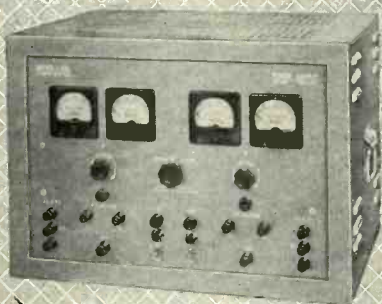

MODEL 510

Model 510 features TWO COMPLETELY INDEPENDENT REGULATED POWER SUPPLIES OUTPUT DC FOR EACH SUPPLY.

REGULATION: 200-500 volts, 200 Ma.

1/2% for both line and load variations.

RIPPLE: 5 millivolts.

OUTPUT AC FOR EACH SUPPLY:

6.3 volts, 6 Amp., CT.

The supplies may be connected for series, parallel, or bucking operation.



MODEL 800

Model 800 features TWO INDEPENDENT REGULATED POWER SUPPLIES OUTPUT DC FOR EACH SUPPLY:

0-600 volts, 200 Ma. in parallel 400 Ma.

REGULATION:

1/2% for both line and load variations.

RIPPLE: 5 millivolts.

OUTPUT AC FOR EACH SUPPLY:

6.3 volts, 10 Amp., CT.

REGULATION 0.1%
KEPCO LABORATORIES manufactures on special order high quality, extremely well regulated Power Supplies. Let us quote on your special requirements.

MODEL 815

B SUPPLY: 0-600 volts, 200 Ma.

REGULATION: 1/2% for both line and load variations.

RIPPLE: 5 millivolts.

C SUPPLY: 0-150 volts, 5 Ma.

REGULATION: 10 millivolts for line 105-125 volts. 1/2% for load at 150 volts.

RIPPLE: 5 millivolts.

FILAMENT SUPPLY: 6.3 volts AC, 10 Amp., CT



MODEL 315

B SUPPLY: 0-300 volts, 150 Ma.

REGULATION: 1/2% for both line and load variations.

RIPPLE: 5 millivolts.

C SUPPLY: 0-150 volts, 5 Ma.

REGULATION: 10 millivolts for line 105-125 volts.

1/2% for load at 150 volts.

RIPPLE: 5 millivolts.

FILAMENT SUPPLY: 6.3 volts AC, 5 Amp., CT.

Available with Rack Mounting

MODEL 500-R

OUTPUT DC: 0-500 volts, 300 Ma.

REGULATION: 1/2% for both line and load variations.

RIPPLE: 10 millivolts.

OUTPUT AC: 6.3 volts, 10 Amp., CT.

Model 615 is the Model 500-R plus C supply



MODEL 245

OUTPUT DC: 200-500 volts, 200 Ma.

REGULATION: 1/2% for both line and load variations.

RIPPLE VOLTAGE: 5 millivolts.

OUTPUT AC: 6.3 volts, 6 Amp., CT.

Available with Rack Mounting

MANUFACTURERS OF ELECTRONIC EQUIPMENT • RESEARCH • DEVELOPMENT



KEPCO

LABORATORIES, INC.

149-14 41st AVENUE • FLUSHING, N. Y.

FOR SPECIFICATIONS ON OUR COMPLETE LINE OF POWER SUPPLIES-WRITE DEPT. P

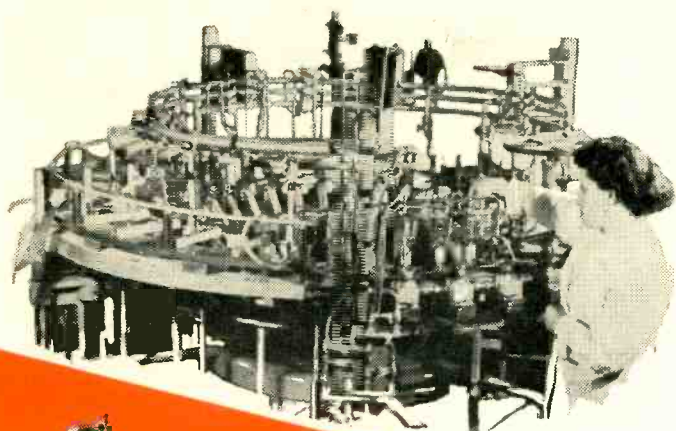

This 32-head exhaust unit, shown at the left, is one of the many specially designed machines used by Haydu Brothers to insure the high vacuum of all small tubes at high production rates. Stage-tests at intervals throughout production guarantee complete *quality control!*

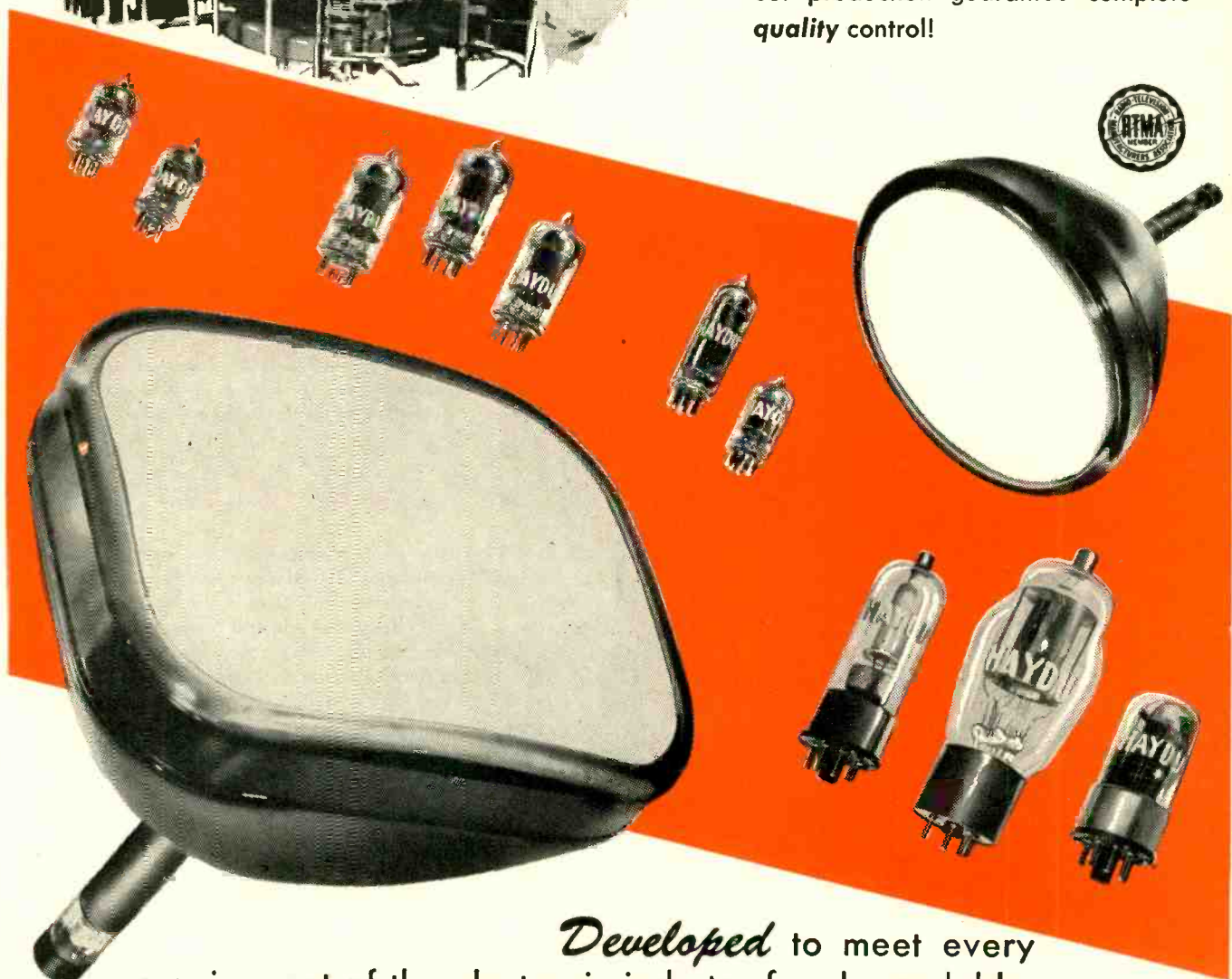

Developed to meet every requirement of the electronic industry for dependable, high-performance vacuum tubes.

Built to exacting standards of precision using the latest production equipment.



Guaranteed by the name...

HAYDU
BROTHERS
 PLAINFIELD, NEW JERSEY



PRODUCED BY THE MILLIONS

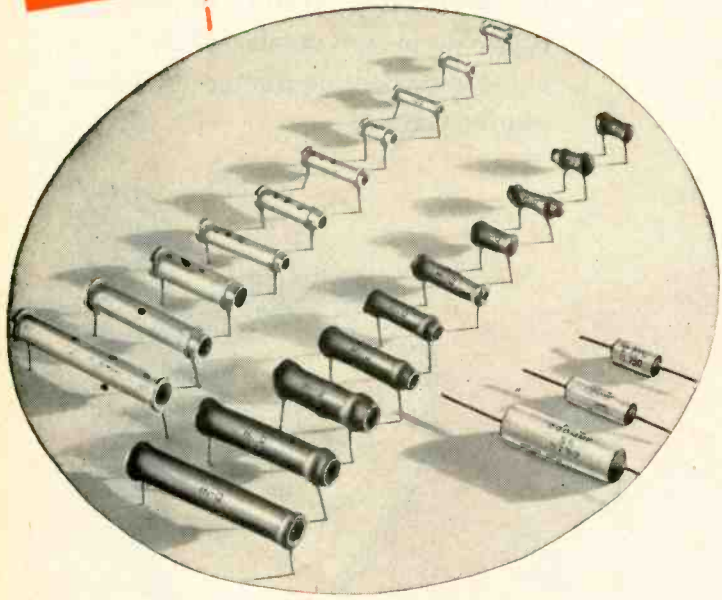

Hi-Q BC TUBULAR CERAMIC CAPACITORS

For coupling, by-passing and filtering where frequency control is not a critical parameter. Readily replace mica and paper condensers of corresponding value. (Not to be confused with Hi-Q close tolerance, temperature compensating units.) Available in capacity ranges from 5 mmf. to 33,000 mmf.

Hi-Q TEMPERATURE COMPENSATING CAPACITORS

Tubular ceramic construction with pure silver electrodes precision coated. Capacities from .25 mmf. to 1830 mmf. and a temperature coefficient range from P 100 to N 1400.

Insulation: Both Hi-Q BC Tubular and Hi-Q Temperature Compensating Capacitors are available with any of three types of insulation:—Clear non-hydroscopic styrene coating (CN) . . . Durez impregnated with low-loss microcrystalline wax (SI) . . . or a ceramic (Steatite) cover tube sealed with a specially developed end seal where applicable (CI).

Hi-Q STAND-OFF CAPACITORS

Basically, these are tubular units with a screw fixture for mounting to chassis or common ground. Type MCS has a ceramic tube enclosed in husky cadmium plated metal case with a specially developed end seal for protection against humidity and temperature changes. Close coupling and their unique construction make them excellent for by-passing RF in the high frequencies. Standard capacity tolerances are $\pm 10\%$, $\pm 20\%$, and GMV for "stand-off" capacitors and -20% , $+ 30\%$, and GMV for multiple tap units. MCS has a capacity of 1500 mmf. ± 500 mmf. All units flash tested for 1000 volts DC, power factor under 3% maximum. Insulation resistance is above 10,000 megohms.

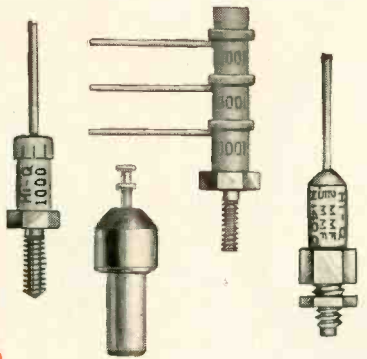

Hi-Q FEED-THRU CAPACITORS

Provide perfect transmission through shields or ground potentials and simultaneously by-pass unwanted frequencies. Extremely rugged to withstand severe vibrations such as those encountered in aircraft, missiles and automotive requirements.

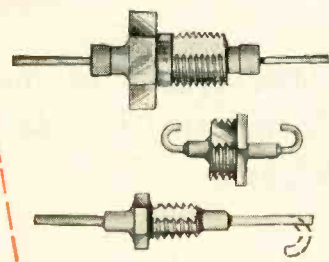

Hi-Q HIGH VOLTAGE TUBULAR CAPACITORS

Available in capacities from 25 mmf. to 250 mmf. Units with working voltage of 3,000 V. D. C. are 1.840" in length and .375" in diameter. Units with working voltages between 500 V. D. C. and 3,000 V. D. C. can be slightly smaller. All are Durez coated and are selected from ceramic bodies having good dielectric characteristics.



Hi-Q COMPONENTS

Capacitors
Trimmers • Choke Coils
Wire Wound Resistors

BETTER 4 WAYS

- ✓ PRECISION
- ✓ UNIFORMITY
- ✓ DEPENDABILITY
- ✓ MINIATURIZATION

*Trade Mark Registered, U. S. Patent Office

— by the top specialists in the ceramic field . . .

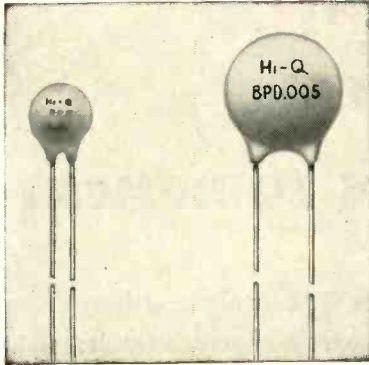

Hi-Q CERAMIC DISK & PLATE CAPACITORS

Hi-Q Disks are high K dielectric by-pass, blocking or coupling capacitors. Multiple capacities may be fabricated on a single disk to eliminate two or more conventional units. Insulated with Durez and high temperature microcrystalline wax for protection against moisture and high humidity. Available in a wide range of capacities and sizes.

Hi-Q Plates are essentially similar to Disks other than in shape. Multiple units do not require a common ground as do Disks and the number of capacities on a plate is limited only by the K of the material and physical size of the unit. Guaranteed minimum capacity values up to 33,000 mmf. per sq. in. are available.

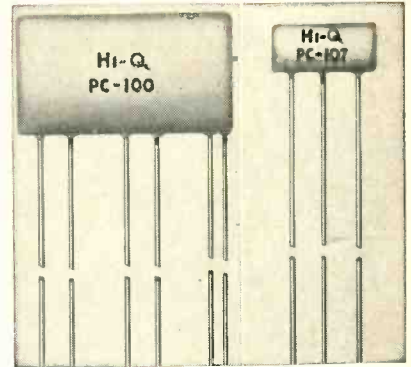

Hi-Q TUBULAR TRIMMERS

Hi-Q Steatite adjustable, high-frequency capacitors are noted for their simplicity of design, mechanical strength and electrical stability. Available in two sizes: 1/2" with two capacity ranges, 0.5 mmf. to 3.0 mmf. and 1.0 mmf. to 4.0 mmf.; and 3/8" with capacity 1.0 mmf. to 6.0 mmf.

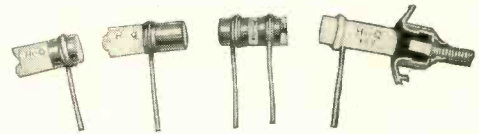

Hi-Q WIRE WOUND RESISTORS



Hi-Q Resistors are made by winding special resistance wire upon a high refractory ceramic core. Element is anchored at each end to copper terminals and silver soldered for good contact. Wattage rated according to dissipation of heat each Hi-Q Resistor will handle without exceeding 300°C (530°F) at its hotspot from a starting ambient temperature not exceeding 40°C (104°F).

Hi-Q NON-INSULATED CHOKE COILS



Hi-Q non-insulated choke coils are a solenoid type of winding on forms moulded from mineral filled moulding material, powdered iron cores, metallic oxides such as titanium, or on a steatite core. Available in many sizes.

Hi-Q INSULATED CHOKES



Available in various values insulated either by a Steatite cover tube or with Durez and high temperature crystalline wax, assuring maximum protection against high humidity and temperature change.

Hi-Q SPECIAL WINDINGS



Available in certain types and combinations of special windings. C and L combinations of capacity and inductance are available in many values.

Write FOR THE HI-Q DATALOG

giving complete details of these and other Hi-Q Components. Please feel free to consult our engineers at any time concerning specific applications. We assure you of complete and fullest cooperation.

JOBBERS — ADDRESS: 740 Belleville Ave., New Bedford, Mass.

*Trade Mark Registered, U.S. Patent Office

Hi-Q*

Electrical Reactance Corp.

OLEAN, N. Y.

SALES OFFICES: New York, Philadelphia, Detroit, Chicago, Los Angeles

PLANTS: Olean, N. Y., Franklinville, N. Y. Jessup, Pa., Myrtle Beach, S. C.

**YOU CAN DO *More*—
DO IT *Better* WITH
GPL TELEVISION EQUIPMENT**

Introduced only last year, this GPL equipment has already received wide industry acceptance for its flexibility, convenience and advanced design features. Developed for easy, attention-free operation, built with watchmaker's precision, the GPL line will do more, do it better, for years of dependable service. Write now for full details . . . act now for early deliveries.

GPL
the
Complete
NEW LINE
for
Studio and Field
that Increases
TV Efficiency

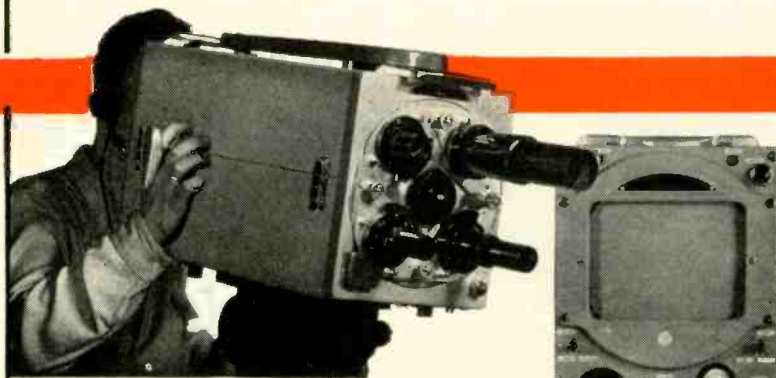

Compact Camera Chain Gives Improved Picture Control

Camera, control unit, power unit make up world's smallest, lightest broadcast chain. Improved picture quality with remote control iris, uniform focus adjustment for all lenses. Remote lens change, focus, pan and tilt also available. Simplified adjustments. Better accessibility. 8½" monitor tube.

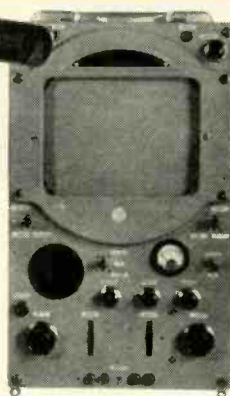

TV CAMERA CHAINS—TV FILM CHAINS
TV FIELD AND STUDIO EQUIPMENT
THEATRE TV EQUIPMENT



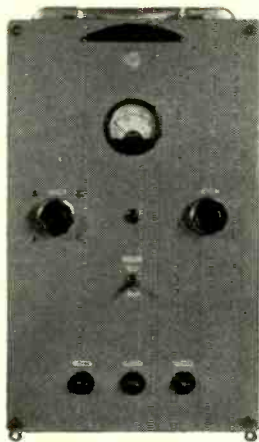

Single-Unit Sync Generator Requires No Adjustment

This unit, complete with power supply, is packaged for field use, may be removed from case for rack mounting. With binary counting circuits and pulse width controlled by delay lines, it provides circuit reliability better than present studio equipment and eliminates operator adjustments.

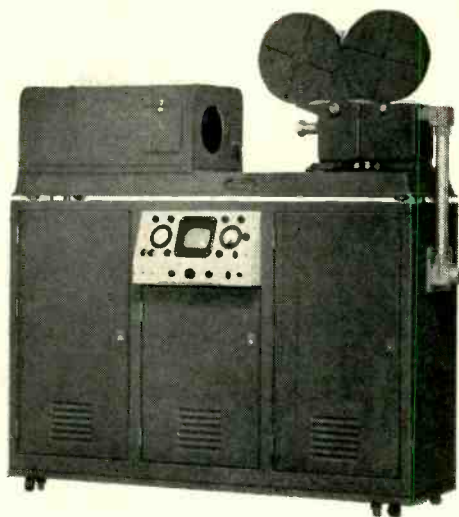

Video Recordings of Live-Program Quality

Precision electronic shutter provides steady interlace and eliminates shutter bar. High-fidelity sound recorded on the film simultaneously. New vacuum gate camera runs continuously without emulsion pile-up. Telecast recording looks and sounds like a live show.

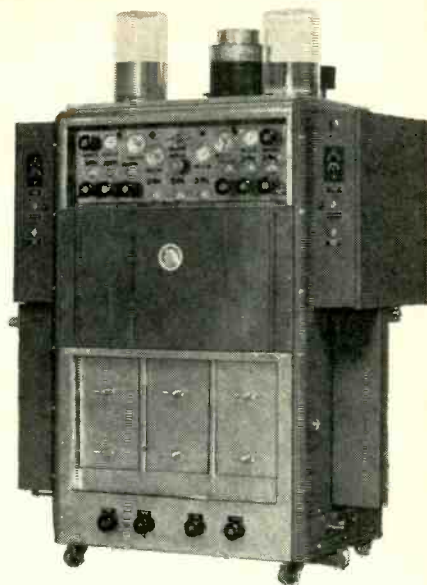

Film Permanently Processed in 40 Seconds

The GPL Rapid Processor develops, rinses, fixes, washes, dries and waxes 16-mm film synchronously as it comes from the Recorder, or its own feed magazine. This facilitates rebroadcasts to other time zones. Operation is fully automatic, gives uniform, highest quality results.

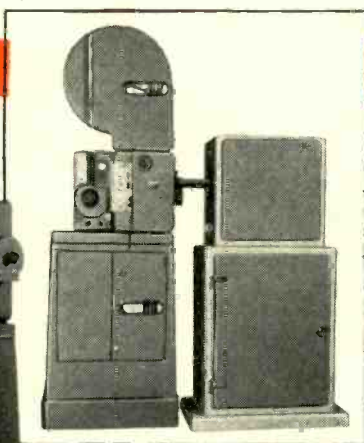
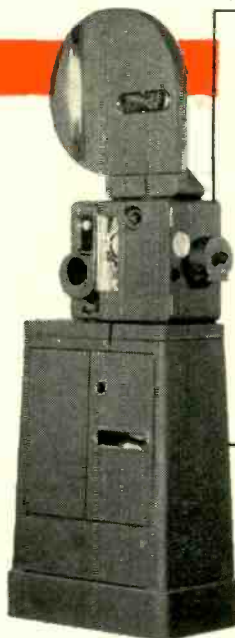

First Professional Sync Projector for 16-mm Film

Designed for TV studio use. Has the reliability of professional 35-mm equipment. Sharper, steadier pictures, finer sound. Uniform illumination, ample light, with 100 foot-candles delivered to camera tube. May be used with any full-storage type film pick-up. Fully enclosed, 4,000 foot film magazine provides for 110 minutes of continuous operation — an entire feature.



New "3-2" Projector Works with Any Image Orthicon Camera

A portable unit of tremendous utility. Used with standard studio or field cameras without special phasing, it makes transmission of motion pictures as simple as stills. Handles film features with results comparable to specialized iconoscope chains. Projects rear-screen effects. Projects commercials to cameras in the field, eliminating expensive studio stand-by facilities. For preview work, its synchronous motor simplifies sound scoring.

General Precision Laboratory

INCORPORATED

PLEASANTVILLE

NEW YORK

WRITE,
WIRE
OR PHONE
FOR DETAILS

CHICAGO OIL IMPREGNATED VACUUM FILLED CAPACITORS



RECTANGULAR TYPE

APPLICATIONS

INDUSTRIAL • TRANSMITTING
POWER FACTOR CORRECTION
MOTOR CAPACITORS
SIGNAL INSTRUMENTS

CHICAGO CONDENSER'S rectangular type capacitors are hermetically sealed and tested at twice-rated voltage.



BATHTUB TYPE

APPLICATIONS

RADIO • INTERFERENCE
MOTORS • ELECTRONICS
SPECIAL TIMMING

CHICAGO CONDENSER'S bathtub type capacitors are hermetically sealed and tested at three-times voltage.

CHICAGO CONDENSER has engineering and plant facilities to meet specialized military requirements.

Drawings and specifications submitted will receive immediate attention.

CHICAGO CONDENSER CORPORATION

General Offices and Factory
3255 WEST ARMITAGE AVENUE
CHICAGO 47, ILLINOIS

FOR YOUR PANEL



A NOVEL and UNIQUE CIRCUIT INDICATOR

DESIGNED FOR NE-51 NEON LAMP

For 110 or 220 volt circuits

The required resistor is
an integral part of this assembly
—“built-in.”

**RUGGED • DEPENDABLE
LOW IN COST**



PATENTED: No. 2,421,321
Cat. No. 521308-997



WILL YOU TRY A SAMPLE?

Write on your company letterhead. We will act at once.
No charge, of course.

SEND FOR THE 192 PAGE HANDBOOK OF PILOT LIGHTS

Among our thousands of Pilot Light Assemblies there is one which will fit your special conditions. Many are especially made and approved for military use. We pride ourselves on prompt deliveries—any quantity.

ASK FOR OUR APPLICATION ENGINEERING SERVICE

Foremost Manufacturer of Pilot Lights

The DIAL LIGHT COMPANY of AMERICA

900 BROADWAY, NEW YORK 3, N. Y. SPRING 7-1300

Sapphire and Glass

JEWEL BEARINGS

Quality controlled



*Serving industry
with fine jewels
since 1913*

Performance proved for precision and long life by world's leading makers of electrical, aircraft and timing instruments; compasses; weather recorders; all testing, indicating and recording apparatus.

Unset or set in screws or bushings to suit requirements. Write for brochure.

Richard H. Bird & Co., Inc.

1 Spruce Street, Waltham, Mass.

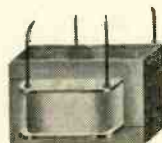

The Key to SUBMINIATURE TRANSFORMER PROBLEMS

DIMENSIONS:..... 7/16" x 3/4" x 5/8"

WEIGHT:..... Less than 1/3 of an ounce

TYPES:..... input, interstage, output, reactor

These transformers fit into the smallest MIL-T-27 Case A.F.

*Prompt Engineering Attention
To Your Subminiature Problems*

UNION ELECTRIC PRODUCTS CO.
24 EDISON PLACE NEWARK 2, N. J.

Keep Up and Ahead -----

WITH

AMPHENOL

PRODUCTS

Request

**CATALOGS — OVER 9,000 ITEMS
CURRENT NEW PRODUCTS
ANNOUNCEMENTS**



CATALOG A-2 — Complete engineering data and listing of Amphenol "AN" connectors for power, signal and control circuits in aircraft and electronic equipment.



CATALOG D-2 — comprehensive engineering details and classification of Amphenol's Radio Frequency cables and connectors.



CATALOG 74 — greatly condensed listing of products in other Amphenol catalogs and complete listing of radio sockets and connectors and Amphenol TV and FM antennas.

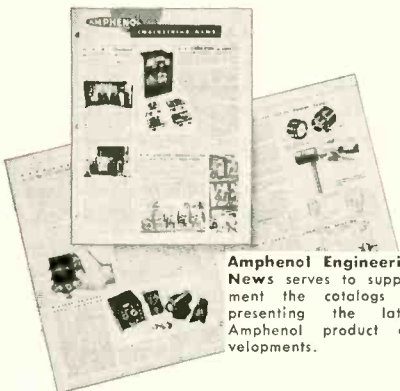

Amphenol Engineering News serves to supplement the catalogs by presenting the latest Amphenol product developments.

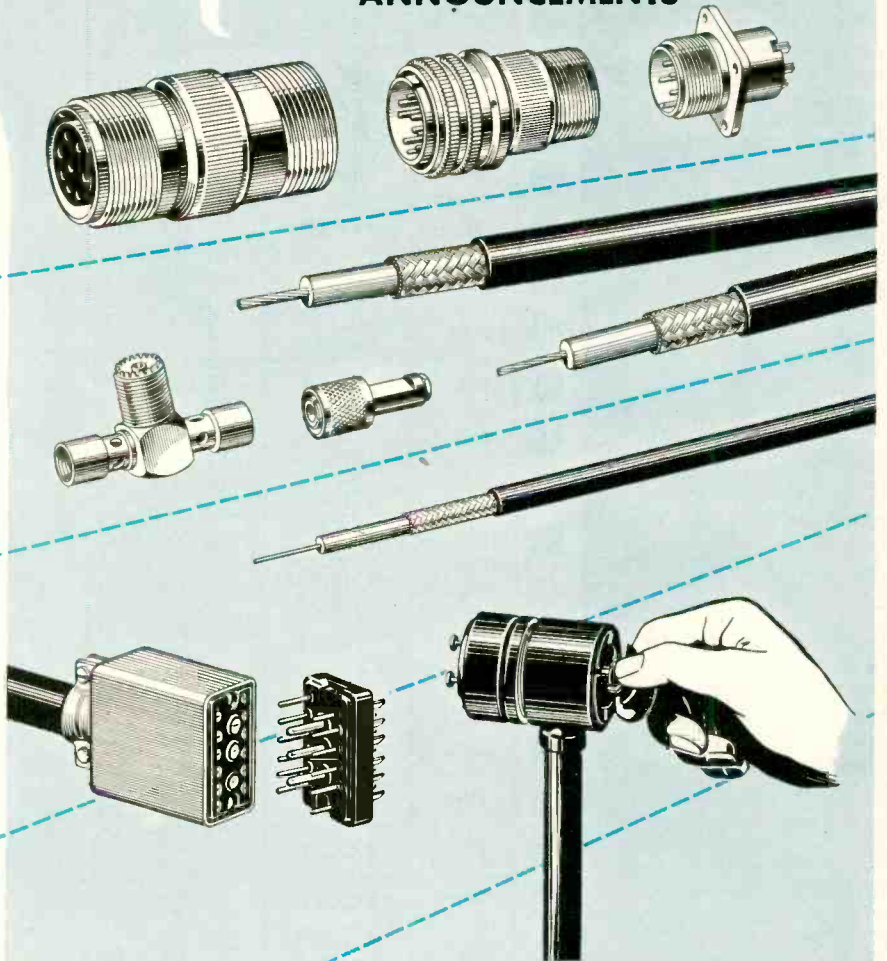

The complete line of Amphenol products includes over 9,000 items designed and produced to the exacting standards required by radio-electronic applications. Amphenol's reputation for superior products of outstanding design is the result of rigid quality control from the development laboratory to the model shop; from the engineering department to the field testing laboratory; from production to finished product.

Amphenol quality products include the most complete line of RG cables, RF connectors, AN connectors and fittings, radio sockets and connectors available from any one source in the world today. To facilitate comprehensive listing of the many components Amphenol produces, cataloging is divided into three sections according to product adaptability and usage. Amphenol Engineering News supplements the catalogs with information on the latest Amphenol product developments. Request the catalogs you require.

Choose AMPHENOL — the quality name in electronics!

AMERICAN PHENOLIC CORPORATION • CHICAGO 50, ILLINOIS

ALLIED'S RELAY GUIDE

ALLIED TYPE	MAXIMUM CONTACT ARRANGEMENT	COIL OPERATION CONTACT RATING CURRENT 24 V. DC. AND 110 V. AC.	COIL DATA IN VOLT-AMPERES OR WATTS AC. DC.						DIMENSIONS			WEIGHT IN OUNCES		ADDITIONAL FEATURES AS NOTED AT LEFT
			MINIMUM		RATED		MAXIMUM		HEIGHT	WIDTH	LENGTH	MINIMUM	MAXIMUM	
			AC	DC	AC	DC	AC	DC						
1	PK	4.P.D.T.	10	AC 2.9 DC 0.8	5.0 1.5	7.0 5.5	4000 4500	220 110	2-1/16	1-1/8	2-1/16	4.5	3.7 9	
2	AS	S.P.D.T.	5	AC 2.5 DC 0.5	3.5 1.0	5.0 4.6	3500 3485	230 60	1-3/16	15/16	1-5/8	2	3	
3	B	S.P.D.T.	1	AC 0.09 DC 0.009	0.12 0.012	9.5 4.9	12000 12000	110 12	1-3/4	2-3/8	2-3/4	7	2	
4	BK	D.P.D.T.	1	AC .190 DC .019	.24 .024	9.5 4.9	12000 12000	150 18	1-21/32	2-5/8	2-5/8	7	2	
5	BG	S.P.D.T.	2	DC .011	.05	4.8	5000	16	1-1/4	1-3/4	1-3/8	2-3/4	3	
6	BJ	D.P.D.T.	5	AC 2.8 DC 1.0	3.5 2.0	7.3 5.5	3370 3370	220 82	1-9/16	25/32	2-5/16	2-1/4	1, 2, 3, 7	
7	BJU	ELECT. LATCH 4.P.D.T.	5	AC 3.6 DC 2.8	9.0 3.5		3370 3370	220 110	1-15/16	1-7/8	1-9/16	6-1/2	6	
8	BN	6.P.D.T.	10	DC 1.5	3.5	8.0	4460	125	2-9/16	3	1-23/32	11	2, 7	
9	BO	D.P.D.T.	15	AC 3.6 DC 1.5	4.5 2.5	10.0 5.7	2675 5000	250 112	1-7/8	1-13/32	1-5/8	4	2, 3, 7	
10	BOY	D.P.D.T.	15	DC .50	.75	7.2	10000	87	1-7/8	1-13/32	1-5/8	5	2, 3, 7	
11	CN	S.P.S.T. N.O. OR N.C.	50	AC 7.2 DC 1.0	9.0 3.5	14.0 8.5	700 4460	230 125	2-1/2	2	2-1/4	9-1/4		
12	DS	DIFFERENTIAL D.P.D.T.	5	DC .04	.05	5.0	8000		1-13/16	1-3/16	2-3/8	7	3	
13	ME	D.P.D.T.	2.5	DC .2	.5	3.5	2800	60	1-3/16	13/16	1-3/8	1.5	3, 7	
14	FID	S.P.S.T.	2	DC .08	.20	4.5	4900	31	1-3/8	1-3/16	1-3/8	2		
15	SW	S.P.D.T. D.P.D.T.	2.5	DC .003 .012	.012 .050	4.25	13800	230	1-7/16	1-1/16	1-19/32	2.5	2.3	
16	HRX	3.P.D.T.	15	AC 5.2 DC 1.5	6.5 3.0	12.0 7.0	1800 4420	230 115	1-1/2	2-11/16	1-5/8	6-3/4	8	
17	PO	3 & 4.P.D.T.	15	AC 8.0 DC 1.0	10.0 2.5	17.2 8.2	870 5000	230 112	2-1/4	3.P.D.T. 1-5/8	1-7/8	7	2, 3, 7	
18	POY	3 & 4.P.D.T.	15	DC 0.6	1.0	8.0	10000	110	2-1/4	4.P.D.T. 2-3/16	1-7/8	7	2, 3, 7	
19	RA	CO-AXIAL S.P.D.T.	1.25 R.F.	DC 0.5	1.5	5.0	2000	55	2	2-7/8	1-3/4	4	4, 10	
20	SK-C-C	D.P.D.T.	1	DC .340	2.5	4.2	4500	110	1-5/16	31/32	1-7/16	2.0	1, 3, 5	
21	SK-CC-C	3.P.D.T.	1	DC .545	2.5	4.2	4500	110	1-1/2	31/32	1-7/16	2.1	3	
22	SK-CC-CC	4.P.D.T.	1	DC .755	2.5	4.2	4500	110	1-1/2	31/32	1-7/16	2.5	3	
23	TSL	D.P.D.T.	1	DC 0.5	1.0	5.0	2000	55	1-9/16	1-3/16	11/16	1	1, 5	
24	PB	4.P.D.T.	10	DC 1.0	2.5	6.0	5000	110	1-13/16	1-9/32	1-13/32	4	3, 7	
25	LK	6.P.D.T.	2	DC .040	.65	7.0	5200	110	1-5/8	1-3/32	2-7/32	4	1, 3	
26	SKH	Hermetically sealed relay — data same as SK												
27	BOHO	Hermetically sealed relay — data same as BO												

ADDITIONAL FEATURES

1. Available with Standard Ceramic Insulation.
2. Available with bakelite base and screw terminals.
3. Available hermetically sealed.
4. Available with auxiliary contacts.
5. Available for low capacity.
6. For intermittent operation only.
7. Available in double-break contact arrangement.
8. Available with ceramic insulation only.
9. Listed by Underwriters' Laboratories, Inc.
10. Designed to handle a maximum of 75 watts of radio frequency up to 150 megacycles when inserted in a properly terminated 52 ohm line.

NOTE 1.
Minimum coil data applies where shock and vibration are not a factor.

NOTE 2.
Maximum coil data based on 85°C rise above 20°C ambient for continuous operation except for mercury type relay which are based on 65°C ambient.

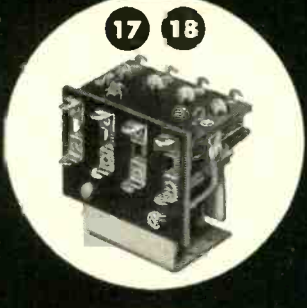
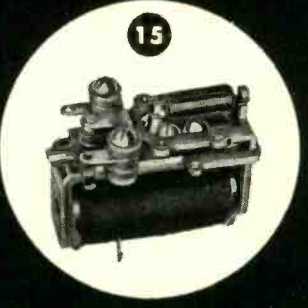
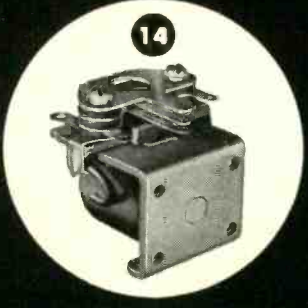
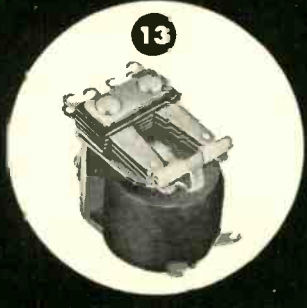
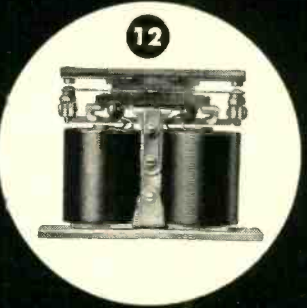
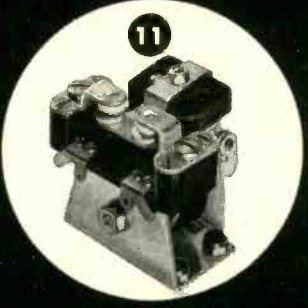
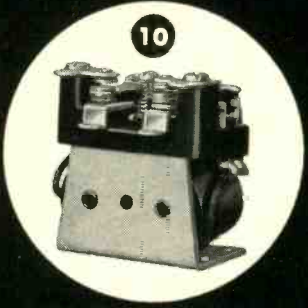
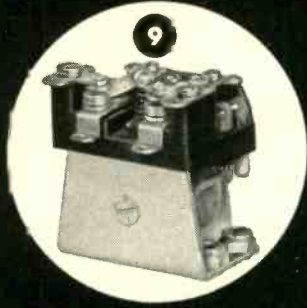
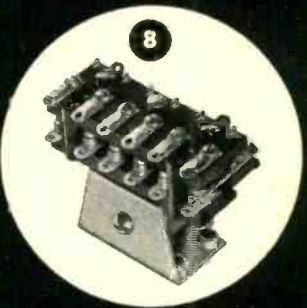
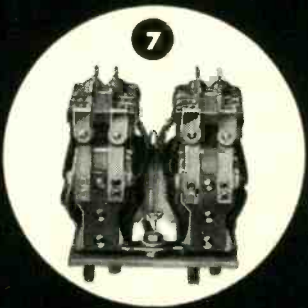
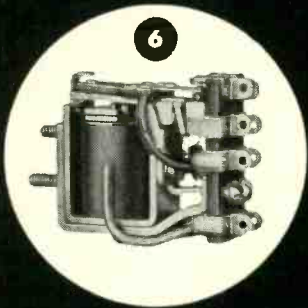
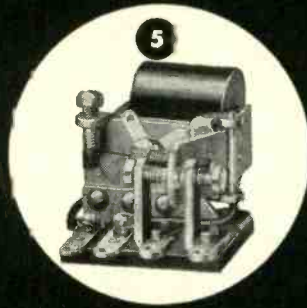
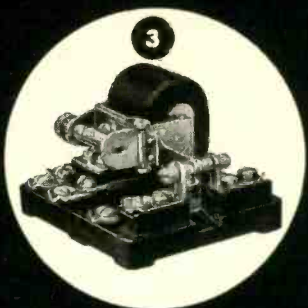
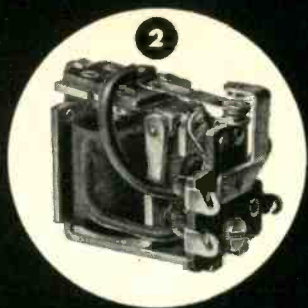
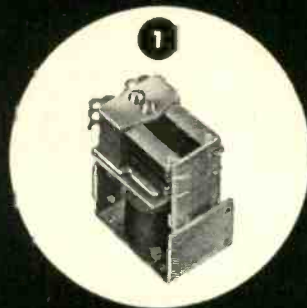

18

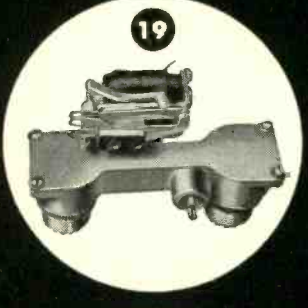

19



20

21

22

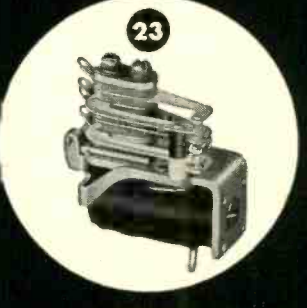

23

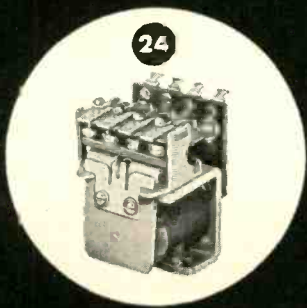

24

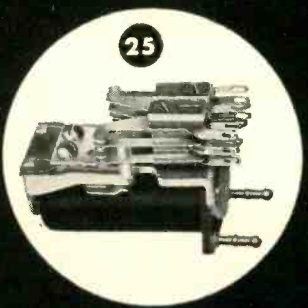

25

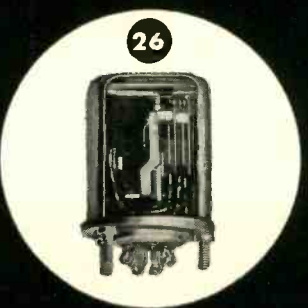

26

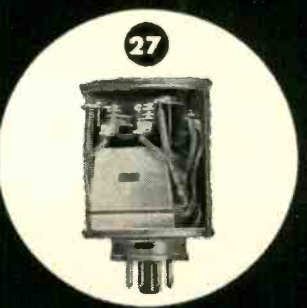

27

Superior TUBE COMPANY Electronics Division

Electronic Tubing—Tailored to Your Needs

"Quality" is the keyword to success in electronics applications. It is also a synonym for Superior in fine small tubing for the Electronics Industry. The newest addition to the Superior plant, at the left in the picture, (more than 50,000 square feet) houses the Electronics Division's production facilities. It is devoted to research, engineering and production of tubing and finished parts to do a better job in tough electronics applications.

For many years the Electronics Industry has come to Superior for tubing and tubular parts tailored to specific needs. We have been able to assist materially in the development of many of these parts. We are now ready, willing and able to work closely with manufacturers toward the solution of any problems which may be solved through such development and refinement. Elsewhere on these pages are some details about a few of the many kinds and types of parts we now make. If you desire more information

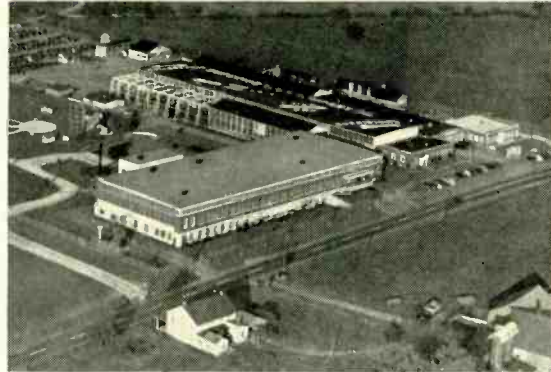

about them, or wish to consult us about a problem, please write—no obligation, of course.

NICKEL CATHODES

Seamless

Standard production calls for an O.D. range of .010" to .121" inclusive with wall thickness from .0015" to .005" inclusive (most generally used, .002" \pm .00025"). Cathodes with larger diameters and heavier walls can also be produced. The International Nickel Company's #220 grade of Seamless Nickel is the most widely used material. Seamless cathodes may be cut to practically any length required. Bead (emboss) may be located anywhere on the Cathode, .040" minimum. Seamless Nickel Cathodes are available in round, oval, elliptical or rectangular shapes.

For information about #220 grade of Seamless Nickel ask for Data Memo #5-2. For detailed data on standard cathode tolerances ask for Specification EM-2.

Lockseam*

This type of cathode is produced from nickel strip especially rolled for the purpose. Present standard range of sizes is .040" to .100" O.D. inclusive with wall thicknesses of .0021" \pm .0001" and .0025" \pm .0001". Lengths are from 11.5MM to 42MM inclusive. Various analyses of nickel strip are used, depending upon characteristics required. Bead or emboss may be located anywhere on the cathodes, .040" minimum. A vertical bead or emboss can also be furnished on certain sizes. Lockseam Cathodes are available in round, oval or rectangular shapes. Most recent Lockseam Cathode development at Superior is integral tabbed sleeves. For information about various analyses of nickel strip write for Data Memo #5-2.

*Manufactured under U. S. Patents.

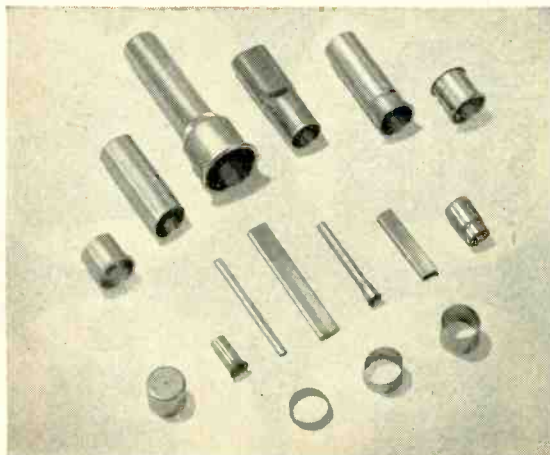

FABRICATED PARTS

Research, engineering experience, production know-how and highly specialized equipment are the factors that have made Superior fabricated parts the standard for the Electronics Industry. At the left are shown a handful of the hundreds of parts we can make.

All of this experience, know-how, and equipment is at your service in the development of a part or parts to suit your particular needs.

We have specialty, automatic and semi-automatic, equipment for cutting, stamping and drilling operations, as well as excellent tumbling equipment. Together with our rigid quality control system, this machinery permits the high-speed production of anodes, grid cylinders and other parts for television and cathode ray gun structures. Parts may be rolled at either end, to meet any requirement. We will be glad to send detailed information promptly upon request.

Superior TUBE COMPANY Electronics Division

DISC CATHODE ASSEMBLY

The Superior Disc Cathode which has proved so satisfactory during the past several years has recently been improved by the addition of the following new feature:

1—The end of the nickel shank opposite the emission cap has been given a slight flare. This insures easier insertion of the coated heater wire and cuts down considerably on heater shrinkage.

To this new feature add the following "old" details which made the Superior assembly outstanding and the result is a product that is truly superior in every respect.

1—Double beaded construction for attaching the ceramic insulator to the nickel shank. This insures the minimum loss of heat and forms a *tight* construction that will not come loose in use.

2—The "E" dimension (distance between top of ceramic and top of emission cap) is held to the rigid tolerance of $\pm .0005''$. This cuts down on the number of spacer combinations that have to be used, and gives better cut-off characteristics.

3—The emission cap has no flange—does not touch the ceramic insulator at all—thus eliminating any additional danger of heat loss.

For information about the Disc Cathode Assembly, ask for Superior print ED-3.

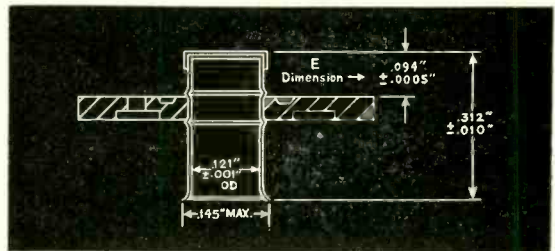
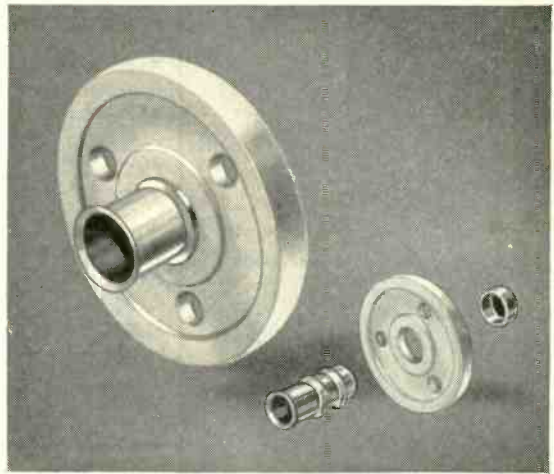

KULGRID†

a product of Sylvania Electric Products, Inc.

Pictured at the top of the illustration below is a section of $\frac{3}{8}''$ O.D. x .0273"/.02955" wall "A" Nickel⁽¹⁾ tubing drawn by Superior over OFHC (oxygen free high conductivity) copper rod. This is the raw material from which Sylvania Electric draws their KULGRID nickel clad wire shown at the bottom of the picture.

KULGRID is a conductor suitable for applica-

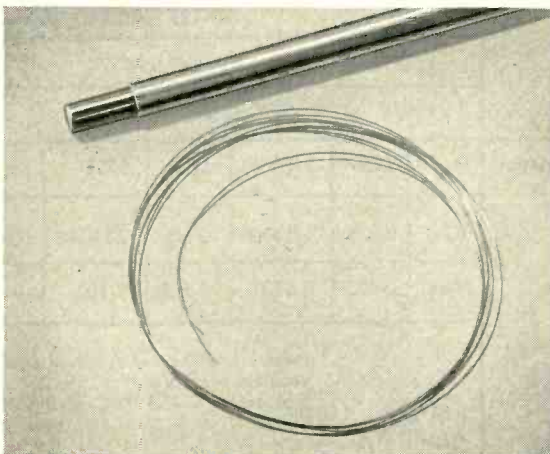

Export Representatives: Driver-Harris Company, Harrison, New Jersey, and affiliated European companies. Phone, Harrison 6-4800.

tion in close proximity to high operating temperatures. It provides good electrical conductivity plus the protection afforded by heat and corrosion resistant nickel. Stranded conductors of this wire may be used as electrical leads for aircraft, electric furnaces, appliances, jet engines and a wide variety of laboratory and industrial equipment.

Superior, by cold drawing, can produce composite tubing or rod of many different materials. We cold draw tubing over plastics, insulated wire, mesh and many other materials which may or may not possess ductility. We are small diameter tubing specialists who have licked many materials problems in cooperation with our customers' engineers.

Just as we were able to assist Sylvania Electric in the production of the material for their KULGRID we may be able to help you. We will welcome the opportunity to do so.

†Covered by U. S. Patent 2,120,561

(1) Reg. U. S. Trademark—The International Nickel Co.

Superior

THE BIG NAME IN SMALL TUBING

All analyses .010" to $\frac{5}{8}''$ O.D.
Certain analyses (.035" max. wall) up to $1\frac{1}{2}''$ O.D.

SUPERIOR TUBE COMPANY
Electronics Division

2500 Germantown Ave., Norristown, Pennsylvania

Specify

SORENSEN

Nobatron Model E-6-15



AC Regulator
Model 500S



3ø Regulator
Model
3P15000

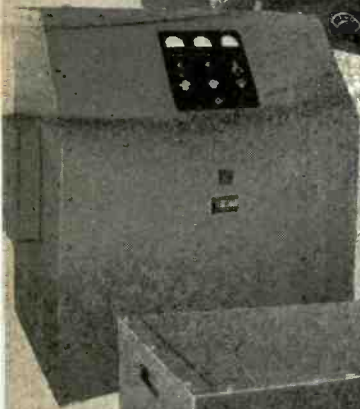

B-Nobatron
Model 500B



Variable Auto
Transformer



Saturable Core Reactor

Ranger
Model SR-10

FUNCTIONAL GROUP

SPECIFICATIONS

AC REGULATORS Models available (numbers denote VA capacities) 150S 250S 500S 1000S 2000S 3000S 5000S 10000S 15000S	Input	95-130 VAC, 1ø, 50-60~; 190-260 VAC in "-2" models
	Output	115 VAC ±5%; 230 VAC with "-2" models
	Reg. accuracy	±0.1% against line or load
	Distortion	2% — 3% max.
	P. F. range	Down to 0.7
	Load range	0 to full load
	Miscellaneous	Fully protected against overload or overvoltage. Models 150S, 250S, 500S, 1000S are self-contained. Cabinets available for others. Normal finish — gray wrinkle.

NOBATRONS* (DC Supplys — low voltage) Models available (numbers indicate voltage & current) E-6-5 E-6-15 E-6-40 E-6-100 E-12-5 E-12-15 E-12-30 E-12-50 E-28-5 E-28-10 E-28-30 E-28-70 E-28-150 E-28-350 E-48-15 E-125-5 E-125-10	Input	95 — 130 VAC, 1ø, 50-60~. In heavy current 28-volt series — 115/208, 3ø, 4-wire, wye.
	Reg. accuracy	±0.2% against line or load changes
	Ripple	1% RMS max.
	Load range	1/10 to full load
	Output range	Adjustable ± 10%
	Recovery time	0.2 seconds — this value includes charging time of filter circuit for most severe change in load or input conditions.
	Miscellaneous	Fully protected against overload and overvoltage. Normally for rack mounting — cabinets available. Normal finish — gray wrinkle. Meters standard in some models; available in all.

B-NOBATRONS* (DC Supplys — high voltage)	Input	105-125 VAC, 1ø, 50 — 60~.
	Load range	0 — full load
	Ripple	10 mv

output	Model	325B*	360B**	500B*	520B*	560B*	1000B*
VDC		0-325	175-360	0-500	200-500	0-500	200-1000
Ma		0-125	0-120	0-300	0-200	0-200	0-500
* meters furnished as standard equipment. regulation accuracy ±0.5% bias supply 0-150 VDC @ 0-5Ma (except model 1000B)							
** no meters, no bias supply regulation accuracy ±1.0%							
All have 6.3 VAC, 6-10 amperes, unregulated, C.T.							

SORENSEN and COMPANY INC., Stamford, Conn.

*Reg. U.S. Pat. Off. by Sorensen & Co., Inc.

The FIRST Line of Electronic Voltage Regulators

FUNCTIONAL GROUP

SPECIFICATIONS

RANGERS (Full-range-variable DC Supplys)	Input range	95 — 130 VAC, 1 ϕ , 50 — 60~.		
	Reg. accuracy	$\pm 0.25\%$ at any voltage setting.		
	Ripple	1% RMS max.		
	Output	Model	SR-10	SR-30
	VDC	3-135	3-30	3-13
	Amps	1-10	3-30	5-50
400~ EQUIPMENT: LINE REGULATORS	Similar to 60~ regulators except: Accuracy $\pm 0.5\%$; distortion 5% max.; frequency 400~ $\pm 10\%$.			
NOBATRONS*	Same general specifications as 60~ Nobatrons.			
3ϕ REGULATORS 60~ 400~	Capacity 450VA to 45KVA. Wye to wye 115/230, 4-wire preferred. Delta to delta no neutral possible with phase transformation and reasonably balanced loads. Capacity 100, 250, and 750 VA. Delta to delta normal.			
VARIABLE AUTO- TRANSFORMERS	Output	0-130 VAC, 350-2400~.		
	Current range	5 and 15 amperes. Cased or open construction.		
REACTORS	Built to customer specifications.			
WOUND COMPONENTS: POWER TRANSFORMERS	Limit capacity to 5KVA and 5000 volts.			
PLATE TRANSFORMERS	Limit capacity to 5KVA and 3000 volts C.T.			
FILAMENT TRANSFORMERS	Usual specifications.			
AUTOTRANSFORMERS	Up to 10KVA capacity			
DC REACTORS, CHOKES	Up to 5000 insulation voltage limit. Limit to 20 henries @ 1 ampere.			
AC REACTORS	Up to 5KVA limit			
400-800~ TRANSFORMERS	Using hypersil or thin gauge lamination construction.			
RECTIFIER TRANSFORMERS	Capacity and voltage limitations above. Wound components can be hermetically sealed to pass JAN-T-27, Grade 1 specifications. Conventional "potting" — fosterited — varnish impregnated to specifications.			
FOSTERITE PROCESS	Up to 500 cubic inches. Under Westinghouse license.			

Standard design AC regulators can be converted to meet appropriate AN-E-19, MIL, and JAN specifications.

Specify

SORENSEN

Coast to Coast

Authorized Sorenson representatives and their field engineers are listed below. Find the one located nearest you — don't hesitate to call on him for consultation and advice.

CALIFORNIA — HOLLYWOOD

Neely Enterprises
7422 Melrose Ave.; Phone Whitney 1147

CALIFORNIA — SACRAMENTO

Neely Enterprises
2334 42nd St.; Phone Hillcrest 6-5521

CALIFORNIA — SAN FRANCISCO

Neely Enterprises
2830 Geary Blvd.; Phone Walnut 1-3960

D.C. — WASHINGTON

Burlingame Associates — F. L. Horman
2017 S St., N.W.; Phone Decatur 8000

FLORIDA — FORT MYERS

Arthur H. Lynch & Associates
P. O. Box 466; Phone 5-6762

GEORGIA — ATLANTA

Floyd Fawcett & Son
1347 Beecher St., S.W.; Phone Raymond 3104

ILLINOIS — CHICAGO

Loren F. Green & Associates
4949 W. Diversey Ave.; Ph. National 2-2370

KANSAS — WICHITA

Standard Products, Inc.
650 E. Gilbert Ave.; Phone Wichita 2-1431

MASSACHUSETTS — BOSTON

Burlingame Associates — P. G. Yewell
270 Commonwealth Av.; Ph. Kenmore 6-8100

MICHIGAN — DETROIT

S. Sterling Company
13331 Linwood Av.; Phone Townsend 8-3130

MINNESOTA — MINNEAPOLIS

Graybar Electric Co. — W. G. Pree
824 S. Fourth St.; Phone Geneva 1621

NEW MEXICO — ALBUQUERQUE

Neely Enterprises
107 S. Washington St.; Phone 5-8731

NEW YORK — FAYETTEVILLE

Burlingame Associates — J. D. Ryerson
13 Edgemere St.; Phone 485-R

NEW YORK — NEW YORK

Burlingame Associates
103 Lafayette St.; Phone Digby 9-1240

NORTH CAROLINA — CHARLOTTE

James L. Highsmith
P. O. Box 1011; Phone 5-6436

OHIO — DAYTON

Charles D. Boehme
Talbot Bldg.; Phone Fulton 8188

OHIO — CLEVELAND

H. A. Watson, Jr.
817 Citizens Bldg.

OREGON — PORTLAND

Electronic Specialty Representatives
331 S.E. 62nd Ave.; Phone East 4331

PENNSYLVANIA — PHILADELPHIA

Burlingame Associates — Ivan Robinson
422 W. Coulter St.; Phone Tennessee 9-2006

PENNSYLVANIA — PITTSBURGH

H. E. Ransford & Co.
Grant Bldg.; Phone Grant 1-1880

TENNESSEE — KNOXVILLE

A. R. Hough
P. O. Box 1452; Phone 8-4312

TEXAS — HOUSTON

Earl W. Lipscomb & Associates
2420-B Rice Blvd.; Phone Linden 9303

TEXAS — DALLAS

Earl W. Lipscomb & Associates
3561 Marquette St.; Phone Emerson 6-7989

CANADA — TORONTO, ONT.

Charles W. Pointon
1926 Gerrard St., East.; Phone Oxford 7435

ESICO

REG. U. S. PAT. OFF.

● Red Label Irons



These are the irons that are used so universally in factory production lines. They are light weight, finely balanced, and have the coolest handles of any irons on the market. Elements are mounted and held in place with a knurled nut which engages the back end of the element and seats against the shoulder of the case shell, holding the element firmly in place regardless of the most rugged use. They are ideal from a maintenance standpoint for, due to their two piece combination terminal and handle, elements are replaceable in three minutes or less. The only iron on the market designed for use with or without a ground wire.

Irons are normally supplied in four wattages. They are obtainable, when required in quantity, in special wattages at no extra cost. Standard voltages are 105-120 and 220-240. Special voltages may be had. List prices of irons are as follows: No. 38-100 watt \$7.65, No. 58-200 watt \$9.85, No. 78-300 watt \$12.05 and No. 98-550 watt \$14.25. The iron illustrated is the No. 38 and is 1/2 actual size.

● No. 61 Pencil Iron



This pencil iron is only seven inches in length and weighs just 2 1/2 ounces exclusive of cord. The handle temperature at the point where it is held in the fingers, is actually no higher than body temperature. Diameter of handle is 3/4" and may be used as a pencil for the most delicate soldering operations. The element construction is of the same type as used in ESICO industrial irons and will give long service. The tip is the so called plug type, held in place with a set screw. Three shapes of tips are available, Type B—1/4" dia. pyramid point, Type A—1/8" dia. straight pencil point and Type C—1/8" dia. bent 90 degrees with a pencil point.

The No. 61 is regularly wound to 25 watts at 105-120 volts, but may be had in higher wattages, when required in quantities at no extra cost. List price of iron is \$5.45. Tips A, B, or C 40¢ each list. Irons are available thru any of the better tool or Radio & Electronic Supply houses. If your distributor can not supply you from stock, send your order direct to us, but please be sure and give name of your distributor.

● Solder Pots

Ruggedly constructed cast iron pots, with easily replaceable elements.

Model No. 12—3/4 lb cap. 200 watt
Net \$4.95

Model No. 36—2 1/4 lbs cap. 250 watt
Net \$6.05

Model No. 60—3 3/4 lbs cap. 325 watt
Net \$7.15

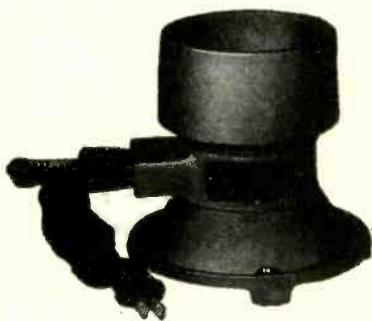

● Temperature Control Stand

This control stand is thermostatically actuated by the tip temperature of the iron. This is the only logical way to control the temperature of a soldering iron, for there is too much lag between element and tip temperature for the application of a thermostat to the element, whether in an iron or a control stand. Cat. No. 5, irons up to 1" dia. tip; Cat. No. 6, irons 1" to 1 1/2" dia. tips. List price \$7.15



ELECTRIC SOLDERING IRON CO., Inc.
3851 West Elm Street
Deep River, Conn., U. S. A.

Titeflex

has the experience
in

WAVEGUIDES COMPONENTS ASSEMBLIES

Regardless of the types of waveguides and components you require, Titeflex can supply them. We manufacture rigid and flexible guides, combinations of the two, and any required component parts. As an A-N approved source, our engineering and testing facilities are always available for the development of new designs. Write us.



SEND FOR THIS NEW BULLETIN

Contains complete waveguide specifications, including materials, dimensions and recommended operating ranges for all types.



Titeflex, Inc.

524 Frelinghuysen Ave., Newark 5, New Jersey

what do you want in a resistor besides resistance?

Ward Leonard VITROHM Resistors maintain consistent accuracy and stability under even the most unfavorable operating conditions.

If the resistors in your equipment will be subjected to thermal shock, vibration, corrosive atmospheres, overloads, even prolonged exposure to humidity and electrolysis . . . select VITROHM and benefit from these Ward Leonard exclusives—

- (1) All components balanced in respect to thermal coefficient of expansion—hence, no loosening, no failure due to unbalance.*
- (2) Special Ward Leonard-made ceramic core pos-

sesses high density, low porosity and high dielectric.

(3) VITROHM vitreous enamel coating provides a complete hermetic seal, is hard, crazeless, yet extremely elastic, and an excellent conductor of heat.

From the complete line of Ward Leonard resistors, including those described below, select the type best fitting your needs and enjoy the confidence of knowing your product is more dependable because the resistor component is more dependable.

**Ward Leonard is the only manufacturer who makes (not just assembles) all the components of a resistor. (Wire drawn to Ward Leonard specifications.)*

fixed resistors

WATTS: 5, 10, 20, 25, 50, 100, 160, 200
OHMS: 1 to 150,000
SIZES: $1\frac{3}{4} \times \frac{5}{16}$ in. to $10\frac{1}{2} \times 1\frac{1}{8}$ in.

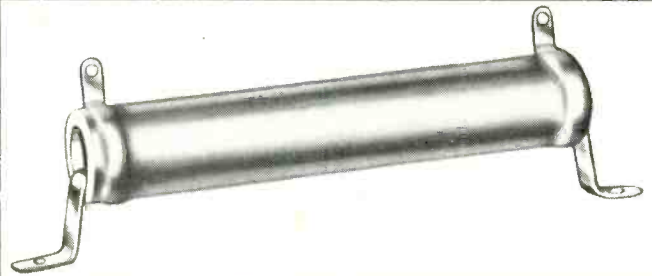

adjustable resistors ADJUSTOHM

The combination of high-quality wire, exclusive VITROHM enamel and Ward Leonard's extra care in manufacturing pays off particularly well in the case of adjustable resistors (which would otherwise be more susceptible to corrosion and damage). Wire turns are uniformly spaced and securely anchored. Contact points are rounded to make positive contact and yet avoid wire abrasion.

The ADJUSTOHM line comes in a complete range of resistance values and watt ratings.

WATTS: 10, 25, 50, 80, 100, 160, 200
OHMS: 1 to 150,000
SIZES: $1\frac{3}{4} \times \frac{5}{16}$ in. to $10\frac{1}{2} \times 1\frac{1}{8}$ in.



strip resistors STRIPOHM

For applications where space is limited, STRIPOHM gives high unit-space rating and extra strength. Elliptical shape increases strength. It also insures even and uniform winding because—with no sharp corners—the wire hugs the core shape. Greater surface area aids heat dissipation.

Combination of low mounting brackets and the arrangement of terminals facilitates multiple stacking.

WATTS: 30, 40, 55, 65, 75
OHMS: 1 to 66,000
SIZES: $1\frac{1}{4}$ to 6 in. lengths



placque resistors

For use where very low values of inductance and distributed capacitance are required. Wire of low temperature coefficient of resistivity is arranged on a rectangular refractory plate and completely imbedded in VITROHM enamel.

WATTS: 20, 40, 125
OHMS: 1 to 33,000
SIZES: $3\frac{1}{16}$, $4\frac{5}{8}$, $5\frac{3}{4}$ in. lengths

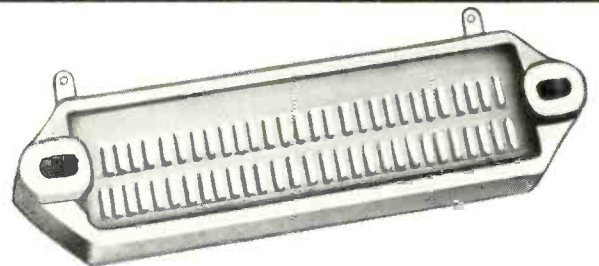

See your nearest Ward Leonard Authorized Industrial Distributor for stock sizes on any of these items.

Write for Catalog D130
WARD LEONARD ELECTRIC CO.
23 South Street, Mount Vernon, N. Y.

**WARD LEONARD
ELECTRIC COMPANY**
Result-Engineered Controls

RESISTORS • RHEOSTATS • RELAYS • CONTROL DEVICES

how to find the RELAY you can promptly forget

From the wide assortment of types and sizes in the Ward Leonard line of relays, you can easily select the one that will operate in your equipment with complete dependability.

Ward Leonard Relays are extra

sturdy to insure positive action and to prevent misalignment of parts by electrical or mechanical shock. They are built on molded phenolic or metal bases with posts securely anchored in the base.

Oversize silver-to-silver con-

tacts with high contact pressures and wiping action insure positive, low-resistance make and break. All parts are insulated against high voltage. Metal parts are plated for protection against corrosion.

thermal time delay relays

type 353

Bi-metallic thermostat control automatically compensates for ambient temperature changes. Continuous-duty, low-power coils. Timing is adjustable over a range of 5 to 45

seconds.

Single pole, single break, double throw. Fully-enclosed. For 115 v, 60 Cy. AC operation. BULLETIN 353.

heavy-duty relays

type 130

All Ward Leonard 130 Relays are built to one basic design which permits using standard interchangeable components. This means—you can get what amounts to a *special* relay for the price of a standard.

TYPES—Single pole: single break or double break. Double pole: single break or double break with common feed. Three and four pole combinations. BULLETIN 130.

heavy-duty midget relay

type 105

This "mighty midget" is often used on jobs normally requiring heavier-duty relays. Certain types are approved by Underwriters as motor controllers. Unique spring suspen-

sion adds a self-cleaning action to the heavy silver-to-silver contacts.

Single pole—double pole. AC or DC. BULLETIN 105.

midget metal-base relay

type 104

A small compact relay that can be used in a wide variety of light-duty applications where space is limited. Two mounting types, front- and rear-mounted, for standard duty. Mounting frames are metal base and are insulated from the contact circuit. Contact fingers are flexible

spring material to resist vibration.

Rear-mounted relays have tapped bosses fitted to the metal base frame, considerably reducing overall dimensions.

Double pole, double throw. AC or DC. BULLETIN 104.

sensitive relays

type 250

For use where devices or equipments are to be controlled by relays capable of operating on low power.

Large knurled heads and hexagon nuts facilitate the adjustment of sil-

ver contacts and the tension on the armature.

Good contact torque at pick-up with crisp drop out. AC or DC. BULLETIN 250.

WARD LEONARD ELECTRIC COMPANY

Result-Engineered Controls

RESISTORS • RHEOSTATS • RELAYS • CONTROL DEVICES

See your nearest Ward Leonard Authorized Industrial Distributor for stock sizes on any of these items. Write for Catalog D20. Ward Leonard Electric Co., 23 South St., Mount Vernon, N. Y.

A WORD TO THE WISE

IS SUFFICIENT



WIRES

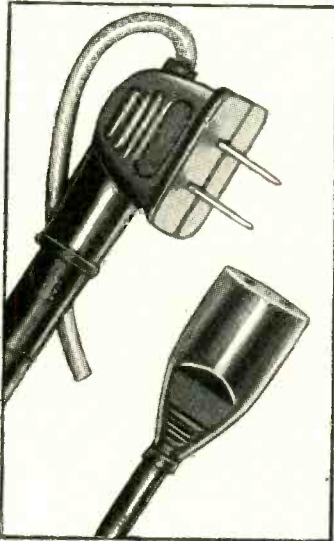

for Radio, Television and Inter-communication

SHIELDED WIRES

MICROPHONE CABLES

CORD SETS

ALL-PURPOSE HOOK-UP WIRES

TELEVISION DOWN LEADS

INTER-COMMUNICATION CABLES

"NOFLAME-COR"*

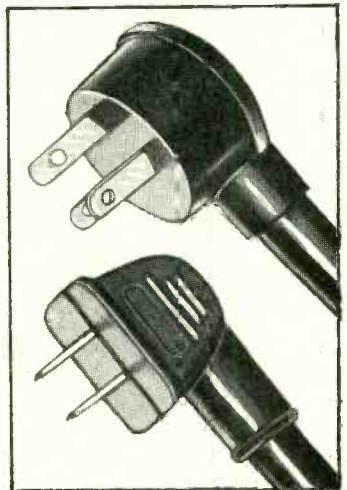

* The Television hook-up wire that eliminates blobbing, nicking; approved by Underwriters Laboratories at 90°; meets government specifications AN-J-C-48a. Available in all sizes, solid and stranded.

CORNISH Cord Sets feature ONE-PIECE molded-on plugs and sure contact spring action blades. They have U-L approved cords, and are designed to eliminate CORDelirium. They stand the gaff!

CORNISH WIRE CO., Inc.

50 Church Street

New York 7, N. Y.

CUSTOM-BUILT Harnesses and Assemblies

Our engineers know your problems and have for years designed complete wiring assemblies for leading manufacturers. Our Wired Assemblies Division at Rutland, Vt., is at your service for planned production:

"MADE BY ENGINEERS FOR ENGINEERS"

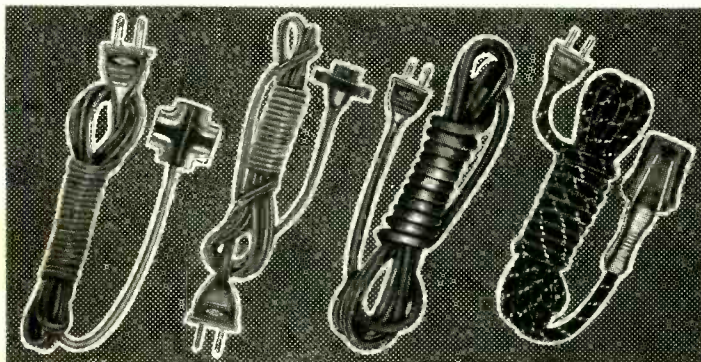

WRITE FOR
CATALOGUE

Branch Offices

Philadelphia	Bridgeport
Cleveland	Cincinnati
Chicago	Detroit
Minneapolis	St. Louis
Atlanta	Dallas
Denver	Los Angeles
San Francisco	Seattle
	Rochester

Specify "MAKEPEACE"

With nearly sixty years experience in the production of both laminated and solid precious metals, MAKEPEACE is today an accepted "headquarters" for the many special precious metal products and assemblies called for in the electronic field.

FOR RINGS AND WAVE GUIDE TUBING in laminated precious metals

Silver or gold, or platinum, or palladium, or their alloys, are bonded to the required base metal, such as copper or bronze alloys, to produce the required operating characteristics at real savings in cost over solid precious metals.

Today, rings are used in special electric motors, calculators and computers, radar, fire control instruments, potentiometers and many other electro-mechanical devices.

Laminated tubing is increasingly called for in the new higher frequency R. F. plumbing . . . for wave guides . . . and for coaxial line segments.

MAKEPEACE maintains a fully equipped research and testing laboratory . . . as well as a staff of thoroughly experienced metallurgists, chemists and consultants . . . all at your service.

Your inquiries are cordially invited and will receive our prompt and interested attention.

D. E. MAKEPEACE COMPANY

Laminated and Solid Precious Metals for Industrial Use • Fabricated Parts and Assemblies • Bar Contact Material • Precious Metal Solders

**MAIN OFFICE AND PLANT, ATTLEBORO, MASSACHUSETTS
NEW YORK OFFICE, 30 CHURCH STREET
CHICAGO OFFICE, 55 EAST WASHINGTON STREET**



Model 99
Dynamic



Model 22X-22D
Crystal or
Dynamic



Model 33X-
33D Crystal
or Dynamic



Model S-20X
Crystal

FOR SOUND PERFORMANCE *Specify* TURNER

Turner Microphones invite comparison from every angle. Compare the style, ruggedness, dependability, performance and price. Name the job — there's a Turner Microphone you can specify with confidence. Write for literature.



Model U9S
Dynamic
4 impedances
at your fingertips

The Aristocrat Model 50D

World's finest dynamic. Laboratory calibrated. For TV, FM, AM. Broadcast, recording and public address. No closely associated auxiliary equipment required. Response: 50 - 15,000 c.p.s. flat within $\pm 2\frac{1}{2}$ db. Level: 56 db below 1 volt/dyne/sq. cm.

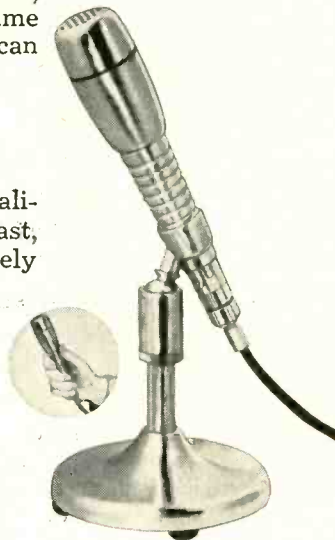

The "Competitor" Model 60X

A new low priced crystal desk and hand microphone for economical recording and sound systems, dictating machines, etc. High output moisture sealed crystal circuit. Response: 70 - 7000 c.p.s. Level: 52 db below 1 volt/dyne/sq. cm.



Model 87
Velocity

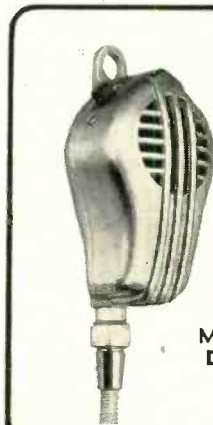

Model 9D
Dynamic



Model L-40 Crystal
Lapel Microphone

In Canada:

Canadian Marconi Company, Toronto, Ontario

Export:

Ad. Auriema, Inc., 89 Broad Street, New York 4, N.Y.

Detailed Data on Request



THE **TURNER** COMPANY

905 17th Street N.E., Cedar Rapids, Iowa

Crystals licensed under patents of the Brush Development Company



AMERICA'S
LEADING INDUSTRIAL PLANTS

RELY ON **M I L O** FOR URGENTLY-NEEDED ELECTRONIC PARTS

FROM coast-to-coast, Industrial Organizations everywhere have come to realize that MILO SERVICE is one that is unsurpassed!

The Secret?—MILO TEAMWORK!

Every order or inquiry, whether large or small, receives highly personalized attention from a CO-ORDINATED TEAM of EXPERTS!

THERE'S no haphazardness at MILO. We pride ourselves on the high speed efficiency of our great staff, every man and woman of which is highly trained and experienced, with broad technical knowledge, working with precision accuracy—aiming to give customer satisfaction.

THAT'S just one of the reasons why thousands of America's leading industrial giants continue to look to MILO for their every electronic need.



FREE! 1053 PAGE **MILO CATALOG**

Purchasing Agents!

Write today on your company letterhead for this gigantic, ready-reference buying guide and directory, listing latest electronic equipment, complete with technical specifications, illustrations and prices. (Necessarily limited to responsible purchasing officials only.) Address Dept. BG.

MILO stocks practically **EVERYTHING** for all electronic applications in scores of industries—radio, television, broadcasting, gas, oil refining, public utilities, power and light, mining, chemicals, plastics, ceramics, electro-plating, aviation, textiles, coal and iron, railroading, transportation, construction, signaling, telephone and telegraphic communications—as well as being suppliers to schools, colleges, research laboratories, police, fire and marine departments of municipal, city, state and U. S. Government agencies, including the Signal Corps, Army, Navy, Air Force and foreign government agencies.

OUR huge warehouse stocks permit us to offer instant shipment on thousands of nationally-advertised, standard brand electronic products—and, if by chance not in stock (we are human, too), due to our close relations with our many factory suppliers, we can get it for you with unbelievable speed.

LET US HELP SOLVE YOUR MATERIAL PROBLEMS, TOO!

MILO RADIO

200 GREENWICH STREET, NEW YORK 7, N. Y.

Cable Address: MILOLECTRO

& ELECTRONICS CORP.

Tel. BEekman 3-2980

The ONE Source for ALL your electronic needs.

for **FASTER** service
TELETYPE
Your Orders and Inquiries
OUR NUMBER IS
NY1-1839

Leading Brands
— IN STOCK!

- ADVANCE ELECTRIC
- AEROVOX • ALPHA WIRE
- AMPHENOL • ATR
- BELDEN • BLILEY
- BOGEN • BUD • BURGESS
- BUSSMAN • CINCH-JONES
- CLAROSTAT
- CORNELL-DUBILIER
- DIALCO • DRAKE
- EITEL-McCULLOUGH
- ERIE • GENERAL CEMENT
- GENERAL ELECTRIC
- GUARDIAN ELECTRIC
- HAMMARLUND
- HICKOK • HYTRON • ICA
- IRC • E. F. JOHNSON
- KESTER • KINGS ELECTRONICS
- LITTELFUSE
- MALLORY • MEISSNER
- JAMES MILLEN • NATIONAL CO.
- OHMITE
- PAR-METAL
- POTTER & BROMFIELD
- PRECISION APPARATUS
- PREMAX
- SANGAMO • SHALLCROSS
- SHURE BROS.
- SIMPSON ELECTRIC
- SOLA ELECTRIC
- SPRAGUE
- STANDARD TRANSFORMER
- SUPERIOR ELECTRIC
- SYLVANIA
- TUNG-SOL
- TRIPLETT • UNGAR ELEC.
- UNITED TRANSFORMER
- WARD LEONARD
- WESTON

and many, many others!
One Call—Gets Them All!

WRITE —
WIRE — PHONE
or TELETYPE,
TODAY!

Burnell **NOW** BIGGER THAN EVER IN THE PRODUCTION OF TOROIDS AND FILTERS

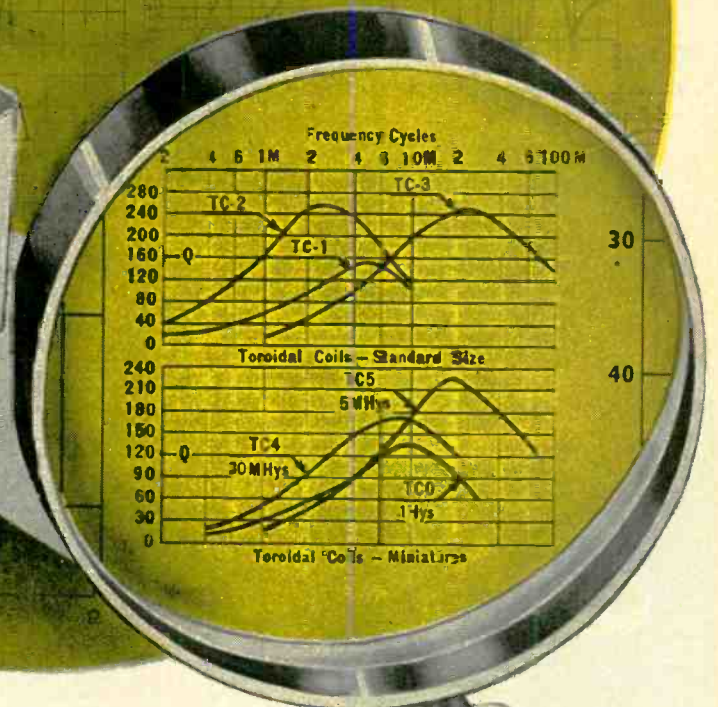
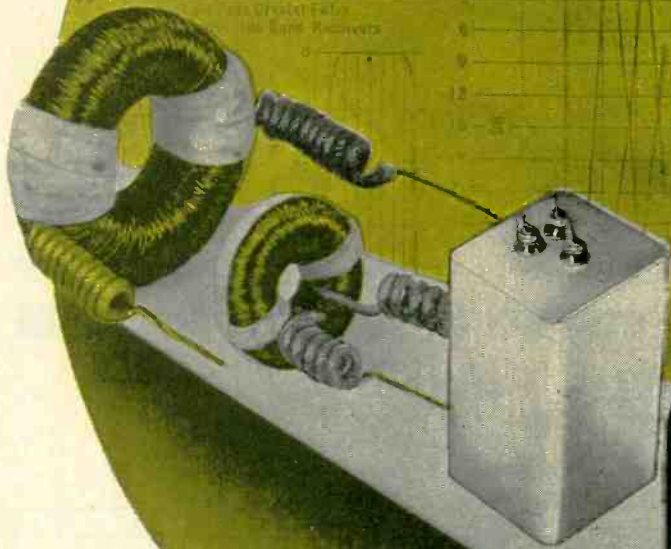

TYPICAL "Q" CHARACTERISTICS OF BURNELL TOROIDS WOUND ON MOLYBDENUM PERMALLOY CORES

Several years ago we began to specialize in the design and manufacture of toroidal coils and audio filter networks. At that time too few electronic engineers were aware of the full value of toroids (particularly those wound on molybdenum permalloy dust cores) as very little publicity had ever been devoted to a product that was fast becoming one of the most vital in the development of modern communications and control equipment.

We believe that since then through our technical service and advertising methods we have helped thousands of engineers to understand and appreciate the toroid as an essential in network applications.

The resulting popularity and industry acceptance of our toroidal coils and filters have necessitated an expansion of our production facilities to ten times what they were five years ago and we are proud to point to this growth as an expression from our customers of their satisfaction in the quality of our product and our service.

STANDARD SIZES

- TC-1 = 1 1/2" O.D. x 3/8"
- TC-2 = 2 1/4" O.D. x 7/8"
- TC-3 = 1 1/2" O.D. x 3/16"

MINIATURE SIZES

- TC-0 = 3/8" O.D. x 3/8"
- TC-4 = 1-3/16" O.D. x 9/16"
- TC-5 = 1-3/16" O.D. x 9/16"

MAXIMUM INDUCTANCE

- TC-1 — Ind.-Jp to 10 Hys.
- TC-2 — Ind.-Jp to 10C Hys.
- TC-3 — Ind. MHY-Up to 750
- TC-0 — Ind.-Jp to 2 Hys.
- TC-4 — Ind.-Jp to 10 Hys.
- TC-5 — Ind. MHY-Up to 750

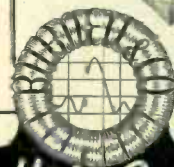

Burnell & Company
YONKERS 2, NEW YORK

CABLE ADDRESS "BURNELL"

EXCLUSIVE MANUFACTURERS OF COMMUNICATIONS NETWORK COMPONENTS

for industrial COILS

No matter what your coil needs may be, you'll find in U.S.E. a dependable source of supply. For further details write for catalog today.

CONTROLLED QUALITY • CONTRACT MANUFACTURING
DEPENDABLE SERVICE • HERMETICALLY SEALED

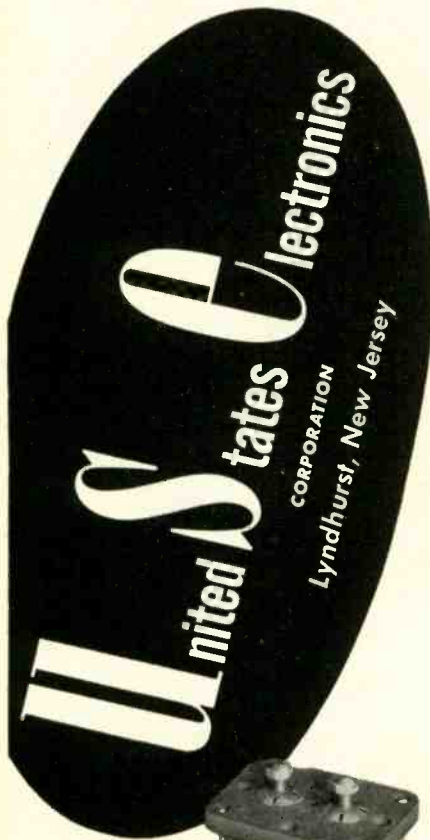

INDUSTRIAL COILS
aircraft
automotive
business machines
electrical
electronics
instrument
marine
mining
railroad
textile
JAN development
oil
radar

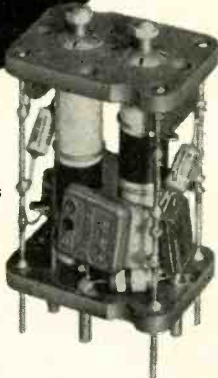

• SMALL
• COMPACT
• WELL DESIGNED
• DEPENDABLE

AGASTAT

TRADE-MARK

TIME DELAY RELAY

PROTECTS BIG INDUSTRY PROCESSES

Address inquiries to Special Products Division
American Gas Accumulator Company
1027 Newark Avenue, Elizabeth 3, New Jersey

RADIO HARDWARE and ACCESSORIES

• • • FASTENINGS • • •

—WRITE for CATALOG—

Whatever your product may be, you are faced with the problem of locating numerous items that form an integral part of your production. Whether it's a screw—nut—washer—lug—grommet or any one of a myriad of parts, each can be a "goat getter" if not easily located.

We Carry in Stock: Screws—Nuts—Washers—Lugs—
Rubber Grommets—Rivets—Eyelets—Etc.—Etc.

FEDERAL SCREW PRODUCTS INC.

224 W. HURON ST. CHICAGO 10, ILL.

PRECIOUS METALS IN ALL FORMS FOR THE ELECTRONIC INDUSTRIES

PLATINUM

WIRE · RIBBON
FOIL
SEAMLESS TUBING

SILVER

WIRE · SHEET · TUBING
SILVER BRAZING
ALLOYS & FLUXES

FOR A COMPLETE LIST OF OUR PRODUCTS
SEND FOR OUR NEW FOLDER, E-20
"PLATINUM, GOLD & SILVER FOR SCIENCE, INDUSTRY & THE ARTS"

THE AMERICAN PLATINUM WORKS

231 NEW JERSEY R.R. AVE. NEWARK 5, N. J.
PRECIOUS METALS SINCE 1875

For Truly Fine Recording and Reproduction



audiorecords®

For more than a decade, Audiorecords have consistently set the standards for quality and uniformity in every field of instantaneous disc recording. A superior lacquer, applied by a patented, precision-machine coating process, gives a mirror-smooth cutting surface with positive thread throw, brilliant h-f response, and freedom from background noise. An important improvement, perfected in 1948, makes all Audiorecords permanently resistant to humidity.

There's an Audiorecord for every recording need — conventional or microgroove.

RED LABEL AUDIORECORDS—exceed the most exacting demands for highest quality professional recordings. Aluminum base. *Double sided*— Sizes: 8", 10", 12" and 16". *Single face*— Sizes: 12" and 16".

YELLOW LABEL AUDIORECORDS—the popular choice for all general-purpose recording. Aluminum base. *Double sided*. Sizes: 8", 10", 12" and 16".

BLUE LABEL AUDIORECORDS—ideal for schools, homes, and general amateur use. Same lacquer as professional discs, but thinner aluminum base. *Double sided*. Sizes: 6½", 8" and 10".

MASTER AUDIORECORDS—the choice of professional recordists for use where pressings are to be made. Give fine results with either silvering or gold sputtering. Aluminum base. *Double sided or single face*. Sizes: 12", 13¼" and 17¼".

REFERENCE LABEL AUDIORECORDS—provide maximum economy for test cuts, reference recordings, auditions, etc. Aluminum base. *Double sided*. Sizes: 10", 12" and 16".



audiopoints®

The newly expanded line of Audiopoints covers the full range of recording and playback needs—for the most exacting professional recordists as well as the non-professional and the general public. Audiopoints are available in Sapphire, Stellite and Steel—precision made by skilled craftsmen, for matchless recordings and reproduction of either conventional or microgroove recordings. Send for folder



audiotape*

Audio Devices now offers a *complete line* of highest quality magnetic recording tape—on plastic or paper base, and with red or black oxide coating, for matched performance in any tape recorder.

Audiotape is precision made to the same exacting standards of quality and uniformity that have characterized Audiorecords for the past decade—your assurance of maximum fidelity, uniformity, frequency response, and freedom from background noise and distortion.

The following types of Audiotape are now available:

Length	Reel	Oxide	TYPE NO.	
			OxideOut	Oxide In
PLASTIC BASE				
600 Ft.	5" Plastic	Black	640	641
		Red	650	651
1250 Ft.	7" Aluminum (or Plastic)	Black	1240	1241
		Red	1250	1251
2500 Ft.	Std. NAB Aluminum Hub Complete 10½" Alum. Reel	Red	2550H	2551H
		Red	2550R	2551R
5000 Ft.	Std. NAB Aluminum Hub Complete 14" Alum. Reel	Red	5050H	5051H
		Red	5050R	5051R
PAPER BASE				
600 Ft.	5" Plastic	Black	600	601
		Red	620	621
1250 Ft.	7" Aluminum (or Plastic)	Black	1200	1201
		Red	1220	1221
2500 Ft.	Std. NAB Aluminum Hub Complete 10½" Alum. Reel	Red	2520H	2521H
		Red	2520R	2521R
5000 Ft.	Std. NAB Aluminum Hub Complete 14" Alum. Reel	Red	5020H	5021H
		Red	5020R	5021R

For special recording applications, Audiotape can be supplied in any desired width.

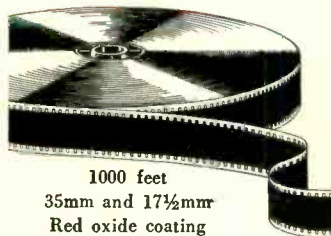

audiofilm*

Audiofilm is a professional-quality magnetic recording medium for the motion picture and television industries—offering all the advantages of high-fidelity, uniformity and easy editing which are inherent in Audiotape.

1000 feet
35mm and 17½mm
Red oxide coating
between sprocket holes on
cellulose acetate base
Other sizes on request

The above Audio Devices products are available through more than 300 authorized distributors, located in principal cities from coast to coast.

Audiorecords are manufactured in the U. S. A. under exclusive license from PYRAL, S.A.R.L., Paris



AUDIO DEVICES, INC.

444 MADISON AVE., NEW YORK 22, N. Y.

EXPORT DEPT.: 13 EAST 40TH ST., NEW YORK 16, N. Y., CABLES "ARLAB"

*Trade Mark

for VARIABLE RESISTORS to MILITARY SPECIFICATIONS . . .



SPECIALISTS IN PRECISION MASS PRODUCTION FOR 55 YEARS

EXCEPTIONALLY GOOD DELIVERY CYCLE ON MILITARY ORDERS due
to tremendous precision mass production facilities.

Electronic engineers all over the world depend upon CTS for:

A variable resistor engineered to the application.

Uniform high quality on a mass production basis.

Each variable resistor thoroughly tested electrically and mechanically
to assure top performance.

Delivery when promised.

If you need variable resistors to exacting military specifications, let
CTS specialists solve your problem.



Type G-C-35-45
Concentric Shaft Tandem



VARIABLE RESISTORS (COMPOSITION AND WIRE WOUND)

Type 85 NEW High Voltage,
Electro-Static Focusing.

Type JJ-033 Microphone Jack



Type JJ-034 Phone Jack.



Specialists in Precision Mass Production Since 1896



Type 25
4 Watt, Wire Wound.
GC 25 with Switch.



Type 45
15/16" Diameter,
Composition.
GC 45 with Switch.



Type 35
1/2" Diameter,
Composition.
GC 35 with Switch.



Type 252
2 Watt, Wire Wound.
GC 252 with Switch.



WITH OR WITHOUT ASSOCIATED SWITCH COMBINATIONS.



CHICAGO TELEPHONE SUPPLY *Corporation*

E. KHART • INDIANA

REPRESENTATIVES

S. J. Hutchinson, Jr.
801 North Broad Street
Philadelphia 8, Pennsylvania
Phone: Walnut 2-5369

W. S. Harman Company
4057 McClurg Drive
Los Angeles 8, California
Phone: Axminster 3-6219

in CANADA

C. C. Meredith & Co.
Stratfordville, Ontario

SOUTH AMERICA

Jose Luis Pontet
Buenos Aires, Argentina
Montevideo, Uruguay
Rio de Janeiro, Brazil
Sao Paulo, Brazil

OTHER EXPORT

Sylvan Winsbury
8 West 40th Street
New York 18, N. Y.

BURTON BROWNE ADVERTISING

Write For Your Free Copy Of This Complete TUBE BUYERS' GUIDE



SUBMINIATURE TUBES

TYPE	CONSTRUCTION	TYPICAL APPLICATION	HEATER	BASE	MAX. PLATE CURRENT (mA)	MAX. PLATE VOLTAGE (V)	MAX. GRID VOLTAGE (V)	MAX. ANODE VOLTAGE (V)	OPERATING TEMPERATURE (°C)	SEE DATA SHEET FOR
6X4	Full Wave	Rectifier	5.0	9-pin	100	250	100	250	100	See Data Sheet
6X5	Full Wave	Rectifier	5.0	9-pin	100	250	100	250	100	See Data Sheet

RELIABLE AND RUGGED TUBES

TYPE	CONSTRUCTION	TYPICAL APPLICATION	HEATER	BASE	MAX. PLATE CURRENT (mA)	MAX. PLATE VOLTAGE (V)	MAX. GRID VOLTAGE (V)	MAX. ANODE VOLTAGE (V)	OPERATING TEMPERATURE (°C)	SEE DATA SHEET FOR
6AR5	Full Wave	Rectifier	5.0	9-pin	100	250	100	250	100	See Data Sheet
6AV6	Full Wave	Rectifier	5.0	9-pin	100	250	100	250	100	See Data Sheet

GERMANIUM CRYSTAL DIODES

TYPE	TYPICAL APPLICATION	MAX. FORWARD CURRENT (mA)	MAX. REVERSE VOLTAGE (V)	MAX. OPERATING TEMPERATURE (°C)	SEE DATA SHEET FOR
1N34A	Detector	100	50	100	See Data Sheet
1N36A	Detector	100	50	100	See Data Sheet

ELECTROMETER TUBES

TYPE	CONSTRUCTION	TYPICAL APPLICATION	HEATER	BASE	MAX. PLATE CURRENT (mA)	MAX. PLATE VOLTAGE (V)	MAX. GRID VOLTAGE (V)	MAX. ANODE VOLTAGE (V)	OPERATING TEMPERATURE (°C)	SEE DATA SHEET FOR
6EM5	Full Wave	Rectifier	5.0	9-pin	100	250	100	250	100	See Data Sheet

RADIATION COUNTER (GEIGER-MUELLER) TUBES

TYPE	MAX. OPERATING TEMPERATURE (°C)	MAX. PLATE CURRENT (mA)	MAX. PLATE VOLTAGE (V)	MAX. GRID VOLTAGE (V)	MAX. ANODE VOLTAGE (V)	OPERATING TEMPERATURE (°C)	SEE DATA SHEET FOR
6349A	100	100	250	100	250	100	See Data Sheet

VOLTAGE REGULATOR - VOLTAGE REFERENCE TUBES

TYPE	TYPICAL APPLICATION	MAX. PLATE CURRENT (mA)	MAX. PLATE VOLTAGE (V)	MAX. GRID VOLTAGE (V)	MAX. ANODE VOLTAGE (V)	OPERATING TEMPERATURE (°C)	SEE DATA SHEET FOR
6X4	Rectifier	100	250	100	250	100	See Data Sheet

RECTIFIER TUBES

TYPE	CONSTRUCTION	HEATER	BASE	MAX. PLATE CURRENT (mA)	MAX. PLATE VOLTAGE (V)	MAX. GRID VOLTAGE (V)	MAX. ANODE VOLTAGE (V)	OPERATING TEMPERATURE (°C)	SEE DATA SHEET FOR
6X4	Full Wave	5.0	9-pin	100	250	100	250	100	See Data Sheet
6X5	Full Wave	5.0	9-pin	100	250	100	250	100	See Data Sheet

TELEVISION PICTURE TUBES

TYPE	BASED SIZE (inches)	HEATER	BASE	MAX. PLATE CURRENT (mA)	MAX. PLATE VOLTAGE (V)	MAX. GRID VOLTAGE (V)	MAX. ANODE VOLTAGE (V)	OPERATING TEMPERATURE (°C)	SEE DATA SHEET FOR
71PA	4 x 3 1/2	5.0	9-pin	100	250	100	250	100	See Data Sheet
8AP6	4 x 3 1/2	5.0	9-pin	100	250	100	250	100	See Data Sheet

RECEIVING TUBES

TYPE	DESIGN	CATHODE	HEATER	BASE	MAX. PLATE CURRENT (mA)	MAX. PLATE VOLTAGE (V)	MAX. GRID VOLTAGE (V)	MAX. ANODE VOLTAGE (V)	OPERATING TEMPERATURE (°C)	SEE DATA SHEET FOR
12A6	Diode	HTV	5.0	9-pin	100	250	100	250	100	See Data Sheet
12AX6	Diode	HTV	5.0	9-pin	100	250	100	250	100	See Data Sheet

The booklet pictured provides performance data on the finest line of quality tubes in the world—Raytheon Tubes. Most of these tubes have been pioneered and developed by Raytheon — many are manufactured exclusively by Raytheon — all will outperform any other tubes in the field.

Get this free Tube Characteristics Booklet today. Write



RAYTHEON MANUFACTURING COMPANY
 Special Tube Section
 NEWTON 58 • MASSACHUSETTS

RAYTHEON

WORLD'S LARGEST
MANUFACTURERS OF
AND WORLD
HEADQUARTERS
FOR

PULSE TYPE MAGNETRONS

Tunable or fixed frequency — 1,000 to 25,000 megacycles — power range from a few watts to several megawatts.

CW MAGNETRONS

Fixed frequency, tunable and frequency modulated tunable — 1,000 to 10,000 megacycles — power range from a few watts to several kilowatts.

KLYSTRONS

Integral and external cavity, low power — frequency range, 500 to 50,000 megacycles.

HIGH VACUUM RECTIFIER & HARD GLASS TUBES

Pulse modulation tubes and high vacuum rectifier tubes for microwave radar purposes — transmitting tubes for amateur and commercial use.

RAYTHEON

For detailed information, get in touch with

RAYTHEON MANUFACTURING COMPANY

Power Tube Division

WALTHAM 54, MASS.

Excellence in Electronics

THOMPSON EXPANDS ITS SERVICE INTO ELECTRONIC PRODUCTION



Model No. 10829 one-pole two-throw coaxial switch.

new!
precision built
coaxial switches

BY **Thompson**



Model No. 10567 one-pole four-throw coaxial switch.

TYPICAL PERFORMANCE

Frequency range, 0 to 10,750 Mc./Sec.
V. S. W. R., 1.5 maximum
Insertion loss, .5 decibels or less at 3,000 Mc./Sec.
Cross-talk, 50 decibels minimum at 3,000 Mc./Sec.
Characteristic impedance, 50 ohms nominal
Maximum RF voltage, 500 volts RMS
Power rating, CW maximum continuous 100 watts at 3,000 Mc./Sec.

THESE SWITCHES are available in several types, including single pole 2-throw, 3-throw, 4-throw and 6-throw, double pole double-throw, and lobing or sensing. Remote actuation is available for all.

The Thompson Products Electronics Division has a competent staff of engineers, electronic and environmental test equipment, model shop facilities, and production facilities ready to work with you on your coaxial switch problems.

WRITE for further technical information and descriptive brochure. Your inquiry will bring a prompt reply.



ELECTRONICS DIVISION, 2196 CLARKWOOD ROAD, CLEVELAND 3, OHIO

Thompson  **Products, Inc.**

MANUFACTURERS OF PRECISION AIRCRAFT PARTS AND ACCESSORIES
CLEVELAND • DETROIT • LOS ANGELES • ST. CATHARINES, ONTARIO

MPB bearings minimize space, weight and friction. Made in more than 70 types and sizes... from .100 to 5/16" diameters.

BEARINGS, BALL MINIATURE for precision mechanisms

How used:

MPB bearings are used in such instruments as gyro compasses, facsimile recorders, differential analyzers, coil winders, servo mechanisms, and in fact wherever the recognized properties of long wear and accurate alignment of larger fine anti-friction bearings are desired but where space is limited.

Made from:

High carbon chrome bearing steel (SAE52100) . . . MPB bearings are also available in 440 stainless and beryllium copper.

Close tolerances:











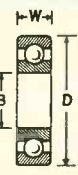

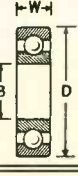

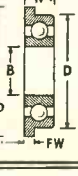
MPB bearings are made to high precision tolerances (ABEC 5 & 7) and carefully inspected at each stage of fabrication. Over 20 years experience assures you of the most modern and rigid standards of quality-control.

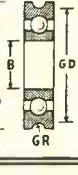
Engineering service:

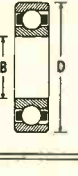
Technical assistance offered on any bearing problem. MPB is fully equipped to design and make special bearings.

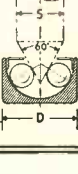
Catalog:

Although chart at right is not complete it gives an idea of the wide range of MPB bearings in stock sizes to meet design specifications. Send for Catalog 51E for complete information TODAY!

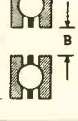
 <p>radial series</p>		<table border="1"> <thead> <tr> <th>Bearing No.</th> <th>100</th> <th>2</th> <th>2½</th> <th>3</th> <th>4</th> <th>5</th> </tr> </thead> <tbody> <tr> <td>O. D. (D)</td> <td>.100"</td> <td>.1250"</td> <td>.15625"</td> <td>.1875"</td> <td>.2500"</td> <td>.3125"</td> </tr> <tr> <td>Bore (B)</td> <td>.0250"</td> <td>.0400"</td> <td>.046875"</td> <td>.0550"</td> <td>.078125"</td> <td>.09375"</td> </tr> <tr> <td>Width (W)</td> <td>.03125"</td> <td>.046875"</td> <td>.0625"</td> <td>.078125"</td> <td>.09375"</td> <td>.109375"</td> </tr> <tr> <td>Balls</td> <td>7 - .65 mm</td> <td>8 - 1/32"</td> <td>10 - 1/32"</td> <td>8 - 3/64"</td> <td>8 - 1/16"</td> <td>10 - 1/16"</td> </tr> <tr> <td>Load Rating (lbs.) 5000 rpm</td> <td>.7</td> <td>1.16</td> <td>1.4</td> <td>3.0</td> <td>5.8</td> <td>6.4</td> </tr> <tr> <td colspan="7">TOLERANCES (D) + .0000" - .0002" (B) + .0000" - .0002" (W) + .000" - .001"</td> </tr> <tr> <td colspan="7">Eccentricity .0002" Max.</td> </tr> </tbody> </table>	Bearing No.	100	2	2½	3	4	5	O. D. (D)	.100"	.1250"	.15625"	.1875"	.2500"	.3125"	Bore (B)	.0250"	.0400"	.046875"	.0550"	.078125"	.09375"	Width (W)	.03125"	.046875"	.0625"	.078125"	.09375"	.109375"	Balls	7 - .65 mm	8 - 1/32"	10 - 1/32"	8 - 3/64"	8 - 1/16"	10 - 1/16"	Load Rating (lbs.) 5000 rpm	.7	1.16	1.4	3.0	5.8	6.4	TOLERANCES (D) + .0000" - .0002" (B) + .0000" - .0002" (W) + .000" - .001"							Eccentricity .0002" Max.						
	Bearing No.	100	2	2½	3	4	5																																																			
O. D. (D)	.100"	.1250"	.15625"	.1875"	.2500"	.3125"																																																				
Bore (B)	.0250"	.0400"	.046875"	.0550"	.078125"	.09375"																																																				
Width (W)	.03125"	.046875"	.0625"	.078125"	.09375"	.109375"																																																				
Balls	7 - .65 mm	8 - 1/32"	10 - 1/32"	8 - 3/64"	8 - 1/16"	10 - 1/16"																																																				
Load Rating (lbs.) 5000 rpm	.7	1.16	1.4	3.0	5.8	6.4																																																				
TOLERANCES (D) + .0000" - .0002" (B) + .0000" - .0002" (W) + .000" - .001"																																																										
Eccentricity .0002" Max.																																																										
 <p>super-light radial series</p>		<table border="1"> <thead> <tr> <th>Bearing No.</th> <th>418</th> <th>518</th> <th>5532</th> <th>5632</th> <th>5732</th> <th>614</th> </tr> </thead> <tbody> <tr> <td>O. D. (D)</td> <td>.2500"</td> <td>.3125"</td> <td>.3125"</td> <td>.3125"</td> <td>.3125"</td> <td>.3750"</td> </tr> <tr> <td>Bore (B)</td> <td>.1250"</td> <td>.1250"</td> <td>.15625"</td> <td>.1875"</td> <td>.21875"</td> <td>.2500"</td> </tr> <tr> <td>Width (W)</td> <td>.09375"</td> <td>.109375"</td> <td>.109375"</td> <td>.109375"</td> <td>.109375"</td> <td>.1250"</td> </tr> <tr> <td>Balls</td> <td>15 - 1 mm</td> <td>11 - 1/16"</td> <td>15 - 3/64"</td> <td>16 - 3/64"</td> <td>26 - 1/32"</td> <td>25 - 1 mm</td> </tr> <tr> <td>Load Rating (lbs.) 5000 rpm</td> <td>3.4</td> <td>4.4</td> <td>3.6</td> <td>3.6</td> <td>2.5</td> <td>3.5</td> </tr> <tr> <td colspan="7">TOLERANCES SAME AS STANDARD RADIAL SERIES</td> </tr> </tbody> </table>	Bearing No.	418	518	5532	5632	5732	614	O. D. (D)	.2500"	.3125"	.3125"	.3125"	.3125"	.3750"	Bore (B)	.1250"	.1250"	.15625"	.1875"	.21875"	.2500"	Width (W)	.09375"	.109375"	.109375"	.109375"	.109375"	.1250"	Balls	15 - 1 mm	11 - 1/16"	15 - 3/64"	16 - 3/64"	26 - 1/32"	25 - 1 mm	Load Rating (lbs.) 5000 rpm	3.4	4.4	3.6	3.6	2.5	3.5	TOLERANCES SAME AS STANDARD RADIAL SERIES													
	Bearing No.	418	518	5532	5632	5732	614																																																			
O. D. (D)	.2500"	.3125"	.3125"	.3125"	.3125"	.3750"																																																				
Bore (B)	.1250"	.1250"	.15625"	.1875"	.21875"	.2500"																																																				
Width (W)	.09375"	.109375"	.109375"	.109375"	.109375"	.1250"																																																				
Balls	15 - 1 mm	11 - 1/16"	15 - 3/64"	16 - 3/64"	26 - 1/32"	25 - 1 mm																																																				
Load Rating (lbs.) 5000 rpm	3.4	4.4	3.6	3.6	2.5	3.5																																																				
TOLERANCES SAME AS STANDARD RADIAL SERIES																																																										
 <p>flanged radial series</p>		<table border="1"> <thead> <tr> <th>Bearing No.</th> <th>3F</th> <th>4F</th> <th>5F</th> <th>518F</th> <th>5632F</th> </tr> </thead> <tbody> <tr> <td>O. D. (D)</td> <td>.1875"</td> <td>.2500"</td> <td>.3125"</td> <td>.3125"</td> <td>.3125"</td> </tr> <tr> <td>Flange O. D. (FD)</td> <td>.234"</td> <td>.296"</td> <td>.359"</td> <td>.359"</td> <td>.359"</td> </tr> <tr> <td>Bore (B)</td> <td>.0550"</td> <td>.078125"</td> <td>.09375"</td> <td>.1250"</td> <td>.1875"</td> </tr> <tr> <td>Width (W)</td> <td>.078"</td> <td>.093"</td> <td>.109"</td> <td>.109"</td> <td>.109"</td> </tr> <tr> <td>Flange width (FW)</td> <td>.023"</td> <td>.023"</td> <td>.023"</td> <td>.023"</td> <td>.023"</td> </tr> <tr> <td colspan="6">TOLERANCES (D) + .0000" - .0002" (FD) ± .005" (B) + .0000" - .0002" (W) + .000" - .001" (FW) + .000" - .003" LOAD RATINGS SAME AS STANDARD BEARINGS</td> </tr> </tbody> </table>	Bearing No.	3F	4F	5F	518F	5632F	O. D. (D)	.1875"	.2500"	.3125"	.3125"	.3125"	Flange O. D. (FD)	.234"	.296"	.359"	.359"	.359"	Bore (B)	.0550"	.078125"	.09375"	.1250"	.1875"	Width (W)	.078"	.093"	.109"	.109"	.109"	Flange width (FW)	.023"	.023"	.023"	.023"	.023"	TOLERANCES (D) + .0000" - .0002" (FD) ± .005" (B) + .0000" - .0002" (W) + .000" - .001" (FW) + .000" - .003" LOAD RATINGS SAME AS STANDARD BEARINGS																			
	Bearing No.	3F	4F	5F	518F	5632F																																																				
O. D. (D)	.1875"	.2500"	.3125"	.3125"	.3125"																																																					
Flange O. D. (FD)	.234"	.296"	.359"	.359"	.359"																																																					
Bore (B)	.0550"	.078125"	.09375"	.1250"	.1875"																																																					
Width (W)	.078"	.093"	.109"	.109"	.109"																																																					
Flange width (FW)	.023"	.023"	.023"	.023"	.023"																																																					
TOLERANCES (D) + .0000" - .0002" (FD) ± .005" (B) + .0000" - .0002" (W) + .000" - .001" (FW) + .000" - .003" LOAD RATINGS SAME AS STANDARD BEARINGS																																																										
 <p>grooved radial series</p>		<table border="1"> <thead> <tr> <th>Bearing No.</th> <th>3G</th> <th>4G</th> <th>5G</th> <th>518G</th> <th>5532G</th> <th>5632G</th> </tr> </thead> <tbody> <tr> <td>O. D. (D)</td> <td>.21875"</td> <td>9/32"</td> <td>.34375"</td> <td>.34375"</td> <td>.34375"</td> <td>.34375"</td> </tr> <tr> <td>Groove root dia. (GD)</td> <td>.1875"</td> <td>.2500"</td> <td>.3125"</td> <td>.3125"</td> <td>.3125"</td> <td>.3125"</td> </tr> <tr> <td>Groove radius (GR)</td> <td>.023"</td> <td>.031"</td> <td>.031"</td> <td>.031"</td> <td>.023"</td> <td>.023"</td> </tr> <tr> <td>Bore (B)</td> <td>.0550"</td> <td>.078125"</td> <td>.09375"</td> <td>.1250"</td> <td>.15625"</td> <td>.1875"</td> </tr> <tr> <td>Balls</td> <td>8 - 3/64"</td> <td>8 - 1/16"</td> <td>10 - 1/16"</td> <td>11 - 1/16"</td> <td>15 - 3/64"</td> <td>16 - 3/64"</td> </tr> <tr> <td colspan="7">TOLERANCES AND LOAD RATINGS SAME AS STANDARD BEARINGS WIDTHS SAME AS STANDARD BEARINGS</td> </tr> </tbody> </table>	Bearing No.	3G	4G	5G	518G	5532G	5632G	O. D. (D)	.21875"	9/32"	.34375"	.34375"	.34375"	.34375"	Groove root dia. (GD)	.1875"	.2500"	.3125"	.3125"	.3125"	.3125"	Groove radius (GR)	.023"	.031"	.031"	.031"	.023"	.023"	Bore (B)	.0550"	.078125"	.09375"	.1250"	.15625"	.1875"	Balls	8 - 3/64"	8 - 1/16"	10 - 1/16"	11 - 1/16"	15 - 3/64"	16 - 3/64"	TOLERANCES AND LOAD RATINGS SAME AS STANDARD BEARINGS WIDTHS SAME AS STANDARD BEARINGS													
	Bearing No.	3G	4G	5G	518G	5532G	5632G																																																			
O. D. (D)	.21875"	9/32"	.34375"	.34375"	.34375"	.34375"																																																				
Groove root dia. (GD)	.1875"	.2500"	.3125"	.3125"	.3125"	.3125"																																																				
Groove radius (GR)	.023"	.031"	.031"	.031"	.023"	.023"																																																				
Bore (B)	.0550"	.078125"	.09375"	.1250"	.15625"	.1875"																																																				
Balls	8 - 3/64"	8 - 1/16"	10 - 1/16"	11 - 1/16"	15 - 3/64"	16 - 3/64"																																																				
TOLERANCES AND LOAD RATINGS SAME AS STANDARD BEARINGS WIDTHS SAME AS STANDARD BEARINGS																																																										
 <p>separable magneto series</p>		<table border="1"> <thead> <tr> <th>Bearing No.</th> <th>3M</th> <th>4M</th> <th>5M</th> <th>518M</th> </tr> </thead> <tbody> <tr> <td>O. D. (D)</td> <td>.1875"</td> <td>.25"</td> <td>.3125"</td> <td>.3125"</td> </tr> <tr> <td>Bore (B)</td> <td>.0550"</td> <td>.078125"</td> <td>.09375"</td> <td>.1250"</td> </tr> <tr> <td>Width (W)</td> <td>.078125"</td> <td>.09375"</td> <td>.109375"</td> <td>.109375"</td> </tr> <tr> <td>Balls*</td> <td>6 - 3/64"</td> <td>6 - 1/16"</td> <td>8 - 1/16"</td> <td>9 - 1/16"</td> </tr> <tr> <td>Load Rating (lbs.) 5000 rpm</td> <td>2.2</td> <td>4.0</td> <td>4.8</td> <td>3.3</td> </tr> <tr> <td colspan="5">*Subject to variations with non-metallic retainers. TOLERANCES SAME AS STANDARD RADIAL SERIES</td> </tr> </tbody> </table>	Bearing No.	3M	4M	5M	518M	O. D. (D)	.1875"	.25"	.3125"	.3125"	Bore (B)	.0550"	.078125"	.09375"	.1250"	Width (W)	.078125"	.09375"	.109375"	.109375"	Balls*	6 - 3/64"	6 - 1/16"	8 - 1/16"	9 - 1/16"	Load Rating (lbs.) 5000 rpm	2.2	4.0	4.8	3.3	*Subject to variations with non-metallic retainers. TOLERANCES SAME AS STANDARD RADIAL SERIES																									
	Bearing No.	3M	4M	5M	518M																																																					
O. D. (D)	.1875"	.25"	.3125"	.3125"																																																						
Bore (B)	.0550"	.078125"	.09375"	.1250"																																																						
Width (W)	.078125"	.09375"	.109375"	.109375"																																																						
Balls*	6 - 3/64"	6 - 1/16"	8 - 1/16"	9 - 1/16"																																																						
Load Rating (lbs.) 5000 rpm	2.2	4.0	4.8	3.3																																																						
*Subject to variations with non-metallic retainers. TOLERANCES SAME AS STANDARD RADIAL SERIES																																																										
 <p>pivot series</p>		<table border="1"> <thead> <tr> <th>Bearing No.</th> <th>1.5P</th> <th>3P</th> <th>4P</th> <th>5P</th> <th>7½P</th> <th>10P</th> </tr> </thead> <tbody> <tr> <td>O. D. (D)</td> <td>.0590"</td> <td>.1181"</td> <td>.1577"</td> <td>.1968"</td> <td>.2953"</td> <td>.3937"</td> </tr> <tr> <td>Width (W)</td> <td>.0472"</td> <td>.0709"</td> <td>.0945"</td> <td>.1181"</td> <td>.1772"</td> <td>.2362"</td> </tr> <tr> <td>Shaft (S) Min.</td> <td>.020"</td> <td>.030"</td> <td>.040"</td> <td>.050"</td> <td>.075"</td> <td>.100"</td> </tr> <tr> <td>Balls</td> <td>4 - 1/64"</td> <td>4 - 1/32"</td> <td>4 - 3/64"</td> <td>4 - 1/16"</td> <td>4 - 3/32"</td> <td>4 - 1/8"</td> </tr> <tr> <td>Load Rating (lbs.) T 1000 rpm</td> <td>.29</td> <td>1.1</td> <td>3.1</td> <td>5.8</td> <td>13.</td> <td>23.2</td> </tr> <tr> <td colspan="7">TOLERANCES (D) + .0000" - .0002" (W) + or - .002" ECCENTRICITY DEPENDS ON SHAFT, RACEWAY AND O.D. CONCENTRIC WITHIN .0002"</td> </tr> </tbody> </table>	Bearing No.	1.5P	3P	4P	5P	7½P	10P	O. D. (D)	.0590"	.1181"	.1577"	.1968"	.2953"	.3937"	Width (W)	.0472"	.0709"	.0945"	.1181"	.1772"	.2362"	Shaft (S) Min.	.020"	.030"	.040"	.050"	.075"	.100"	Balls	4 - 1/64"	4 - 1/32"	4 - 3/64"	4 - 1/16"	4 - 3/32"	4 - 1/8"	Load Rating (lbs.) T 1000 rpm	.29	1.1	3.1	5.8	13.	23.2	TOLERANCES (D) + .0000" - .0002" (W) + or - .002" ECCENTRICITY DEPENDS ON SHAFT, RACEWAY AND O.D. CONCENTRIC WITHIN .0002"													
	Bearing No.	1.5P	3P	4P	5P	7½P	10P																																																			
O. D. (D)	.0590"	.1181"	.1577"	.1968"	.2953"	.3937"																																																				
Width (W)	.0472"	.0709"	.0945"	.1181"	.1772"	.2362"																																																				
Shaft (S) Min.	.020"	.030"	.040"	.050"	.075"	.100"																																																				
Balls	4 - 1/64"	4 - 1/32"	4 - 3/64"	4 - 1/16"	4 - 3/32"	4 - 1/8"																																																				
Load Rating (lbs.) T 1000 rpm	.29	1.1	3.1	5.8	13.	23.2																																																				
TOLERANCES (D) + .0000" - .0002" (W) + or - .002" ECCENTRICITY DEPENDS ON SHAFT, RACEWAY AND O.D. CONCENTRIC WITHIN .0002"																																																										
 <p>angular contact series</p>		<table border="1"> <thead> <tr> <th>Bearing No.</th> <th>2A</th> <th>3A</th> <th>4A</th> <th>6A</th> <th>6A7B</th> </tr> </thead> <tbody> <tr> <td>O. D. (D)</td> <td>.1250"</td> <td>.1875"</td> <td>.2500"</td> <td>.3750"</td> <td>.3750"</td> </tr> <tr> <td>Width (W)</td> <td>.046875"</td> <td>.0700"</td> <td>.09375"</td> <td>.140625"</td> <td>.1406"</td> </tr> <tr> <td>Shaft (SE) Max. (without cone)</td> <td>.032"</td> <td>.048"</td> <td>.063"</td> <td>.094"</td> <td>.1250"</td> </tr> <tr> <td>P Shaft (S) Min.</td> <td>.042"</td> <td>.062"</td> <td>.0850"</td> <td>.124"</td> <td>.150"</td> </tr> <tr> <td>Cone (C) Max.</td> <td>60°</td> <td>60°</td> <td>60°</td> <td>60°</td> <td>60°</td> </tr> <tr> <td colspan="6">TOLERANCES (D) + .0000" - .0002" (W) + .000" - .002" Eccentricity same as for Pivot Series. Consult Engineering Department for other angles and speeds.</td> </tr> </tbody> </table>	Bearing No.	2A	3A	4A	6A	6A7B	O. D. (D)	.1250"	.1875"	.2500"	.3750"	.3750"	Width (W)	.046875"	.0700"	.09375"	.140625"	.1406"	Shaft (SE) Max. (without cone)	.032"	.048"	.063"	.094"	.1250"	P Shaft (S) Min.	.042"	.062"	.0850"	.124"	.150"	Cone (C) Max.	60°	60°	60°	60°	60°	TOLERANCES (D) + .0000" - .0002" (W) + .000" - .002" Eccentricity same as for Pivot Series. Consult Engineering Department for other angles and speeds.																			
	Bearing No.	2A	3A	4A	6A	6A7B																																																				
O. D. (D)	.1250"	.1875"	.2500"	.3750"	.3750"																																																					
Width (W)	.046875"	.0700"	.09375"	.140625"	.1406"																																																					
Shaft (SE) Max. (without cone)	.032"	.048"	.063"	.094"	.1250"																																																					
P Shaft (S) Min.	.042"	.062"	.0850"	.124"	.150"																																																					
Cone (C) Max.	60°	60°	60°	60°	60°																																																					
TOLERANCES (D) + .0000" - .0002" (W) + .000" - .002" Eccentricity same as for Pivot Series. Consult Engineering Department for other angles and speeds.																																																										
 <p>thrust series</p>		<table border="1"> <thead> <tr> <th>Bearing No.</th> <th>2T</th> <th>4T</th> <th>7T</th> </tr> </thead> <tbody> <tr> <td>O. D. (D)</td> <td>.1250"</td> <td>.2500"</td> <td>.4375"</td> </tr> <tr> <td>Bore (B)</td> <td>.0400"</td> <td>.09375"</td> <td>.1250"</td> </tr> <tr> <td>Width (W)</td> <td>.0625"</td> <td>.09375"</td> <td>.1875"</td> </tr> <tr> <td>Balls</td> <td>8 - 1/32"</td> <td>8 - 3/64"</td> <td>6 - 3/32"</td> </tr> <tr> <td>Load Rating (lbs.) 5000 rpm</td> <td>.9</td> <td>2.0</td> <td>14.2</td> </tr> <tr> <td colspan="4">TOLERANCES (D) + .0000" - .0002" (B) + .0000" - .0002" (W) + .000" - .002"</td> </tr> </tbody> </table>	Bearing No.	2T	4T	7T	O. D. (D)	.1250"	.2500"	.4375"	Bore (B)	.0400"	.09375"	.1250"	Width (W)	.0625"	.09375"	.1875"	Balls	8 - 1/32"	8 - 3/64"	6 - 3/32"	Load Rating (lbs.) 5000 rpm	.9	2.0	14.2	TOLERANCES (D) + .0000" - .0002" (B) + .0000" - .0002" (W) + .000" - .002"																															
	Bearing No.	2T	4T	7T																																																						
O. D. (D)	.1250"	.2500"	.4375"																																																							
Bore (B)	.0400"	.09375"	.1250"																																																							
Width (W)	.0625"	.09375"	.1875"																																																							
Balls	8 - 1/32"	8 - 3/64"	6 - 3/32"																																																							
Load Rating (lbs.) 5000 rpm	.9	2.0	14.2																																																							
TOLERANCES (D) + .0000" - .0002" (B) + .0000" - .0002" (W) + .000" - .002"																																																										

Suppliers to the World's Foremost Instrument Manufacturers



MINIATURE Precision BEARINGS

Incorporated

KEENE, NEW HAMPSHIRE

The Remarkable New Dielectric Gas

SULFUR HEXAFLUORIDE

SF₆

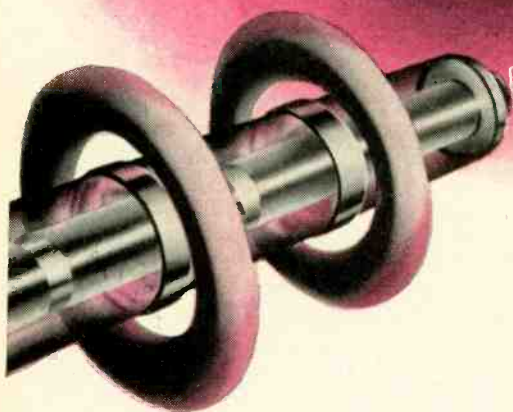

For Transformers—Co-axial Cables—

Capacitors—and other High Voltage Equipment.

Some practical advantages of Sulfur Hexafluoride:

- 1 Permits operation at higher voltages or lower pressures than are possible with air or nitrogen; i.e. increased voltage at the same pressure, or the same voltage at reduced pressure.
- 2 Reduces or eliminates corona.
- 3 Offers opportunity for simplified design and reduced dimensions of equipment; also lower construction and maintenance costs occasioned by lower pressure required.
- 4 Makes it possible to maintain voltages over greater distance in cables with lower power loss.
- 5 Has minimum permanent or cumulative effect in event of breakdown.
- 6 Is non-flammable.

WHEREVER A GASEOUS OR LIQUID DIELECTRIC has application, General Chemical Sulfur Hexafluoride merits prompt investigation. This remarkable new insulating gas has a dielectric strength comparable to that of mineral oil at moderate pressures! With it, operating efficiency can be stepped up in many types of electrical equipment, while overall construction and maintenance costs may often be lowered.

GENERAL'S Sulfur Hexafluoride is an extremely pure material that meets the most exacting dielectric requirements: it is remarkably inert; possesses exceptional thermal stability, and has a dielectric strength substantially higher than that of air or nitrogen.



For commercial quantities or more detailed technical information, consult General Chemical's Product Development Department. Please use business letterhead when writing.

SULFUR HEXAFLUORIDE

Formula: SF₆
Molecular Weight: 146.06
Melting Point: -50.8°C
Sublimation Temperature: -63.8°C
Critical Temperature: 45.6°C
Critical Pressure: 540 p.s.i.a.
Vapor Pressure:
Temp. (°C) Pressure (p.s.i.a.)

60 cycle Dielectric Strength (tungsten rod and 1" diam. sphere, 1" spacing)

	Pressure, p.s.i.g.			
	0	10	20	30
Sulfur Hexafluoride, kilovolts	70	107	120	122
Nitrogen, kilovolts	13	17	21	25

PRODUCT DEVELOPMENT DEPARTMENT

GENERAL CHEMICAL DIVISION

ALLIED CHEMICAL & DYE CORPORATION

40 Rector Street, New York 6, N. Y.

Offices: Albany • Atlanta • Baltimore • Birmingham • Boston • Bridgeport • Buffalo
Charlotte • Chicago • Cleveland • Denver • Detroit • Houston • Jacksonville
Los Angeles • Minneapolis • New York • Philadelphia • Pittsburgh • Providence
San Francisco • Seattle • St. Louis • Yakima (Wash.)

In Wisconsin: General Chemical Company, Inc., Milwaukee, Wis.

In Canada: The Nichols Chemical Company, Limited • Montreal • Toronto • Vancouver

Centralab introduced carbon controls to the radio industry 25 years ago! Today, there's no substitute for Centralab control research and development.

Centralab

Division of GLOBE-UNION INC.

934 East Keefe Avenue
Milwaukee 1, Wisconsin

CONTROLS

BLUE SHAFT RADIOHMS

A new line of modern carbon type controls, $\frac{1}{8}$ " diameter. Distinctive blue shafts. Switch types are factory assembled and tested, for smoothest action and instant usefulness. Rating, $\frac{1}{2}$ watt. Standard shafts, 3" universal fluted full length mill. Type BSK units have special $2\frac{1}{8}$ " split knurl shafts. Switches are universal DPST, easily wired for SPST and 3-wire usage.

Cat. No.	Cat. No. Switch Type	Ohms Max.	Taper	List Price	List Price
Plain				Plain	Switch Type
B-4	B-4-S	500	C1	\$1.25	\$1.75
B-5	B-5-S	1,000	C1	1.25	1.75
B-6	B-6-S	2,000	C1	1.25	1.75
B-7	B-7-S	2,500	C1	1.25	1.75
B-8	B-8-S	3,000	C1	1.25	1.75
B-10	B-10-S	5,000	C1	1.25	1.75
B-11	B-11-S	5,000	C2	1.25	1.75
B-12	B-12-S	5,000	C5	1.25	1.75
B-14	B-14-S	10,000	C1	1.25	1.75
B-15	B-15-S	10,000	C2	1.25	1.75
B-16	B-16-S	10,000	C6	1.25	1.75
B-20	B-20-S	15,000	C6	1.25	1.75
B-22	B-22-S	20,000	C1	1.25	1.75
B-24	B-24-S	20,000	C6	1.25	1.75
B-26	B-26-S	25,000	C1	1.25	1.75
B-27	B-27-S	25,000	C5	1.25	1.75
B-28	B-28-S	25,000	C6	1.25	1.75
B-31	B-31-S	50,000	C1	1.25	1.75
B-32	B-32-S	50,000	C2	1.25	1.75
B-35	B-35-S	75,000	C1	1.25	1.75
B-40	B-40-S	100,000	C1	1.25	1.75
B-41	B-41-S	100,000	C2	1.25	1.75
B-44	B-44-S	150,000	C2	1.25	1.75
B-46	B-46-S	200,000	C1	1.25	1.75
B-50	B-50-S	250,000	C1	1.25	1.75
B-51	B-51-S	250,000	C2	1.25	1.75
B-52	B-52-S	250,000	C5	1.25	1.75
BT-53	BT-53-S	250,000	C11	1.85	2.35
BT-55	BT-55-S	250,000	C13	1.85	2.35
BT-57	BT-57-S	350,000	C12	1.85	2.35
B-59	B-59-S	500,000	C1	1.25	1.75
B-60	B-60-S	500,000	C2	1.00	1.50
B-61	B-61-S	500,000	C1	1.25	1.75
BT-65	BT-65-S	500,000	C11	1.85	2.35
BT-66	BT-66-S	500,000	C12	1.85	2.35
BT-67	BT-67-S	500,000	C13	1.85	2.35
B-68	B-68-S	1 Megohm	C1	1.25	1.75
B-69	B-69-S	1 Megohm	C1	1.25	1.75
B-70	B-70-S	1 Megohm	C2	1.00	1.50
BT-71	BT-71-S	1 Megohm	C11	1.85	2.35
BT-72	BT-72-S	1 Megohm	C12	1.85	2.35
BT-73	BT-73-S	1 Megohm	C13	1.85	2.35
BT-74	BT-74-S	1 Megohm	C16	1.85	2.35
B-75	B-75-S	2 Megohms	C1	1.25	1.75
B-76	B-76-S	2 Megohms	C2	1.25	1.75
B-77	B-77-S	2 Megohms	C5	1.25	1.75
BT-78	BT-78-S	2 Megohms	C11	1.85	2.35
BT-79	BT-79-S	2 Megohms	C12	1.85	2.35
BT-80	BT-80-S	2 Megohms	C13	1.85	2.35
BT-81	BT-81-S	2 Megohms	C15	1.85	2.35
BT-82	BT-82-S	2 Megohms	C18	1.85	2.35
B-83	B-83-S	2.5 Megohms	C1	1.25	1.75
B-84	B-84-S	3 Megohms	C1	1.25	1.75
B-85	B-85-S	3 Megohms	C2	1.25	1.75
B-86	B-86-S	4 Megohms	C1	1.25	1.75
B-87	B-87-S	5 Megohms	C1	1.25	1.75
B-98	B-98-S	10 Megohms	C1	1.25	1.75

MODEL BSK — with Split Knurl Shafts, $2\frac{1}{8}$ " long

BSK-60	BSK-60-S	500,000	C2	1.10	1.60
BSK-70	BSK-70-S	1 Megohm	C2	1.10	1.60
BTSK-66	BTSK-66-S	500,000	C12	1.85	2.35
BTSK-72	BTSK-72-S	1 Megohm	C12	1.85	2.35

MODEL BB TWIN RADIOHMS

Two B Radiohms mounted in tandem on a single shaft which rotates both sections. No switch types. Rating $\frac{1}{2}$ watt. Shaft, 3" universal fluted full length mill.

BB-100	10,000	25,000	C4	C3	\$2.50
BB-101	10,000	50,000	C2	C1	2.50
BB-102	100,000	100,000	C2	C2	2.50
BB-103	250,000	250,000	C2	C2	2.50
BB-104	500,000	500,000	C2	C2	2.50

HANDY PLASTI-PAKS MODELS B AND BSK CONTROLS IN PLASTIC BOXES

The widely used half megohm and one megohm controls of C2 taper are available in hinged lid plastic boxes, size $8\frac{1}{2} \times 4\frac{1}{4} \times 1\frac{1}{4}$ " deep. There is no extra charge for this convenient container.

BP-1 PAK — Contains 12 Cat. No. B-60 plain controls, 500,000 ohms; C2 taper. LIST PRICE — \$12.00.
BP-2 PAK — Contains 12 Cat. No. B-70 plain controls, 1 megohm, C2 taper. LIST PRICE — \$12.00.
BP-3 PAK — Contains 12 Cat. No. B-60-S switch controls, 500,000 ohms; C2 taper. LIST PRICE — \$18.00.

BP-4 PAK — Contains 12 Cat. No. B-70-S switch controls, 1 megohm, C2 taper. LIST PRICE — \$18.00.
BP-5 PAK — Contains 12 Cat. No. BSK-60 plain controls, 500,000 ohms, C2 taper, with split knurl shafts. LIST PRICE — \$13.20.
BP-6 PAK — Contains 12 Cat. No. BSK-70 plain controls, 1 megohm, C2 taper, with knurl shafts. LIST PRICE — \$13.20.
BP-7 PAK — Contains 12 Cat. No. BSK-60-S Switch Type Controls, 500,000 ohms, C2 taper, with split knurl shafts. LIST PRICE — \$19.20.
BP-8 PAK — Contains 12 Cat. No. BSK-70-S Switch Type Controls, 1 megohm, C2 taper, with split knurl shafts. LIST PRICE — \$19.20.

MODEL N RADIOHMS STANDARD $1\frac{1}{32}$ " SINGLE CONTROLS



Popular, medium size control of the carbon type. Diameter $1-3/32$ inch. Plain, no switch construction. Switches are available separately and can be attached easily. Rating $\frac{1}{2}$ watt. Standard shafts $3\frac{1}{2}$ " long, universal fluted full length mill.

Cat. No.	Ohms Max.	Taper	List Price
N-153	1000 C1		\$1.25
N-106	5000 C1		1.25
N-107	10000 C1		1.25
N-112	20000 C6		1.25
N-113	25000 C1		1.25
N-114	50000 C1		1.25
N-115	50000 C2		1.25
N-116	100000 C1		1.25
N-117	100000 C2		1.25
N-102	250000 C2		1.25
N-118	500000 C1		1.25
N-103	500000 C2		1.00
NT-120	500000 C13		1.85
NT-149	500000 C11		1.85
NT-104	1 Megohm C2		1.00
NT-150	1 Megohm C12		1.85
NT-121	1 Megohm C13		1.85
N-155	2 Megohms C2		1.25
NT-151	2 Megohms C15		1.85
NT-152	2 Megohms C12		1.85
NT-122	2 Megohms C13		1.85
NT-153	2 Megohms C11		1.85
N-177	5 Megohms C1		1.25
N-178	10 Megohms C1		1.25

MODEL NK SINGLE CONTROLS SPLIT KNURL SHAFTS — WITHOUT SWITCHES

Cat. No.	Ohms Max.	Taper	List Price
NK-140	500,000	C2	\$1.10
NK-141	1 Megohm	C2	1.10

SWITCHES FOR MODELS N, NK AND AN CONTROLS

These switch units replace covers on controls and when attached are both firmly seated and positive in action. RATING — 3 amperes, 125 volts a.c.; 1 ampere, 250 volts a.c. Approved by Underwriters' Laboratories.

Cat. No.	Switch Action	List Price
K-155	Single pole, single throw	\$.50
K-156	Single pole, double throw	.65
K-157	Double pole, single throw	.65
K-158	Four pole	.65
K-169	Single pole, single throw, dummy lug	.65

ADASHAFT SHAFTS

Order separately as required. They fit Adashaft basic controls readily.

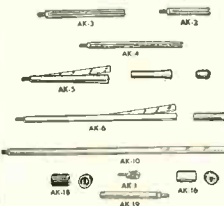

Cat. No.	Description	List Price
AK-1	Fingertip Knurl with screwdriver slot, length $\frac{3}{8}$ " from bushing	\$.15
AK-2	1-9/16" with .078" Slot.	.20
AK-3	3" Universal Fluted Mill	.25
AK-4	$\frac{3}{8}$ " Split Knurl	.15
AK-5	$\frac{3}{8}$ " Auto Type	.55
AK-6	$\frac{3}{8}$ " Auto Type	.65
AK-10	10" With Flat Mill .216x4-5/16"	.30
AK-16	Coupler—adjustable for $\frac{1}{4}$ " and $\frac{1}{2}$ " or $\frac{3}{8}$ " and $\frac{1}{2}$ "	.40
AK-18	Coupler—Insulating Auto Type Slotted	.65
AK-19	Insulating Nylon, 2-1/16" from bushing, with screwdriver slot.	.55

HANDY ADASHAFT KIT — In hinged lid plastic box, $8\frac{1}{2} \times 4\frac{1}{4} \times 1\frac{1}{4}$ " x $1\frac{1}{4}$ ", are the following: Controls: 6 AN-60 $\frac{1}{2}$ meg.; 3 AN-70 1 meg.; 1 ANT-60 $\frac{1}{2}$ meg. tapped. Switches: 4 K-155 SPST; 1 K-157 DPST. Shafts: 7 AK-4, 3 AK-3, 2 AK-1, 1 AK-2, 1 AK-5, 1 AK-19, Couplers: 2 AK-16. To order, specify CAT. NO. AN-100 KIT. List Price — \$17.50

CENTRALAB TV REPLACEMENTS
Custom Controls — for exact replacements — are listed in Centralab Special Control Bulletin. Also available: Centralab TV Control Guide — 25c.

ADASHAFT RADIOHMS BUY CONTROLS WITHOUT SHAFTS — ADD A SHAFT



Built in popular Model N construction, the basic control unit is furnished without a shaft. Select the required shaft from wide assortment, as listed. This new idea in controls offers flexibility and economy. By a unique mechanical arrangement, shafts can be almost instantly locked into the control. Adashaft controls can be converted to the switch type by adding switches as listed in column to the left. Rating, $\frac{1}{2}$ watt. BE SURE TO ORDER SHAFTS SEPARATELY.

Cat. No.	Ohms Resis.	Taper	List Price
AN-5	1000 C1		\$1.10
AN-6	5000 C1		1.10
AN-7	2500 C1		1.10
AN-10	5000 C1		1.10
AN-11	5000 C2		1.10
AN-12	5000 C5		1.10
AN-13	6500 C1		1.10
AN-14	10,000 C1		1.10
AN-22	20,000 C1		1.10
AN-23	20,000 C5		1.10
AN-26	25,000 C1		1.10
AN-27	25,000 C5		1.10
AN-31	50,000 C1		1.10
AN-32	50,000 C2		1.10
AN-40	100,000 C1		1.10
AN-41	100,000 C2		1.10
AN-50	250,000 C1		1.10
AN-51	250,000 C2		1.10
AN-52	250,000 C5		1.10
AN-59	500,000 C1		1.10
AN-60	500,000 C2		.95
AN-61	500,000 C5		1.10
ANT-66	500,000 C12		1.70
AN-68	1 megohm		C5 1.10
AN-69	1 megohm		C1 1.10
AN-70	1 megohm		C2 .95
ANT-73	1 megohm		C13 1.70
AN-75	2 megohms		C1 1.10
AN-76	2 megohms		C2 1.10
AN-77	2 megohms		C5 1.10
ANT-78	2 megohms		C11 1.70
ANT-80	2 megohms		C13 1.70
AN-83	2.5 megohms		C1 1.10
AN-84	3 megohms		C1 1.10
AN-86	4 megohms		C1 1.10
AN-87	5 megohms		C1 1.10
AN-98	10 megohms		C1 1.10

MODEL V WIREWOUND CONTROLS — 3 TAP — LINEAR

1-7/16" diam. x 9/16" depth, 3" fluted mill shafts. Switches available.

Cat. No.	Ohms List	Cat. No.	Ohms List
V-100	2 \$1.85	V-121	100 \$1.85
V-102	4 1.85	V-123	200 1.85
V-104	6 1.85	V-125	300 1.85
V-106	8 1.85	V-126	400 1.85
V-108	10 1.85	V-127	500 1.85
V-109	15 1.85	V-128	750 1.85
V-110	20 1.85	V-129	1000 1.85
V-111	25 1.85	V-131	2000 1.85
V-112	30 1.85	V-133	3000 1.85
V-114	40 1.85	V-134	4000 1.85
V-116	50 1.85	V-135	5000 1.85
V-117	60 1.85	V-136	7500 1.85
V-118	75 1.85	V-137	10,000 1.85

Cat. No.	Model V Switches	List Price
K-10	Single pole, single throw	\$.60
K-11	Single pole, double throw	.75
K-12	Double pole, single throw	.75

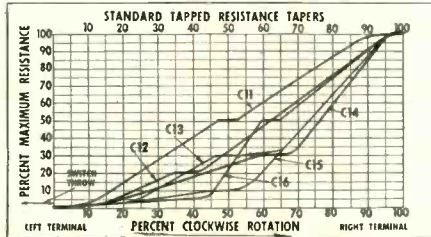
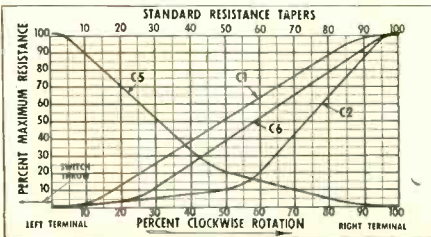

See the Centralab Distributor in your neighborhood . . . over 700 in U. S. and Canada

SWITCHES



Division of GLOBE-UNION INC.

934 East Keefe Avenue
Milwaukee 1, Wisconsin

Centralab offers a complete line of switches to meet nearly every low-power and medium duty requirement.

ROTARY SELECTOR SWITCHES PHENOLIC INSULATION

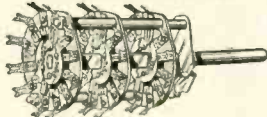

Series 1400 offers compact design and quality construction. Laminated phenolic insulation. Mtg. bushing $\frac{3}{8}$ " x 32 thread, $\frac{3}{8}$ " long. Shaft, $1\frac{1}{2}$ " long. Index, positive, 30°. Adjustable stop. Revisions are easily made, if later required, due to availability of all parts separately. See listing under hardware. Packaged with mtg. nut, lockwasher and $1\frac{1}{4}$ " black bar knob.

Cat. No.	per Tot. Sec. No.	Tot. Sec. No.	Posi- tions	List Price
1400	1	1	2 to 6	\$1.25
1402	1	1	2 to 11	1.50
1404	2	1	2 to 5	1.50
1406	3	1	2 to 3	1.75
1408	4	1	2 to 6	1.75
1410	1	2	2 to 6	2.00
1412	1	2	2 to 11	2.25
1414	2	2	2 to 5	2.50
1416	3	2	2 to 3	2.75
1418	4	2	2 to 6	2.75
1420	1	3	2 to 6	2.75
1422	1	3	2 to 11	3.00
1424	2	3	2 to 5	3.25
1426	1	4	2 to 6	3.50
1428	1	4	2 to 11	3.75
1430	2	4	2 to 5	4.50

NON-SHORTING (make before break)

Cat. No.	per Tot. Sec. No.	Tot. Sec. No.	Posi- tions	List Price
1401	1	1	2 to 6	1.25
1403	1	1	2 to 11	1.50
1405	2	1	2 to 5	1.50
1407	3	1	2 to 3	1.75
1409	4	1	2 to 6	1.75
1411	1	2	2 to 6	2.00
1413	1	2	2 to 11	2.25
1415	2	2	2 to 5	2.50
1417	3	2	2 to 3	2.75
1419	4	2	2 to 6	2.75
1421	1	3	2 to 6	2.75
1423	1	3	2 to 11	3.00
1425	2	3	2 to 5	3.25
1427	1	4	2 to 6	3.50
1429	1	4	2 to 11	3.75
1431	2	4	2 to 5	4.50

PHENOLIC SECTIONS FOR 1400 SERIES

Cat. No.	Cat. No.	Non-Short. Short. Poles	Posi- tions	List Price
A	H	1	2 to 6	\$.50
B	J	1	2 to 11	.75
C	K	2	2 to 5	.75
D	L	3	2 to 3	1.00
E	M	4	2 to 6	1.50
EE	F	1	2 to 3	1.50
EE	F	1	2 to 5	.75

Unused contacts on one side of common connected and shorted out.

G 1 2 to 10 1.00
All unused contacts connected and shorted out.

N Combine N and P for resistance decade switch .75
P Special section for capacitance decade switch .75
Q



ROTARY SELECTOR SWITCHES STEATITE INSULATION

2500 Series Switches have highest quality Steatite insulation and meet critical requirements of r.f. circuit applications. Mtg. bushing, $\frac{3}{8}$ " x 32 thread, $\frac{3}{8}$ " long. Shaft, $1\frac{1}{2}$ " long. Index, positive, 30°. Adjustable stop. Parts, including sections, also available separately. See listings below. Packaged with mtg. nut, lockwasher and $1\frac{1}{4}$ " black bar knob.

Cat. No.	per Tot. Sec. No.	Tot. Sec. No.	Posi- tions	List Price
2500	1	1	2 to 6	\$2.25
2502	1	1	2 to 11	2.25
2504	2	1	2 to 5	2.25
2506	3	1	2 to 3	2.25
2510	1	2	2 to 6	3.50
2512	1	2	2 to 11	3.50
2514	2	2	2 to 5	3.50
2516	3	2	2 to 3	3.50
2520	1	3	2 to 6	5.00
2522	1	3	2 to 11	5.00
2524	2	3	2 to 5	5.00

SHORTING CONTACTS (make before break)

Cat. No.	per Tot. Sec. No.	Tot. Sec. No.	Posi- tions	List Price
2501	1	1	2 to 6	2.25
2503	1	1	2 to 11	2.25
2505	2	1	2 to 5	2.25
2507	3	1	2 to 3	2.25
2511	1	2	2 to 6	3.50
2513	1	2	2 to 11	3.50
2515	2	2	2 to 5	3.50
2517	3	2	2 to 3	3.50
2521	1	3	2 to 6	5.00
2523	1	3	2 to 11	5.00
2525	2	3	2 to 5	5.00

NON-SHORTING (break before make)

Cat. No.	per Tot. Sec. No.	Tot. Sec. No.	Posi- tions	List Price
2501	1	1	2 to 6	2.25
2503	1	1	2 to 11	2.25
2505	2	1	2 to 5	2.25
2507	3	1	2 to 3	2.25
2511	1	2	2 to 6	3.50
2513	1	2	2 to 11	3.50
2515	2	2	2 to 5	3.50
2517	3	2	2 to 3	3.50
2521	1	3	2 to 6	5.00
2523	1	3	2 to 11	5.00
2525	2	3	2 to 5	5.00

STEATITE SECTIONS FOR 2500 SERIES

Cat. No.	Cat. No.	Short. Non-Short. Poles	Posi- tions	List Price
T	X	1	2 to 6	\$1.25
U	Y	1	2 to 11	1.25
R	Rit	2	2 to 5	1.25
S	SS	3	2 to 3	1.25
W	Z	4	2 to 6	1.25
GG		1	2 to 10	1.25

With GG, unused contacts connected and shorted out.

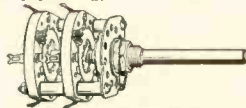

HAM TYPE SWITCHES

Heavier than normal Steatite insulation. Use with tubes operating up to 1000 volts and inputs up to 150 watts. Non-shorting, 90° positive index. Mtg. bushing $\frac{3}{8}$ " x 32 thread, $\frac{3}{8}$ " long. Shaft, $1\frac{1}{2}$ " long.

Cat. No.	per Tot. Sec. No.	Tot. Sec. No.	Posi- tions	List Price
2542	1	1	2 to 4	\$2.25
2543	1	2	2 to 4	3.50
2544	1	3	2 to 4	4.75
2545	1	4	2 to 4	6.00
2546	1	5	2 to 4	7.25

SEPARATE STEATITE SECTIONS — furnished with 4 fibre cushion washers. CAT. No. XX 1 pole 2 to 4 positions Non-shorting \$1.25.

TIE BOLT NUTS AND LOCKWASHERS — $\frac{3}{16}$ " hex. nut $\frac{3}{32}$ " thick. No. 5-40 thread, cadmium plated steel. Lockwashers — split ring, steel, cadmium plated. Packaged 12 per envelope.*

Nut—Cat. No. P-147 .15 per Doz. Lockwasher—Cat. No. P-148 .15 per Doz.

DIAL PLATES AND KNOBS — Packaged singly.*

Cat. No.	Description	Each	Cat. No.	Description	Each
P-115	Dial Plate 1 to 5	.20	P-119	$1\frac{1}{2}$ " Round Arrow Knob, Black	.20
P-116	Dial Plate 1 to 6	.20	P-120	$1\frac{1}{2}$ " Bar Knob, Black	.20
P-117	Dial Plate 1 to 10	.20	P-103	Knob for Lever Switch, Black	.15
P-118	Dial Plate 1 to 11	.20	P-194	Knob for Lever Switch, Red	.20
P-173	Dial Plate 1 to 23	.25	P-195	Knob for Lever Switch, White	.20

*Minimum order quantities.

LEVER ACTION SWITCHES

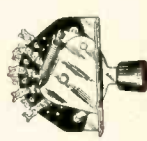

Coil spring index design of very long life. Coil spring easily replaced without removing switch. Mtg. plates available. Black knob is standard.

Cat. No.	Tot. Posi- tion	Type Index	List Price	
1452	2	3	Positive	\$1.25
1453	2	3	Spring Ret.	1.25
1456	4	2	Spring Ret.	1.25
1459	4	2	Positive	1.25
1466	2	3	Pos. Spr. Ret.	1.25

SHORTING CONTACTS (make before break)

Cat. No.	per Tot. Sec. No.	Tot. Sec. No.	Posi- tions	List Price
1452	2	3	Positive	\$1.25
1453	2	3	Spring Ret.	1.25
1456	4	2	Spring Ret.	1.25
1459	4	2	Positive	1.25
1466	2	3	Pos. Spr. Ret.	1.25

NON-SHORTING (break before make)

Cat. No.	per Tot. Sec. No.	Tot. Sec. No.	Posi- tions	List Price
1454	2	3	Positive	1.25
1455	2	3	Spring Ret.	1.25
1457	4	2	Spring Ret.	1.25
1458	4	2	Positive	1.25
1467	2	3	Pos. Spr. Ret.	1.25

MOUNTING PLATES FOR ABOVE

Provides $\frac{3}{4}$ " spacing between switches. Black crackle finish. Width, 2 $\frac{1}{2}$ ".

Cat. No.	Number Switches	Length	List Price
P-1755	1	$\frac{3}{4}$ "	\$.35
P-1756	2	$1\frac{1}{2}$ "	.40
P-1757	3	$2\frac{1}{4}$ "	.50
P-1758	4	3"	.60
P-1759	5	$3\frac{3}{4}$ "	.75

ROTARY SWITCH HARDWARE

SHIELD—Cadmium plate .035" steel shield, for insertion between switch sections to reduce coupling effects. Use with 1400 and 2500 series switches. CAT. NO. P-200 Inter-section Shield. List \$.15.

INDEX ASSEMBLIES

Individually cartoned, all hardware and shaft included, except Basic Index 1435W — as supplied in No. 1500 Kit.

Cat. No.	Description	List Price
P-121	For 1 or 2 sec. switches	1.25
P-122	For 3 or 4 sec. switches	1.75
P-123	For 5 to 6 sec. switches	2.25
1435W	Basic Index only	1.10

HARDWARE AND ACCESSORIES

SPACERS—Cadmium plated seamless brass tubing. .133" I.D., .187" O.D., Chamfered edges. Packaged 12 per envelope*.

Cat. No.	per Lgth. Doz.	Price	Cat. No.	per Lgth. Doz.	Price
P-124	$\frac{1}{4}$ " .15		P-126	$\frac{1}{4}$ " .30	
P-125	$\frac{3}{8}$ " .30		P-127	$\frac{1}{2}$ " .50	
			P-128	1" .50	

DETACHABLE FLAT SHAFTS

.064" x $\frac{1}{4}$ " Cadmium plated steel. Packaged singly*.

Cat. No.	per Lgth. Doz.	Price	Cat. No.	per Lgth. Doz.	Price
P-129	$\frac{1}{8}$ " .30		P-132	$\frac{1}{4}$ " .50	
P-130	$\frac{3}{16}$ " .30		P-133	$\frac{1}{2}$ " .75	
P-131	$\frac{1}{2}$ " .50		P-134	3" .75	
			P-135	3" .85	

TIE BOLTS — No. 5 round head. No. 5-40 thread, Cadmium plated steel. The dimension given is the length. Packaged 12 per envelope*.

Cat. No.	per Lgth. Doz.	Price	Cat. No.	per Lgth. Doz.	Price
P-136	$\frac{1}{8}$ " .15		P-142	$\frac{1}{4}$ " .75	
P-137	$\frac{1}{4}$ " .25		P-143	$\frac{1}{2}$ " .85	
P-138	$\frac{3}{8}$ " .30		P-144	3" 1.00	
P-139	$\frac{1}{2}$ " .33		P-145	7" 1.00	
P-140	$\frac{3}{4}$ " .50		P-146	9" 1.50	
			P-141	$3\frac{3}{4}$ " .50	

MEDIUM DUTY POWER SWITCHES

An outstanding medium duty switch of heavy Steatite insulation. Rating 750 watts. Voltage breakdown, 3000 RMS volts to ground. Mtg. bushing, $\frac{3}{8}$ " x 32 thread, $\frac{3}{8}$ " long. Shaft, $1\frac{1}{2}$ " long. Index, 20° double roller, non-stalling. Adjustable stops.

Cat. No.	per Tot. Sec. No.	Tot. Sec. No.	Posi- tions	List Price
JV9000	1	1	2 to 17	\$12.00
JV9002	3	1	2 to 5	12.00
JV9004	1	2	2 to 17	21.00
JV9006	3	2	2 to 5	21.00
JV9008	1	3	2 to 17	30.00
JV9010	3	3	2 to 5	30.00
JV9012	1	4	2 to 17	39.00
JV9014	3	4	2 to 5	39.00
JV9016	1	5	2 to 17	48.00
JV9018	3	5	2 to 5	48.00
JV9020	1	6	2 to 17	57.00

SHORTING CONTACTS (make before break)

Cat. No.	per Tot. Sec. No.	Tot. Sec. No.	Posi- tions	List Price
JV9001	1	1	2 to 17	12.00
JV9003	3	1	2 to 5	12.00
JV9005	1	2	2 to 17	21.00
JV9007	3	2	2 to 5	21.00
JV9009	1	3	2 to 17	30.00
JV9011	3</			

Centralab offers the widest variety of ceramic capacitors on the market today for all ranges of voltage and frequency—for any application in circuitry.

Centralab

Division of GLOBE-UNION INC.

934 East Keefe Avenue
Milwaukee 1, Wisconsin

Centralab introduced ceramic capacitors and has constantly devoted more research and larger laboratory and production facilities to this field, than can be said of any other firm. Ceramics are known as the most permanent type of capacitors.

BC HI-KAP TUBULARS



For bypass, coupling and general use. Tolerance $\pm 20\%$ through 2200 MMF.; higher cap. Guaranteed Minimum Values (GMV), 85°C. plus operation. Tropicalized, 1000 volts d.c. test; 600 volts d.c. working. Minimum order quantity, 5.

Cat. No.	Cap. MMF.	Size	List Price
D6-100	10	A	\$.25
D6-120	12	A	\$.25
D6-150	15	A	\$.25
D6-180	18	A	\$.25
D6-220	22	A	\$.25
D6-250	25	A	\$.25
D6-270	27	A	\$.25
D6-330	33	A	\$.25
D6-390	39	A	\$.25
D6-470	47	A	\$.25
D6-500	50	A	\$.25
D6-560	56	A	\$.25
D6-680	68	A	\$.25
D6-750	75	A	\$.25
D6-101	100	A	\$.25
D6-121	120	A	\$.25
D6-151	150	A	\$.25
D6-181	180	A	\$.25
D6-201	200	A	\$.25
D6-221	220	A	\$.25
D6-251	250	A	\$.25
D6-271	270	A	\$.25
D6-301	300	A	\$.25
D6-331	330	A	\$.25
D6-391	390	A	\$.25
D6-401	400	B	\$.25
D6-471	470	B	\$.25
D6-501	500	B	\$.25
D6-561	560	B	\$.25
D6-601	600	B	\$.25
D6-681	680	B	\$.25
D6-751	750	B	\$.25
D6-102	1,000	B	\$.25
D6-122	1,200	B	\$.25
D6-152	1,500	B	\$.25
D6-182	1,800	B	\$.25
D6-202	2,000	B	\$.25
D6-222	2,200	B	\$.25
D6-252	2,500	B	\$.25
D6-272	2,700	B	\$.25
D6-302	3,000	B	\$.25
D6-332	3,300	C	\$.30
D6-402	4,000	C	\$.30
D6-472	4,700	C	\$.30
D6-502	5,000	C	\$.30
D6-562	5,600	D	\$.30
D6-682	6,800	D	\$.30
D6-103	10,000	D	\$.30

Body Dimensions

Size	Diam.	Length
A	.230"	.475"
B	.230"	.750"
C	.255"	.885"
D	.310"	1.180"

DISC HI-KAPS



Fit narrow spaces. Tolerances GMV except Cat. No. DD-2-502 is -20% $+ 80\%$, 1000 d.c. test; 600 volts d.c. working. Min. order quantity, 5.

Cat. No.	Cap. MFD.	Diam.	Thick.	List Price
DD-471	.00047	1/4"	.156	\$.25
DD-801	.0008	1/4"	.156	\$.25
DD-102	.001	3/8"	.156	\$.25
DD-152	.0015	3/8"	.156	\$.25
DD-202	.002	1/2"	.156	\$.25
DD-502	.005	1/2"	.156	\$.25
DD-103	.01	3/8"	.156	\$.30

Cat. No.	Cap. MFD.	Diam.	Thick.	List Price
DD-2-102	2x.001	3/8"	.156	.40
DD-2-152	2x.0015	3/8"	.156	.40
DD-2-502	2x.005	3/8"	.156	.45

TYPE DD-3* - SHIELDED DUAL DISCS

DD-3-102	2x.001	3/8"	.225	.45
DD-3-152	2x.0015	3/8"	.225	.45
DD-3-202	2x.002	1/2"	.225	.45
DD-3-502	2x.005	1/2"	.225	.50
DD-3-103	2x.01	3/8"	.225	.50

TYPE DF FLAT-PLATE HI-KAPS*

DF-203	.02	1 1/8" x 3/8" x 3/8"	thick .60	
DF-503	.05	1 3/8" x 3/8" x 3/8"	thick .70	
DF-104	.1	1 3/8" x 3/8" x 3/8"	thick .80	

*Packaged singly.

TC TEMPERATURE COMPENSATING TUBULARS



TCZ units are negative-positive-zero (NPO) type. TCN units are temperature compensating, N750 type, giving a negative change of 750 parts per million per degree C. Packaged singly, including instructions. 1200 volts d.c. test; 600 volts d.c. working.

Cat. No.	Cap. MMF.	Tol. MMF.	Size	List Price
TCZ-5	.5	$\pm .25$	A	\$.75
TCZ-.68	.68	$\pm .25$	A	\$.75
TCZ-1	1.	$\pm .25$	A	\$.75
TCZ-1.5	1.5	$\pm .25$	A	\$.75
TCZ-2.2	2.2	$\pm .25$	A	\$.75
TCZ-3.3	3.3	$\pm .25$	A	\$.75
TCZ-4.7	4.7	$\pm .5$	A	\$.60
TCZ-6.8	6.8	$\pm .5$	A	\$.60
TCZ-10	10.	$\pm .5$	A	\$.60
TCZ-12	12.	$\pm .5$	A	\$.60
TCZ-15	15.	$\pm .5$	A	\$.60
TCZ-18	18.	$\pm .5$	A	\$.60
TCZ-20	20.	$\pm .5$	A	\$.60

TCZ NEGATIVE-POSITIVE-ZERO (NPO)

Cat. No.	Cap. MMF.	Tol. %	Size	List Price
TCZ-22	22.	$\pm 2 1/2$	A	\$.50
TCZ-24	24.	$\pm 2 1/2$	A	\$.50
TCZ-27	27.	$\pm 2 1/2$	B	\$.50
TCZ-30	30.	$\pm 2 1/2$	B	\$.50
TCZ-33	33.	$\pm 2 1/2$	B	\$.50
TCZ-36	36.	$\pm 2 1/2$	B	\$.50
TCZ-39	39.	$\pm 2 1/2$	B	\$.50
TCZ-43	43.	$\pm 2 1/2$	B	\$.50
TCZ-47	47.	$\pm 2 1/2$	B	\$.50
TCZ-51	51.	$\pm 2 1/2$	B	\$.50
TCZ-56	56.	$\pm 2 1/2$	B	\$.50
TCZ-62	62.	$\pm 2 1/2$	C	\$.50
TCZ-68	68.	$\pm 2 1/2$	C	\$.50
TCZ-75	75.	$\pm 2 1/2$	C	\$.50
TCZ-82	82.	$\pm 2 1/2$	C	\$.50
TCZ-91	91.	$\pm 2 1/2$	C	\$.50
TCZ-100	100.	$\pm 2 1/2$	C	\$.50
TCZ-110	110.	± 5	C	\$.50
TCZ-120	120.	± 5	C	\$.50
TCZ-130	130.	± 5	D	\$.50
TCZ-150	150.	± 5	D	\$.50
TCZ-160	160.	± 5	D	\$.50
TCZ-180	180.	± 5	D	\$.50
TCZ-200	200.	± 5	E	\$.50
TCZ-220	220.	± 5	E	\$.50
TCZ-240	240.	± 5	E	\$.50
TCZ-270	270.	± 5	E	\$.50
TCZ-300	300.	± 5	E	\$.50

TCN NEG. TEMP. UNITS (N750)

Cat. No.	Cap. MMF.	Tol. %	Size	List Price
TCN-10	10.	$\pm .5$	A	\$.60
TCN-12	12.	$\pm .5$	A	\$.60
TCN-15	15.	$\pm .5$	A	\$.60
TCN-18	18.	$\pm .5$	A	\$.60
TCN-20	20.	$\pm .5$	A	\$.60
TCN-22	22.	$\pm 2 1/2$	A	\$.50
TCN-24	24.	$\pm 2 1/2$	A	\$.50
TCN-27	27.	$\pm 2 1/2$	A	\$.50
TCN-30	30.	$\pm 2 1/2$	A	\$.50
TCN-33	33.	$\pm 2 1/2$	A	\$.50
TCN-36	36.	$\pm 2 1/2$	A	\$.50
TCN-39	39.	$\pm 2 1/2$	A	\$.50
TCN-43	43.	$\pm 2 1/2$	A	\$.50
TCN-47	47.	$\pm 2 1/2$	A	\$.50
TCN-51	51.	$\pm 2 1/2$	A	\$.50
TCN-56	56.	$\pm 2 1/2$	A	\$.50
TCN-62	62.	$\pm 2 1/2$	A	\$.50
TCN-68	68.	$\pm 2 1/2$	B	\$.50

TCN-75	75.	$\pm 2 1/2$	B	\$.50
TCN-82	82.	$\pm 2 1/2$	B	\$.50
TCN-91	91.	$\pm 2 1/2$	B	\$.50
TCN-100	100.	$\pm 2 1/2$	B	\$.50
TCN-110	110.	± 5	B	\$.50
TCN-120	120.	± 5	B	\$.50
TCN-130	130.	± 5	B	\$.50
TCN-150	150.	± 5	B	\$.50
TCN-160	160.	± 5	B	\$.50
TCN-180	180.	± 5	C	\$.50
TCN-200	200.	± 5	C	\$.50
TCN-220	220.	± 5	C	\$.50
TCN-240	240.	± 5	C	\$.50
TCN-270	270.	± 5	C	\$.50
TCN-300	300.	± 5	C	\$.50
TCN-330	330.	± 5	C	\$.50
TCN-360	360.	± 5	D	\$.50
TCN-390	390.	± 5	D	\$.50
TCN-430	430.	± 5	D	\$.50
TCN-470	470.	± 5	D	\$.50
TCN-510	510.	± 5	D	\$.50
TCN-560	560.	± 5	E	\$.50
TCN-620	620.	± 5	E	\$.50
TCN-680	680.	± 5	E	\$.50
TCN-750	750.	± 5	E	\$.50

Body Dimensions

Size	Diam.	Length
A	.200"	.400"
B	.200"	.690"
C	.225"	.860"
D	.285"	1.165"
E	.285"	1.625"

TV HI-VO-KAPS



The accepted standard for filter and bypass applications in television high voltage power supply. Body sizes—501, 1" diam. x .510", 502, 1" diam. x 1.050", 503, 1.4" diam. x 1.250". Terminals: A—plain studs. B—one slotted 1/8" wide x 1/8" deep, other slotted 6-32, 1/4" deep. C—screw terminals, male 6-32 x 1/4", female 6-32 x 1/4". Capacity tolerance — 20% + 50%.

Cat. No.	Cap. MMF.	V.D.C. Working	Term.	List Price
TV1-501	500	10,000	A	\$1.75
TV2-501	500	10,000	B	1.75
TV3-501	500	10,000	C	1.75
TV1-502	500	20,000	A	2.25
TV2-502	500	20,000	B	2.25
TV3-502	500	20,000	C	2.25
TV1-503	500	30,000	A	4.50

TV6 CERAMIC 6000 VOLT REPLACEMENT TUBULAR



Used in capacity deflection circuits in electrostatic TV sets, also in voltage divider circuits in electrodynamic TV sets. Molded casing assures adequate external insulation. Tolerance GMV. Body size 3/4" diam. x 2 3/4".

Cat. No.	Cap. MFD.	V.D.C. Working	List Price
TV6-502	.005	6000	\$1.10

CERAMIC MIN-KAPS

Tiny flat-plate capacitors, size 1/8" x 1/8" x 1/8". Tolerance — 20% + 80%. Space savers for low voltage applications. 5 per package.

Cat. No.	Cap. MFD.	V.D.C. Working	List Price
DM-201	.0002	150	\$.35
DM-501	.0005	150	.35
DM-102	.001	150	.35
DM-202	.002	150	.45
DM-502	.005	150	.45
DM-103	.01	150	.65

FT FEED-THROUGH HI-KAPS

For single hole mounting where capacity ground to chassis or shield is desired. 1000 volts d.c. test, 600 volts d.c. working. Packaged singly.

Cat. No.	Cap. MMF.	Tol.	List Price
FT-500	500	$\pm 20\%$	\$1.00

CERAMIC CAPACITORS

FT-1000 1000 $\pm 20\%$ 1.00
FT-1500 1500 -20% $+50\%$ 1.00



HIGH ACCURACY CAPACITORS
Precision ceramic capacitors for applications involving rigid frequency control. Excellent as prime or secondary Standards. 1/8" diameter. Metal case grounded, with mtg. stud 1/16" long 6-32 thread. Other terminal opposite end, plain stud 1/4" long. Tolerance $\pm 1\%$.
Cat. V.D.C. L List
No. MMF. Wkg. Price
950-501 500 500 1/8" \$40.00
950-102 1000 500 1/8" 40.00
950-202 2000 500 1/8" 40.00

TRANSMITTING CAPACITORS



Type 851 ceramic capacitors are high voltage units, held to $\pm 10\%$ tolerance. Size 1 1/2" diam. x 1 1/2". End terminal plates are center tapped 10-32.
Cat. Cap. V.D.C. Temp. List
No. MMF. Wkg. COEF. Price
851-25Z 25 15,000 NPO \$10.00
851-50Z 50 15,000 NPO 10.00
851-100N 100 15,000 N750 10.00
851-200N 200 7,500 N750 10.00

Type 850S high voltage ceramic capacitors are $\pm 10\%$ tolerance, in cases with centered hex studs, one each end, projecting 1/8", tapped 6-32, 1/4" deep.

Cat. No.	Cap. MMF.	V.D.C. Temp.	Wkg. COEF.	List Price
850S-25Z	25	7500	NPO	\$3.00
850S-50Z	50	7500	NPO	3.00
850S-50N	50	7500	N750	3.00
850S-75N	75	7500	N750	3.00
850S-100N	100	5000	N750	3.00

SMALL HIGH VOLTAGE UNITS

The three series which follow are exceedingly compact ceramic capacitors, similar in appearance to type 850S above. Mounting is with axial screw type terminals, tapped 2-56. Tolerance $\pm 10\%$. Sizes: 853, 3/8" diam. x 1/2". 854, 1/2" diam. x 3/8". 855, 1/2" diam

PRINTED ELECTRONIC CIRCUITS

PRINTED ELECTRONIC CIRCUITS

For the first time, Centralab's famous Printed Electronic Circuits (P.E.C.) are now made available as stock items. P.E.C. units, in simplest form for application as components, consist of resistance materials and pure metallic silver fired to sturdy Ceramic-X plates, including integral "printed" circuit connections, brought out to convenient external leads which are mechanically anchored to the plate. The complete unit is protected with a moisture-proof phenolic coating. The result is a combination of resistors and capacitors of ultra compactness and permanence. No other modern development in electronic circuitry offers so many advantages in low powered applications as regards small size, low cost assembly and utmost reliability.



RESISTOR AND RESIS.-CAP. UNITS
Plate size, $1\frac{1}{4}'' \times \frac{3}{8}'' \times \frac{3}{16}''$ thick, max. Capacitors, 150 v.d.c.w. Resistors, $\frac{1}{2}$ watt.

Cat. No.	Dwg.	Consists of	List Price
PC-2	A	2 meg. Resis.	\$.35
PC-21	B	$\frac{1}{2}$ meg., 110,000 ohms	.50
PC-30	C	R-240,000 ohms. C-1000 mfm.	.50
PC-33	D	R-1 meg. C-1000 mfm.	.50
PC-36	E	R-100,000 ohms. C-100 mfm.	.50

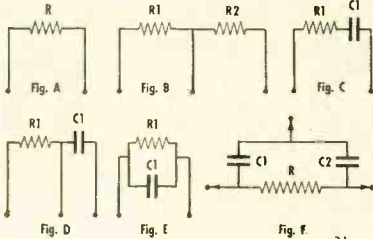

FILPEC BALANCED DIODE LOAD FILTER

Plate size, $1\frac{1}{4}'' \times \frac{3}{8}'' \times \frac{3}{16}''$ thick max. Capacitors, 100 v.d.c.w. Resistors, $\frac{1}{2}$ watt.

Cat. No.	Dwg.	Consists of	List Price
PC-50	F	C1=100 mfm. C2=100 mfm. R=47,000 ohms	\$.60
PC-51	F	C1=150 mfm. C2=150 mfm. R=47,000 ohms	.60

TELEVISION H-PADS FOR ATTENUATION OF SIGNAL STRENGTH

These handy Centralab P.E.C. units are specially designed for use in television antenna installations where signal strength needs attenuation to secure optimum performance. The proper H-Pad, in many instances, will match the signal strength to the requirements of the receiver. This can prevent overloading, can eliminate tearing of the image, and improve both audio and video results. They are especially valuable where the television set is located too close to the broadcast station. In connection with a switching arrangement, they are helpful to balance signals from stations which, because of high power or location, are too strong in relation to other stations. H-pads also are useful in matching impedance between the antenna and the receiver.

The H-Pad has four terminals, and is for installation in series with the standard 300 ohm antenna. Full directions are included.

SIZE — $1\frac{1}{4}'' \times \frac{3}{8}'' \times \frac{3}{16}''$ thick.

TERMINALS — Solder terminals, $\frac{3}{32}''$ long.

PACKAGED — Singly in envelopes. In sets of four, in a plastic box.

Cat. No.	Type	Attenuation Rating	List Price
PCH-10	H-Pad	10 db.	\$.80
PCH-20	H-Pad	20 db.	.80
PCH-30	H-Pad	30 db.	.80
PCH-40	H-Pad	40 db.	.80
PCH-100 SET OF FOUR H-PADS, one each of the above, in plastic box			3.00

Centralab

Division of GLOBE-UNION INC.
934 East Keefe Avenue
Milwaukee 1, Wisconsin

TRIODE COUPLATES P.E.C. INTERSTAGE COUPLING PLATES MIDGET NO. 2 COUPLATE



Plate size, $1\frac{1}{4}'' \times \frac{3}{8}'' \times \frac{3}{16}''$ thick max. Capacitors, 450 v.d.c.w. Resistors, $\frac{1}{2}$ watt.

Cat. No.	Consists of (See Fig. A)	List Price
PC-70 MIDGET #2 COUPLATE	C1=.005 mfd. C2 and C3=250 mfm. R1=500,000 ohms. R2=500,000 ohms.	\$.70
PC-71 MIDGET #2 COUPLATE	C1=.005 mfd. C2 and C3=250 mfm. R1=250,000 ohms. R2=500,000 ohms.	.70

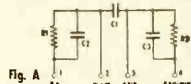

STANDARD TRIODE COUPLATE

Plate size, $1\frac{1}{4}'' \times \frac{3}{8}'' \times \frac{3}{16}''$ thick, max. Capacitors, 450 v.d.c.w. Resistors, $\frac{1}{2}$ watt.

Cat. No.	Consists of (See Fig. B)	List Price
PC-80 STANDARD COUPLATE	C1=.01 mfd. C2 and C3=250 mfm. R1=500,000 ohms. R2=500,000 ohms.	\$.75
PC-81 STANDARD COUPLATE	C1=.01 mfd. C2 and C3=250 mfm. R1=250,000 ohms. R2=500,000 ohms.	.75

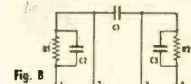

PENTODE COUPLATES

Plate size, $1\frac{1}{4}'' \times \frac{3}{8}'' \times \frac{3}{16}''$ thick max. Capacitors, 450 v.d.c.w. Resistors, $\frac{1}{2}$ watt.

Cat. No.	Consists of (See Fig. C)	List Price
PC-90 PENTODE COUPLATE	C1=.005 mfd. C2=50 mfm. C3=2000 mfm. R1=4.7 megohms. R2=1 megohm. R3=2.2 megohms.	\$.90
PC-91 PENTODE COUPLATE	C1=.005 mfd. C2=100 mfm. C3=.005 mfd. R1=4.7 megohms. R2=1 megohm. R3=2.2 megohms.	.90

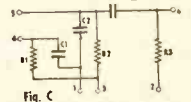

VERTICAL INTEGRATOR PLATES

Due to great saving in assembly costs, this Centralab printed circuit is being used widely

Cat. No.	Type	Consisting of	List Price
PC-200	AMPEC	Complete Three Stage Speech Amplifier, including three built-in sockets, less tubes.	\$15.00
PC-201	AMPEC	Same as PC-200, but furnished complete with tubes, two CK512AX and one CK525AX.	26.00

TUBES — Listed separately as a matter of convenience.

Cat. No.	CRL List Price
CK512AX	Raytheon Subminiature Voltage Amplifier Pentode Tube \$3.40
CK525AX	Raytheon Subminiature Output Pentode Tube 4.25

AUDET OUTPUT STAGE FOR AC-DC RADIO RECEIVERS

Cat. No. PC-150 AUDET

Consisting of (See drawing) List Price
C1=.002 mfd. C2=220 mfm. \$1.00
C3 and C5=220 mfm. C4=.005 mfd.
R1=6.8 megohms. R2=470,000 ohms.
R3=470,000 ohms.

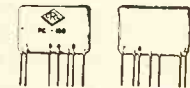

Audet is a P.E.C. audio-detector plate, with seven leads, and furnishes the values of all components which quite generally comprise the output stage of AC-DC radio receivers. Where there is trouble with old style components in this part of the set, it is easy to replace the entire audio-detector stage with Audet.

Plate size, $1\frac{1}{8}'' \times \frac{7}{8}'' \times \frac{1}{8}''$ thick max. Capacitors, 450 v.d.c.w. Resistors, $\frac{1}{2}$ watt.

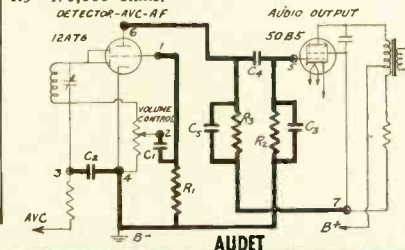

AUDET

Centralab Printed Electronic Circuits — no other electronic development offers such tremendous time, material and cost saving advantages in low-power applications.

in television vertical integrator networks. Two forms are available. Either one has only three external leads. Size, PC-100 $1\frac{1}{8}'' \times 1\frac{1}{8}'' \times \frac{1}{8}''$ thick max. PC-101, $1\frac{1}{8}'' \times 1\frac{1}{8}'' \times \frac{1}{8}''$ thick max. Capacitors, 450 v.d.c.w. Resistor, $\frac{1}{2}$ watt.

Cat. No.	Consisting of (See Fig. D)	List Price
PC-100 VERTICAL INTEGRATOR	C1=.002 mfd. C2=.005 mfd. C3=.005 mfd. R1=22000 ohms. R2=8200 ohms. R3=8200 ohms.	\$1.10

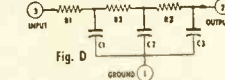

Cat. No.	Consisting of (See Fig. E)	List Price
PC-101 VERTICAL INTEGRATOR	C1=.01 mfd. C2=.002 mfd. C3=.005 mfd. C4=.005 mfd. R1=22000 ohms. R2=2000 ohms. R3=8200 ohms. R4=22000 ohms.	1.25

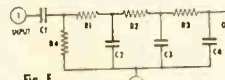

AMPEC COMPLETE SPEECH AMPLIFIER

There's never been an electronic device like Centralab's Ampec. In the compact unit — permanently bonded to a master plate — are all the components of an audio amplifier — tube sockets, capacitors, resistors, wiring — a three tube, three stage speech amplifier. Similar Centralab units are widely used in hearing aids, for the most trouble-free performance ever attained. Ampec has other interesting applications, as mike preamplifier, etc. Size, $1\frac{1}{4}'' \times 1\frac{1}{8}'' \times .340''$ over tube sockets. Capacitors, 100 v.d.c.w. Resistors, $\frac{1}{2}$ watt. Recommended tube complement, T-1 and T-2 (see dwg.) Raytheon type CK512AX; T-3, Raytheon type CK525AX. Gain frequency performance — A voltage 1.2; input voltage, 1 millivolt; B voltage 22, 50,000 ohm load. At 1000 cycles per second, the amplification factor is 4000. Volume control (VC in dwg.) not furnished. The ideal control is Centralab Cat. No. B16-124 or switch type Cat. No. B16-224.

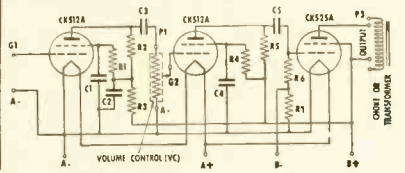

See the Centralab Distributor in your neighborhood . . . over 700 in U. S. and Canada



CLEVELITE* COSMALITE*

LAMINATED PHENOLIC TUBING THAT
MEETS THE MOST EXACTING REQUIREMENTS!

DEPENDABLE DELIVERIES

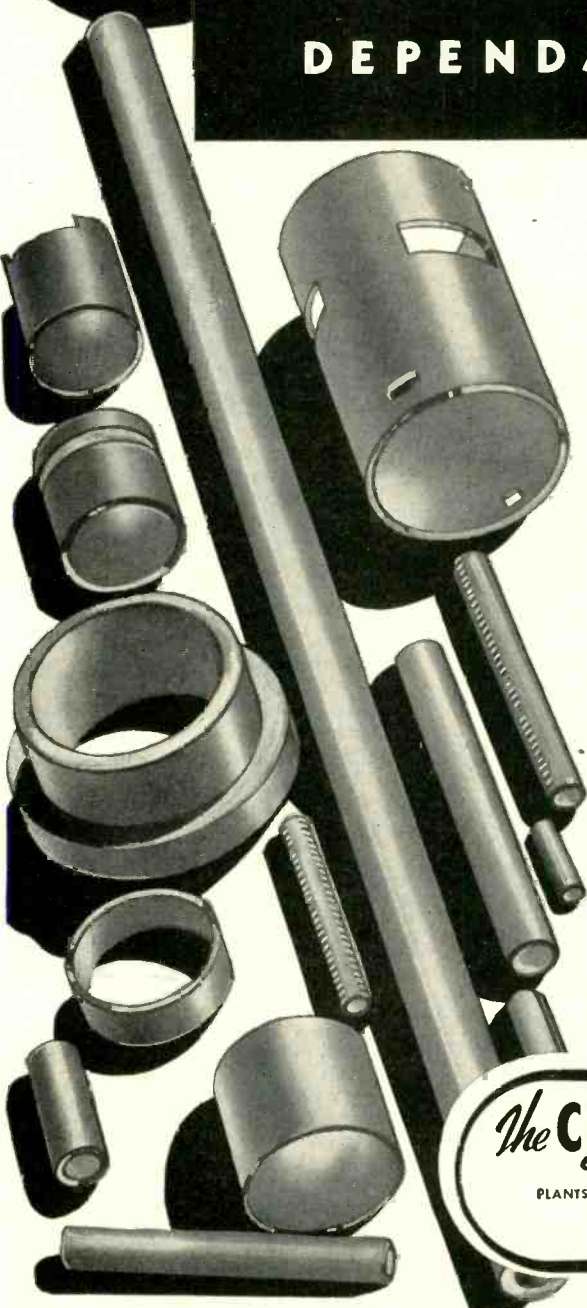

Cleveland Container can relieve your procurement problems on phenolic tubing by assuring prompt deliveries. In fact, orders can be filled immediately on any number of the more popular sizes.

Clevelite and Cosmalite have high dielectric strength . . . low moisture absorption . . . low loss . . . strength and good machineability.

They are available in diameters, wall thicknesses and lengths to meet special or new adaptations, with a grade for every need. Ask for samples.

Why Pay More?

"CALL CLEVELAND"

The **CLEVELAND CONTAINER Co.**
6201 BARBERTON AVE. CLEVELAND 2, OHIO

PLANTS AND SALES OFFICES at Plymouth, Wisc., Chicago, Detroit, Ogdensburg, N. Y., Jamesburg, N. J.
ABRASIVE DIVISION at Cleveland, Ohio
CANADIAN PLANT: The Cleveland Container, Canada, Ltd., Prescott, Ontario

REPRESENTATIVES

NEW YORK AREA R. T. MURRAY, 604 CENTRAL AVE., EAST ORANGE, N. J.

NEW ENGLAND R. S. PETTIGREW & CO., 10 N. MAIN ST., WEST HARTFORD, CONN.

CHICAGO AREA PLASTIC TUBING SALES, 5215 N. RAVENSWOOD AVE., CHICAGO

* Trade Marks



Like a Phantom Finger

the Branson non-destructive Thickness Testers probe metal from one side—quickly and accurately.

the AUDIGAGE® THICKNESS TESTER

Ultrasonic Resonance eliminates slow and costly drill-and-plug in checking the progress of corrosion in tanks, pipes, ships' hulls and other difficult or inaccessible locations. Gages thickness of non-porous materials from 1/16-inch to 12 inches with flat or curved surfaces; detects laminar flaws. Portable and self-powered—light and rugged for field use, precise enough for the laboratory. Accurate within 3%, 10-to-50 times faster than older methods.

the AUDIGAGE® FLAW DETECTOR

Proven from coast to coast by dozens of railroads, has scores of uses beyond its original sleuthing of defective rails, frogs and crossings. Like the THICKNESS TESTER, portable and rugged; *Ultrasonic Resonance* probes from one side for laminar flaws, other defects in non-porous materials. Very compact, portable, self-powered.

the BRANSON COATINGAGE

Calipers non-magnetic coatings, scale, coke, etc., from 0.0001 inch to 0.5 inch thick on iron or steel. Compact, portable, self-powered, precise; for field and laboratory.

For full information on AUDIGAGE® THICKNESS TESTERS and FLAW DETECTORS, and the BRANSON COATINGAGE, address

BRANSON INSTRUMENTS, Inc.,

438 FAIRFIELD AVE.

STAMFORD, CONN.



HERE'S AN

Oster
GUARANTEED QUALITY

SPECIALTY

COMPACT

RUGGED

PRECISION BUILT

FRACTIONAL H. P.

ELECTRIC MOTORS

1/1000 H. P. to 1/4 H. P.



For 25 years, OSTER has specialized in building fractional H.P. motors to meet specific requirements. OSTER is unsurpassed in engineering, tooling, and assembly of electric motors up to 6" maximum O.D. of the following types:

Direct current—6 volts to 220 volts

Universal motors—6 volts to 220 volts

Induction motors—conventional voltages

Shaded pole motors—conventional voltages

400 cycle motors of the smaller sizes

Also precision electro mechanical assemblies

In several fields of fractional H.P. motor use, OSTER is the world's largest producer—electric barber clippers and massage instruments, for example. OSTER electric housewares, including food mixers, knife sharpeners, and hair dryers, because of their outstanding design and efficiency, are currently national best sellers.

All this OSTER experience and precision workmanship, plus the considerable volume of fractional H.P. electric motor production, assures you a reliable source for motors of dependable performance. For full information as to how OSTER can serve your special motor needs, write, wire or telephone . . .



JOHN OSTER

MANUFACTURING CO.

RACINE, WISCONSIN

PERFORMANCE TESTED TRANSFORMERS DESIGNED FOR YOUR NEEDS

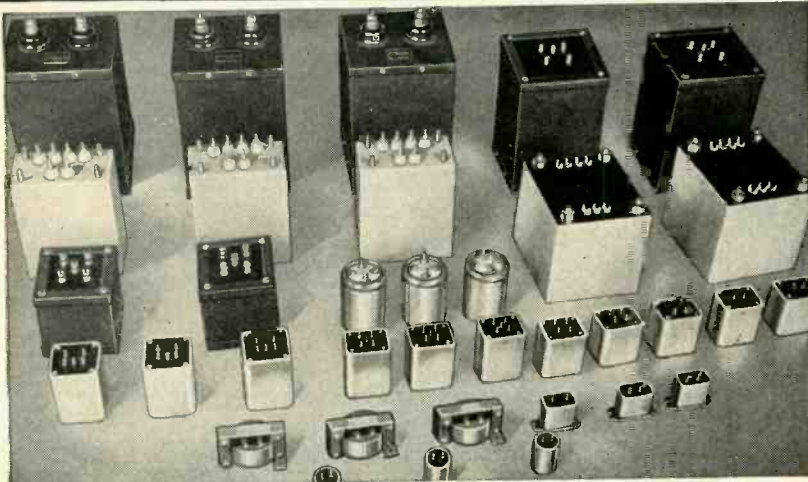

QUALITY PRODUCTS PRODUCED IN QUANTITY

ACME ELECTRIC CORPORATION

31BG WATER STREET

CUBA, N. Y.

Acme  **Electric**
TRANSFORMERS

For easy assembly... dependable performance

ERIE RESISTOR COMPONENTS

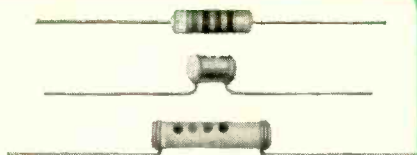

Erie "GP" ^{*}Molded Insulated Ceramicon*
5 MMF—5,000 MMF
Erie "GP" Dipped Insulated Ceramicon
5 MMF—5,000 MMF
Erie "GP" Non-Insulated Ceramicon
5 MMF—5,000 MMF

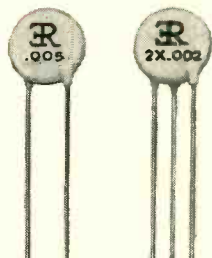

Erie Disc Ceramicon
Up to .01 MFD

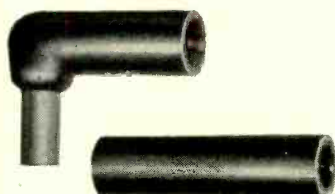

Types L-4, L-7, S-5 Suppressors
for Spark Plugs and Distributors



Feed-Thru Ceramicon
5 MMF—1,000 MMF
5 MMF—1,500 MMF

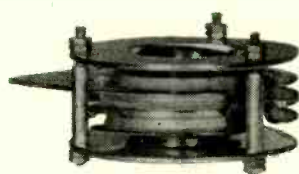

Type 3688
High Voltage Ceramicon
Up to 15,000 Volts
WORKING

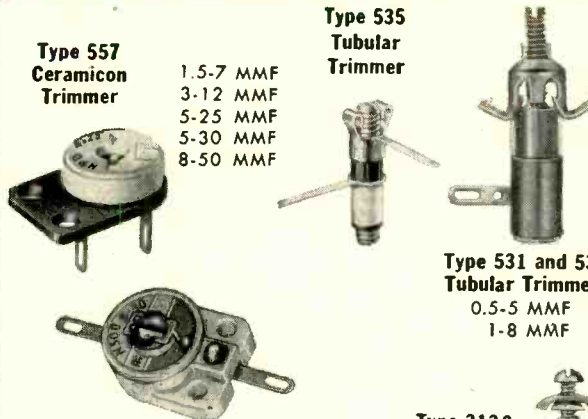

Type 557
Ceramicon
Trimmer
1.5-7 MMF
3-12 MMF
5-25 MMF
5-30 MMF
8-50 MMF

Type 535
Tubular
Trimmer

Type 531 and 532
Tubular Trimmers
0.5-5 MMF
1-8 MMF

Type TS2A Ceramicon Trimmer
1.5-7 MMF 3-13 MMF 4-30 MMF
3-12 MMF 5-20 MMF 7-45 MMF

Type 3139
Tubular Trimmer

Erie Resistor Components are designed with definite objectives in mind: they must be accurate and well within the tolerances required for their application; they must be reliable for sustained satisfactory service based on time proven life tests; they must be compact and sturdy for easy installation on the assembly line and in the service shop.

Erie manufactures a complete line of Ceramic and Button Mica Capacitors for transmitter and receiver applications: Fixed Ceramic and Mica Capacitors, Variable Ceramic Capacitors, Carbon Suppressors, Custom Injection Molded Plastic Knobs, Dials, Bezels, Name Plates and Coil Forms. Complete technical information on request.

*Ceramicon, Hi-K, GP, and Plexicon are registered trade names of Erie Resistor Corporation.

Electronics Division

ERIE RESISTOR CORP., ERIE, PA.

LONDON, ENGLAND • TORONTO, CANADA

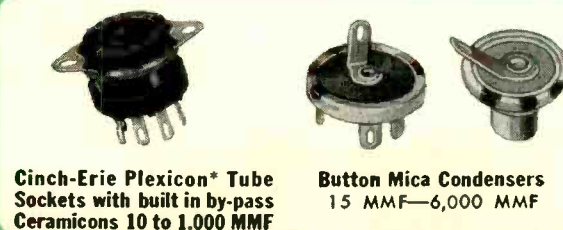

Cinch-Erie Plexicon* Tube
Sockets with built in by-pass
Ceramicon 10 to 1,000 MMF

Button Mica Condensers
15 MMF—6,000 MMF

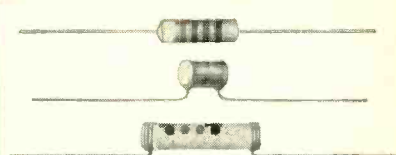

Temperature Compensating
Molded Insulated Ceramicon
0.5 MMF—550 MMF
Temperature Compensating
Dipped Insulated Ceramicon
0.5 MMF—1,800 MMF
Temperature Compensating
Non-Insulated Ceramicon
0.5 MMF—1,800 MMF

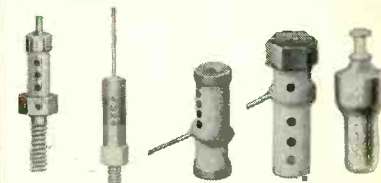

Type 720A
Types 323 and 324
Type 2322
Type 2336
Type 325
Insulated

Erie Stand-Off Ceramicon
5 MMF—5,000 MMF

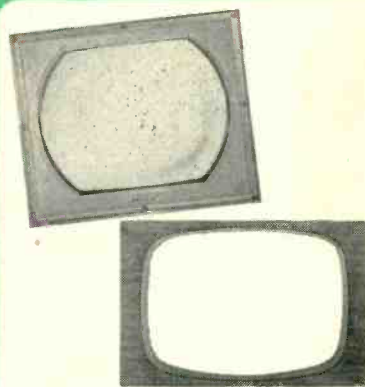

Custom Molded
Plastic TV Lenses and Frames



Custom Injection Molded
Plastic Knobs, Dials, Bezels,
Name Plates, Coil Forms, etc.

Insulation by IRVINGTON

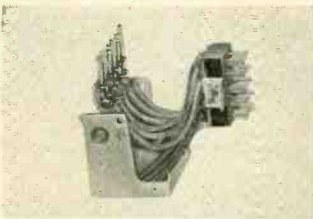

FLEXIBLE TUBING: Extruded Plastic and Varnished

THE IRVINGTON LINE of insulating tubing includes extruded thermoplastic and varnished types, for all conductor sizes commonly used in electronic wiring. All are characterized by high dielectric and tensile strength, excellent flexibility, smooth surfaces and resistance to acids, alkalis and fumes.

Application	Recommended Types	Dielectric Strength* (vpm)	Tensile Strength (psi)	Remarks
VHF	Polyethylene	1350	1600	High resistance to ozone
LOW-TEMPERATURE	Hyflex Ivi-Flex Transflex	1000 650 1000	3000 1000 3000	-70°F to 167°F Flexible at -80°F Transparent: -58°F to 167°F
HIGH-TEMPERATURE	Temflex 105	1200	3000	Cont. Oper. at 105°C
GENERAL-PURPOSE	IRV-O-LITE XTE-30	1000	3000	Rubber-like, flexible
	Varnished	IRV-O-VOLT: Tubing—cotton, rayon and glass, varnished inside and out; Sleeving—cotton, rayon and glass, saturated. IRVINGTON: Lacquer-coated cotton, rayon and glass tubing. Special types.		

*Dry test, .020" wall



IRVINGTON INSULATING TAPES and YARD GOODS

Available in a wide range of formulations to meet such electronic requirements as: high dielectric strength; resistance to moisture and heat; flexibility at high and low temperatures. Table lists the more commonly used types; consult our engineering department for special requirements.

Application	Recommended Types	Thicknesses	Dielectric Strength* (vpm)	Tensile Strength lbs/1" width
VHF	Polyethylene	.004-.020		
COMPACT EQUIPMENT	Varnished silk	.002-.008	1700-1100	13
	Varnished rayon	.003-.008	1200-1000	35
	Varnished nylon	.003-.008	1200-1000	25-30
	Varnished cambric	.003-.005	1200	32
	Varnished paper	.00075-.015	2500-500	
HIGH TEMPERATURES	Varnished Fibreglas	.003-.030	1200-600	70-550
	Silicone Varnished Fibreglas	.003-.025	1500-250	100-525
	Fibron	.008-.020	1000-750	40-47
GENERAL-PURPOSE	Varnished cambric (straight cut)	.005-.015	1100-1200	38-50
	Varnished cambric (bias cut)	.005-.015	1100-1300	40-47
SPECIAL APPLICATIONS	Ivi-Bind (pressure-sensitive backing)	.005-.012	1050	38-44

*Avg. short-time test

STANDARD WIDTHS AND LENGTHS: Straight cut supplied in 25 and 50 yard rolls. Bias cut supplied in 36 and 72 yard rolls. 36" wide or tapes from 1/4" up. Consult our catalog for detailed dimensions.

LOOK TO IRVINGTON FOR
INSULATION LEADERSHIP

Irvington

For Electronic Applications

HARVEL and IRVINGTON Insulating Varnishes

The varnishes listed below represent a few of the many types developed by Irvington for a wide range of uses. All these varnishes offer good-to-excellent resistance to moisture and heat, and most of them also resist the effects of oil, acids and alkalies. Dielectric strength ratings in this table are based on average short-time tests for a film of varnish on paper in the case of baking varnishes; on U.S. Navy Specifications in the case of air drying types.

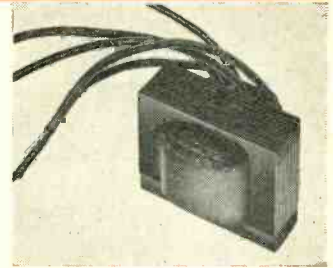

Method of Drying	Varnish Type	Dielectric Strength (vpm)
INTERNAL BAKING	Harvel 512-C	2100
	Harvel 612-C	2300
	Harvel 912-C	2200
	Irvington 100	2250
	Irvington 200	2100
	Irvington 500	2100
REGULAR BAKING	Harvel 202	2100
	Harvel 602	2100
	Irvington 1	2150
	Irvington 5	2300
	Irvington 121	2400
	Irvington 517	2000
AIR DRYING	Harvel 1301	1650
	Irvington 9	2000

Other Insulation Products

HARVEL OIL STOP

Oil Stop is used as a filling compound for enclosed coils in X-ray machines and other types of electronic equipment. It will not soften under heat in service, and is extremely resistant to the effects of acids, alkalies, water, oils and petroleum products.

WIRE MARKERS

Irvington Wire Markers are made in both plastic and varnished-tubing types, for quick, positive wiring identification that speeds up original assembly and simplifies maintenance and repair work. Sizes and markings to specification.

PUNCHINGS

Insulating gaskets, washers and other parts can be punched to order from most of the materials in the extensive Irvington insulation line. Dies are on hand for many standard sizes and shapes — special designs can be tooled to specification.



Write for literature on the entire line of Irvington Insulation

VARNISH & INSULATOR CO.

6 Argyle Terrace, Irvington 11, New Jersey

One Source of Supply - Headquarters for

E-I sealed leads and multiple headers

FOR EVERY APPLICATION

Standard
**SEALED
LEADS**

Over 50 standard types to choose from. Made of hard glass, preformed with microscopic air cushioning. Absolutely free from internal strain. Tin dipped for easy soldering. Write for Bulletin 849 for complete information.

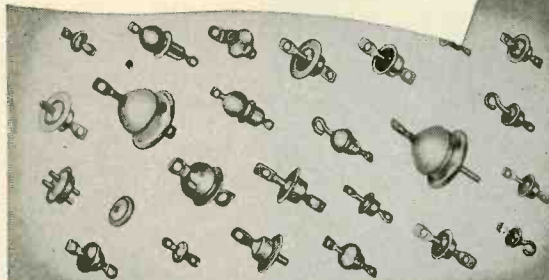

Standard
**MULTIPLE
HEADERS**

Over 100 standard types available. All headers vacuum tight, with cushioned glass preforms. Completely strain free, tin dipped, silicone treated. Many optional features including CRT closures. Full information can be obtained by writing for Bulletin 850.

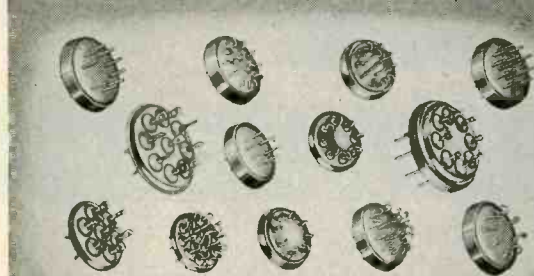

CUSTOM
**SEALS to
Specification**

Practically any type of sealed terminal or multiple header can be produced to exact customer requirements. Whether your problem involves a new design or the application of a standard item, E-I engineers offer complete collaboration.

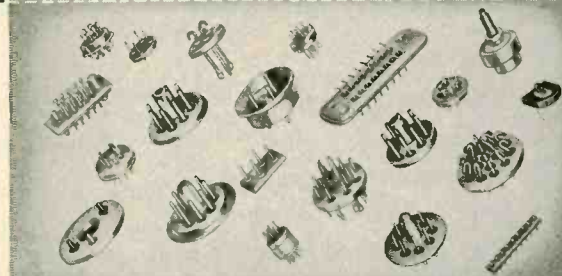

SAMPLE
**KIT for
Designers**

Contains 81 standard terminals, 11 different headers. All economy priced items—picked to solve practically any problem. Transparent case with labeled bins for easy selection. Complete kit sells for only \$10.00—check or money order.

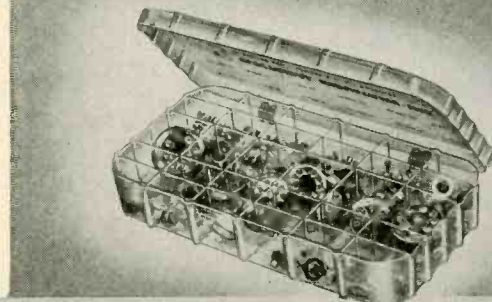

ELECTRICAL INDUSTRIES·INC

MANUFACTURERS OF SPECIALIZED ELECTRONIC EQUIPMENT

44 SUMMER AVENUE, NEWARK 4, NEW JERSEY





30 years of quality

When you install a Scientific Electric unit you're getting the finest that quality material, experienced engineering and constant research can produce. A unit backed up by 30 years of leadership in the electrical equipment field!

From Bombardiers (or induction heating units) to high voltage power supplies and spot welders, Scientific Electric's quality-tested precision products are serving alert manufacturers in all branches of electronics.

For complete information send for free catalog — today.



Scientific Electric

107-119 MONROE STREET
GARFIELD, NEW JERSEY

PRECISION MEASURING INSTRUMENTS FOR THE RADIO AND ELECTRONIC INDUSTRY

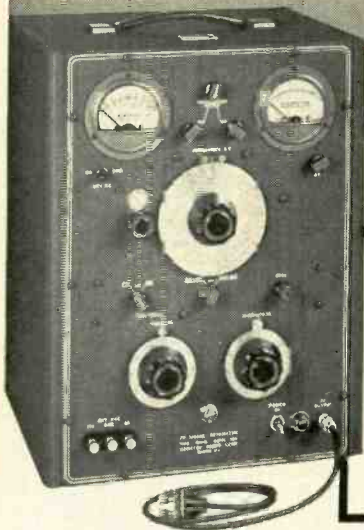

FM SIGNAL GENERATOR TYPE 202-B

RF COVERAGE: 54—216 megacycles in two ranges; accuracy $\pm 0.5\%$.
 FM DEVIATION: Three ranges, 0—24 kc., 0—80 kc., 0—240 kc., continuously adjustable.
 FM DISTORTION: Less than 2% at 75 kc. deviation.
 AMPLITUDE MODULATION: One range, 0—50%; calibrations at 30% and 50% modulation.
 INTERNAL MODULATING FREQUENCIES: Eight frequencies from 50 cycles to 15 kc.
 RF OUTPUT: 0.1 microvolt to 0.2 volt, continuously adjustable by means of 26.5 ohm piston type attenuator.



UNIVERTER TYPE 207-A

An FM-AM frequency converter accessory with unity gain for use with 202-B FM Signal Generator.
 RF RANGE: 0.1 mc. to 55 mc.
 RF INCREMENT DIAL: ± 300 kc. in 5 kc. increments.
 RF OUTPUT: 0.1 microvolt to 0.1 volt, calibrated output (26.5 ohms); 1.5 volts max., uncalibrated output (approx. 330 ohms).

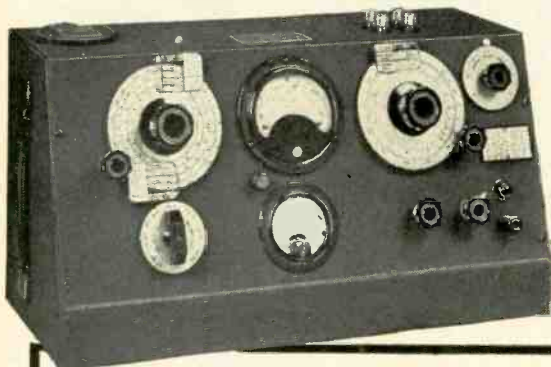

Q-METER TYPE 160-A

FREQUENCY RANGE: 50 kc. to 75 mc. ($\pm 1\%$, 50 kc.—50 mc.; $\pm 3\%$, 50 mc.—75 mc.). May be extended down to 1 kc. with external accessory oscillator.
 RANGE OF Q MEASUREMENTS, COILS: 50—625.
 ACCURACY OF Q MEASUREMENT: In general, $\pm 5\%$.
 RANGE OF Q TUNING CAPACITOR: Main Section, 30—450 mmf. ($\pm 1\%$ or ± 1 mmf., whichever is greater). Vernier Section, plus 3, zero, minus 3 mmf. (± 0.1 mmf.).

Q-METER TYPE 170-A

FREQUENCY RANGE:
 30 mc. to 200 mc. ($\pm 1\%$).
 RANGE OF Q MEASUREMENT: 80—1200.
 ACCURACY OF Q MEASUREMENT: In general, $\pm 10\%$.
 RANGE OF Q TUNING CAPACITOR: 11—60 mmf. ($\pm 1\%$ or ± 0.5 mmf., whichever is greater).



GLIDE SLOPE TEST SET—TYPE 212-A

For use with Type 211-A Signal Generator to test Glide Slope Receivers.
 RF FREQUENCY RANGE: 329 mc. to 335 mc.
 Output: Same as 211-A ± 1 db—Variations in output for constant input indicated.
 Output Impedance: 53 ohms unbalanced.
 IF FREQUENCIES: 20.700 mc., 20.400 mc., 21.000 mc. crystal controlled.
 Output: 1 microvolt to 1 volt across 53 ohms unbalanced.
 AM Modulation available.



OMNI RANGE SIGNAL GENERATOR

TYPE 211-A FREQUENCY RANGE: 88-140 megacycles in one range. Also two crystal controlled frequencies: 110.100 and 114.900 mc., each accurate to $\pm 0.0035\%$.
 AMPLITUDE MODULATION: Two ranges, 0-30% and 0-100%. Fidelity ± 0.5 db., 30 cycles to 11 kc.
 INTERNAL AUDIO OSCILLATOR: Two modulating frequencies, 400 and 1000 cycles.
 PHASE DISTORTION: Less than 0.25 degrees at 30 cycles up to 60% AM.
 OUTPUT VOLTAGE: 0.2 volts maximum across 26.5 ohms.

Write for further information



BOONTON RADIO
 CORPORATION

BOONTON - N.J. - U.S.A.

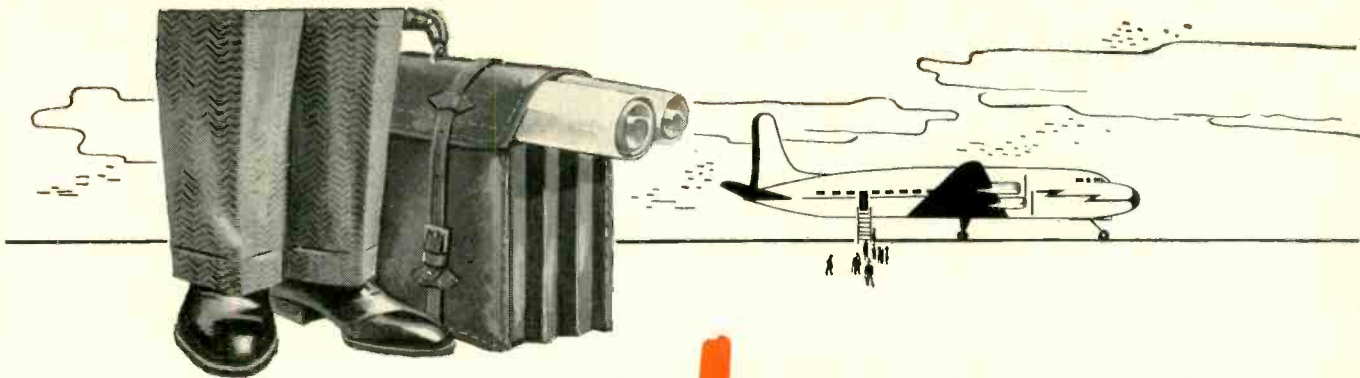

at your service

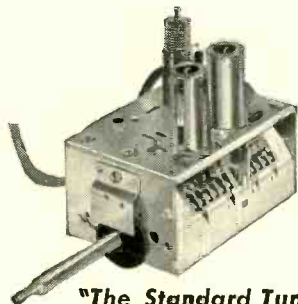

"The Standard Tuner"

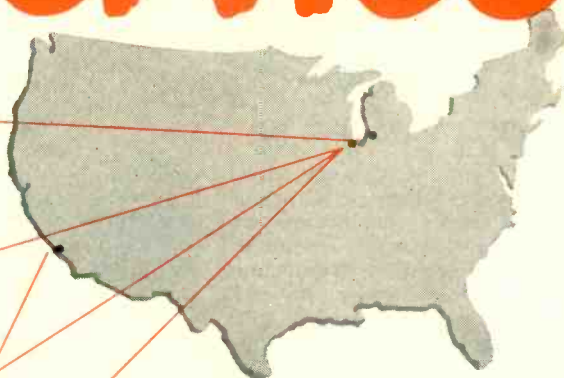
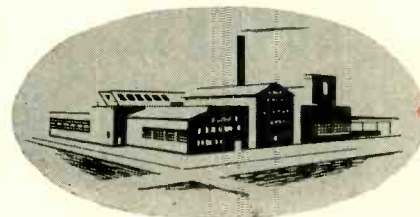
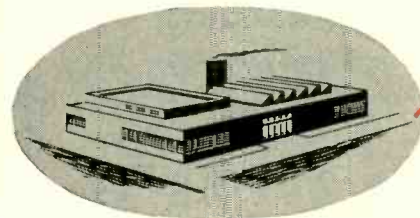
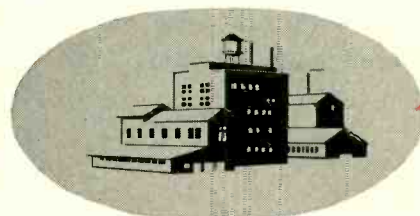
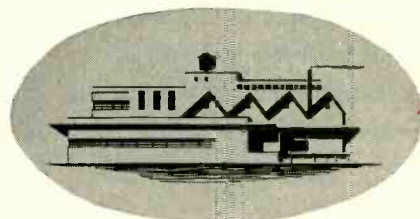
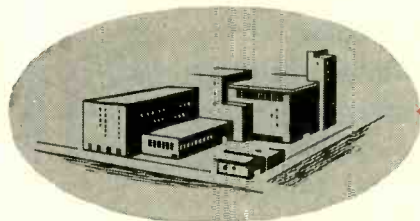

THE company that gave TV the most widely accepted tuner "The Standard Tuner" is at your service. With its vast facilities (five factories strategically located, plus highly experienced engineering development and production staffs), Standard Coil will assist you in any of your military or civilian electronic problems.

MANUFACTURED TO YOUR SPECIFICATIONS

TV Components

- Picture I. F. Transformers
- Cathode Trap Coils
- Video Peaking Coils
- Heater Choke Coils
- Sound I. F. Transformers
- Sound Discriminator Transformers
- Horizontal Oscillator Coils
- Horizontal Linearity Control Coils
- Width Control Coils
- I. F. Strips Flyback Coils

Radio and Miscellaneous Components

- I. F. Transformers
- R. F., Oscillator, & Solenoid Coils
- Antenna Loops
- Permeability Tuning Pre-selector Assemblies
- Miscellaneous Electro-Mechanical Assemblies

Standard COIL PRODUCTS CO. INC.
CHICAGO • LOS ANGELES • BANGOR, MICHIGAN



The New "Standard Booster" Model B-51 for fringe area reception.

**TEMPERATURES?
ATMOSPHERES?
PRESSURES?**



for the finest in Test Chambers

TEST WITH *Tenney*

Tenney has combined years of specialized experience with the most advanced engineering methods. Results have convinced industry that Tenney testing equipment is the finest available. For complete confidence, specify Tenney.

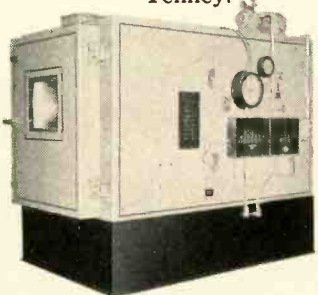

TENNEYZPHERE ALTITUDE CHAMBERS

Designed to withstand atmospheric pressure and to simulate global conditions of pressures, temperatures and humidities. Altitudes from sea level to approx. 75,000 ft. Temperature range from plus 200°F to minus 100°F. Also simulates desired relative humidity.

TENNEY SERVO UNIT

Portable air conditioning unit which may easily be attached to various types of laboratory enclosures—impact machines; tension machines; torsion testers; cold boxes and similar equipment. Through its use, articles undergoing testing, aging or weathering can be subjected to wide variations of humidity, heat and cold.

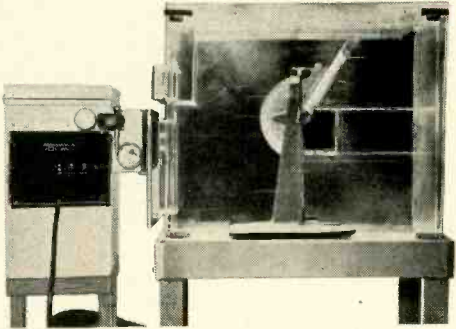

TENNEY TEMPERATURE AND HUMIDITY CHAMBER

Designed for positive control of temperature, humidity and air circulation. Permits the accurate checking of physical quality, fragility, tension and other factors.

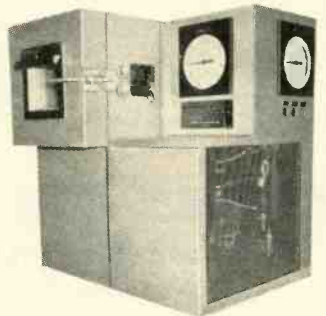

TENNEY SUB-ARCTIC INDUSTRIAL CABINETS

Designed for low-temperature testing of metals, radios, instruments, plastics, liquids, chemicals and pharmaceuticals. Temperature ranges of -40°F, -60°F, -95°F and -150°F are standard for each size.

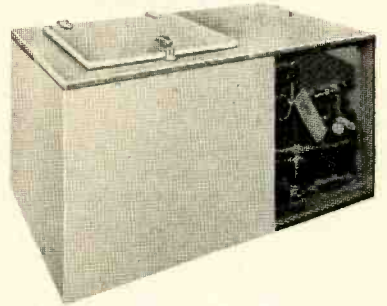

For further information on these and other Tenney test equipment, write to Tenney Engineering, Inc., Dept. J, 26 Avenue B, Newark 5, New Jersey.

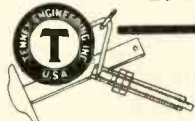

Tenney

Engineers and Manufacturers of Automatic Temperature, Humidity and Pressure Control Equipment

**THIS IS THE
ONE
BOOK**

**THE ONLY
ONE OF ITS KIND**

In which design engineers and purchasing agents will find a complete, accurate, and up-to-date list of the manufacturers of all types of electronic and allied products... components and complete equipment.

Keep it handy for ready reference throughout the year.

When buying, or requesting product information be sure to mention...

**electronics
BUYERS'
GUIDE**



MEASUREMENTS CORPORATION

Laboratory Standards

QUALITY ELECTRONIC
MEASURING INSTRUMENTS
FOR ACCURATE, DEPENDABLE SERVICE

NEW!

**CRYSTAL
CALIBRATOR
Model 111**
250 Kc. to 1000 Mc.



**INTERMODULATION METER
Model 31**
Range: 0 to 30%



**STANDARD SIGNAL GENERATOR
Model 82**
20 Cycles to 50 Mc.

**MEGACYCLE
METER
Model 59**
2.2 Mc. to 400 Mc.



STANDARD SIGNAL GENERATORS

MODEL	FREQUENCY RANGE	OUTPUT RANGE	MODULATION
65-B	75 Kc.-30 Mc.	0.1 microvolt to 2.2 volts	AM. 0 to 100% 400 cycles or 1000 cycles External mod., 50-10,000 cycles
78	15-25 Mc.; 195-225 Mc. 15-25 Mc.; 90-125 Mc. other ranges on order	1 to 100,000 microvolts	AM. 8200-400 cycles 625-400 cycles Fixed at approximately 30%
78-FM	86 Mc.-108 Mc.	1 to 100,000 microvolts	Deviation 0-300 kc, 2 ranges FM. 400-8200 cycles External modulation to 15 Kc.
80	2 Mc.-400 Mc.	0.1 to 100,000 microvolts	AM. 0 to 30% 400 cycles or 1000 cycles External mod., 50-10,000 cycles.
82	20 cycles to 200 Kc. 80 Kc. to 50 Mc.	0-50 volts 0.1 microvolt to 1 volt	Continuously variable 0-50% from 20 cycles to 20 Kc.
84	300 Mc.-1000 Mc.	0.1 to 100,000 microvolts	AM. 0 to 30%, 400, 1000, or 2500 cycles. Internal pulse modulator. External mod., 50-30,000 cycles.
90	20 Mc.-250 Mc.	0.3 microvolt to 0.1 volt	Continuously variable, 0 to 100% Sinusoidal modulation 30 cycles- 5 Mc. Composite TV modulation.

U.H.F. OSCILLATOR

MODEL	FREQUENCY RANGE	OUTPUT RANGE	OUTPUT IMPEDANCE
112	300 Mc. - 1000 Mc.	Maximum varies between 0.3 volt and 2 volts. Adjustable over 40 db range	50 ohms

PULSE GENERATOR

MODEL	FREQUENCY RANGE	PULSE WIDTH	OUTPUT
79-B	60 to 100,000 cycles	Continuously variable from 0.5 to 40 microseconds	Approximately 150 volts positive with respect to ground. "Sync Output" 75 volts positive with respect to ground.

SQUARE WAVE GENERATOR

MODEL	FREQUENCY RANGE	WAVE SHAPE	OUTPUT
71	Continuously variable 6 to 100,000 cycles	Rise time less than 0.2 microseconds with negligible overshoot	Step attenuator: 75, 50, 25, 15, 10, 5 peak volts fixed and 0 to 2.5 volts continuously variable.

U.H.F. RADIO NOISE and FIELD STRENGTH METER

MODEL	FREQUENCY RANGE	INPUT VOLTAGE RANGE
58	15 Mc. to 150 Mc.	1 to 100,000 microvolts in antenna. 1 to 100 microvolts on semi-logarithmic output meter, balanced resistance attenu- ator with ratios of 10, 100 and 1000 ahead of all tubes.

VACUUM TUBE VOLTMETERS

MODEL	VOLTAGE RANGE	FREQUENCY RANGE	INPUT IMPEDANCE
62	0-1, 0-3, 0-30 and 0-100 volts AC or DC	30 cycles to over 150 Mc.	Approximately 7 mmfd.
62-U.H.F.	0-1, 0-3, 0-30 and 0-100 volts AC or DC	100 Kc. to 500 Mc.	Approximately 2 mmfd.
67	.0005 to 300 volts peak-to-peak	5 to 100,000 sine-wave cycles per second	1 megohm shunted by 30 mmfd.

MEGACYCLE METER

MODEL	FREQUENCY RANGE	FREQUENCY ACCURACY	MODULATION
59	2.2 Mc. - 400 Mc.	Within $\pm 2\%$	CW or 120 cycles fixed at ap- proximately 30%. Provision for external modulation

CRYSTAL CALIBRATOR

MODEL	FREQUENCY RANGE	FREQUENCY ACCURACY	HARMONIC RANGE
111	250 Kc. - 1000 Mc.	0.001%	.25 Mc. Oscillator: .25-450 Mc. 1 Mc. Oscillator: 1-600 Mc. 10 Mc. Oscillator: 10-1000 Mc.

BRIDGES

MODEL	INDUCTANCE (L)	CAPACITANCE (C)	AC RESISTANCE (R)
102	0.5 microhenry to 110 henries	1 mmf. to 110 mfd. Power factor 0-30%	1 ohm to 11 megohms

MEASUREMENTS CORPORATION • BOONTON, N. J.



Products of the House of Resistors

Armed Services requirements as to corrosion-resistant materials and plating, low-temperature operation, vibration, rigid electrical and mechanical specifications, etc., can be incorporated in any of the Clarostat units.

COMPOSITION-ELEMENT CONTROLS (Series 48)

5/8 DIA. FOR MINIATURIZATION
Linear, 1,000 ohms to 5 megohms.
Taper, 5,000 ohms to 2.5 megohms;
10% resistance at 50% C.W. rotation.
Rated at 0.1 watt for linear units.
300° rotation.
Shaft locking device may be incorporated upon request.
Single and multiple units available.

Engineering Bulletin No. 121

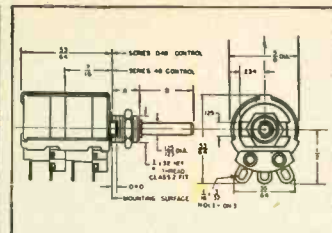
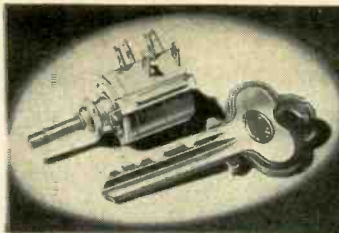

COMPOSITION-ELEMENT CONTROLS (Series 47)

15/16 DIA.

Linear and tapered, 1,000 ohms to 5 megohms.
Rated at 0.25 watt for linear units.
Standard taps at 37 1/2, 50 and 62 1/2% of effective rotation.
300° rotation without switch; 330° with.

Engineering Bulletin No. 117

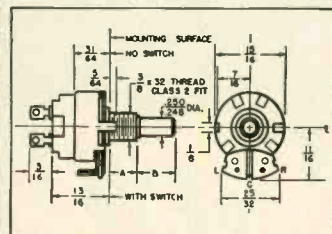
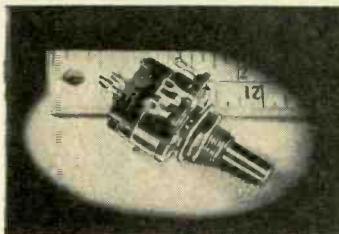

COMPOSITION-ELEMENT CONTROLS (Series 37)

1-1/8 DIA.

Linear and tapered, 1,000 ohms to 5 megohms.
Rated at 0.5 watt for linear units.
Standard taps at 37 1/2, 50 and 62 1/2% of effective rotation.
300° rotation without switch; 330° with.

Engineering Bulletin No. 112

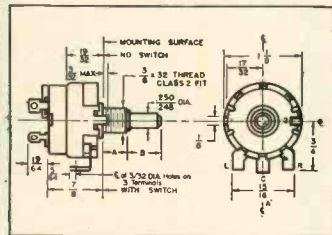

COMPOSITION-ELEMENT CONTROLS (Series 51)

2" DIA., HI-VOLTAGE, HI-RESISTANCE

Resistance range, 5,000 ohms to 50 megohms for linear units.
Rated at 1 watt minimum.
Insulation, 10,000 volts D.C. to ground, 4,000 volts maximum across end terminals.

Engineering Bulletin No. 119

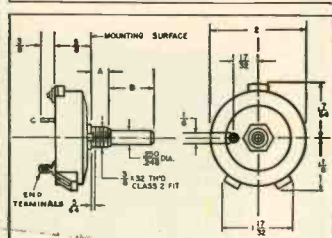
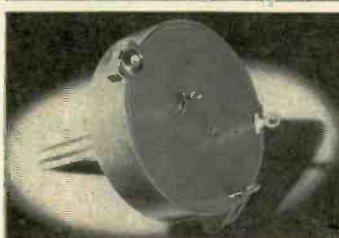

WIRE-WOUND CONTROLS (Series 43)

1-1/8 DIA.

Linear, 1 to 10,000 ohms.
Tapered, submit your requirements.
Rated at 2 watts, for linear units.
Mechanical rotation 300°. Electrical 280° without switch; 260° with switch.

Engineering Bulletin No. 116

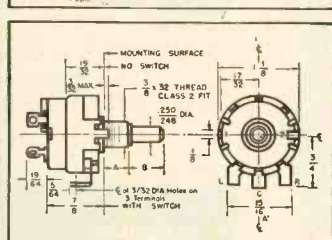

WIRE-WOUND CONTROLS (Series 58)

Linear, 1 to 50,000 ohms.
Tapered, 5 to 25,000 ohms.
Non-inductive 1 to 12,000 ohms, linear only.
Linear, 3 watts.
Mechanical rotation 300°. Electrical 280° without switch; 240° with switch.

Engineering Bulletin No. 118

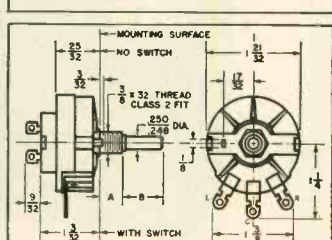

CONSTANT-IMPEDANCE PADS (Series CIT-58)

Continuous range Zero to 30 db.
Approximate, attenuation in 90° rotation, infinite attenuation last 10%.
6 to 2,000 ohm values. Below 6 and above 2,000, up to 10,000 ohms, special.
2.5 watts continuous D.C. rating.
Series CIT rated at 10 watts.
"L" Pads, Bridged "M" Pads, Bridged "H" Pads available.

Engineering Bulletin No. 102, and Bulletin No. 111

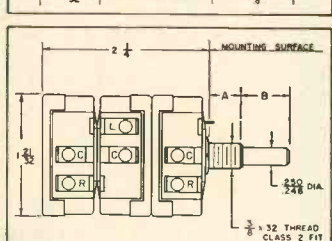

MULTIPLE-UNIT CONTROLS (Series 42)

In 1 to 18 unit assemblies. Single-shaft. No back lash.
Linear: 1 to 100,000 ohms.
Taper: 5 to 25,000 ohms. Max. res. change for any 10% of rotation, 5,000 ohms.
High linearity and close tracking.
Power rating for linear units, 3 watts per section.
Mech. rotation 291°; electrical 281°

Engineering Bulletin No. 142

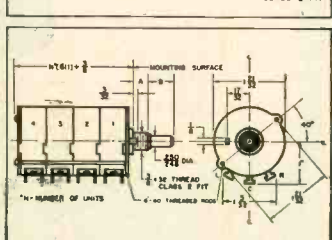

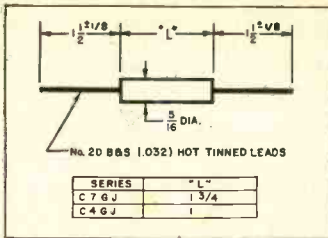

GREENOHM JR. POWER RESISTORS (Series GJ)

C7GJ, 7-watt, 0.5 to 5,000 ohms.
C4GJ, 4-watt, 0.5 to 1,000 ohms.
Standard resistance tolerance $\pm 10\%$.
Breakdown voltage between surface and resistance element, > 2500 volts A.C.
Ceramic tube casing, inorganic materials throughout. Pigtail terminals, standard.

Engineering Bulletin No. 110

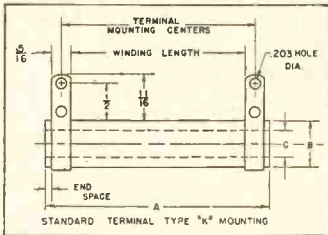

GREENOHM POWER RESISTORS

Fixed, 4 to 200 watts; adjustables, 10 to 200 watts.
10% plus/minus; 1%, special.
Intermediate taps, special.
Widest choice of mountings and terminals.
Non-inductive units made to specifications.

Engineering Bulletin No. 113

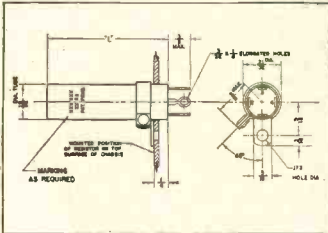

"STANDEE" RESISTOR (Series KS)

ABOVE-CHASSIS-MOUNTED

Rated, 10 to 25 watts.
Resistance range, 0.25 ohms to 15,000 ohms.
Taps can be furnished on special order.
Resistors are so designed to be above-chassis mounted for heat dissipation.

Engineering Bulletin No. 146

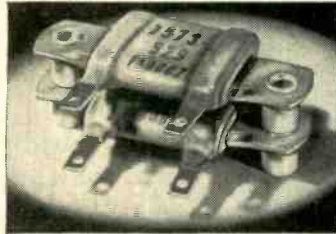
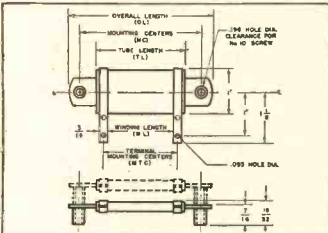

POWER RESISTORS (Series ZT)

STACK-MOUNTING

30, 40, 55, 65 and 75 watt ratings.
0.5 to 65,000 ohms maximum.
Mounting collars provide adequate free-air circulation for maximum heat radiation.

Engineering Bulletin No. 113

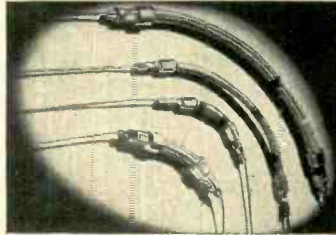
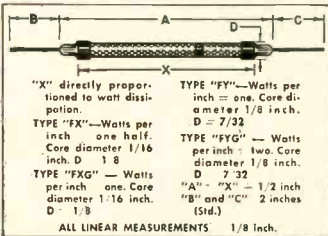

GLASOHM FLEXIBLE RESISTORS (Series FXG and FYG)

Used as resistors and also as miniature heating elements.
Ratings per winding inch: FXG, 1-watt; FYG, 2-watt.
Clinch-grip ferrule ends with bare pigtail terminals. Other terminals, special.

Engineering Bulletin No. 105

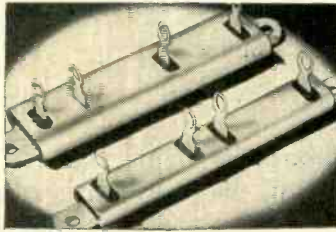
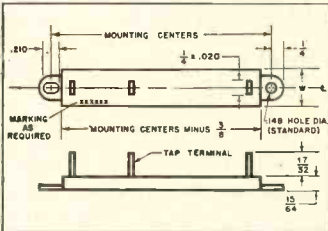

METAL-CLAD MOLDED RESISTORS (Series MMR)

From 5 ohms to 15,000 ohms per winding inch.
Ratings: 5 watts per winding inch, mounted on metal. 2 1/2 watts in free air.
Intermediate taps. Horizontal and vertical mountings.

Engineering Bulletin No. 109

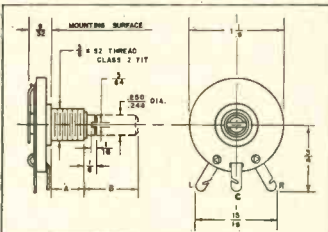

WIRE-WOUND CONTROLS (Series MH) "HUMDINGER"

Ultra-compact potentiometer or rheostat.
2 to 1,000 ohms, only linear resistance feasible. Rating, 1 watt.
Intermediate taps are special.
Metal dust-proof cover available.

Engineering Bulletin No. 103

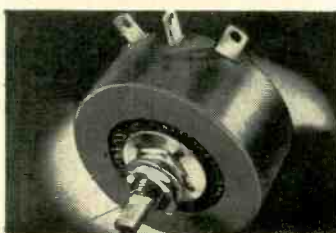
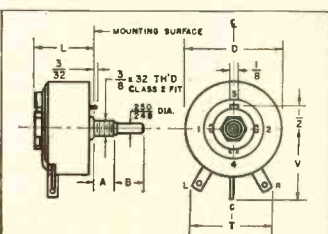

POWER RHEOSTATS (Series PW-25 & PW-50)

Full power rating even at fractional settings.
25-watt, 1/2 to 2,500 ohms; 50-watt, 1/2 to 5,000 ohms. Linear and tapered.
Tandem units available.
PW-25G and PW-50G approved under AN-R-14a specifications.

Engineering Bulletin No. 115

CLAROSTAT

MFG. CO., INC.

DOVER • NEW HAMPSHIRE



Large wall chart on request. • Write for bulletins of particular interest to you. • Submit your resistance and control problems. • Let us quote.

Emeloid

HILLSIDE, NEW JERSEY

Supplier of PLASTIC PRODUCTS to the Radio and Electronic fields since 1919, announce the addition of

PRINTED CIRCUITS

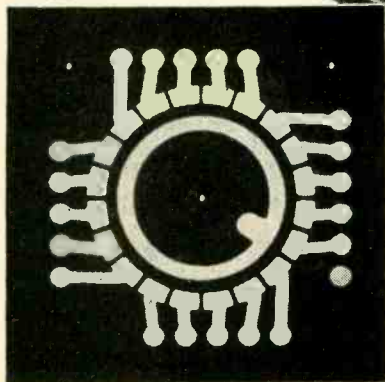
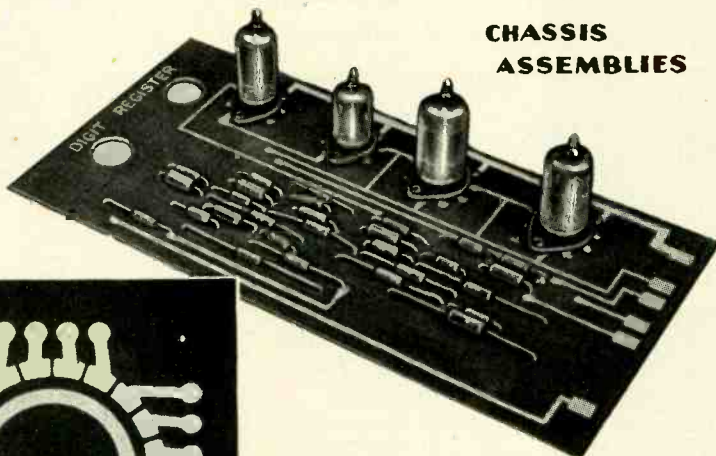

FLUSH. Abrasive resisting contacts and insulating switching plate withstands maximum brush load.

CHASSIS ASSEMBLIES — SWITCHING PLATES — SUB-ASSEMBLIES — COMMUTATORS — RESISTOR BOARDS — TERMINAL BOARDS

- **CONDUCTIVE MATERIALS** Copper, Silver, Steel, Bronze, Brass, Nickel, Aluminum
- **PLATING** Copper, Silver, Nickel, Aluminum, Gold, Silver, Chrome
- **INSULATING BASES** Phenolic, Melamine, Silicone, Polyester, Polystyrene, Polyethylene, Lucite, etc.; Ceramics
- **OPERATIONS PERFORMED** Die Stamping, Intricate Piercing, Plating, Injection Molding, Machining, Soldering, Assembly, Research

Emeloid

1239 CENTRAL AVENUE
HILLSIDE, NEW JERSEY

ELIZABETH 2-1944 - 1945 - 1946
N. Y. C., RECTOR 2-8554 - 8555

For additional information, write to PRINTED CIRCUIT DEPT.

Get RID of BARKHAUSEN OSCILLATION



with the

PERFECTION B. O. ELIMINATOR

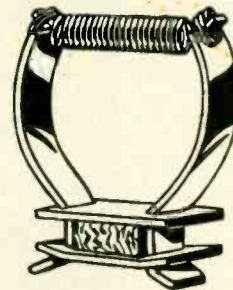

(Actual Size)

To eliminate the vertical black bars which appear in TV pictures as a result of Barkhausen Oscillation in the horizontal sweep output tube (such as the 25BQ6, 6BQ6, 6EV5, 25EV5, 6AU5 or 25AU5, etc.) — use the Perfection B. O. Eliminator.

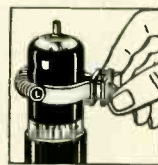

Easy to Install

Because it brings a concentrated magnetic field near the screen grid it usually eliminates the oscillation. Just slip the B. O. Eliminator over the tube, move down, or up, or turn until the dark vertical bars disappear.

Write today for full details!

PERFECTION ELECTRIC CO.

2635 South Wabash Avenue, Chicago 16, Illinois
Makers of Perfection Speakers, Ion Traps and BeamAjuster TV Picture Centering Controls

THIS BOOK...

The

electronics BUYERS' GUIDE

tells you who makes each of fourteen hundred different electronic and allied products.

Keep it and use it for quick buying and technical reference throughout the year.

When buying, or requesting product information be sure to mention ELECTRONICS BUYERS' GUIDE.

SPERRY GYROSCOPE COMPANY

KLYSTRON TUBES and MICROLINE† TEST EQUIPMENT

KLYSTRONS

Type	Description	Frequency Range in MC	Output Power*	Beam Voltage Max.	Reflector Voltage Max.	R-F Fittings
3K27	Reflex Oscillator	750 to 960	5w	1000	0 to -1500	1-SKL
SRL17	Reflex Oscillator	750 to 960	5w	1000	0 to -1500	1-SKL
3K23	Reflex Oscillator	950 to 1150	5w	1000	0 to -1500	2-SKL
SRL7C	Reflex Oscillator	1850 to 2160	12w	1000	0 to -1000	1-Type N
2K41	Reflex Oscillator	2660 to 3310	2.5w	1250	0 to -750	2-SKL
2K42	Reflex Oscillator	3300 to 4200	700mw	1250	0 to -750	1-SKL
2K43	Reflex Oscillator	4200 to 5700	600mw	1250	0 to -750	1-SKL
2K44	Reflex Oscillator	5700 to 7500	600mw	1250	0 to -750	1-SKL
2K39	Reflex Oscillator	7500 to 10,300	500mw	1250	0 to -750	1-SKL
SRX16	Reflex Oscillator	10,000 to 15,000	200mw	1250	0 to -750	1-SKL
SRC20	WG Reflex Oscillator	4400 to 4600	2w	1000	0 to -1000	Waveguide 2"x1"
SRC21	WG Reflex Oscillator	4600 to 4800	3w	1000	0 to -1000	Waveguide 2"x1"
SRC12	WG Reflex Oscillator	4800 to 5000	4w	1000	0 to -1000	Waveguide 2"x1"
SRC13	WG Reflex Oscillator	5000 to 5200	4w	1000	0 to -1000	Waveguide 2"x1"
3K21	Amplifier / Oscillator	2300 to 2725	40w	3000	none	4-SKL
3K30	Amplifier / Oscillator	2700 to 3300	40w	3000	none	4-SKL
3K22	Amplifier / Oscillator	3300 to 4000	40w	3000	none	4-SKL
SAC19	Amplifier / Oscillator	6000 to 6300	9w	625	none	2-Waveguide 1 1/2"x3/4"
SAS28	Cascade Amplifier	**2600 to 2800	225w	4000	none	2-SKL
2K35	Cascade Amplifier	2730 to 3330	40w	3000	none	1-1" -32 special 3-SKL
SAC41	Cascade Amplifier	3700 to 4200	30w	1000	none	2-BNC 1-Waveguide (WR-229) 1"x1/2"
SAC9	Cascade Amplifier	**4955 to 5065	9w	1000	none	2-BNC 1-SKL
SAC33	Cascade Amplifier	**4800 to 5300	500w	5200	none	2-BNC 1-Waveguide 2"x1"
SAL39	Pulsed Cascade Amp. (1% duty cycle)	960 to 1215	30kw	20,000	none	2-BNC 1-1/2" coaxial (female)
SAX30	Pulsed Amplifier (3.5% duty cycle)	**9100 to 9500	325w	5000	none	2-Waveguide 1"x1/2"
SAX22	Pulsed Amplifier (2.5% duty cycle)	**9100 to 9500	7.5kw	17,000	none	2-Waveguide 1"x1/2"
2K34	Oscillator-Buffer	2730 to 3330	40w	3000	none	2-SKL
2K47	Frequency Multiplier	250 to 280 in 2250 to 3360 out	140mw	1000	none	4-SKL
SMS27	Frequency Multiplier	**250 to 270 in **2500 to 2700 out	700mw	1250	none	2-BNC 1-SKL
SMC34	Frequency Multiplier	**260 to 280 in **4945 to 5320 out	100mw	1000	none	2-BNC 1-SKL
SMC11	Frequency Multiplier series	**715 to 875 in **3750 to 6000 out	700mw	1000	none	2-BNC 1-SKL
SMX32	Amp.-Freq. Multiplier	**4500 to 5250 in **9000 to 10,500 out	3w	1000	none	1-BNC 1-SKL
SMK40	Amp.-Freq. Multiplier	**4700 to 5200 in **23,500 to 26,000 out	600mw	1500	none	1-Waveguide 1"x1/2" 1-BNC 1-SKL

*Typical, mid-band output power.

**Pretuned by manufacturer to center frequency specified by customer. An individual tube has only trimmer tuning.

BARRETT MOUNTS

Model	Description	Bar-rett Type	Frequency Range-kmc	Max. VSWR	Fittings Input	Fittings Output
148	3/8" Coaxial (tunable)	811	5-2.5	2.0	UG-46/U	UHF
163	Type M Coaxial	821	2.5-2.7	1.8	Type N Plug	UHF
85	Type M Coaxial	821	2.7-2.9	1.8	Type N Plug	UHF
164	Type M Coaxial	821	2.9-3.1	1.8	Type N Plug	UHF
285	Type M Coaxial	821	3.1-3.3	1.8	Type N Plug	UHF
245	2"x1" Waveguide	821	3.7-4.5	1.5	UG-149A/U	UHF
83A	2"x1" Waveguide	821	4.6-5.65	1.5	UG-149A/U	UHF
253	1 1/2"x3/4" Waveguide	821	5.3-6.65	1.7	UG-344/U	UHF
212	1 1/2"x3/4" Waveguide	821	6.0-7.6	1.5	UG-344/U	UHF
313	1 1/2"x3/4" Waveguide	821	6.6-8.1	1.5	UG-344/U	UHF
184	1"x1/2" Waveguide	821	8.5-9.6	1.5	UG-39/U	UHF

IMPEDANCE METERS

Model	Frequency Range-kmc	Reading Accuracy	Transmission Line Size	Detector Element	Input	Flanges Output
361A	65-4.0	0.1mm	3/8" Coaxial	1N21B*	UG-46 U	UG-45/U
299	2.6-4.0	0.1mm	3"x1 1/2"	1N21B*	UG-214/U	UG-214/U
103B	3.95-6.0	0.1mm	2"x1"	1N23B*	UG-149A/U	UG-149A/U
116A	3.5-7.0	0.1mm	3/8" Coaxial	1N23B*	UG-141/U	UG-140/U
201	5.3-8.2	0.1mm	1 1/2"x3/4"	1N23B*	UG-344/U	UG-344/U
145	8.1-12.4	0.1mm	1"x1/2"	1N23B*	UG-39/U	UG-39/U
344	12.4-18.0	0.1mm	.702"x.391"	1N26	UG-419/U	UG-419/U
320	18.0-26.5	0.01mm	3/2"x3/4"	1N26	UG-425/U	UG-425/U
346	26.5-40.0	0.01mm	.360"x.220"	1N53	UG-381/U	UG-381/U

*The Model 821 barretter element can also be used.

IMPEDANCE TRANSFORMERS

Model	Type	Description	Frequency Range-kmc	Max. VSWR	Fittings
363	Double-Slug	3/8" Coaxial	.65-3.7	5-6	UG-46/U and UG-45/U
34A	Triple-Stub	3/8" Coaxial	1.7-3.75	50	UG-46/U and UG-45/U
137	Double-Stub	3/8" Coaxial	2.66-10.3	—	Type N Jack
301	Double-Slug	3"x1 1/2"	2.6-4.0	10	UG-214/U
109B	Double-Slug	2"x1"	3.95-6.0	8-14	UG-149A/U
117B	Susceptance Waveguide	2"x1"	3.95-6.0	40	UG-149A/U
202	Susceptance Waveguide	1 1/2"x3/4"	5.3-8.1	40	UG-344/U
178	Susceptance Waveguide	1"x1/2"	8.1-12.4	40	UG-39/U
146	Double-Slug	1"x1/2"	8.1-12.4	8-14	UG-39/U
409	Susceptance Waveguide	1"x1/2"	8.1-12.4	40	UG-39/U
408	Susceptance Waveguide	1/2"x1/4"	18.0-26.5	40	UG-425/U
347	Susceptance Waveguide	0.360"x0.220"	26.5-40.0	35	UG-381/U

FREQUENCY METERS

Model	Description	Type*	Frequency Range-kmc	Absolute Accuracy	Fittings R-F	Video
124B	Broadband Coaxial	T	.66-3.0	1/1000	Type N	UHF
S22	Detector Wave-meter Kit	T&A	2.4-3.4	1/2000	Type N	UHF
291A	Cavity	T&A	2.575-3.78	1/10,000	Type N	UHF
27A	Coaxial	T	3.5-6.5	1/1000	Type N	UHF
28B	Cavity	T&A	4.01-6.0	1/10,000	UG-149A/U	UHF
207	Coaxial	T	5.3-8.1	1/2000	Type N	UHF
208A	Cavity	T&A	5.49-8.1	1/10,000	UG-344/U	UHF
273	Cavity	T&A	8.1-11.9	1/10,000	UG-39/U	UHF
536	Coaxial	T	8.1-12.4	1/1000	Type N	BNC
540	Cavity	T	12.4-18.0	1/5000	UG-419/U	BNC
348	Cavity	T&A	13.8-18.0	1/1000	UG-419/U	
541	Cavity	T&A	18.0-26.5	1/5000	UG-425/U	
349	Cavity	T&A	19.0-26.0	1/1000	UG-425/U	
350	Cavity	T&A	26.5-39.0	1/1000	UG-381/U	
542	Cavity	T&A	26.5-39.0	1/5000	UG-381/U	

*T—Transmission, A—Absorption

DIRECTIONAL COUPLERS

Model	Description	Frequency Range-kmc	Attenuation-db	Fittings
518	3/8" Coaxial	.12-2.4	20	UG-46/U*
517	3/8" Coaxial	.24-4.8	20-30-40	UG-46/U*
519	3/8" Coaxial	.48-9.6	20-30-40	UG-46/U*
480	3/8" Coaxial	.96-1.99	20-30-40	UG-46/U*
467	3/8" Coaxial	1.99-4.0	20-30-40	UG-46/U*
730	3/8" Coaxial	2.47-3.13	26.5	UG-46/U*
306	3"x1/2" Waveguide	2.6-4.0	30	UG-214/U
233	2"x1" Waveguide	4.0-6.0	24	UG-149A/U
321	2"x1" Waveguide	4.0-6.0	30	UG-149A/U
322	2"x1" Waveguide	4.0-6.0	40	UG-149A/U
209	1 1/2"x3/4" Waveguide	5.3-8.1	24	UG-344/U
237	1 1/2"x3/4" Waveguide	5.3-8.1	30	UG-344/U
235	1"x1/2" Waveguide	8.1-12.4	20	UG-39/U
236	1"x1/2" Waveguide	8.1-12.4	24	UG-39/U
234	1"x1/2" Waveguide	8.1-12.4	40	UG-39/U
388	0.702"x0.390" Waveguide	12.4-17.0	20	UG-419/U
413	1/2"x1/4" Waveguide	18.0-26.5	20	UG-425/U
415	1/2"x1/4" Waveguide	18.0-26.5	40	UG-425/U
405	0.360"x0.220" Waveguide	26.5-36.0	20	UG-381/U
429	0.360"x0.220" Waveguide	32.0-39.0	10	UG-381/U

*Input fitting. Main line output, UG-45/U. Secondary line output, UG-46/U except for Model 730 which has Type N Jack.

SHORTS

Model	Description	Frequency Range—kmc	Fittings
636	3/4" Coaxial	7-4.0	UG-46/U
114A	2"x1" Waveguide	3.95-6.0	UG-149A/U
203	1 1/2"x3/4" Waveguide	5.3-8.2	UG-344/U
377	1"x1/2" Waveguide	8.1-12.4	UG-39/U
372	0.702"x0.391" Waveguide	12.4-18.0	UG-419/U
373	1/2"x1/4" Waveguide	18.0-26.5	UG-425/U
371	0.360"x0.220" Waveguide	26.5-40.0	UG-381/U

ATTENUATORS

Model	Description	Frequency Range—kmc	Attenuation Range—db	Waveguide Size	Fittings
127A	Precision ±.2db	29-32mc	15-95		UHF
294	Variable	2.6-4.0	2-16.5	3"x1 1/2"	UG-214/U
289	Variable	3.95-6.0	2-20	2"x1"	UG-149A/U
110	Variable	4.0-6.0	0-20	2"x1"	UG-149A/U
216	Variable	5.3-8.1	2-20	1 1/2"x3/4"	UG-344/U
292	Variable	7.0-10.0	2-20	1 1/4"x5/8"	UG-51/U
134	Calibrated ±.5db	8.5-9.6	2-45	1"x1/2"	UG-39/U
173	Fixed ±.5db	8.5-9.6	3	1"x1/2"	UG-39/U
174	Fixed ±.5db	8.5-9.6	6	1"x1/2"	UG-39/U
183	Fixed ±.5db	8.5-9.6	10	1"x1/2"	UG-39/U
152A	Variable	8.1-12.4	0.5-20	1"x1/2"	UG-39/U
375	Variable	12.4-18.0	0.5-20	0.702"x0.391"	UG-419/U
374	Variable	12.4-18.0	15	0.360"x0.220"	UG-381/U

DETECTORS AND MIXERS

Model	Description	Frequency Range—kmc	Crystal	Fittings		
				Input	Local osc.	Output
111A	Detector Sect.	3.95-6.0	1N23B	UG-149A/U	none	UHF
206	Detector Sect.	5.3-8.2	1N21B*	UG-344/U	none	UHF
364	Detector Sect.	7.0-10.0	1N23B*	UG-51/U	none	UHF
360	Detector 1"x1/2" Waveguide	7.5-9.6	1N23B*	UG-39/U	none	UHF
357	Detector 0.702"x0.391" Waveguide	12.4-18.0	1N26	UG-419/U	none	UHF
358	Detector 1/2"x1/4" Waveguide	18.0-26.5	1N26	UG-425/U	none	UHF
359	Detector 0.360"x0.220" Waveguide	26.5-40.0	1N53	UG-381/U	none	UHF
337	Mixer 3/8" Coaxial	2.6-4.0	1N23	Type N Female	Type N	UHF
378	Mixer	2.6-4.0	1N23B	UG-214/U	Type N	UHF
338	Mixer 3/8" Coaxial	3.95-5.85	1N23B	UG-23B/U	Type N	UHF
334	Mixer	3.95-5.85	1N23B	UG-149A/U	Type N	UHF
339	Mixer 3/8" Coaxial	5.85-8.2	1N23B	UG-23B/U	Type N	UHF
335	Mixer	5.85-8.2	1N23B	UG-344/U	Type N	UHF
340	Mixer 3/8" Coaxial	7.0-10.0	1N23B	UG-23B/U	Type N	UHF
336	Mixer	7.0-10.0	1N23B	UG-51/U	Type N	UHF
379	Mixer	8.1-12.4	1N23B	UG-39/U	Type N	UHF
380	Mixer	12.4-18.0	1N26	UG-419/U	UG-419/U	UHF
381	Mixer	18.0-26.5	1N26	UG-425/U	UG-425/U	UHF
382	Mixer	26.5-40.0	1N53	UG-381/U	UG-381/U	UHF

*The Model 821 barretter element can also be used.

ADAPTERS

Model	Description	Frequency Range—kmc	Fittings
352A	3/8" Coaxial to Type N	0-4.0	UG-45/U
217	3/8" Coaxial to Type N	0-4.0	UG-46/U
354A	3/8" Coaxial to 3/8" Coaxial	0-4.0	UG-45/U
355A	3/8" Coaxial to 3/8" Coaxial	0-4.0	UG-46/U
101A	3/8" Coaxial to Type N	0-7.0	UG-140/U
286A	3/8" Coaxial to BNC	0-7.0	UG-140/U
398	3"x1 1/2" Waveguide to 3/8" Coaxial	2.6-4.0	UG-214/U
250	3"x1 1/2" Waveguide to Type N	2.6-4.0	UG-214/U
144A	3"x1 1/2" Waveguide to 3/8" Coaxial	2.6-4.0	UG-214/U
248	2"x1" Waveguide to Type N	3.95-6.0	UG-149A/U
100A	2"x1" Waveguide to 3/8" Coaxial	3.95-6.0	UG-149A/U
204	1 1/2"x3/4" Waveguide to Type N	5.3-8.2	UG-344/U
251	1 1/2"x3/4" Waveguide to 3/8" Coaxial	5.3-7.0	UG-344/U
249	1 1/2"x3/4" Waveguide to Type N	7.0-10.0	UG-51/U
167A	1"x1/2" Waveguide to Type N	8.1-12.4	UG-39/U
486A	SKL to 1"x1/2" Waveguide Transformer Adapter	8.1-12.4	UG-39/U

MAGIC TEES

Model	Description	Frequency Range—kmc	Max. VSWR (Any Arm)	Min. Isolation (Shunt to Series)	Fittings
323	3"x1 1/2"	2.6-4.0	2	35	UG-53/U
324	3"x1"	3.95-6.0	2	35	UG-149A/U
325	1 1/2"x3/4"	5.3-8.2	2	35	UG-344/U
326	1 1/4"x5/8"	7.0-10.0	2	35	UG-51/U
406	1"x1/2"	8.1-12.4	2	35	UG-39/U
389	0.702"x0.391"	12.4-18.0	2	35	UG-419/U
390	1/2"x1/4"	18.0-26.5	2	35	UG-425/U
391	0.360"x0.220"	26.5-40.0	2	35	UG-381/U

TEES AND BENDS

Model	Description	Frequency Range—kmc	Fittings
274	3"x1 1/2" Waveguide—Series Tee	2.6-4.0	UG-214/U
275	3"x1 1/2" Waveguide—Shunt Tee	2.6-4.0	UG-214/U
106A	2"x1" Waveguide—Series Tee	3.95-6.0	UG-149A/U
107A	2"x1" Waveguide—Shunt Tee	3.95-6.0	UG-149A/U
276	1 1/2"x3/4" Waveguide—Series Tee	5.3-8.2	UG-344/U
277	1 1/2"x3/4" Waveguide—Shunt Tee	5.3-8.2	UG-344/U
278	1 1/4"x5/8" Waveguide—Series Tee	7.0-10.0	UG-51/U
279	1 1/4"x5/8" Waveguide—Shunt Tee	7.0-10.0	UG-51/U
165A	1"x1/2" Waveguide—Series Tee	8.1-12.4	UG-39/U
166A	1"x1/2" Waveguide—Shunt Tee	8.1-12.4	UG-39/U
170	1"x1/2" Waveguide—E-Plane Bend	8.1-12.4	UG-39/U
171	1"x1/2" Waveguide—H-Plane Bend	8.1-12.4	UG-39/U
392	0.702"x0.391" Waveguide—Series Tee	12.4-18.0	UG-419/U
393	0.702"x0.391" Waveguide—Shunt Tee	12.4-18.0	UG-419/U
394	1/2"x1/4" Waveguide—Series Tee	18.0-26.5	UG-425/U
395	1/2"x1/4" Waveguide—Shunt Tee	18.0-26.5	UG-425/U
396	0.360"x0.220" Waveguide—Series Tee	26.5-40.0	UG-381/U
397	0.360"x0.220" Waveguide—Shunt Tee	26.5-40.0	UG-381/U

THERMISTOR MOUNTS

Model	Description	Frequency Range—kmc	Max. VSWR	Input	Fittings	Output
423A	2"x1" Waveguide	5.0-5.9	1.5	UG-149A/U		BNC
219A	1"x1/2" Waveguide	8.2-9.6	1.5	UG-39/U		BNC
365A	0.702"x0.391" Waveguide	15.75-18.0	1.5	UG-419/U		BNC
422	1/2"x1/4" Waveguide	23.5-25.1	1.5	UG-425/U		BNC

TERMINATIONS

Model	Description	Frequency Range—kmc	Power Capacity Watts	Max. VSWR	Fittings
637	3/8" Coaxial	6.5-3.5	12	1.4	UG-46/U
308	3"x1 1/2" Waveguide	2.6-4.0	1	1.04	UG-214/U
239	3"x1 1/2" Waveguide	2.6-4.0	1900	1.15	UG-53/U
105	2"x1" Waveguide	3.95-6.0	1	1.08	UG-149A/U
113	2"x1" Waveguide	4.0-6.0	310	1.10	UG-149A/U
240	2"x1" Waveguide	3.95-6.0	875	1.15	UG-149A/U
214	1 1/2"x3/4" Waveguide	5.3-8.2	1	1.04	UG-344/U
213	1 1/2"x3/4" Waveguide	5.3-8.2	150	1.10	UG-344/U
241	1 1/2"x3/4" Waveguide	5.85-8.2	420	1.15	UG-344/U
242	1 1/2"x3/4" Waveguide	7.0-10.0	280	1.15	UG-51/U
150	1"x1/2" Waveguide	8.1-12.4	1	1.04	UG-39/U
246	1"x1/2" Waveguide	8.1-12.4	100	1.10	UG-39/U
400	1"x1/2" Waveguide	8.1-12.4	175	1.15	UG-39/U
370	0.702"x0.391" Waveguide	12.4-18.0	5	1.05	UG-419/U
401	0.702"x0.391" Waveguide	12.4-18.0	100	1.15	UG-419/U
418	1/2"x1/4" Waveguide	18.0-26.5	.5	1.07	UG-425/U
316	1/2"x1/4" Waveguide	18.0-26.5	35	1.15	UG-425/U
369	0.360"x0.220" Waveguide	26.5-40.0	.5	1.10	UG-381/U
402	0.360"x0.220" Waveguide	26.5-40.0	18	1.15	UG-381/U

WATTMETER BRIDGES—SIGNAL SOURCES

Model 84C	Wattmeter Bridge
Model 123B	Wattmeter Bridge
Model 538	Microwave Power Meter
Model 444	Klystron Power Supply
Model 555	Klystron Power Supply
Model 296B	Microwave Receiver
Model 38A	F. M. Test Set (Commercial equivalent of the TS-147/B)

For detailed information write Special Electronics Department

SPERRY GYROSCOPE COMPANY

DIVISION OF THE SPERRY CORPORATION • GREAT NECK, NEW YORK

PRINTED IN U. S. A.

†T.M. Reg. U. S. Pat. Off.



KARP IS GEARED FOR ALL TYPES OF SHEET METAL FABRICATION



**BIG
JOBS**



**LITTLE
JOBS**

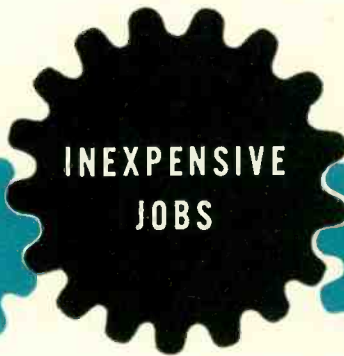

**INEXPENSIVE
JOBS**



**INTRICATE
JOBS**

To large and small manufacturers alike, the Karp Blueprint Man is the symbol of traditional excellence in sheet metal fabrication . . . hallmark of highest quality and value in every class of work, from the most routine to the most exacting.

Our plant, three full city blocks long, is equipped with every advanced mechanical facility to enhance the superior skills of our craftsmen, and to insure speedy and economical production.

Thousands of accumulated dies and jigs are at the service of our customers, to save them the time and expense of special dies. We do all types of welding, including heliarc. Aluminum welding is handled with great care and precision. Our welders and equipment are certified by the U. S. Air Force. Painting and finishing are done in a dustproof, water-washed atmosphere.

No job is too big or too small to merit the traditional excellence for which our craftsmanship is known. Write for data book.

Any Metal Any Gauge Any Size Any Quantity Any Finish

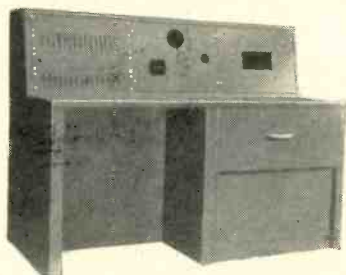

KARP METAL PRODUCTS CO., INC.

225 63rd STREET, BROOKLYN 20, NEW YORK
Specialists in Fabricating Sheet Metal for Industry

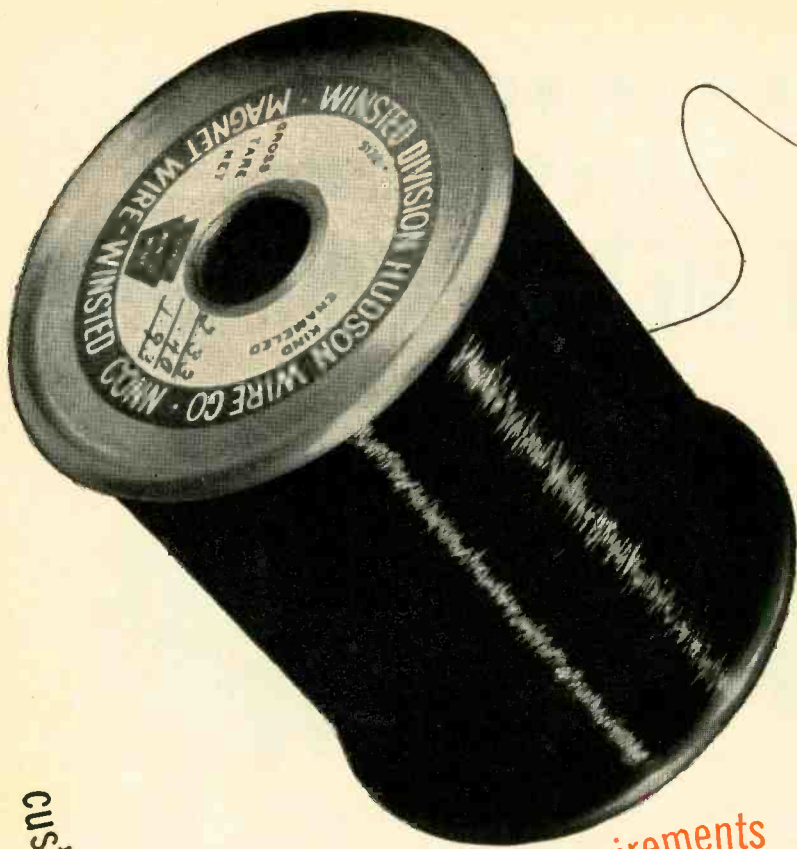

FINE WIRE made finer

⊙ Custom-made fine wire! Just specify the electrical properties, flexibility, tensile strength, laying speed, uniformity and other characteristics you must have. Our Hudson and Winsted Divisions will meet and maintain your specifications.

Uniformity of product is guaranteed by our critical supervision which guards against variations in size, structure and electrical values. Yes, "Fine Wire Made Finer!" That is why Hudson-Winsted fine wires are the first choice of electrical, radio, television and electronic manufacturers whose products are noted for reliability and long life.

Custom drawn ⊙ custom insulated ⊙ requirements to your most exacting ⊙ custom spooled

⊙ Tell us your wire problems and requirements. Our research, engineering and production facilities are at your disposal. Let us quote!

BARE WIRES (HUDSON WIRE DIVISION)

Copper	Silver-plated
Brass	Bronze
Zinc	Phosphor-Bronze
Tinsel	Silver
Tin	Monel
Nickel-Silver	Lead Wire
Cadmium	Fuse Wire
Oxygen-free	Specialty
Copper	Wires

TEXTILE-COVERED WIRES (WINSTED DIVISION)

Nylon	Cotton
Celanese	Rayon
Silk	Fiberglas

All available on bare or enameled wire, single or double covered.

INSULATED WIRES (WINSTED DIVISION)

MATERIALS	TYPES	COVERINGS
Copper	Instrument	Plain and Heavy
Aluminum	Tubing	Enamel
Iron	Litz	Formvar
Copper-clad	Multiplied	EZsol (Liquid Nylon)
Steel	and Twisted	Cement-coated Enamel

FINE WIRES (HUDSON & WINSTED DIVISIONS)

Specializing in fine wires, custom-drawn and insulated, to critical needs—size, material, insulation. Your consideration is called particularly to the finest wire sizes—Nos. 44 to 50.

hudson wire company



general offices: ossining, n. y. winsted division: winsted, conn.

MAGNETIC METALS AND ALLOYS

These metals fill a wide range of electrical and magnetic applications. They offer a variety of permeability characteristics, low hysteresis losses and high purity. Where their characteristics are particularly suited to the requirements of the application, these alloys are superior to other magnetic materials and will improve performance considerably.

HIPERNIK V® — A 50% iron-nickel grain oriented alloy. It is supplied in torodial coils of .002" and .005" lamination thickness. Both material and core are carefully processed under laboratory control to assure uniform characteristics.

HIPERNIK® — An alloy of iron and nickel with small amounts of manganese and silicon added. It has high initial and maximum permeability and low hysteresis loss. Principally used as core material for high grade audio and instrument transformers, it has a wide range of applications — sensitive relays, a-c meters, magnetic shields, audio transformers, reactors, etc.

CONPERNIK® — An iron-nickel alloy of the same chemical composition as Hipernik, but of different electromagnetic characteristics produced by a special annealing process. It is most applicable where a component having high ratio of reactance to resistance (high Q) is required. Also used in choke coils and other components having a high d-c component of current.

HIPERCO® — An iron-cobalt alloy containing 1/3 cobalt, 2/3 iron and 1 to 2% of another element to increase the electrical resistivity. Used primarily for aircraft equipment where size and weight saved is a vital factor. Transformers, generators, motors and high-speed aerial cameras are some of the uses.

Other alloys that serve a wide range of functions are Kovar,® Puron,* Cupaloy,* K-42-B,® Refractaloy® and Discaloy.® These are used for electrodes, contacts, for sealing glass and metal, for tube lead-in wires, and for high strength at high temperatures.

For further information about application and specifications write to Special Alloys Sales, East Pittsburgh.

*Trade-Mark

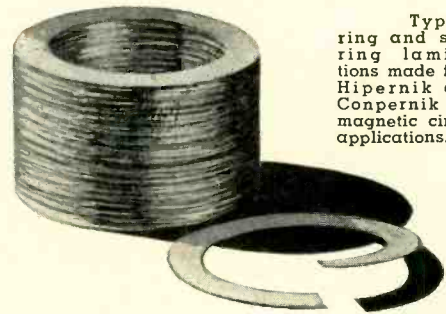

Typical ring and split ring laminations made from Hipernik and Conpernik for magnetic circuit applications.

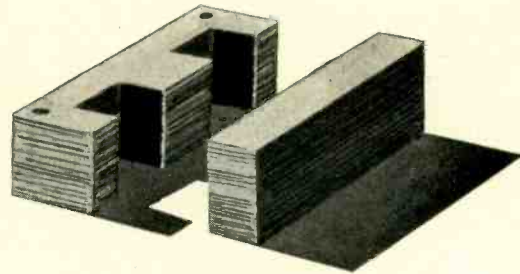

"E" and "I" punchings of Hipernik and Conpernik. These are normally mated with related shapes to form magnetic circuits through coils.

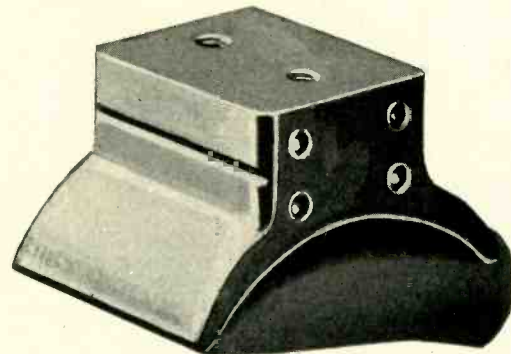

Motor pole for fractional horsepower motor made from Hipernik alloy laminations. Low coercive force assures precise positioning of d-c meters used in mechanical control applications.

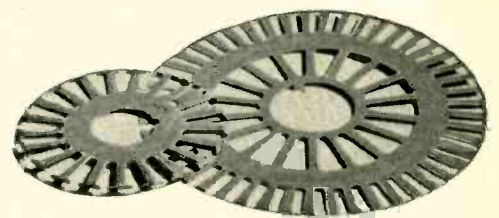

Hiperc armature punchings for aircraft generator.

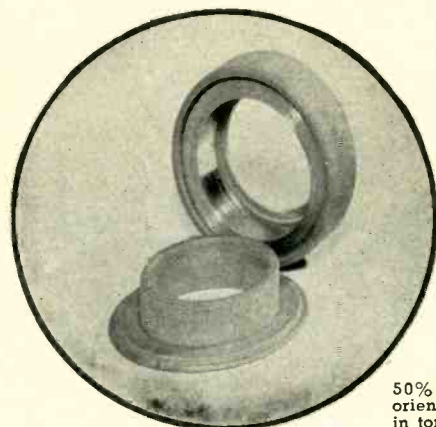

Hipernik V is a 50% iron nickel grain oriented alloy. Supplied in torodial cores of .002" or .005" lamination thicknesses.



YOU CAN BE **SURE**... IF IT'S
Westinghouse

SPECIAL ALLOYS

SWITCHBOARD INSTRUMENTS

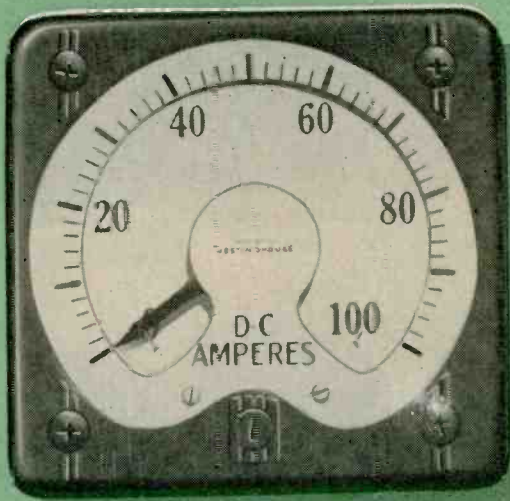

SOCKET INSTRUMENTS



PORTABLE INSTRUMENTS

PANEL INSTRUMENTS

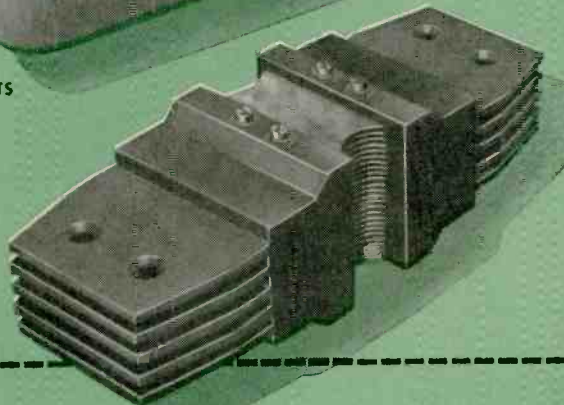

INSTRUMENT AUXILIARIES

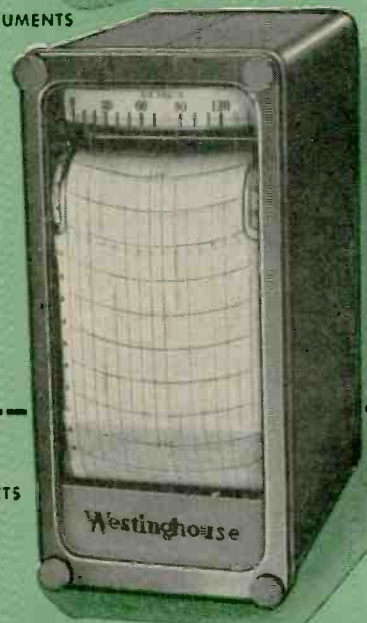

RECORDING INSTRUMENTS

The most complete line in the industry!

In the complete line of Westinghouse Electrical Instruments, you're sure to find the *right answer* to your measuring requirements. Moreover, you'll get a wider selection for specific applications, whether it be a-c or d-c current and voltage, single or polyphase circuits, watts or vars, frequency, power factor, synchrosopes, temperature indicators, ground detectors or position indicators.

For laboratories, production lines, power plants, field service, or military operations—whether the requirement is for recording or indicating—for portable or permanent application—Westinghouse Instruments give you lasting accuracy.

Meets A. S. A. Performance Requirements

Every Westinghouse Instrument is built to meet the rigid performance requirements of the American Standards Association. No more exacting guarantee of an instrument can be made.

Competent Application Assistance!

Westinghouse Instrument Application Engineers are available to help you in selecting and applying the proper instruments for your application. Simply call your nearest Westinghouse office.

For complete information on Westinghouse Instruments write for Booklet B-4696. Address: Westinghouse Electric Corporation, P. O. Box No. 868, Pittsburgh 30, Pennsylvania.

J-40406

YOU CAN BE SURE.. IF IT'S
Westinghouse

INSTRUMENTS



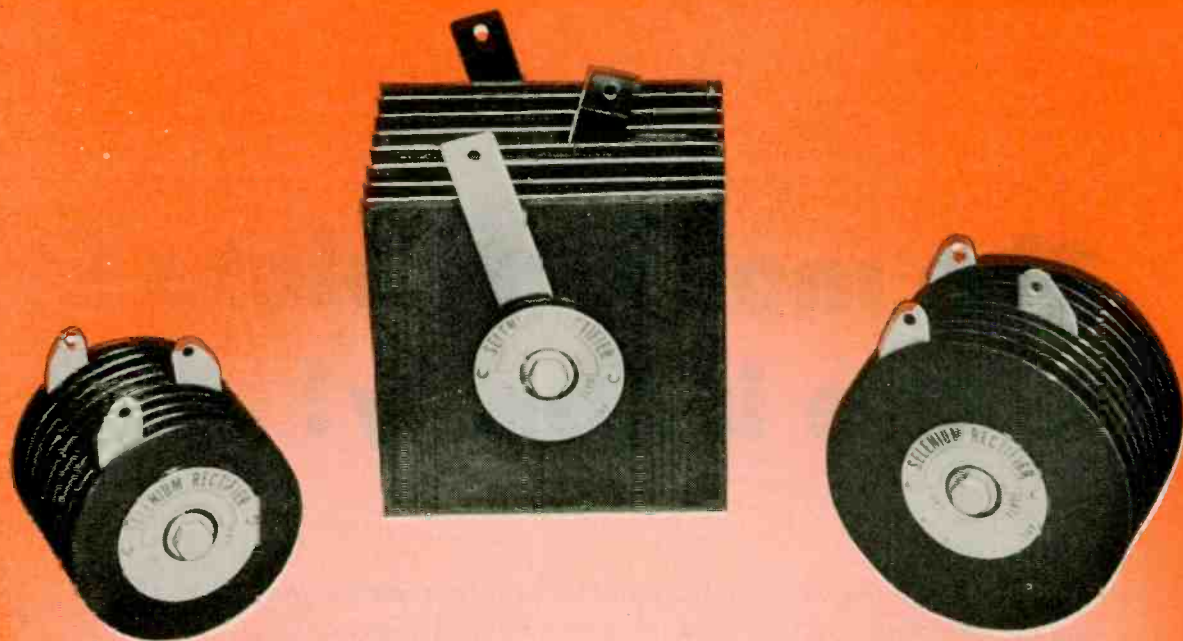

Pure Quality— **Selenium Stacks**

Selenium Rectifier Stacks manufactured by the exclusive Westinghouse process are characterized by their ability to operate continuously or in alternate cycles of extremely high and low temperatures up to 125° C—by the lowest rate of forward aging—by their high voltage per plate—and by uniform quality and dependable design performance over a long period of time.





These field-tested selenium stacks provide d-c from a-c source and are particularly useful where small size and minimum weight are important design factors.

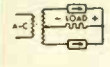
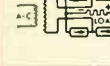
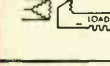
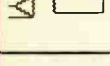

SCHEMATIC DIAGRAMS AND CELL RATINGS FOR WESTINGHOUSE TYPE H SELENIUM CELLS (TYPE M CELLS USE 1/2 VOLTAGE RATING SHOWN; CURRENT IS APPROX. AS SHOWN)

Maximum Ratings 35°C Ambient Self-Cooled Maximum Inverse Voltage—33 Volts RMS Per Cell

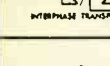
CELL NUMBER 8 Std. Cell Sizes (Six Shown)		1	2	3	4	5	6
CELL DIMENSIONS		" DIAMETER	1 3/8" DIAMETER	1 3/4" DIAMETER	2 1/16" DIAMETER	2 3/8" DIAMETER	2 3/4" DIAMETER
APPROXIMATE CELL SPACING	NORMAL	.142	.168	.190	.238	.326	.326
	WIDE	.207	.233	.264	.443	.452	.452
NUMBER CELLS PER STACK	NORMAL	1-8 9-20 21-36	1-8 9-20 21-32	1-8 9-20 21-40	1-8 9-20 21-36	1-8 9-18 17-28	1-8 9-16 17-28
	WIDE	1-8 9-20 21-30	1-8 9-20 21-28	1-8 9-20 21-32	1-8 9-16 17-20	1-8 9-16 17-20	1-8 9-16 17-20

RECTIFIER CIRCUIT CONNECTIONS	MAXIMUM D-C VOLTS	MAXIMUM D-C AMPERES PER CELL*																		
		1		2		3		4		5		6		1		2		3		
SINGLE PHASE - HALF WAVE  EAC = 2.3 (EDC + ER) IAC = 1.57 IDC Ripple Freq. = f Approx. Ripple = 121%	12	NORMAL	.125	.100	.075	.200	.175	.150	.350	.325	.300	.800	.650	.500	1.60	1.375	1.20	2.50	2.25	2.00
		WIDE	.138	.125	.113	.275	.250	.225	.500	.475	.450	.750	.700	.650	1.80	1.700	1.63	3.00	2.75	2.50
SINGLE PHASE - CENTER TAP  EAC = 1.15 (EDC + ER) IAC = 785 IDC Ripple Freq. = 2f Approx. Ripple = 48%	12	NORMAL	.250	.200	.150	.400	.350	.300	.700	.650	.600	1.20	1.10	1.00	3.00	2.75	2.40	5.00	4.50	4.00
		WIDE	.275	.250	.225	.550	.500	.450	1.000	.950	.900	1.50	1.40	1.30	3.60	3.40	3.25	6.00	5.50	5.00
SINGLE PHASE - BRIDGE  EAC = 1.15 (EDC + ER) IAC = 1.15 IDC Ripple Freq. = 2f Approx. Ripple = 48%	24	NORMAL	.250	.200	.150	.400	.350	.300	.700	.650	.600	1.20	1.10	1.00	3.00	2.75	2.40	5.00	4.50	4.00
		WIDE	.275	.250	.225	.550	.500	.450	1.000	.950	.900	1.50	1.40	1.30	3.60	3.40	3.25	6.00	5.50	5.00
THREE PHASE - HALF WAVE - STAR  EAC = .86 (EDC + ER) IAC = 585 IDC Ripple Freq. = 3f Approx. Ripple = 18%	16	NORMAL	.337	.270	.203	.540	.473	.405	.945	.877	.810	1.82	1.485	1.35	4.05	3.71	3.24	6.75	6.07	5.40
		WIDE	.371	.338	.304	.743	.675	.608	1.350	1.28	1.22	2.03	1.890	1.76	4.86	4.59	4.39	8.10	7.43	6.75
THREE PHASE - BRIDGE  EAC = .74 (EDC + ER) IAC = 85 IDC Ripple Freq. = 6f Approx. Ripple = 4.2%	32	NORMAL	.375	.300	.225	.600	.525	.450	1.05	.975	.900	1.80	1.65	1.50	4.50	4.13	3.60	7.50	6.75	6.00
		WIDE	.413	.375	.338	.825	.750	.675	1.50	1.425	1.350	2.25	2.10	1.95	5.40	5.10	4.89	9.00	8.25	7.50
SIX PHASE - STAR  EAC = .74 (EDC + ER) IAC = .41 IDC Ripple Freq. = 6f Approx. Ripple = 4.2%	16	NORMAL	.475	.380	.285	.780	.685	.570	1.33	1.235	1.14	2.28	2.09	1.90	5.70	5.22	4.58	9.50	8.55	7.60
		WIDE	.523	.475	.428	1.045	.950	.855	1.90	1.805	1.71	2.88	2.68	2.47	6.84	6.46	6.18	11.40	10.45	9.50
THREE PHASE - DOUBLE WYE  EAC = .85 (EDC + ER) IAC = 287 IDC Ripple Freq. = 6f Approx. Ripple = 4.2%	13.6	NORMAL	.750	.600	.450	1.20	1.05	.900	2.10	1.95	1.80	3.60	3.30	3.00	9.00	8.25	7.20	15.00	13.50	12.00
		WIDE	.825	.750	.675	1.65	1.50	1.350	3.00	2.85	2.70	4.50	4.20	3.90	10.80	10.20	9.75	18.00	16.50	15.00
D-C - VALVE 	30	NORMAL	.197	.157	.118	.314	.275	.257	.55	.51	.47	.94	.87	.79	2.36	2.16	2.89	3.93	3.54	3.14
		WIDE	.216	.196	.175	.432	.393	.383	.785	.75	.71	1.18	1.10	1.02	2.83	2.67	2.65	4.72	4.32	3.93

SYMBOL ABBREVIATIONS

% Ripple = $\frac{\text{(RMS) A-C Ripple Voltage} \times 100}{\text{Average D-C Voltage}}$ (Resistance load)
 ER = Average Voltage Crop thru rectifier
 Eac = (RMS) A-C input voltage
 Iac = (RMS) A-C line current
 f = Input frequency
 Idc = Average D-C load current
 Edc = Average D-C output voltage

*To be used to determine the number of cells in parallel to get required D-C output for the circuits shown above.

YOU CAN BE SURE... IF IT'S
Westinghouse

SELENIUM RECTIFIERS



Transformers



designed for electronic applications

Custom built for applications of Low and High Power Radar, electronic control, R. F. Heating and AM, FM and Television Transmitters.

FOSTERITE® TREATED

Small size electronic transformers, for airborne applications, may be FOSTERITE impregnated to resist moisture penetration and withstand temperature changes. Potting compound and metal cases are thus eliminated, saving size and weight.

HERMETICALLY SEALED

Small, light transformer components using HIPERSIL® type C cores, hermetically sealed with compression type or solder seal bushings, and designed to meet government specifications are now available.

DRY TYPE

Class B insulated, dry type transformers using HIPERSIL type C cores are available in ratings 150 kva and below, 8.6 kv and below. These transformers provide the ultimate in safety and economy for such applications as indoor rectifier plate transformers in radio and television transmitters or induction heaters.

For specific information, write to Specialty Transformer Division, Sharon, Pa.

YOU CAN BE SURE... IF IT'S
Westinghouse

TRANSFORMERS



FOR DEPENDABLE

ELECTRONIC TUBES

LOOK TO WESTINGHOUSE

*When you Specify Westinghouse
you get . . .*

- 1. QUALITY CONTROL.** Every step in the manufacture of every Westinghouse electronic tube is controlled and checked. This Westinghouse policy assures top performance in every tube.
- 2. PERSONALIZED INVENTORY.** At no obligation to you, Westinghouse distributors throughout the country will maintain a ready supply of the tubes you use, available for immediate delivery.

RESISTANCE WELDING CONTROL

A complete line of ignitron and
thyatron tubes for all resistance welding
control equipments.



YOU CAN BE SURE...IF IT'S

Westinghouse

RADAR APPLICATIONS

TR, ATR, Pre-TR Tubes
Reference Cavities
Modulator Spark Gaps

For military
electronic equipment



BROADCASTING & COMMUNICATIONS

Tubes for all transmitters,
from the smallest to the largest.

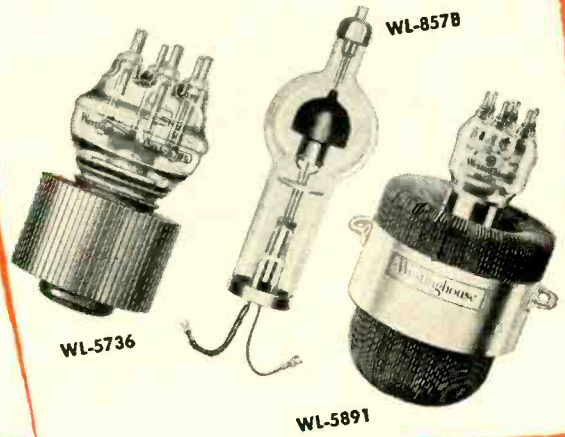

POWER CONTROL, REGULATION AND CONVERSION

Tubes for motor speed control and power
regulation and conversion to handle the wide
range of requirements of both light
and heavy industry.



RF HEATING

A complete range of power
tubes for both induction and
dielectric heating, from the small
radiation-cooled through the forced air-
cooled and water-cooled types.

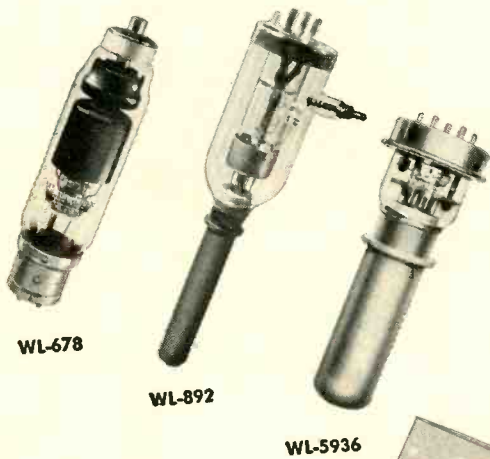

**This Booklet
Gives Helpful Tube
Information
You Can Use**

Classifies tubes and provides
essential technical data on each.
Send Today For Your Copy Of
The Westinghouse Easy Guide



Electronic Tube Division
Westinghouse Electric Corp.
Bloomfield, N. J.

Gentlemen:

Please send me a copy of the Westinghouse Easy Guide.

NAME _____ TITLE _____

COMPANY _____

ADDRESS _____

CITY _____ ZONE _____ STATE _____

TRANSICOIL

PRECISION COMPONENTS

TO *Your* SPECIFICATION

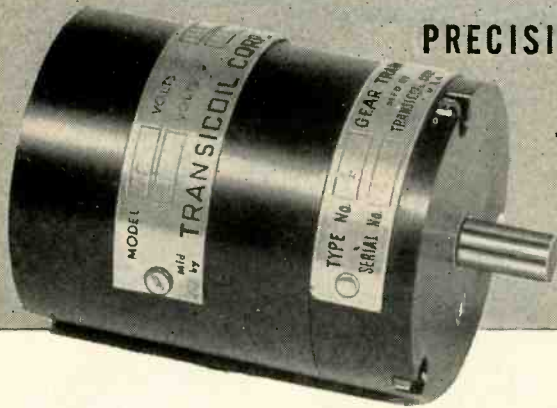

CONTROL MOTORS

Transicoil Servo Control Motors are 2-phase units, available for either 60-cycle or 400-cycle operation, in sizes from fractions of a watt to 10 watts mechanical output. They are precision assembled to operate under difficult conditions. Manufactured to

your phase voltage requirements—line operation or plate-to-plate. Plate-to-plate types are a Transicoil development that has reduced weight and size. Moreover, they eliminate the need for output transformers.

PRECISION GEAR TRAINS

Beautifully miniaturized, designed to mount the motor and data elements and to provide the necessary output shaft, Transicoil Precision

Gear Trains match a fine watch in their precise construction. Types supplied for all Transicoil and other control motors.

INDUCTION GENERATORS

Designed for operation in electronic equipment in which a variable voltage output must be proportional to a shaft speed having the same frequency as the supply. Output voltage is linear over an extended range. Low re-

sidual voltage, as a function of the design, enhances the performance of associated components. Induction generators also furnished with motor gear trains as a complete assembly when desired.

SERVO AMPLIFIERS

There are no fixed restrictions when you use Transicoil Servo Amplifiers! You specify such characteristics as: phase voltage, reduction rate, mounting, gain, phase shift, input

impedance, and damping. We conform to fine standardization to physical dimensions! Electromechanical feedback loops can also be built up with Transicoil components.

NOW! GREATLY EXPANDED FACILITIES

To meet the fast-growing demand for its products, Transicoil has recently tripled its production facilities. As in the past, there will be no "standard" Transicoil components. Each unit is designed, elec-

trically and mechanically, to match your specifications exactly. Engineering representatives in leading cities. They will be happy to give you information on any specific problem.

TRANSICOIL CORPORATION
107 Grand Street New York 13, N. Y.

Hold on / to this book

It will be
June 1952
before another
edition is published

**IT IS THE MOST COMPLETE,
AUTHORITATIVE AND UP-TO-DATE
DIRECTORY OF ELECTRONIC AND
ALLIED PRODUCTS AVAILABLE.**

It gives you the manu-
facturers of each of
more than fourteen
hundred electronic
and allied products.

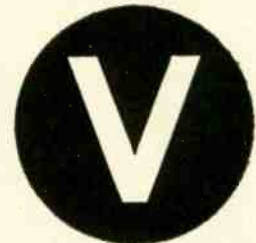

... gives you information
as to where they are in pro-
duction or available in a
reasonable time and unre-
stricted for general indus-
trial use.

1951-1952

electronics BUYERS' GUIDE

Please mention this book when
buying or inquiring from it.

For standard or
SPECIAL WIRING NEEDS..

HOOK UP

with

"Synkote"®

"SYNKOTE" INSULATION is almost completely impervious to water, oils, acids, alkolies, sunlight, cold, fungus growths; vermin-proof; unusually resistant to abrasion, flexing and tearing. Will not support combustion. High dielectric strength; low dielectric leakage.

Right now, of course, there's a heavy emphasis in the electronics field on insulated wires that conform to government procurement specifications.

Naturally, the standard line of Synkote wires includes many types that are fully approved for use on specification jobs.

But that's just a part of Synkote service to the electronics industry.

We're also prepared, on short notice, to engineer and produce special wire and cable designs to meet practically any requirement.

The check-list below gives just a few of the service requirements met either by standard Synkote wires, by easily made modifications or by engineered designs. For other wiring needs, consult our Engineering Department.

CHECK UP
on your requirements

✓ RADIO HOOK-UP WIRE JAN-C-76	Three approved types: SRIR, SRHV, WL. Details of approved sizes available on request.
✓ AIRCRAFT CABLE AN-JC-48A	Flexible, lightweight cable.
✓ COAXIAL CABLE JAN-C-17A	Flexible and semi-flexible types. Many approved constructions conforming to JAN-C-17A; also special constructions.
✓ HIGH-TEMPERATURE SERVICE	105° C hook-up wire, approved by Underwriters' Laboratories.
✓ TV WIRE	Twin-conductor; flat and flat perforated. Rotary antenna leads and coaxial types.
✓ NYLON JACKETING	For increased abrasion resistance. Can be applied over any type of cable.
✓ SHIELDING	Tinned or bare copper, loose or tight weave, to meet individual requirements.
✓ COLOR STRIPING	1, 2 or 3 stripes as required.
✓ MULTI-CONDUCTOR CABLES	Engineered to meet requirements.

Write us about your requirements

PLASTOID

Sales and Executive Offices:
42-61 24th Street, Long Island City 1, N. Y.

Corporation

Factory: HAMBURG, N. J.

Choose JOHNSON Variable Condensers For *DEPENDABLE EFFICIENCY*

Excellent design, careful workmanship and quality materials are combined in the manufacture of JOHNSON Variable Condensers to assure highest stability of the tuned circuit.

The entire JOHNSON line features high quality steatite insulation and sturdy construction — your assurance of long, dependable service.



Type
C & D

Unusually economical for quality condensers, Types C and D have .051" thick, rounded aluminum plates, large laminated rotor brushes. Air gap from .080" to .250" (Type D) and .125" to .500" (Type C). Panel space, Type C, 5 1/2" W x 5 3/8" H. Type D, 4 1/4" W x 4" H.



Type
E & F

Rugged, compact units for low and medium power transmitters. Aluminum plates .032" thick, rounded edges. Stainless steel shafts. Air gap from .045" to .125" (Type E) and .045" or .075" (Type F). Panel space, Type E, 2 5/8" square; Type F, 2-1/16" square.

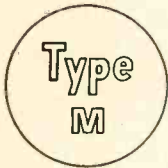

Type
M

MINIATURE — SMALLEST EVER BUILT!

Ideal for VHF, miniature test equipment, etc. Soldered construction, silver plated beryllium copper contact spring, split sleeve rotor bearings — no shaft wobble. Made in single and differential models up to 19.6 mmf and butterfly up to 11 mmf. Panel space only 5/8" x 3/4". Air gap .017".

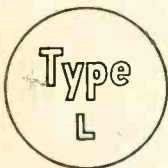

Type
L

Ceramic soldered — no eyelets or rivets to loosen. All brass, soldered construction. "Bright alloy" plated. Ideal for rough service. Beryllium copper contact spring, silver plated. Made in butterfly, single and differential types. Panel space 1 3/8" square. Air gap .030". Also furnished in .020", .060" and .080".

TYPE N

Small mounting space requirements, extremely high voltage rating and fine adjustment make these neutralizing condensers ideal.

TYPE BC

... for Commercial and Broadcast use where high voltage, high current conditions prevail.



New aluminum die cast plates have heavy beaded round outer edge for maximum voltage breakdown.

Cast aluminum end plates, with rounded edges, rugged steatite insulators with long creepage path. Width 7 1/8", height 7-5/16". Voltage ratings up to 18,000 volts peak breakdown.

Many other types, including pressurized units, are made for high voltage, high power applications.

TYPE G

Extremely popular as neutralizing condensers for medium and low power stages. Also widely used for grid and plate tuning at high frequencies.

TYPE R

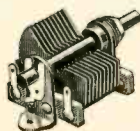

Here's the JOHNSON version of a highly popular standardized condenser widely used in compact portable and mobile equipment. Engineered for efficient, quiet operation in aircraft, police

and other mobile receivers and transmitters as well as laboratory and test equipment. All soldered and riveted construction. Heavy steatite insulating bars. Supplied at present only on special order in production quantities. Write E. F. JOHNSON COMPANY for specifications and full details.

WRITE TODAY FOR
JOHNSON CONDENSER CATALOG

JOHNSON a famous name in Radio

E. F. JOHNSON CO.

WASECA, MINN.

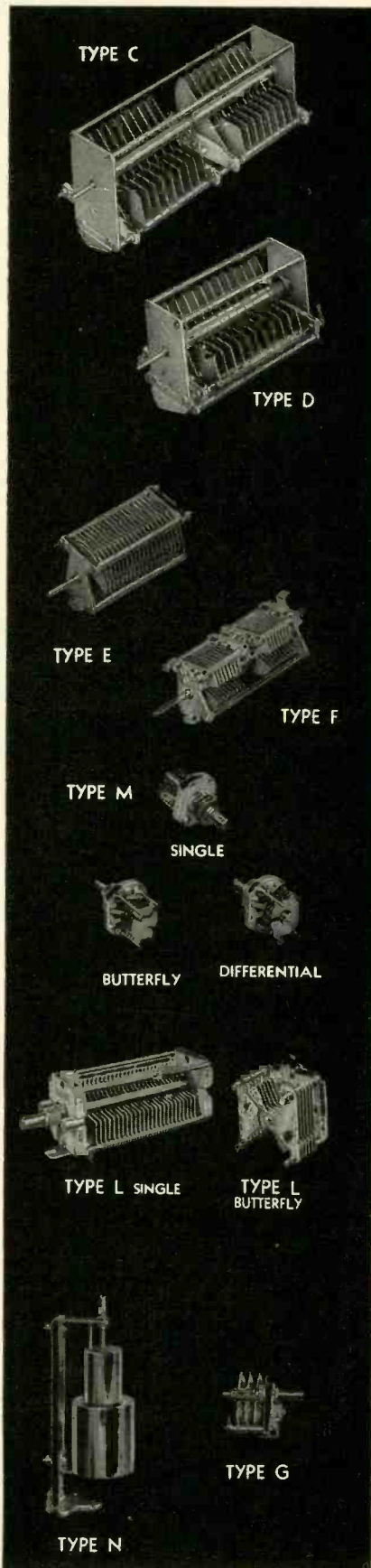

Perfect in Every Detail . . .

JOHNSON *Quality* INSULATORS

In design . . . material . . . workmanship, you'll find characteristic JOHNSON superiority.

Each insulator is designed for a specific purpose. Where lowest losses are vital, glazed steatite is used; elsewhere, superior grade electrical porcelain. Proportions and contours are chosen to best balance insulating value — creepage path, dielectric strength and electrical losses — against mechanical strength in the various sizes. Hardware is high grade nickel plated brass.

Why be satisfied with less than the best?

Bold face listings are illustrated; light face listings are similar except for size. "H" indicates height of ceramic above mounting surface.

Cat. No.	Material	H	Cat. No.	Material	H
135-20	Steatite	1 9/16	135-50	Steatite	1/2
-22		1	-51		13/16
-24		5/8	-52		1 1/8
135-22J	Steatite, Jack type	1	135-53	Porcelain*	1 3/4
-20J		1 9/16	135-54	Porcelain**	4
135-503	Steatite cone	2	* **Mounting Flanges not included		
-500		5/8	135-90	Mtg. flange for 135-53	
-501		1	-91	Mtg. flange for 135-54	
-502		1 1/2	135-15-90	Glass lead-in bowl	6 15/16
-504		2	O.D., 4 3/8 high, 11/16 hole.		
135-66	Porcelain, metal base	2 3/4	Also furnished with mounting flange, gaskets, and studs, singly or in pairs.		
-67		4 1/2	N.P. Brass Studs, 1/4-20 thread, with nuts and washers. For -53 and -54 insulators or other uses.		
135-68	Porcelain, metal base	2	115-240	8"	
-65		1 3/8	115-241	10"	
135-42	Steatite	7/8	115-242	15"	
-40		1 1/4			
-44		5/8			
135-42J	Steatite, jack type	7/8			
-40J		1 9/16			

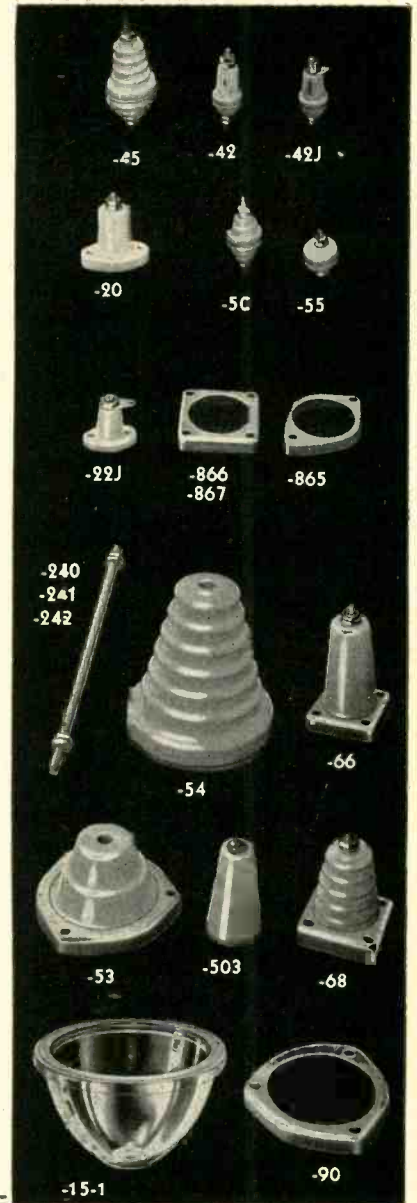

JOHNSON KNOBS and DIALS

Featuring fresh, advanced styling, these new JOHNSON models will enhance the appearance of your equipment. Molded phenolic knobs have 12 well defined flutes, large gripping area. Knob faces slightly convex, sides slightly tapered to contribute to pleasing appearance. Beautiful satin chrome scales that will retain their new appearance indefinitely. Each knob and dial has brass set screw insert molded in place. Special models available on quantity orders.

Knob Diam.	Shaft Diam.	Knob Only Cat. No.	Spinner Knob Cat. No.	Knob with Phenolic Skirt Cat. No.	Knob with Chrome Dial Cat. No.	Dial Diam.	Scale
2 3/8"	1/4"	116-280	116-286	116-281	116-282	4"	0-100 180°
2 3/8"	3/8"	116-280-3					
1 5/8"	1/4"	116-260	116-266	116-261	116-262	2 3/4"	0-100 180°
1 1/8"	1/4"	116-220		116-221	116-222-1	1 1/2"	100-0 180°
1 1/8"	1/4"				116-222-2	1 1/2"	0-10 270°
1 1/8"	1/4"				116-222-3	1 1/2"	1-7 180°
1 1/8"	1/4"				116-222-4	1 1/2"	On-off 60°
1 1/8"	1/4"				116-222-5	1 1/2"	Indicator

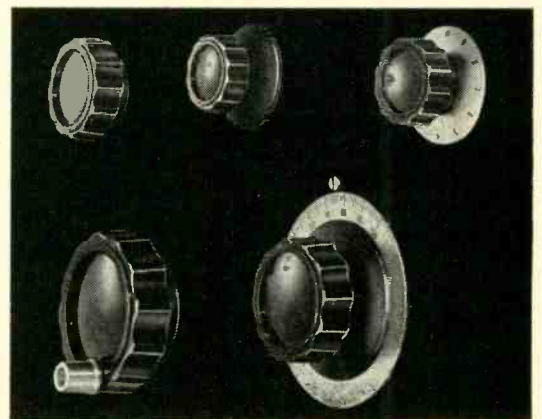

Write for illustrated sheet describing these exceptional JOHNSON Knobs and Dials.



JOHNSON *a famous name in Radio*

E. F. JOHNSON CO., WASECA, MINNESOTA

Highest Quality Tube Sockets

JOHNSON LINE OFFERS YOU MORE
through Better Design,
Finer Workmanship



In selecting a tube socket for any application, it is wise to insist on quality if long, efficient service is your goal.

Those who appreciate precise workmanship, superior design and quality components will readily appreciate why JOHNSON sockets are preferred by so many for such a wide variety of applications. Whether employing porcelain or steatite bases, there is none finer anywhere — at any price.

- 123-206. Industrial Bayonet, Steatite, Silver plated beryllium copper contacts. Base is 4 pin super jumbo. Tension springs in shell.
- 123-209. Medium 4 pin bayonet, white glazed porcelain base, metal shell, heavy phosphor bronze side wiping contacts. 2-13/16" Dia.
- 123-209SB. Same as -209 but with Steatite base and beryllium copper contacts.
- 123-210. Same as -209 except contact to shell spacing not as great. 2 1/2" Dia.
- 123-211. Standard 50 watt type. Similar to -209 but with double filament contacts. 3 3/8" Dia.
- 123-211SB. Same as -211 but with Steatite base and beryllium copper contacts.
- 124-212. Steatite socket for RCA833 or 833A. 5 1/8" plate leads.
- 123-216. Giant 5 pin Bayonet. For tubes such as 803, RK28. 3 3/4" Dia.
- 123-216SB. Same as -216 but with Steatite base and beryllium copper contacts.
- 124-213. For Eimac 152TL and 304TL. Contacts arranged for either series or parallel filaments.
- 124-214. For Eimac 1500TH, with air cooling jet.
- 124-215. For 250 watt tubes such as 204A, 849, etc. The plate terminal has a "safety cup" which prevents accidental dislodgement.

Wafer Types

- Steatite, top and sides glazed. Brass contacts with steel springs cadmium plated.
- 122-217. 7 pin small. 122-225. 5 pin. 122-227. 7 pin medium.
- 122-224. 4 pin. 122-226. 6 pin. 122-228. Octal socket.
- 122-237. Giant 7 pin Steatite wafer. For Xmitting tubes such as HK257 and RCA-813. With 3/4" diam. ventilating hole in base.
- 122-247. 7 pin Steatite for tubes such as 826. Etched aluminum shield.
- 122-244. 4 pin. Steatite. Super jumbo base tubes such as 8008.
- 122-101. 7 pin Steatite wafer with shield, retainer springs and provision for mounting button mica by-pass capacitors. Designed for VHF use with tubes such as 832.
- 122-275 Giant 5 pin Steatite wafer socket for 4-125A, RK48 tubes. Ventilation holes in base.

Miniature Sockets

- 120-267. all ceramic, 7 pin.
- 120-277B. with shield base, 7 pin.
- 133-277S. shield base only.

Shields

- 133-278A. 1 3/8" High, N.P. Brass
- 133-278B. 1 3/4" High, " "
- 133-278C. 2 1/4" High, " "

Acorn Type

- 121-265. Steatite acorn socket. Silver plated beryllium copper contacts.

COUPLINGS AND SHAFTS

JOHNSON insulated shaft couplings provide maximum voltage breakdown and superior strength. Glazed Steatite insulation except -264 which is phenolic.

Cat. No.	Peak Volt.	Dia.	Cat. No.	Peak Volt.	Dia.
104-250	4000	1-5/16"	104-258	1/2"
104-2503	4000	1-5/16"	104-259	8000	1-1/32"
104-251	5000	2 1/8"	104-2593	5000	1-1/32"
104-251A	5000	2 1/8"	104-261	7500	2 1/2"
104-251B	5000	2 1/8"	104-262	5000	2"
104-252	1000	1 1/16"	104-264	400	1-1/32"

Panel Bearings

- With and without 1/4" shaft. Accommodates up to 3/8" panels.
- 115-255. Panel bearing only. 115-256. Bearing and 3" shaft.
- 115-2562. Bearing and 6" shaft.

Flexible Shafts

- Non-rusting phosphor bronze, with 1/4" hubs, for connecting out of line control shafts.
- 115-253. 3" long. 115-254. 6" long.

PILOT, DIAL AND INDICATOR LIGHTS

JOHNSON dial and indicator light assemblies are outstanding examples of sound engineering design, excellent material and careful workmanship. JOHNSON carries a complete line of hundreds of standard pilot light assemblies to meet every ordinary need. In addition, special assemblies can be furnished in production quantities on special order. Your inquiries are invited.

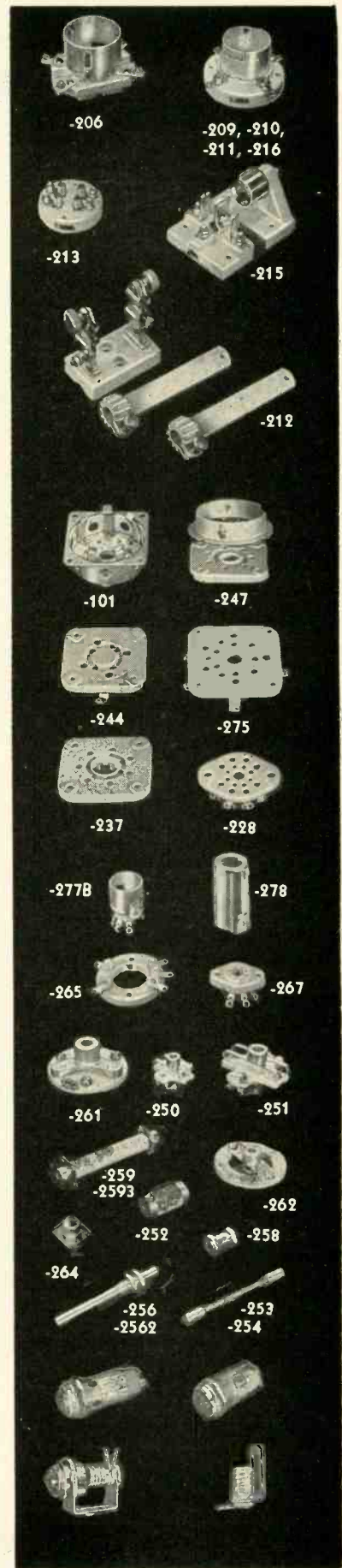

WRITE FOR COMPLETE CATALOG

JOHNSON PLUGS AND JACKS

Below is a partial listing of the complete JOHNSON line of high quality plugs and jacks. Excellent design and workmanship and the use of finest materials are but a few of the reasons JOHNSON Plugs and Jacks are preferred by so many manufacturers. For example, note the unusual and superior features found in the JOHNSON Tip Jacks: Full length heat treated beryllium copper contacts for smooth, positive action with low resistance. Retains high spring tension over long life. Large, easy-wiring terminal provides plenty of room for several wires. Solder cannot run inside. Machined parts of highest quality with close fitting threads and smooth finish.

Manufacturers are invited to write for free samples and complete information.

Banana Spring Type

Accurately turned from brass, with milled nuts and tinned terminals. Nickel plated. Nickel-silver springs (other metals optional). Low contact resistance, high current capacity.

-75 series plugs fit -74 series jacks, -77 series plugs fit -76 jack. -7451 and -7452 have molded phenolic heads.

JACKS

108-74	1/4-28 x 17/32 thread.
108-7451	1/4-28 x 1/2 thread, red.
108-7452	1/4-28 x 1/2 thread, black.
108-76	3/8-28 x 15/16 thread.

PLUGS

108-75	6-32 x 3/8 thread.
108-75A	6-32 x 3/4 thread.
108-75BB	3/8 x 1 3/8 handle, black.
108-75BR	3/8 x 1 3/8 handle, red.
108-75C	6-32 x 5/16 screw.
108-77	10-32 x 5/8 thread.
108-77A	10-32 x 3/4 screw.
108-77BB	5/8 x 1 3/4 handle, black.
108-77BR	5/8 x 1 3/4 handle, red.

TIP JACKS & PLUGS Insulated Tip Jacks

Attractively colored strong Plaskon heads. Nickel plated brass body threaded 1/4-32, and insulating washers for 3/8 hole.

Cat. No.	Color	Cat. No.	Color
105-520	Red	105-526	Orange
105-521	Black	105-527	Yellow
105-522	Dk. Green	105-528	Lt. Green
105-524	Brown	105-529	Dk. Blue
105-525	Lt. Blue	105-530	Ivory

Heavy duty type. Nickel plated brass body molded into phenolic head. 5/16-40 thread, and insulating washers for 3/8 hole. No. 105-418 Red No. 105-419 Black

ALL METAL TIP JACKS

Nickel plated brass, 5/16 hex head, 1/4-32 thread, with insulating washers for 3/8 hole. 105-1 is similar but headless, no nut nor washers, for mounting in 1/4-32 tapped panel hole.

No. 105-417 No. 105-1

SOLDERLESS TIP PLUGS

No. 105-14	13/16 prong, pointed.
No. 105-15	13/16 prong.
No. 105-415	9/16 prong.

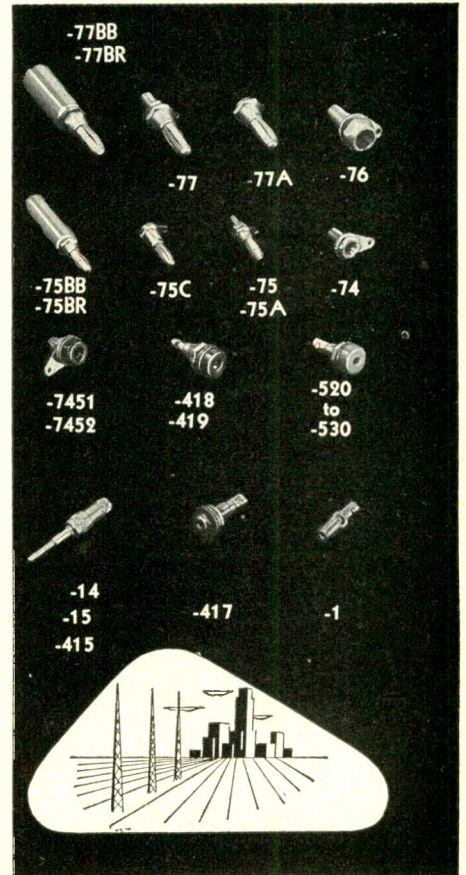

JOHNSON BROADCAST EQUIPMENT

One reason JOHNSON Directional Antenna Equipment enjoys such wide popularity is careful attention to specifications. You may feel confident that your consultant's recommendations will be carried out in detail. Because all units are individually designed there's no need for compromises with good engineering. The cost is no more—frequently it is lower than less flexible, less generously rated equipment.

Illustrated below is a typical JOHNSON Antenna Phasing Unit installed in a JOHNSON cabinet built to match a particular customer's transmitter. This equipment offers many advantages including: optimum circuit design, heavier components, automatic switching from directional to non-directional operation, and others.

Other JOHNSON

Broadcast Equipment

Phase Sampling Loops	Coaxial Line Pressurized Capacitors
Isolation Filters	Variable Inductors
Tower Lighting Filters	Standing Wave Indicators
R F Contactors	

For specific information on equipment listed above and related items, write E. F. JOHNSON COMPANY.

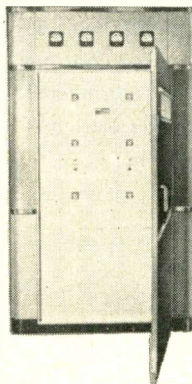

Typical Johnson Antenna Phasing Unit

JOHNSON INDUCTORS

In years of serving the manufacturers of transmitting and RF heating equipment, JOHNSON has evolved an extremely diverse line of inductors. From a comparatively few basic designs and with standardized parts, it is possible to "tailor" an inductor for virtually any RF power application. This technique results in reasonable manufacturing costs and surprisingly good delivery on special as well as standard inductors. Examples of JOHNSON inductors are shown below.

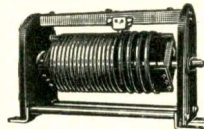

226 Series

A variable inductor featuring rotating coil with variable pitch for high frequency use. The conductor is 1/4" x 1/8" silver plated edgewise wound copper strip. Silver contacts assure low contact resistance. Maximum current is 5 to 10 amperes, maximum inductance 8.0, 13.5 or 22.5 microhenries. Insulation glass bound mica.

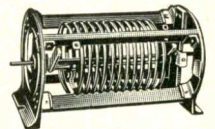

224 Series

Up to 35 amperes with 1/2" copper tubing windings to 50 microhenries. With 3/8" tubing, current may be 25 amperes, inductance to 110 microhenries. Insulation is glass bound mica, end frames cast aluminum, roller contact is silver plated beryllium copper. A special 224 inductor also available with dual windings and two contacts for push-pull balanced circuits.

OTHER INDUCTORS

In addition to these sample types, the JOHNSON line includes many other variable and fixed inductors for low, medium and high power applications. Fixed inductors are available with single or multiple windings, fixed or variable coupling windings and with electrostatic shields if desired.

There is a JOHNSON inductor to fit your needs. In large quantities or small, we will be glad to quote on your requirements.



JOHNSON a famous name in Radio

E. F. JOHNSON CO., WASECA, MINNESOTA

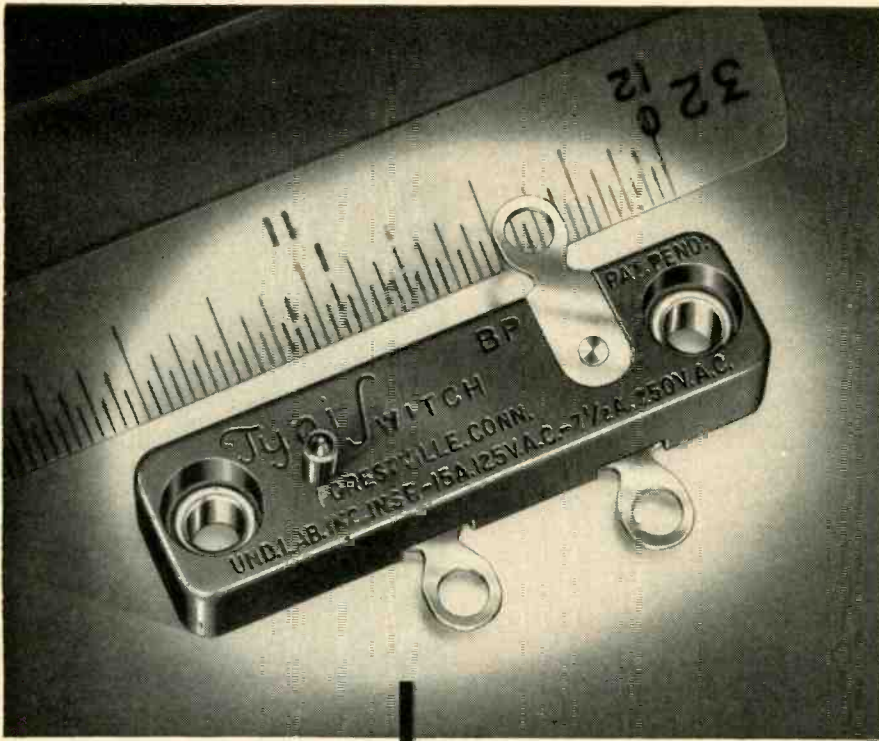

Illustrated: Model BP. Single-pole, double throw, 15A., 125 V., A.C.

The only miniature snap switch

... where size and
high rating
come to terms
with cost

Here's a new ally for the design engineer in his effort to keep quality high and cost low. TYNISWITCH fits in the smallest places, yet handles the load of switches much larger and more expensive. Basic design is readily adapted to new products or special applications.

In its simplified construction, TYNISWITCH introduces many new principles of switch design that add up to efficient switching at low cost.

Thorough laboratory tests have proven its dependability and durability at high operating speeds and over millions of cycles.

Where your equipment design calls for the best switch value for the money, investigate the advantages of TYNISWITCH. Special models can be developed for you economically by TYNISWITCH engineers. Write for technical details and engineering design sheets.



for your

Raytheon Tube Requirements

in the
Metropolitan
New York Area

It's
DALIS

Phone
Algonquin
5-3000

*Serving the trade for
over a quarter century*

**H.L.
DALIS**  **INC.**
*Wholesale Distributors
Electronic Parts*

175 VARICK ST.,
NEW YORK 14, N.Y.

Wire or Write Dept. IND

Want to know about the...

AUGETRON
 ECCLES-JORDAN CIRCUIT
 KATHETRON TUBE
 MEKAPION TUBE
 PERMATRON
 PETOSCOPE
 SCHLIEREN METHOD
 SCOPHONY
 SEMAGRAPH
 SIRUFER
 SYNDEC
 THEREMIN
 TRATONIUM
 VODER

or other early electronic developments?

You can find out about them in the early issues of **ELECTRONICS**.

The cumulative index to **ELECTRONICS'** first decade, pages C-1 to C-36 in this book, tells you where to look.

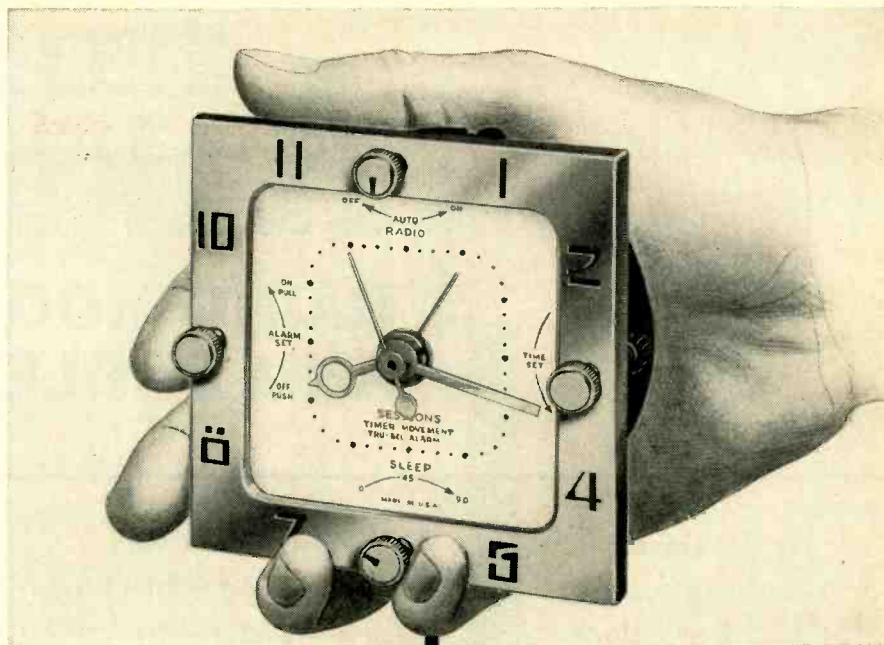

Dependable Clock Switch Timers

with your own custom styling

Radios, TV sets, electrical appliances, many other types of equipment stand to gain powerful sales appeal with a built-in Sessions Clock Switch Timer. Sessions movements give you split-second accuracy, plus the important advantage of distinctive appearance. Choose from a variety of standard models, or Sessions engineers will work with you to develop special styling for your own application.

Outstanding Features

Sessions Switch Timers feature a compact, demountable, self-starting motor which operates at low, subsynchronous speed—assures longer, more accurate life, without annoying buzz of high speed gears. Quiet-acting switch, rated at 10 and 15 amps. (UL approved), turns on silently and posi-

tively. When user forgets, timer automatically turns switch off in 1½ to 2 hrs. For "lullaby" use, Sleep-Sector, on some models, turns switch off automatically after a preset interval of up to 90 minutes. And Sessions "Tru-Bel" ten-minute reminder is a pleasant sounding bell—a great improvement over harsh, rasping buzzers.

Custom Styling

Sessions Switch Timers are available with front or back controls; round or square bezel; etched or screened numerals, luminous or in any color. Dial and hand styling to specifications. All movements factory tested and guaranteed for one year. Write for complete details.

The Sessions Clock Company, Timer Div., Dept 27, Forestville, Conn.

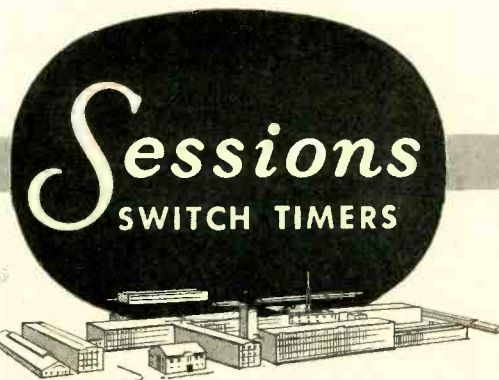

★ ANSONIA ★ Ankoseal®

RADIO HOOKUP WIRES AND CABLES...

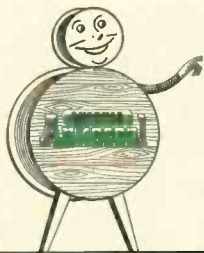

Available in
these Types →
for your D.O. Work

HOOKUP WIRES

Glass Braided or Nylon Jacketed				Plain, Glass Braided or Nylon Jacketed			
WL	3/5	(1)	22	SRIR, SRHV	3/5	(1)	22
WL	3/5	(7)	22	SRIR, SRHV	3/5	(7)	22
WL	1	(1)	20	SRIR, SRHV	1	(1)	20
WL	1	(7)	20	SRIR, SRHV	1	(7)	20
WL	1 1/2	(1)	18	SRIR, SRHV	1 1/2	(1)	18
WL	1 1/2	(7)	18	SRIR, SRHV	1 1/2	(7)	18
WL	2 1/2	(1)	16	SRIR, SRHV	2 1/2	(1)	16
WL	2 1/2	(7)	16	SRIR, SRHV	2 1/2	(7)	16
WL	2 1/2	(19)	16	SRIR, SRHV	2 1/2	(19)	16
WL	4	(1)	14	SRIR, SRHV	4	(1)	14
WL	4	(19)	14	SRIR, SRHV	4	(19)	14
WL	6	(19)	12	SRIR, SRHV	6	(19)	12
WL	9	(37)	10	SRIR, SRHV	9	(37)	10



Available in
these Types →
for commercial uses,
subject to
government restrictions.

CUSTOM DESIGNED CABLES

for

Sonar • Telephone • Radar Control • Airborne

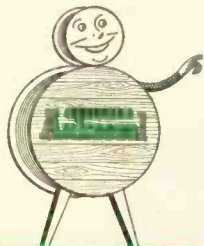

APPLIANCE WIRING MATERIAL

Sizes 24 thru 8 solid or stranded for service at 80°C, 90°C, and 105°C,
both 1/64 and 1/32 wall thicknesses for 300 and 600V service respectively.

CUSTOM DESIGNED CABLES

for

Television Camera Cables
Control Cables

Interconnecting Cables
Carrier Frequency Cables

THE ANSONIA ELECTRICAL COMPANY

SUBSIDIARY OF NOMA ELECTRIC CORPORATION

ANSONIA, CONNECTICUT

Tel. Ansonia 4-3306



BALLANTINE



STILL THE FINEST IN ELECTRONIC VOLTMETERS



MODEL 300



MODEL 302B

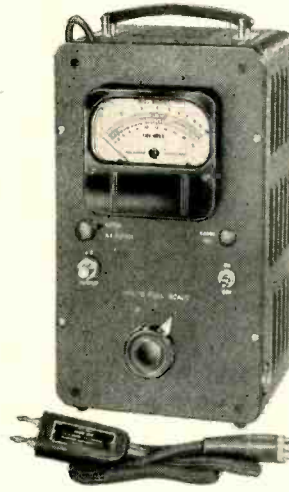

MODEL 304



MODEL 305

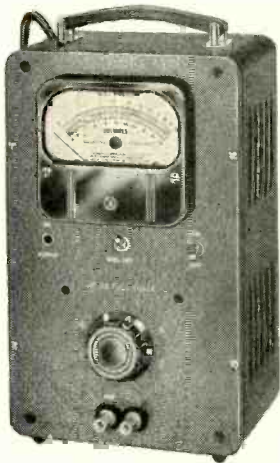

MODEL 310A

MODEL	FREQUENCY RANGE	VOLTAGE RANGE	INPUT IMPEDANCE	ACCURACY
300	10 to 150,000 cycles	1 millivolt to 100 volts	1/2 meg., shunted by 30 mmfds.	2% up to 100 KC 3% above 100 KC
302B Battery Operated	2 to 150,000 cycles	100 microvolts to 100 volts	2 megs. shunted by 8 mmfds. on high ranges and 15 mmfds. on low ranges	3% from 5 to 100,000 cycles; 5% elsewhere
304	30 cycles to 5.5 megacycles	1 millivolt to 100 volts except below 5 KC where max. range is 1 volt	1 meg. shunted by 9 mmfds. on high ranges. 4 mmfds. on highest range	3% except 5% for frequencies under 100 cycles and over 3 megacycles and for voltages over 1 volt
305	Measures peak values of pulses as short as 3 microseconds with a repetition rate as low as 20 per sec. Also measures peak values for sine waves from 10 to 150,000 cps.	1 millivolt to 1000 volts Peak to Peak	Same as Model 302B	3% on sine waves 5% on pulses
310A	10 cycles to 2 megacycles	100 microvolts to 100 volts	Same as Model 302B	3% below 1 MC 5% above 1 MC



MODEL 220A BATTERY OPERATED DECADE AMPLIFIER gives exact voltage gains of 10 or 100, permitting a corresponding increase in voltmeter sensitivity from 10 to 150,000 cycles.



PRECISION SHUNT RESISTORS

Four different types of Precision Shunt Resistors, varying from 1 to 1000 ohms, permit the Voltmeters to be used to measure currents from 1 ampere to one-tenth of a microampere.

MULTIPLIERS

Five different types of Multipliers, whose input resistance varies from 5 to 40 megohms, permit the voltage range of the Voltmeters to be increased 10 or 100 times.

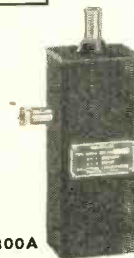

1300A



1300B

BALLANTINE pioneered circuitry and manufacturing integrity assure the maximum in **SENSITIVITY • ACCURACY • STABILITY**

- All models have a single easy-to-read logarithmic voltage scale and a uniform DB scale.
- The logarithmic scale assures the same accuracy at all points on the scale.
- Multipliers, decade amplifiers and shunts shown above extend range and usefulness of voltmeters.
- Each model may also be used as a wide-band amplifier.

For further information, write for catalog

BALLANTINE LABORATORIES, INC.

100 FANNY ROAD, BOONTON, NEW JERSEY

FERRAMIC

cores by GENERAL CERAMICS

Ferramics are soft magnetic materials featuring:

- HIGH PERMEABILITY
- HIGH VOLUME RESISTIVITY
- HIGH EFFICIENCY
- LIGHT WEIGHT
- ELIMINATE LAMINATIONS



TYPE OF FERRAMIC MATERIAL

PROPERTY	UNIT	A 34	B 90	C 159	D 216	E 174	G 254	H 419	I 141	J 472
Initial permeability at 1mc/sec	—	15	95	220	410	750	410	850	600	330
Maximum permeability	—	97	183	710	1030	1710	3300	4300	1010	750
Saturation flux density	Gauss	840	1900	3800	3100	3800	3200	3400	1540	2900
Residual magnetism	Gauss	615	830	2700	1320	1950	1050	1470	660	1600
Coercive force	Oersted	3.7	3.0	2.1	1.0	0.65	0.25	0.18	0.40	.80
Temperature coefficient of Initial permeability	%/°C.	0.65	0.04	0.4	0.3	0.25	1.3	0.66	0.3	0.22
Curie point	°C.	280	260	330	165	160	160	150	70	180
Volume resistivity	Ohm-cm	1x10 ⁹	2x10 ⁵	2x10 ³	3x10 ⁷	4x10 ⁵	1.5x10 ⁸	1x10 ⁴	2x10 ⁵	—
Loss Factor:										
at 1 mc/sec	—	—	.00016	.00007	.00005	.00008	.00008	.00030	.0003	.000055
at 5 mc/sec	—	.0004	.0011	.0008	.0012	.002	.00075	.00155	.005	—
at 10 mc/sec	—	.0005	—	—	—	—	.0017	.00275	—	—

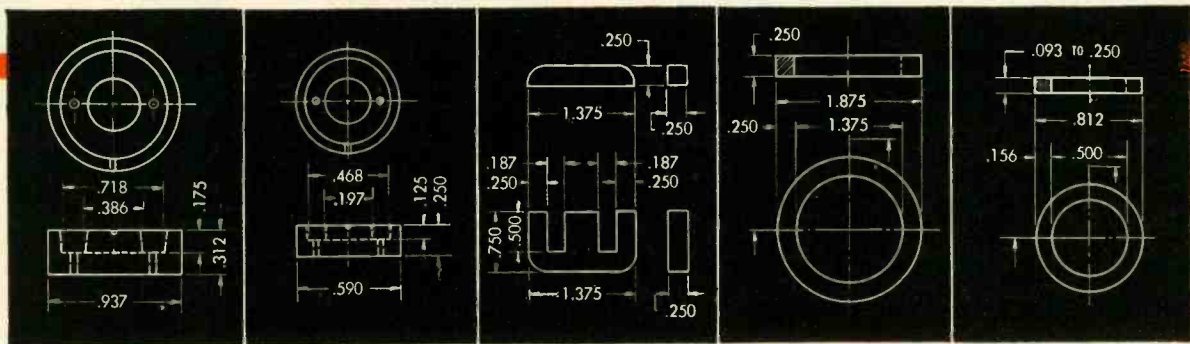

General CERAMICS AND STEATITE CORP.
GENERAL OFFICES and PLANT: KEASBEY, NEW JERSEY

MAKERS OF STEATITE, TITANATES, ZIRCON PORCELAIN, FERRAMICS, LIGHT DUTY REFRACTORIES, CHEMICAL STONWARE, IMPERVIOUS GRAPHITE

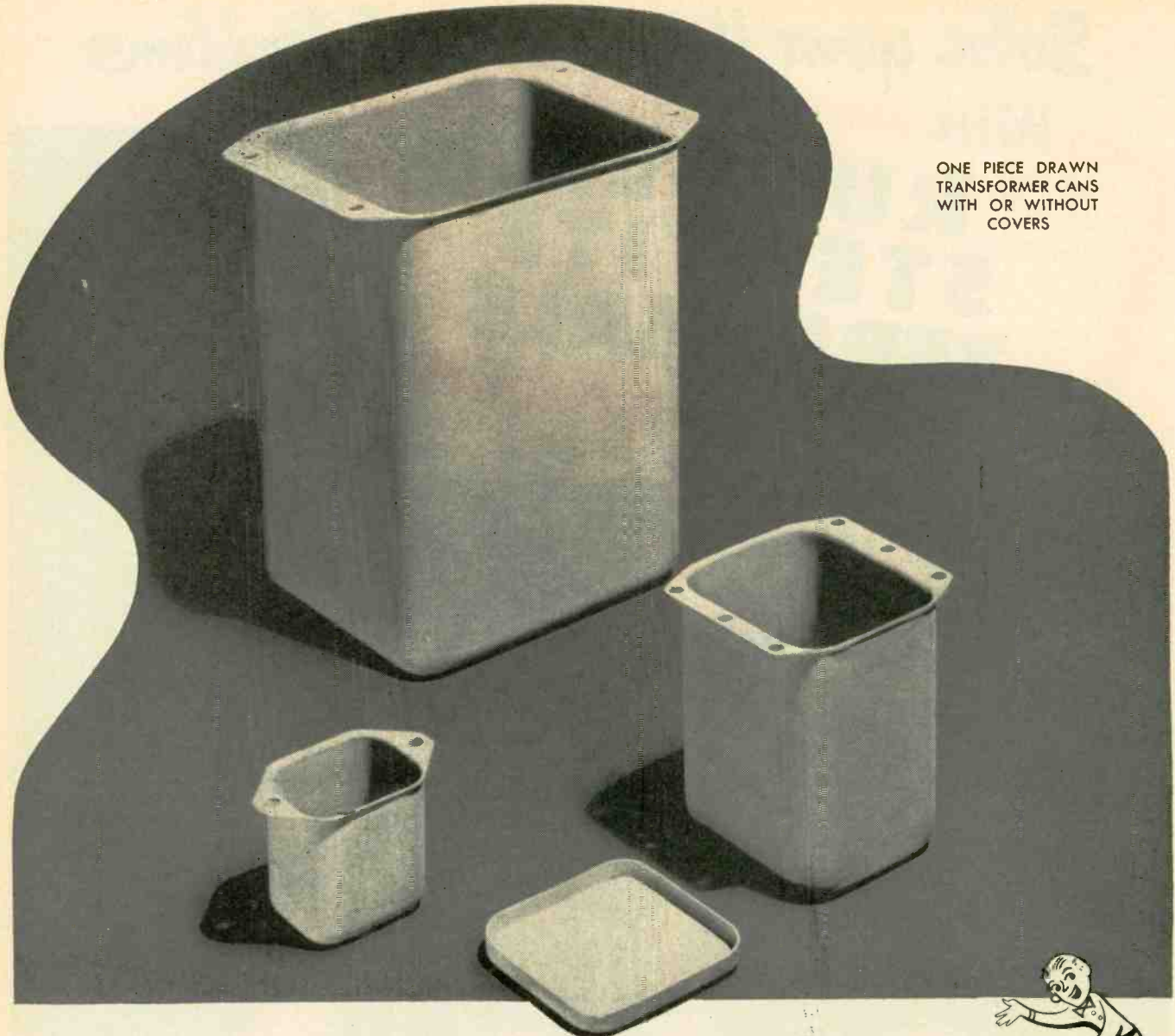

ONE PIECE DRAWN
TRANSFORMER CANS
WITH OR WITHOUT
COVERS

IN STOCK: TRANSFORMER CANS IN STANDARD SIZES

Save die costs on stock size transformer cans. IMMEDIATE DELIVERY on full range of sizes, with or without covers. *All drawn in one piece!* Write for list of sizes and prints.

SPECIAL SHAPES AND SIZES

We are fully equipped to fabricate special sizes (round, square, and rectangular) to your specifications. Tell us your requirements and let us submit estimates.



Here's Help for your DO Contracts.
Craft offers you these seven
metal fabricating services.

- STAMPING
- SPINNING
- ANNEALING
- DEEP DRAWING
- SHEET METAL WORK
- PICKLING
- WELDING

WRITE OR PHONE FOR FULL INFORMATION OR SEND
BLUEPRINTS FOR PROMPT QUOTATION.

Craft MANUFACTURING CO.

3949 W. SCHUBERT AVE., CHICAGO 47

Craft

Stainless Steel Specialists

**EICO KITS
and INSTRUMENTS**



320K SIG. GEN. KIT \$19.95
Wired \$29.95



New 950K COND.-RES. COMP. BRIDGE KIT \$19.95
Wired \$29.95



New 1040K BATTERY ELIM. KIT \$25.95
Wired \$34.95



511K VOM KIT \$14.95
Wired \$17.95



145K SIG. TRACER KIT \$19.95
Wired \$28.95



HV PROBE
(Wired only) \$6.95

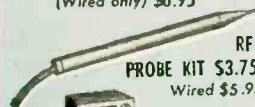

RF PROBE KIT \$3.75
Wired \$5.95



C-5 SMC CRYSTAL
\$3.95



New 315K DELUXE SIG. GEN. KIT \$39.95
Wired \$59.95

EICO
TEST EQUIPMENT

guards **Emerson**
HIGH STANDARDS OF
PRODUCTION QUALITY



Harry R. Ashley, President of EICO, inspecting the use of the EICO Model 425 Oscilloscope and Model 221 Vacuum Tube Voltmeter at one of the important alignment positions on the Emerson television production line, New York plant.

For Laboratory Precision at Lowest Cost—the Leaders Look to EICO!

FOR electronics test equipment, there's no tougher proving ground than the factories where TV sets are made. There's where the pace is fastest, precision requirements the highest, costs the tightest—and day-after-day dependability an absolute *must*.

In both the giant New York and New Jersey television plants of the Emerson Radio & Phonograph Corporation — at the many critical constant-duty testing positions along the production line—EICO instruments stand guard. For Emerson has found that for speed, accuracy and trustworthiness, at lowest cost, EICO instruments always deliver the fullest measure of value.

From coast to coast, in one leading TV factory after another, this is the experience—*this is the proof of EICO superiority*—that is repeated again and again. The top-flight TV set makers have discovered—and over 50,000 servicemen have learned—that for the industry's greatest instrument values, at the industry's lowest costs—it's EICO!

Be sure you look at the EICO line before you buy any higher-priced equipment! Each EICO product is jam-packed with unbelievable value. YOU be the judge—compare EICO at your local jobber today—and SAVE! Write NOW for free newest Catalog EBG.



New 221K VTVM KIT \$25.95
Wired \$49.95



New 425K 5" SCOPE KIT \$44.95
Wired \$79.95



New 625K TUBE TESTER KIT \$34.95
Wired \$49.95



360K SWEEP GEN. KIT \$34.95
Wired \$49.95

EICO

ELECTRONIC INSTRUMENT CO., Inc.
276 NEWPORT STREET, BROOKLYN 12, NEW YORK

© 1950, Electronic Instrument Co., Inc.

LOW LEVEL D.C. INSTRUMENTS

MODEL 200-A D.C. MILLIVOLTMETER

- 5 microvolts to 10 volts
- 2 megohms input resistance
- No zero control

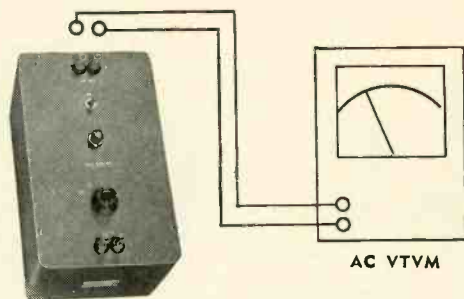

D.C. INPUT

A precision converter that makes the AC vacuum tube voltmeter direct reading in DC microvolts

MODEL 203-A BRIDGE BALANCE INDICATOR

PRECISE WHEATSTONE BRIDGE

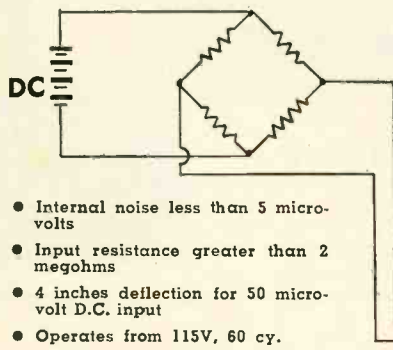

- Internal noise less than 5 microvolts
- Input resistance greater than 2 megohms
- 4 inches deflection for 50 microvolt D.C. input
- Operates from 115V, 60 cy.

A null detector for high resistance DC bridges with sensitivity of 5 microvolts

MODEL 205-B SERVO MODULATOR

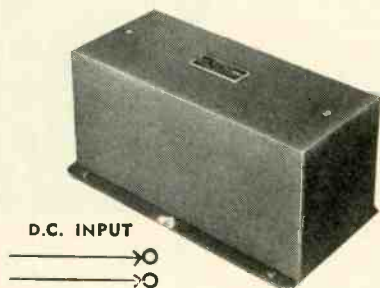

D.C. INPUT

A.C. AMP.

MOTOR

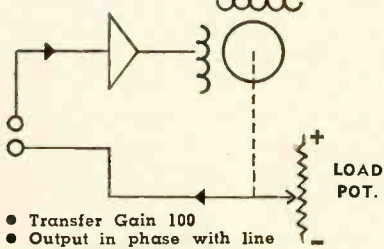

- Transfer Gain 100
- Output in phase with line
- Input impedance 10 megohms

A low level 60 cps modulator with zero offset below 100 microvolts

THIS IS THE

ONE BOOK

THE ONLY ONE OF ITS KIND

In which design engineers and purchasing agents will find a complete, accurate, and up-to-date list of the manufacturers of all types of electronic and allied products... components and complete equipment.

Keep it handy for ready reference throughout the year.

When buying, or requesting product information be sure to mention...

electronics BUYERS' GUIDE

ICCO INDUSTRIAL CONTROL COMPANY
 Wyandanch Dept. EB Long Island, New York

DRIVER-HARRIS

Your
dependable
source for



Wire and Ribbon

Resistor and Radio Alloys

FOR RESISTANCE

There are Driver-Harris Alloys for every electrical resistance requirement. Most widely used are:

- ... Nichrome* and Nichrome* V, for winding large value resistors where overall size is limited, but dependability is a must.
- ... Manganin, for fixed stability and constant resistance under normally variable operating conditions; examples being precision bobbins, potentiometers, National Bureau of Standards type resistance standards.
- ... Advance*, most frequently specified for precision resistors in electric meters and laboratory testing devices, because in its finer sizes it has a temperature coefficient of only $\pm .00002/^{\circ}\text{C}$.
- ... Karma*, high ohmage, 800 ohms/cmft at 20°C ., makes possible extremely small resistors. Especially suitable for service in resistors requiring negligible temperature coefficient of resistance. Thermal e.m.f. against copper only .002 millivolts $/^{\circ}\text{C}$. between 0°C . and 100°C . Where mechanical strength is important, larger diameter Karma wire can be used for a given resistance per foot.
- ... Plus a total of more than 80 electrical heat and corrosion-resistant alloys which singly, or in combination fill any electrical resistance specifications.

FOR RADIO

Always abreast of the latest developments in radio metallurgy, Driver-Harris has been headquarters for Radio Alloys since the earliest days of the industry. In greatest demand are:

- ... Nickel and Nichrome*, for plate strip. Thin but rigid, they take a tightly adhering heat radiation coat.
 - ... Gridnic* Alloys, having a very low electron emission — especially suitable in tubes where back-emission is involved.
 - ... Cathode Sleeve Material: special melted Nickel Alloys to meet any emission requirements.
- Other widely accepted D-H Alloys, meeting or exceeding most radio specifications are: Nilvar*, #42 Alloy, #52 Alloy, and Nickel "A", "D", "E", "Z".



For efficiency and dependability —
Specify Electrical Resistance and Radio Alloys by —

Driver-Harris COMPANY

HARRISON • NEW JERSEY

BRANCHES: Chicago • Detroit • Cleveland • Los Angeles • San Francisco • Seattle
The B. GREENING WIRE COMPANY, LTD., Hamilton, Ontario, Canada

*Trade Mark Reg. U. S. Pat. Off.

BOWSER

Environmental Test Equipment

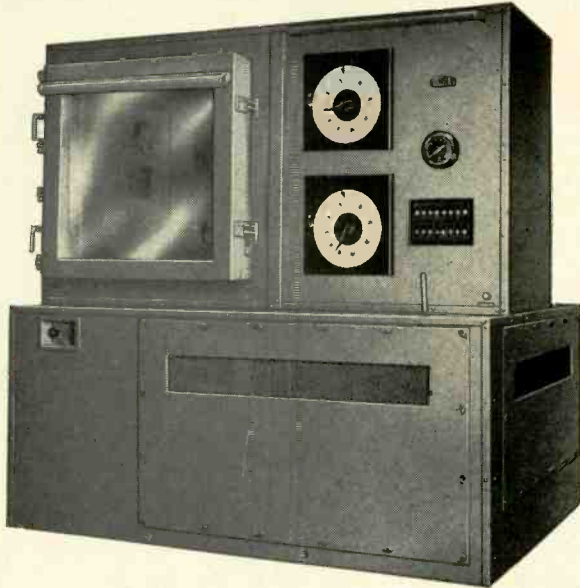

L-SERIES

Laboratory Unit for complete environmental testing of aircraft instruments and equipment at a temperature range from $+180^{\circ}\text{F}$. to -100°F ., relative humidity simulation from 20% to 95%, and altitude from ambient atmospheric pressure to 80,000 feet.

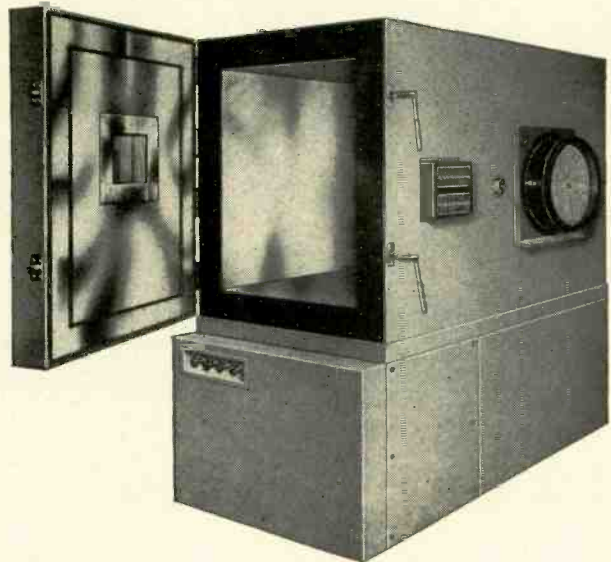

S-SERIES

These units will automatically maintain temperature conditions within a range from -80°F . to $+180^{\circ}\text{F}$.. In addition, units which incorporate humidity conditions will provide humidity from 20% to 95% between $+35^{\circ}\text{F}$. and $+180^{\circ}\text{F}$.. Dry and wet bulb temperature ranges can be extended to meet other requirements.

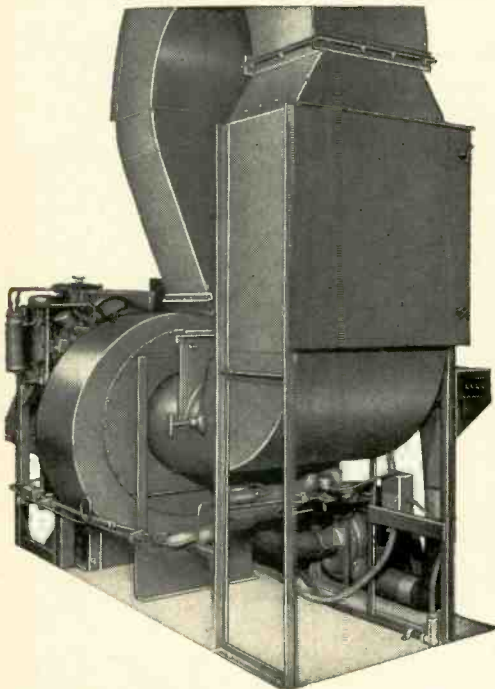

EXPLOSION

Explosion chamber to meet all MIL, JAN, USAF, AN and other specifications for testing of instruments and equipment in explosive atmosphere at altitudes up to 80,000 feet. Safety devices and automatic fuel metering enable this equipment to be installed and operated indoors.

Special Engineering

Bowser Technical Refrigeration maintains a complete engineering staff to solve special test problems for the aircraft industry. All test chambers can be furnished with power drives into the test chamber. Also available as accessories are test racks to special design, optical viewing arrangements, pressurized and explosion proof connectors, special high voltage in- and outlets, radio shielding and connections for testing hydraulic equipment. To meet individual requirements, other special instrumentation, accessories and sizes are available.

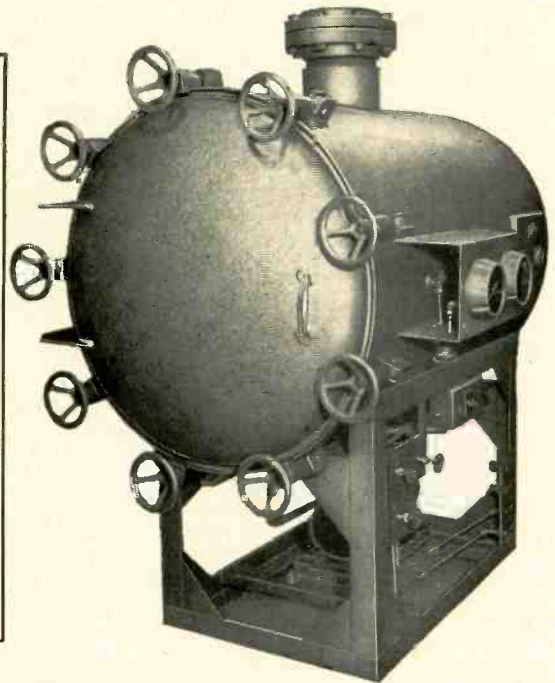

SAND & DUST

Sand and dust chamber to meet all MIL, JAN, USAF, AN and other test specifications for aircraft components. Provides testing facilities in air-suspended sand and dust at air velocities at 100 and 2300 feet per minute. Accurate temperature control of the air is provided by automatic heating and refrigeration equipment.

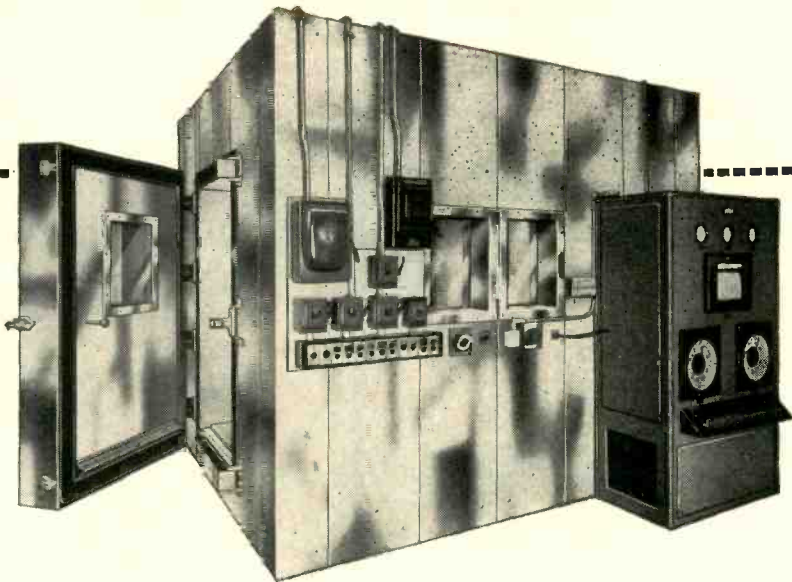

WALK-IN ROOMS.....

Bowser Walk-In Rooms have a temperature range from $+180^{\circ}\text{F}$. to -100°F . and relative humidity simulation from 20% to 95%. Because of sectionalized panel construction any size or shape room can be manufactured for final assembly in the field. Smaller sizes are preassembled at the factory. Extended ranges of temperature, humidity and provision for altitude simulation can be provided. Special accessories and instrumentation also available.

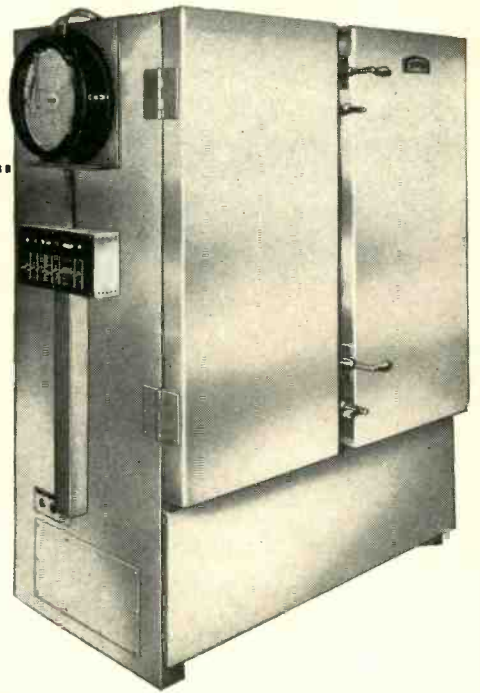

H-SERIES.....

Relative Humidity Simulation Unit which will automatically maintain humidity conditions from 20% to 95% at temperatures from $+35^{\circ}\text{F}$. to $+170^{\circ}\text{F}$. (Dry Bulb)

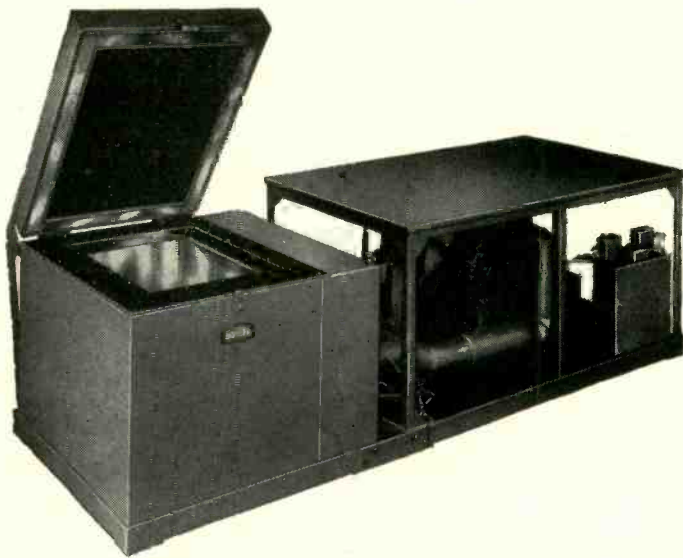

T-SERIES.....

These new Units are ideal for all types of processing requiring rapid extraction of heat. The wide range of temperatures down to -150°F . also allows complete testing of products under conditions of extreme cold. In addition, storage of products is singularly effective because of the close control tolerance and dependability featured in all Bowser units. Other applications for which these units are well suited are stabilization of metals, aging of metals, expansion fitting, conditioning for tensile tests etc.

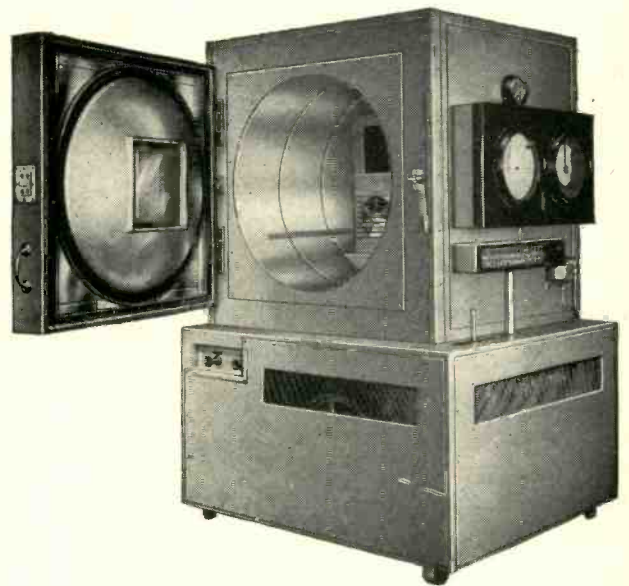

U-SERIES.....

These units are designed specifically for production processing of aircraft instruments, accessories and equipment. Temperature ranges from $+158^{\circ}\text{F}$. to -80°F . Relative humidity simulation from 20% to 95% and altitude simulation to 55,000 feet are provided.

Write for more information NOW

BOWSER
 TECHNICAL REFRIGERATION
 DIVISION BOWSER INC.
 TERRYVILLE • CONN.



FIXED AND

**from one
reliable source**

With the widest line of resistor types in the industry, IRC can supply *all* your requirements from one reliable source. And because we manufacture all types, our recommendations are unbiased. For more than 25 years, IRC has concentrated exclusively on the design and manufacture of resistors. You benefit by this accumulated experience when you specify IRC.

IRC distributors maintain complete stocks of all standard resistors. A telephone call to your nearest IRC distributor will give you fast, local service on your experimental and maintenance orders.

Complete characteristics and specifications of the resistors shown here are detailed in Catalog Data Bulletin BG-1 through BG-18. Write for the Bulletins in which you are interested.

INTERNATIONAL RESISTANCE COMPANY

401 N. Broad Street, Phila., Pa.

IN CANADA: International Resistance Co., Ltd.,
Toronto, Licensee



advanced type BT resistors

Meet JAN-R-11 specifications at 1/8, 1/2, and 1 and 2 watts. Small Insulated Composition Resistors, up to 22 megohms in RMA Ranges. Catalog BG-1.



type BW wire wound resistors

Exceptionally stable and inexpensive for low range requirements. Fully insulated 1/2, 1 and 2 watts in RMA Ranges up to 8200 ohms. Catalog BG-2.

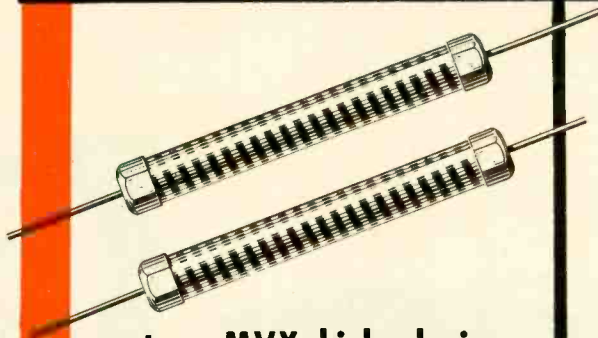

type MVX high ohmic high voltage resistors

Meet requirements for a small high range unit with axial leads. Can be mounted through a hole in a mounting block of insulating material without terminal interference. Power rating is 2 watts. Catalog BG-18.

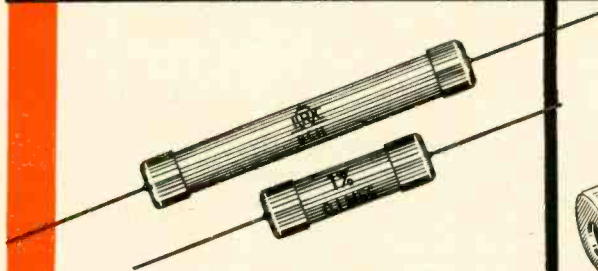

deposited carbon PRECISTORS

Combine accuracy and economy in close tolerance applications. Tiny, light-weight units in wide range of values, and 3 tolerances—1%, 2% and 5%. Catalog BG-14.

new type Q controls

Compact 1 1/16" design. 1/4 watt rating. Available with or without tap and switch. Lustrous nickel-plated finish meets federal salt-spray requirements. Catalog BG-3.

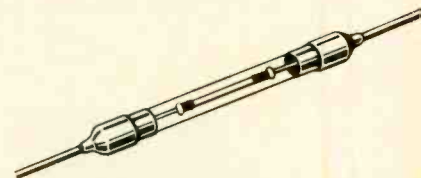
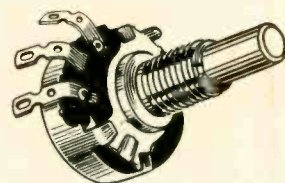

new type UHR resistor

(Ultra High Resistance)

Hermetically sealed in inert gas in a glass tube to protect it from mechanical damage and exposure. Small size suits it to use in atomic research instrumentation and other applications requiring very high resistance value.

(Resistance available: 10⁸ to 10¹² ohms inclusive)

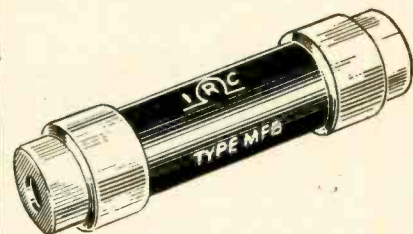

type MF voltmeter multipliers

Interconnected and encased in sealed ceramic tubes. Completely impervious to humidity. 0.5 meg. to 6 meg. Catalog BG-15.

VARIABLE RESISTORS

wire wound potentiometers

Two watt control. 1 1/4" diameter. Wide variety of rheostat and potentiometer applications. Catalog BG-4.

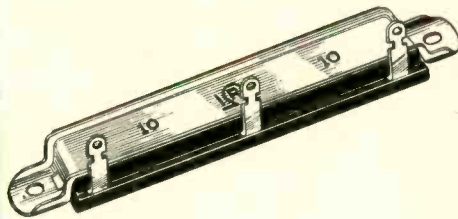
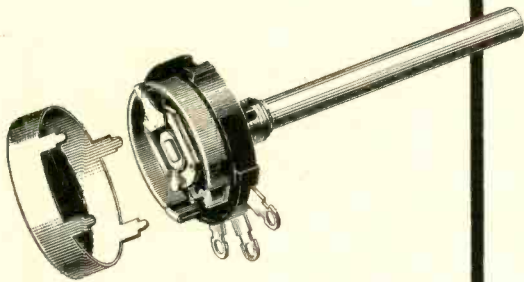

type MW wire wound resistors

Flat wire wound resistors, completely insulated and protected. Unique design permits savings in cost and space. Catalog BG-5.

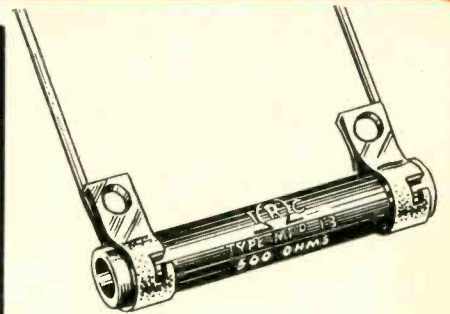

type MP high frequency resistors

For frequencies above those of conventional resistors. 2 watts to 90 watts. (MPM's are tiny, 1/4-watt units ideal for miniaturization.) Catalog BG-6.

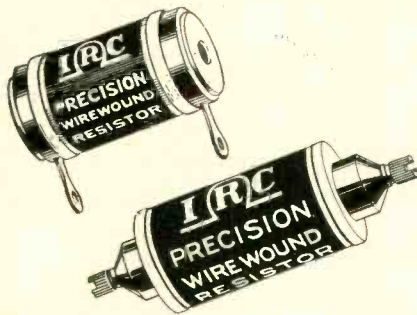

precision wire wound resistors

Maximum accuracy and dependability in instrument applications. 1% tolerance standard. Variety of terminal types. Catalog BG-10.

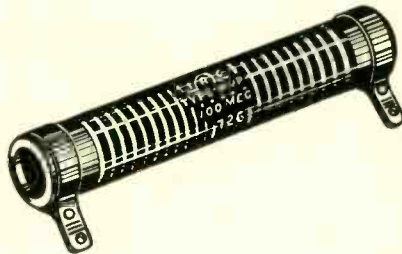

type MV high voltage resistors

For use where high resistance and power are required. 2 watts to 90 watts. Variety of terminal types. Catalog BG-11.

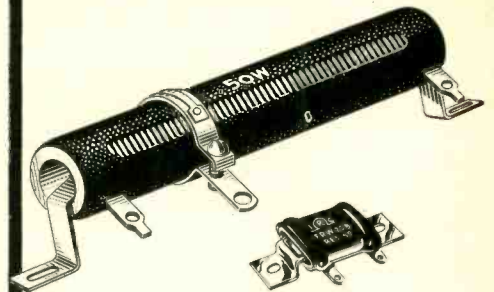

power wire wound resistors

(Tubular or Flat)

Full range of sizes, types, terminals. Special cement coating resists humidity and aids heat dissipation. Catalogs BG-12 and BG-13.

type MVM-5 and MVM-6 high voltage probe resistors

Specially developed for use as resistance element in many makes of high voltage probes used with VTVM (vacuum tube voltmeters) to increase voltage reading up to 30KV. Very low voltage coefficient characteristics over a wide range give readings over the entire scale. Resistance available: 100 to 1500 megohms.

Tolerance: $\pm 2\%$ at 15KV.

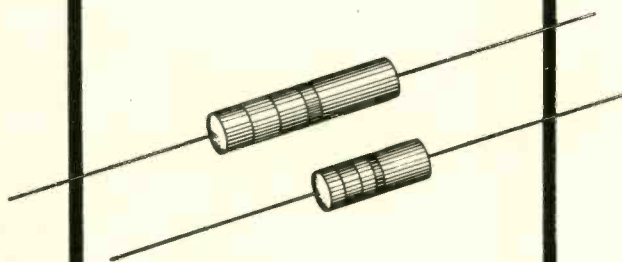
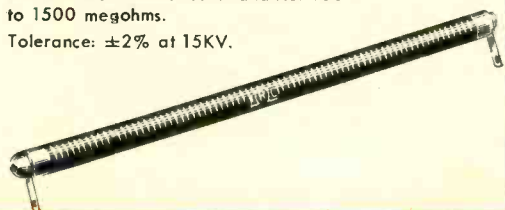

insulated chokes

Ideal for television and similar circuits. Wide range of size and characteristic combinations permit accurate specification to individual requirements. Inexpensive and versatile. Catalog BG-17.



Wherever the Circuit Says - I R C

**INTERNATIONAL
RESISTANCE
COMPANY**

Need **VOLUME**
on Small Parts
Like
These?



Investigate
MULTI-SWAGE

Economy Way to Get Volume!

If it's **VOLUME** you need on small tubular metal parts similar to these, be sure to look into Bead Chain's **MULTI-SWAGE** Process. Send the part (up to $\frac{1}{4}$ " dia. and to $1\frac{1}{2}$ " length) and your specs for a quotation. Chances are you'll find a new way to effect important savings.

Much Cheaper Than Solid Pins

Many prominent users of solid pins for electronic and mechanical purposes have cut costs by switching to Multi-Swaged *tubular* pins . . . without sacrificing strength or accuracy. Often this is possible to accomplish.

Typical Applications —

As terminals, contacts, bearing pins, stop pins, male-female connections, etc., in a wide variety of electronic and mechanical products:—Toys . . . Business Machines . . . Ventilator louvers . . . Radio and Television apparatus . . . Terminal-boards . . . Electric Shavers . . . Phono Pick-ups, etc. For **DATA BULLETIN**, write to



The **BEAD CHAIN** Mfg. Co.
27 Mountain Grove St., Bridgeport 5, Conn.

Manufacturers of **BEAD CHAIN**—the kinkless chain of a thousand uses, for fishing tackle, novelty, plumbing, electrical, jewelry and industrial products.

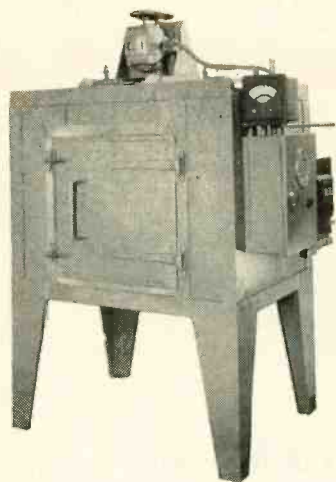

OVENS

Forced Air Circulation
Cabinet Types, as illustrated, for glass annealing, coil baking, curing.

* * * * *

Also conveyor ovens for high production of electronic tubes and components of all types.

* * * * *

STEINER-IVES COMPANY

16 AVENUE L

NEWARK 5, NEW JERSEY

DESIGNERS AND BUILDERS OF INDUSTRIAL OVENS

Since 1889

VERSATILE • DEPENDABLE • RESOURCEFUL
AMERICAN ELECTRONEERING CORPORATION

Manufacturers of communications and radio-telephone equipment—regulated power supply units—aircraft maintenance test equipment.

Sub-assemblies also produced for specific purposes, needs—to meet rigid specifications and inspection.

Rehabilitation of electronic equipment including overhaul and modification work. Test & Development Facilities—Technical Coordination.

WRITE TODAY FOR DETAILS

AMERICAN ELECTRONEERING CORPORATION

5025-29 West Jefferson Blvd.

Los Angeles 16, California



WIRE FORMING SPECIALISTS

Precision Parts to meet your Production and Engineering needs. From .002" dia. to .125" dia. Radio tube parts—Stampings—Drawings Modern facilities, high-production equipment.

Metal Crystal Holder Parts

Send sketch or print for quotation.

PIX MANUFACTURING CO., Inc.
24 Bedford St., Newark 3, N. J.

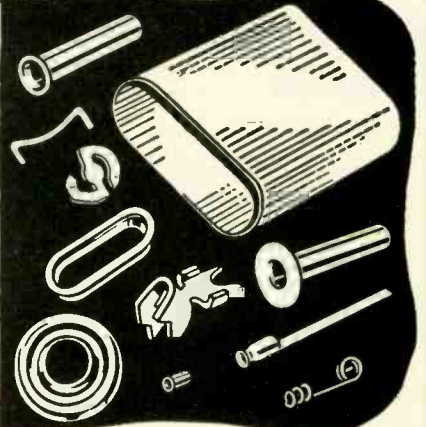

Dedicated
to Quality Output and
Golden Rule Service

ASTRON

STARTLINGLY SMALL

AMAZINGLY LIGHT WEIGHT

ABSOLUTELY RELIABLE

“METALITE”

METALLIZED PAPER CAPACITORS

DRY ELECTROLYTICS

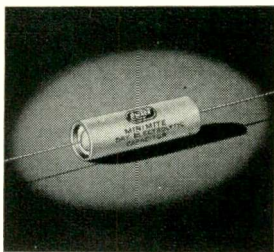

“MINIMITE”

Type MM Metal Tubular

For under-chassis and other “limited space” mounting. Multiple paper spacers assure adequate voltage breakdown; riveted cathode tab; hermetically sealed; low leakage, withstand high surge voltage.



Type EY Twist Prong

Hermetically sealed in seamless aluminum cans, single and multiple, for operation at ambient temp. up to 85°C. Terminal coding clearly stamped. Electrically welded terminal tabs.

MOLDED PAPER TUBULARS

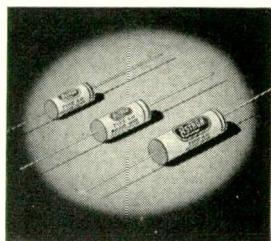

Rugged—high temp.—humidity proof—heat resistant. Perfectly sealed to meet extreme field conditions, will not cold-flow at 100°C. For TV, radio and other electronic applications.

OIL-FILLED BATHTUB

Type ADM Capacitor, non-inductively wound, mineral oil impregnated and filled. Hermetically sealed in metal cans, solder lugs side, top, bottom or ends.

Also type ADH, wax-impregnated and filled.

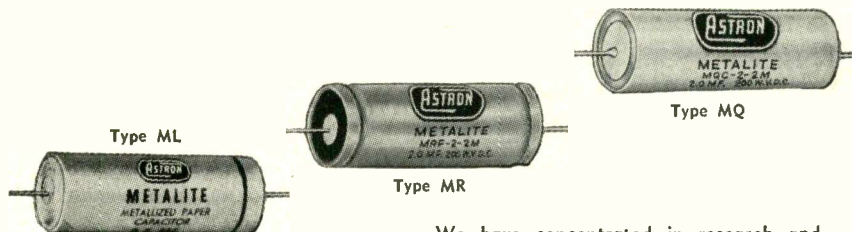

We have concentrated in research and development here, until the very term “METALLIZED” is almost synonymous with the name **ASTRON**. Whether in Cardboard Tubulars . . . in Metal Encased Tubulars, or in special designs engineered to your particular requirements . . . “METALITE” represents supreme **ECONOMY** and **EFFICIENCY** in miniature capacitors.

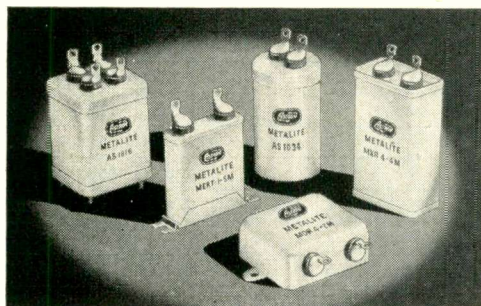

Type MD, MX and other standard and special “METALITES” available in wide range of ratings, multiple as well as single. Special case styles if you wish.

INTERFERENCE FILTERS

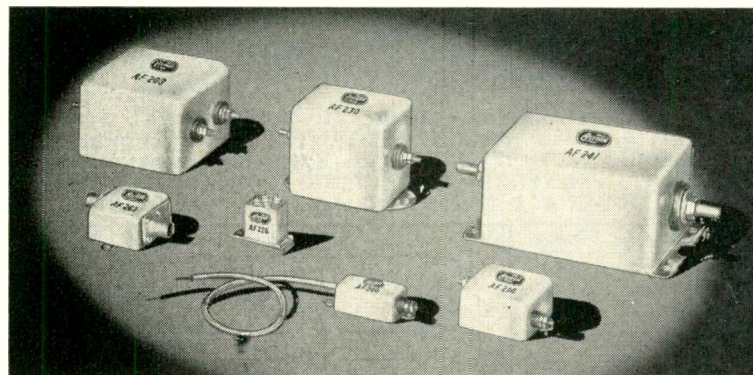

Applying the sensationally economical, space-saving “METALITE” capacitors with a success that has made these Filters **MUST** with leading mfrs. of aircraft, aircraft-electronic and electrical equipment, and all types of electrical systems and apparatus where noise suppression is a vexing problem. We are equipped to design just the Filter for **YOU**.

WRITE FOR CATALOGUE AC-2

ASTRON

CORPORATION - 255 Grant Avenue, East Newark, N.J.



CERAMIC FORMS: Non-hygroscopic material, high dielectric, low coefficient of expansion. No. 6 screw hole through center.

WIRE: Highest grade alloys; Cu-Ni, Ni-Cr, Cu-Mn-Ni, Ni-Cr-Al-Cu, Ni-Cr-Fe, enamel or fabric covered. Minimum size .0015 standard, .0007 special.

TEMPERATURE COEFFICIENT: $\pm .002\%/^{\circ}\text{C}$ for ohmage up to approx. 2500; $.017\%/^{\circ}\text{C}$ above 2500. $.002\%/^{\circ}\text{C}$ may be ordered special on any type resistor.

TOLERANCE: $\pm 1\%$, $\pm 5\%$, $\pm 25\%$ standard. $\pm .1$, $\pm .05$ special.

MOISTURE PROTECTION: Standard units thoroughly impregnated with moisture and salt water proofing compounds and fungus resistant acetate label. Vacuum impregnating and other special sealing on request.

INSULATION: Each cross-over wire insulated from winding by acetate cloth. All units receive 500V. breakdown test.

INDUCTANCE: Reversed, balanced winding in each pie section minimizes inductance up to approx 50KC. Special frequency characteristics upon request.

Type		Wattage Rating		Resistance Range			Dimensions (Inches)		Jan Voltage Ratings		
Jan.	Mepco	Jan.	Com-mercial	Low (OHM)	High (MEG)	Special* (MEG)	Length	O. D.	1%	.5%	.25%
RB 10	RB 10	1/4	1/2	.1	.2	.5	15/32	1/2	215	186	152
RB 11	WM 3	1/3	1	.1	.2	.4	9/16	9/16	316	274	224
RB 12	WM 4	1/2	1	.1	.6	1.5	1	9/16	387	335	274
RB 13	WM 5	1/2	1	.1	.9	3	1 1/4	3/4	612	520	433
RB 14	WM 2	1	2	1	3	5	2	7/8	2000	1732	1414
RB 21	WM 1	1	1	1.0	.5	1	2 1/8	9/16	895	775	632
RB 40	WM 12	.4	1	.1	.15	.3	1	3/4	245	212	173
RB 41	WM 13	1/2	1	.1	.3	.6	1 1/4	3/4	387	335	274
RB 42	WM 14	.6	1	.1	.5	1.5	1 3/8	3/4	520	450	367
RB 51	RB 51	1/4	1/2	.1	.1	.3	3/8	3/8	158	137	112

* Higher maximum resistance at reduced power rating using smaller wire sizes.

MEPCO METER MULTIPLIER

JAN R - 29
TYPES MFA & MFB



HERMETICALLY SEALED: Metal to Steatite. **HIGH STABILITY:** Finest grade Alloy wire—Properly aged. **SHOCK RESISTANT:** Suspended elements—Internal cushioning. **REPLACEABLE SECTIONS:** Eliminates complete loss of unit if damaged. **TEMPERATURE COEFFICIENT:** $\pm .017\%/^{\circ}\text{C}$ standard, $\pm .002\%/^{\circ}\text{C}$ special. **TERMINALS:** Nickel plated brass. Fits standard fuse clips.

Type	Megohms†	Kilovolts
MFB 105*	1.0	1.0
MFB 155	1.5	1.5
MFB 205	2.0	2.0
MFB 255	2.5	2.5
MFB 305	3.0	3.0
MFB 355	3.5	3.5
MFA 355*	3.5	3.5
MFA 405	4.0	4.0
MFA 455	4.5	4.5
MFA 505	5.0	5.0
MFA 605	6.0	6.0

* U.S.N. replacement † $\pm 5\%$

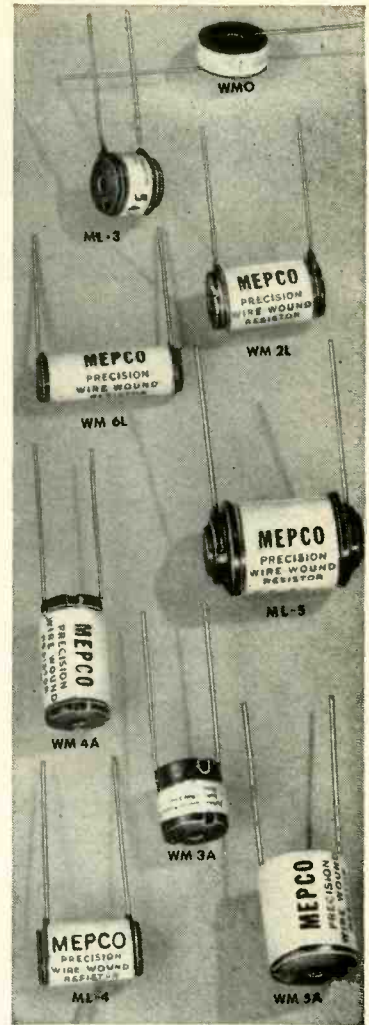

COMMERCIAL LEAD TERMINAL TYPES

MOLDED* lead terminal PRECISION RESISTORS: Positive Connection between Winding and Terminal. Eliminates all soldered joints in resistor. No flux used—all connections non-corrosive. Cannot "OPEN" due to flexing of lead terminals. Same construction as our JAN R-93 Lug terminal types.

* Terminal and end of winding are imbedded together by the metal molding process, assuring a positive electrical and mechanical connection.

Other lead terminal types are of the same basic construction as Lug Types. Terminals are No. 21 AWG copper wire, tinned, 1 1/2" long. Wire fastened on resistor so it cannot turn or come loose. Wire from winding attached to lead at side opposite terminal to prevent breaking when terminal is flexed.

Type WM-0 resistor usually supplied with an inductive winding. Special non-inductive construction on request.

Type	Wattage Rating	Resistance Range		Dimensions (Inches)	
		Low	High*	Length	O. D.
WM 1/4	1/20	50 ohms	.03 meg	9/32	1/4†
WM 1/2	1/10	5 ohms	.05 meg	7/16	1/4†
WM 0	1/4	1 ohm	.2 meg	1/4	5/8
WM 2L	1/2	.1 ohm	.1 meg	3/4	3/8
* ML-3	1	.1 ohm	.2 meg	9/16	9/16
* ML-4	1	.1 ohm	.6 meg	1	9/16
* ML-5	1	.1 ohm	.9 meg	1 1/4	3/4
* ML-2	2	1 ohm	3 meg	2	7/8
WM 6L	1	.1 ohm	.2 meg	1 3/16	3/8
WM 3A	1	.1 ohm	.5 meg	1/2	1/2
WM 4A	1	1 ohm	.8 meg	1	1/2
WM 5A	1	1 ohm	1 meg	3/4	5/8

† Not illustrated.

* Higher maximum resistance, at reduced power rating, may be had by using smaller wire sizes. Date on request.

MEPCO, INC. 37 Abbett Avenue
Morristown, N. J.
Telephone: Morristown 4-5777

for compactness... low
temperature coefficient
... low inherent
inductance... and high
R. F. conductivity

use
UNITED
Vacuum Capacitors

Type	Capacitance uuf	Maximum Current	Peak R.F. Voltage	Overall Dimensions		Capacity Tolerance
				Length	Width	
CAP-6/30/20	6	30 amps.	20 KV	3-11/16"	3"	± 4MMFD
CAP-12/30/20	12	30 amps.	20 KV	3-11/16"	3"	± 1MMFD
CAP-25/60/20	25	60 amps.	20 KV	3-11/16"	3"	± 1MMFD
CAP-50/60/20	50	60 amps.	20 KV	3-11/16"	3"	± 1MMFD
CAP-50/60/25	50	60 amps.	25 KV	4-1/2"	2-5/8"	± 2%
CAP-6/30/35	6	30 amps.	35 KV	6-19/32"	2-13/16"	± 4MMFD
CAP-12/30/35	12	30 amps.	35 KV	6-19/32"	2-13/16"	± 1MMFD
CAP-25/60/35	25	60 amps.	35 KV	6-19/32"	2-13/16"	± 1MMFD
CAP-50/60/35	50	60 amps.	35 KV	6-19/32"	2-13/16"	± 1MMFD
CAP-75/60/35	75	60 amps.	35 KV	6-19/32"	2-13/16"	± 2%
CAP-100/60/35	100	60 amps.	35 KV	6-19/32"	2-13/16"	± 2%
CAP-150/60/35	150	60 amps.	35 KV	6-19/32"	2-13/16"	± 2%
CAP-200/60/35	200	60 amps.	35 KV	6-19/32"	3-1/16"	± 2%
CAP-250/60/35	250	60 amps.	35 KV	6-19/32"	3-1/16"	± 2%
CAP-450/60/20	450	60 amps.	20 KV	8-15/32"	3"	± 2%
CAP-500/60/20	500	60 amps.	20 KV	9-7/32"	3"	± 2%

All metal parts of UNITED vacuum capacitors are oxygen free, high conductivity copper

Outstanding features of UNITED vacuum capacitors are the employment of large elements and large periphery glass to copper seals, as illustrated. Type designations of UNITED vacuum capacitors symbolize their capacitance ratings and their maximum current and voltage ratings—thus:

C = Capacitance A = Amperes P = Potential

Complete technical information sent on request.

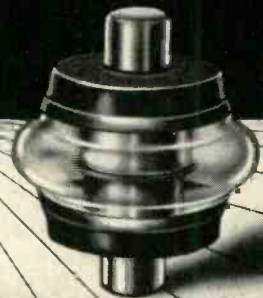
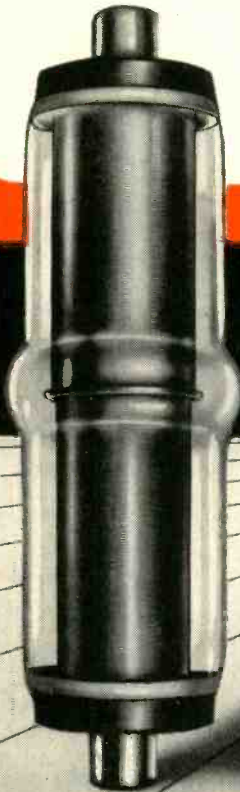

UNITED  **ELECTRONICS, 42 Spring Street, Newark 2, N. J.**
(TRANSMITTING TUBES EXCLUSIVELY Since 1934)

Save time by contacting

UNITED

for the wide range of

JAN APPROVED GAS RECTIFIERS & THYRATRONS

Complete Technical Data
Sent On Request

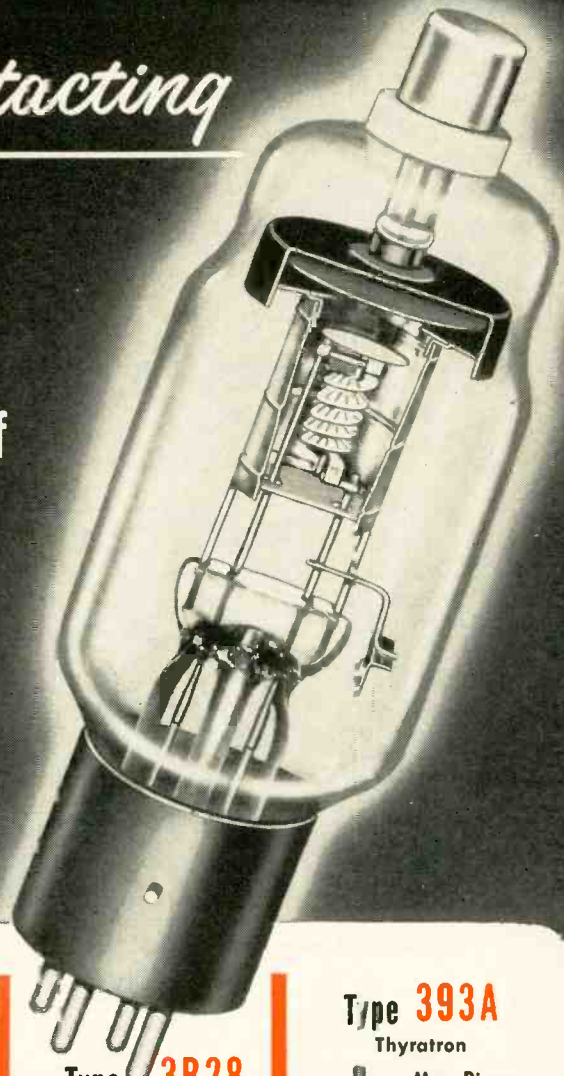

Type 4B32

Rectifier



Max. Dimen.:
Ht. 8-1/2"
Diam. 2-5/16"

Ratings:
Ef 5.0 volts
If 6.75 amps.
epx 10 KV
Io 1.25 amps.
Ib 5.0 amps.

Atmosphere:
Xenon Gas

Type 323B

Thyratron



Max. Dimen.:
Ht. 6-9/16"
Diam. 2-3/16"

Ratings:
Ef 2.5 volts
If 7.0 amps.
epx 1250 volts
Io 1.5 amps.
Ib 6.0 amps.

Atmosphere:
Argon-Mercury

Type 3B28

Rectifier

Max. Dimen.:
Ht. 6-5/32"
Diam. 2-1/16"

Ratings:
Ef 2.5 volts
If 5.0 amps.
epx 10 KV
Io 250 ma
Ib 1.0 amp.

Atmosphere: Xenon Gas

Type 393A

Thyratron



Max. Dimen.:
Ht. 6-10/16"
Diam. 2-1/16"

Ratings:
Ef 2.5 volts
If 7.0 amps.
epx 1250 volts
Io 1.5 amps.
Ib 6.0 amps.

Atmosphere:
Argon-Mercury

Type 3C23

Thyratron



Max. Dimen.:
Ht. 6-1/8"
Diam. 2-1/16"

Ratings:
Ef 2.5 volts
If 7.0 amps.
epx 1250 volts
Io 1.5 amps.
Ib 6.0 amps.

Atmosphere:
Argon-Mercury

Type 355A

Thyratron



Max. Dimen.:
Ht. 9-1/2"
Diam. 3-3/16"

Ratings:
Ef 2.5 volts.
If 16.0 amps.
epx 350 volts
Io 4.0 amps.
Ib 16.0 amps.

Atmosphere:
Argon-Mercury

Type 354A

Thyratron



Max. Dimen.:
Ht. 9-1/2"
Diam. 2-5/16"

Ratings:
Ef 2.5 volts
If 16.0 amps.
epx 1500 volts
Io 4.0 amps.
Ib 16.0 amps.

Atmosphere:
Mercury Vapor

Type 575A

Rectifier



Max. Dimen.:
Ht. 11-1/16"
Diam. 3-1/16"

Ratings:
Ef 5.0 volts
If 10.0 amps.
epx 15 KV
Io 1.5 amps.
Ib 6.0 amps.

Atmosphere:
Mercury Vapor

UNITED  ELECTRONICS, 42 Spring Street, Newark 2, N. J.

(TRANSMITTING TUBES EXCLUSIVELY Since 1934)

Do you know about these

NEW TUBES for Pulse Modulator Applications

UNITED

HIGH VOLTAGE—HIGH VACUUM DIODES

These new United Graphite Anode Diodes have been developed to fulfill the important aims of the Armed Services program for decreased size . . . increased ruggedness . . . and increased reliability of Electron Tubes. Complete technical data sent on request.

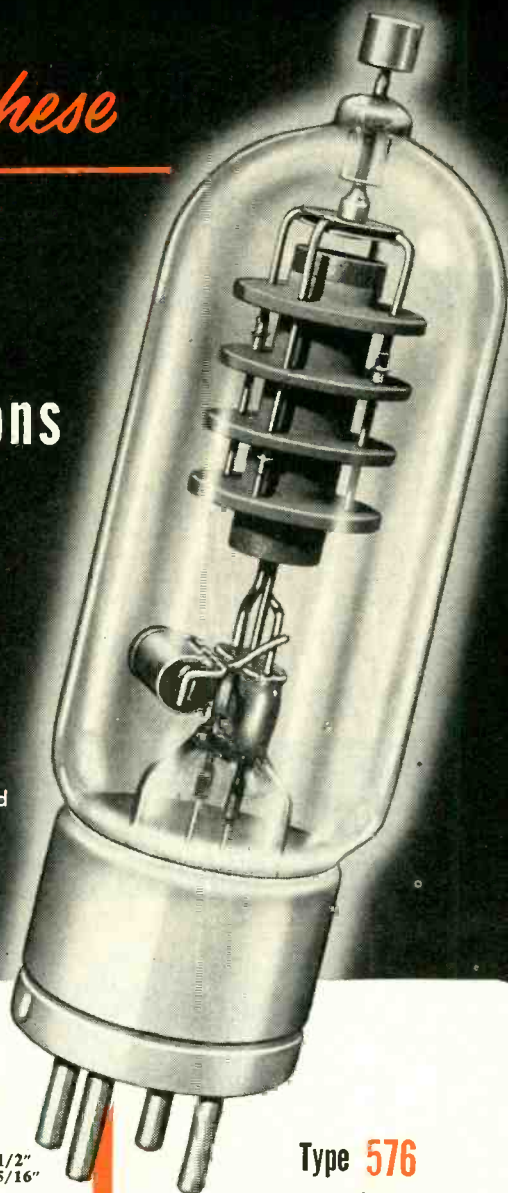

Type 577

Max. Dimen.:

Height 7-3/8"
Diameter 2-1/16"

Ratings:

Ef 5.0 volts
If 10.25 amps.
epx 25 kv
Io 300 ma
ib 1.50 amps.



Type 578

Max. Dimen.:

Height 6-1/2"
Diameter 2-5/16"

Ratings:

Ef 5.0 volts
If 6.0 amps.
epx 40 kv
Io 100 ma
ib 750 ma

Type 576

Ratings:

Ef 5.0 volts
If 14.0 amps.
epx 25 kv
Io 500 ma
ib 2.5 amps.

Max. Dimen.:

Height 7-1/2"
Diameter 2-5/16"



Type 371-B

Max. Dimen.:

Height 8-3/4"
Diameter 2-5/16"

Ratings:

Ef 5.0 volts
If 10.3 amps.
epx 25 kv
Io 300 ma
ib 1.5 amps.



Type 3B24W

Max. Dimen.:

Height 4-1/2"
Diameter 1-9/16"

Ratings:

Ef 5.0 volts
If 3.0 amps.
epx 20 kv
Io 60 ma
ib 300 ma



Type 3B29

Max. Dimen.:

Height 4-3/4"
Diameter 1-9/16"

Ratings:

Ef 2.5 volts
If 4.75 amps.
epx 16 kv
Io 65 ma
ib 250 ma

UNITED



ELECTRONICS, 42 Spring Street, Newark 2, N. J.



BRAININ ELECTRICAL CONTACTS

PRECISION SERVICE . . .
from Order to Delivery

Your production problems may be simplified when you consult an organization with a long record of successfully serving electrical manufacturers in all types of precision work. Whether you are seeking advice on new applications, redesign, or wish your own designs executed, send us your requirements, and they will receive our most careful attention.

Extra KNOW-HOW
for your specific design problems

THERMOSTATIC BIMETAL
PRECIOUS METAL PRODUCTS FOR ELECTRICAL MANUFACTURERS

C. S. BRAININ CO.

318 Washington Street, Mt. Vernon, N. Y.

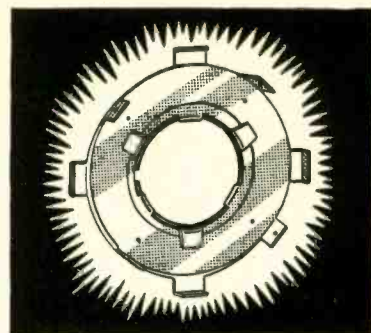

CENTER TV PICTURES IN 3 SECONDS

with the

PERFECTION

BeamaJuster

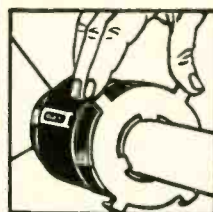

1. Snap BeamaJuster on back cover of tube yoke. (Fits any standard yoke and any size tube.)
2. Rotate BeamaJuster as shown here for approximate centering of picture.
3. Make final adjustment by sliding outer plate of BeamaJuster vertically or horizontally.

Write today for full details!

PERFECTION ELECTRIC COMPANY
2635 South Wabash Ave. Chicago 16, Illinois

Makers of Perfection Speakers, Ion Traps and B. O. (Barkhausen Oscillation) Eliminators.

**Original Equipment
in MORE than
500,000 sets . . .**

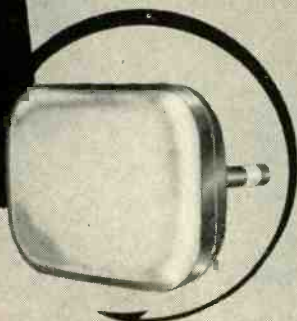

TEL-O-TUBE

The World's Finest Television Picture Tube

Electrostatic Focus & Deflection Tubes

Magnetic Focus & Deflection Tubes

Electrostatic Focus Magnetic Deflection Tubes

10 to 20 inches Round and Rectangular

Repair department for out of warranty tubes

Send Today For Complete Specifications

TEL-O-TUBE CORPORATION OF AMERICA

E. PATERSON NEW JERSEY

Sales Office: Tel-O-Tube Sales Corporation

580 5th Ave. New York 19, N. Y.

TEL-O-TUBE



THE WORLD'S FINEST
TELEVISION PICTURE TUBE

NOT...

**until next year
will you get another**

electronics BUYERS' GUIDE

Don't let it get away
from you.

It's the best source
of buying information
for electronic
and allied products
that has ever
been compiled.

When buying, or requesting product information be sure to mention
ELECTRONICS BUYERS' GUIDE.

50th YEAR

OF CERAMIC LEADERSHIP



APRIL, 1951, marks the beginning of the 50th year of American Lava Corporation's ever-growing services to users of custom made technical ceramics. We are proud of this record and are genuinely grateful to the customers who have made this growth possible. To our customers we dedicate our future to a continuance of the type of services and quality of products that will contribute to the success of expanding American industries.

AMERICAN LAVA CORPORATION

PHILADELPHIA • ST. LOUIS • CAMBRIDGE • CHICAGO • LOS ANGELES • NEWARK

CHATTANOOGA 5, TENNESSEE

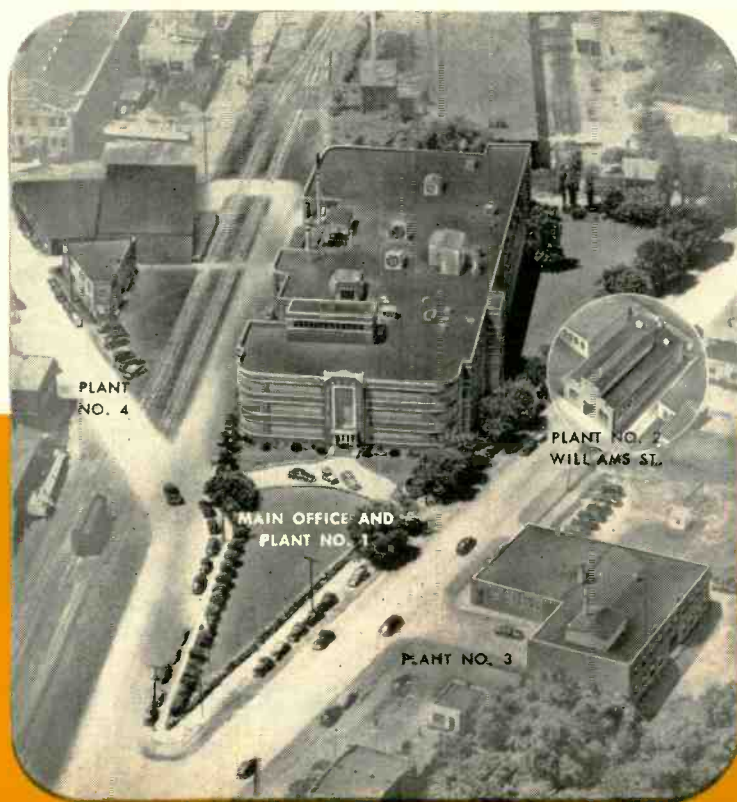

ALSI-MAG

For Dependable Quality TRANSFORMERS

*Specify
Stancor*

More than 150 power transformers are listed in the Stancor catalog—the most complete line in the industry.

The design of the "8400 Series" of power transformers was based on a thorough study of today's power transformer needs. These transformers have a wide range of applications. All units have low temperature rise, well within the limits set by RTMA standards.

A choice of horizontal (PM) Or vertical (PC) mountings is available for most ratings.

For top quality at a low price, specify the Stancor "8400 Series."

COMBINATION PLATE AND FILAMENT SUPPLY

The 8400 Series Power Transformers listed below cover 95% of today's power transformer needs.

POWER TRANSFORMERS TO PROVIDE APPROXIMATELY 260 VOLTS D.C. TO CONDENSER INPUT FILTER

TYPE & PART NO.	PLATE SUPPLY A.C. VOLTS D.C. MA.	RECTIFIER FIL. VOLTS AMPS.	OTHER WINDINGS VOLTS AMPS.	BASE AREA	OVERALL HEIGHT	MTG. CENTERS	SHPG. WT. IN LBS.	LIST PRICE
PC8401	235-0-235 40	5.0 2.0	6.3 CT 2.0	2 5/8" x 2 5/8"	3 1/16"	2" x 1 1/16"	2.2	\$ 6.15
PM8401				2 1/2" x 3"	2 5/8"	2" x 2 1/2"		
PC8402	240-0-240 55	5.0 2.0	6.3 CT 2.0	2 5/8" x 2 3/4"	3 3/4"	2" x 1 1/16"	2.4	6.80
PM8402				2 1/2" x 3"	2 3/4"	2" x 2 1/2"		
PC8403	250-0-250 70	5.0 2.0	6.3 CT 2.5	2 5/8" x 3 1/8"	3 3/16"	2" x 2 1/16"	3.2	7.65
PM8403				2 1/2" x 3"	3 1/8"	2" x 2 1/2"		
PC8404	260-0-260 90	5.0 2.0	6.3 CT 3.0	3" x 3 1/2"	3 5/8"	2 1/4" x 2 1/4"	4.0	8.60
PM8404				2 7/8" x 3 3/8"	3 5/8"	2 1/4" x 2 13/16"		
PC8405	270-0-270 120	5.0 3.0	6.3 CT 3.5	3 1/4" x 3 1/4"	4"	2 1/2" x 2 5/16"	4.9	9.50
PM8405				3 1/8" x 3 3/4"	3 1/4"	2 1/2" x 3 1/8"		

POWER TRANSFORMERS FOR USE WITH CHOKE INPUT FILTER, VR-TUBE REGULATED SUPPLY, SPEAKER FIELD IN FILTER, OR HIGHER VOLTAGE WITH CONDENSER INPUT FILTER

PC8406	325-0-325 40	5.0 2.0	6.3 CT 2.0	2 5/8" x 2 3/4"	3 1/16"	2" x 1 1/16"	2.4	\$ 6.25
PM8406				2 1/2" x 3"	2 3/4"	2" x 2 1/2"		
PC8407	325-0-325 55	5.0 2.0	6.3 CT 2.0	2 5/8" x 3 1/8"	3 3/4"	2" x 2 1/16"	3.2	6.90
PM8407				2 1/2" x 3"	3 1/8"	2" x 2 1/2"		
PC8408	340-0-340 70	5.0 2.0	6.3 CT 2.5	3" x 3 5/8"	3 3/8"	2 1/4" x 2 1/8"	3.8	7.95
PM8408				2 7/8" x 3 3/8"	3 1/2"	2 1/4" x 2 13/16"		
PC8409	350-0-350 90	5.0 2.0	6.3 CT 3.0	3" x 3 5/8"	3 3/8"	2 1/4" x 2 3/8"	4.5	8.85
PM8409				2 7/8" x 3 3/8"	3 3/4"	2 1/4" x 2 13/16"		
PC8410	360-0-360 120	5.0 3.0	6.3 CT 3.5	3 1/4" x 3 3/4"	4"	2 1/2" x 2 5/16"	5.5	9.65
PM8410				3 1/8" x 3 3/4"	3 3/4"	2 1/2" x 3 1/8"		
PC8411	375-0-375 150	5.0 3.0	6.3 CT 4.5	3 5/8" x 4"	4 5/16"	2 3/4" x 2 13/16"	5.8	11.55
PM8411				3 1/2" x 4 1/8"	3 7/8"	2 3/4" x 3 5/16"		
PC8412	400-0-400 200	5.0 3.0	6.3 CT 5.0	4" x 4"	4 3/4"	3" x 2 13/16"	8.2	13.25
PM8412				3 3/4" x 4 1/2"	3 7/8"	3" x 3 3/4"		
PC8413	400-0-400 250	5.0 4.0	6.3 CT 5.0	4" x 4 1/2"	4 3/4"	3" x 3 5/16"	10.0	16.30
PC8414	600-0-600 200	5.0 3.0	6.3 6.3 3.0 3.0	4" x 4"	4 3/4"	3" x 2 13/16"	8.3	16.40

POWER TRANSFORMERS FOR USE WITH 6AX5, 6X4, 6X5, OR SELENIUM RECTIFIERS

PS8415	125 1/2-wave 15		6.3	0.6	2 3/8" x 1 3/8"	2"	2"	0.7	\$ 2.90	
PS8416	125-0-125 25		6.3	1.0	2 7/8" x 1 3/4"	2 5/16"	2 5/16"	1.0	3.60	
PA8421	125 1/2-wave 50		6.3	2.0	3 3/4" x 2 1/4"	2 1/4"	3 1/8"	1.5	4.75	
PC8417	220 0 220 50	6.3	0.6	25.2	0.5	2 5/8" x 2 5/8"	3 1/16"	2" x 1 1/16"	2.2	6.70
PC8418	230-0-230 50		6.3	2.5	2 5/8" x 2 5/8"	3 1/8"	2" x 1 1/16"	2.2	5.95	
PM8418					2 1/2" x 3"	2 5/8"	2" x 2 1/2"			
PC8419	240-0-240 70		6.3	3.0	2 5/8" x 2 7/8"	3 1/16"	2" x 1 13/16"	2.6	6.80	
PM8419					2 1/2" x 3"	2 7/8"	2" x 2 1/2"			
PC8420	260-0-260 90		6.3	4.0	3" x 3 1/2"	3 1/2"	2" x 2 1/4"	3.5	7.60	
PM8420					2 7/8" x 3 3/8"	3 1/2"	2 1/4" x 2 13/16"			

These units are representative of the 450 stock transformers in the Stancor Catalog and are available for immediate delivery from your local Stancor distributor. Write for the complete 1951 Stancor Catalog today.

Stancor also leads the field in the production of special transformers for specific industrial applications. Complete facilities for the production of transformers meeting MIL-T-27 specifications are available. Your inquiries are invited.

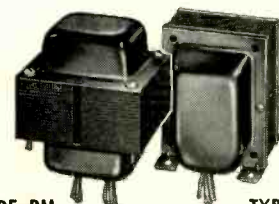

TYPE PM

TYPE PC

STANDARD TRANSFORMER CORPORATION 3580 ELSTON AVENUE, CHICAGO 18, ILLINOIS

TUBE TEST EQUIPMENT

- Aging and Life Racks
- Vibration—Aging Racks
- Vibration Short Test Racks

CHARACTERISTIC TEST SETS (for Receiving-Type Tubes)

- Heater-Cathode Leakage
- Grid Currents
- Plate Current Emission
- Amplification Factor
- Gas
- Trans-Conductance
- Power Output—AF and RF

CHARACTERISTIC TEST SETS (for Cathode Ray Tubes)

- Spot Position
 - Spot Displacement
 - Deflection Uniformity
 - Deflection Factor
 - Brilliance
 - Persistency
 - Heater Current
 - Anode Current
 - Gas
 - Voltage Breakdown
-
- Transmitter-Receiver: A.M.; F.M.; P.M.; TV
 - Navigational Aids and Devices—Homing and Direction Finding Equipment
 - Telemetering; Radar, Sonar
 - Micro-wave techniques and applications: Generators; Converters and complete assemblies

ELECTRONIC CONTROL EQUIPMENT FOR:

- Guided Missiles: Drone Aircraft; Remote Control Devices
- Computers and Calculators • Servo Links
- Velocity Propagation Measurement
- Processing Equipment—industrial applications, quality control

ELECTRONIC MEASURING DEVICES

- Flow indicators—Liquids, gases, solid components
- Sorting, counting and inspection
- Chemical process control; titration; ionization; diffusion
- Flow detection—strains, stresses, inner faults
- X-Ray, supersonic and radio frequency applications to measurement

INSTRUMENTATION

- DC; AC; Audio; RF; Microwaves; Infra-Red; Visible Spectrum; Ultra-Violet; Soft and Hard X-Ray; Cosmic Radiation
- Vacuum Tube Meters • Null Detectors
- RF Audio Frequency Generators
- Bridges
- Multi-Wave Shape Generators
- High Gain Amplifiers • Oscilloscopes
- Power Supplies, Regulated, High & Low Level

SHERRON WILL INITIATE OR DEVELOP AND MANUFACTURE PROTOTYPES FROM YOUR SPECIFICATIONS



SHERRON OFFERS AN OVER-ALL, START-TO-FINISH ELECTRONICS SERVICE

RESEARCH • DESIGN • DEVELOPMENT



You get all the benefits of an experienced, integrated, all inclusive electronics service — when you work with Sherron. This definitive service includes . . . research and development in our electronics and electro-mechanical laboratories right through sheet metal fabrication in our block-long plant.

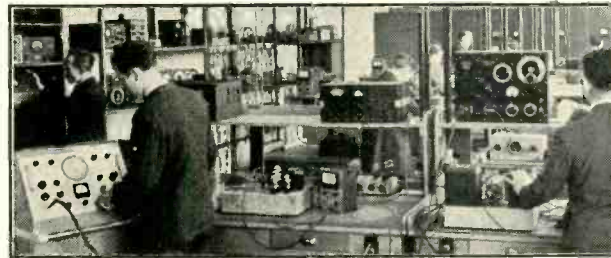

At the top of the Sherron personnel pyramid are physicists with electronic knowledge who will provide the necessary research for your project . . . electronic and mechanical engineers who will develop it . . . technicians who will accredit its workability. These men work hand in hand with our production engineers, who have at their command the necessary sheet metal fabrication facilities and manpower to turn out a finished prototype . . . ready for you to manufacture. Whether we initiate the design — or work from your prints and specifications — our service is confidential.

HYDRO MECHANICAL DIVISION

To design, style, develop and manufacture prototypes and high precision mechanical sub-assemblies, or assemblies involving part manufacture and assembly of units incorporating machine elements of bases, springs, levers, shafts, bearings, cams, valves, regulators, drives, transmissions and controls for:

- JET ENGINE ACCESSORY TEST STANDS
- SPECIAL HYDRAULIC UNITS
- SPECIAL MEASURING INSTRUMENTS
- SERVO MECHANISMS
- KEYS & COUPLERS
- DRIVING AND CONTROLLING EQUIPMENT
- REGULATORS
- MICRO WAVE APPARATUS
- RADAR MECHANISMS
- COMPUTER MECHANISMS
- MECHANICAL OPTICAL SPECIALTIES
- MECHANISMS OF NAVIGATIONAL DEVICES
- VIBRATION CONTROL MOUNTINGS
- PRECISION GEAR TRAINS



SHERRON ELECTRONICS COMPANY

Division of Sherron Metallic Corporation

1201 FLUSHING AVENUE • BROOKLYN 6, NEW YORK

CORNELL-DUBILIER ELECTRIC CORP.

South Plainfield, N. J. Other plants in New Bedford, Brookline and Worcester, Mass.; Providence, R. I., Indianapolis, Ind., and subsidiary, The Radiart Corp., Cleveland, O.



CONSISTENTLY DEPENDABLE

CORNELL-DUBILIER

CAPACITORS — AUTO VIBRATORS
TV AND FM ANTENNAS — ROTATORS — CONVERTERS



"BLUE BEAVER" Electrolytics — most popular for all applications where dependability and economy are essential. In single and dual capacities at 25 to 500 V.D.C.W.

ELECTROLYTICS



TYPE UP's for safe operation at temperatures $+65^{\circ}\text{C.}$ or $+85^{\circ}\text{C.}$ In all commercial capacities at voltages from 10 to 500 V.D.C.W.



TYPE EZ universal mounting units. Practical, dependable, economical. In all capacities at voltages from 150 to 450 V.D.C.W.



ROYAL TIGER Polykane Tubulars for operation at -35° to $+100^{\circ}\text{C.}$ A new type tubular in all capacities from 100 V.D.C. to 1000 V.D.C.

PAPER CAPACITORS



TYPE TMC's are also available in all standard capacities and voltage ratings up to 6,000 V.D.C. Can also be furnished to JAN specifications.



TYPE DYR Oil-filled "bath tub" capacitors. Provided with terminals either side, top or bottom. In all capacity combinations and voltages to 1000 V.D.C.

DYKANOL* TRANSMITTER CAPACITORS



TYPE T's are the finest, most dependable capacitors obtainable for broadcast and commercial transmitting application. In all popular capacities up to 7,500 V.D.C.



TYPE TQ DYKANOL* CAPACITORS. Hermetically sealed in round aluminum containers. With two insulated terminals available at voltages between 600 and 3,000 V.D.C.

TINY MIKE* CERAMICS

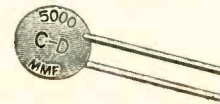

Miniature disc type—highly efficient, low cost. Remarkably rugged. Available in capacity range of 1,000 mmfd. to 5,000 mmfd. guaranteed minimum capacity, at 500 V.D.C.W. Units of between 100 and 150 mmfd. at $\pm 20\%$ or $\pm 10\%$.

MICA RECEIVING AND TRANSMITTING CAPACITORS

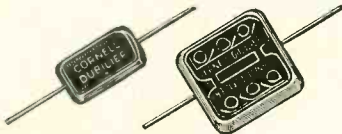

MOULDED MICAS for all requirements. Available moulded in low loss bakelite. "Silver-Mike" micas for use in high Q electronic circuits.

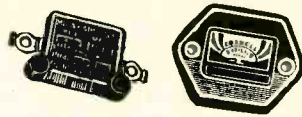

TYPES 4 and 9—for amplifier and transmitter applications. All capacities in voltages to 5,000 V.D.C. test.

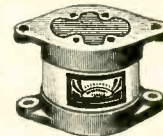

TYPE 50 Series Transmitter micas feature world famous series stack construction.

VIBRATORS



C-D vibrators are quieter, longer lasting, more efficient.

CONVERTERS



FOR D.C. TO A.C.; A.C. TO D.C.; D.C. TO D.C. CONVERSION.

TV, AM, FM, AUTO and ROTATOR ANTENNAS

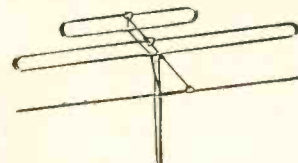

Sturdily constructed for a lifetime of trouble-free service.

Specify

ELECTRONIC ENGINEERS

GUARDIAN

HERMETICALLY SEALED RELAYS

TV CENTERING MAGNETS AND FOCUS COILS

NEAT

EFFICIENT

EASY-TO-SERVICE

VIBRATION-PROOF

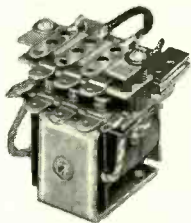

SERIES 335 RELAY

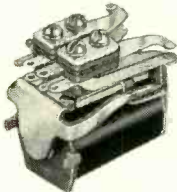

SERIES 595 RELAY

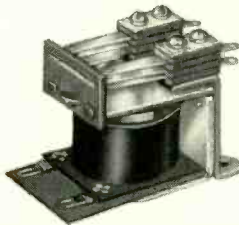

SERIES 610 AC—615 DC RELAY



THE SCREW TERMINAL TYPE



THE A. N. CONNECTOR TYPE



THE OCTAL PLUG TYPE



THE LUG HEADER TYPE

Valuable information on **HERMETICALLY SEALED** Guardian Relays is yours for the asking. Write on your business letterhead for new completely descriptive and illustrated Catalog 5-H. No cost. No obligation.

Write—ASK US TO MAKE SPECIFIC RECOMMENDATIONS. NO OBLIGATION.

GUARDIAN ELECTRIC

1625-BG W. WALNUT STREET CHICAGO 12, ILLINOIS
A COMPLETE LINE OF RELAYS SERVING AMERICAN INDUSTRY



GUARDIAN CENTERING MAGNETS

The Guardian Centering Magnet compensates magnetically for any misalignment of the electronic beam or the focus coil assembly. Eliminates manual adjustment of the raster.



GUARDIAN FOCUS COILS

Over a million Focus Coils have rolled off Guardian's production lines into TV sets of leading manufacturers. With more than 75 types established as *Guardian Standard*, speedy delivery to meet today's replacement needs is a matter of routine.



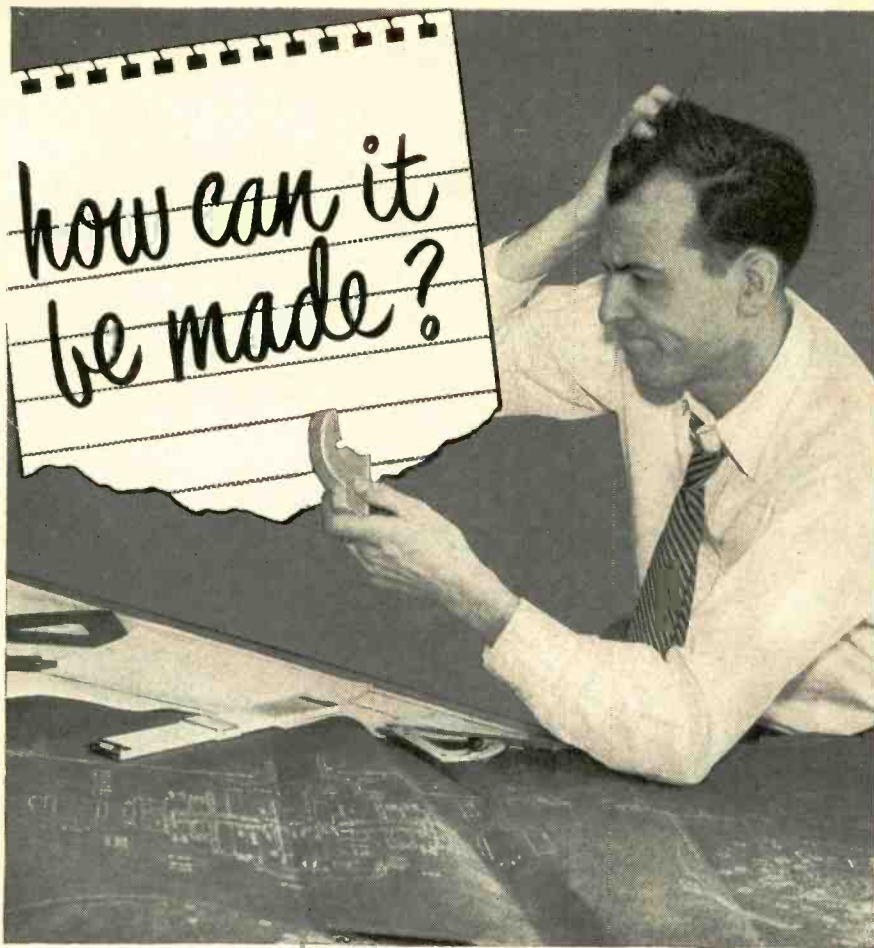

**Intricate parts and precision components
can be *ELECTROFORMED***



Write Dept. BG-6
for copy of
Electroforming
Applications
and
Procedure

If the radio frequency component you need cannot be made by conventional methods or is difficult and costly to manufacture, the possibilities are it can be made by electroforming.

Electroforming can produce parts of intricate design, accurate interior dimensions and with high interior surface finish up to 5 micro-inch. Combinations of metals may be used such as silver, gold, copper, nickel and iron for specific applications such as conductivity, strength and corrosion resistance. Dimensional stability is easily obtainable whereas it would be impossible to hold dimensions by any other method.

ELECTROFORMING is the manufacturing of an article by the electrodeposition of metal on a form of predetermined size, shape, accuracy and finish. We welcome the opportunity to discuss your problem, no matter how difficult it may seem.



BART LABORATORIES CO., INC.

227 Main St.

Belleville 9, N. J.

Pioneers in Precision Electroforming

A Sound INVESTMENT
IN FINE MUSIC . . .

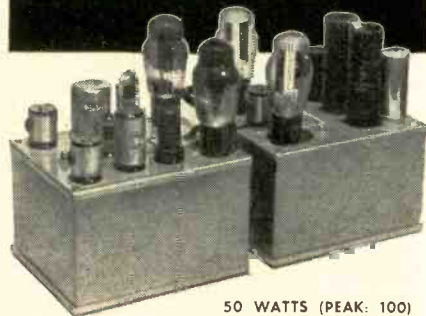

50 WATTS (PEAK: 100)
50W-2 \$249.50

McIntosh
WORLD'S FINEST
AUDIO AMPLIFIER

50 WATT AMPLIFIER

Unequaled for quality reproduction of any sound source, the McIntosh is the most advanced amplifier of the day. Its unique, compact design offers: HIGHEST EFFICIENCY—over 65%; LESS THAN 1% DISTORTION AT PEAK POWER; DYNAMIC RANGE: OVER 70 db; FREQUENCY RESPONSE: 20-20,000 cps.

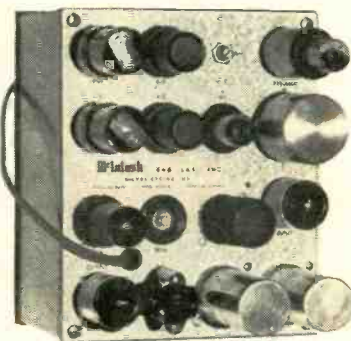

20 WATTS (PEAK: 40) 20W-2 \$149.50



AE-2 AMPLIFIER EQUALIZER . . . \$74.50

SEND FOR **FREE** CATALOG TODAY!
McINTOSH Engineering Laboratories, Inc.
DEPT. C, 320 WATER ST., BINGHAMTON, N. Y.

FREED

TRANSFORMERS & INSTRUMENTS

"PRODUCTS OF EXTENSIVE RESEARCH"



NO. 1060 VACUUM
TUBE VOLTMETER
INPUT IMPEDANCE
50 MEGOHMS



NO. 1030 LOW
FREQUENCY "Q"
INDICATOR

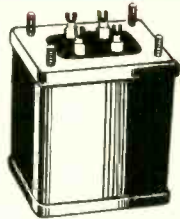

HIGH FIDELITY
TRANSFORMERS
1/2 DB 20 CPS TO 30 KC

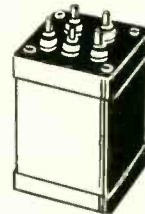

DISCRIMINATORS
10 CPS TO 1-MC

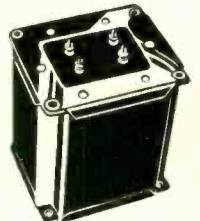

COMMERCIAL
COMPONENTS
QUALITY —
DEPENDABILITY — PRICE



NO. 1140 NULL
DETECTOR
COMPLETE WITH
SELECTIVE CIRCUITS



NO. 1020 MEGOHMMETER
2,000,000 MEGOHMS
DIRECT READING

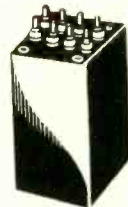

HERMETICALLY
SEALED COMPONENTS
TO MEET MIL-T-27 SPECS.

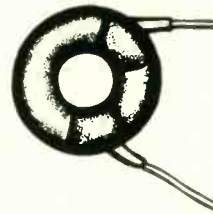

TOROIDAL INDUCTORS
60 CPS TO 1 MC

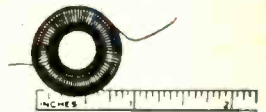

MINIATURE INDUCTORS
1000 CPS TO 100 KC

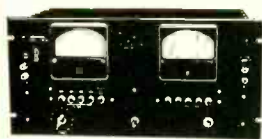

NO. 1210 NULL
DETECTOR & VACUUM
TUBE VOLTMETER



DECADE INDUCTORS
30 CPS TO 300 KC



SUB-MINIATURE
HERMETICALLY SEALED
TOROIDAL INDUCTORS



SUB-MINIATURE
HERMETICALLY SEALED
COMMUNICATION
COMPONENTS



SLUG TUNED
COMPONENTS
1000 CPS TO 1 MC



NO. 1150 UNIVERSAL
BRIDGE
5 A.C. BRIDGES IN ONE
UNIT



NO. 1010 COMPARISON
BRIDGE
FAST, ACCURATE,
RELIABLE

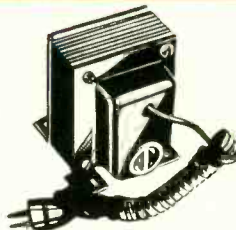

STEPDOWN
TRANSFORMERS
50 WATTS TO 3 KW



PULSE TRANSFORMERS
FROM WATTS TO
MEGAWATTS

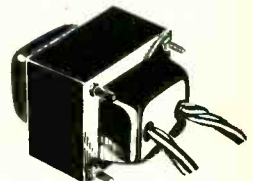

POWER
TRANSFORMERS
RUGGED, DEPENDABLE,
INEXPENSIVE.



1170 D.C. SUPPLY
DIRECT CURRENT UP TO
500 MA.

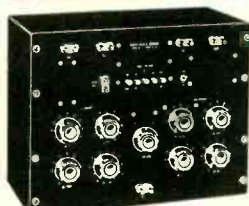

NO. 1110 A INCREMENTAL
INDUCTANCE BRIDGE
A NECESSITY FOR EVERY LAB



PRECISION FILTERS
10 CPS. TO 1 MC.

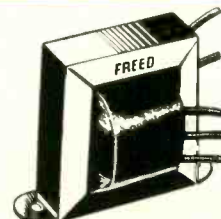

CHANNEL MOUNTING
INEXPENSIVE—RELIABLE

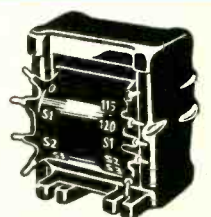

FREEDSEAL TREATMENT
ANE-19 SPECS.

SEND FOR LATEST CATALOG!

FREED TRANSFORMER CO., INC.

DEPT. GE 1718-36 WEIRFIELD ST., (RIDGWOOD) BROOKLYN 27, NEW YORK

RADIO DIRECTION FINDER CRD-2

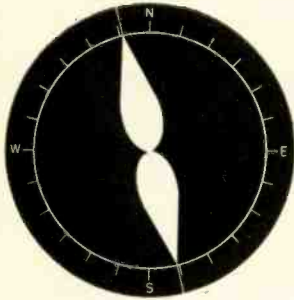

The SCA electronic goniometer is an automatic radio direction finder for ground-station use. It produces an instantaneous visual bearing indication on any sky-wave or ground-wave signal of communication usefulness. The novel electronic scanning and presentation method results in high sensitivity and accuracy, low power consumption, ease of maintenance, and operational versatility. HF and UHF models available.

SECONDARY FREQUENCY STANDARD

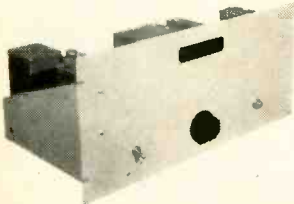

Produces a crystal-controlled spectrum of harmonically-related frequencies. The envelope of the harmonic amplitudes is uniform from 1 k.c. to 85 m.c. A single operating control sets the instrument to any one of the five harmonic-interval spacings. An aperiodic output circuit eliminates the usual tuning control; band switching is unnecessary.

SPECIFICATIONS

USEFUL FREQ. RANGE: 1 k.c. to 85 m.c.
 INTERVAL SPACINGS: 2, 5, 10, 20, and 50 k.c.
 ACCURACY: .0015% long-time stability, or .005% over a 24 hour period with daily adjustment, over an ambient temperature range of +10° to +50°C.
 AMPLITUDE UNIFORMITY: Less than 1% amplitude variation over any 1 m.c. range.
 OUTPUT LEVELS: For 20 k.c. interval spacing, 20 millivolts or more to 50 m.c.; 10 millivolts or more to 75 m.c.; 5 millivolts or more to 85 m.c.
 OUTPUT IMPEDANCE: 160 ohms. POWER INPUT: 100 watts at 105-125 volts, 50-60 cps.
 SIZE AND WEIGHT: 8 3/4" high, 19" wide, 10" deep; 39 lbs. Panel construction for rack mounting.

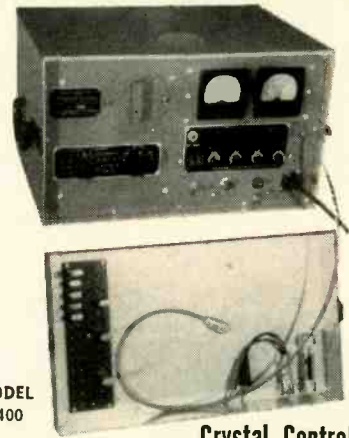

MODEL 2400

Crystal Controlled SIGNAL GENERATOR

Covers a range of 150 kc to 150 mc in 10 overlapping bands. For frequencies up to 9.6 mc the output frequency is that of the frequency controlling crystal. For output frequencies of 9.4 to 150 mc, cascaded frequency doublers are switched into the system thus limiting the maximum crystal frequency requirement to 9.6 mc. The R.F. carrier output adjustable from 1 to 100,000 microvolts into a nominal 53 ohm load. The R.F. level reads from the microvolts meter. A 4-step push button multiplier multiplies output level in steps of 10, the meter being directly calibrated for 1 to 10 microvolts.

MARKER GENERATOR: Produces 2 crystal-controlled marker frequencies in each of 6 bands. When combined with the harmonic-spectrum of the S.C.A. Secondary Frequency Standard, these frequencies serve as "mileposts" in the spectrum. It is synchronized from the S.C.A. Secondary Frequency Standard and its output frequencies have the same accuracy as the standard. Output frequencies switch selected—no tuning is required. Individual 50-ohm outputs provided for 2 marker frequencies.

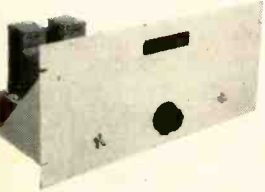

USEFUL FREQ. RANGE: 500 k.c. to 32 m.c. in six bands of 1:2 frequency ratio.

ACCURACY: .0015% long time stability, or .0005% over a 24 hour period with daily adjustment, over an ambient temperature range of +10° to +50°C.

OUTPUT LEVEL: 10 volts r.m.s. OUTPUT IMPEDANCE: 50 ohms.

POWER INPUT: 60 watts at 105-125 volts, 50-60 cps.

SIZE AND WEIGHT: 8 3/4" high, 19" wide, 7" deep; 28 lbs. Panel construction for rack mounting.

SERVOTHERM



THERMISTOR BOLOMETERS INFRARED RADIATION DETECTORS

The Servotherm Thermistor Bolometers are fast, sensitive infrared detectors. They are rugged units suitable for spectrophotometric, industrial and military applications. They have the same properties as types developed by the Bell Telephone Labs, and are manufactured under license arrangements with Western Electric Co. For all types, the flake is a blackened thermistor; flake size—L-2.5 mm, W-.2 mm., Thickness—0.010 mm, flake resistance at 25°C approximately 3 meg.

SERVOTHERM TYPE	BQ-1	BG-1	BA-1
Thermal Sink	Quartz	Glass	Air-spaced Metal
Recommended Bias Voltage, Approx.†	200	130	80
Responsivity,* Volts/watt, approx.†	400	400	600
Time Constant, Seconds	.003 to .005	.005 to .008	.020 to .040

*For infrared energy from a 400° K. black body square wave chopped at 15 cps.
 †Test results are furnished with each unit.

BOLOMETER PREAMPLIFIER: Serves as the bolometer mount and permits high impedance bolometer output to be fed in a rigidly supported and shielded tube to the preamplifier input. The 2-stage amplifier uses a twin-triode low noise, low microphonic tube. The amplifier has a gain of 300, an output impedance of about 20,000 ohms, and a low frequency cut-off of approximately 3 cps. The high frequency cut-off is normally 1500 cycles.



THERMISTOR POWER UNIT: Consists of a high quality regulator of 270 v. output which operates 2 high frequency oscillators. One is rectified and filtered for the 6 v. filaments to the preamplifier and the other is rectified and filtered for the thermistor bridge voltage. Line voltage variations are stabilized in the 270 v. regulator and do not cause large voltage variations in output supply voltages of the 6 v. and thermistor supply circuits. B supply for preamplifier is derived from a V-R tube also operated from the 270 v. regulator.

RADIATION PYROMETER: The Servotherm Radiation Pyrometer is used for remotely measuring or controlling the temperature of objects. Temperatures as small as 10° C. above or below ambient may be measured. Measurements are taken at a rate of 40 cps. The pyrometer optical head may be located at any distance from the object.

SERVO CORPORATION OF AMERICA

Dept. BG-51

• NEW HYDE PARK, N. Y. •

FIELDSTONE 7-2810



The New Servoscope®

Saves Time and Guesswork in design and synthesis of . . .
CONTROLLERS • SERVOMECHANISMS • REGULATORS • PROCESS INSTRUMENTATION

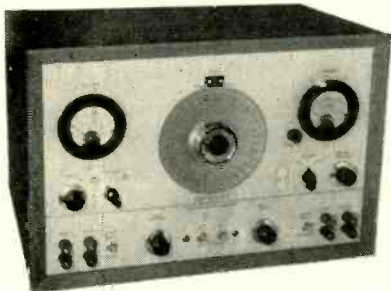

Servoscope has been built for engineers BY engineers. It is one of a line of tools and techniques we have developed for our own use in successfully solving many of the same kind of problems as those facing you. Servoscope solves your servomechanism design problem in applications for INDUSTRY—GOVERNMENT—EDUCATION.

Servoscope is a versatile test instrument for use in the development of all types of servomechanisms and process controls. Transfer characteristics, frequency response, phase lag or lead become available continuously and instantly. Servoscope furnishes test signals and functions as an amplitude-phase comparator. Complete frequency response data may be plotted quickly and accurately. If a minor change is made in the Servo under test, the effect of the change may be readily gauged without actually plotting the curve. Thus rapid servo analysis is the keynote. It will solve problems such as determining operations under flight conditions and resolve the problem of equipment meeting specs quickly and accurately. Indispensable equipment for scientists, development and test engineers.

PERFORMANCE SPEC • Operates on any signal carrier from 50 to 800 cps • Carrier modulation from .1 to 20 cps • Sinusoids from .1 to 20 cps for testing D. C. servos • Square waves from .1 to 20 cps • (Model B from .15 to 30 cps) • Amplitude range 0 to 25 volts RMS • Two-phase reading methods: pattern shift or rotating pattern • Frequency calibration: accuracy 1.5% • Phase lead or lag accuracy 1 degree • X-axis switch to select either phase-reading method • Y-axis switch to by-pass at will servo under test • Synchronized electronic linear sweep 0 to 150 volts • Dimensions: length 21", height 14", depth 15" • Net weight 55 lbs • Shipping weight 75 lbs.

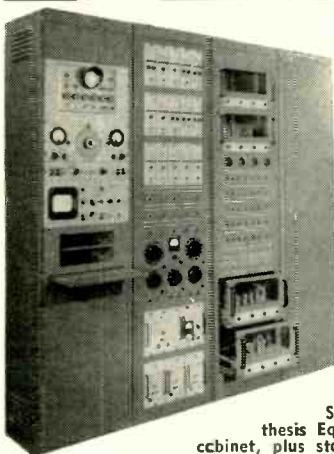

SERVO LABORATORY Analysis & Synthesis Equipment

The Servo Laboratory Analysis and Synthesis Equipment includes a selected list of equipments required in the Servo Test and Development Laboratory. These equipments are grouped in a carefully arranged package to permit the servo designer readily to synthesize a wide variety of systems from standard components and test them with maximum efficiency and time economy. Complete flexibility is provided by standardized interchangeable, plug-in electronic components and efficient and versatile mechanical breadboards. Electrical interconnections are facilitated by terminating the various circuits in jack panels which can be quickly cross-connected by patch cords as desired.

SERVO SYNTHESIS EQUIPMENT: Servo Laboratory Analysis and Synthesis Equipment as shown comprise 3 basic units and 1 associated storage cabinet, plus standardized plug-in servo components for synthesizer panels. Servo Synthesis Equipment is available in sizes ranging from individual assembly panels to multiple cabinet groups. Write concerning your requirements.

ANALYZER CABINET . . . 1 servoscope, 1 cathode ray indicator (D.C.), 1 cathode ray oscilloscope, 1 sliding desk.

SYNTHESIZER CABINET . . . 3 servo synthesizer panels, 3 jack panel assemblies, 1 variable A.C. supply panel, 1 plate and filament supply panel (2 units), 1 regulated power supply panel (3 units).

SERVOBOARD ASSEMBLY CABINET . . . 4 servoboard assemblies, 5 jack panel assemblies, 1 power distribution panel, 1 precision attenuator assembly.

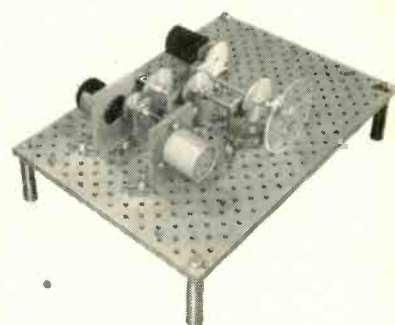

SERVOBOARD — Experimental Mechanical Component Group

The Servoboard is a set of standard precision mechanical parts, including gears, shafts, bearings, hangers and mounting plates, which, when coupled to the necessary motors, tachometers, synchros, potentiometers and amplifiers, rapidly builds a flexible experimental mechanical assembly of a servo system, computer or regulator. The Servoboard was developed as an aid to the design of servomechanisms by providing means for quickly synthesizing the electro-mechanical parts of the control system.

SERVOBOARD COMPONENTS

1 Each—Anodized aluminum plate 1/2" thick, 12" x 17" drilled mounting holes, assembled with legs.

1 Set—Precision ball bearing shaft hangers, shaft 2" off base. Anodized aluminum, shielded ball bearings .25" bore. 4 double bearing type hangers, 6 single bearing type hangers.

1 Set—Stainless steel ground shafts .25" O.D. with ground flat for set screws.

4—Shaft 1 3/8" long 4—Shaft 6" long
 8—Shaft 3" long 4—Shaft 8" long

1 Slip clutch, adjustable friction. Clutch arranged in middle of 3" shaft and may be used in place of standard 3" shaft.

1 Set—Pinion gears with integral shaft 3" long .25" o.d. with ground flat for set screws. Pinion gears—2-12 teeth, 2-16 teeth.

1 Set—Anodized, precision cut 48 pitch aluminum gears, hub for .25" o.d. shafts, with set screws. 2 each with 20, 28, 32, 36, 40, 48, 64, 80, 84, 96, and 108 teeth. (22 gears)

1 Set—Hardware and accessories
 25 Stainless steel clamps, necessary screws, nuts and washers for holding shaft hangers.

1 Gear stand to store gears when not in use.
 1 Storage case.



60 CYCLE SERVO AMPLIFIER A Two-Phase Motor Control

Consists of 3 amplifier stages, phase-inverter and push-pull output stage. Control signals connected by means of front panel plug to a network assembly as a convenient means of changing the network summing resistors should application require. 3 matched .33 meg. summing resistors supplied permit operation as a position servo with tachometer stabilization or as a rate servo. Control signals must be in phase. Amplifier output phase is shifted 90° from the power line phase. Power output is 10 w.

TUBE COMPLEMENT: 1—12AX7 amplifier; 1—12AU7 amplifier-inverter; 1—5Z4 power rectifier; 1—6A2 regulator; 2—6V6 power amplifier.

Fuse: 115 volts, 1 amp.

Dimensions: 12" deep, 7 1/4" wide, 10" high.



Plug in Type or Enclosed Mounting

RELUCTANCE AMPLIFIERS 60 and 400 Cycle Models

Plug-in Type or Enclosed Mounting

8 or 18 watts output
 Lighter • Smaller
 High Gain • Rapid Response
 No Power Supply Needed

Stable Performance
 Internal Error Rate Damping
 Typical 400 Cycle 18 Watt Unit
 Dimensions: 5 3/4" x 3 1/2" x 3 1/4" high
 Weight: 2 lbs. 8 ozs.

This is a NEW
SERVO AMPLIFIER
 Not a Magnetic Amplifier
 Patent Pending

THE NATIONAL VARNISHED PRODUCTS CORP.

Telephone: Rahway 7-8800

Cable Address: NATVAR, Rahway, N. J.

201 RANDOLPH AVENUE

WOODBIDGE, NEW JERSEY

MANUFACTURERS OF



FLEXIBLE INSULATION

NATVAR FLEXIBLE ELECTRICAL INSULATING MATERIALS

STANDARDS Natvar insulations have excellent electrical and physical properties, and meet the requirements of ASTM, NEMA, and other applicable standards with ease. These industry standards for such properties as dielectric strength, tensile strength, heat and oil resistance, as determined by specified test procedure, protect the buyer against inferior materials. At the same time, they provide the buyer with a valid basis for comparison which should enable him to buy quality materials best suited to his needs. Full test reports on Natvar insulations are available on request.

PERFORMANCE Performance is the prime consideration in the manufacture of Natvar insulations. New materials and new methods are constantly being studied and developed to provide improved performance under service conditions. As an example, Natvar 400 extruded vinyl tubing, accepted for its high heat resistance (approved for 105°C) is also outstanding in its resistance to oil, and shows no tendency toward embrittlement when immersed in hot oil for prolonged periods. From the standpoint of performance this is important, because it means that leads insulated and protected with Natvar 400 stay flexible after varnish baking.

UNIFORMITY Natvar insulations give extra protection because of their exceptional uniformity. This uniformity also means that Natvar insulations can be depended upon to be the same, no matter when or where the order is placed.

CONTROL Raw materials, fabrics and papers are laboratory checked against our specifications. Materials in process are subject to constant laboratory control. Both plant and equipment are modern. Natvar insulations are made by experienced production men.

SERVICE Shipments of Natvar standard insulations are usually made on the same day the order is received either from distributors' stock or direct. Orders for special insulations are handled promptly. For problems where special insulations are required to meet unusual conditions, engineering service is available, without obligation. To expedite shipment, give complete detail with each order.

VARNISHED CAMBRIC

Straight cut for application on regular smooth surfaces; bias for irregular surfaces. Supplied in all normal commercial sizes and thicknesses, in yellow or black, and in four finishes, greasy, tacky, dusty and dry. Physical and electrical properties comply with ASTM Specifications with ample safety factor.

VARNISHED CAMBRIC TAPE

Supplied straight cut or seamless bias, in all normal widths and thicknesses, yellow or black, greasy, tacky, dusty or dry. Characteristics same as for VC. Accurately slit for use in taping heads.

VARNISHED CANVAS AND DUCK

For use where greater mechanical protection is required. High strength fabrics coated with same high grade varnishes as VC.

VARNISHED SILK

For use where requirements call for very thin, high dielectric insulation.

VARNISHED SPECIAL RAYON

For use where high tensile and high dielectric strength are required in addition to smoothness and minimum clearance.

VARNISHED FIBERGLAS

Natvar Varnished Fiberglas is Class B insulation for equipment which operates at temperatures above normal safe working range of varnished cambric. Has great mechanical strength and excellent dielectric properties. Available in rolls, tape and full width sheets to 36".

SILICONE COATED FIBERGLAS

For higher permissible temperatures. Available in tape, sheets and rolls 36" wide.

SLOT INSULATION

Combination of Copaca 100% rag paper stock to which a layer of Natvar VC is firmly bonded. The high dielectric strength and moisture resistance of Natvar VC together with the toughness and abrasion resistance of 100% rag paper make a slot insulator which will withstand pounding and chafing without impairment of its electric properties. Rolls or sheets approximately 36" wide.

VARNISHED PAPERS

Chemically inert rope and kraft stocks selected for uniform thickness, tensile and dielectric strength and for freedom from pinholes. In yellow varnished, condenser type tissues and yellow or black varnished heavy papers.

SATURATED SLEEVING

Smooth rayon or Fiberglas braid, single, double or triple saturated with varnish or synthetic. Flexible and smooth for fast application to soft or stranded leads. Wide range of vivid colors for coding. All sizes.

VARNISHED AND LACQUERED TUBING

Smooth rayon or Fiberglas braid impregnated and coated with varnish, or coated with lacquer, in a continuous coating. Exceptionally smooth and flexible. Meets ASTM and NEMA Specifications with ample margin. Several grades to meet various dielectric, aging and heat endurance requirements. Also in heavy-wall cotton braid where higher mechanical strength is required and O.D. is not a limiting factor. Vivid colors for coding. All sizes.

EXTRUDED VINYL TUBING AND TAPE

Natvar 400, for applications requiring high resistance to both heat and oil, is approved by Underwriters' Laboratories for continuous operating temperatures of 105°C. and stays flexible when immersed in hot oil for prolonged periods. It is a well balanced tubing that is tough, elastic, flexible, resistant to abrasion and tear, inert and resistant to oils, waxes, alkalies, acids and most solvents. Available in black, white, transparent and several colors.

V.I.T. 200 is an all-purpose tubing with excellent flexibility through a temperature range of -40°C. to +85°C. Melts at high temperatures but will not support combustion. Shows no disintegration or flaking when immersed in oil. In general has the same inherent characteristics as Natvar 400, but slightly higher tensile strength, averaging 3600 p.s.i.

IDENTIFICATION MARKERS

Short sleeves of varnished braid or extruded vinyl, marked with numbers or letters or both for identifying terminals of complex wiring systems, such as airplane ignition systems. Wide color range, any size, any marking.

SPECIAL PRODUCTS

Our laboratory, manufacturing facilities and engineers are at your service to help with problems not solved by standard materials.

In this panel are illustrated standard models of HELIPOT multi-turn and single-turn precision potentiometers—available in a wide range of resistances and accuracies to fulfill the needs of nearly any potentiometer application. The Beckman DUODIAL is furnished in two designs and four turns-ratios, to add to the usefulness of the HELIPOT by permitting easy and rapid reading or adjustment.

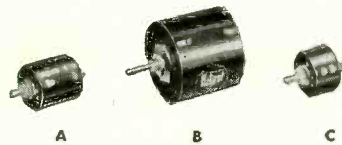

MODELS A, B, & C HELIPOTS
 A—10 turns, 46" coil, 1-13/16" dia., 5 watts—resistances from 10 to 300,000 ohms.
 B—15 turns, 140" coil, 3-5/16" dia., 10 watts—resistances from 50 to 500,000 ohms.
 C—3 turns, 13-1/2" coil, 1-13/16" dia., 3 watts—resistances from 5 to 50,000 ohms.

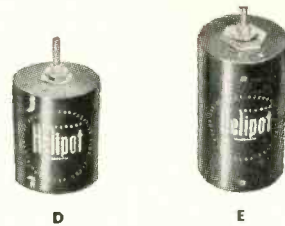

MODELS D AND E HELIPOTS
 Provide extreme accuracy of control and adjustment, with 9,000 and 14,400 degrees of shaft rotation.
 D—25 turns, 234" coil, 3-5/16" dia., 15 watts—resistances from 100 to 750,000 ohms.
 E—40 turns, 373" coil, 3-5/16" dia., 20 watts—resistances from 200 ohms to one megohm.



MODELS F, G AND J PRECISION SINGLE-TURN POTENTIOMETERS
 Feature both continuous and limited mechanical rotation, with maximum effective electrical rotation. Versatility of designs permit a wide variety of special features.
 F—3-5/16" dia., 5 watts, electrical rotation 359°—resistances 10 to 100,000 ohms.
 G—1-5/16" dia., 2 watts, electrical rotation 356°—resistances 5 to 20,000 ohms.
 J—2" dia., 5 watts, electrical rotation 357°—resistances 50 to 50,000 ohms.

LABORATORY MODEL HELIPOT

The ideal resistance unit for use in laboratory and experimental applications. Also helpful in calibrating and checking test equipment. Combines high accuracy and wide range of 10-turn HELIPOT with precision adjustability of DUODIAL. Available in eight stock resistance values from 100 to 100,000 ohms, and other values on special order.



MODELS R AND W DUODIALS
 Each model available in standard turns-ratios of 10, 15, 25 and 40 to 1. Inner scale indicates angular position of HELIPOT sliding contact, and outer scale the helical turn on which it is located. Can be driven from knob or shaft end.
 R—2" diameter, exclusive of index.
 W—4-3/4" diameter, exclusive of index. Features finger hole in knob to speed rotation.

FOR PRECISION POTENTIOMETERS

come to **Helipot**

...world's largest manufacturer of such equipment!

For many years The HELIPOT Corporation has been a leader in the development of advanced types of potentiometers. It pioneered the *helical* potentiometer—the potentiometer now so widely used in computer circuits, radar equipment, aviation devices and other military and industrial applications. It pioneered the *DUODIAL**—the turns-indicating dial that greatly simplifies the control of multiple-turn potentiometers and other similar devices. And it has also pioneered in the development of many other unique potentiometric advancements where highest skill coupled with ability to mass-produce to close tolerances have been imperative.

In order to meet rigid government specifications on these developments—and at the same time produce them economically—HELIPOT* has perfected unique manufacturing facilities, including high speed machines capable of winding extreme lengths of resistance elements employing wire even less than .001" diameter. These winding machines are further supplemented by special testing facilities and potentiometer "know-how" unsurpassed in the industry.

So if you have a problem requiring precision potentiometers your best bet is to bring it to The HELIPOT Corporation, world's largest manufacturer of such equipment. A call or letter outlining your problem will receive immediate attention!

*Trade Marks Registered

The versatility of the potentiometer designs illustrated above permit a wide variety of modifications and features, including double shaft extensions, ganged assemblies, the addition of a multiplicity of taps, variation of both electrical and mechanical rotation, special shafts and mounting bushings, high and low temperature operation, and close tolerances on both resistance and linearity. Examples of potentiometers modified for unusual applications are pictured at right.

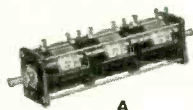

3-GANGED MODEL A HELIPOT AND DOUBLE SHAFT MODEL C HELIPOT
 All HELIPOTS, and the Model F Potentiometer, can be furnished with shaft extensions and mounting bushings at each end to facilitate coupling to other equipment. The Model F, and the A, B, and C HELIPOTS are available in multiple assemblies, ganged at the factory on common shafts, for the control of associated circuits.

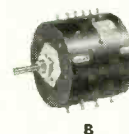

MULTITAPPED MODEL B HELIPOT AND 6-GANGED TAPPED MODEL F
 This Model B Helipot contains 40 taps, placed as required at specified points on coil. The Six-Gang Model F Potentiometer contains 19 additional taps on the middle two sections. Such taps permit use of padding resistors to create desired non-linear potentiometer functions, with advantage of flexibility, in that curves can be altered as required.

THE Helipot CORPORATION, SOUTH PASADENA 7, CALIFORNIA

Field Offices: Boston, New York, Philadelphia, Rochester, Cleveland, Detroit, Chicago, St. Louis, Los Angeles and Fort Myers, Florida. Export Agents: Fratham Co., New York 18, N.Y.

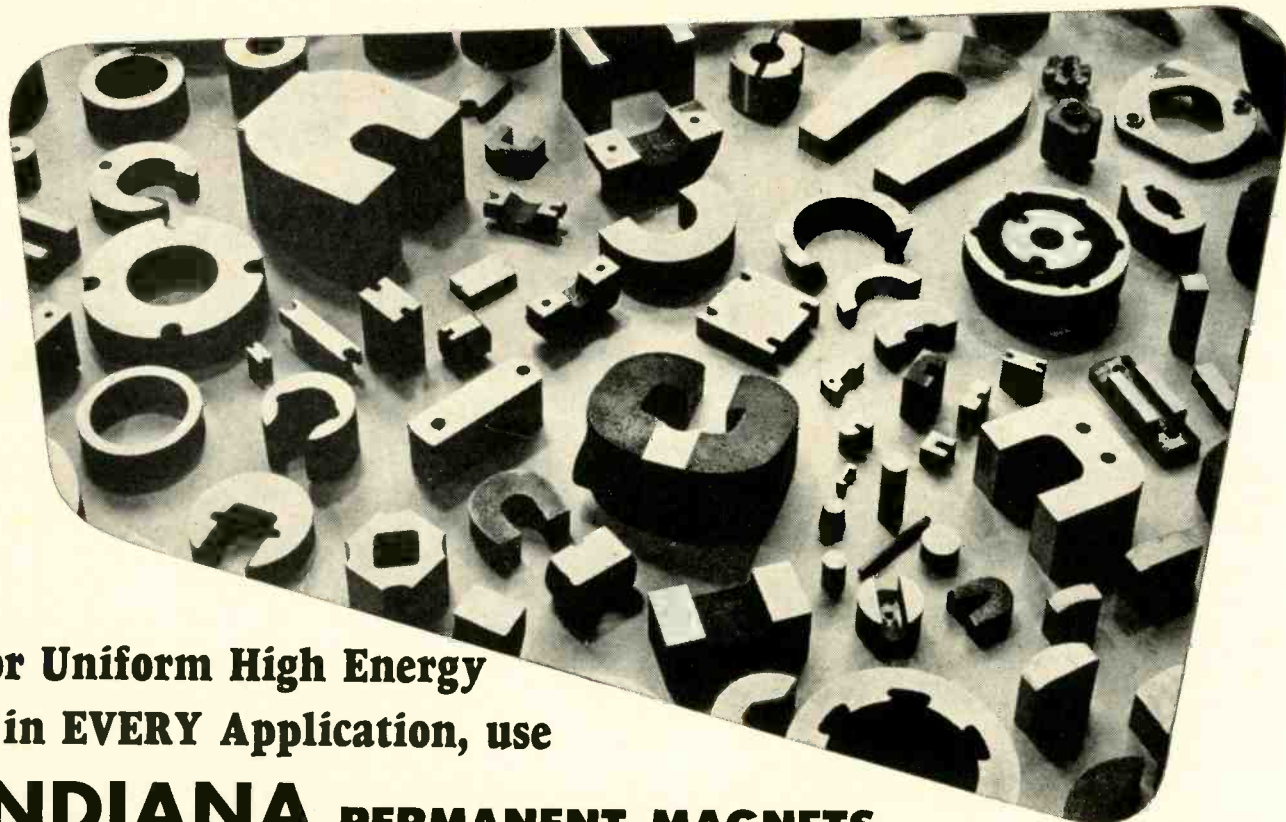

**For Uniform High Energy
in EVERY Application, use**

INDIANA PERMANENT MAGNETS



THIN-WALL ALNICO RINGS

All sizes of ring-type permanent magnets for television focus coils. Indiana quality assures a strong magnetic field.

"ION-TRAP" PERMANENT MAGNETS

Permanent magnets to deflect electrons out of the ion-electron stream. Made of Alnico and Cunife in all diameters and forms.

PERMANENT MAGNETS FOR PHONOGRAPH PICK-UPS

Indiana permanent magnets for transforming mechanical energy into electrical energy cover the full range of physical properties, sizes, and shapes. For phonograph pick-ups, microphones, electric organs, etc.

PERMANENT MAGNETS FOR SPEAKERS

Indiana permanent magnets for transforming electrical energy into mechanical energy in loud speakers, telephone receivers, polarized vibrators, electric clocks, etc. Indiana has the right permanent magnet for each need.

PERMANENT MAGNETS FOR INSTRUMENTS, RELAYS, AND CONTROLS

A complete variety for ammeters, galvanometers, light meters, voltage regulators, switches, polarized relays, etc. Indiana brings you the latest methods and techniques.

PERMANENT MAGNET SUB-ASSEMBLIES

Assemblies, of which the permanent magnet is a part, designed to meet your specifications. Furnished for all requirements.

● Look to INDIANA for *quality* permanent magnets—for skill in manufacture—for cost-cutting engineering aid. Strict supervision in every step of production is your assurance of exact magnetic and mechanical characteristics.

ALL MATERIALS • ALL SIZES • ALL SHAPES

INDIANA—the world's largest exclusive producer of permanent magnets, and the only manufacturer furnishing *all commercial grades* of permanent magnet alloys—has the know-how and facilities to develop and produce the permanent magnets you require. More than 30,000 different needs have been met successfully by INDIANA "packaged energy." Write today.

Sales Offices Coast to Coast

Boston 16, Mass., 258 Park Square Building.
Chicago 2, Ill., 6 N. Michigan Ave.
Cleveland 14, O., 508 Hippodrome Building.
Los Angeles 15, Calif., 1151 S. Broadway.
New York 17, N. Y., 51 East 42nd Street.
Philadelphia 7, Pa., Real Estate Trust Bldg.
Rochester 4, N. Y., 519 Sibley Tower Bldg.

INDIANA'S wide variety of magnet alloys permits precise selection.

CAST
Alnico, I, II, III,
IV, V, VI, XII
Cobalt
Cunico
Indalloy
SINTERED
Alnico II, IV, V
Indalloy
Vectolite
DUCTILE
Cunico
Cunife I, II
Silmanal
FORMED
Chrome
Cobalt
Tungsten

**INDIANA
PERMANENT
MAGNETS**

THE INDIANA STEEL PRODUCTS COMPANY
VALPARAISO, INDIANA

SPECIALISTS IN "PACKAGED ENERGY" SINCE 1908

PRACTICALLY PURE DIRECT CURRENT—Less than 1/4 of 1% Ripple

Bogue Low Ripple DC Generators

for:

1. High Power Electronic Equipment
2. Testing of High or Low Power Electronic Equipment
3. Telephone Exchange Battery Charging
4. Cyclotron Power and similar applications

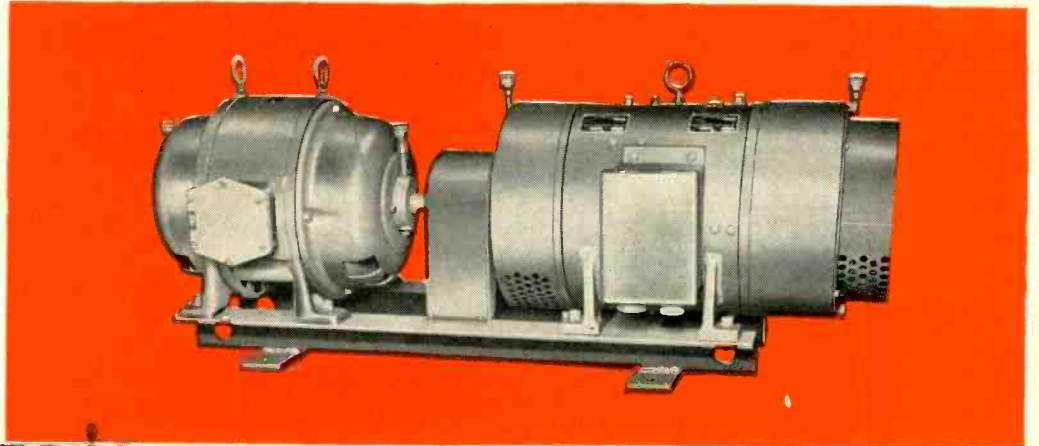

Bogue
25KW, 1000 Volt
Control Panel



Bogue Electric produces a line of AC/DC Motor-Generator Sets whose DC output contains less than 1/4 of 1% ripple, with some designs as low as 1/10 of 1%. This excellent performance is secured by precision design, care in selection of materials, and quality control in manufacture.

The units are made in sizes from 1KW to 25KW and in voltages from 6 to 1000 or higher if required. If extreme accuracy in output voltage is required the sets can be equipped with Bogue Magnetic Amplifier (Static) Voltage Regulators which will hold the DC output voltage constant to within 1/10 of 1% over the full range from no load to full load. If you have problems along these lines please consult our engineering department.

BOGUE ELECTRIC MANUFACTURING COMPANY

Where Precision Coordinated Design... Counts!

50 IOWA AVENUE

PATERSON 3, NEW JERSEY

MAGNETIC AMPLIFIERS • MAGNETIC CONTROLLERS • AC & DC MOTORS
AC & DC GENERATORS • VOLTAGE & SPEED REGULATORS • SWITCHBOARDS

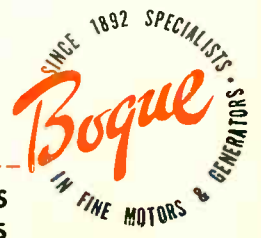

BOGUE PRECISION POWER

Standard Crystals for EVERY FREQUENCY CONTROL APPLICATION

Produced to Meet
All Military and
Commercial Specifications

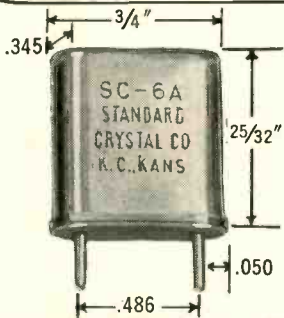

Freq. range 800 KC to 100 MC.
Stab. .002% from -55 to 90°C.



Standard Octal Base

Temperature controlled oven, type TC-68, for single SC-6A crystal. For dual frequency operation, specify type TC-268.

Operating Temp. 85°C.
Rating 6.3 V. at 1 Amp.
Stability, .0001%

The modern facilities for research, development and production maintained by the Standard Crystal Company is your assurance that your "custom built" crystals will always meet your exacting requirements and be processed by the latest manufacturing techniques. Feel free to contact us on any of your crystal problems. Complete details will be forwarded by return mail.

Send for
Our
New
Catalog

Our complete standard line of crystal units covers the frequency range from 1000 Cycles to 100 Megacycles.



STANDARD CRYSTAL COMPANY
400 ARMSTRONG
KANSAS CITY 1, KANSAS

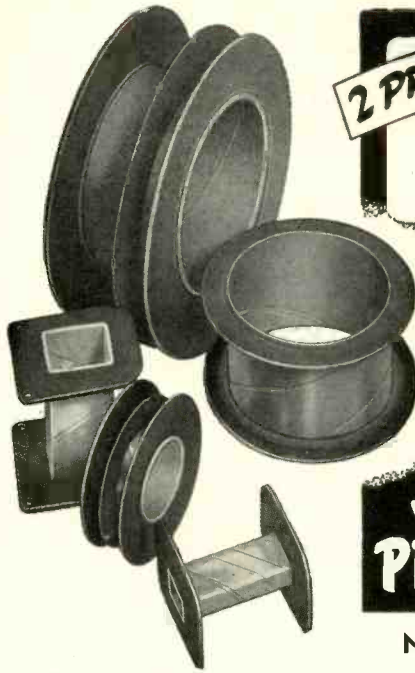

2 PROBLEMS

1. How can I strengthen the magnetic field without increasing the size of my coil?
2. How can I reduce resistance, and hold my coil to the same space?

2 ANSWERS!

1. More winding of same gauge on same size coil base.
2. Larger gauge wire on same size coil base.

when you use PRECISION BOBBINS

NO INSULATION STRIPS NEEDED

Each winding layer fits snugly into the one below. This permits use of minimum coil size, yet provides adequate windings—enables you to cut costs substantially.

Precision Bobbins are spirally wound and heat-treated for extra strength; tube ends swaged to firmly lock vulcanized flanges. The entire Precision Bobbin is impregnated to meet Underwriters' requirements.

SEND FOR SAMPLES TODAY!

PRECISION PAPER TUBE CO.

2041 W. Charleston St.
Chicago 47, Ill.

Plant No. Two, 79 Chapel St., Hartford, Conn.

Also Mfrs. of dielectric paper tubes

Sherman ELECTRICAL FITTINGS

A dependable source of supply with large capacity for terminals, lugs, fuse clips, etc., many of which are considered standard by government procurement agencies. Write today for complete Sherman Electrical Catalog.

H. B. SHERMAN MFG. CO.
Battle Creek, Mich.



JAN-SPEC

Filters
Servo Controls
Power Supplies
Miniaturization
Wire Assemblies

SUB-CONTRACT

OUR FACILITY
REPORT AVAILABLE
UPON REQUEST

COMMERCIAL

TV-Filters
Radios
Tuners
Amplifiers
Sub-Assemblies

THE ORTHON CORP.

196 ALBION AVENUE

PATERSON 2, N. J.

Telephone: MUIberry 4-5858

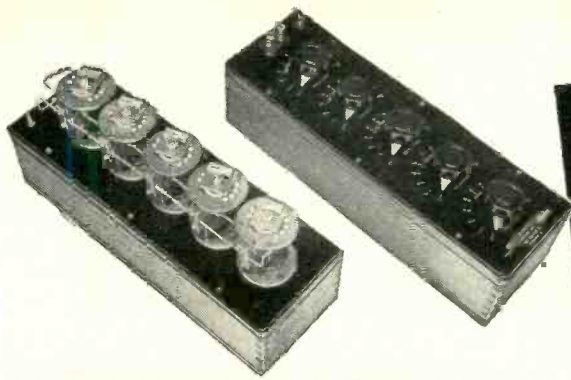

DECADE RESISTANCE BOX TYPE 750

FIRST CALL ON DAVEN

Prime Supplier of
Electronic Instruments
of Unparalleled Quality,
Accuracy and Dependability

In the manufacturing of sensitive, accurate instruments, the reputation of the Daven organization is world wide. For substantially more than a generation, specialization in electronics, coupled with unexcelled development and engineering personnel, has thrust the Daven Company far in the forefront of producers of instruments of notable quality.

Shown on this page is only a small part of the Daven line. When writing for more complete information on the units illustrated, please identify by name and model number.

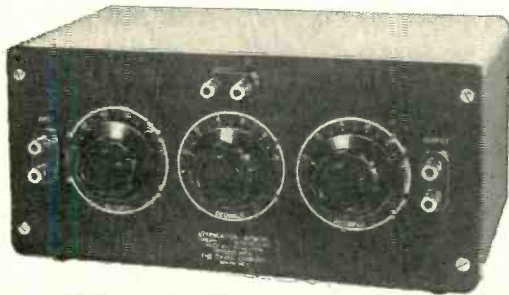

HIGH-FREQUENCY ATTENUATION BOX TYPE 795

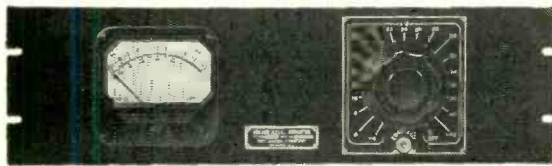

VOLUME LEVEL INDICATOR SERIES 910-911

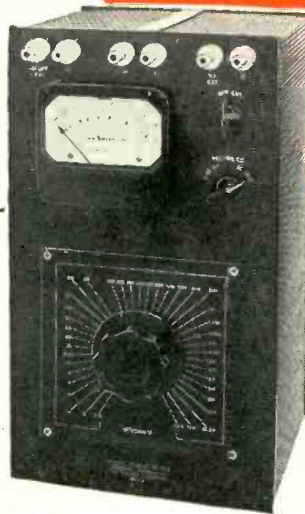

OUTPUT POWER METER
TYPE OP-962

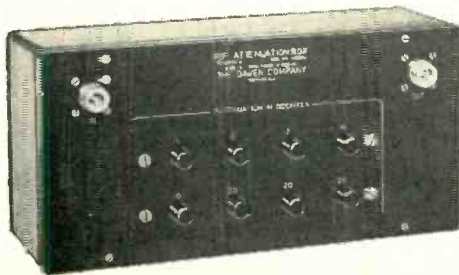

RF ATTENUATION BOX TYPE 650

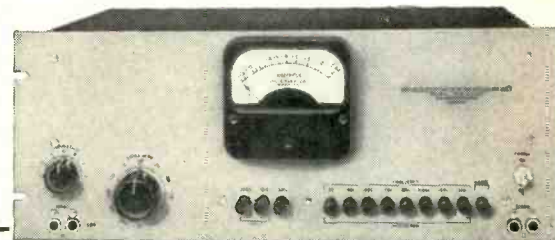

DISTORTION & NOISE METER TYPE 35-A

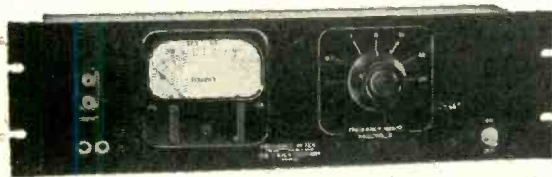

FREQUENCY METER TYPE 838A



ATTENUATION BOX
SERIES 690



Precision equipment demands the finest components. Always specify Daven Attenuators.



GAIN SET TYPE 11A

THE **DAVEN** CO.
191 CENTRAL AVENUE • NEWARK 4, NEW JERSEY

ELECTRONIC SLIDES

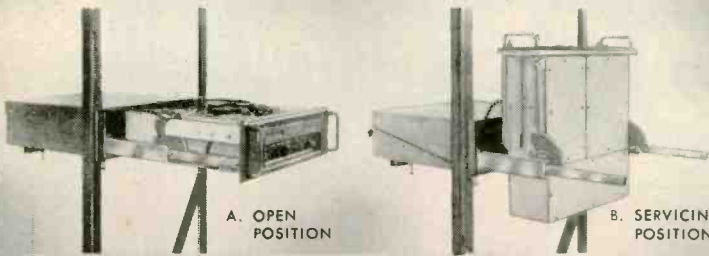

A. OPEN POSITION

B. SERVICING POSITION



Three section slide, progressive action type. Locks in extended position only. Tripping mechanism controls unlocking. Load capacity: Up to 200 lbs. Cat. No. 375

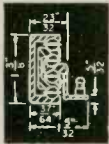
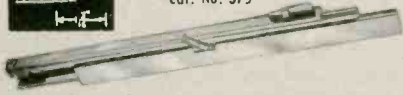

Three section slide, progressive action type. Load Capacity: Up to 50 lbs. per pair. Cat. No. 350



Three section slide, progressive action type. Locks in open and closed positions. Provided with quadrant to allow for tilting to 90 degrees. Load Capacity: Up to 200 lbs. Cat. No. 364



Three section slide, progressive action type. Locks in open position. Slide includes mechanism for unlocking from the outside of chassis and for tilting to 90 degrees. Load Capacity: up to 100 lbs. per pr. Cat. No. 392

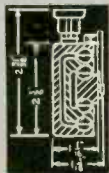

Three section slide, progressive action type. Locks in extended position only. Thumb release controls unlocking. Load Capacity: Up to 200 lbs. maximum. Cat. No. 371



- A. Featuring Smooth continuous action. Closely fitted slide parts assure minimum of play. Locking device holds slide when fully extended, permitting easy access to all parts.
- B. Quadrant for pivot support and tilting provision is equipped with simple tripping mechanism for servicing. Lever operated, it releases chassis and allows movement to open and closed positions.

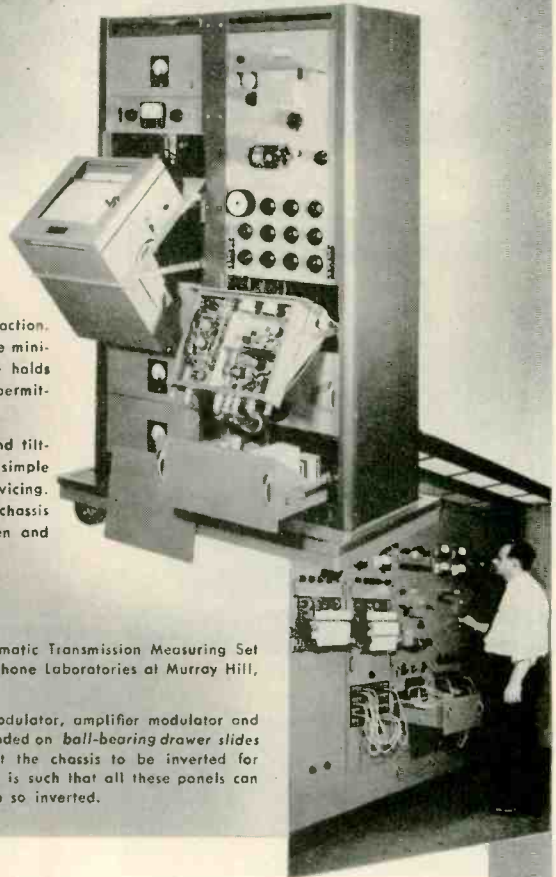

Illustration shows an Automatic Transmission Measuring Set as developed by Bell Telephone Laboratories at Murray Hill, New Jersey.

The receiving amplifier, modulator, amplifier modulator and recorder panels are suspended on ball-bearing drawer slides and are pivoted to permit the chassis to be inverted for servicing. The arrangement is such that all these panels can be kept in operation while so inverted.

The present preparedness program requires that manufacturers be absolutely certain of the precision and dependability of all component parts. Over 50 years of dependability lie behind Grant Pulley & Hardware Co. Our extensive engineering and research department is constantly planning new and improved sliding devices. This department is available for consultation on individual specifications, and also provides engineering liaison from inception to conclusion of production. Chassis, Consoles, Racks, any device where access to parts or motion of equipment is desired should be equipped with Grant Slides. Wherever the installation, laboratory, tank, bomber, ship, mobile or stationary unit . . . you save time and manpower when you use Grant Sliding Devices.

Grant Slides are adaptable for many military uses, and Grant customers with Government contracts can rely upon the dependability of Grant cooperation and delivery.



FOR FURTHER INFORMATION WRITE
ELECTRONIC ENGINEERING DIVISION

GRANT PULLEY & HARDWARE CO.

31-87 WHITESTONE PARKWAY, FLUSHING, N. Y. • FLUSHING-9-1900

The foremost name in Sliding Devices

Precision Built

*for the
Finest Equipment*

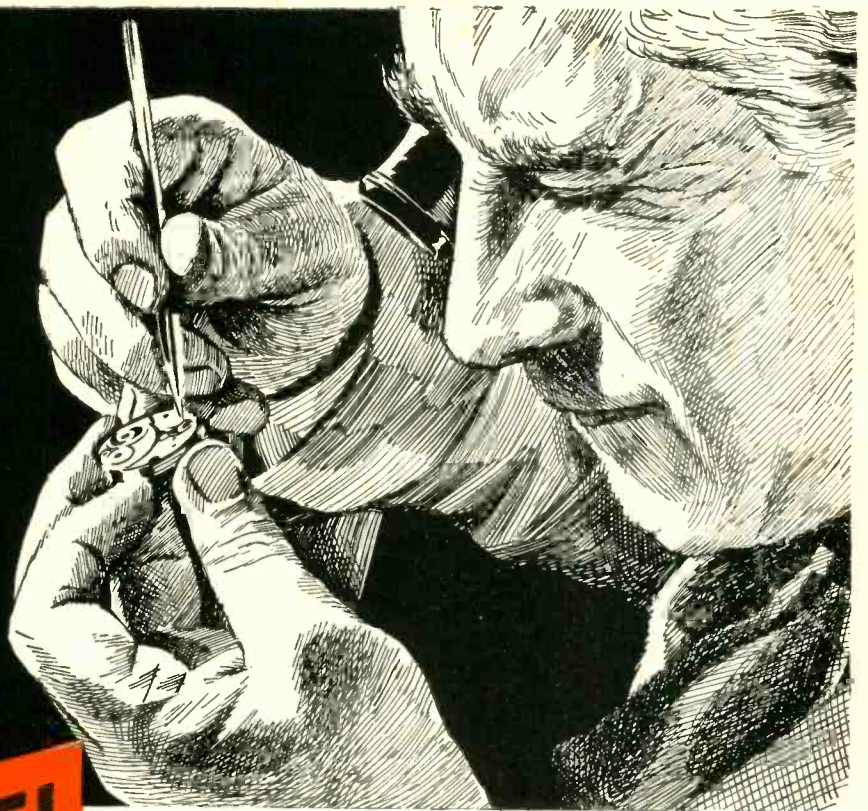

FERRANTI

Transformers

Our long experience in building all types of transformers, including hermetically sealed units, qualifies us as a dependable supply source for transformers used in military applications. We offer sound engineering and faultless craftsmanship . . . custom design with the economy and speed of modern mass production methods.

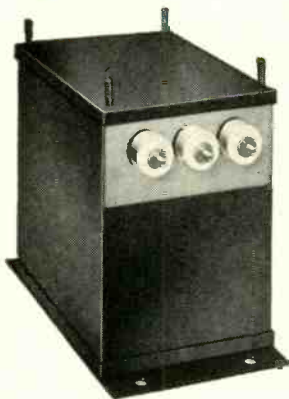

Hermetically Sealed Types for MIL-T-27 applications . . . Special Cores . . . High Temperature Insulation . . . as well as all normal types for every purpose.

FERRANTI ELECTRIC, INC.

30 Rockefeller Plaza, New York 20, New York

There is No Finer Name in Transformers than

FERRANTI



HIGH VACUUM PUMPS

MECHANICAL, OIL SEALED

Almost without exception in the United States and in an increasing number of plants abroad, Kinney High Vacuum Pumps are standard equipment for exhausting lamps and tubes. They also provide low absolute pressures for sintering alloy metals, coating lenses, refining rare metals and producing blood plasma, penicillin and other drugs. They are used effectively wherever a high vacuum pump can be applied including cyclotron evacuation, atom smashing, and condenser vacuum service in power plants. Over 10,000 installations serve a wide variety of fields.

The plungers in Kinney Vacuum Pumps have no contact with cylinder surfaces due to the unique method of automatic lubrication, resulting in a no-clearance pump of extremely long life. Simple and efficient in design, these pumps have established an impressive record for dependability and low cost operation.

SINGLE STAGE VACUUM PUMP MODELS VSD AND DVD

Eight pump sizes cover a capacity range from 13 to 702 cu. ft. per min. with motors from 1/2 to 40 h.p., respectively. VSD556 is furnished air cooled only — other VSD Models either air or water-cooled. All DVD Models furnished water cooled only. Single Stage Pumps on a blank test produce low absolute pressures of 10 microns (.01 mm Hg.) or better.

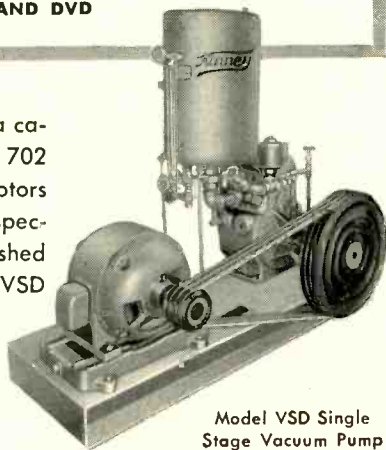

Model VSD Single Stage Vacuum Pump

COMPOUND VACUUM PUMP MODELS CVM 556 AND CVM 8610

Four sizes of Compound Pumps are available in capacities of 2, 4.9 (See New Pumps), 15.2, and 46 cu. ft. per min., respectively. The working mechanism is similar to the Single Stage but the two cylinders are connected in series. The Compound Pump has an air cooled casing of unique design and special provision for oil sealing and lubricating the high vacuum working parts. Both of these compound pumps test to low absolute pressures of 0.5 micron (.0005 mm Hg.) or better.

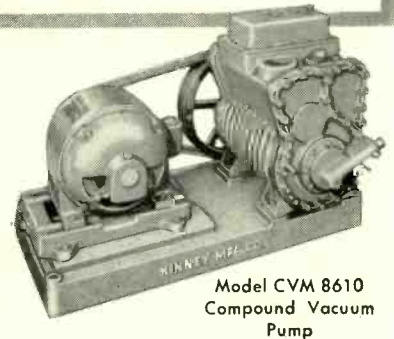

Model CVM 8610 Compound Vacuum Pump

NEW SMALL VACUUM PUMPS MODELS CVM 3153 AND CVM 3534

These new Kinney Vacuum Pumps combine the advantages of small size and high pumping speed. Model CVM 3153 has a free air displacement of 2 cu. ft. per min. It weighs only 70 lbs., complete with its 1/4 h.p. motor. Model CVM 3534 has a displacement of 4.9 cu. ft. per min. Its weight: 140 lbs. with 1/2 h.p. motor. Both pumps test to low absolute pressures of 0.1 micron (.0001 mm Hg.) or better.

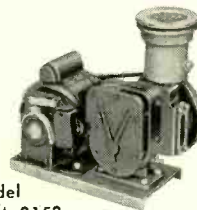

Model CVM 3153



Model CVM 3534

KINNEY VACUUM VALVES — VACUUM OIL

Kinney Vacuum Tight Valves facilitate testing vacuum installations. Special metal bellows eliminate the leakage at the valve stem which occurs with ordinary valves having stuffing boxes. Three types of valves are available — cast steel, cast iron, and bronze. Write for Vacuum Tight Valves Bulletins.

The oil supplied with the Compound Pumps is carefully processed to insure low vapor pressure and suitable viscosity. It is available under the name "Kinney Super X Vacuum Dried Oil."

Ask for Kinney High Vacuum Pump Bulletin V45

KINNEY MANUFACTURING COMPANY

3565 WASHINGTON ST. • BOSTON 30, MASS.
 New York • Chicago • Cleveland • Philadelphia
 Los Angeles • San Francisco • Houston • New Orleans
 Seattle • England • Australia • South Africa
 Switzerland

MORE POWER FOR YOU

in every

Federal
tube

Electronic Vacuum Tubes for all power requirements: Transmitting, Rectifying, Industrial, Special Purpose, Television.



F-892-R

Used in 5 and 10 KW AM transmitters.

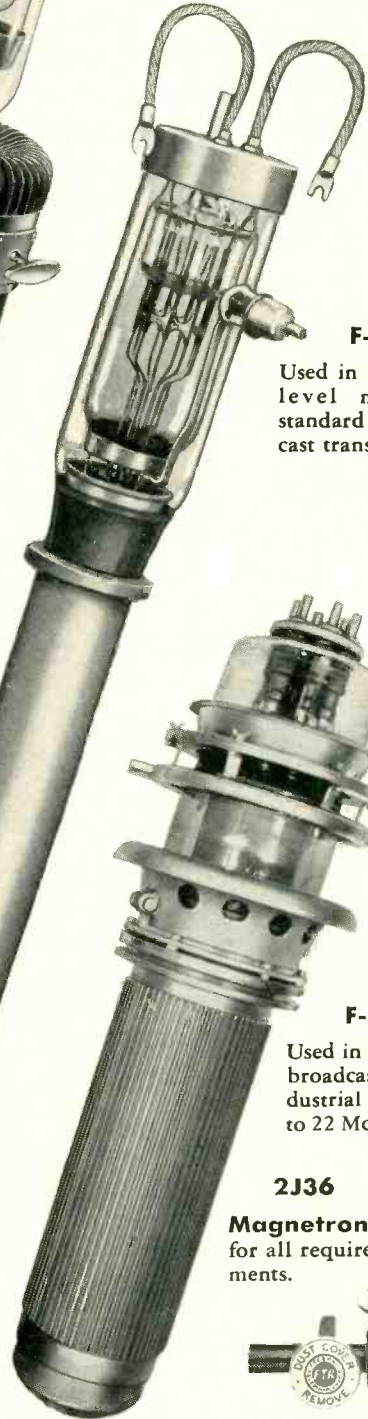

F-862

Used in 50 KW low level modulated standard AM broadcast transmitters.



F-5512

Used in FM broadcasting, industrial and research applications up to 110 Mc.



F-5680

Used in broadcasting and industrial applications up to 50 Mc.



F-124-A

Used in 50 KW AM and short wave transmitters.



Picture Tubes

Rectangular and round screen types: 12½, 14, 16, 17, 19 and 20 inch.



F-134

Used in high power broadcasting and industrial service up to 22 Mc.

2J36

Magnetrons for all requirements.



Federal Telephone and Radio Corporation

100 KINGSLAND ROAD, CLIFTON, NEW JERSEY

In Canada: Federal Electric Manufacturing Company, Ltd., Montreal, P. Q.

Export Distributors: International Standard Electric Corp., 67 Broad St., N. Y.

Federal

High Frequency Coaxial Cables

A complete line of quality cables
for every electronic application

by *Federal...America's Largest Producer of Solid Dielectric HF Cables*

Approved Army-Navy and Special Types for

HF Communications

Television

Industrial Electronics

Aviation

Test Equipment

Radio and TV Lead-In

Radar, Pulse and Experimental Equipment



Single Braid

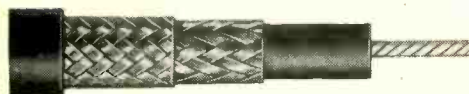

Double Braid



Armored



Air Spaced Low Capacitance

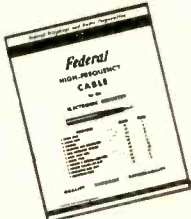

Write for Federal's Data Booklet on HF Cables. An informative guide to characteristics and applications of the industry's most comprehensive line of high quality HF Cables. Address Department D313.



Dual Conductor (Twinax)

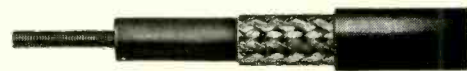

Spiral Delay



Unshielded Lead-In



Shielded Lead-In

Federal

Heavy Duty Selenium Rectifiers

From AC to DC—From Milliwatts to Kilowatts
For Every Industrial Power Conversion Application

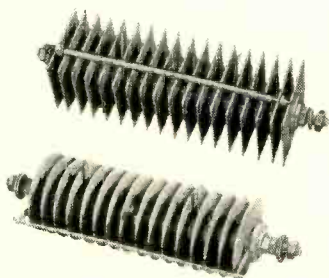
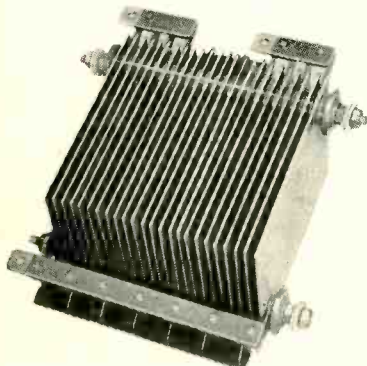

Complete design and application data on America's foremost line of Selenium Rectifiers for industrial service... available in Federal's 36-page Selenium Rectifier Engineering Data Book. Write—on your company letterhead—for your copy today! Address Department F-513



Federal Telephone

Federal

Miniature Selenium Rectifiers

The revolutionary circuit elements that have led the way to important design advances in Television and Radio Receivers and Electronic Equipment

Wherever DC power is required—from 65 Ma. to 450 Ma.—there is a Federal Miniature Selenium Rectifier to do the job... and do it with an efficiency and reliability that is backed by the outstanding reputation of *Federal—America's oldest and largest manufacturer of Selenium Rectifiers.*

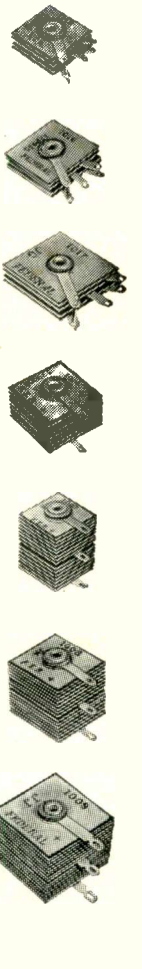
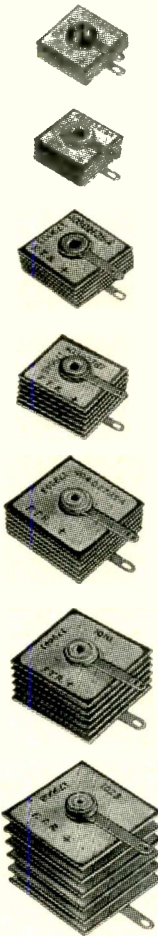



Federal Cat. No.	Federal Code No.	Output MA-DC	Input (RMS) Volts	Input (RMS) MA	Inverse Volts	Peak MA	Plate Size	Application
1097	1097	20	130	50	380	200	1/2" Sq.	B+ Boosters; Bias
1002	402D3452A	65	130	160	380	750	1" Sq.	B+ AC-DC (5 tube)
1903	402D3150A	75	130	220	380	900	1" Sq.	B+ 3-way Radios
1101	1101A	100	130	160	380	750	1" Sq.	B+ Radios, Television
1004	403D2625A	100	130	325	380	1200	1 13/64" Sq.	B+ Radios, Television
1005	403D2787A	150	130	425	380	1200	1 13/64" Sq.	B+ Radios, Television
1006	404D2795A	200	130	550	380	2000	1 17/32" Sq.	B+ Television
1010	404D3450	250	130	625	380	2000	1 17/32" Sq.	B+ Television
1087	1087A	275	130	700	380	2000	1 17/32" Sq.	B+ Television
1890	1090A	300	130	750	380	2000	1 17/32" Sq.	B+ Television
1023	1023	350	130	900	380	3000	1 3/4" Sq.	B+ Television
1130	1130	400	130	1000	380	4000	2" Sq.	B+ Television
1021	439D4200	450	130	1150	380	4000	2" Sq.	B+ Television
1014	403D2889A	100	160	325	440	1200	1 9/32" Max.	Vibrator
1022	439D4300	450	160	1150	440	4000	2" Sq.	B+ Television
1007	402D3239A	75	160*	220	440	900	1" Sq.	Vibrator Doubler
1008	403D3240A	100	160*	325	440	1200	1 13/64" Sq.	Vibrator Doubler
1009	404D3241A	200	160*	550	440	2000	1 17/32" Sq.	Vibrator Doubler
1015	402D3550	150	25	270	35	1800	1" Sq.	Bridge Rectifier
1016	403D3551	300	25	540	35	2400	1 13/64" Sq.	Bridge Rectifier
1017	404D3552	600	25	1080	35	4000	1 17/32" Sq.	Bridge Rectifier
1013	4D2814AS	700	18†	1 17/32" Sq.	Battery Charger
1018	104D2943S	2000	18‡	4 1/4" lg. (Mtg. Plt.)	Battery Charger
1001	402D3151	75	20	220	55	900	1" Sq. (Mtg. Plt.)	Bias Rectifier
1019	N.T.C. Resistor (Resistance: Cold, 1400 ohms, Hot, 200 ohms)							

* These rectifiers have two sections—characteristics given apply to one section only; if both sections are used half-wave, voltage input is 320 volts.

† The characteristics given for this rectifier are based on its use in a half-wave rectifier circuit with a 3-cell battery load.

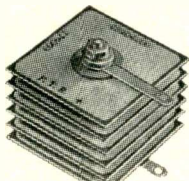
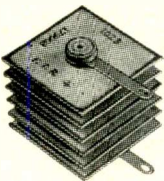
‡ The characteristics given for this rectifier are based on its use in a full-wave rectifier circuit with a 3-cell battery load.





Federal's Miniature Selenium Rectifier Handbook... 48 pages of valuable design, characteristics and application. Available for 25 cents (coin only)

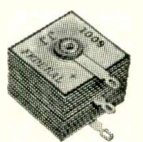
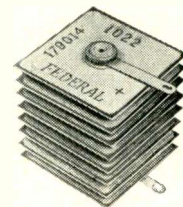

Federal High Voltage Selenium Rectifiers

for Photo-Flash Power Supplies—Cathode Ray Oscilloscopes—Television Circuits—DC Power Supplies—Bias Supplies—High Voltage Testing Equipment—and other applications requiring high voltage at low current.

Federal Code Number	DC Output Voltage	Max. Peak Inverse Voltage	AC Input Voltage	Max. Eff. Inverse Voltage
123D1101	1400	4000	1400	2000
123D1071	1050	3000	1050	1500
123D1126	700	2000	700	1000
123D1182	350	1000	350	500

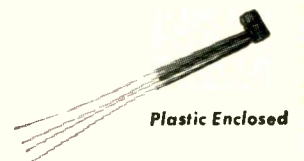

and Radio Corporation

SELENIUM and INTELIN Division, 100 Kingsland Road, Clifton, New Jersey
 In Canada: Federal Electric Manufacturing Company, Ltd., Montreal, P. Q.
 Export Distributors: International Standard Electric Corp., 67 Broad St., N. Y.

VHF
UHF

IMPEDANCE MEASUREMENTS

SPEED AND CONVENIENCE

FTL-42A IMPEDOMETER

Rapid, accurate measurement of impedance, reflection coefficient and standing wave ratio. Small size, convenient for field use.

50 to 500 Mc.

Can be inserted in various sizes of solid coaxial line or flexible cables.

Make three readings; plot diagram and read off impedance to $\pm 5\%$.

\$400.00.

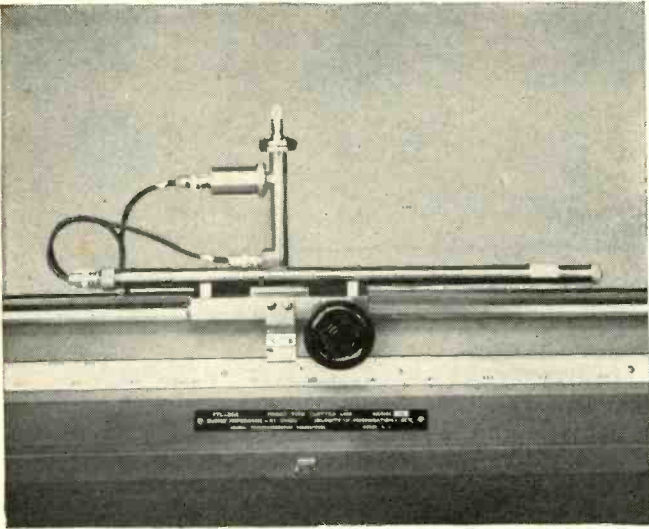

FTL-30A SLOTTED LINE

Precise impedance measurements in the range of 60 to 1000 megacycles per second. Accuracy $\pm 2\%$.

1000 to 2000 Mc range covered with slightly reduced accuracy.

Coaxial line 250 centimeters long having a surge impedance of 51.0 ohms ± 0.5 ohms.

\$2,495.00.

PRECISION

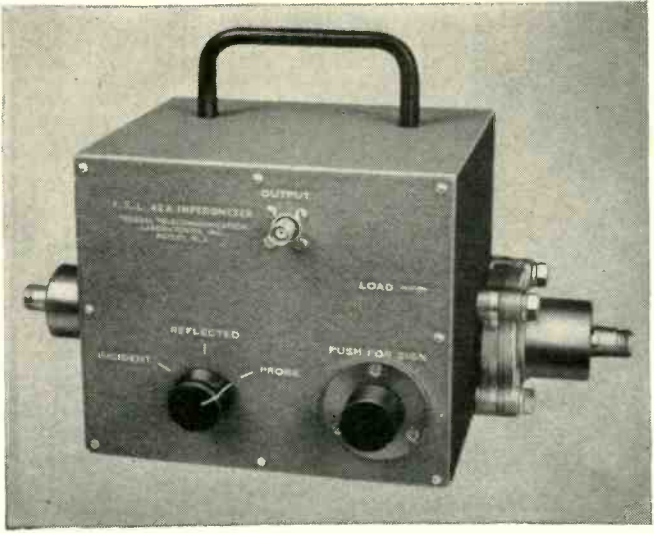

Write for FTL-30A and FTL-42A brochures.

Federal Telecommunication Laboratories, Inc.

500 Washington Avenue
Nutley 10, New Jersey

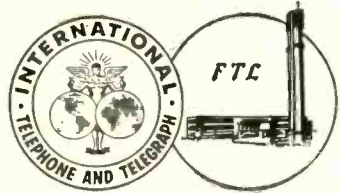

3 plants serving the **ELECTRONIC INDUSTRY**

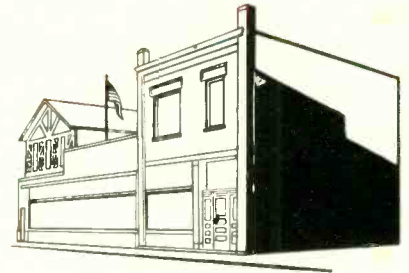
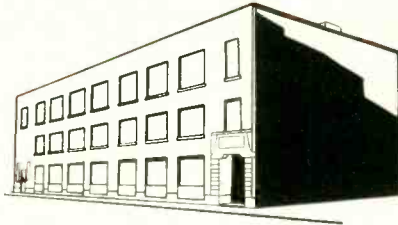

YOU GET THE BEST FROM MIDWEST

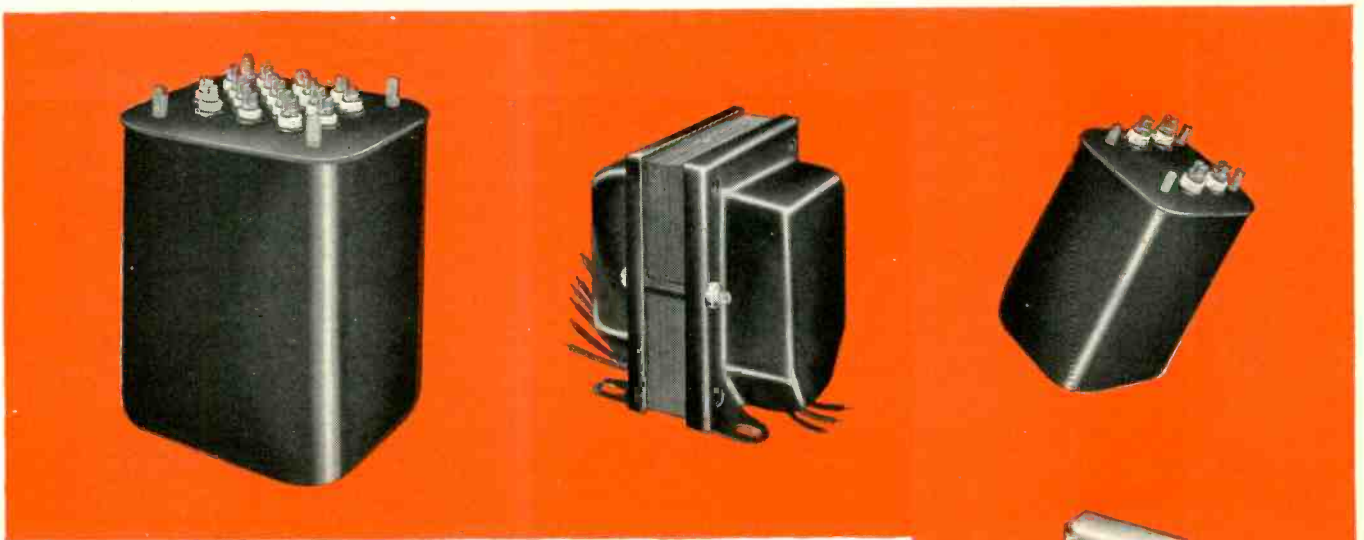

Each modern plant is staffed by experienced personnel employing the latest equipment and electronic knowledge to produce uniform components of consistent quality for television and radio.

Our engineering department is always ready to assist you with any problems. The long association of MID-WEST COIL & TRANSFORMER COMPANY and the electronic industry is your assurance of SERVICE, QUALITY and DEPENDABILITY.

MID-WEST COIL & TRANSFORMER COMPANY is qualified to produce to JAN-T-27 or MIL-T-27 government specifications.

WE INVITE PRIME and SUB-CONTRACT INQUIRIES.



MID-WEST COIL & TRANSFORMER CO.
1642 NORTH HALSTED STREET • CHICAGO 14, ILLINOIS

NEW YORK CITY
270 La Fayette St.

BRANCH OFFICES
BUFFALO (KENMORE)
278 Hamilton Blvd.

PLYMOUTH, INDIANA
805 Pennsylvania

SKL

The Finest In PRECISION EQUIPMENT



MODEL 302
Variable Electronic Filter

FEATURES
Cutoff Range: Continuously variable from 20 cps to 200 KC.
Sections: Two.
Function: High-pass, low-pass, band-pass.
Attenuation Rates: Band-pass max. 18 db per octave. Series max. 36 db per octave.
Insertion Loss: 0 db.

Providing a continuous choice of cutoff frequencies from 20 cps to 200 KC, the Model 302 Variable Electronic Filter consists of two identical filter sections. Each section has 18 db per octave attenuation. A range switch selects either high or low-pass operation and, when the sections are in series, a band-pass connection. An insertion loss of 0 db and a low noise, well-regulated power supply make the Model 302 ideal for use in the aircraft, automotive, moving picture and radio broadcasting industries as well as in many general laboratory applications. Also available: the Model 300 single-section Variable Electronic Filter.



MODEL 212TV—Amplifier

This untuned amplifier has been especially designed for television distribution systems.

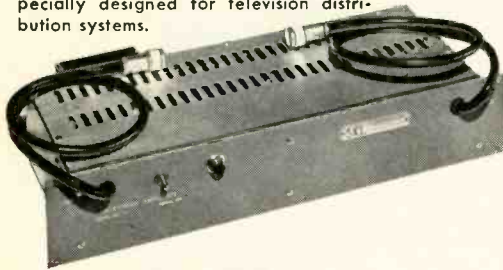

MODEL 202P
Wide-Band Chain Amplifier

A two-stage, traveling wave amplifier designed for high speed pulse amplification.

SPECIFICATIONS

Bandwidth: 100 KC to 200 MC.
Voltage Gain: 20 db.
Impedance: 200 ohms.
Risetime: Less than .003 usec.
Response: ± 1.5 db from 100 KC to 200 MC.
Power Supply: Stabilized, 115 volts, 60 cycles.
Connectors: Standard Type N.
Also available: the Model 200A single-stage, the Model 202 dual-stage.

SPECIFICATIONS

Bandwidth: 40 to 225 MC.
Gain: 20 db.
Impedance: 52 or 72 ohms unbalanced.
Response: ± 2 db from 50 to 220 MC.
Power Supply: 115 volts, 60 cycles.

Designed for use with cathode ray tubes, high speed counters, and other pulse circuits requiring high driving voltages, the Model 214 Chain Pulse Amplifier has a maximum output voltage of 125 volts with a risetime of less than .006 usec. More than one inch of deflection on a cathode ray tube can be obtained for the viewing of high speed pulses. The input impedance of 180 ohms is provided so that the Series 200 Wide-Band Chain Amplifiers may be used where additional gain is required. Supplied with a special output termination at the end of 15' of cable, the input connector is a standard type N for convenient coupling to associated equipment.

MODEL 214
Chain Pulse Amplifier

FEATURES

Response: 40 KC to 100 MC,
 $\pm 1\frac{1}{2}$ db — 50 KC to 80 MC.
Output Voltage: 125 volts max.
Pulse Gain: 30 db.
Input Impedance: 180 ohms.
Rise Time: Less than .006 usec.
Connector: Standard type N.
Power Supply: 115 v., 60 cyc.

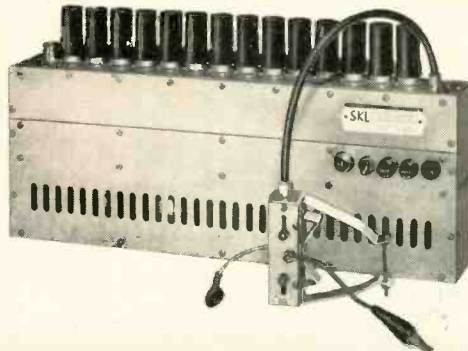

SPECIALISTS IN ELECTRONIC GEARS

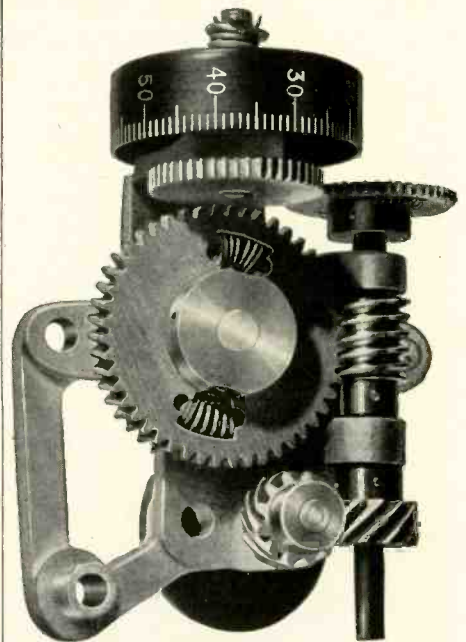

QUAKER CITY GEAR WORKS

1910 N. FRONT ST.
PHILADELPHIA 22, PA.

this BOOK **11th**
year
now in its

has earned industry-wide acceptance as the only complete and accurate source of buying information for all types of electronic and allied products components and complete equipment

In Addition, this year . . .



tells who has what in production or available in a reasonable time and unrestricted for general industrial use.

electronics BUYERS' GUIDE

Please mention this book when buying or inquiring from it.

SKL

SPENCER-KENNEDY LABORATORIES, INC.
181 MASSACHUSETTS AVE., CAMBRIDGE 39, MASS.

Ceramics
Kovar
Metal

STUPAKOFF PRODUCTS

Kovar-Glass
Seals

FOR *Electrical and Electronics Applications*

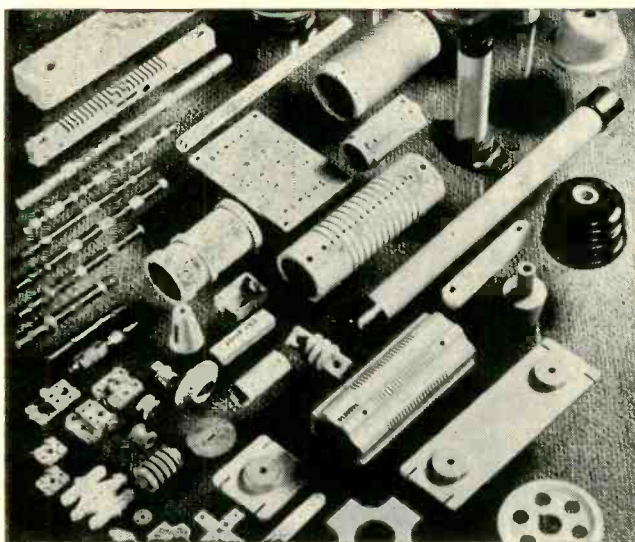

ASSEMBLIES—Stupakoff assemblies include metallized ceramic Induction COILS for radio receivers and transmitters; metallized ceramic SHAFTS for air-tuning condensers; METALLIZED PLATES for making fixed rigid assemblies; ceramic trimmer condensers; printed circuits.

CERAMICS—Stupakoff has long been a leading supplier of ceramic products for a wide variety of electrical and electronic applications—precision made for all voltages, frequencies and temperatures.

RESISTOR CERAMICS—Stupakoff Temperature-Sensitive Resistors are used for temperature indicating or measuring equipment such as Radiosonde, for infra-red light source and for heating elements. Supplied complete with terminals, in the form of rods, tubes, discs, bars, rings, etc.

STUPALITH—A group of ceramics having remarkable ability to withstand extreme thermal shock. STUPALITH may be made to have zero, low-positive or low-negative expansivities. Formed by conventional methods. Safely used at temperatures up to 2200° F.

CERAMIC DIELECTRICS—Stupakoff makes general purpose Ceramic Dielectrics for by-pass, lead through blocking, standoffs and trimmer applications. Temperature compensating Ceramic Dielectrics have coefficients from P-100 to N-2700, and high K materials up to K-6000. Made in the form of tubes, discs and special shapes, plain or silvered.

PRINTED CIRCUITS—Amplifiers, couplings, filters, integrators.

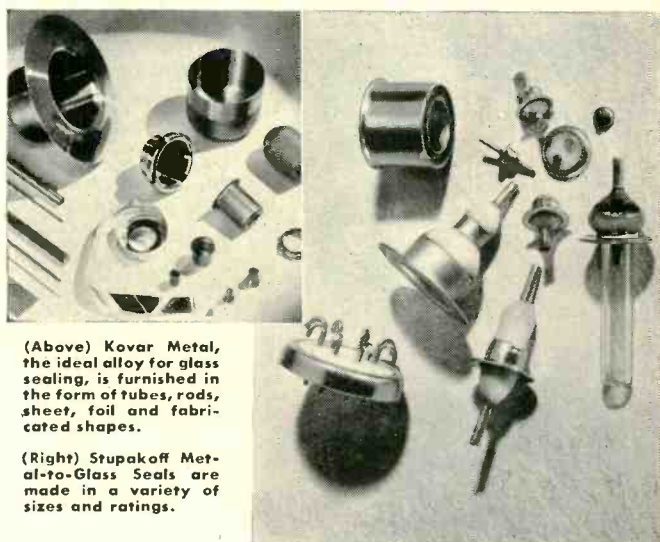

(Above) Kovar Metal, the ideal alloy for glass sealing, is furnished in the form of tubes, rods, sheet, foil and fabricated shapes.

(Right) Stupakoff Metal-to-Glass Seals are made in a variety of sizes and ratings.

SEALS KOVAR-GLASS—Terminals; Lead-ins; Standoffs—for hermetically sealing for mechanical construction in radio, television, electronic and electrical apparatus. Single or multiple terminal units, in a wide variety of sizes and ratings.

KOVAR METAL—Kovar is the ideal alloy for sealing to hard glass. Used for making hermetic attachments for electrical and electronic products. Available in the form of rod, wire, sheet, foil—or as cups, eyelets or other fabricated shapes.

**STUPAKOFF
CERAMIC
AND
MANUFACTURING CO.**

LATROBE, PA.

When You Think of
TOROIDAL COMPONENTS...

Think of
**COMMUNICATION
ACCESSORIES CO.**



UNCASED COILS ADJUSTED TO YOUR SPECIFICATIONS

A wide variety in physical size, power capacity and frequency range is offered. Coils are wound to comply with customers' requirements and specifications. Engineering assistance and suggestions are offered without charge. Coils may be supplied to a tolerance of plus or minus one percent, or matched to a standard inductor to a tolerance of one-tenth percent, or one turn. Coils may be supplied with temperature coefficient of 180 parts per million per degree Centigrade, or may be supplied with 0° C. coefficient through a limited temperature range.

MOISTURE PROOF PLASTIC COATED TOROIDS

To eliminate the possibility of damage to the exposed winding during assembly, we offer toroids coated with tough thermal setting plastic coating. These coated toroids are recommended where coils are subject to high humidity and where coils must be mechanically mounted. Plastic coating is available in all types of toroidal coils.

STEEL CASED TOROIDS AND FILTERS

C.A.C. engineers, with years of experience in the design of filter networks are at your service to design or help you design the proper networks for your requirements. Where space requirements are severe, filters may be miniaturized by the use of wedding ring toroids and special capacitors. Typical filter cases are shown. However, cases may be fabricated to your specifications.

Write for our
latest catalog ➔



COMMUNICATION ACCESSORIES
Company

HICKMAN MILLS, MISSOURI

Hold on to this book

It will be
June 1952
before another
edition is published

**IT IS THE MOST COMPLETE,
AUTHORITATIVE AND UP-TO-DATE
DIRECTORY OF ELECTRONIC AND
ALLIED PRODUCTS AVAILABLE.**

It gives you the manu-
facturers of each of
more than fourteen
hundred electronic
and allied products.



... gives you information
as to where they are in pro-
duction or available in a
reasonable time and unre-
stricted for general indus-
trial use.

1951-1952

electronics BUYERS' GUIDE

Please mention this book when
buying or inquiring from it.

ONE STANDARD — *The best that can be made* —
For Initial Equipment and Replacement



TUNG-SOL

RADIO, TV TUBES, DIAL LAMPS

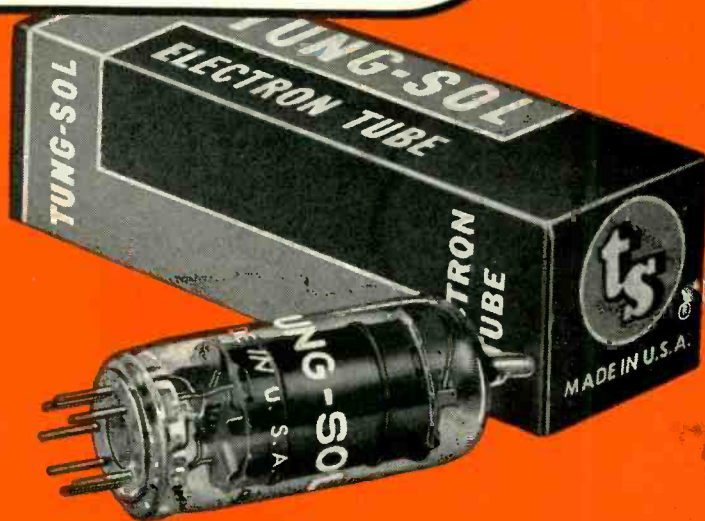
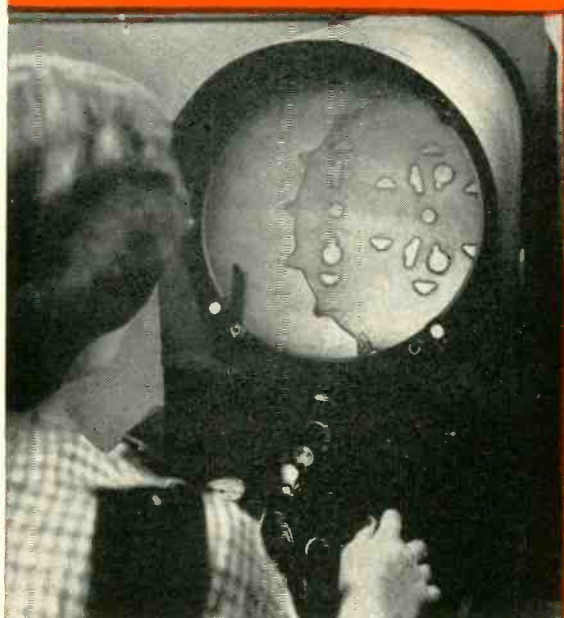

Optical comparator
is used to check mica
disc specifications
to thousandth-inch
accuracy.

TUNG-SOL LAMP WORKS INC., Newark 4, N. J. — Sales Offices: Atlanta
Chicago • Dallas • Denver • Detroit • Los Angeles • Newark



STACKPOLE ELECTRICAL AND ELECTRONIC COMPONENTS

Ceramag® FERRITE CORES

"U" and "E" TYPES FOR FLYBACK TRANSFORMERS AND DEFLECTION YOKES

These units assure permeability on the order of 10 to 1 by comparison with conventional iron cores. They are much smaller, have high resistance and operate cooler.

Advantages of Stackpole Ceramag non-ferrous (ferrite) cores include much higher permeability, lower losses with higher efficiency and lower operating temperatures, less corona effect, lower cost, lighter weight and smaller sizes. All types can be supplied in two standard grades:

CERAMAG 5N—A medium Q material temperature stabilized for minimum permeability change at temperatures up to 100° C. Primarily designed for low flux density uses.

CERAMAG 7—Ideal for use at high flux densities as in television flyback transformer applications. Temperature stabilized.

◀ TV IMAGE W-I-D-T-H CONTROL TYPES

Tops for TV horizontal image deflection circuits. Give ratios of from 1 to 8 or more in low line voltage areas compared with 1-5 for ordinary high permeability cores.



▶ SEGMENTED DEFLECTION YOKE CORES

This popular 4-segment design is highly efficient and can readily be handled in set production with little breakage.

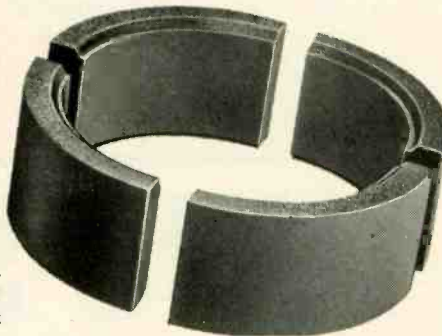

STANDARD AND SPECIAL IRON CORES

The rapid increase in the use of molded iron cores throughout electronic engineering has resulted in large part from Stackpole engineering that has made new and improved types available in a wide assortment

of shapes, sizes and ranges. Special Stackpole manufacturing techniques assure cores of outstanding dependability for exacting specifications. Write for details on any type.

- | | |
|-----------------------------------|----------------------------|
| STANDARD AND HIGH-FREQUENCY TYPES | SIDE-MOLDED CORES |
| HIGH-RESISTIVITY CORES | IRON CORES FOR CHOKE COILS |
| IRON CORES FOR CHOKE COILS | IRON SLEEVE CORES |
| THREADED CORES | CUP CORES |
| INSULATED CORES | |
| MOLDED COIL FORMS | CERAMAG® CORES |

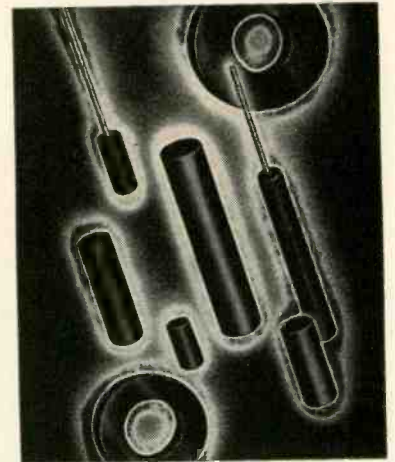

FIXED AND VARIABLE RESISTORS

Stackpole Variable Resistors offer a fully proved selection of types and sizes for volume control, tone control, potentiometer and similar applications in values from 500 ohms to 5 meg-ohms and in ratings to .6 watt. Recent developments include exceptionally small units conservatively rated at .5 watt and concentric shaft controls for TV.

Fully insulated and moisture-protected by phenolic sleeves, Stackpole molded carbon composition fixed resistors are available in 1/2-, 1- and 2-watt sizes in all standard and many special values for electrical, radio, TV and other electronic uses. Special Stackpole resistors include capacitor discharge, surge, lightning arrester, ignition suppressor and other types.

MILITARY TYPES—Need fixed or variable resistors for JAN or MIL specification uses? Send details of your requirements for recommendation by Stackpole engineers.

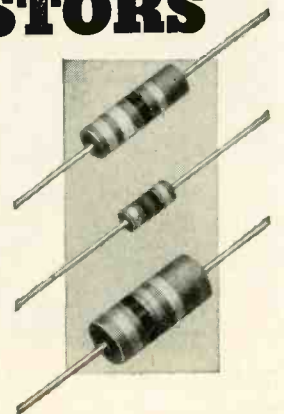
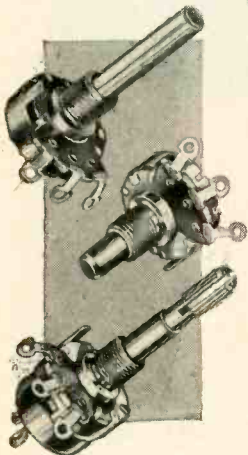

**HUNDREDS of STANDARD
ITEMS . . . thousands
of "Specials"**

Write for details on any type

- Anodes • Battery Carbons
- Bearing Materials
- Brazing Furnace Boats
- Brushes of all types for rotating electrical equipment
- Carbon and Graphite Contacts
- Chemical Carbons • Clutch Rings
- Dash Pot Plungers
- Electric Furnace Heating Elements
- Electrolytic Anodes • Friction Segments
- Glass Molds • Ground Rods (carbon)
- Mercury Arc Rectifier Anodes
- Metal-Graphite Contacts
- Power Tube Anodes
- Rail Bonding Molds
- Rare Metal Contacts
- Resistance Welding and Brazing Tips
- Seal Rings (for gas or liquid)
- Special Molds and Dies
- Spectrographite No. 1
- Trolley and Pantograph Shoes
- Voltage Regulator Discs
- Water Heater and Pasteurization Electrodes
- Welding Carbons
- Welding Plates and Paste

CARBON-GRAPHITE SPECIALTIES

The unique electrical, mechanical, physical and chemical properties of Stackpole carbon, graphite and molded carbon-graphite products solve countless problems of friction, temperature, arcing, corrosion, shaft sealing, voltage regulation and others. So broad is the line of Stackpole products in this field, so extensive the facilities for "specials" that it is practical to list only a few of them here. Stackpole engineers welcome the opportunity to assist in adapting any of these products to your specific design, engineering or production requirements.

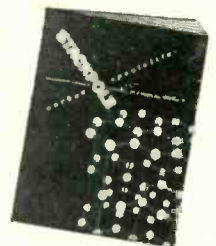

GET THIS DATA BOOK! Stackpole Booklet 40 contains a wealth of helpful data on carbon, graphite and carbon-graphite engineering uses. Write on company stationery.



LINE SWITCHES for Stackpole Controls

Only .888" in diameter by .312" thick, the Stackpole A-10 DP ST line switch fits even the smallest Stackpole variable resistor controls. Rated 1 amp, 250 volts AC-DC or 3 amps, 125 volts it combines outstanding ruggedness with ample-sized contacts and positive contact wiping action. Ideal for long, trouble-free service for portable and auto radios and numerous other uses. A similar single-pole design, Type A-11, with or without dummy terminal will soon be available.

OPEN

CLOSED

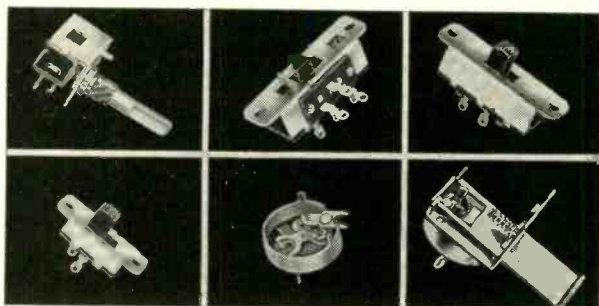

INEXPENSIVE LINE AND SLIDE SWITCHES including new 3 amp. types

Dress up your product—add to its convenience and "saleability" with these sturdy, low-cost switches! 18 fractional amperage and new 3 amp. types are available. Modifications can be produced economically for quantity users. Write for Switch Bulletin RC7C. State details of your application for samples.



SEND FOR COMPLETE DATA

Catalog RC-8 listing the complete line-up of Stackpole Electronic Component Specialties will gladly be sent on letterhead request. Write for your copy today.

STACKPOLE SPECIALTIES

TINY GA CAPACITORS

Stackpole GA Capacitors cost no more than "gimmicks" and assure far greater stability, higher Q, better insulation resistance and higher breakdown voltage. Moreover, they are mechanically superior and eliminate the inductive characteristic of the twisted wires. Capacities of 0.5; 0.68; 1.0; 1.5; 2.2; 3.3 and 4.7 mmfd. are available. $\pm 20\%$ tolerance.

BAKELITE COIL FORMS

Stackpole molded coil forms are the modern answer to the need for inexpensive mechanical supports for windings. Cost is low, space factor is reduced, assembly is easier and point-to-point wiring is feasible with far fewer soldered connections. Write for details and samples to your specifications.



STACKPOLE

Electronic Components Division
STACKPOLE CARBON COMPANY, ST. MARYS, PA.

Electra
carbon-coat

PRECISION

RESISTORS



**They're
NEW**
PRECISION...
1% Tolerance

**deposited
carbon
resistors**

The right choice for **ACCURACY**... **ECONOMY**... and **STABILITY** in circuits where wire wound resistors are often times too expensive and the characteristics of carbon composition resistors are not suitable. Deposited carbon resistors are especially adapted to high frequency applications that require high stability and close tolerance of resistance values. Manufactured to customer's specifications. For complete data mail coupon.

ELECTRA MFG. COMPANY
RESISTOR DIVISION
2537 Madison Ave. • Kansas City 8, Mo.
FOR 25 YEARS A MANUFACTURER OF
PRECISION ELECTRICAL EQUIPMENT

ELECTRA MFG. COMPANY
2537 Madison Ave. • Kansas City 8, Mo.

Please send Bulletin E-1—Complete Data on Deposited Carbon Resistors.

NAME _____
COMPANY _____
ADDRESS _____
CITY _____
STATE _____

INDUCTOROIDS

TOROIDAL INDUCTANCES OF HIGH "Q" QUALITY

Toroidal Inductances wound on Molybdenum Permalloy compressed powdered dust cores are available in all practical inductance values. Several core sizes and types are stocked making it possible to supply high Q inductances, especially suitable for *your* frequency and load ranges. We supply Inductoroids either cased or uncased

Filters and Equalizers

Because of their high Q, great inductance stability, and extremely low pick-up from external fields toroidal coils are highly desirable for such applications as wave filters, equalizers, and similar circuits. We supply these networks built to meet your circuit specifications or we will design and build such networks to meet your performance specifications.

Important! Send us your specific requirements.

DE COURSEY ENGINEERING LABORATORY

P. O. BOX 235

LOS ANGELES 25, CALIF.

RADIATION BARRIERS

In strip or gasket form, a resilient bonding material for:

HF & UHF Cages
Screen Rooms
Engine Casings
Wave Guides
Magnetic Housings
etc.

Unwanted radiation emitted or intercepted by electronic equipment can be effectively controlled with York Radiation Barriers. By the adaptation of York Technically Knitted Wire Mesh, compressed resilient shieldings with air porosities of from 40 to 90% and exceptionally large conductive areas, are available in any shape or size of the most suited material for your internal or external radiation control.

YORK RADIATION BARRIERS are made to precise engineering specifications for varied applications. Our engineers, with their wealth of know-how, invite your inquiry.

York
ENGINEERS AND
MANUFACTURERS

ELECTRONICS DIVISION
OTTO H. YORK CO., INC.

69 Glenwood Place
East Orange, New Jersey Orange 4-2000

ELECTRONS INCORPORATED

127 SUSSEX AVENUE

NEWARK 4, N. J.

*Inert gas rectifier and thyatron
tube specialists since 1928.
Send for our "Engineering Manual & Catalog."*

Hermetic Seal Products Co. is

WAY OUT FRONT!

In the Development and
Production of Hermetic Seals
for the Most Vital Controls
and Components Made by
America's Leading Industries



Hermetic Seal Products Co. makes only glass-metal headers—created and produced by the largest staff of specialist-engineers in the world. This company truly stands alone in its remarkable achievements in smaller-than-small miniature plugs and seals. Its line embraces literally hundreds of new practical designs—thoroughly field tested and already in production for myriad applications.

These headers are available in unlimited shapes and with any number of terminals as required. They are the only seals you can hot tin dip at 525°F. for easy assembly soldering, for a strain and fissure-free sealed part with resistance of over 10,000 megohms. They will also withstand sub-zero conditions, swamp test, temperature cycling, high vacuum, high pressure, salt water immersion and spray, etc.

Important!

Terminals and Headers are available in RMA Color Code.



←... JUST OFF THE PRESS—1951-52 CATALOG

Invaluable information on miniatures and hundreds of exclusive new developments in hermetic seals have been incorporated into a greatly needed NEW catalog. This book features many illustrations and complete technical data to make it easy for you to determine the right glass-metal header for the components you are planning. This book is available to you without cost. Write for your FREE copy today.

Remember, too, that Hermetic Seal Products' staff of specialist-engineers is waiting to help you with your problems in this ever-expanding field.



HERMETIC SEAL PRODUCTS CO.
31-33 South Sixth Street, Newark 7, New Jersey



TEFLON

ELECTRONIC PARTS

Teflon's outstanding electrical properties make it an ideal insulating material for high-voltage, high-temperature, high- or ultra-high-frequency service. Component parts fabricated of Teflon are finding a steadily increasing number of applications in radio, radar, TV and other electrical and electronic equipment.

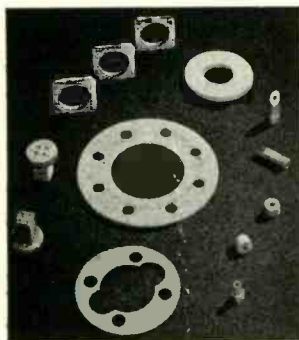
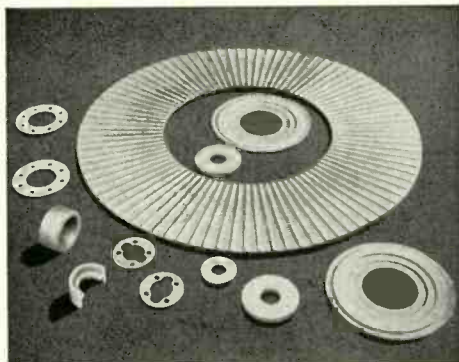

Teflon's loss factor is less than 0.0005; its dielectric constant only 2.0—at all frequencies measured to date. Teflon is serviceable throughout the entire temperature range of -110°F . to 575°F . with negligible change in critical electrical characteristics. Teflon is tough, somewhat resilient, weather-proof, has zero water absorption and is absolutely non-corroding.

We manufacture all types of molded or machined Teflon parts including coaxial spacers and coaxial connectors for electronic equipment, component parts for switches, relays, and contactors, as well as tube sockets, high-voltage brackets for power resistors, gaskets, specialties, etc. For more information request Catalog No. 400. Also available — Teflon sheets, cylinders, rods, tubing and bars. *We are the country's foremost manufacturer of Teflon products.*

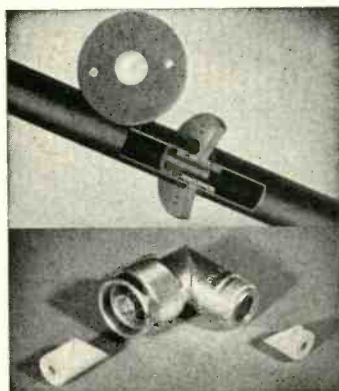

Teflon Products Division

UNITED STATES GASKET CO.

600 N. 10th Street • CAMDEN, NEW JERSEY

Typical Properties of "Teflon"

Tensile Strength @ 77 F	1500 to 2500 psi.	Specific Heat	0.25 Btu./lb./deg. F
Elongation @ 77 F	100 to 200%	Heat Distortion Temperature for 66 psi.	270 F
Flexural Strength @ 77 F	Did not break (D790-44T)	Surface Arc-Resistance	Does not track even after 1200 seconds of exposure ASTM D 495-42
Stiffness @ 77 F	60,000 psi.	Volume Resistivity	10^{15} ohm-cm.
Izod Impact Strength @ 70 F	2.0 ft.-lb./in.	Surface Resistivity @ 100% Rel. Hum.	3.6×10^8 megohms
77 F	4.0 ft.-lb./in.	Dielectric Constant, 60 to 10^8 Cycles	2.0-2.05
170 F	6.0 ft.-lb./in.	Power Factor, 60 to 10^8 Cycles	0.0005
Durometer Hardness	55 to 70	Water Absorption	0.0%
Compressive Stress @ 0.1% Deformation	1700 psi.	Flammability	Nonflammable
Deformation under Load @ 122 F, 1200 psi., 85 hr.	4 to 8%	Resistance to Weathering	Excellent
Coefficient of Linear Thermal Expansion from 77 to 140 F	5.5×10^{-5} per deg. F	Specific Gravity	2.1 to 2.3
Thermal Conductivity	1.7 Btu./hr./sq. ft./deg. F/in.		

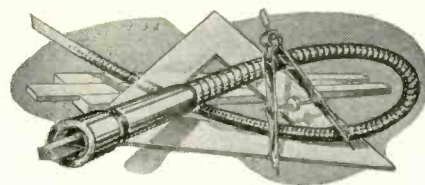

MODERN DESIGN AND ENGINEERING

Many an industry owes much of the success of its products to the modern solution of its angular drive problems with flexible shafting. The right application of a flexible shaft can mean greater flexibility in alignment . . . better integration of units . . . less complex gearing.

The result is lower assembly costs and a product that is quiet, smooth, efficient and trouble-free in operation with minimum repair requirements. Circle Ess flexible shafts will stand the most rigid tests and scrutiny. They will help to solve your problems as they have those of many other manufacturers.



Write for our new book "Flexible Shaft Assemblies."

F. W. STEWART MFG. CORP.

4311-13 RAVENSWOOD AVE.
CHICAGO 13, ILL.

WEST COAST BRANCH: 431 VENICE BLVD., LOS ANGELES 15, CAL.

This Year
The
BUYERS' GUIDE
inaugurates
A
Where-to-find-it Guide
to the
1930-1939
electronics'
editorial
contents

A cumulative editorial index to the first ten years of **ELECTRONICS**
Pages C-1 to C-36

Next ten years in next year's **GUIDE**.

RCA Measuring Instruments

...for research, production and servicing



**Television Calibrator
WR-39C**

Has variable-frequency oscillator operating on fundamentals over entire range. Crystal standards supply over 600 calibration points at 0.25-Mc intervals. Crystal-calibrated markers for all TV frequencies, with extra markers spaced 4.5 Mc from fundamental marker. Wide-band modulator has range of 0 cps to 30 Mc. Provision for injection of external marker. Useful as bar-pattern generator for making linearity adjustments.



**Television Sweep Generator
WR-59B**

Covers all TV channels on preset fixed positions, and in addition has a continuous tuning range providing for present and future intermediate frequencies from 0.3 to 50 Mc. The rf signal is frequency-modulated at the fundamental by special vibrating capacitor. Has 12-Mc sweep for rf and if bands, output flat within ± 1.5 db even at rated sweep width. Includes blanking circuit which produces zero-reference line on CR tube.

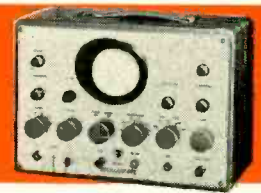

**Television Oscilloscope
WO-57B**

Designed for viewing and measuring square waves, sine waves, pulses, and TV sync signals. Has sensitivity of 30 millivolts rms per inch deflection. Response of vertical amplifier flat within -2.0 db from zero to 500 kc, -6 db at 1 Mc. Employs frequency-compensated and voltage-calibrated vertical attenuators, and 60-cycle sweep with phasing control. Magnetic shield on CR tube. Excellent performance for a small compact instrument.



**Senior VoltOhmyst*
WV-97A**

Directly measures complex waves from 0.2 volt to 2000 volts, peak-to-peak. Measures dc voltages from 0.02 to 1500 volts with $\pm 3\%$ accuracy of full scale. Measures rms values of sine-wave voltages from 0.02 volt to 1500 volts. Measures resistance from 0.2 ohm to 1000 megohms. Response flat from 30 cps to 3 Mc. Has 7 non-skip voltage and resistance ranges. Fully enclosed metal case shields sensitive electronic bridge from rf fields.
Reg. U. S. Pat. Off.

**Laboratory Oscilloscope
WO-79B**

For detailed observation and accurate measurement of voltages produced by TV sync and deflection circuits, ignition waveforms, pulses and radar signals. Will accurately display 1-microsecond pulses with extremely steep leading edges. Has triggered sawtooth sweep with delay network, three-to-one trace expansion, vertical amplifier flat within 10 cps to 5 Mc, calibrating meter for voltage measurements, built-in 0.2-microsecond delay line.



**Television Oscilloscope
WO-56A**

Uses 7" CR tube, and direct-coupled, 3-stage, push-pull, vertical and horizontal amplifiers. Special circuit automatically controls synchronization over a wide range of input-signal levels. Dual controls for "coarse" and "fine" adjustments. Frequency-compensated and voltage-calibrated attenuators on both amplifiers. Response flat within -2 db from dc to 500 kc, -6 db at 1 Mc. Vertical deflection sensitivity, 10.6 rms millivolts per inch. Magnetic shield on CR tube.



**Ultra-Sensitive DC Microammeter
WV-84A**

Reads from 0.001 microampere to 1000 microamperes in six ranges. Also useful for measuring high values of resistance, or as a high-resistance voltmeter with a sensitivity of 100 megohms per volt. Accuracy $\pm 5\%$ of full scale or better.

**High-Voltage Test Probe
WG-289 or WG-290**

For measuring voltage of TV power supplies and other high-voltage sources. Has anti-corona probe tip, completely insulated grip, and separate ground lead. Multiplier resistors available to adapt probes to most makes of volt-ohm-meters. WG-289 equipped with microphone-type connector and WG-290 equipped with phone-tip connectors.



**Rack-Adapter Panel
WS-18A**

For mounting any of the matched RCA Test Instruments—such as the WR-39C, WO-57B and WR-59B—in standard 19-inch racks. Adds convenience and standardization to test set-ups. Dimensions, 10½" high, 19" wide, ⅛" thick. Umber gray finish.



For complete technical data bulletins on individual instruments, see your RCA Test Equipment Distributor, or write RCA, Commercial Engineering, Section 43FX, Harrison, N. J.



RADIO CORPORATION of AMERICA
TEST EQUIPMENT
HARRISON, N. J.



KINGS MICROWAVE

Shown on the next page are but a few of the many precision-engineered components made by Kings Microwave Company. The complete line offers features of advance design and dependability that assure maximum accuracy and versatility.

Our fully-staffed engineering department welcomes the opportunity of assisting you with your individual microwave and research problems. Your inquiries and requests for catalogs are invited.

PHOTO	MODEL No.	DESCRIPTION	FREQUENCY RANGE, MCS	TRANS. LINE SIZE	CONNECTORS	SPECIAL FEATURES
1	073	Crystal Mixer	2,600-3,400	5/8" coax.	3-UG-21B/u	1, 2, 3, 4, 11
2	434	Feed Horn	8,500-9,600	RG-52/u	1-UG-39/u	2, 5, 6, 7, 11
3	403	Wavemeter, Direct Reading	8,500-9,600	RG-52/u	2-UG-40/u	1, 7, 8, 9, 11
4	047	Double Stub Tuner	1,000-10,000	5/8" coax.	UG-21B/u, UG-18B/u	1, 2, 3, 7, 11
5	108 S1	Adapter	0-4,000	5/8" to 7/8" coax.	UG-46/u, UG-21B/u	1, 2, 3, 6, 10, 11
6	948	Antenna	75	5/8" coax.	1-UG-21B/u	3, 8, 11, 12
7	972	Mixer-TR. Assembly	2,700-2,900	5/8" coax.	3-UG-21B/u	1, 2, 3, 4, 11
8	002	Filter-Detector Assembly	2,600-3,400	5/8" coax.	1-UG-21B/u, 1-SO-239	1, 2, 3, 6, 7, 8, 11, 13
9	026 S	Oscillator Cavity	2,600-3,300	5/8" coax.	1-UG-21B/u	1, 2, 3, 8, 11, 14
10	025	Hi Power Load	2,600-3,400	RG-48/u	UG-200/u	7, 11, 12, 15
11	248	Antenna	2,600-3,400	5/8" coax.	UG-21B/u	1, 2, 3, 6, 11
12	165	Oscillator Cavity	1,200-1,400	5/8" coax.	UG-21B/u	1, 2, 3, 7, 11, 14, 16
13	068 C	Standing Wave Indicator	4,000-6,000	RG-49/u	2-UG-149/u	1, 2, 3, 4, 7
14	138	Wavemeter	3,700-4,400	5/8" coax.	UG-21B/u	1, 2, 3, 4, 7, 8
15	040 X	E/H Tee	8,200-12,400	RG-52/u	4-UG-39/u	1, 2, 7, 11
16	106 V	Series Tee	12,400-18,000	RG-91/u	3-UG-419/u	1, 2, 7, 11
17	264 Y	E Plane Elbow	7,050-10,000	RG-51/u	2-UG-51/u	1, 2, 6, 7, 11
18	288 Y	Bidirectional Coupler	8,500-9,600	RG-51/u	2-UG-51/u, 2-UG-21B/u	1, 2, 3, 6, 7, 11
19	401 X	Waveguide Coaxial Adapter	8,500-9,600	RG-52/u	1-UG-39/u, 1-UG-21B/u	1, 2, 3, 7, 11
20	134 Z	Flap Attenuator	5,850-8,000	RG-50/u	UG-344/u	1, 2, 7

SPECIAL FEATURES

- | | | |
|----------------------------------|--------------------------------------|-------------------------------|
| 1. Silver Plated | 7. Enamel External Finish | 12. Aluminum Construction |
| 2. Brass Construction | 8. Temperature Compensated | 13. Uses 1N32 Crystal |
| 3. All Contacts Beryllium Copper | 9. Calibrated to ± 2 mcs | 14. Uses 2C40 Vacuum Tube |
| 4. Uses 1N21 B Crystal | 10. All Insulators Teflon | 15. Maximum Average Power 1KW |
| 5. Gold Plated | 11. Used in Armed Services Equipment | 16. Motor Operated |
| 6. Pressurized | | |

RADIO FREQUENCY COMPONENTS

1

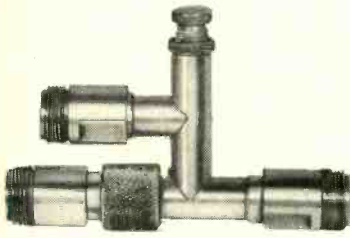

2

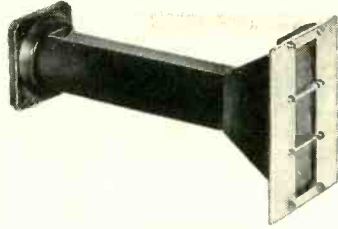

3

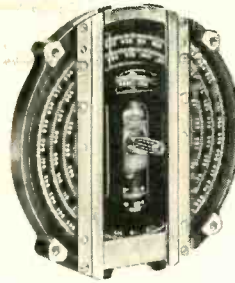

4



5



6

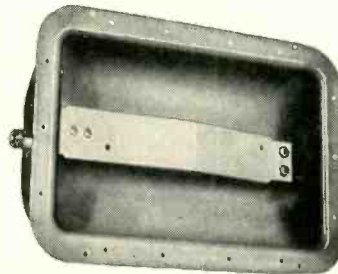

7

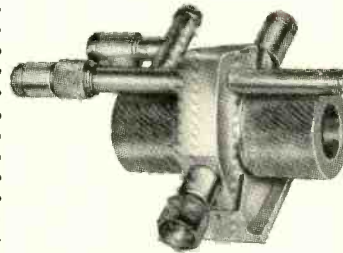

8

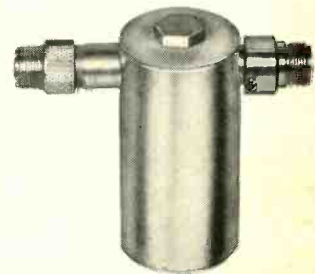

9

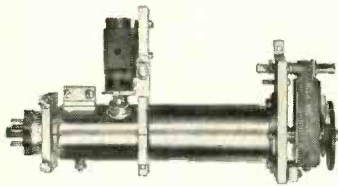

10

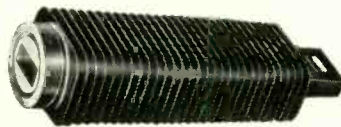

11

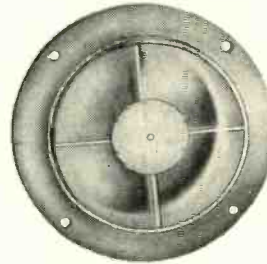

12

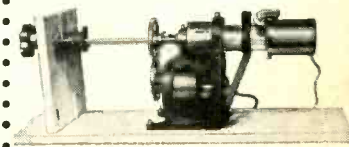

13

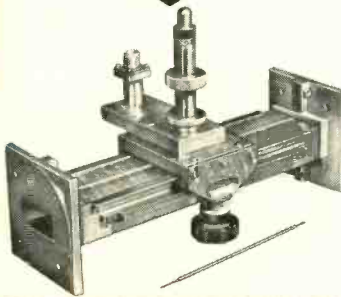

14



15

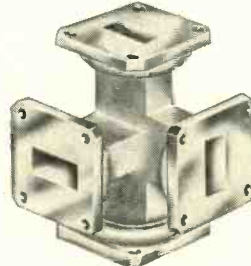

16

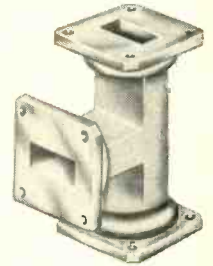

17

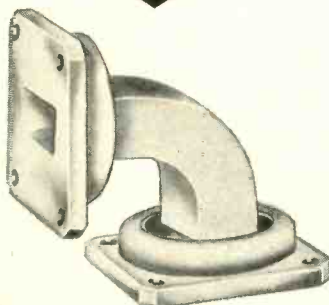

18

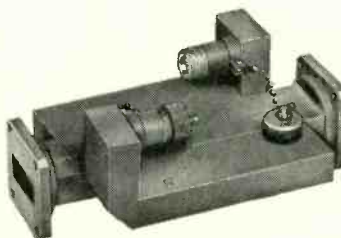

19



20



Want to know about the...

AUGETRON

ECCLES-JORDAN CIRCUIT

KATHETRON TUBE

MEKAPION TUBE

PERMATRON

PETOSCOPE

SCHLIERN METHOD

SCOPHONY

SEMAGRAPH

SIRUFER

SYNDEC

THEREMIN

TRATONIUM

VODER

or other early electronic developments?

You can find out about them in the early issues of **ELECTRONICS**.

The cumulative index to **ELECTRONICS'** first decade, pages C-1 to C-36 in this book, tells you where to look.

KINGS COAXIAL CONNECTORS

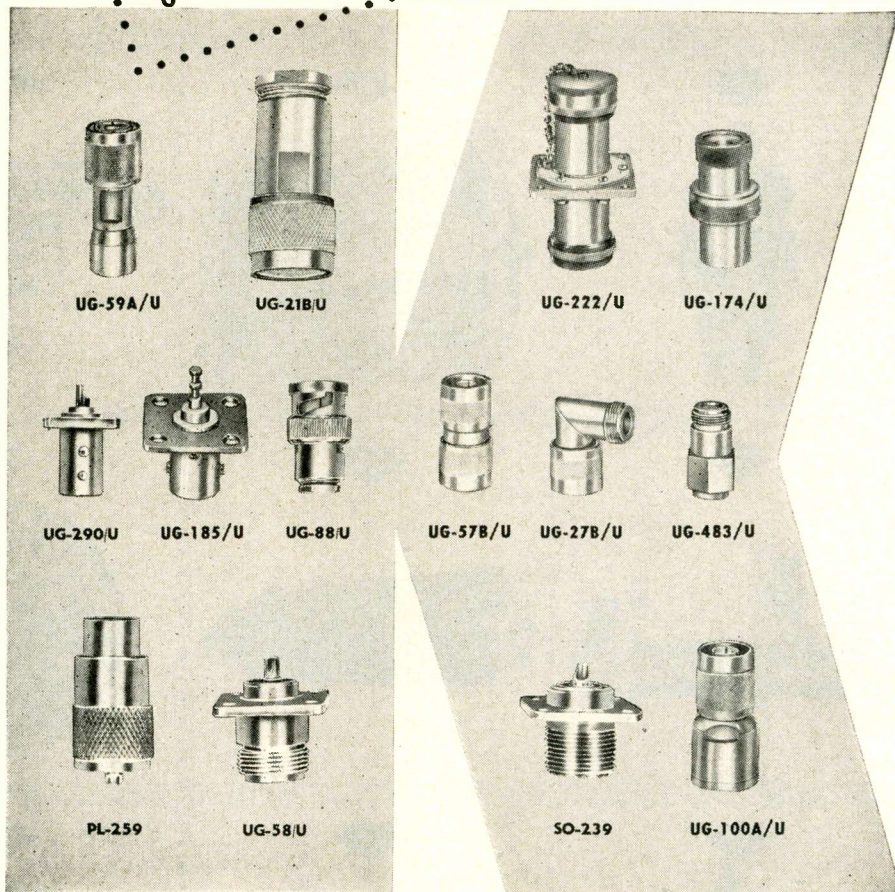

preferred by engineers everywhere

From coast-to-coast, engineers in all fields look to Kings Electronics for the finest coaxial connectors.

Special problems in design and fabrication receive the wholehearted cooperation of Kings own engineering department.

For precision-made, pressurized R. F. Connectors call on Kings — the leader. Quotations on request.



40 MARBLEDALE ROAD, TUCKAHOE, N. Y.
IN CANADA: ATLAS RADIO CORP., TORONTO

KINGS solves your insulation problems

with **TEFLON** and
TEXTOLITE

Production Facilities
Available For
Manufacture of
Insulation Parts
To Your
Specifications.

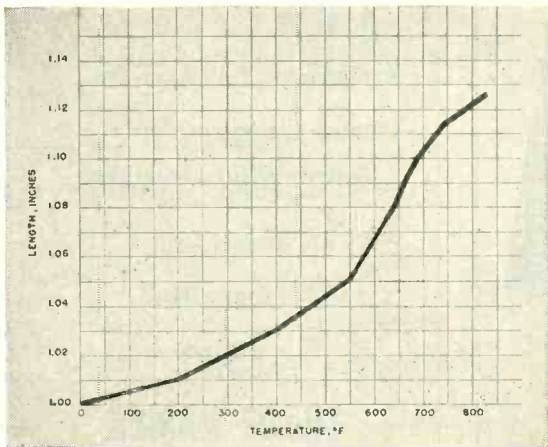
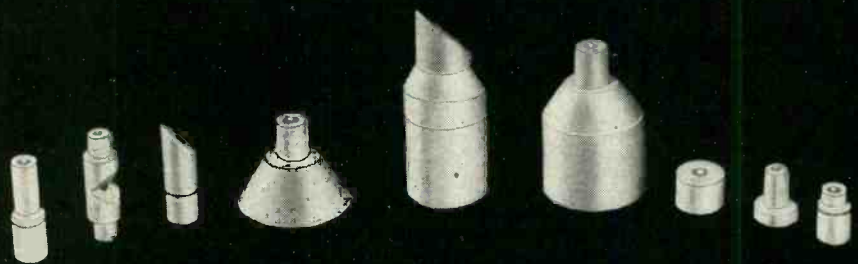

LINEAR EXPANSION OF
POLYTETRAFLUOROETHYLENE (TEFLON)
TOTAL LENGTH VS. TEMPERATURE

Manufacturers from coast-to-coast call on Kings to produce their insulation parts from machined bar stock made from Teflon or Textolite 1422.

Tolerances are held extremely close. Special lubricants developed by Kings will not affect the dielectric characteristics of these materials.

For most purposes of electrical insulation, in relatively high frequency fields, Textolite 1422 is recommended. Where impact strength, chemical inertness, and resistance to heat are major factors, Teflon is recommended.

Kings fabricates its own Teflon Rod and Tubing which is also available to industry in raw form. Whatever your insulation problem, you can rely on Kings. Distributors inquiries solicited.



Plastics Division, BOX 217, TUCKAHOE, N. Y.
IN CANADA: ATLAS RADIO CORP., LTD., TORONTO

PHOTOTUBES

CETRON engineer perfected phototubes. Many types for innumerable applications. "Insist on CETRON."



RECTIFIERS

CETRON industrial rectifiers in full and half wave mercury vapor, full and half wave gas filled using both mercury vapor and gas. "Insist on CETRON."



THYRATRONS

CETRON grid controlled thyratrons have a longer life and better performance. "Insist on CETRON."



For over a quarter of a century CETRON phototubes, industrial rectifiers, and thyratrons have been meeting the needs of the industry effectively and efficiently. Send for a copy of our 50 page catalog. It contains all the technical data and specifications of all electronic tubes in our large line.

CONTINENTAL ELECTRIC CO.

Geneva, Illinois



2 for 1

Two of these newly developed Acme Band Pass Wave Filters take up no more chassis space than formerly was required for one.

This is just another example of how Acme is solving the most difficult specialized problems. Your inquiry is invited.

Acme

ELECTRONICS, INC.

300 No. Lake Ave., Pasadena 4, Calif.
Formerly Acme Metal Die, Inc.

Wave Filters • Delay Lines • Magnetic Amplifiers • Special Transformers & Chokes • Toroidal, Universal & Solenoid Wound Inductors

a plus feature

Immediately following the
Product Listings in the

DIRECTORY SECTION

of this Issue

is a list of more than

2500

TRADE NAMES

of electronic and
allied products.

They are intended for
your use in determining
the manufacturer's name
when only
a trade name is known.

Now! the first and only electronics distributor COAST TO COAST!

- to cut your production costs
- speed your service, and
- assure you a smooth flow of supplies

Federated Purchaser

is technically equipped
to handle J A N specifications
and ALL electronic needs.
Direct Export facilities.

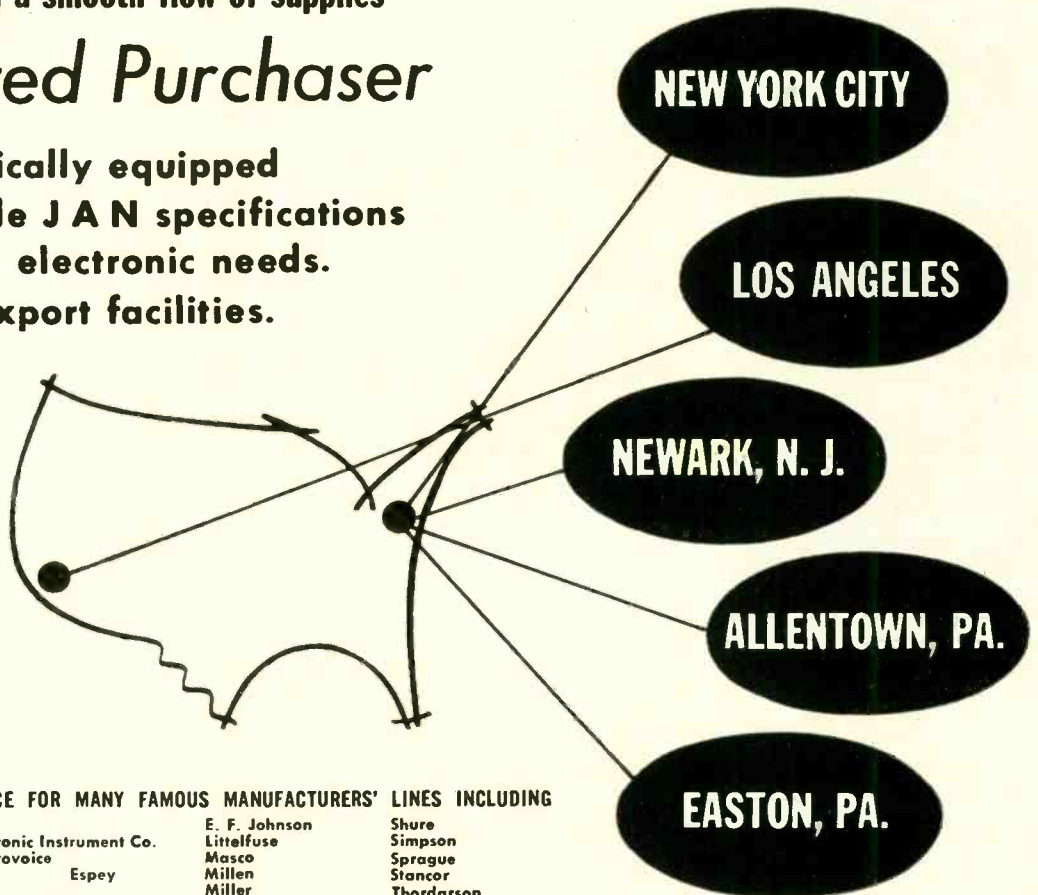

AUTHORIZED DIRECT SOURCE FOR MANY FAMOUS MANUFACTURERS' LINES INCLUDING

Aerovox
American Phenolic
Astatic
Belden
Bogan
Bud
Burgess
C-D
Cinch-Jones
Condenser Products
Dial Light

Eby
Electronic Instrument Co.
Electrovoice
Erie Espey
GC
General Electric
Greenlee
Hallicrafters
ICA IRC
JBT
Jensen
JFD

E. F. Johnson
Littelfuse
Masco
Miller
Miller
Mueller
National
National Carbon
Ohmite
Par-Metal
RCA
Sangamo

Shure
Simpson
Sprague
Stancor
Thordarson
Triplett
UTC
Ward Leonard
Xcelite
and many others

Purchasing Agents! Engineers!

Take advantage of F-A-R R-E-A-C-H-I-N-G Federated Purchasing Power

CABLE: FEDERPURCH

Federated Purchaser

INCORPORATED

THE ONLY COAST TO COAST ELECTRONICS DISTRIBUTOR

New York City
66 Dey St.
DIgby 9-3050

Los Angeles
911 S. Grand Ave.
TRinity 7311

Newark, N. J.
114 Hudson St.
MArket 3-4005

Allentown, Pa.
1115 Hamilton St.
Phone 3-7441

Easton, Pa.
701 Northampton St.
Phone 4259

"Mr. Fed" says:

You get our 1200 page RADIO'S MASTER
Buying Guide FREE with your order.

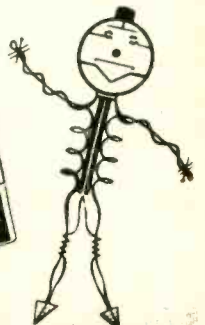

Polarad
Electronics Corporation

PRECISION LABORATORY INSTRUMENTS

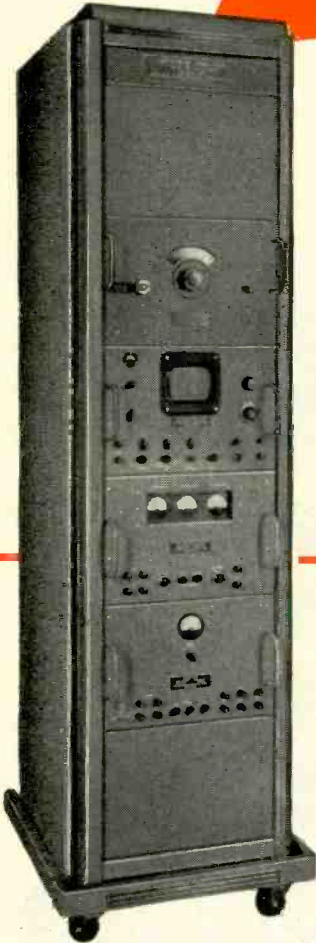

Model LSA

the instrument consists of the following units:

- Model LTU-1 R.F. Tuning Unit—10 to 1000 MC.
- Model LTU-2 R.F. Tuning Unit—940 to 4500 MC.
- Model LTU-3 R.F. Tuning Unit—4460 to 16,520 MC.
- Model LDU-1 Spectrum Display Unit.
- Model LPU-1 Power Unit.
- Model LKU-1 Klystron Power Unit.



MICROWAVE SIGNAL SOURCES

Models SSR,
SSL, SSS,
SSM, SSX
634 MC to 11,000 MC

For use as a reliable source of microwave energy in transmission loss measurements, standing wave determination, etc. Unidial Control for accuracy and ease of operation. Direct reading (no mode charts to consult). Frequency determination accurate to 1% through use of present calibration and temperature compensated klystrons.

Five Microwave Signal Sources are available to cover the frequency range from 634 MC to 11,000 MC. Units ruggedly constructed, mounted on aluminum castings to insure mechanical stability. Klystron reflector voltage automatically tracked with tuning of the klystron cavity to provide unidial control. Signal sources supplied complete with klystron.

all band, direct reading

SPECTRUM ANALYZER

10 MC to 16,520 MC

The Model LSA is the result of years of research and development. It provides a simple and direct means of rapid and accurate measurement and spectral display of an rf signal.

Outstanding Features:

- Continuous tuning.
- One tuning control.
- 5 KC resolution at all frequencies.
- 250 KC to 25 MC display at all frequencies.
- Tuning dial frequency accuracy 1 percent.
- No Klystron modes to set.
- Broadband attenuators supplied with equipment above 1000 MC.
- Frequency marker for measuring frequency differences 0-25 MC.
- Only three tuning units required to cover entire range.
- Microwave components use latest design non-contacting shorts for long mechanical life.
- Maximum frequency coverage per dollar invested. 5 inch CRT display.

Where Used:

Polarad's Model LSA Spectrum Analyzer is a laboratory instrument used to provide a visual indication of the frequency of distribution of energy in an rf signal in the range 10 to 16,520 MC.

Other uses are:

1. Observe and measure sidebands associated with amplitude and frequency modulated signals.
2. Determine the presence and accurately measure the frequency of radio and/or radar signals.
3. Check the spectrum of magnetron oscillators.
4. Measures noise spectra.
5. Check and observe tracking of rf components of a radar system.
6. Check two rf signals differing by a small frequency separation.



Model V

WIDE BAND VIDEO AMPLIFIER

Model V 100 CPS to 20 MC

Designed for use as an oscilloscope deflection amplifier for the measurement and viewing of pulses of extremely short duration and rise time. Supplied complete with Video Amplifier Unit, Power Unit and Low Capacity Probe.

Features:

- Flat frequency response from 100 cps to 20 mc \pm 1.5 db.
- Uniform time delay of .02 microseconds.
- Pulse rise of 0.02 μ s with minimum overshoot.
- Gain of 50 db.
- Frequency compensated high impedance attenuator calibrated in 10 db steps from 0-50.
- Fine attenuator covers a 10 db range.
- Phase Linear with frequency over entire band.

Manufacturers of precision laboratory instruments

RADIO CUE SYSTEM



Model AB

Used to direct the activities of persons within a limited area from a central control point. Widely used in broadcast and motion picture studios (sound and television). Ideal for factories, yards, hangars, airports, auditoriums, and places where the noise level is high. The Radio Cue System permits efficient operation under difficult conditions.

Packet size receivers worn by radio directed personnel are small and light in weight assuring complete freedom of movement. Simultaneous transmission on two or more communication channels. System is portable and can be installed rapidly because of its unusual simplicity.

REGULATED POWER UNITS

Electronically regulated power supplies designed to meet the needs of television equipment and other apparatus which require extremely fine regulation, low ripple content and appreciable quantities of D.C. power.

Output impedance less than 1.5 ohms.
Regulation better than 0.2%.

The power supplies are built on a dishpan type chassis with transformers, tubes and control panel at the front. All wiring is on the rear of the chassis which is of standard rack width. To insure long life, no electrolytic condensers are used.

A portable carrying case, Model C111, is available.

Model PT111

Consists of a positive and a negative voltage supply independently regulated.

Output Voltage: 250-300 volts D.C.
Output Current: 100-400 ma.

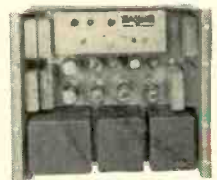

Model PT112

Heavy duty electronically regulated D.C. power source.

Output Voltage: 250-300 volts, D.C.
Output Current: 150-800 ma.

Model PT111D (Dual Regulated)

Consists of two independently regulated D.C. power sources, (isolated from ground), mounted on one chassis.

Each power source has its own power switch, fuse, pilot light and voltage control. Each power supply can be operated with negative or positive ground.

(Each power source, two such sources available)
Output Voltage: 250-300 volts, D.C.
Output Current: 100-400 ma.

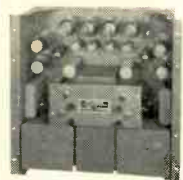

POLARAD ELECTRONICS CORP., 100 Metropolitan Ave., Brooklyn 11, N. Y.

TELEVISION EQUIPMENT

Polarad
Electronics Corporation

- for
- STUDIO
 - LABORATORY
 - MANUFACTURER

PORTABLE TELEVISION WAVE FORM MONITOR



Model TO-1

Specifications:

- Maximum Vertical Deflection Sensitivity: 0.1 volts per inch.
- Input Signal Level: 0.25 to 2 volts peak to peak.

Designed for precise waveform analysis and amplitude measurement of video signals in television circuits. Also ideal as a general purpose instrument in many applications, because of its wide frequency response, high sensitivity, excellent synchronizing capability, precision calibrating circuits and unusually large symmetrical horizontal expansion. Means are provided for calibrating or comparing signals observed.

- Input Impedance: (V. Amp.) 1 megohm, 50 mmf; (H. Amp.) 1 megohm, 27 mmf.
- Frequency Response: (V. Amp.) flat to -3db at 4 mc.; (H. Amp.) flat to -3db at 35 kc.

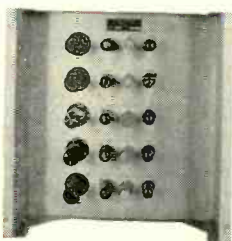

Model TDA-1

TELEVISION DISTRIBUTION AMPLIFIER

Isolates and distributes television signals over transmission lines for station and production use.

Specifications:

- 5 individual wide band linear video amplifiers.
- High Input Impedance permits bridging of 5 amplifiers across same source.
- Positive and Negative signals available at the output.

- Undistorted output of 5.5 volts peak to peak across 100 ohms at either positive or negative polarity.
- Frequency Response: flat to 10 megacycles -5 db.
- Power Input: 250 volts D.C., 350 ma., 150 volts D.C., 15 ma., 6.3 volts A.C., 6 amps.

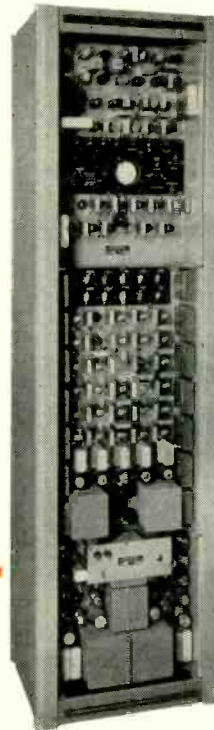

Model PT-101

TELEVISION MONOSCOPE SIGNAL SOURCE

Model PT-102

Used in transmitting stations, laboratories and in receiver factories where a reliable standard video signal in the form of a test pattern is a prime requisite for testing overall video performance.

Specifications:

- Composite Video Signal.
 - Wide Band Video Amplifier, 3db down at 7 mc.
 - Dual outputs for feeding two 75 or 100 ohm lines.
 - Black positive or Black negative output.
 - Resolution greater than 500 lines.
- INPUT: Vertical and Horizontal Driving Pulses, Camera and Kinescope Blanking Pulses.
- OUTPUT: Composite Video Signal, 2 Volts peak to peak. Complete with tubes, high and low voltage power units, cabinet rack.

TELEVISION SYNCHRONIZING GENERATOR

For use in television broadcasting studios, laboratories and receiver manufacturing where precise and

stable synchronizing signals are an essential requirement.

Specifications:

- Fast lock-in action of AC line synchronizing circuits.
- Interlaced Fields: 525 lines, 60 fields, 30 frames.
- Output Signals: Synchronizing (Neg.); Video Blanking (Pos.); Camera Blanking (Pos.); Camera Horizontal Driving (Neg.); Camera Vertical Driving (Neg.)
- Output Signal Level: 5 volts peak to peak.
- Output Termination: 100 ohms.
- Power: 115 volts, 80 cps, 750 watts.

PICTURE and WAVE FORM MONITOR

Model M-102

High fidelity monitoring of picture signals and general supervision and investigation of composite video signals at the studio or remote point.

Specifications:

- Resolution greater than 500 lines.
- Picture Amplifier: flat \pm 1 db to 6 mc.
- Wave Form Oscilloscope: flat \pm db to 3 mc.
- Input Impedance: 470,000 ohms.
- Input Signals: Video (black neg.) 0.25-2 volts peak to peak; Video Drive (Neg.) 4 volts; Kin. Blank (Pos.) 4 volts; Synchronizing Pulse (Neg.) 4 volts.
- Power Input: 115-125 volts, 50/60 cps, 6 amps.

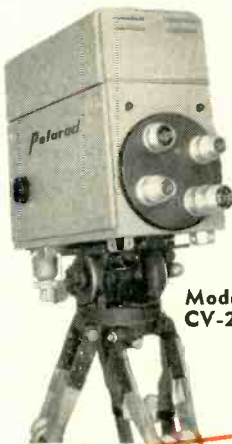
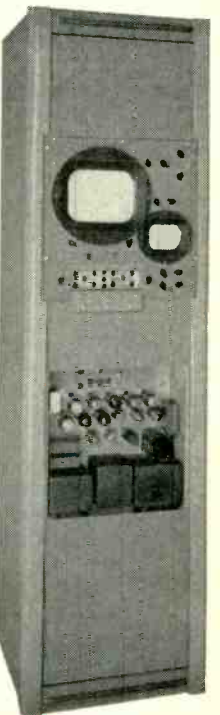

Model CV-2

FIELD CAMERA CHAIN

Used both indoors and outdoors for picking up programs. Excellent picture quality and resolution over 500 lines are obtained even under difficult and unpredictable lighting conditions. Camera unit supported on a special scanning mount and tripod provides excellent maneuverability in covering scenes over a wide angle. Electronic view finder plugs into the camera and is readily detachable. Removable four lens turret with interlocking switches for changing scenes rapidly without circuit transients.

Television Camera Chain consists of:

Field Camera Unit	Camera Cable
Camera Control Unit	Lens Component
Power Unit	50 mm, f 1.9
Electronic View Finder	90 mm, f 3.5
Camera Tripod	135 mm, f 3.8

The Power Unit is adjustable for varying AC line conditions and provides metering for the system. All power requirements for the Camera Chain are provided by this unit. The Camera Chain is adaptable to and can operate with existing equipment.

Television Engineers and Consultants to the Nation's Great Television Stations!

Specifications and Descriptions of Polarad Equipment Available on Request.

POLARAD ELECTRONICS CORP., 100 Metropolitan Ave., Brooklyn 11, N. Y.



Cinch
ELECTRONIC
COMPONENTS

CINCH MANUFACTURING CORPORATION

1026 S. HOMAN AVE. • CHICAGO 24, ILLINOIS

Subsidiary of United-Carr Fastener Corporation, Cambridge, Mass.

CINCH PARTS . . . *The Standard in Electronics*

The vast engineering behind every Cinch component concerns itself primarily with the problems of perfection, precision and performance in all phases of communications and industrial electronic equipment. Their small individual assemblies have always fully performed the service for which they were designed and in many cases have anticipated engineering needs of the future. So that today, judged by service, and by numbers in use as well as by testimonies of users, **CINCH PARTS ARE STANDARD.** They meet the demands for higher quality materials and closer tolerance in all communications and industrial control equipment.



CINCH SUB-MINIATURE



CINCH NOVAL
NINE PRONG



CINCH MOLDED
MINIATURE



CINCH-ERIE
PLEXICON

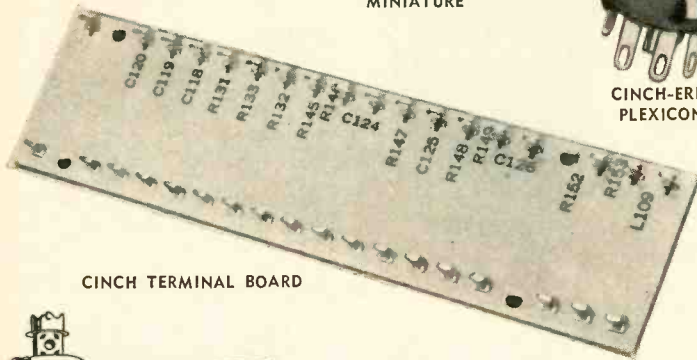

CINCH TERMINAL BOARD

SEND FOR COMPLETE CATALOG

Cat. No. 51 contains complete data on all of the Cinch electronic components. Requests on company letterheads will be promptly answered.

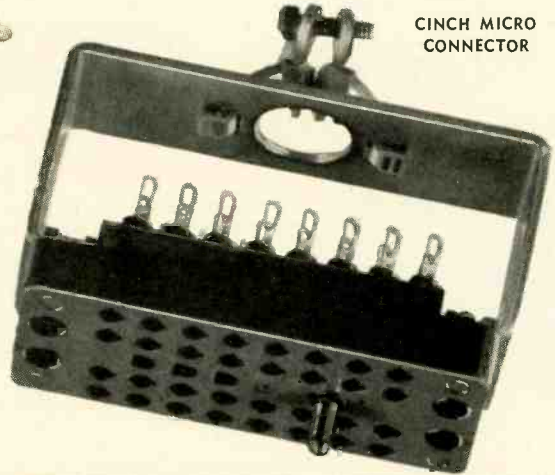

CINCH MICRO
CONNECTOR



Jones

HOWARD B. JONES DIVISION

CINCH MANUFACTURING CORPORATION

1026 S. HOMAN AVE. • CHICAGO 24, ILLINOIS

A steadily expanding variety of plugs and sockets as produced at Jones Division have a wide range of the highest quality electrical and mechanical parts to efficiently fill the need. Some indication of extensive use of these parts is shown in the photographs on this page.

SEND FOR COMPLETE CATALOG

Cat. No. 18 will give you complete data (electrical characteristics, etc.). Your request for this catalogue or for quotes on special products will be promptly answered.



JONES
FANNING
STRIPS

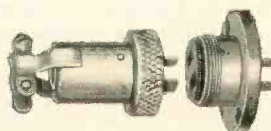

JONES PLUGS AND SOCKETS



JONES BARRIER TYPE
TERMINAL STRIPS



Cinch
ELECTRONIC
COMPONENTS



THE COMBINED PLANT
OF CINCH-JONES

**CINCH
JONES**
are **READY---**

Specialists in . . .

METAL-PLASTIC ASSEMBLY

To produce the intricate assemblies of metal and plastic so essential in gear of all kinds, their facilities include a combination of metal stamping and plastic production. A highly trained staff skilled in this type of work is available for *any* military or commercial requirement.

TYPICAL EXAMPLES: The list below comprises the products of both Cinch and Jones. They are indicative of their wide scope and also indicate the myriad of variations and redesigning that are possible with this background of production experience.

SOCKETS, Tube (Receiver, Transmitter and Special): Battery, all types • C-R Tube • Crystal • Electrolytic • Glass Type; 4 to 7 prong laminated • Infra-red Ray Tube • High Altitude Airborne Types • Kinescope; Magnal, Duodecal, Diheptal • Loktal-Miniature-Multiplug-Noval-Octal (Molded bakelite, steatite and laminated) • Plexicon • Printed Circuit • Special Sockets to Specs • Sub-Miniature; Hearing Aid Types • TV; 110V Circuit Breakaway • Vibrator

ANTENNA JACKS
BANANA PINS AND JACKS
BARRIER TERMINAL STRIPS
FANNING STRIPS
BATTERY PLUGS & SOCKETS
BINDING POSTS
CONNECTORS, MULTI CONTACT
FUSE STRIPS, BLOCKS & BOARDS
GRID CAPS
GRID CAP SHIELDS
HERMETICALLY SEALED TUBE SOCKETS

METAL STAMPINGS
MICRO-CONNECTORS
MOUNTING DEVICES
PHONO TIP JACKS
PRINTED CIRCUIT, CONNECTORS
SHIELDS, TUBE-MINIATURE & NOVAL & BASES SOLDERING LUGS—200 VARIATIONS
STRAP NUTS
TUBE HOLDERS—SPRING TYPE
VIBRATOR PLUGS AND SOCKETS

TERMINAL ASSEMBLIES: Blocks, boards in laminated and molded, assembled with lugs, pins, screw terminals, contacts, clips, turret lugs and other hardware to specifications.

. . . TO DESIGN

Military version of *any* commercial electronic component from their vast resources. They are equipped to produce and are already in production on many variations of standard electronic components for military use, guided missiles, radar, gun fire control, etc. A special staff of engineers are daily working in close cooperation with the military on redesigning components to the most rigid specifications.

. . . TO PRODUCE

Any component assembly needed in electronic mobilization that falls within the engineering and production facilities of their vast plant. Their organization is extremely flexible, readily adapted to the requirements of military or commercial emergencies. Also readily available are adequate production facilities, development, design and production engineering personnel. Consult them today.

PACKAGED Functional Electronics

Components for Control Systems

mecha products

Servomechanisms Inc. designs, engineers and manufactures electronic control devices for military and commercial applications.

These devices are composed of a number of functional electronic units, which are miniaturized and packaged as plug-in components.

Control equipment is readily synthesized from these small component packages which solve the important system requirements of:

- *Spatial adaptability*
- *Instant maintainability*
- *Training simplicity*
- *Ease of manufacture*

SERVOMECHANISMS
INC.

Post & Stewart Aves., Westbury, N. Y.

El Segundo, Cal. — Fort Lauderdale, Fla.

*Trajona t

Tophet

RESISTANCE WIRE

de-ices the new television

"TOTEM POLE"

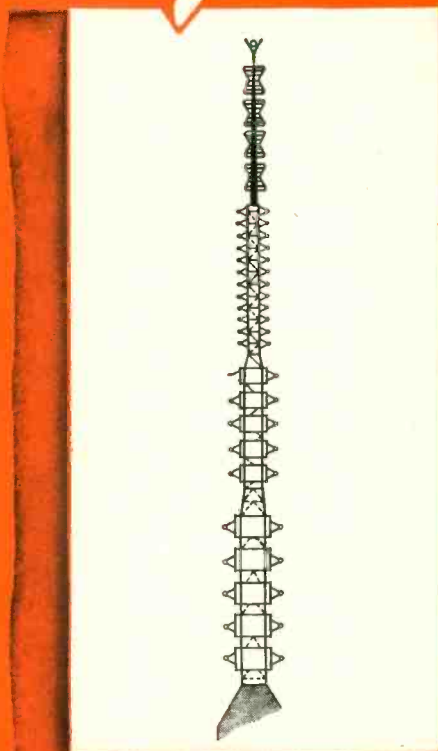

**—towering
above the
Empire State
Building in
New York City**

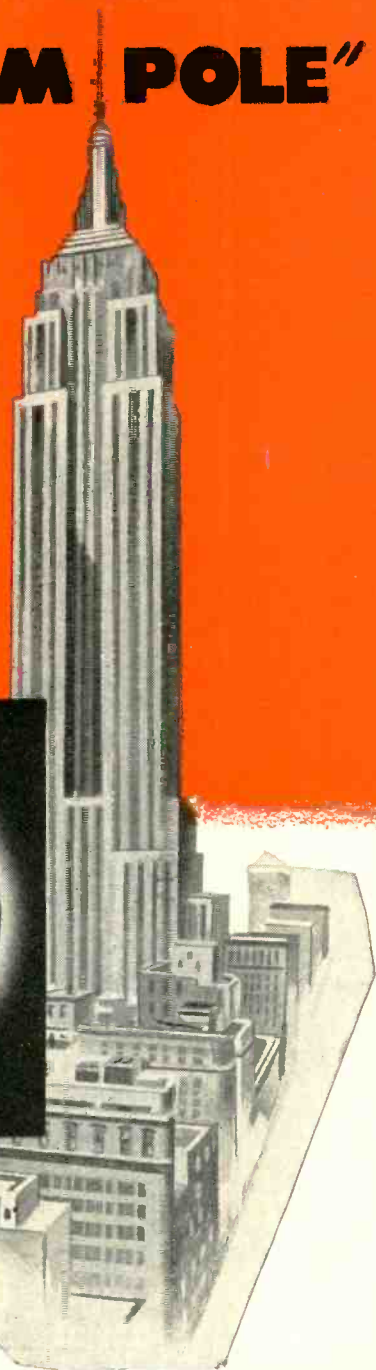

The new five channel "totem pole" antenna atop the world's tallest building posed many difficult-to-solve problems. One of these — severe icing conditions — was solved with specially-designed de-icers, manufactured by Electro-Therm, Inc., of Silver Spring, Maryland and installed by RCA engineers. Tophet heating elements in the de-icers effectively prevent ice accumulations. Wherever an extra margin of dependability is required, engineers specify Tophet for greater dependability. For Tophet Resistance Wire has been proven

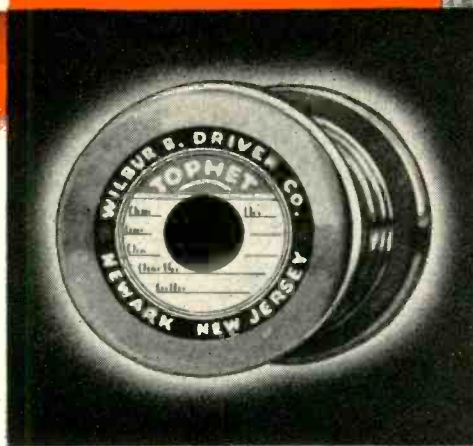

over the years to provide top heat and top performance in applications ranging from household appliances to heavy duty industrial furnaces.

It's TOPHET for Top Heat



WILBUR B. DRIVER COMPANY

150 RIVERSIDE AVENUE, NEWARK 4, NEW JERSEY

A Complete Line of POWERSTAT

VARIABLE TRANSFORMERS AT YOUR SERVICE

POWERSTAT variable transformers are autotransformers of toroidal core design with a movable brush tap which rotates to deliver a continuously adjustable output voltage from a-c power lines. Features of every POWERSTAT are excellent regulation, high efficiency, conservative ratings, zero waveform distortion, rugged mechanical construction, smooth control and standard mountings. Numerous types are available for 115, 230 and 460 volts, single and three phase operation in ratings from 405 VA to 100 KVA. Most models are offered for either manual or motor-driven operation. In the chart are listed some of the standard types. In addition, oil-cooled and explosion-proof types are available. Therefore, if one of the units listed does not suit your particular need, consult us. There's a POWERSTAT for every variable a-c voltage control requirement.

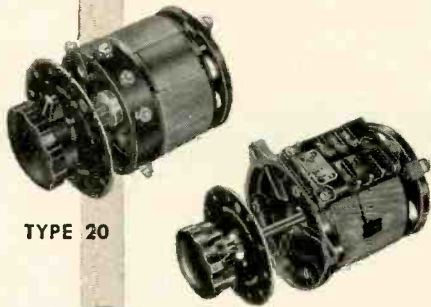

TYPE 20

TYPE 116U



TYPE 116

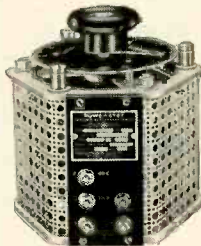

TYPE 1226



TYPE 2PF1126

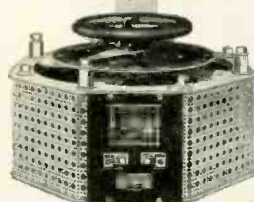

TYPE 1156



TYPE MZ1126-3Y

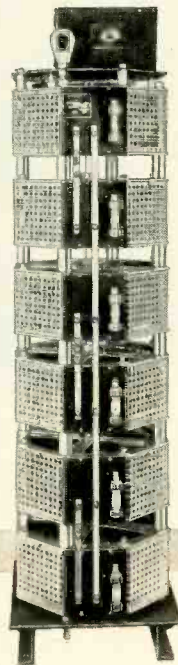

TYPE MW1156-6

Line Volt.	Output Volt.	Max. Output Amp.	Output KVA	Frequency	Type	Approximate Net Wt. (Lbs.)	Shipp. Wt. (Lbs.)	**Standard Motor Speeds
115	0-135	3.0	0.4	160	*20	4	6	
	0-135	7.5	1.0	50/60	*116U	10	11	
	0-135	7.5	1.0	50/60	116	11	12	T
	0-135	7.5	1.0	50/60	3PF116	11	12	
	0-135	7.5	1.0	50/60	3TF116	11	12	
	0-135	15.0	2.0	50/60	1126	21	25	W,X,Y,Z
	0-135	15.0	2.0	50/60	F1126	21	25	W,X,Y,Z
	0-135	30.0	4.0	50/60	1126-2P	48	55	W,X,Y,Z
	0-135	45.0	6.1	50/60	1156	73	80	W,X,Y,Z
	0-135	45.0	6.1	50/60	F1156	74	81	W,X,Y,Z
	0-135	90.0	12.1	50/60	1156-2P	150	170	W,X,Y,Z
	0-135	135.0	18.2	50/60	1156-3P	225	295	W,X,Y,Z
	0-135	180.0	24.3	50/60	1156-4P	330	420	W,X,Y
	0-135	270.0	36.4	50/60	1156-6P	500	600	W,X,Y
230	0-270	3.0	0.81	50/60	*216U	10	11	
	0-270	3.0	0.81	50/60	216	11	12	T
	0-270	3.0	0.81	50/60	3PF216	11	12	
	0-270	3.0	0.81	50/60	3TF216	11	12	
	0-270	7.5	2.0	50/60	*116U-2S	17	22	
	0-270	7.5	2.0	50/60	116-2S	18	23	T
	0-270	9.0	2.4	50/60	1226	25	29	W,X,Y,Z
	0-270	9.0	2.4	50/60	F1226	25	29	W,X,Y,Z
	0-270	15.0	4.0	50/60	1126-2S	45	52	W,X,Y,Z
	0-270	28.0	7.5	50/60	1256	73	80	W,X,Y,Z
	0-270	28.0	7.5	50/60	F1256	74	80	W,X,Y,Z
	0-270	45.0	12.1	50/60	1156-2S	144	164	W,X,Y,Z
	0-270	56.0	15.1	50/60	1256-2P	150	170	W,X,Y,Z
	0-270	84.0	22.7	50/60	1256-3P	225	295	W,X,Y,Z
0-270	112.0	30.2	50/60	1256-4P	330	420	W,X,Y	
0-270	168.0	45.3	50/60	1256-6P	500	600	W,X,Y	
460	0-540	3.0	1.6	50/60	216U-2S	17	22	T
	0-540	3.0	1.6	50/60	216-2S	18	23	
	0-540	9.0	4.9	50/60	1226-2S	53	60	W,X,Y,Z
	0-540	28.0	15.1	50/60	1256-2S	144	164	W,X,Y,Z
	0-540	56.0	30.2	50/60	1256-4PS	330	420	W,X,Y
0-540	84.0	45.3	50/60	1256-6PS	500	600	W,X,Y	
Three Phase	0-135	3.0	0.7	160	*20-2D	9	15	
	0-135	7.5	1.8	50/60	*116U-2D	17	22	
	0-135	7.5	1.8	50/60	*116-2D	18	23	T
	0-135	15.0	3.5	50/60	1126-2D	45	52	W,X,Y,Z
	0-135	45.0	10.5	50/60	1156-2D	144	164	W,X,Y,Z
	0-135	90.0	21.0	50/60	1156-4D	320	410	W,X,Y
	0-135	135.0	31.6	50/60	1156-6D	490	590	W,X,Y
	230	0-230	3.0	1.2	60	20L-3Y	15	24
0-270		3.0	1.4	50/60	*216U-2D	17	22	
0-270		3.0	1.4	50/60	*216-2D	18	23	T
0-270		7.5	3.5	160	*116U-3Y	26	36	
0-270		7.5	3.5	160	*116-3Y	27	37	T
0-270		9.0	4.2	50/60	1226-2D	53	60	W,X,Y,Z
0-270		15.0	7.0	160	1126-3Y	65	75	W,X,Y,Z
0-270		28.0	13.1	50/60	1256-2D	144	164	W,X,Y,Z
0-230		45.0	17.9	50/60	1156L-3Y	215	280	W,X,Y,Z
0-270		56.0	26.2	50/60	1256-4D	320	410	W,X,Y
0-270		84.0	39.3	50/60	1256-6D	490	590	W,X,Y
0-230	90.0	35.8	50/60	1156L-6Y	500	600	W,X,Y	
460	0-540	3.0	2.8	160	*216U-3Y	26	36	
	0-540	3.0	2.8	160	216-3Y	27	37	T
	0-540	9.0	8.4	160	1226-3Y	76	86	W,X,Y,Z
	0-540	28.0	26.2	160	1256-3Y	215	280	W,X,Y
	0-540	56.0	52.5	160	1256-6Y	500	600	W,X,Y

* These units are supplied with an "L" terminal which allows connecting in the field to limit the output voltage to the applied voltage. If "L" type connection is required on other models, the "L" must be included in the type number when ordering.

† When these POWERSTATS are "L" connected so that the output voltage does not exceed the applied voltage, the frequency range is 50/60 cycles.

** When a motor-drive is required, prefix the letter "M" together with the speed designation letter to the type number; T — 5 seconds, Z — 6 seconds, Y — 14 seconds, X — 19 seconds and W — 45 seconds for full range travel. Since the driving motors are frequency sensitive, be sure to specify whether 50 or 60 cycles is required. Only manually-operated unit weights are listed. For motor-drives add 10, 11 and 14 pounds to the 116-216, 1126-1226 and 1156-1256 types, respectively.

WRITE FOR POWERSTAT BULLETIN P 550

STABILINE *Automatic* VOLTAGE REGULATORS

Two types of STABILINE automatic voltage regulators are built by The Superior Electric Company to meet the requirements of maintaining constant voltage to electrical equipment.

TYPE IE INSTANTANEOUS ELECTRONIC

Completely electronic, instantaneous in action, with no moving parts. Waveform distortion never exceeds 3%. Output voltage is held to within ± 0.1 per cent of nominal for wide line variations; to within ± 0.15 per cent of nominal for any load current change or load power factor change from lagging .5 to leading .9. Standard types listed below.

TYPE IE51002R

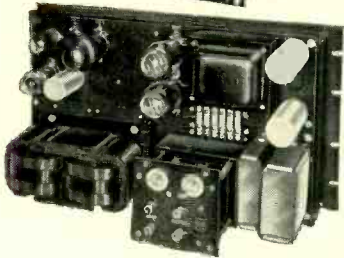
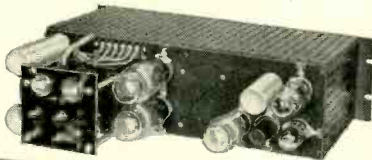

TYPE IE5101R

TYPE EM ELECTRO MECHANICAL

Consists of an electronic detector circuit controlling a motor-driven POWERSTAT variable transformer which feeds a buck-boost auxiliary transformer. Features zero waveform distortion together with insensitivity to magnitude and power factor of load. Has no effect on system power factor. Constant output voltage is maintained regardless of variations in input voltage or load current.



TYPE EM4115

RATINGS TYPE IE

Input Voltage Range	Output Voltage Range	Frequency In Cycles	Load Range In Amperes	Load Power Factor Range	Rated Output KVA	Type
95-135	110-120	60 \pm 10%	0 - 2.2	.5 lagging	0.25	IE51002
95-135	110-120	60 \pm 10%	0 - 2.2		0.25	IE51002R
95-135	110-120	60 \pm 10%	0 - 4.5		0.5	IE51005
95-135	110-120	60 \pm 10%	0 - 4.5		0.5	IE51005R
95-135	110-120	50 \pm 10%	0 - 4.5		0.5	IE51005R
95-135	110-120	50 \pm 10%	0 - 4.5		0.5	IEL51005R
195-255	220-240	50 \pm 10%	0 - 2.2		0.5	IEL52005
195-255	220-240	50 \pm 10%	0 - 2.2		0.5	IEL52005R
95-135	110-120	60 \pm 10%	0 - 8.5		1.0	IE5101
95-135	110-120	60 \pm 10%	0 - 8.5		1.0	IE5101R
95-135	110-120	50 \pm 10%	0 - 8.5	1.0	IEL5101	
95-135	110-120	50 \pm 10%	0 - 8.5	1.0	IEL5101R	
195-255	220-240	50 \pm 10%	0 - 4.5	1.0	IEL5201	
195-255	220-240	50 \pm 10%	0 - 4.5	1.0	IEL5201R	
95-135	110-120	60 \pm 10%	0 - 22.0	2.5	IE5102	
95-135	110-120	60 \pm 10%	0 - 22.0	2.5	IE5102R	
195-255	220-240	60 \pm 10%	0 - 11.0	2.5	IE5202	
195-255	220-240	60 \pm 10%	0 - 11.0	2.5	IE5202R	
195-255	220-240	50 \pm 10%	0 - 11.0	2.5	IEL5202R	
95-135	110-120	60 \pm 10%	0 - 43.5	5.0	IE5105	
195-255	220-240	60 \pm 10%	0 - 22.0	5.0	IE5205	

RATINGS TYPE EM

Nominal Output Voltage	Input Voltage Range	Output Voltage Range	Output Current (Amperes)	Output KVA	Type
Single Phase 115	95-135	110-120	17.5	2.0	EM4102
			52.0	6.0	EM4106
			130.0	15.0	EM4115
230	195-255	220-240	32.5	7.5	EM4207
			120.00	27.5	EM4228
460	400-520	420-460	15.0	6.6	EM4407
			40.0	17.6	EM4418
Three Phase 230	195-255	220-240	25.0	10.0	EM6210Y
			38.0	15.0	EM6215Y
			50.0	20.0	EM6220Y
			113.0	45.0	EM6245Y
			175.0	70.0	EM6270D
460	400-520	420-460	16.0	12.5	EM6412Y
			22.0	17.5	EM6417Y
			33.0	25.0	EM6425Y
420-500	420-460	420-460	66.0	50.0	EM6450Y
			100.0	75.0	EM6475Y
			131.0	100.0	EM64100Y



VARICELL D-C POWER SUPPLIES

provide a stabilized and regulated variable d-c output voltage from a-c power lines. Not affected by line or load changes.

TYPE 13015



VOLTBOX A-C POWER SUPPLIES

are a compact portable source of variable a-c voltage. Type UC1M operates from 115 volts, 50/60 cycles, single phase lines and delivers 0-135 volts, 7.5 amps. output; Type UC2M from 230 volts, 50 60 cycles, single phase lines to deliver 0-270 volts, 3.0 amps.

TYPE UC1M

5-WAY BINDING POSTS

available in black and red for permanent clamping, spade lug, clip-lead, banana plug, or looping and clamping.



5-WAY BINDING POST

Write 4000 Church Street for Product Literature.



WRITE FOR STABILINE BULLETIN S 351



BRUSH AND CONTACT

Materials for Exacting Applications

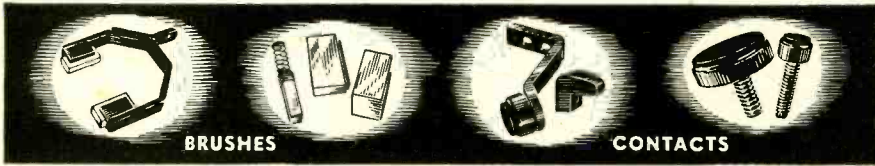

The GRAPHALLOY family of metal-impregnated graphite brush and contact materials is specially designed for a wide range of applications requiring very low contact drop, very low electrical brush noise level or non-welding contact operation. Made by impregnating metals into solid graphite, they are inherently fitted for high speed, high altitude applications and for low-current circuits. Certain types are valuable for their arc-quenching characteristics in opening inductive circuits.

A few of the more commonly used types are given in the following table:

	LOW-METAL GRADES	
Material	Typical Current Density* Amperes per Square Inch	Typical Rubbing Speeds Feet per Minute
Silver GRAPHALLOY	100-150 and higher	5000
Copper GRAPHALLOY	90	3000
Cadmium GRAPHALLOY	75	4000
	HIGH-METAL GRADES	
Copper GRAPHALLOY	100-125	3000
Special Copper GRAPHALLOY	150	3000

*Depending on brush size.

Silver GRAPHALLOY, the supreme brush material, is widely used in brush applications where low, constant contact drop and low resistance are needed and where a low electrical noise level is imperative. Its high quality results from the use of extremely pure silver for impregnation into the graphite. Adapted for high-altitude brush applications and for low current circuits. It operates best against coin-silver slip rings.

As a non-welding contact material, Silver GRAPHALLOY is valuable in circuits where a low and constant contact drop are necessary or where contact welding must be prevented.

Copper GRAPHALLOY — This material is widely used as brush material for small and medium sized motors and generators where long brush and commutator life are important.

As a contact, certain types are extensively used for arcing and main contact tips in circuit breakers and contactors.

Cadmium GRAPHALLOY — This material is particularly adapted for commutating or opening circuits which are subject to heavy inductive arcing. The arc quenching characteristics of

the Cadmium vapor which is released during arcing make this material very valuable for high duty contactors and for brush applications where wear conditions and arcing are severe.

HIGH METAL TYPES

Copper GRAPHALLOY is extensively used for rotary converter slip ring brushes, plating generator brushes and for other applications requiring extremely high current carrying capacity with low or moderate friction.

Special Copper GRAPHALLOY grades have been developed for contacts which are required to carry extremely high operating current without overheating and without sacrificing arc-quenching qualities.

APPLICATION DATA

Upon receipt of a brief description of your contact or brush problem we shall be glad to suggest a suitable design and material. We suggest that you send the current and voltage conditions, proposed rubbing speed, commutator or slip ring width and material. Send for our special brush inquiry sheet which outlines the required information.



Use GRAPHALLOY for

OILLESS BUSHINGS

CHARACTERISTICS OF COMMONLY USED GRAPHALLOY GRADES

Material	Maximum Ambient Temperature	
	In Air	In non-oxidizing conditions
Babbitt GRAPHALLOY	300	300
Copper "	700	1700
Bronze "	600	600
Cadmium "	250	550
Silver "	700	1500

Coefficient of friction, .12 to .25, dry; .02 to .13 submerged.

Specify GRAPHALLOY materials which contain no oil and need no oil for efficient operation dry, submerged in liquids, or at extremely high or low temperatures where ordinary lubricants would carbonize, congeal or decompose.

Excellent for current carrying bushings.

Widely used for pump bushings and vanes, seal rings, stoker and high temperature conveyor bushings.

Ideal for use where ordinary bushing lubricants would contaminate food products.

Send for further information. Or, if you have a specific application, supply us the details of speed, load, shaft material and temperature conditions and we shall be glad to make recommendations or supply test samples.

Call on the accumulated design experience of our engineers for help in solving your problem.

GRAPHITE METALLIZING CORPORATION

1041 NEPPERHAN AVE • YONKERS, NEW YORK

MERCOID

SOLVES INDUSTRY'S AUTOMATIC CONTROL PROBLEMS



THE ONLY 100% MERCURY SWITCH EQUIPPED CONTROLS

The distinguishing feature of Mercoid Controls is the exclusive use of Mercoid hermetically sealed mercury switches. These switches are not subject to dust, dirt or corrosion, thereby assuring better performance and longer control life.



Pressure



Thermostats Line Voltage



Temperature



Explosion Proof

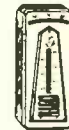

Thermostats Low Voltage



Liquid Level

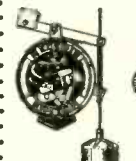

Fleet Operated



Oil Burner Safety



Transformer-Relay

If you have a control problem involving the automatic control of pressure, temperature, liquid level, mechanical operations, etc., it will pay you to consult Mercoid's engineering staff—always at your service.

Complete Mercoid Catalog sent upon request.

THE MERCOID CORPORATION, 4201 BELMONT AVE., CHICAGO 41, ILL.

Included in the
DIRECTORY SECTION
of this Issue
is a list of more than

850

DISTRIBUTORS OF
ELECTRONIC COMPONENTS
and
ELECTRONIC EQUIPMENT

They are ready and
willing to serve you.

When ordering, be sure
to mention the . . .

electronics
BUYERS'
GUIDE

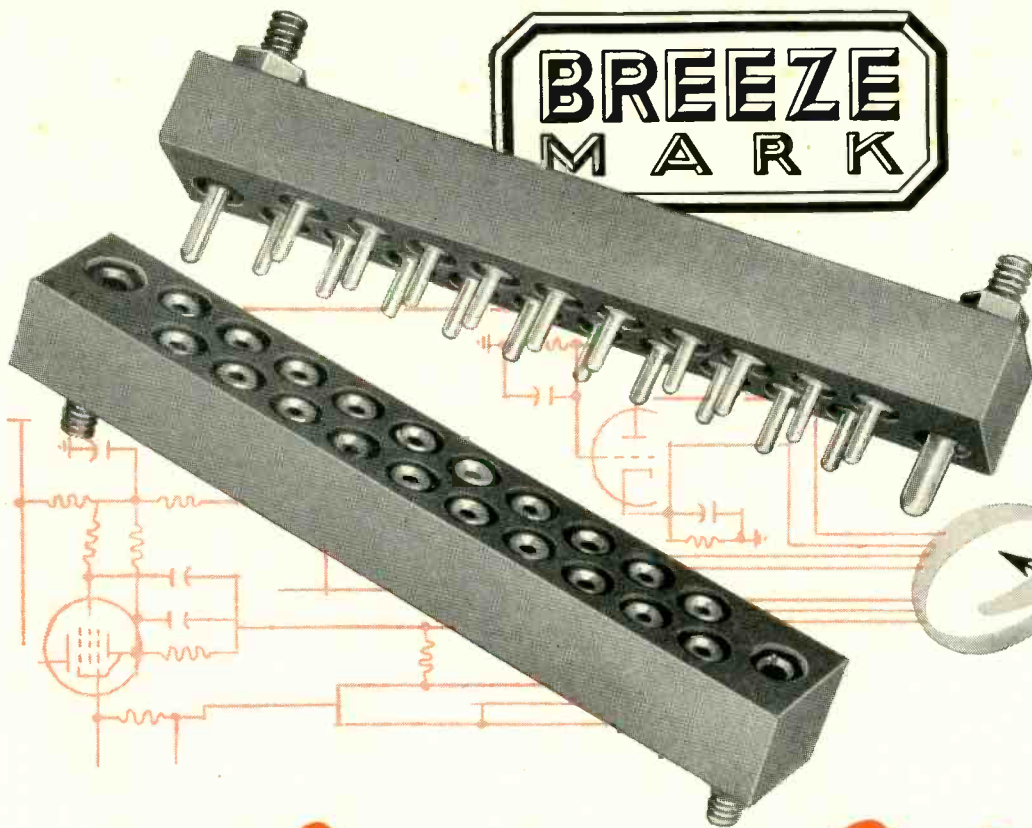

Connector Problem?

...We'll take it from **HERE**

Good ideas for electronic circuitry sometimes run afoul of connector problems. Maybe existing connector units won't hold air pressure gradients, won't stand the heat, aren't rugged enough for the job. Or maybe it's a question of altitude, or under-water application. But if you can sketch the circuit, we'll take it from there. We've engineered so many special connectors, solved so many "impossible" problems, that whatever the requirements are, we can usually provide the answer.



Lightweight actuators for any requirement.



Job engineered, welded diaphragm bellows.



Flexible conduit and ignition assemblies.



Aero-Seal vibration-proof hose clamps.

WRITE TODAY for specific information, or send us your sketches. We'll forward recommendations promptly.

BREEZE Special CONNECTORS

BREEZE CORPORATIONS, INC.

41 South Sixth Street

Newark, New Jersey

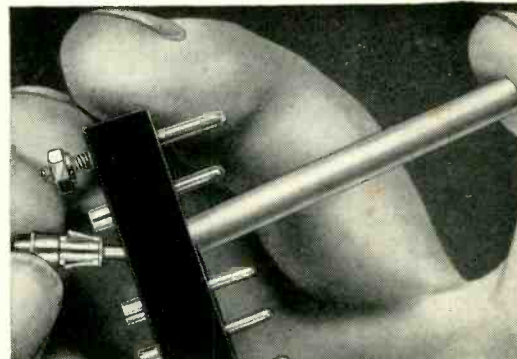

Removable pins in Breeze connectors speed soldering, save time, trouble. Pins snap back into block.



FIXED and VARIABLE HIGH VOLTAGE VACUUM CAPACITORS and SWITCHES

SPECIFICATIONS

FIGURES	NICKEL TYPES	COPPER TYPES	CAPACITY MMFD.	PEAK VOLTAGE KILOVOLTS	RMS AMPERES		OVERALL LENGTH	MAXIMUM O. D.	CONTACT DIAMETER	MOUNTING CENTERS	
					NICKEL	COPPER					
2	VC	VCC	6, 12, 25, 50, 75, 100, 150	20, 25, 30	14	42	6 1/2	2 1/4	13/16	5 7/8	
2	VC	VCC	200, 250	20, 25, 30	14	42	6 1/2	2 1/16	13/16	5 7/8	
15	W		6, 12, 25, 50, 100	20	10.5		4 3/16	2 1/4	3/8	3 3/8	
18	X		5, 10, 15, 20, 25	17	7		3 1/4	1 1/4	11/32	2 7/8	
19	Y		1, 2, 3, 4, 5	17	7		3 1/4	7/8	11/32	2 7/8	
21		JCS-1	25, 50, 75, 100, 150	7.5, 10, 15		28	3 5/8	2 1/32	55/64	3	
32		JCS-2	5-10-20-50	10, 15, 20		21	2 11/16	1 7/16	3/8	1 25/32	
31		JCS	250	7.5, 10, 15		42	3 5/8	2 5/8	55/64	3 1/8	
31		JCS	500	7.5, 10		42	3 5/8	3 1/8	55/64	3 1/8	
13		JCS	1000	7.5, 10		42	5 1/4	3 1/2	2	4 1/8	
7		JC-2	25, 50, 100	15, 20, 25		42	3 3/4	3 1/4	51/64	3 1/8	
34		JC-3	20, 40, 50, 60	35, 40, 50, 60		140	8 1/4	4	2	6 5/8	
4		JC-4	100, 125	35, 40, 50, 60		175	9 1/4	5	3 1/8	7	
27		JC-5	200	35, 40, 50, 60		225	11 1/4	7	4 1/8	8 3/4	
3	M	MC	500, 750, 1000	10, 15, 20	21	60	8 3/8	5	2	6 1/4	
6	ML	MLC	500, 750, 1000	25, 30	21	60	9 1/4	5	2	7 1/4	
3	MH	MHC	200 or less	35, 40, 50	21	60	8 1/2	5	2	6 3/8	
33	MM	MMC	1500, 2000	10, 15	21	125	9 1/4	6 1/8	4 1/8	6 3/4	
33	MMH	MMHC	450	35, 40, 45	21	125	9 3/8	6 1/8	4 1/8	6 13/16	
22		MC-1	500-750-1000	10, 15		150	4 1/2	4 1/2	3 1/2	3 1/2	
10	K		12, 25, 50	35, 40, 50	14		8 1/2	3	13/16	7 3/4	
30		TRC-1	1-8, 2-10	15		30	4 1/4	1 3/8	1 3/8	2	
11	T		5-25	20	10.5		6 1/4	2 1/4	1/2 x 5/8	4	
11		TC	5-25	20		21	6 1/4	2 1/4	5/8	4	
24	TR		2-8	17	10.5		6 1/2	2 1/4	11/32 x 5/8	4	
24		TRCS	2-8	7.5, 10, 15		21	6 3/16	2 1/4	5/8	4	
23	SS		10-30 per section	25, 30, 35	7		6 1/8	3	11/32 x 5/8	3 7/8 x 2 3/4	
17		SSC-1	2-10 per section	10		15	6 1/16	2 5/8	9/16 x 5/8	1 1/2 x 3 7/8	
11	AT		10-50	20, 25, 30	10.5		6 1/2	3	1/2 x 5/8	4 3/16	
26		UCS	5-200	7.5, 10, 15		42	8 3/32	2 5/8	55/64 x 2	4 5/8	
26		UCS	10-300	7.5, 10, 15		42	8 3/4	2 5/8	55/64 x 2	4 5/8	
26		UCS	25-500	7.5, 10, 15		42	8 3/4	3	55/64 x 2	4 5/8	
26		UCSX	10-500	7.5, 10		42	6 3/4	3 3/4	55/64 x 3 1/8	5 3/4	
26		UCSX	25-700	7.5, 10		42	6 5/8	3 3/4	2 x 3 1/8	4 1/16	
26		UCSX	25-1000	7.5, 10		42	6 7/8	3 3/4	2 x 3 1/8	4 11/16	
25	U	UC	50-250	10, 15, 20	21	60	11 7/16	5	2	6 1/2	
25	UH	UHC	10-75	35, 40, 50	21	60	11 7/16	5	2	6 1/2	
25	UH	UHC	75-150	35, 40, 50	21	60	12	5	2	7 1/16	
12	UX	UXC	25-500	10, 15, 20	21	60	14	5	3 1/8	7 7/8	
12	UXH	UXHC	25-150	35, 40, 50	21	60	14 5/8	5	3 1/8	8 1/4	
8		UXC-1	25-500	10, 15		125	9	4 1/2	3 1/2	5 3/8	
5	VM	VMC	50-1000	10, 15	21	100	14	7	3 1/8	7 7/8	
14	VMM	VMMC	100-2000	10, 15	21	125	15 1/4	6 1/8	4 1/8	8 3/8	
14	VMMH	VMMHC	25-450	35, 40, 45	21	125	15 3/8	6 1/8	4 1/8	8 1/2	
16		TAS-4	Variable Capacitor in above ranges								
		500 JR	Tube EIMAC Type 4x500								
1		TAS-5	Variable Capacitor in above ranges								
		2500 JR	Tube EIMAC Type 3x2500								
			Also available in both air- and water-cooled units from 50 watts to 25 kilowatts. Write for details.								
30		R-1	Vacuum Relay	50		50	7	3	5/8	5 1/8	
30		R-2	Vacuum Relay	65		50	9	3	5/8	7 1/4	
29		R-4	Vacuum Relay	20		50	5 1/8	1 9/16	5/8	3 1/8	
29		R-6	Vacuum Relay	15		35	3 5/8	1 1/16	11/32	2 3/16	
28		Feed Thru	Up to 100 MMFD	20		21	6 3/8	2 5/8	17/32	5 1/2	
29			Vacuum Transformer 2:1 step-up to 40 kv.				5 3/4	2 1/4	11/32		

CURRENT RATINGS MAY BE INCREASED BY FORCED COOLING WITH ADEQUATE MOUNTINGS
CORRESPONDENCE INVITED FOR OTHER CAPACITIES AND VOLTAGES

JENNINGS RADIO MANUFACTURING COMPANY • 970 McLAUGHLIN AVE. • P. O. BOX 1278 • SAN JOSE 12, CALIFORNIA

Originators, Exclusive Designers and Producers of JENNINGS
**FIXED AND VARIABLE HIGH VOLTAGE VACUUM
CAPACITORS & SWITCHES**

Jennings
RADIO
VACUUM ELECTRONIC COMPONENTS

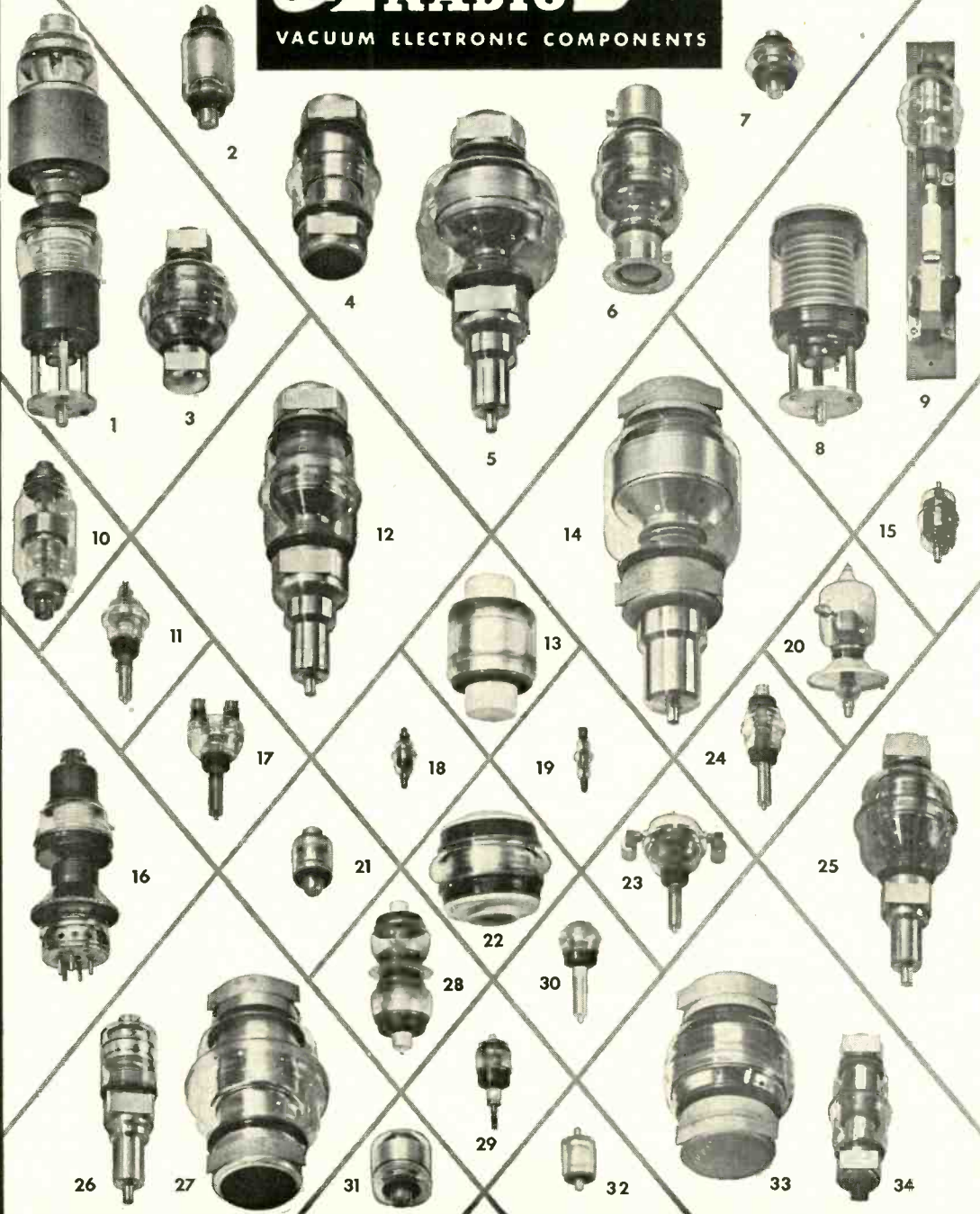

JENNINGS RADIO MANUFACTURING COMPANY • 970 McLAUGHLIN AVE. • P. O. BOX 1278 • SAN JOSE 12, CALIFORNIA

it's **FALSTROM** for
metal
forming-

Battery of
Medium Gauge
Steel Housings



1. CONTROL CENTERS
2. ENCLOSURES
3. CABINETS
4. PANELS



FALSTROM service is fast, competent, complete. It includes shearing, punching, forming, welding, assembly and finishing in thicknesses up to 1/4" plate.

Mechanics skilled in working with steel, aluminum and stainless steels assure finest workmanship. All work performed by FALSTROM is done by engineers and technicians thoroughly familiar with each phase of production.

FALSTROM equipment is in service throughout the electrical, chemical and petroleum industries—has been an accepted standard of excellence since 1870. For a practical, economical solution to your metal forming problems, go to FALSTROM!

TO GET ALL THE FACTS, FILL OUT AND MAIL THE HANDY COUPON BELOW

**FALSTROM
COMPANY**

44 FALSTROM COURT • PASSAIC, N. J.

Gentlemen:

Please send full information at once. I am interested in Nos. _____

NAME _____

TITLE _____

COMPANY _____

STREET _____

CITY _____ ZONE _____ STATE _____

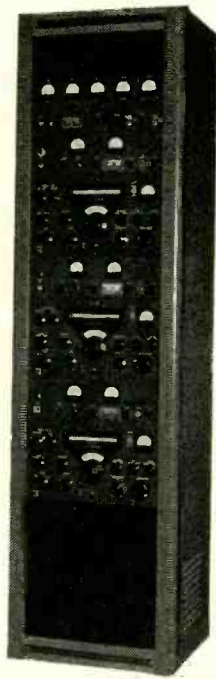

EXALTED-CARRIER DIVERSITY RECEIVER

*A new standard of performance
in high-frequency reception*

Combines all advantages of the best diversity reception plus new exalted-carrier detection which eliminates selective fading distortion and greatly reduces interference from interfering stations within the received channel.

Supplied in compact three-receiver combination with high continuity-of-service factor and switching flexibility.

New diversity selector chooses strongest of the three signals and completely rejects the weaker signals.

For reception of voice, program, or tone-multi-plex transmitted by either amplitude or phase modulation.

Exalted-carrier adapters also available for single-receiver use.

Inquiries invited

CROSBY LABORATORIES, INC.

126 HERRICKS ROAD

MINEOLA, N. Y.

Garden City 7-6487

FLOCKING ELECTROSTATICALLY

Turntables for Phonographs and Recorders

Finest in the Electronics Industry

Flocked Speaker Grilles, Vent Grilles of wire screen and perforated metal
Formed, Blanked, Punched to size

Flocked Back plates, Dial plates, Masks, Baffle boards

Flocked Trademarks, emblems and designs in three dimensional effects

MODERN EQUIPPED PLANT

Superior Work Guaranteed To Meet Your Specifications & Standards

FLOCK PROCESS COMPANY INC.

FACTORY: SPRINGDALE, CONN.

N. Y. Office: 53 W. 21 St., New York 10, N. Y.

• Phone: Oregon 5-2438 •

KURMAN RELAYS

Reliable • Powerful • Constant

For all types of Automatic Controls, Keying, Antenna Changeover, Burglar Alarms, Closed Circuit Applications.

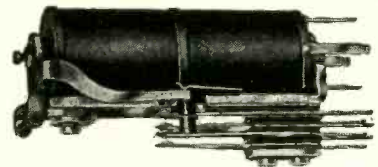

Class A (all other types available)

TELEPHONE Class A—Multicontact . . . Pin Hinge. Complete range of contacts up to 28 Springs. Wide variety of contact materials. Can be provided for slow operate, slow release, or slow acting. 4 x 1-7/32 x 1-1/8".

Sensitive Miniature Relay—Series 43 . . . Suitable for use in plate circuit and other control applications where low current consumption, small size, and adjustable contacts are important factors. DC sensitivity 30 to 18 milliwatts. Balanced armature. Contacts available—single pole double throw; also available in dust proof 5-prong container.

Prompt deliveries. Prices quoted on request.
Write for Issue 2.

KURMAN ELECTRIC CO., INC.

35-18 37th St.

Long Island City 1, N. Y.



Series 43

Let
Bendix
 Solve Your
 Problems

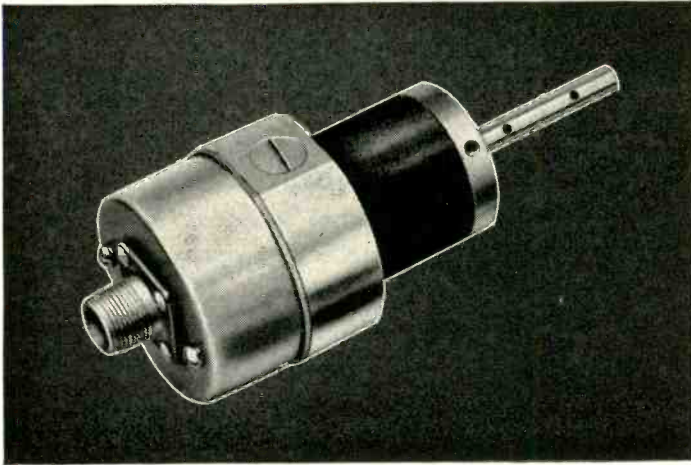

WITH
**SPECIALIZED
 DYNAMOTORS**
 AND
DC MOTORS

When you are faced with specifications that place impossible requirements on dynamotors or small DC motors, according to World War II standards, take advantage of recently developed improvements in high temperature and high altitude techniques by simply outlining your requirements to Bendix. Model units *exactly* meeting your performance specifications will be developed and tested for pre-production use—production units will then follow in accordance with your manufacturing schedule.

DYNAMOTORS

Regular • Multiple output • Special purpose

DC MOTORS

1/100 hp—1/2 hp • Continuous and Intermittent Duty
 DC Servos and special motors

RED BANK DIVISION OF BENDIX AVIATION CORPORATION
 RED BANK, NEW JERSEY

Export Sales: Bendix International Division, 72 Fifth Avenue, New York 11, N.Y.



Write for this colorful and informative book —it's free. You'll find it loaded with facts and figures about all types of dynamotors.

RECTIFIER TUBES

RUGGEDIZED BY
ECLIPSE-PIONEER
FOR ADDED RELIABILITY

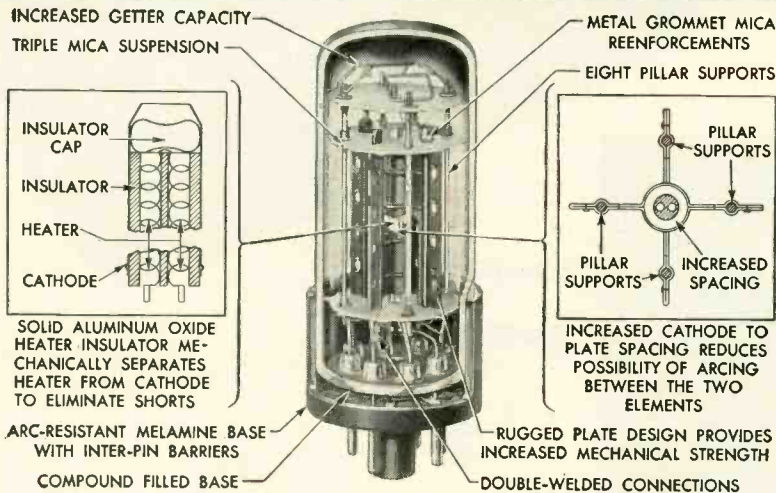

We are not in the standard vacuum tube business, but we are in the business of developing and manufacturing a reliable line of special purpose electron tubes—tubes that will serve and meet the stiff and varied operational requirements of aviation, ordnance, marine and other fields of modern industry. Typical of these are receiving type tubes such as Beam-Power Amplifiers, R-F Pentodes, Twin Triodes, and the Full-Wave Rectifiers illustrated above and described

below. All of these tubes are exhausted on a special automatic exhausting machine capable of extra high evacuation, and are aged under full operating and vibration conditions for a period of 50 hours. In addition to the tubes described above, Eclipse-Pioneer also manufactures special purpose tubes in the following categories: gas-filled control tubes, Klystron tubes, spark gaps, temperature tubes and voltage regulator tubes.

LOOK FOR THE PIONEER MARK OF QUALITY
REG. U. S. PAT. OFF.

Electrical Characteristics of E-P Full-Wave Rectifier Tubes

TUBE TYPE	R.M.A. 5838	R.M.A. 5839	R.M.A. 5852	R.M.A. 5993
Heater Voltage	12 volts	26.5 volts	6.3 volts	6.3 volts
Heater Current	0.6 amps.	0.285 amps.	1.2 amps.	0.80 amps.
Peak Inverse Voltage	1375 v. (max.)	1375 v. (max.)	1375 v. (max.)	1250 v. (max.)
Peak Plate Current (per plate)	270 ma. (max.)	270 ma. (max.)	270 ma. (max.)	230 ma. (max.)
D-C Heater-Cathode Potential	450 v. (max.)	450 v. (max.)	450 v. (max.)	400 v. (max.)
Cathode Heating Time	1 min.	1 min.	1 min.	45 sec.
Total Effective Plate Supply Impedance	150 ohms (min.)	150 ohms (min.)	150 ohms (min.)	150 ohms (min.)

Other E-P precision components for servo mechanism and computing equipment:

Synchros • Servo motors and systems • rate generators • gyros • stabilization equipment • turbine power supplies and remote indicating-transmitting systems.

For detailed information, write to Dept. C

ECLIPSE-PIONEER DIVISION of
TETERBORO, NEW JERSEY



Export Sales: Bendix International Division, 72 Fifth Avenue, New York 11, N. Y.

THIS IS THE

ONE BOOK

THE ONLY
ONE OF ITS KIND

In which design engineers and purchasing agents will find a complete, accurate, and up-to-date list of the manufacturers of all types of electronic and allied products... components and complete equipment.

Keep it handy for ready reference throughout the year.

When buying, or requesting product information be sure to mention . . .

**electronics
BUYERS'
GUIDE**

NEW
Linear Stabilized
PRESSUREGRAPH
MEASURES & RECORDS
EXPLOSION, GAS or
HYDRAULIC PRESSURE



For Jet or Internal Combustion Engines, Compressors, Pipe Lines, Injection Pumps and Explosions

Completely Re-engineered, it now provides greater accuracy in measuring and recording pressure-time studies of dynamic, static and transient pressure phenomena. In addition to its wide range (from a few ounces to 10,000 PSI) and broad frequency response (static or zero to over 20,000 CPS) it offers these new exclusive features:

Linear measurement. Drift stabilized. Temperature stabilized. 200,000 separate pressure measurements per second. Up to 200' of pick-up cable can be used. Greatly simplified adjustments on pick-up.

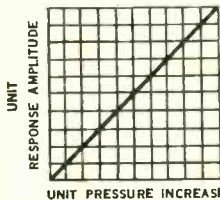

DYNAMIC MICROMETER

Measures Dynamic or Static Displacement, Vibration or Movement of Any Metal Body Without Physical Contact

Only accurate measurement for static or dynamic displacement due to eccentricity, axial vibration, radial whip, bearing clearance, radial expansion with acceleration and reciprocating movement. Measurements are independent of acceleration or speed of rotation.

Let Our Sales Engineers Help You



ELECTRO PRODUCTS LABORATORIES
 4513-LD Ravenswood Ave., Chicago 40, Illinois



SYNCHROS

PRECISION-BUILT BY

ECLIPSE-PIONEER

GUARANTEED ACCURACY TO WITHIN 15 MINUTES ON ALL PRODUCTION UNITS

For more than 17 years Eclipse-Pioneer has been a leader in the development of high precision synchros for aircraft, marine and industrial applications. Today, thanks to this long experience and specialization, Eclipse-Pioneer Autosyn* Synchros give you a *guaranteed* accuracy of 15 minutes (maximum) on all individual AY 200 type 400 cycle transmitters, differential generators, control transformers and resolvers. Furthermore, this phenomenal accuracy applies to *all production units* in this series. Where special applications are involved, Eclipse-Pioneer will supply Autosyn Synchros with an even *finer* degree of accuracy. And remember, when you buy from Eclipse-Pioneer, this high precision is yours at the lowest possible cost.

*REG. TRADE MARK BENDIX AVIATION CORPORATION

LOOK FOR THE PIONEER MARK OF QUALITY
 REG. U.S. PAT. OFF.

Typical Performance Characteristics for one AY-201-3 Autosyn Synchro when transmitting to:

	One Control Transformer	Two Control Transformers	Three Control Transformers
INPUT			
Voltage	26-volts, single-phase	26-volts, single-phase	26-volts, single-phase
Frequency	400 cycles per second	400 cycles per second	400 cycles per second
Current	105 milliamperes	130 milliamperes	155 milliamperes
Power	0.90 watts	1.4 watts	1.9 watts
Impedance	85-j240 ohms	80-j180 ohms	77-j149 ohms
OUTPUT			
Voltage max. (rotor output)	18.0 volts	15.5 volts	13.3 volts
Voltage at null	30 millivolts	20 millivolts	20 millivolts
Sensitivity	315 millivolts/degree	270 millivolts/degree	230 millivolts/degree
Voltage phase shift	18.5 degrees	24.5 degrees	28.0 degrees
System accuracy (max. possible spread)	0.5 degrees	0.5 degrees	0.5 degrees

Other E-P precision components for servo mechanism and computing equipment:

Servo motors and systems • rate generators • gyros • stabilization equipment • turbine power supplies • remote indicating-transmitting systems and special purpose electron tubes.

For detailed information, write to Dept. C

ECLIPSE-PIONEER DIVISION of
 TETERBORO, NEW JERSEY



Export Sales: Bendix International Division, 72 Fifth Avenue, New York 11, N. Y.

MARION

means the most
in meters

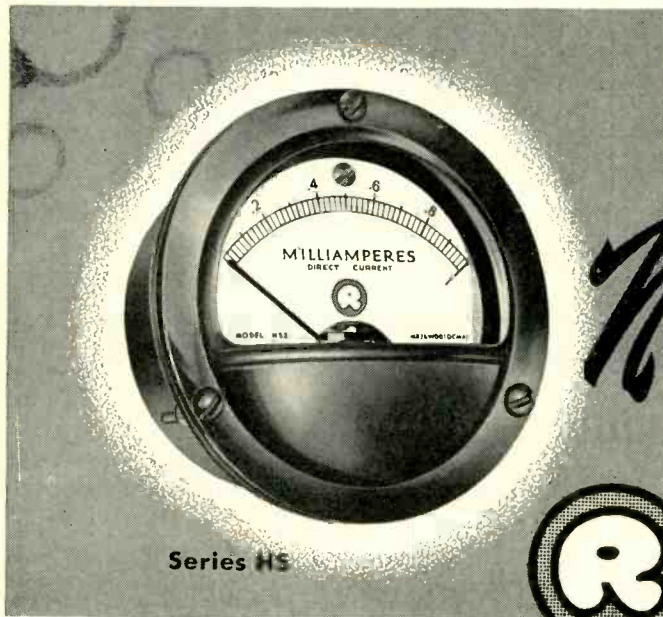

Series HS

New

MARION RUGGEDIZED METERS HERMETICALLY SEALED

Series HS

Standard 1½", 2½", 3½" Mr 26 Series, 3½" Mr 36 Series, and 4½" sizes. Extremely accurate and sensitive in any application, even under critical conditions of Shock, Vibration, Mechanical Stress, Strain, Weather Conditions and Climate. Gives faster response time, more sustained accuracy, lower bearing friction and longer life. Meet dimensional requirements of JAN-I-6. Completely interchangeable with standard 2½" and 3½" types.



Series HM

SEALED LIKE A VACUUM TUBE FOR GUARANTEED PERFORMANCE

Magnetically shielded. 2½" & 3½". Hermetically Sealed. Unaffected by heat, cold, humidity, giving peak performance with critical accuracy. Interchangeable round and square colored flanges for different panel needs. One year unconditional guarantee on materials and workmanship. Extra guarantee for replacement of burned out or abused hermetically sealed meter. (On flat fee basis, \$1.50 for 200 microamps upward; \$2.50 if more sensitive than 200 microamps.)

Large, 4⅝" × 4⅛". Gives critical readability on 100° scale. Alnico V magnets for sensitive range; heavy Alnico for standard ranges. Extreme accuracy assured. Designed for permanent and portable test equipment.

Marion Null Indicators are extremely sensitive shaded pole piece D'Arsonval type galvanometers. They are used primarily as bridge and potentiometer balance indicators and in any application where an instrument with very high sensitivity about the zero or balance point is desired. We particularly recommend Types HM2 and HM3 because they are hermetically sealed instruments which completely shield the galvanometers from the effects of moisture and dirt, and external factors. Ideal for use in discriminator alignment of FM receivers and as general laboratory balance indicators.

Space saver, yet has superior damping characteristics. Available in standard 2½" square (Model 52S). Dependable, extra strong — has well-aged Alnico magnet and heavy flanged construction. Popular for pocket test, portable radio, medical equipment and general electrical service where size and dependability count.



HM 2 HM 3



Model 55



Null Indicators



Model 52N

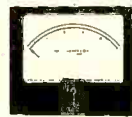

Model 56



Model 57S



Model 53SN

New 6½" × 5¼" bakelite cased meter. Easy reading at a distance. Large open face has 100° scale in 5½" arc. Room for multirange scale if needed. Milliamp ranges are Alnico II constructed, Alnico V for microamps. Strong, accurate, efficient, dependable.

Superb milliammeter — more than a mere overgrown 3 inch. 8½" × 7", open face, extra long scale. Enlarged pole shoes — higher torque movement — higher damping factor. Accurate within 1%. Used in large vacuum tube voltmeters, multitesters and production testing.

Standard commercial 3½" rectangular type. Also available in 3½" JAN Spec., round case. All Alnico construction. Excellent scale distribution characteristics. Ideal for portable test equipment and general electronic equipment application.

A Special Marion Service

In addition to manufacturing the finest standard electrical indicating instruments money can buy, Marion will design, engineer and manufacture precision products to meet your most exacting requirements. Let Us quote on your specifications. Write the Marion Electrical Instrument Company, 402 Canal Street, Manchester, New Hampshire.

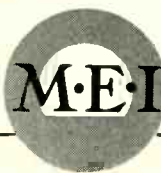

marion meters

MARION ELECTRICAL INSTRUMENT COMPANY 402 Canal Street, Manchester, New Hampshire. Export Division, 458 Broadway, New York 13, U.S.A., Cables MORHANEX. In Canada: The Astral Electric Company, 44 Danforth Road, Toronto, Ontario

**WINCHESTER
ELECTRONICS
INCORPORATED**

EXTREMELY COMPACT and LIGHTWEIGHT

CONNECTORS

(Standard or Your Specification)

Signal-Communication-Power

FOR ALL ELECTRONIC USES

**Hermetically
Sealed**



HM 14 P



HM 7 P

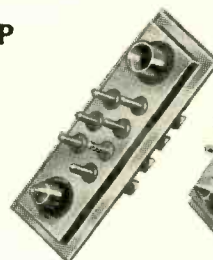

HMRE 7 P

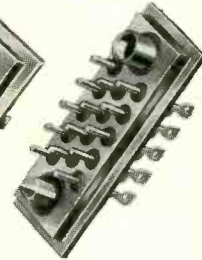

HMRE 14 P

Each contact separately sealed in glass.

(Illustrated actual size)

**Quick
Disconnect**

Patent No. 2,466,370

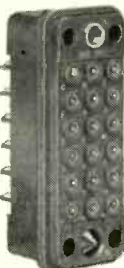

QRE 18 S



QRE 18 P

Each contact separately spring loaded.

(Illustrated one-half actual size)

**Pressure
Tight**

Patent No. 2,513,080

451



450

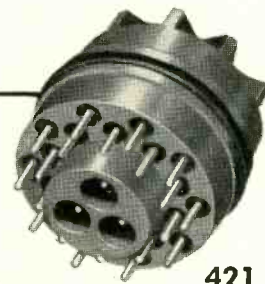

421

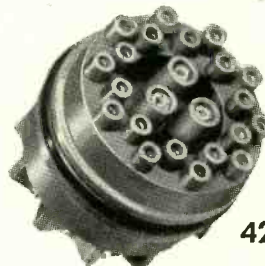

422

(Illustrated one-half actual size)

Each contact and insert has individual Neoprene ring.

WRITE FOR DETAILS:

We can help you with your more difficult connector problems.

Winchester Electronics
INCORPORATED

GLENBROOK, CONNECTICUT, U.S.A.



SYNCHRONOUS MOTORS - ELECTRIC TIMERS

A wide range of timing devices, extensively used on electrically-operated commercial and industrial equipment where accurate, dependable timing is essential to insure efficient product performance . . . to add convenience of operation . . . to prevent work spoilage and protect equipment itself. We are frequently called upon to design special equipment to meet specific requirements . . . consult us about your timing problems. Write for complete information.

The R.W. CRAMER Co., Inc., Box #27, Centerbrook, Conn.

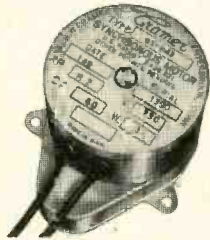

TYPE SX SYNCHRONOUS MOTORS — Widely used for instrument and control applications requiring constant speed at a given frequency. Powerful, precision-built. Produce an exceptionally high torque. Available with output speeds from 60 RPM to 1/24 RPH.

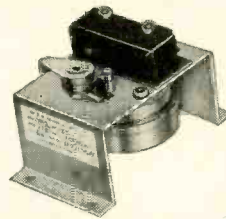

TYPE TF2 TIME DELAY RELAYS — Provide a fixed time delay between closing of control circuit and opening or closing of one or two load circuits. Used to protect high voltage electronic tubes, control of signalling devices, machines or process control, etc.

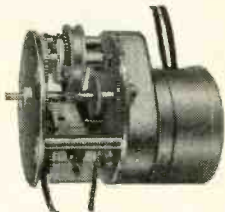

TYPES SCS-SCR CLUTCH MOTORS — Designed to meet the needs of many timing, recording, indicating and switching applications requiring reset operation. TYPE SCS — standard clutch type. Type SCR — reversible clutch type.

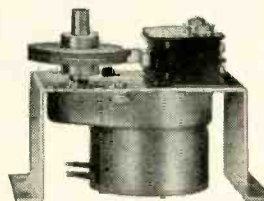

TYPES CF3-CF6 CYCLE TIMERS — For built-in applications where from one to eight circuits are to be controlled in accordance with a pre-determined program — commercial dishwashers, ice-making units, to reverse motors, to operate motors, solenoid valves, etc.



TYPE IE INTERVAL TIMERS — Setting to any desired time opens one load circuit, closes another, starting time cycle. Restores to normal position at end of time interval. Designed to control electrically operated equipment such as mixers, X-ray machines, ovens, plating processes, etc.



TYPE V PULSE TIMERS — Continuously electrical impulses of a definite set duration at end of successive identical time intervals. Used for control of automatic lubricators, conveyors, pumps, electron tube testing, etc.



TYPE IG INTERVAL TIMERS — Holds one or two circuits either open or closed for pre-set time and returns them to original position at end of interval. Used for built-in applications in microfilming equipment, battery chargers, therapeutic machines, etc.

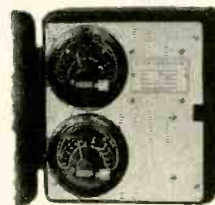

TYPE DU DUPLEX CYCLE TIMERS — Designed to open or close one or two load circuits continuously or to perform one complete cycle and stop. Used to control idle and running time of machines, periodic feeding of chemicals to boilers, etc.



TYPE RE RESET TIMERS — Automatically closes one circuit and opens another for a pre-set time when started. Used for control of process work where accuracy of repeat operation is required — on copying machines, laboratory equipment, photo printers, etc.



TYPE PE PERCENTAGE TIMER — Designed to control percent of time in which electrical circuit is closed or open out of definite time cycle. Used to regulate input to electrically operated furnaces, ovens or heaters, etc.



TYPE TE TIME DELAY RELAYS — Provides adjustable time delay between closing of control circuit and subsequent closing or opening of load circuit. Used to control heat treating equipment, shakers, etc.

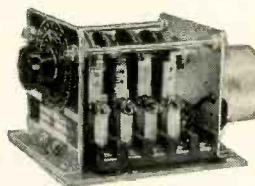

TYPE M MULTI-CONTACT TIMERS — Designed to control automatically a number of electrical circuits in pre-determined sequence. Used to control a series of machine operations, to reverse motors, valves, signals or combinations in sequence, etc.



TYPES TEC-TER TIME DELAY RELAYS — Provide an adjustable time delay between operation of a control circuit and subsequent closing or opening of load circuit. Used in industrial controls for heat treating, lapping, grinding, induction heating, mixing, etc.



TYPE E RUNNING TIME METERS — Designed to cumulatively register total operating or idle time of any circuit, machine or system. Used to record operating time of vacuum tubes, to forecast need for servicing of machines, etc.

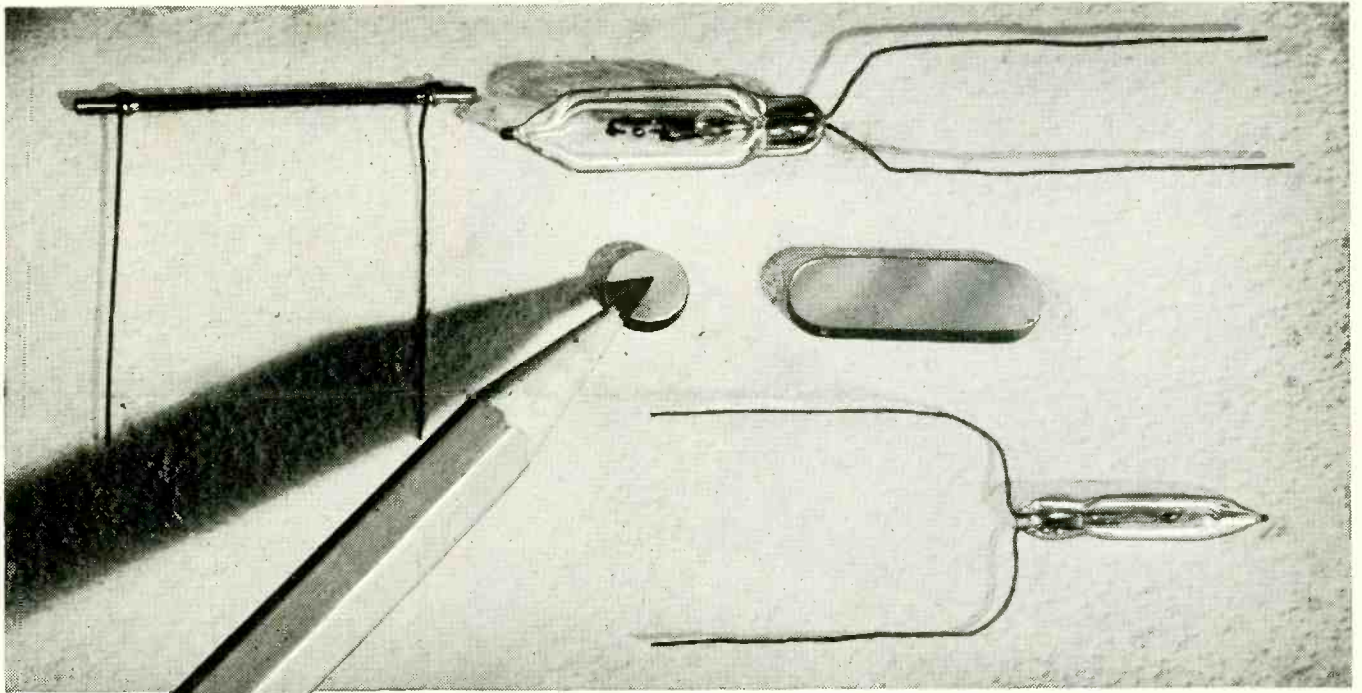

and now...

THERMISTORS

Ready to Revolutionize Control and Measurement

Effective immediately, VECO is licensed and geared to produce thermistors in any quantity to specification. Engineers familiar with the characteristics of thermistors will welcome a ready source of these new, extremely sensitive thermal resistors, and will appreciate VECO'S policy of maximum cooperation in engineering and production scheduling.

VECO is fully equipped both in design skills and production facilities to produce thermistors in a full range of types. Beads, washers, discs, rods—similar to familiar Western Electric types, or of advanced types for unlimited applications—can presently be produced to exacting specifications in line with your engineering requirements.

WRITE outlining your measurement or control problems, whatever the nature. Our engineers will study your needs and forward recommendations promptly.

Victory

Manufactured under license arrangement with Western Electric Company, Inc.

Engineering Corporation

744 Broad Street Newark, New Jersey

MARKet 3-0420

more and more... ENGINEERS specify

CINEMA RESISTORS

Precision wire wound non-inductive resistors have been a featured product of Cinema Engineering Company for over fifteen years. Now produced in over thirty-one styles... quarter watt to ten watt capacity... in accuracies of 1/20% to 1%. Temperature coefficients to .00002/degree C. Cinema Catalogue 14-R covers a most complete line of resistors for your laboratory and precision applications. Write for your copy today.

CINEMA SWITCHES

As manufacturer of custom built instrument rotary tap switches, we have an extremely broad experience in this field. Cinema has now tooled for a complete new series of switches under the type number CES. These will be available in a wide variety of combinations... interchangeable variety of parts allows for speedy delivery and economy of price. Built for instrument applications, these switches are "long" on performance and "short" on contact resistance. Bulletin C1014 tells the story... write for your copy today.

CINEMA CONTROLS

This year, as in every year in the past fifteen, Cinema has made steady progress to the ultimate in control design. New mechanical designs in construction have greatly enhanced the performance characteristics of all of our controls. Among this controls are variable attenuators... mixer controls... faders... decade units... potentiometers. We also make custom built non-linear step controls, slide-wire controls, impedance matching networks, and voltage ratio controls. Catalogue 11-AZ contains complete details. Write for your copy today.



CINEMA ENGINEERING COMPANY

1510 WEST VERDUGO AVENUE, BURBANK, CALIFORNIA

Export Agents: Frazer & Hansen, Ltd. • 301 Clay Street • San Francisco, Calif., U. S. A.

Use MODELECTRIC
Wiring Harnesses
Control Assemblies
& Wiring Assemblies
at Low Overall Cost

• Assembling electrical harnesses and controls may be costing you too much in time, money and plant space under to-day's competitive conditions. Then it's time to call on MODELECTRIC.

• We specialize solely in wiring assemblies for your APPLIANCE, DISPENSING EQUIPMENT, MACHINE TOOL, ELECTRONIC PRODUCT, etc. This includes connectors, terminals, coils, relays, controls, switches, etc.

• Our Engineers will be pleased to diagnose your problem, and custom build assemblies to your product AT SAVINGS to you. We will prove our point with a sample assembly to your specification at no obligation to you.

• With a Modelectric wiring assembly you can end your electrical worries and ACTUALLY PROFIT from Greater Economy, Proved Dependability, Precise Uniformity and 8 years of experience.

**Modelectric
Products Corp.**
ASBURY PARK, N. J.

this BOOK tells you
the MANUFACTURERS
of over 1400 types of
ELECTRONIC and
ALLIED PRODUCTS
from... ABRASIVES
to... YOKES, Deflection
and this year...



tells you where they are in production or available in a reasonable time and unrestricted for general industrial use.

**electronics
BUYERS'
GUIDE**

Please mention this book when
buying or inquiring from it.

Quick Service
From Stock on

CHICAGO

New Equipment
Transformers at the
following distributors:

California

Alhambra: Coast Electronics Supply Co.
Burbank: Fred S. Dean Co.
Long Beach: Fred S. Dean Co.
Los Angeles: Radio Products Sales, Inc.
Pasadena: Electronic Supply Corp.
San Diego: Shanks & Wright

District of Columbia

Washington: Electronic Wholesalers, Inc.

Illinois

Chicago: Allied Radio Corp.
Lukko Sales Corp.
Newark Electric Co.

Louisiana

New Orleans: Electronic Supply & Engineering Service, Inc.

Massachusetts

Boston: Radio Shack Corp.

Michigan

Ann Arbor: Wedemeyer Electronic Supply Co.

New Jersey

Newark: Continental Sales Co.
Federated Purchaser, Inc.

New York

Buffalo: Dymac, Inc.
N. Y. City: Harvey Radio Inc.
Hudson Radio & TV
Newark Electric Co., Inc.
Rochester: Hunter Electronics
Masline Radio & Electronic Equipment Co.
Syracuse: Stewart W. Smith, Inc.

Ohio

Dayton: Allied Supply Co.
Toledo: Lifetime Electronics

Oklahoma

Tulsa: Electronic Supplies

Pennsylvania

Philadelphia: Herbach & Rademan, Inc.

Texas

Austin: The Hargis Co.
Dallas: Wilkinson Bros.
Houston: Busacker Electronic Equipment Co.

Many other distributors stock Chicago Replacement Transformers and can supply your Chicago New Equipment Transformer needs.

the world's toughest transformers

wear these exclusive one-piece drawn-steel cases

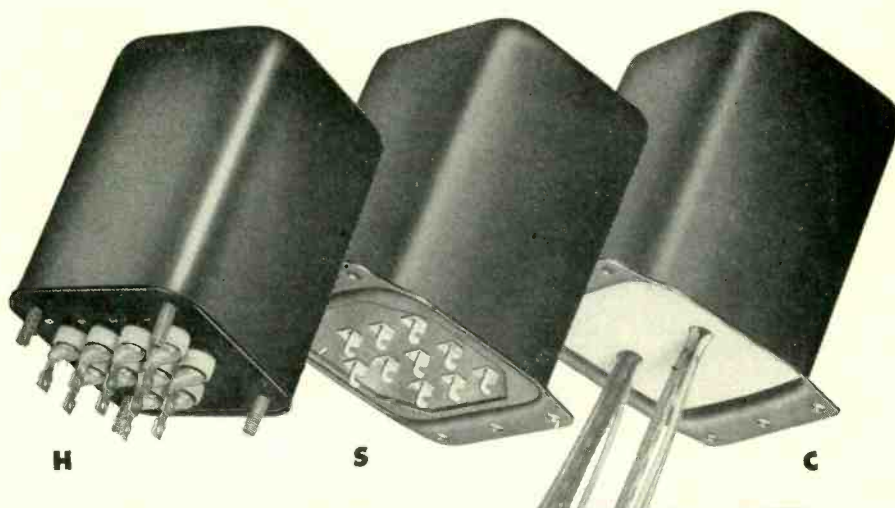

CHICAGO

**NEW EQUIPMENT
TRANSFORMERS**

THE ONLY COMPLETE*, VERSATILE LINE WITH
TOUGH SEALED-IN-STEEL CONSTRUCTION**

When tougher transformers are made, CHICAGO makes them—in rugged, streamlined drawn-steel cases that provide the fullest enclosure and protection, that look well with other modern electronic components and enhance the appearance of the equipment. The exclusive CHICAGO one-piece drawn-steel case (no seams or spot welds) is the strongest, toughest type of mechanical construction. Further, the one-piece design provides a continuous electrical and magnetic path which means better electrostatic and magnetic shielding. Seamless construction assures maximum protection against adverse atmospheric conditions—means longer, more dependable transformer life.

Whether your transformers must pass the most rigid MIL-T-27 specifications or are intended simply for average, normal applications, it's wise to choose CHICAGO "Sealed-in-Steel" Transformers (the world's toughest) for that extra margin of dependability under all operating conditions.

***COMPLETE.** There's a CHICAGO "Sealed-in-Steel" unit for every application: Power, Bias, Filament, Filter Reactor, Audio, MIL-T-27, Stepdown, Isolation—all in one-piece, drawn-steel cases.

****VERSATILE.** Available in 3 constructions to meet most requirements—a type for every application.

H-Type. Steel base cover is deep-seal soldered into case. Terminals hermetically sealed. Ceramic bushings. Stud-mounted unit. Meets all MIL-T-27 specs.

S-Type. Steel base cover fitted with phenolic terminal board. Convenient numbered solder lug terminals. Flange-mounted unit.

C-Type. With 10" color-coded stripped and tinned leads brought out through fibre board base cover. Flange-mounted unit.



SEND FOR "NEW EQUIPMENT" TRANSFORMER CATALOG

Have the full details at your fingertips on CHICAGO'S New Equipment Line—covering "Sealed-in-Steel" transformers designed for every application and geared to today's circuit requirements. Write for your copy of this important catalog today, or get it from your electronic parts distributor.

CHICAGO TRANSFORMER

DIVISION OF ESSEX WIRE CORPORATION

3501 ADDISON STREET • CHICAGO 18, ILLINOIS





UHF

DEVELOPMENT

DESIGN

MANUFACTURE

EQUIPMENT

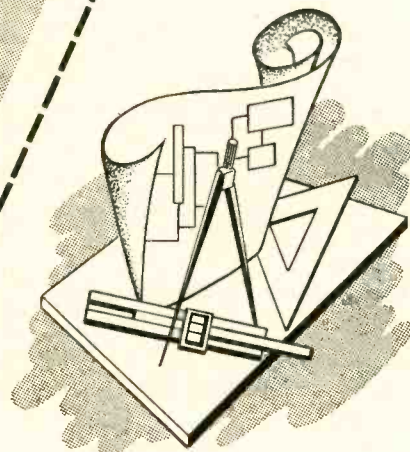

- ... *If* UHF design or development is a major problem with you, or ...
- ... *If* low-unit manufacturing cost is essential to satisfactorily meet competition, or ...
- ... *If* trustworthy, confidential collaboration is a highly necessary factor ...

**LAVOIE PRODUCTS
INCLUDE:**

RADAR RECEIVERS
RADIO RECEIVERS
SIGNAL GENERATORS
FREQUENCY METERS
ANTENNA EQUIPMENT
PULSE GENERATORS
OSCILLOSCOPES
RADAR BEACONS
COMMUNICATION
SYSTEMS
CRYSTAL IMPEDANCE
METERS
ETC., ETC.

THEN Lavoie Laboratories, Inc. can be of invaluable assistance. We have the Engineering Staff . . . the shop techniques . . . a competent understanding of government contract procedures . . . and the reputation for satisfactorily meeting *all* of these requirements.

We welcome your inquiries on any phase of UHF design, development or production.

Lavoie Laboratories, Inc.

MORGANVILLE, N. J.

Specify

CHESTER

plasticord-plasticote
WIRES and CABLES

JAN-C-76 APPROVED WIRES

80° 90° 105°C HOOK-UP WIRES

SHIELDED WIRES and CABLES

FLEXIBLE CORDS

TELEVISION LEAD-IN CABLES

GAS TUBE & OIL BURNER IGNITION WIRE

TELEPHONE WIRE

THERMOSTAT CABLES

BELL - OFFICE - BLASTING WIRES

TW BUILDING & FIXTURE WIRES

"Chesty" says —



Our new catalog is a complete guide to plastic insulated wire and cable for every purpose. Write for a copy of this important data compilation for your files today.

CHESTER CABLE CORP.

C H E S T E R , N E W Y O R K

MANUFACTURERS OF QUALITY WIRES AND CABLES FOR EVERY ELECTRONIC REQUIREMENT

Everything in wiring

More and more—engineers, designers, production men and purchasing officials have come to regard Plasticord and Plasticote Wires and Cables by Chester as the standard of comparison. This is because every inch of these dependable insulated conductors is made to conform to exacting quality controls that assure long service life, and performance as specified by the factory. That's the reason electrical men, everywhere, look for the Chester trademark when they're looking for the best!



Brown Instruments and Components for

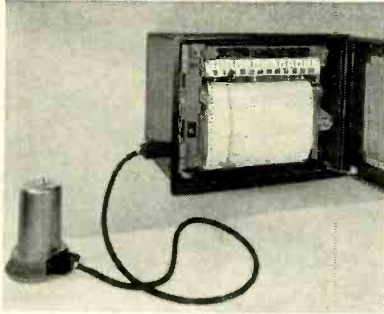

BROWN ELECTROMETER

To measure and record currents as low as 10^{-15} amperes. High accuracy provided through use of a null balance servo system and a-c amplifiers which eliminate drift common to d-c amplifiers. Used to measure and record minute currents in ionization chambers and wherever currents as low as a billionth of a microampere are encountered. The only such system that incorporates a recorder as an integral part of the circuit. Additional features include a special power supply to prevent false measurements from stray signals which might originate in an a-c power source . . . vibration frequency carefully selected to prevent phase shift . . . and automatic standardization of voltage across the slide-wire.

Electrical Characteristics

Full Scale Current Ranges Available: 10^{-13} amperes with 10^{11} ohm resistor, and selector switch adjustment for full scale of 10^{-12} or 10^{-11} amperes. Using other resistors, full scale current changes up to 10^{-7} amperes can be supplied with selector switch adjustment up to 10^{-3} amperes.

Input Resistor: 10^{11} ohms for most sensitive current measurement. (Also supplied in values down to 10^5 ohms.)

System Accuracy: Approximately 1 per cent of scale.

Zero Drift: Should not exceed 0.3 millivolt per day.

System Noise: Approximately 5 microvolts.

Instrument Speed of Response: Available for either 24, 12, or $4\frac{1}{2}$ seconds full scale.

Maximum Speed of Response Using $4\frac{1}{2}$ Second Instrument Speed: 5 seconds for 90 per cent of change, with preamplifier located at source.

Power Supply: 115 volts, 60 cycles. Also dry cell supplied in instrument.

Power Requirements: 65 watts.

For further information, send for Data Sheet No. 10.0-4.

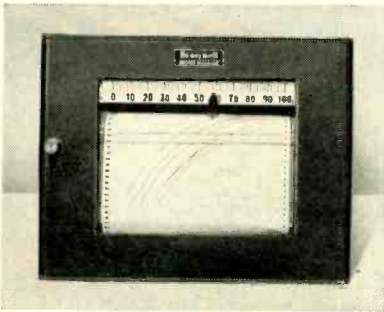

FUNCTION PLOTTER

Can be advantageously employed wherever there is occasion to depict graphically one variable as a function of another. Specifically, it imparts speed, accuracy and efficiency to the plotting of curves showing such data as the relationship of speed versus torque . . . stress versus strain . . . temperature versus pressure . . . amplifier output versus input . . . antenna radiation patterns . . . plate current versus grid voltage . . . temperature versus temperature difference . . . pressure versus displacement . . . force versus motion. Its design is such that both pen and chart measuring circuits can be energized by any d-c source. However, the chart can be equipped with a selsyn motor which permits direct linkage to a mechanical pick-up which is responsive to one variable. Thus, wide flexibility in the problems that can be studied with the instrument is achieved. For further information, send for Data Sheet No. 10.0-5.

BROWN EXTENDED RANGE PRECISION INDICATOR

Ideal for facilitating the measurement of a variable where it changes throughout a wide range, and where precise evaluation and good readability are vital factors. Incorporating extended scale with automatic range changing operation, the instrument can be supplied with from two to five ranges, calibrated in emf or the specific quantity under measurement (i.e., pounds or tons force or thrust, millivoltage, temperature, etc.).

For further information, send for Data Sheet No. 10.0-3.

DUPLEX TWO PEN RECORDER

Provides simultaneous measurements of practically any combination of two independent variables (voltage, current, temperature, pressure, etc.) on a single chart thereby facilitating comparisons of the two variables. Has two separate measuring systems with associated pens. Pens are entirely independent, and traverse the full eleven inches of chart width without interfering with each other. Both measuring circuits are standardized simultaneously by means of a push button. Actuation and range of the circuits may be the same or totally different.

For further information, send for Data Sheet No. 10.0-6.

NARROW SPAN RECORDERS

New narrow span potentiometer circuit makes possible precise measurement of spans as low as 100 microvolts. Instruments embodying this new circuit (recorders and precision indicators) are available as self-contained units requiring no pre-amplifier unit. The instruments find ready use wherever accurate measurement of d-c potentials of the order of microvolts is required. Potentials as low as one microvolt can be precisely determined. Can be calibrated in terms of temperature, emf, etc.

For further information, send for Data Sheet No. 10.0-8.

NEW *ElectroniK* HIGH SPEED RECORDER

Ideal for accurately measuring and recording rapidly changing variables often found in research, engineering analyses and other technical investigations. Develops a pen speed sufficiently high to traverse its 11-inch graduated chart in one second. Full scale signals which vary as rapidly as 20 cycles per minute can be accurately recorded. Signals with a peak-to-peak amplitude of 10% of scale can be reproduced at variations up to 180 cycles per minute.

For further information, send for Data Sheet No. 10.0-7.

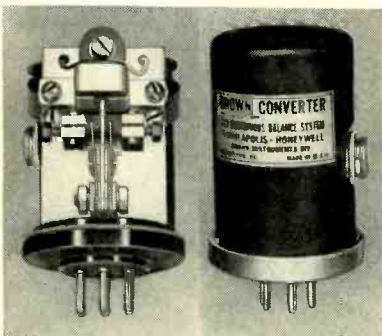

BROWN CONVERTERS

May be used with any system requiring the conversion of low power d-c signals, of the order of 100 microvolts, to 60 or 400 cycle alternating voltages. Output is unaffected by atmospheric pressure changes. Special material in reed assembly reduces pick-up of strays and transients to negligible proportion. Particularly useful in applications requiring error voltage measurements or null detection.

Electrical Characteristics

Driving Coil Requirements: 18 volts, 94 milliamperes, 400 cycles \pm 10 per cent.

Contact Rating: SPDT switching. Nominal rating—6 volts to one microvolt.

Load Characteristics: Resistive or inductive.

Shielding: Shell and coil shield, both grounded through pin No. 2.

Vibration Resistance: Output voltage will vary less than 2 per cent, with rates of vibration from 0 to 10 g (gravity).

Phase Shift: Output voltage differs from that of driving voltage by 45 to 50 degrees.

Stray Pick-up: Electrostatic— $2X10^{-10}$ volts per ohm of input circuit impedance. Electromagnetic— $2X10^{-5}$ volts, constant to $2X10^{-6}$ volts.

For further information send for Data Sheet No. 10.20-1.

1.0 milliampere; maximum power 100 microwatts.
Switching Action: Each contact closed 55 per cent of each cycle. Contacts closed simultaneously 5 per cent of the time, twice each cycle.
Symmetry: Within 5 per cent.

Research, Testing and Laboratory Applications

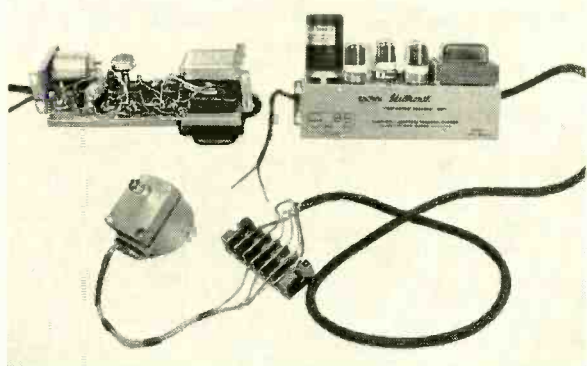

BROWN SERVO AMPLIFIER SYSTEM

High sensitivity with extremely low stray level. Comprises a converter (if the signal to be detected or measured is d-c); amplifier; and balancing motor. The servo amplifier and motor can be used to translate electrical signals into directional motion. Two models of the amplifier are available. Both are readily adaptable for use with a-c input signals by omitting the converter and applying the signal directly to the primary of the input transformer. Their general characteristics are:

Amplifier No.	*Input Impedance Ohms	Sensitivity, Volts	Over-All Voltage Gain	60-Cycle Output Current	60-Cycle Output Voltage
351921	400	2×10^{-6}	10^6	0-12	0-154
354547	7000	0.5×10^{-6}	4×10^6	0-12	0-154

*The amount of resistance in series with the input necessary to reduce the output voltage by one-half with the input voltage maintained constant.

For further information, send for Data Sheet No. 10.20-3.

• An amplifier with added stage of amplification and greatly increased sensitivity is also available. It produces motor drive from signals as low as 0.05 microvolt. Special features eliminate spurious signals resulting from thermal potentials and stray a-c pick-up.

For further information, send for Data Sheet No. 10.20-4.



BROWN 60-CYCLE BALANCING MOTOR

Totally enclosed and self-lubricated, ideal where positive positioning is required. Finds wide usage in servo-type mechanisms, remote positioners, auto-bridge and auto-potentiometric circuits. Available in 3 speeds, it combines reversibility with low inertia . . . eliminates coasting, promotes maximum effectiveness from any dynamic braking. Designed to have a tapered curve of speed versus voltage and, at the same time, maintain high torque at low speeds.

	27 RPM MOTOR	54 RPM MOTOR	162 RPM MOTOR
MAXIMUM TORQUE	Approx. 85 inch-ounces	Approx. 43 inch-ounces	Approx. 19 inch-ounces
MAXIMUM POWER	Approx. 6300 inch-ozs. per minute at approx. 17-18 rpm.	Approx. 67—inch-ozs. per minute at approx. 30-32 rpm.	Approx. 8150 inch-ozs. per minute at approx. 100 rpm.
POWER REQUIREMENTS	Line field—approx. 9.5 Watts. Amplifier field—approx. 4 Watts. Total power—approx. 13.5 Watts		

For further information, send for Data Sheet No. 10.20-2.



BROWN-RUBICON PRECISION INDICATOR

Combines the high accuracy of the *Rubicon* Laboratory potentiometer with the automatic continuous balance principle of the *ElectroniK* Precision Indicator. Advantageously employed wherever it is desired to rapidly and accurately measure small voltages. Speeds operations involving checking, calibration, and standardization of meters, potentiometers and thermocouples . . . as well as plotting large numbers of frequent, repetitive voltage readings. Unaffected by vibration.

Ranges and Operating Characteristics

Over-All Range: 0 to 70.1 millivolts.

Self-Balancing Scale Range: 0 to 1.1 millivolts.

Readability: one microvolt.

Sensitivity: one microvolt.

Accuracy: within three microvolts, or 0.02 per cent of indication whichever is greater.

Full Scale Travel Time: 12 seconds.

Variable Suppression and Narrow Span: provided by a combination of three elements—(1) a manually positioned seven-point switch, 10 millivolts per point; (2) a manually positioned ten-point switch, one millivolt per point; and (3) a helical slidewire, 25 inches long, with 1600 convolutions, 1.1 millivolts over-all.

Size of Scale: 28 $\frac{3}{4}$ inches long, with 550 one-sixteenth inch divisions of two microvolts each.

For further information, send for Data Sheet No. 10.0-2.

MINNEAPOLIS-HONEYWELL REGULATOR CO.
Industrial Division

4578 Wayne Ave., Philadelphia 44, Pa.

Offices in more than 80 principal cities of the United States, Canada and throughout the world.

Write for Research Bulletin No. 15-14.

MINNEAPOLIS
Honeywell

Brown Instruments

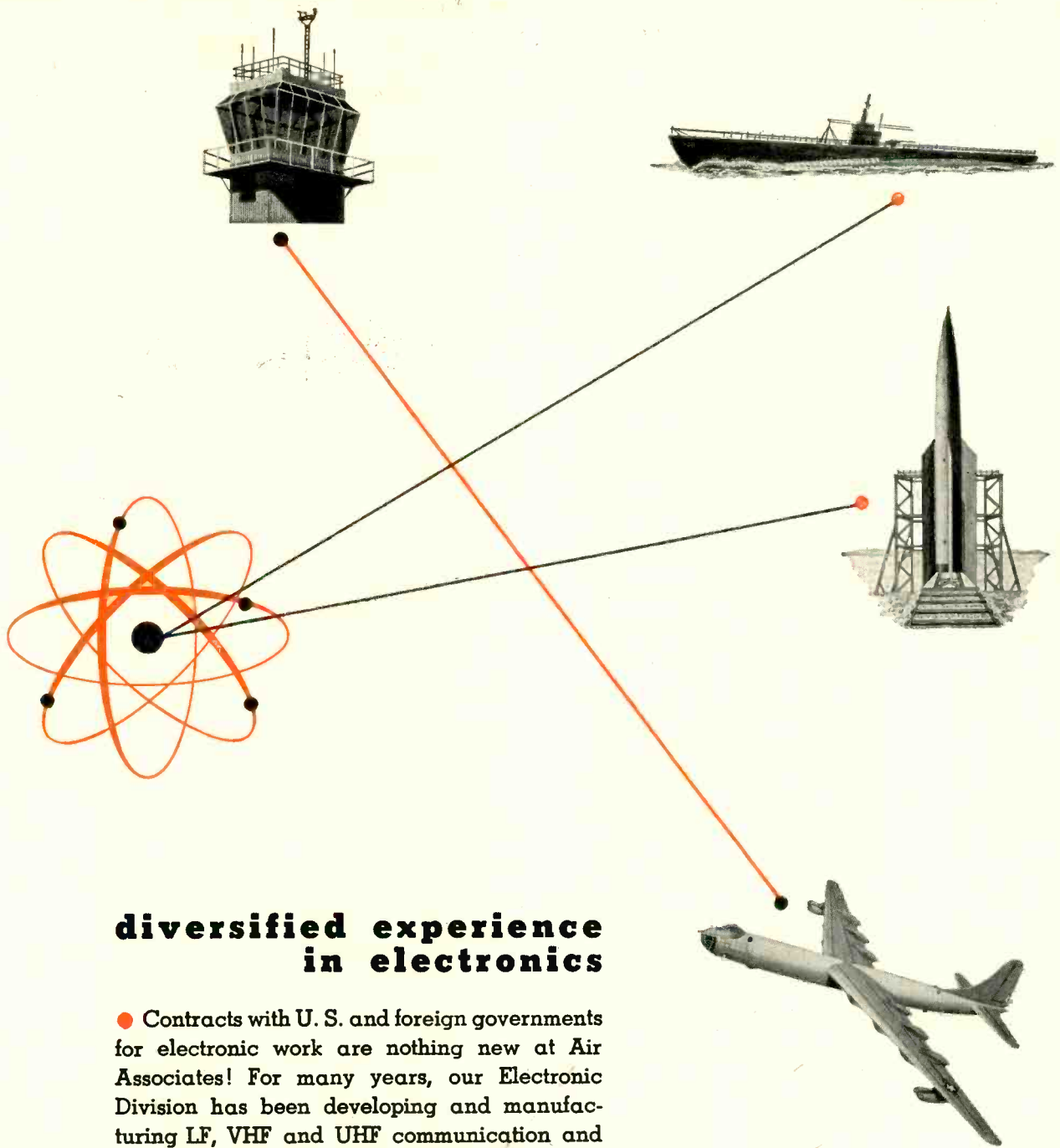

diversified experience in electronics

● Contracts with U. S. and foreign governments for electronic work are nothing new at Air Associates! For many years, our Electronic Division has been developing and manufacturing LF, VHF and UHF communication and navigation systems, landing systems, firing error indicator systems, echo ranging systems (including sonar) and special miniaturized electronic devices. Our wide experience and expanded facilities for airborne, marine and ground electronics equipment are available to help solve your design and production problems. Your inquiry to Teterboro will receive prompt attention.

Air Associates
INCORPORATED
TETERBORO, NEW JERSEY



SERVING THE NATION IN AVIATION

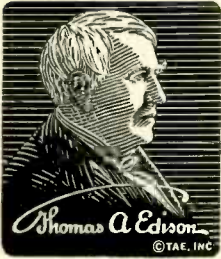

SEALED TIME DELAY RELAYS

A Thermal Relay is the simplest, least expensive, and most trouble-free way to introduce a delay period into an electric circuit. The advanced design of the Edison Model 501 Relay enables circuit designers to realize these advantages with complete confidence in its stability and long life. In addition, the inherent operating characteristics of the device provide an ideal way of solving many circuit problems not primarily concerned with timing.

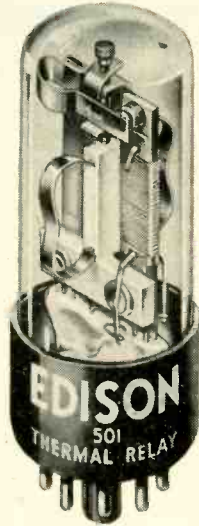

The mechanism of the Edison Model 501 Thermal Relay consists of two bimetal strips, each rigidly supported at one end and carrying a contact at the other. An electrical heater is wound around the primary bimetal which is deflected by the application of heater current. The use of the second bimetal, which supports the preloaded spring contact, provides compensation for ambient temperatures from -60 to $+85^{\circ}$ C. **Hermetically Sealed**—Explosion-proof; non-corrosive, non-arcing with currents to 6 amps. **Chatter-Proof**—Instantaneous 50 to 80 gram contact pressure with wiping action. **Tamper-Proof**—Pre-set adjustment within the glass envelope. **Vibration and Shock Resistant**—Withstands vibration of $1/16''$ overall amplitude at 55 cps and impact of 50 g. **Light Weight**— $1\frac{1}{2}$ to $2\frac{1}{4}$ oz. **Built for long life**—Large contacts ($.153''$ dia.); riveted and spot welded construction; heaters operate at low temperature (275° C max.); fungus-resistant micanol base. **Wide Range of Delay Periods Available**—From 5 seconds to 5 minutes. Special models incorporate time delays to 25 minutes. **Operates in any position. Quick Mounting**—Fits standard intermediate octal socket.

TYPICAL APPLICATIONS

For General Control Use: In many applications in which magnetic relays have been used. No maintenance, reduction in size and weight, independence from atmospheric pressure, and complete silence are features which are gained.

Cathode Protection: The satisfactory life of certain thermionic tubes requires the delay of application of plate voltage until the cathode has reached operating temperature. The Thermal Relay is ideally suited to this application.

Sustained Over-Current or Over-Voltage Protection: Since it operates by heat input, which is proportional to the square of the heater current, and there is no pull-in drop-out differential, the Relay serves as a sensitive indicator or control of over- or under-current or voltage. Because of the Relay's delay function, surges

are ignored and operation occurs only when the condition persists. **Motor Starting:** Adaptable to switching in motor starting circuits, also as an overload protection device.

Improving sensitive Contact Operation: Contacts of a control device will often make or break before firmly closing. Use of an Edison Thermal Relay instead of a magnetic relay for controlling the load will eliminate relay chatter and false starting of the load. It improves sensitive instrument contact operation by presenting a resistive load with no surges which might weld contacts.

Integration: Integrates pulses or intermittent current into accumulated heat energy which will operate its contacts after a predetermined rate of input has been reached.

TIMING VALUES: In addition to the voltage and current ratings, a thermal relay includes three time values among its operating characteristics . . .

Operating Time: The interval, in seconds, between the application of heater voltage and relay contact closure.

Reoperating Time: The interval between removal of heater voltage and opening of relay contacts.

Recovery Time: The interval between removal of heater voltage and restoration of 85% of the Operating Time. (The figure of 85% has been arbitrarily selected in order to define this value more accurately because of the asymptotic nature of the heating and cooling curves.)

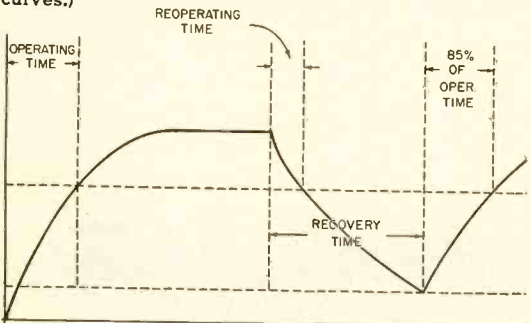

SPECIAL TYPES: Relays can be made in quantity orders to specifications which will be reviewed without obligation. Mention type number of nearly acceptable standard relay and specify only the necessary variations in contacts normally open or closed • heater voltage • contact voltage and current • operating time • reoperating time, instantaneous or saturation • recovery time, instantaneous or saturation • type of mounting.

General Specifications—STANDARD RELAYS

Switch Action: Normally open, single pole, single throw.

Mounting: Intermediate octal base, fungus-resistant micanol. Bakelite base available on 117 volt types only.

Tolerances: Nominal Heater Voltage: $\pm 10\%$ with corresponding variation in timing. Ambient temperature: at -60° or $+85^{\circ}$ may vary $\pm 15\%$ from 25° C timing.

Reoperating Time: $\pm 20\%$

Recovery Time: $\pm 20\%$

TYPE NUMBERS NOMINAL HEATER VOLTAGES				OPERATING TIME		REOPERATING TIME**		CONTACT RATING xxx
117V.	26.5V.	6.3V.	Nom. Sec.	Tol. Sec. \pm	Instant. Sec. $\pm 20\%$	Saturated Sec. $\pm 20\%$		
*B2001 B2101	B2011	B2021	5	1	5	50	3.0 AMP 150 v. D.C. or 250 v. A.C.	
*B2002 B2102	B2012	B2022	10	2	2.5	25		
*B2003 B2103	B2013	B2023	20	3	6.5	45		
*B2004 B2104	B2014	B2024	30	5	4.5	30		
*B2005 B2105	B2015	B2025	45	7	4	40		
*B2031 B2131	B2034	B2037	60	9	3.5	35		
*B2006 B2106	B2016	B2026	75	12	1.5	20	3.0 AMP 450 v. D.C. or 450 v. A.C.	
*B2040 B2140	B2041	B2042	90	14	75	110		
*B2007 B2107	B2017	B2027	105	16	35	70		
*B2032 B2132	B2035	B2038	120	18	30	60		
*B2008 B2108	B2018	B2028	150	23	65	175		
*B2033 B2133	B2036	B2039	180	27	40	135		
*B2009 B2109	B2019	B2029	210	32	35	125		
*B2010 B2110	B2020	B2030	300	45	55	185		

* Bakelite base on these types.

** At Nominal Voltage and 25° C.

xxx Contacts—silver, normally open. Tungsten available for 6 amp. rating.

SPECTRUM ANALYZER

- 5 inch 'scope gives high visibility
- Interchangeable RF heads extend range
- Complete accessibility for adjustment or maintenance
- Panel controls grouped for convenience of user
- Stabilized IF amplifier holds long-term alignment
- Full shielding by mu-metal tube shield and steel case
- Bezel accepts Dumont hood, filters, and camera
- Heavy-duty power supply handles all 300 v. reflex-klystron local oscillators

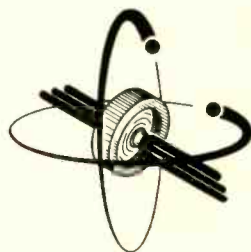

SPECIFICATIONS

Overall gain—130 decibels
Sensitivity—Approx. -60dbm for $1\mu\text{sec.}$ pulse width.

IF bandwidth—50kc. standard (10 kc. if so ordered); 50 kc bandwidth recommended for CW and pulse widths 0.2 to $2\mu\text{sec.}$; 10 kc bandwidth recommended for pulse widths up to $10\mu\text{sec.}$

Sweep frequency—10-30 cps — easily changed for special-purpose measurements.

Power requirements—115 or 230 volts, 50-980 cps.

Frequency spread (max.) — 0.75 mc/in. at S-Band, 3 mc/in. at X-Band.

Model SA10S—Frequency range, with S-band head — 2400 to 3650 mc.

Model SA10X—Frequency range, with X-band head — 8500 to 9660 mc.



The Vectron spectrum analyzer is a double superheterodyne receiver with a five-inch cathode-ray oscilloscope output indicator. The local oscillator is frequency-modulated by the same sawtooth voltage wave that produces linear horizontal sweep on the cathode-ray tube. The components of an input signal are shown as vertical pips on the 'scope screen; the frequency and power of a component are indicated by the position and amplitude of its pip.

The analyzer can be furnished with either an S-band or an X-band head. Heads for other frequencies are available on special order. The heads are interchangeable, allowing one basic unit to be used with all heads.

To assure trouble-free service, the instrument uses a stabilized IF amplifier, potted transformers, oil-filled capacitors, and preferred-type tubes. Removable case panels give quick access to the chassis if adjustment is ever necessary.

VECTRON ALSO OFFERS engineering and manufacturing service in the design and production of electro-mechanical apparatus. Your needs in development of instrumentation, gyro-mechanisms, communication networks, filters, servomechanisms, and electronic systems can be met by our plant, equipment, personnel, and experience.

Electro-Mechanical Equipment
VECTRON, inc.
 235 HIGH STREET, WALTHAM, MASSACHUSETTS

**HUGH H.
 EBY, INC.**

*electrical and
 electronic components*

• SOCKETS

- 7-Pin Miniature
- 9-Pin Noval
- Special Miniatures
- 7- and 9-Pin Turret
- Molded Lock-In
- Molded Octal
- Universal
- Battery
- Television
- Crystal

• TUBE SHIELDS

• CONNECTORS

- Speaker
- Phono
- Universal
- 11-Pin (Male & Female)
- 5-Pin (Male & Female)

• KNOBS

• PLUGS

- Speaker
- Molded Battery
- Laminated Battery
- Laminated Chassis
- Special

• JACKS

- All Molded Single & Twin
- Metal
- Laminated Twin & Triple

• TERMINAL STRIPS

- Screw-Type
- Special

• BINDING POSTS

- Insulated (Single, Twin, Triple)
- Non-Insulated Metal
- Spring (Push-Type)
- Panel & Telepost

Fuse Holder & Fuse Blocks
 Miscellaneous Mechanical & Electrical
 Components to Specification

Write for Illustrated Eby Catalog No. 51

**HUGH H.
 EBY, INC.**

4700 Stenton Ave.
 Philadelphia, Pa.

For Every Electronic Wiring Need

SPECIFY

“Rome”

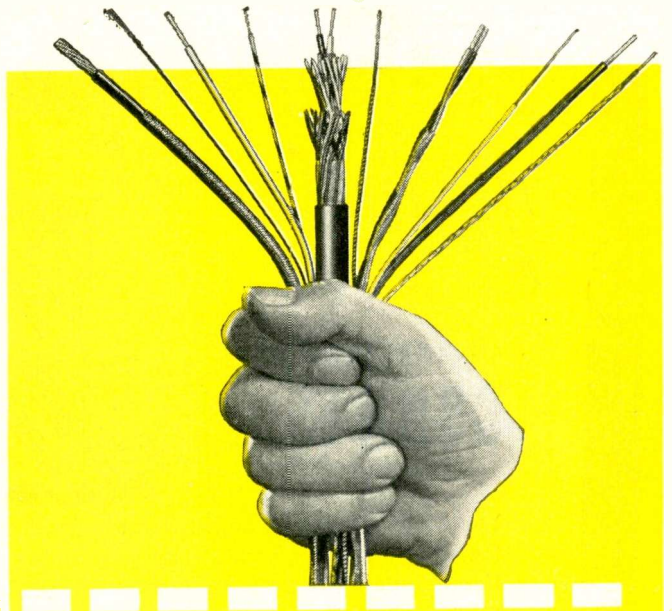

Rome Cable offers the electronic equipment manufacturer a wide range of electronic wires and cables, in both commercial and military types. All are manufactured to one standard of quality . . . the highest. They are approved by Underwriters' Laboratories, Inc. or the Armed Services Electro Standards Agency (ASESA).

In keeping with the current industry miniaturization program, Rome Cable engineers have developed a small-size

hook-up wire with an 8 mil wall of insulation and exceptionally small overall diameter. Approved for use above or below the chassis, with no assigned voltage, at temperatures up to 105° C., this item is a real space saver.

Whether your requirement is for hook-up wire or multiple conductor cable, Rome Cable engineers will welcome the opportunity to study your problem.

COMMERCIAL TYPE HOOK-UP WIRES



Rome Hi-Temp—Rome Hi-Temp Hook-Up Wires are rubber insulated and possess high resistance to heat and moisture. They are approved by Underwriters' Laboratories, Inc. for temperatures up to 75° C., with ratings of 300 and 600 volts. Available in sizes 24 AWG to 16 AWG, plain or with outer covering.



Rome Synthinol®—Being a polyvinyl chloride thermoplastic compound, Rome Synthinol insulation is impervious to oils, acids, alkalis, moisture and flame. Underwriters' approved for temperatures up to 80° C., with ratings of 300, 600 and 1000 volts. Available in sizes 24 AWG to 14 AWG, plain or with outer covering.

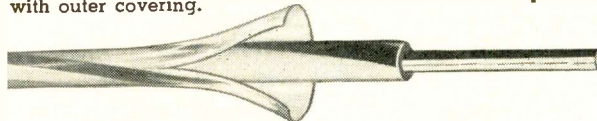

Rome Synthinol 901—Rome Synthinol 901, a resin plasticized polyvinyl chloride thermoplastic compound, is a Rome Cable development offering definite advantages of greater resistance to heat deformation, baking embrittlement, shrinkage, cracking, oils, solvents, moisture and flame, plus improved solderability. Underwriters' approved for temperatures up to 105° C., as a special thin wall insulation with no assigned voltage, as well as regular 300 and 600 volt ratings. Available in sizes 24 AWG to 16 AWG, plain or with outer covering.

All Rome Cable hook-up wires are in strict conformance with specification standards and carry proper approval for required use.

It Costs Less to Buy the Best

MILITARY TYPE HOOK-UP WIRES

Rome Cable is an approved manufacturer of military types SRIR, SRHV and WL, complying with Army-Navy Joint Specification JAN-C-76, as well as shipboard types SRI and SRIB conforming to Specification MIL-C-915. Insulated with Rome Synthinol thermoplastic compound, these wires are manufactured in the complete range of specification sizes.

MULTIPLE CONDUCTOR CABLES

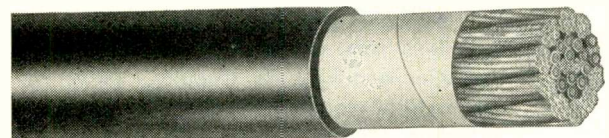

Abetted by increasingly wider use of thermoplastic materials such as polyvinyl chloride, polyethylene and nylon, Rome Cable manufactures a wide variety of multiple conductor cables for use in radio, television, electric computers and other electronically operated devices. Rome engineers will be glad to design a cable fitted to your particular requirements.

OTHER TYPES

In addition, a variety of wires and cables for electronic use are available as follows:

- Television Camera Cable • Intercommunication Cables
- Microphone Cables • Supervisory Control Cables •
- Radio Frequency Transmission Line • Flexible Cords

Descriptive literature sent upon request.

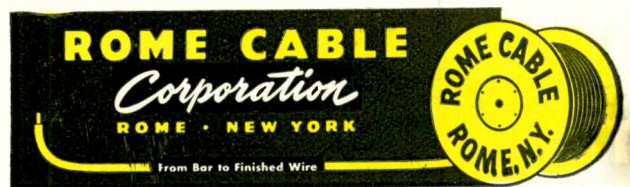

Timing Ideas

WHEN TIMING COUNTS

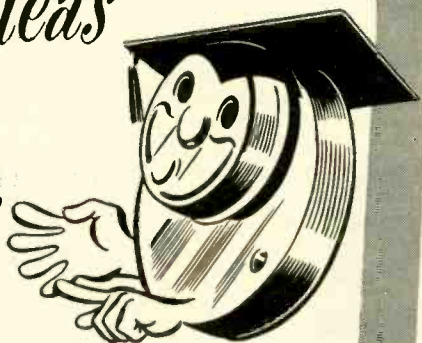

You can always count on Haydon to provide the right motor for your timing job. Timing Headquarters offers a broad line of efficient, economical timing motors and timers produced by specialists who have no other interest than to provide the best in timing.

LOW COST VERSATILITY—1600 SERIES:

Specifically designed as a standard component for the widest possible range of timing applications with 79 speeds from 300 rpm to 1 revolution per 4 hours.

COMPACTNESS AND SLOW SPEED—4400 SERIES:

Designed for small size and low cost in applications requiring slower speeds from 6 hours to 7 days per revolution.

HEAVY DUTY DEPENDABILITY—3100 SERIES:

For control and instrument applications that require a heavy duty train and speeds from 1 hour to 14 days per revolution.

SUPERIORITY FEATURES

Slow (450 rpm) rotor speed makes for quiet operation and long life. Unusually small. All motors totally enclosed. Separate rotor and reduction gearing lubricating systems permit selection of best methods and lubricants, control circulation, insure against leakage. Operates continuously in any position. Simple to mount, entire face of motor can be supported securely against mounting surface. Standard, interchangeable design in only 2 motor series with speed range from 300 rpm to 1 revolution in 7 days.

For complete design and engineering specifications, write for catalog: Timing Motors No. 322 — Timers No. 323 — Clock Movements No. 324. Yours without obligation.



1600



4400



3100



IF IT'S ABOUT TIME

Illustrated here are just a few of the many timing motors and timing devices we've designed and produced to solve the timing problems of our customers. Whether you can use a standard model—or whether you'll need a special design—you'll find that, in the long run, it'll pay to see Haydon* first.

STANDARD SPECIFICATIONS

Available for any size order; normally stocked in limited quantities.

THE 1600 SERIES

SPEEDS: 1/60, 1/45, 1/30, 1/15, 1/10, 1/6, 1/5, 1/4, 1/3, 1/2, 1, 2, 4, 5, 10, 30, 60 rpm

VOLTAGES: 115 standard; 230 to order

FREQUENCIES: 60 cps standard; 50 and 25 cps to order

ROTATION: Right (clockwise) standard; left (counter-clockwise) to order

SHAFT: 1/8" diameter x 3/8" long

WATTS INPUT (115V, 60 cps): 2.5

LEADS: 6", stripped 1/2"

TORQUE: 5 ounce inches @ 1 rpm (60 cps, 2.5 w); maximum torque load for standard gear train: 20 ounce inches

THE 4400 SERIES

SPEEDS: 6, 8, 12 hours and 1 or 7 days per revolution

VOLTAGES: 115 standard; 230 to order

FREQUENCIES: 60 cps standard; 50 and 25 cps to order

ROTATION: Right (clockwise) standard; left (counter-clockwise) to order

SHAFT: 1/8" diameter x 3/8" long

WATTS INPUT (115V, 60 cps): 2.5

LEADS: 6", stripped 1/2"

TORQUE: 20 ounce inches at all speeds, which is maximum torque load for standard gear train

THE 3100 SERIES

SPEEDS: 1, 12 hours, 1, 7, 14 days per revolution

VOLTAGES: 115 standard; 230 to order

FREQUENCIES: 60 cps standard; 50 and 25 cps to order

ROTATION: Left (counter-clockwise) standard; right (clockwise) to order

SHAFT: 3/16" diameter x 3/8" long, with .162 diameter flat

WATTS INPUT (115V, 60 cps): 2.5

LEADS: 12", stripped 1/2"

TORQUE: 15 pound inches at all standard speeds, which is maximum torque load for standard gear train

Many additional speeds and shafts available in quantities of 100 or more; also special voltage-frequency combinations.

*Trade Mark Reg. U. S. Pat. Off.

HAYDON

AT TORRINGTON

HEADQUARTERS FOR
TIMING

HAYDON Manufacturing Co., Inc.

500 ELM STREET

TORRINGTON, CONNECTICUT

SUBSIDIARY OF GENERAL TIME CORPORATION

...IT'S TIME TO SEE HAYDON....

Some of our customers incorporate Haydon Timing Motors into their products. Others ask us to give them timing devices — in many cases devices especially designed for their application. Whatever your need may be, Haydon timing experience and facilities are at your disposal. Feel free to call on Haydon whenever you have a timing problem.

STANDARD SPECIFICATIONS

SERIES 8006 INTERVAL TIMER

Standard models for intervals of 1, 15, 60 and 180 minutes; dial and knob optional • Other models for intervals up to 24 hours or more available without dial or knob • HOLD feature optional • Switch rated 28A, 250 VAC; 1 HP 250 VAC • Removable dust cover for timer; motor totally enclosed • Settable in either direction, to start or when operating • Withstands high temperature and humidity conditions • U.L. Approved.

SERIES 8010 INTERVAL TIMER WITH BUZZER

Many intervals available with a wide range of motor speeds • Optional buzzer for audible signal at completion of cycle; sounds until turned off • Load contact ratings: 16A, 250 VAC; 1/2 HP, 250 VAC • Compact: 3-53/64" x 2-55/64" x 1-25/32" • Operates in any mounting position • U.L. Approved.

SERIES 5900 TIME DELAY RELAY

5901 Series adjustable time delay relays are available in delays of 15 seconds, 1, 10 and 5 minutes. 5902 Series, non-adjustable, available in delays of 12, 15, 30, 45 and 48 seconds and 1, 2, 3, 3-3/4, 4, 5, 6, 7-1/2, 8 and 10 minutes.

SERIES 5700 ELAPSED TIME INDICATORS

5701 and 02 Series are non-reset indicators, available for time registers of hours and tenths, hours, minutes and tenths, and minutes; total registers for 9,999.9 hours or minutes or 99,999.0 hours or minutes. 5704 and 07 Series are resettable units, with time registers for hours and tenths, hours, minutes and tenths, and minutes; total registers for 9,999.9 hours or minutes or 99,999.0 hours or minutes.

Timing Ideas

PRECISION PERFORMANCE



Manufacturers, recognizing that components of quality insure outstanding product performance, look to Haydon® at Torrington for timers and timing devices. All Haydon timers are made with the same precision as the Haydon motor — your guarantee of satisfactory performance. If you need a special design, you'll find Haydon's extensive engineering and development facilities without equal for service and results.

A few examples of basic Haydon timing units are featured below.

SERIES 8010 INTERVAL TIMER WITH BUZZER

Compact, low cost timer for volume production. Wide range of intervals. Audible (buzzer) signal optional. Quick break. Load contact rated 10A, 1/2 HP 250 VAC.

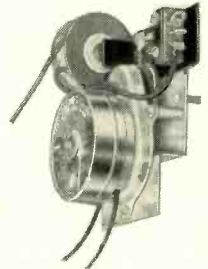

SERIES 8006 INTERVAL TIMER

Designed for heavy duty, this unit is available in quantities in standard models. Wide range of intervals. HOLD feature optional. Quick break. Totally enclosed. Switch rated 28A, 1 HP 250 VAC.

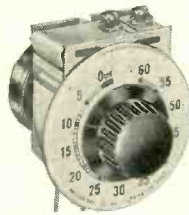

SERIES 5900 TIME DELAY RELAY

For use where positive, accurate time delay relay is imperative. Automatic reset. Fixed models for volume production; adjustable models in 4 delay ranges for general use.

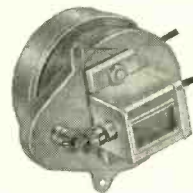

SERIES 5700 ELAPSED TIME INDICATOR

Synchronous timing motors with cyclometer type counters for metering elapsed time. Rugged models for wide range of timing, recording operations; in several registers, resettable or non-resettable.

® TRADE MARK REG. U.S. PAT. OFF.

For complete design and engineering specifications, write for catalog: Timing Motors No. 322 — Timers No. 323 — Clock Movements No. 324. Yours without obligatin.

HAYDON Manufacturing Co., Inc.

500 ELM STREET

TORRINGTON, CONNECTICUT

SUBSIDIARY OF GENERAL TIME CORPORATION

HAYDON

AT TORRINGTON

HEADQUARTERS FOR

TIMING

NATIONAL ELECTRONICS, INC.

QUICK-HEATING INDUSTRIAL ELECTRONIC TUBES



3C23 THYRATRON

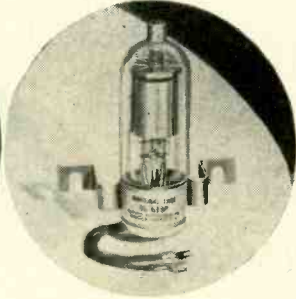

NL-618P RECTIFIER

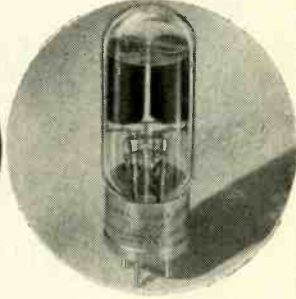

NL-604 RECTIFIER

THYRATRONS

Type Number	Gas Filling	DC Output Amperes	Peak Amps. Rating	Peak Inverse Voltage	Fila-ment Volts	Fila-ment Amperes
3C23	Arg. & Merc.	1.5	6	1250	2.5	7
323B	Arg. & Merc.	1.5	6	1250	2.5	7
393A	Arg. & Merc.	1.5	6	1250	2.5	7
NL-714	Arg. & Merc.	1	3	1250	2.5	5
NL-715/5557	Mercury	1	3	5000	2.5	5
NL-710/6011	Arg. & Merc.	2.5	30	1250	2.5	9
NL-740	Arg. & Merc.	4	50	1250	2.5	16
NL-741	Mercury	4	50	5000	2.5	16

HALF-WAVE RECTIFIERS

NL-614	Xenon	2.5	15	900	2.5	8.5
NL-615	Mercury	2.5	10	2000	2.5	7
NL-617	Mercury	5	20	1000	2	12
NL-618	Xenon	6.4	40	750	2.5	18
NL-623	Mercury	15	45	500	2.5	20
NL-625	Mercury	15	45	900	2.5	20
NL-627	Mercury	20	120	1000	2.5	26
NL-635	Mercury	6.4	40	1000	2.5	18
NL-643	Mercury	15	90	700	2.5	23
NL-649/5834	Mercury	2	10	900	2.5	7
NL-653/5835	Mercury	3	12	900	2.5	10

FULL-WAVE RECTIFIERS

NL-600	Arg. & Merc.	1	4	900	2.5	6
NL-604	Arg. & Merc.	2.5	10	900	2.5	12

Longest Life—Longest Warranties in the Industry

WRITE FOR TECHNICAL DATA BOOK

NATIONAL ELECTRONICS, INC.
GENEVA • ILLINOIS • U.S.A.



COILS

QUALITY COILS
TO
YOUR SPECIFICATIONS

We manufacture quality coils for the radio and electronics industry. Universal, bank-wound, universal-progressive or solenoid coils made to JAN specifications. Let us know your requirements: We will quote promptly.

FUGLE-MILLER LABORATORIES

METUCHEN
398 Main St.

NEW JERSEY
Me 6-2245

THIS BOOK...

The
**electronics
BUYERS'
GUIDE**

tells you
who makes each of
fourteen hundred dif-
ferent electronic and
allied products.

Keep it
and use it
for quick buying
and technical reference
throughout the year.

When buying, or requesting prod-
uct information be sure to mention
ELECTRONICS BUYERS' GUIDE.

Mitchell-Rand

m

**THE ONE
DEPENDABLE
SOURCE OF SUPPLY
FOR EVERYTHING IN
ELECTRICAL
INSULATION**

r

MIRAGLAS*
**WOVEN TAPES, TUBINGS
SLEEVINGS, CORDS
CLOTHS, ETC.**

**VARNISHED TUBINGS,
SLEEVINGS & TAPES**

**COTTON TAPES & SLEEVINGS
FIBERGLAS-MICA COMBINATIONS
VARNISHES · WAXES
COMPOUNDS**

* **WOVEN OF FIBERGLAS YARN**

**M-R THE
ELECTRICAL
INSULATION
HEADQUARTERS
FOR 61 YEARS.**



MITCHELL-RAND INSULATION CO. Inc.

51 MURRAY STREET · COlOrlandt 7-9264 · NEW YORK 7, N.Y.

A PARTIAL LIST OF M-R PRODUCTS: FIBERGLAS VARNISHED TUBING, TAPE AND CLOTH · INSULATING PAPERS AND TWINES · CABLE FILLING AND POTHEAD COMPOUNDS · FRICTION TAPE AND SPLICE · TRANSFORMER COMPOUNDS · FIBERGLAS SATURATED SLEEVING · ASBESTOS SLEEVING AND TAPE · VARNISHED CAMBRIC CLOTH AND TAPE · MICA PLATE, TAPE, PAPER, CLOTH, TUBING · FIBERGLAS BRAIDED SLEEVING · COTTON TAPES, WEBBINGS AND SLEEVINGS · IMPREGNATED VARNISH TUBING · INSULATED VARNISHES OF ALL TYPES · EXTRUDED PLASTIC TUBING



MT—SMALL TELEPHONE



ST—SHORT TELEPHONE



LT—LONG TELEPHONE

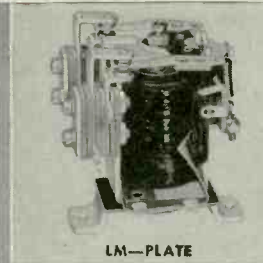

LM—PLATE



LS—PLATE

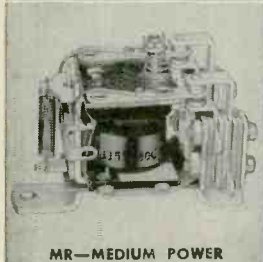

MR—MEDIUM POWER



MS—MOTOR START



SM—SUPER MIDGET

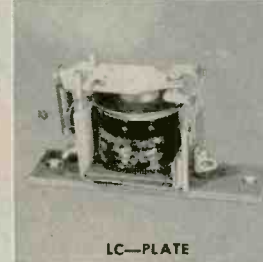

LC—PLATE



LP—PLATE

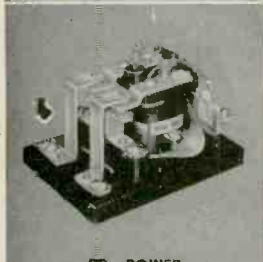

PR—POWER

Potter & Brumfield

Leading supplier of relays to industry—for every electrical and electronic application. Specialists in design and manufacture of open and sealed relays for military equipment.

Write for 26 page catalog No. 109 describing numerous standard models. Send specifications for recommendations, samples and quotations.

Contact your nearest P & B Sales Engineering Office:

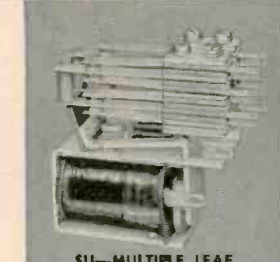

SU—MULTIPLE LEAF

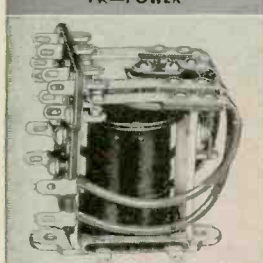

KL—LIGHT DUTY

ALBANY 7, NEW YORK, 100 State Street, Albany 3-3628
 ALEXANDRIA, VIRGINIA, 122 N. Fayette Street, Temple 1718
 ATLANTA 5, GEORGIA, 1145 Peachtree St., N. E., Hemlock 6161
 BOSTON 16, MASS., 25 Huntington Avenue, Kenmore 6-5580
 BUFFALO 2, NEW YORK, 1124 Prudential Bldg., Mohawk 9222
 CEDAR RAPIDS, IOWA, 309 Guaranty Bldg., Phone: 40833
 CHICAGO 34, ILLINOIS, 3352 N. Central Ave., Pensacola 6-6776
 CLEVELAND 15, OHIO, 1836 Euclid Avenue, Main 1-1286
 DALLAS 5, TEXAS, 7322 Marquette Ave., Emerson 6-6286
 DAYTON 2, OHIO, 18 W. Monument Avenue, Hemlock 9661
 DETROIT 35, MICHIGAN, 19481 James Couzens H'way, Vermont 8-3460
 DREXEL HILL, PENNSYLVANIA, 3611 Berry Avenue, Clearbrook 9-0231
 INDIANAPOLIS 1, INDIANA, 2208 E. Washington Street, Market 8517
 KANSAS CITY 2, MISSOURI, 1010 Porter Building, Logan 9824
 LOS ANGELES 15, CALIFORNIA, 1150 W. Olympic Blvd., Prospect 7595
 MEMPHIS, TENNESSEE, 1336 Madison Avenue, Phone 2-1914
 MILWAUKEE 3, WISCONSIN, 744 North 4th Street, Broadway 2-0517
 MINNEAPOLIS 17, MINNESOTA, 5022 29th Avenue, South, Drexel 1895
 NEW YORK 16, N. Y., 13 E. 40th St., Murray Hill 3-7585
 PITTSBURGH 19, PA., 600 Grant Street, Court 0131
 PORTLAND 5, OREGON, 917 S. W. Oak Street, Broadway 3830
 SAN FRANCISCO 3, CALIF., 1234 Folsom Street, Market 1-4166
 ST. LOUIS 5, MISSOURI, 311 Connor Building, Parkview 7622
 SEATTLE 9, WASHINGTON, 2530 Warren Avenue, Garfield 7398
 SYRACUSE 1, NEW YORK, P. O. Box 1224, Baldwinsville 662
 TORONTO 13, ONT. CANADA, 2273 Danforth Avenue, Oxford 1127
 VANCOUVER, B.C., CANADA, 132 W. Hastings St., Pacific 3195
 EXPORT: ROCKE INTERNATIONAL CORPORATION
 13 East 40th Street • New York 16, N. Y.



K CAN—OCTAL PLUG



KR—LIGHT DUTY

POTTER & BRUMFIELD • PRINCETON, INDIANA • PHONE 1208



K CAN—SOLDER TERMINAL



HG—MERCURY CONTACT

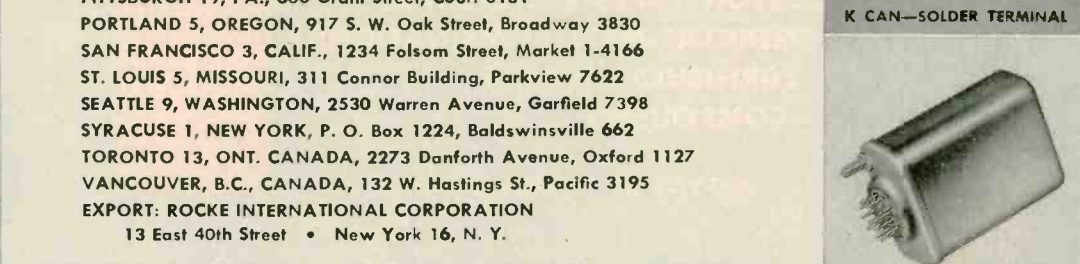

M CAN—14 PRONG PLUG



SP—SHOCK PROOF



FR—PHOTO FLASH



CA—SPACE SAVER

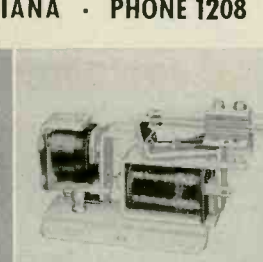

EL—LATCHING



M CAN—SOLDER TERMINAL

P RECISION F FABRICATION

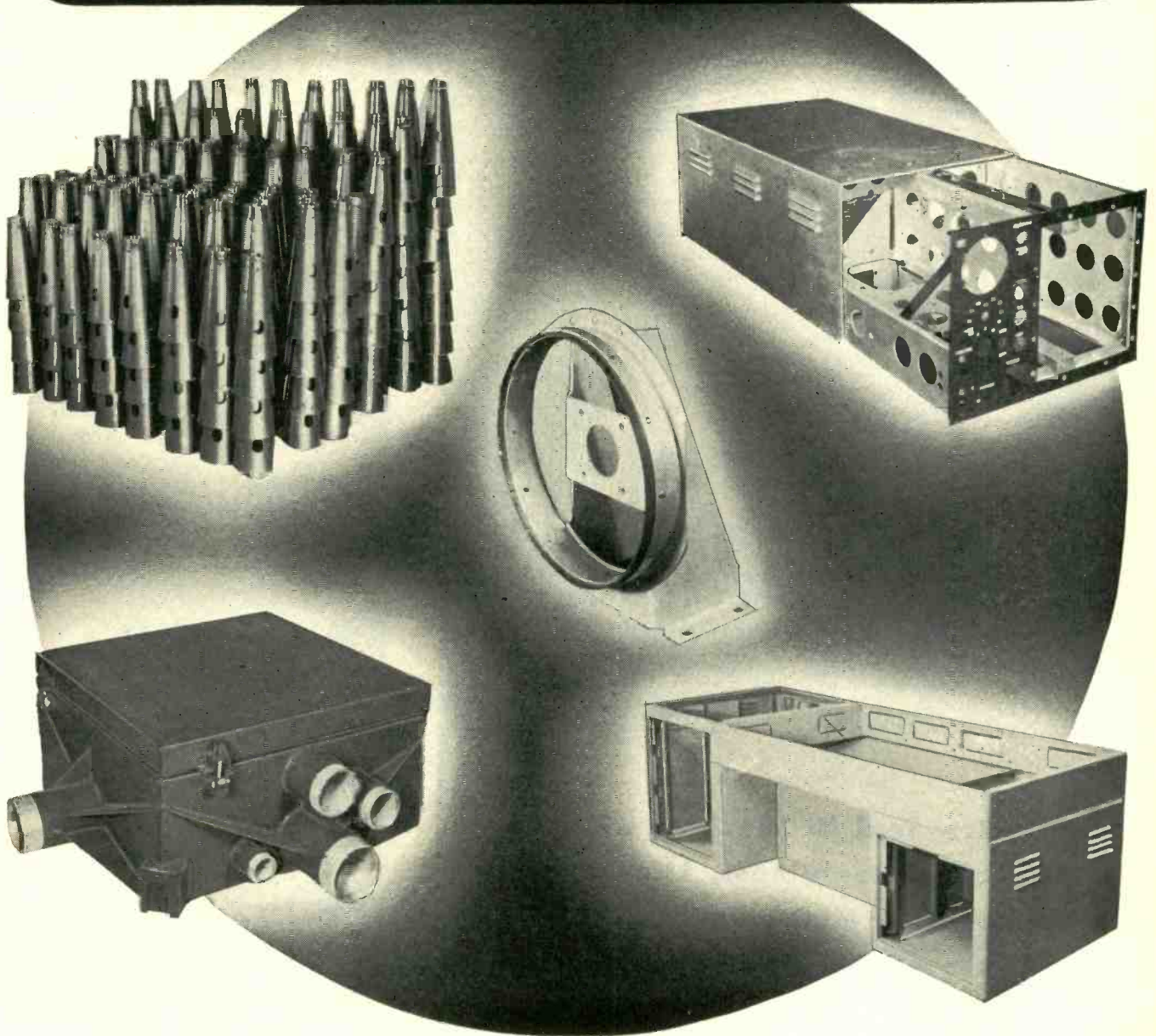

MULTI-METAL specializes in precision sheet metal fabrication in all metals including: Aluminum, Carbon Steel, Copper, MuMetal, Stainless Steel, etc. A large, modern, well equipped plant and 40 years of service to industry insures a high quality product at economical cost. Our Technical Department invites your problems, from simplest commercial stamping to most complicated assembly.

WIDE RANGE OF PRODUCTS

Cabinets — Chassis — Dial Plates — Dust Covers — C. R. Tube Shields — Watertight Units — Brackets — Panels — Racks.

Write for illustrated brochure.

Multi-Metal Co.

1350 Garrison Ave., New York 59, N. Y.

Telephone: Kilpatrick 2-2500

Make atmosphere a part of your product

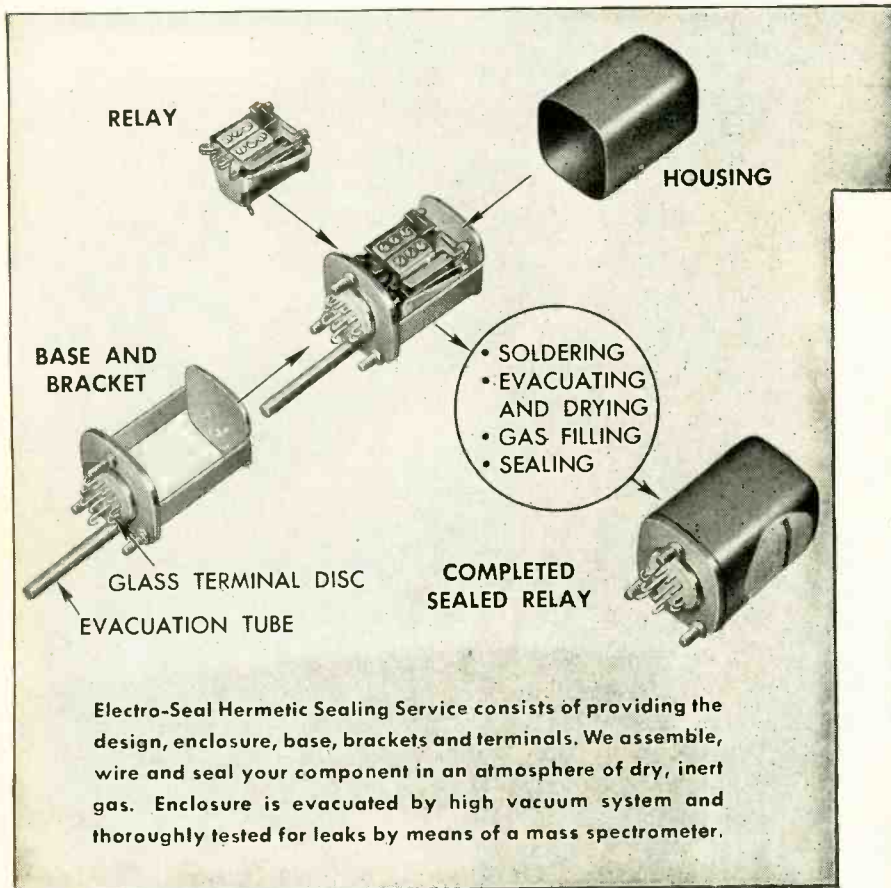

Electro-Seal Hermetic Sealing Increases Usefulness, Life and Freedom from Maintenance of Many Types of Electrical Products

No matter how efficient and dependable your product . . . relay, transformer, flasher, timer, amplifier, vibrator or other electrical device . . . it will only operate most reliably in "ideal" atmosphere.

Electro-Seal Hermetic Sealing Service permanently surrounds your product with atmosphere free of moisture, dust, fungi or pressure changes . . . makes it tamper-proof.

For aircraft use, hermetic sealing guards against failure caused by varying air pressure and condensation. In industry, it provides a safe enclosure in

hazardous locations and complete protection from dirt and dust.

Let us show you how Electro-Seal Hermetic Sealing Service can add to the life and reliability of your product by making atmosphere a "built-in" part of the product.

Enclosures can be made up by temporary tools to provide small quantities for engineering samples or limited production schedules. We invite you to send complete engineering information and samples of parts to be hermetically sealed.

A FEW STANDARD TYPES OF ELECTRO-SEAL ENCLOSURES

All Electro-Seal Enclosures can be equipped with individual terminals, multiple headers or plug-in arrangements as well as mounting flanges or studs. Dimensions given are inside usable dimensions.



SERIES 5-E

(Dia: 1½", Depth: 1⅞", Overall Outside Ht.: 2⅝"). Normally equipped with octal plug.

SERIES 6-E

(Width: 1⅞", Length: 4⅜", Depth: 2⅜", Overall Outside Ht.: 3⅜"). Size frequently permits sealing several components within the enclosure.



SERIES 8-E

(Dia: 2¼", Depth: 2⅞", Overall Outside Ht.: 3½"). Normally equipped with octal plug. Maximum base area required: 2½" x 2½".

SERIES 13-E

(Width: 1¾", Length: 1¾", Depth: 2⅜", Overall Outside Ht.: 2⅜"). Base provided with three mounting studs.



SERIES 14-E

(Width: 1¾", Length: 2⅝", Depth: 2½", Overall Outside Ht.: 2½") Size frequently permits sealing of several items within the enclosure.



ELECTRO-SEAL CORPORATION

946 LEE STREET • DES PLAINES, ILLINOIS

RMC CERAMIC DISCAPS

... THE MONEY-SAVING
REPLACEMENT FOR MICA AND
CERAMIC TUBULAR CONDENSERS

RMC DISCAPS are approved and used by leading manufacturers of TV sets and tuners, radio receivers and high frequency electronic equipment. In addition to their lower cost, they offer the advantages of small size, low self inductance, low power factor, high working voltage, greater mechanical strength and faster production line handling.

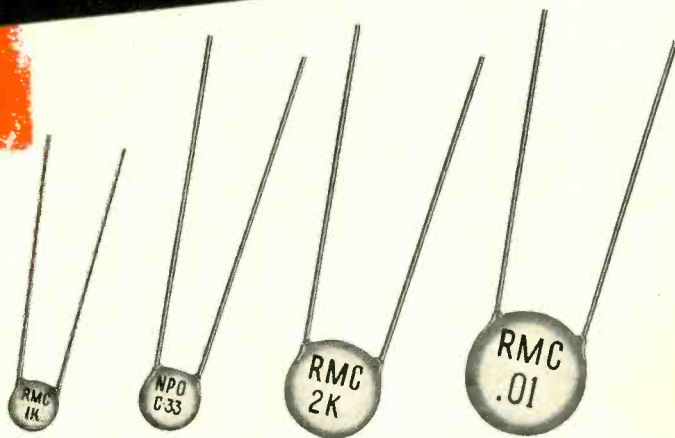

TYPE B DISCAPS

GMV By-Pass Series

Type B DISCAPS are the finest high frequency by-pass capacitors available and are engineered to exceed guaranteed minimum capacity at 85° C with 250 applied V.D.C. Capacity change between room temperature and 65° C is only +18%, -0%. Available in all standard capacities from .001 MFD to .02 MFD and in a number of dual capacity types.

SPECIFICATIONS

POWER FACTOR 1.5% at 1 KC
WORKING VOLTAGE 600 V.D.C.
TEST VOLTAGE 1200 V.D.C.
INSULATION, Durez Phenolic—Vacuum Waxed
RESISTANCE Initial 7500 Megohms
After Humidity 1000 Megohms
LEADS #22 Tinned Copper (.026 DIA.)
CAPACITY TOLERANCE GMV

TYPE C DISCAPS

NPO and TC

Type C DISCAPS are ideally suited to coupling and tuned circuit applications. Their capacity will not change under voltage. Available in a wide range of capacities and temperature coefficients conforming to the RMA specifications for Class I ceramic condensers.

SPECIFICATIONS

POWER FACTOR
Less than .1% at 1 Megacycle
WORKING VOLTAGE 600 V.D.C.
TEST VOLTAGE 1200 V.D.C.
INSULATION
Durez Phenolic—Vacuum Waxed
RESISTANCE Initial 7500 Megohms
After Humidity 1000 Megohms
LEADS #22 Tinned Copper (.026 DIA.)
CAPACITY TOLERANCE
±5%, ±10%, ±20%

TYPE D DISCAPS

STABLE CAPACITY

Specify Type D DISCAPS when a more stable capacity is required for coupling and by-passing filter networks. Available in a capacity range between 150 MMF and 5000 MMF. They feature a very small capacity change between +25° C and +85° C.

SPECIFICATIONS

POWER FACTOR 1% at 1 KC
WORKING VOLTAGE 600 V.D.C.
TEST VOLTAGE 1200 V.D.C.
INSULATION
Durez Phenolic—Vacuum Waxed
RESISTANCE Initial 7500 Megohms
After Humidity 1000 Megohms
LEADS #22 Tinned Copper (.026 DIA.)
CAPACITY TOLERANCE
±20% at +25° C

Every DISCAP Is 100% Tested for Capacity, Leakage Resistance and Breakdown

RMC production checks eliminate costly service failures. Because RMC produces the complete condenser, even to the processing of the dielectric element itself, it is possible to exercise the finest quality control. If you are interested in improving the uniformity of your product you will be interested in RMC DISCAPS.

SEND FOR SAMPLES AND TECHNICAL DATA

DISCAP
CERAMIC
CONDENSERS

RMC

RADIO MATERIALS CORPORATION

GENERAL OFFICE: 1708 Belmont Ave., Chicago 13, Ill.

FACTORIES AT CHICAGO, ILL. AND ATTICA, IND.

Two RMC Plants Devoted Exclusively to Ceramic Condensers



SELF-BONDING POLYETHELENE BASE TAPE



Forms into a solid mass of insulation producing moisture-tight seals by means of a gasketing action on all materials.

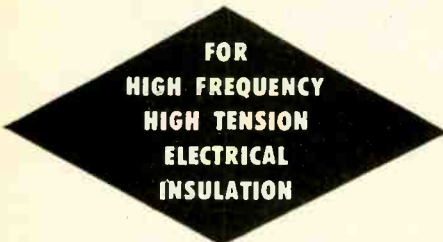

- FOR** Torroids • Coils • Resistors • Deflection Yokes • Antennas
- FOR** Electroplating - Masking surfaces of external recessed diameters
Clean edges eliminate the need of lacquers.
- FOR** End Sealing of Cables.
- FOR** An underwater sealing mechanism both for dielectric and hermetic sealing.

CHECK THESE EXCLUSIVE FEATURES:

- ✓ Fuses into a non-laminar homogeneous mass.
- ✓ Excellent dielectric characteristics—over 1,000 volts/mil.
- ✓ A perfect moisture barrier and corona resistant. (Can be applied at—30° F.) Prolonged ageing without deterioration.
- ✓ Will not corrode metals.
- ✓ Easy to apply—conforms readily to odd contours.
- ✓ S. I. C. 2.12, P. F. .0004 @ 10 m.c.

SEND TODAY FOR FREE SAMPLE STRIP



BISHOP MANUFACTURING CORPORATION
254 West 31st Street, New York 1, N. Y.
Please send BI-SEAL data.

Mr. _____
Title _____
Company _____
Address _____

Factory: Cedar Grove, N. J.

NOW
Production Line
Engraving of BIG Panels

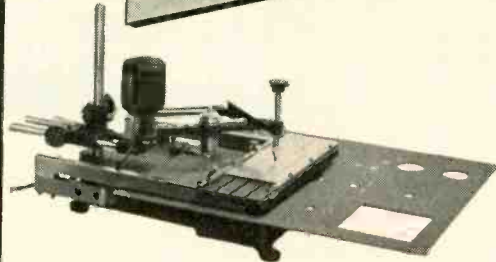

with the GREEN PANEL ENGRAVER

Here's the answer to high engraving costs on large instrument and control panels! No special jigs and fixtures needed with this new Green Panel Engraver . . . saves time . . . does a neater, more accurate job. The principle difference between this and the standard model is found in the master copy carrier which is supported above the machine base. Panels 3/8" thick by 19" wide by any length may be engraved.

Like the famous standard Green Engraver, this new machine does sharp engraving on plastic, metal or wood surfaces by merely tracing master copy. Easily operated by anyone who can write.

If you're fed up with high engraving costs, the Green story makes pleasant reading. So write for details today. Pat. appl'd for



GREEN INSTRUMENT CO.
363 Putnam Ave., Cambridge, Mass.

New accessories cut costs on special jobs

GREEN DRUM ENGRAVER
Rules and engraves in *one* operation. Adaptable to many diameters . . . simple, precise indexing.

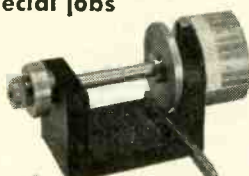

GREEN RADIAL ENGRAVER
Engraves in curves from straight line master copy with automatic spacing. No guesswork or inaccuracies . . . no hand layouts. Pat. appl'd for

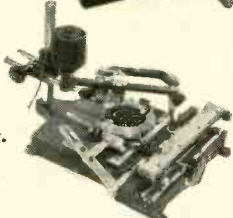

Vectorlyzer TYPE 201

8 CPS TO 500 MEGACYCLES \$385 f.o.b. Passaic

SPECIFICATIONS

Frequency Range:
8 cps to 10 mc through panel binding posts, 20 kc to 500 mc through probe.

Input Impedances:
Probe — 2.5 uuf shunted by 1/4 megohm.
Binding Posts — 14 uuf shunted by 100 megohms.

Voltage Range:
2, 4, 10, 20, and 40 volts, full scale.

Phase Angle Range:
0-180, and 180-360 degrees, ranges with better angular sensitivity can be obtained through panel adjustment.

Accuracy:
±3% through panel binding posts, ±10% through probe.

USE IT TO MEASURE:
1. Vector sum or difference of two voltages. 2. Phase angle between two voltages. 3. Complex components of unknown voltages. 4. Voltage across two points which are both above a.c. ground potential. 5. Unknown impedances.

ADVANCE ELECTRONICS CO.
451 Highland Avenue, Passaic, New Jersey

COILS — C-B — COILS

A dependable manufacturer of Coils and Electronic Assemblies for military applications.

Your inquiry will receive immediate attention. Prompt quotations from blueprints and on Coils to your specifications.

Write, wire or telephone

CADDELL-BURNS MFG. CO.
40 East 2nd St., Mineola, Long Island, N. Y.
TELEPHONE: GARDEN CITY 7-2310

COILS **COILS**

Manufacturers of Kilovolters and Radio and Television Components

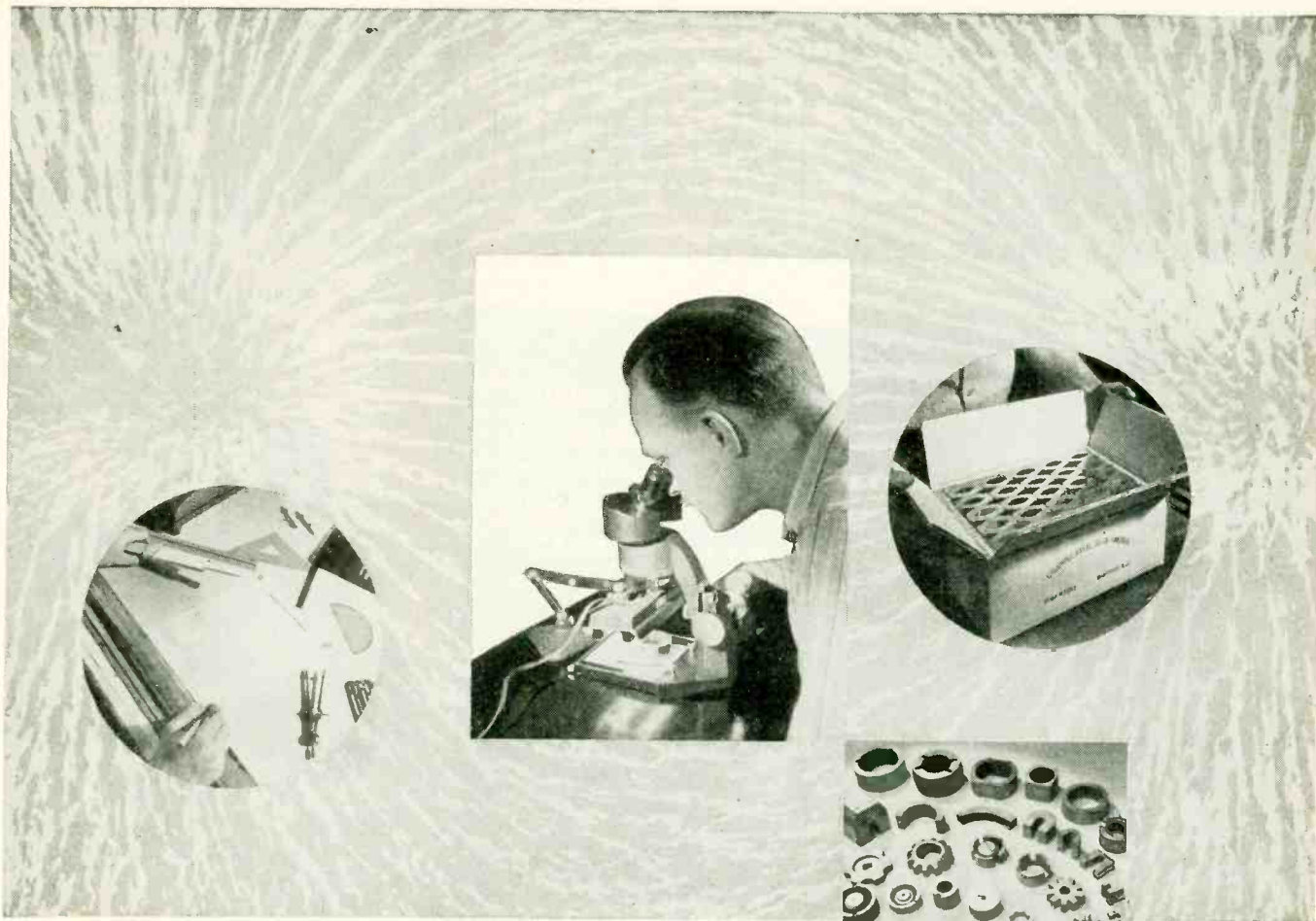

quality magnets from start to finish

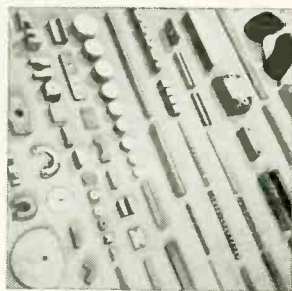

From the first engineering drawing to the final inspection and shipping, Crucible Permanent Alnico Magnets receive the same careful attention and workmanship that is found in all Crucible specialty steels. Rigid quality control at every step in the production of Crucible Alnico . . . with a keen devotion to detail . . . is the reason that users of Crucible Permanent Alnico Magnets have found that from Crucible they get a better magnet with *higher gap flux per unit weight*.

Crucible Alnico Magnets are serving successfully in thousands of varied applications. The experience of Crucible's alert staff of metallurgists and engineers is freely available to you. Take advantage of Crucible's half century of specialty steel leadership. When you think of permanent magnets . . . call Crucible. CRUCIBLE STEEL COMPANY OF AMERICA, Chrysler Building, New York 17, N. Y.

CRUCIBLE

first name in special purpose steels

PERMANENT ALNICO MAGNETS

STAINLESS • HIGH SPEED • TOOL • ALLOY • MACHINERY • SPECIAL PURPOSE • STEELS

ELECTRONICS BUYERS' GUIDE — June, 1951 — MID-MONTH

PRECISION FREQUENCIES

ACCURACY: 1 PART IN 100,000 (OR BETTER) .001%

The controlling unit of these frequency standards is a bi-metallic fork, temperature-compensated and hermetically sealed against humidity and variations in barometric pressure. When combined with related equipment, accurate speed and time controls are afforded by mechanical, electrical, acoustical or optical means.

Instruments of our manufacture are used extensively by industry and government departments on such precision work as bomb sights and fire control.

Whatever your frequency problems may be, our engineers are ready to cooperate.

When requesting further details, please specify the Type Numbers on which information is desired.

FOR USE IN SUCH FIELDS AS

AVIATION
ASTRONOMY
BALLISTICS
HIGH-SPEED PHOTOGRAPHY
VISCOSITY MEASUREMENT
NUCLEAR PHYSICS
TELEMETERING
RADIATION COUNTING
FLUID FLOW
CHEMICAL REACTION
NAVIGATION
SCHOOL LABORATORIES
INDUSTRIAL RESEARCH LABS.
ACCURATE SPEED CONTROL

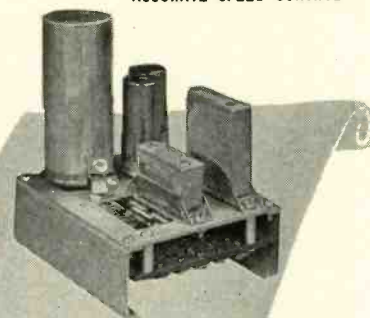

TYPE 2001-2. BASIC UNIT

Frequencies, 200 to 1500 cycles.
Dividers and Multipliers available for lower and higher frequencies.
Miniaturized and JAN construction.
Output, 6 volts.



TYPE 2005. UTILITY UNIT

consists of Type 2001-2 and booster to provide 10 watts at 110 V at 60 cyc. Input, 50-100 cyc.



TYPE 2121A. LAB. STANDARD

Outputs, 60 cycle, 0-110 Volts.
120-240 cycle impulses.
Input, 50-400 cycles, 45 W.



TYPE 2111. POWER UNIT

50 W output, 0-110 V at 60 cyc.
Input, 50-100 cyc., 275 W.

American Time Products, Inc.

580 Fifth Avenue

New York 19, N. Y.

OPERATING UNDER PATENTS OF THE WESTERN ELECTRIC COMPANY

Hold on to this book

It will be
June 1952
before another
edition is published

IT IS THE MOST COMPLETE,
AUTHORITATIVE AND UP-TO-DATE
DIRECTORY OF ELECTRONIC AND
ALLIED PRODUCTS AVAILABLE.

It gives you the manu-
facturers of each of
more than fourteen
hundred electronic
and allied products.



... gives you information
as to where they are in pro-
duction or available in a
reasonable time and unre-
stricted for general indus-
trial use.

1951-1952

electronics BUYERS' GUIDE

Please mention this book when
buying or inquiring from it.

AN 3210-1 . . . snap-acting,
precision switch with heavy-
duty, screw terminals.



SERIES 5501A-10

SERIES 5504A-10



SERIES 5505A-10

SERIES 5506A-10



SERIES 5507A-10

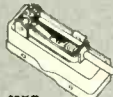

TYPE MXP
push-on, push-off action, for
single-button maintained-con-
tact control.



TYPE MXM
safety interlock with auto-
matic-releasing manually
operated "cheater" latch.

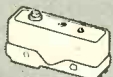

TYPE MXO
two-button switch for main-
tained-contact, ON-OFF ap-
plications.

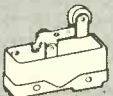

TYPE MXF
with pre-stressed, hinged,
roller-type Adaptaplate giving
long over-travel and a
flat gradient force of operat-
ing.



TYPE MX-1-Z25
continuously adjustable move-
ment differential, from 0.005
to 0.008 in.

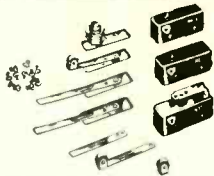

TO SPEED DESIGN

use the Unimax Design Kit.
This useful kit of basic
switches and Adaptaplates
lets you check space and
operating requirements . . .
make accurate mock-ups . . .
hasten prototypes. Aircraft
design kit . . . \$5.00. Order
TODAY.



TYPE MXY-1-Z133
operating point continuously
adjustable through $\frac{3}{8}$ -inch
range.



MB . . . basic switch for
operation at reduced force
and increased movement dif-
ferential.

TO SPEED PRODUCTION

SPECIFY

UNIMAX[®]

for your
AN
needs

RED-TOP PRECISION SWITCHES

EASY TO USE

Save valuable pro-
duction time by fast,
installation with the
full-opening design of Unimax
AN-type metal-cased precision
switches. See (below) how their
unique features help speed pro-
duction.

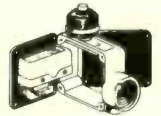

- 1 You can take both side plates off the case for easy wiring.
- 2 Switch is press fit on side-plate studs — can mount on either side of case.
- 3 Metal case mounts on either side, or on base — from above by flanged side plates or from beneath by tapped bosses.
- 4 Neoprene gaskets give oil-proof, splash-proof, dust-proof seal.

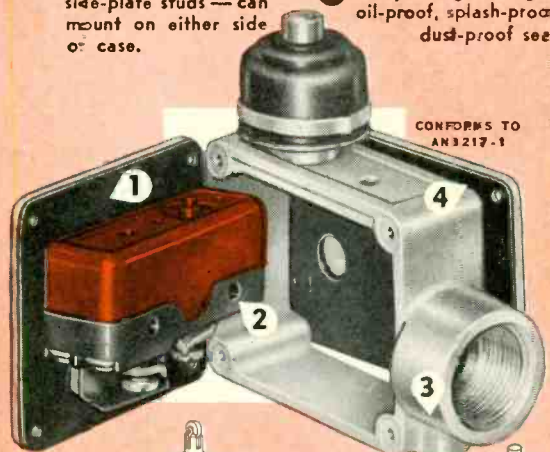

CONFORMS TO
AN 3217-1



AN 3218-2



5502A10



5503A10

EASY TO CHOOSE

There's a Unimax switch for just about any use you can think of. Catalog 50-12 gives dimensions and operating characteristics. Conversion list 51-6 shows AN numbers and corresponding Unimax numbers.

WRITE TODAY for
your FREE copy of cata-
log, AN conversion list,
or both.



UNIMAX SWITCH

DIVISION OF THE W. L. MAXSON CORPORATION
460 WEST 34th ST., NEW YORK 1, N. Y.

BRUSH INSTRUMENTS

For Industrial and Laboratory Use

Brush Development Company comprehensive service offers you the advantages of an expertly staffed, modern electronics and electromechanical laboratory. All the skill and knowledge Brush is applying to the broad field of electronics is available for the solution of your particular design problems. Your inquiries are invited.

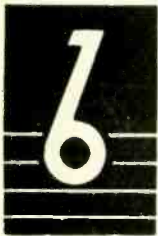

BL-222 COMBINATION DOUBLE CHANNEL MAGNETIC OSCILLOGRAPH

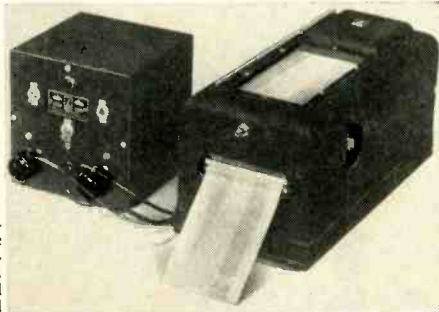

Combination Oscillographs retain basic features of Brush direct inking recorders and offer additional feature of optional use of electric stylus for special recording conditions. Heart of oscillograph is magnetic pen-motor, reproducing electrical signals in the frequency range from DC to 120 cps. Three speed paper drive provided. Adequate for virtually every recording need. A hinged door in the cover permits access to inkwell, pen, and chart paper for minor adjustments and notations. Entire cover may be easily removed for reloading chart paper, etc. Also supplied in a single channel model in the same chassis known as the Model BL-221. Each model is furnished with both inking pen and electric stylus, six rolls of chart paper and one 2 oz. bottle of both purple and green charting ink. A BL-944 Power Supply is furnished with either model.

Chart Paper... BL-222—3 15/16" W

BL-221—2 3/8" W

5mm. longitudinal divisions

1mm. transverse divisions

Paper Speeds... .5, 25, and 125mm/sec.

Chart Drive Motor... .105—125V, 50

—60 cycles, 40w, synchronous

Net Wgts... BL-222—25 Lbs.

BL-221—20 Lbs.

Shipping Wgts... BL-222—28 Lbs.

BL-221—23 Lbs.

Dimensions... 6 7/8" H, 6 1/2" W,

14 7/8" L

Electric Stylus Power Supply...

Dimensions 6" x 6" x 6" Shipping Wgt. 10 Lbs.

BL-206 SIX CHANNEL MAGNETIC OSCILLOGRAPH

Consists of six magnetic Penmotors mounted in a line, recording on 12" wide chart paper. On standard units, a paper speed of either 125 mm/second, 100 mm/second, 50 mm/second or 25 mm/second plus 1/5 or 1/10 of this speed can be provided. Other speed combinations available on special units. Chart paper may be torn off or rolled as desired. Has approximate dimensions of 20"x17"x17". Provides excellent recording medium for multiple strain gage recording, vibration analysis, wind tunnel work, etc. Either DC or AC circuits may be measured. Assures uniform frequency response and a linear phase shift with frequency. Furnished with or without AC or DC amplifiers to fit particular applications. Linear frequency response from DC to 100 cps, when used with our amplifiers.

BL-928 DUAL CHANNEL DC AMPLIFIER

Developed primarily for coupling external circuits to either the BL-202 or BL-202A double channel magnetic Oscillographs, where high gain is not essential. It will give simultaneous graphic records of two electric phenomena of amplitudes of 40 millivolts or more and frequency components between 0 and 100 cycles. Particularly useful in the study of battery characteristics, photocell outputs, electrolysis surveys, and characteristics of dc generators and motors. A useful tool for the experimenter as a unit for matching special amplifiers to the magnetic Penmotors, as, for example, in electrocardiograph or electroencephalograph work.

The two amplifiers are contained in a single case with carrying handle provided on front panel for ready portability. Control panel located at front of amplifier case contains a "factor of 10" attenuator, gain control and a pen positioning bias control for each amplifier. A dc calibration source is supplied in the form of an accurate standard cell.

Frequency response DC to 100 cps

Sensitivity... .1 chart mm/50 mv

Stability... .025 chart mm pen drift

or less per hour

Voltage gain... 25 times (approx.)

Power Requirements

95 to 125 volts

60 cycles

145 watts

Input impedance... 10 megohms

Output impedance... Approx. 50

ohms must not be loaded with

less than 1500 ohms

Input voltage range... .05 to 200v

Output voltage... .15 v (max RMS)

Dimensions 17 1/4" long x 11" wide

x 7 1/2" high.

Net weight... 30 lbs.

Tubes required

4—6F5, 2—6V6, 4—VR150

BL-502 TRANSIENT RECORDER: Designed to record and graphically represent varied transient phenomena of 2/10 sec. or less. Transient phenomena capable of being converted into electrical impulses recorded and reproduced automatically. Such transients as vibrations, explosion waves, light flashes, welding cycles, etc. are a few that can be recorded. Reproduction repeats continuously for visual analysis by a cathode ray oscilloscope.

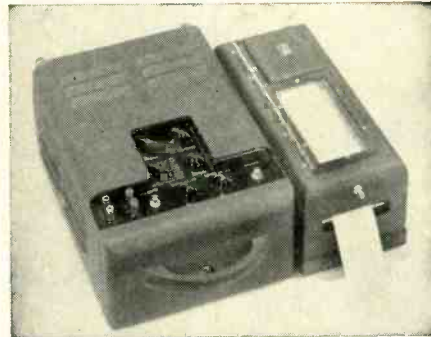

BL-320 UNIVERSAL AMPLIFIER

When used with Brush Magnetic Direct Inking Oscillograph, is a complete package unit for measurement of strains. Simply operated, producing records which are immediately available and easily interpreted. Records either static or dynamic strains up to 100 cps, and direction as well

as magnitude of the measured strain can be read from the chart. Connections brought out so 1 to 4 active gages may be used. If less than 4 active gages used, dummy gages or precision resistors must be substituted for missing gages to complete bridge network. One of the dummy gages may be used for temperature compensation when one active gage is employed. Provision is made for connecting an internal calibrating resistor in the bridge circuit and adjusting the overall gain. Readily calibrated for individual gages, so that strain can be read directly in microinches per inch from the chart deflection. Can be used to record pressures, temperatures, accelerations, forces, etc., provided the equipment is calibrated in terms of the particular pickup used. The output consists of 3 stages, direct coupled, designed to match characteristics of direct inking oscillograph. This section may be used as general purpose, low gain d-c amplifier with gain and centering controls provided. May be adapted for use with Esterline-Angus or other similar graphic recorders.

Recommended gages... 120 ohm

type (50 to 1000 ohm gages may

be used).

Range of measurable strain... 10

to 40,000 microinches/inch with

one active gage. (Greater sensi-

sitivity obtained when more

active gages are employed.

Frequency response (when used

with Brush Direct Inking Oscil-

lograph)... d-c to 100 cps.

Bridge Energizing Frequency

2,000 cps.

Output Impedance... Approx. 50

ohms (Not to be loaded with

less than 1500 ohms)

Power required... 100 to 125 v., 60

cps., 135 w.

Dimensions 17 1/4" long x 11" wide

x 7 1/2" high.

Weight... 30 lbs.

Tubes Required... 2—6SF5, 1—6C5,

1—6H6, 1—6SN7, 2—6V6, 2—

VR150, 1—VR105, 1—VR75, 1—

5U4GT.



BL-932 D-C AMPLIFIER

Designed for use with Brush Magnetic Direct Inking Oscillograph, also used to make recordings of many types of phenomena heretofore measured only with the aid of complicated intermediate equipment. Studies of static or dynamic conditions, such as strains, displacement, pressures, light intensities, temperatures, d-c and a-c voltages or currents, and many others are simplified by the use of the Brush Direct Inking Oscillograph

with the BL-932 Amplifier. Voltage gain is sufficient to give 1 chart mm deflection per mv input. Novel design features combined with both plate and heater voltage regulation reduce effects of power line fluctuation. Zero signal drift amounts to not more than 1 chart mm per hr. Frequency response essentially uniform from d-c to 100 cycles per sec. Control panel located at front contains a factor of 10 attenuator, gain control, calibrating meter and controls for determining input voltages. Balancing potentiometer provided for electrically biasing oscillograph pen to any position on the chart.

Frequency response... DC to 100 cps

Sensitivity... .1 chart mm/mv

Stability... .1 chart mm pen drift

or less per hr.

Voltage gain... 1000 times (Ap-

prox.)

Power requirements... 105 to 125 v

60 cycles 125 w

Input Impedance... 10 meg

Input voltage range... .001 to 200 v

Dimensions... 17 1/4" long x 11"

wide x 7 1/2" high

Net Wgt... 34 lbs.

Shipping wgt... 38 lbs.

Balancing control... Helipot (10 rev-

olutions)

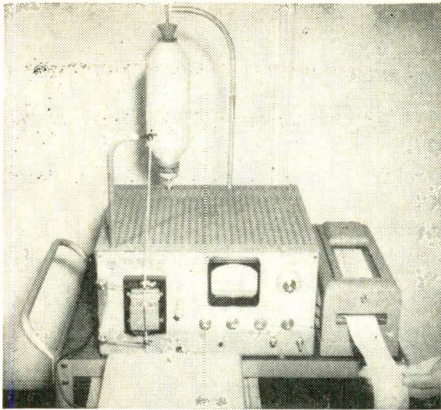

BL-314-A UNIFORMITY ANALYZER

An electronic instrument designed to measure and make a permanent record of irregularities in weight per unit length of yarn, roving, and sliver. As the material to be measured is passed continuously through the measuring heads, the cotton count at any given point, or the average cotton count, is shown on the calibrated meter, and a running record graph is drawn automatically by the recorder. The instrument requires only minor changes to be used for the inspection of wool, nylon, rayon, and various plastics. Available as an accessory is an automatic evaluator for rapidly determining the percent non-uniformity. Additional accessories include graduated sensing heads, external meter, chart take-up drive, and mounting table.

Supply Voltage...110-120 Volts AC
Power...230W
Weight...90 Lbs.
Amplifier Dimen...9 1/4" x 17" x 18"
Sensing
head—1...08 to 1.5 cotton count
head—2...8 to 15 cotton count
head—3...8 to 150 cotton count
Speed of Measurement... 2 motor drive supplied

Drive 1—Yarn—5 feet per second
Drive 2—Roving and sliver—6 inches per second
Recorder Speeds...5, 25, and 125 mm per second
Package Handling—Yarn may be run from cones, cheese, tubes, and bobbins. Roving may be run from bobbins and sliver from cans. Package holders, guides and tension are supplied.

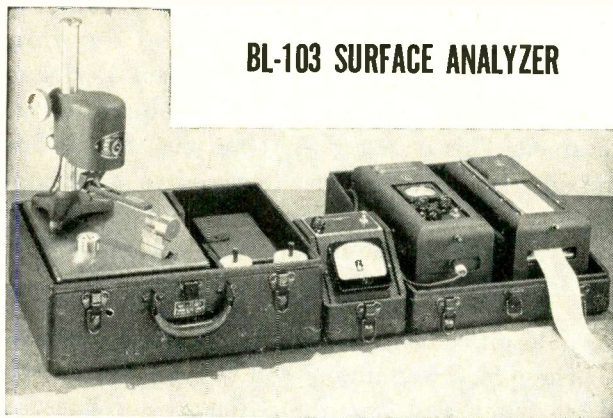

BL-103 SURFACE ANALYZER

For exploration, and instantaneous charting of surface finishes—metals, glass, plastics, paper, plated and painted surfaces from less than 1 to 3000 microinches. Complete with PA-2 Pickup Arm, Drive Head, Amplifier, Magnetic Oscillograph, Surface Plate, Carrying Cases, Glass Calibration Standard, 2V-Blocks, 6 rolls Chart paper, one 2 oz. bottle Red Ink, connecting cords and operating instructions. BRUSH "RMS" METER: "average reading" type calibrated in terms of the "RMS" value of an equivalent sine wave. Provides constant visual check of "RMS" surface roughness where "hill and dale" chart profiles are not needed. Convenient to read because of large illuminated dial. "RMS" Meter may be purchased separately or with Surface Analyzer. ROUGHNESS RANGE—1/2 to 125 microinches (may be extended) POWER REQUIREMENTS—105 watts, 105-125 volts, 50-60 cycles DRIVE HEAD—Model DA-2 STROKE—1/16" reciprocal .0125" per second Complete Cycle—10 seconds. Height Adjustment—7 inches PICKUP—Model PA-2 Roughness Range—1/2 to 125 microinches "RMS" Exploring Stylus—Diamond, .0005" tip radius Minimum Bore—.250" dia. x .750" depth Maximum Penetration—4" for dia. 1.125" or greater CALIBRATING AMPLIFIER Maximum Voltage Gain—2000 times Input Voltage Range—.001 to 300 volts Maximum Output Voltage—22 volts peak. Input Impedance—10 meg-ohms MAGNETIC OSCILLOGRAPH—Model BL-201 Frequency Response—1/4 to 120 cps with BL-905 amplifier Chart Speeds—5, 25, 125 mm. per second. Chart Drive—Synchronous Motor MODEL BL-106 "RMS" METER Scales—3 and 10 microinch Frequency Range—1/4 to 120 cps Circuit—Rectifier type meter reads true "RMS" value of a Sinusoidal input signal.

The following instruments are manufactured in Denmark by The Bruel and Kjaer Company, and distributed exclusively in the United States and Canada by The Brush Development Company.

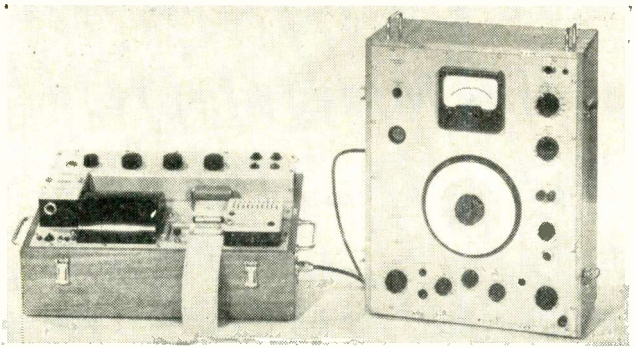

BL-2301 HIGH SPEED LEVEL RECORDER

Designed for acoustical and electro-acoustical measurements, incorporating a potentiometer controlled moving-coil stylus drive system, and a variable speed paper drive.

Input Frequency Range...20 to 200,000 cps.

Zero Level...adjustable between 3 and 12mV. A reference voltage of 10mV is supplied.

Writing Speed...Variable in nine steps between 50 and 1000 db/sec.

Paper Speed...Choice of 10 speeds between 0.003 and 100 mm/sec.

Connection to other instruments provided through two mechanical power take-offs.

BL-1011 BEAT FREQUENCY OSCILLATOR

Of particular use in conjunction with Level Recorder.

Frequency Range...0 to 20,000 cps.

Frequency Accuracy...1% ± 1 cps.

Output Impedance...variable in four steps between 6 and 6000

Output Power...maximum 3 watts, cont. variable volume control.

Vacuum Tube Voltmeter...reads exact output voltage.

Attenuator...10 step attenuator provided.

Warble Tone...Mod. freq. variable from 1 to 32 cps. Band width from 0 to ±200 cps.

Compressor...regulating amplifier controls 45 db range, maintains constant output.

Connection to Level Recorder... provided through flexible drive shaft.

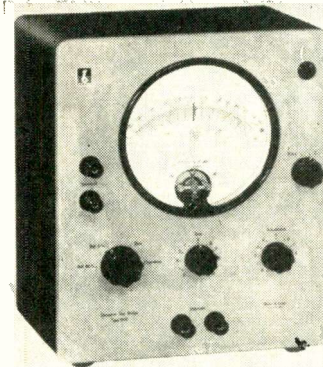

BL-1502 and BL-1507 DEVIATION TEST BRIDGES

For high speed production checking of resistors, capacitors, inductors. Indicates percentage deviation from standard on large meter with zero point in center. Full scale deflection at 7% and 25%.

BL-1502 frequency 1000 cps, ranges resistance 100 ohms—10 meg, capacitance 50 μf—10 μf, inductance 2mh—100h. BL-1507 frequency 50 kc, ranges resistance 20 ohms—100,000 ohms, capacitance 255 μf—0.1 μf, inductance 100 μh—0.3h.

BL-2002 HETERODYNE VOLTMETER... a high frequency selective vacuum tube voltmeter for range 20 kc to 27 mc, measures both voltage and modulation. Full scale deflection from 10 μv to 10 volts.

BL-4703 FREQUENCY RESPONSE TRACER... for analyzing audio frequency response of amplifiers, receivers, loudspeakers, microphones. Five inch CR tube synchronized with Beat Frequency Oscillator presents plot of response in db vs freq. Audio Oscillator 0-20,000 cps... constant output radio freq. oscillator 1 mc mod. 30%... CR Oscillograph Component, 50 db range presented through logarithmic amplifier. Trace area 3 5/16" x 2".

The BRUSH DEVELOPMENT CO.

3405 PERKINS AVENUE
CLEVELAND 14, OHIO, U.S.A.

There's a **NEW SILHOUETTE**
on the **Microphone Horizon...**

The **NEW ULTRA-CARDIOID**

DYNAMIC 55s
"THE PERFECT PERFORMER"

SMALL Unidyne



MODEL 55s
List Price \$72.50

The New Small Unidyne is approximately only half as large as the Standard Unidyne.

- ▶ Eliminates Feedback Problems
- ▶ Permits performer to stand farther from the microphone



Model 55s Small Unidyne

This mighty, though little, Microphone, is the *only* small-size, uni-directional moving-coil dynamic microphone! With this "Perfect Performer," all the important directional qualities are retained. This New Small "Unidyne" Model 55s offers superior performance, featured in a streamlined, small, functionally designed case. The 55s is actually a new Microphone retaining all the highly desirable features of the Model 55 "Unidyne."

The internal unit is based on the Shure-patented "Uni-Phase" principle. The moving-coil system has a high over-all efficiency and smooth frequency response. A large air-gap clearance and a rugged coil construction provide immunity of the moving-coil system to abnormal atmospheric conditions and severe mechanical shocks.

The New Small "Unidynes," Models 55s and 556s, are not replacements for the current Models 55 and 556 "Unidynes." The regular "Unidynes" will not be discontinued. Let your customers decide which they prefer of these four outstanding microphones.

"not 2 but 4!"

Model 55s Small Unidyne	Code: RUDOT List Price: \$72.50
Model 556s Small Broadcast	Code: RUDOV List Price: 100.00
Model 55 Standard Unidyne	Code: RUMUL List Price: 72.50
Model 556 Standard Broadcast	Code: RUMUB List Price: 100.00

Patented by Shure Brothers, Inc.

Model 556s Small Broadcast Dynamic



SHURE BROTHERS, Inc.

225 W. Huron St., Chicago 10, Illinois

★ **MANUFACTURERS of MICROPHONES and ACOUSTIC DEVICES**
• **Cable Address: SHUREMICRO**

CROLOY RADIO RODS

Replacing usual loops. Spell new reception standards. Permit mounting on chassis, and final test before placement in cabinet. "Q" of order of 250 as against 80 for small loops. Usual Croloy radio rod is 8" l. by 1/2" d. Other sizes available.



CROLOY CORES

Molded in widest range of shapes and sizes. Deflection yokes expand TV-tube deflection angles without corresponding voltage increase. Croloy cores slash TV transformer bulk.

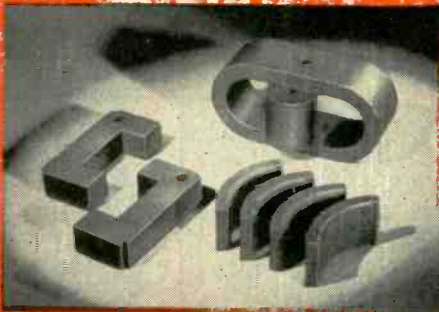

CROLOY RADIO CORES

Croloy slug tuners and I.F. coils reduce cost and raise gain. Made in widest variety of designs, sizes and modifications. With screw inserts, with threaded bodies, cup-shaped, tiny closed cores, etc. Choice of compositions to meet electronic characteristics.



EXTRUDED CROLITE

From tiny tubes no bigger than pencil lead and with one or two longitudinal holes to tubes, rods and blocks up to 4" dia. Widest variety of cross-sectional shapes. The Crowley extrusion technique minimizes machining.

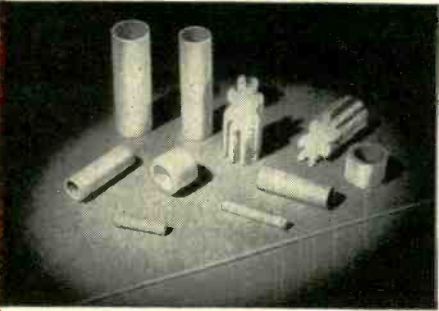

PRESSED CROLITE

Formed in standard or custom molds into the widest choice of shapes and sizes, thereby minimizing machining. High degree of accuracy to fit with metal parts in any assembly. Plain or glazed finish.



MACHINED CROLITE

Elaborate shapes, including grooves, bobbins, holes, threads, fins and other features, can be included in Crolite machined pieces. Precision machined tools in the hands of skilled specialists, insure the matching of rigid mechanical specifications.



parts from powders

Consider Crowley your No. 1 source of supply for magnetic and ceramic pieces. For here, under one roof, are specialists who have pioneered the "parts from powders" art for the radio-electronic industry.

Crowley means production facilities that have supplied the major portion of magnetic cores in peace and war alike. Here are extrusion, molding and machining facilities that can provide steatite and other severe-service insulators in the widest range of characteristics, sizes, shapes.

By all means try Crowley! You can save time, money and trouble, just as other electronic designers, engineers and production men are doing.

*Let us collaborate
on your TV, radio or electronic
problems. Samples,
engineering aid, and quotations,
on request.*

HENRY L. CROWLEY & COMPANY, INC.
Pioneering POWDER-IRON and STEATITE products
1 Central Avenue
West Orange, N. J.

SPECIFY:

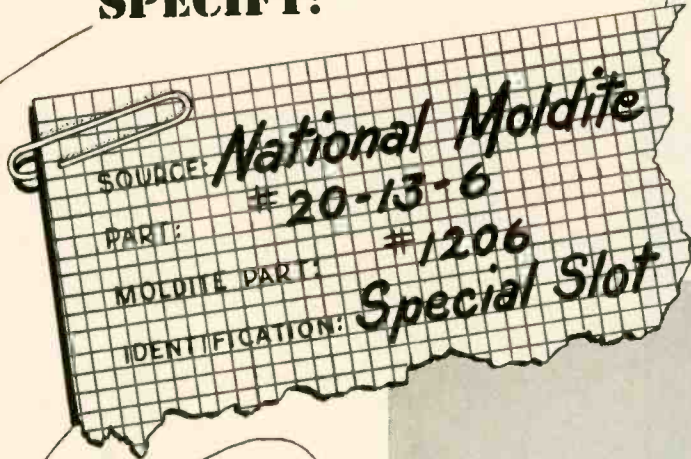

Precision Controlled



Cores For Every



Electronic Use



Sam p l e s
p r o m p t l y
s u b m i t t e d
u p o n
r e q u e s t
f o r
d e s i g n,
p r e - p r o -
d u c t i o n,
a n d
t e s t
p u r p o s e s.

SEND FOR CATALOG 106

Jerry Golten Co.
2750 W. North Ave.
Chicago 22, Ill.

Perlmuth-Colman & Associates
1335 South Flower
Los Angeles, Cal.

(Northern N. Y.)
Martin P. Andrews
Garden City, N. Y.

Jose Luis Pontet
Cardoba 1472
Buenos Aires

... on
the principle
that it
costs less
to work with
the finest!

**NATIONAL
MOLDITE
COMPANY**

1410 CHESTNUT AVE., HILLSIDE 5, N. J.

**The New STAVER
MINI-SHIELD**
PATENT AND TRADE MARK REG. PEND.



The
shield
that fits
all
Miniature
Tubes

A flexible shield that snugly fits all miniature tubes because it compensates for all variations in tube dimensions. Mini-Shields are made for both T5 1/2 and T6 1/2 bulb tubes. Send for catalog sheet.

**The New STAVER
MINI-SPRING**
PATENT AND TRADE MARK REG. PEND.

Available!
Special
Improved
Types for
Military
Apparatus



Gives support two ways—Keeps pressure downward and gives sideway support. The spring action is constant and resilient permanently. Send for catalog sheet.



91 PEARL STREET • BROOKLYN 1, N. Y.
ULSTER 5-6303

WORKSHOP antennas

A Complete Line for all High-Frequency Bands

AMATEUR	COMMERCIAL	RADIO RELAY	GOVERNMENT
TELEVISION		MICROWAVE RELAY	RADAR
FM		STL RELAY	GUIDED MISSILE OR ROCKET-BORNE
EMERGENCY SERVICES		TV RELAY	COMMUNICATION AND NAVIGATION

The WORKSHOP line covers all bands from 28 mc. up. Our standard antennas fit the majority of applications, but where special situations must be met, slight modifications in design usually accomplish the desired result.

Engineering and Contract Service. The WORKSHOP handles scores of special government and commercial antenna problems every year from design through production. With our new plant and greatly expanded facilities, we are able to handle a larger proportion of this type of contract work than ever before.

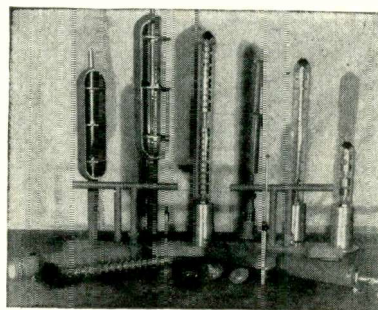

A representative group of high-precision radar antennas.

TYPE and USE	MODEL NO.	FREQUENCY (MCS.)	GAIN* (DB.)	HALF POWER ANGLE	
				E Plane *	H Plane *
PARABOLIC For radio, microwave, STL and TV relay, radar, and communications.	940	920-960	19.0-28.0	19.75-7.8	17.75-6.9
	2000	1990-2110	27.0-34.5	10.28-3.65	9.2-3.25
	6075	5925-6225	36.0-42.0	3.24-1.47	2.86-1.32
	6725	6575-6875	36.8-42.8	2.79-1.47	2.50-1.32
	7275	7125-7425	37.0-43.0	2.70-1.36	2.42-1.21

* Gain and Half Power Angles are dependent on size of parabolas, — 4, 6, 8 or 10 foot diameter.

DIRECTIONAL and BI-DIRECTIONAL	MODEL NO.	FREQUENCY	GAIN	ANGLE	
				Horizontal	Vertical
For police, highway patrol, railway, forestry, utilities, oil fields.	33C	29.5-36.5	7.8	64°	68°
	40C	36.5-43.5	7.8	64°	68°
	47C	43.5-50.5	7.8	64°	68°
	74C	72-76	7.8	64°	68°
	144C	140-146	7.8	64°	68°
	149C	146-152	7.8	64°	68°
	155C	152-157	7.8	64°	68°
	160C	157-162	7.8	64°	68°
	165C	162-168	7.8	64°	68°
	171C	168-174	7.8	64°	68°

BEACON	MODEL NO.	FREQUENCY	GAIN	ANGLE
For fire, police, taxicab, aeronautical, and private fleet communications.	2HW	108-144	2.7	31°
	3HW-B	144-152	4.2	24°
	3HW-A	152-162	4.2	24°
	3HW-2	162-174	4.2	24°
	6HW-A	450-460	8	
	6HW-B	460-470	8	

TELEVISION	MODEL NO.	DESCRIPTION
	A	3-element, high gain (5 db.), directional; a model for each TV channel.
	2A	Two series A's spaced 1/2 wave apart, connected by cable harness.
	VV	All-channel, high gain, sharp directivity, patented.
	2VV	Double-stacked VV for higher gain, distant reception.

AMATEUR A complete line for 2, 6, 10 meters and UHF.

CABLE FITTINGS AND ACCESSORIES

Model T-72 Matching Transformer. Matches 72 ohm coaxial cable such as RG-59/U to 300 ohm receivers. Voltage step up of 2:1, with a flat response over the TV channels from 52-216 mcs. A W-50 solderless cable connector is furnished. Size 2 inches long, 1-inch diameter.

Model T-300 Exterior Matching Transformer. Completely weatherproof device for converting 72 ohm antennas for use with inexpensive 300 ohm Twin Lead transmission line at reasonable efficiency. Can also be used with 300 ohm antennas to realize benefits of 72 ohm coaxial cable.

Model W-50 Silver Plated Solderless Cable Connector (Male). Used with RG-59/U coaxial cable. Specially slotted to withstand considerable strain. Mates with W-60 receptacle (on R-4A switch) and W-80 junction listed below.

Model W-60 Silver Plated Chassis Receptacle (Female). Mates with W-50 cable connector. For chassis or panel mounting. Threaded stem 1/8 inch long. Soldering terminal protrudes from rear.

Model W-80 Silver Plated Cable or Panel Junction (Female). Mates at either end with W-50 male connector. A complete splice requires one W-80 junction and two W-50 connectors which must be ordered separately.

Model W-100 Cable Adaptor. Required when changing from larger size RG-11/U or RG-8/U to smaller RG-59/U coaxial cables. No soldering necessary. W-50 cable connector furnished.

Model R-4A New Coaxial Switch (SP4T). This virtually lossless, constant impedance switch will connect any one of four single-channel TV antennas to a receiver. By simply using additional switches it can also be used for demonstrating any number of TV receivers in a display room, or for low-level audio applications. Size — 2 1/2 inches front to back; 2-inch diameter.

If your product or service requires high-frequency antennas — research, design, test, or production — get in touch with the WORKSHOP. Write, or phone Needham 3-0005. No obligation.

THE WORKSHOP ASSOCIATES, INC.

135 CRESCENT ROAD, NEEDHAM HEIGHTS 94, MASSACHUSETTS

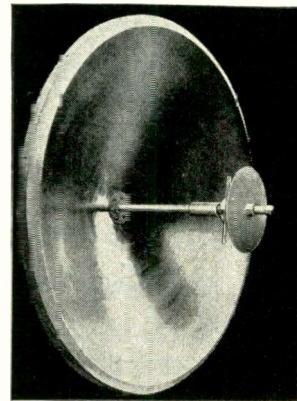

Standard Parabolic Relay Antenna for Studio-to-Transmitter Link on 920-960 mc. band.

Left — High-Gain Beacon Antenna. Recommended by all 152-162 mc. equipment manufacturers. Hundreds are in use throughout the country.

Below — WORKSHOP DUBL-VEE Television Antenna, double-stacked.

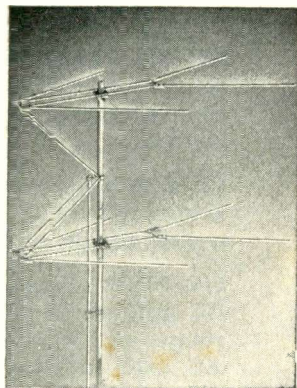

Below — 10 over 20 Stacked Array — the last word in amateur antenna equipment.

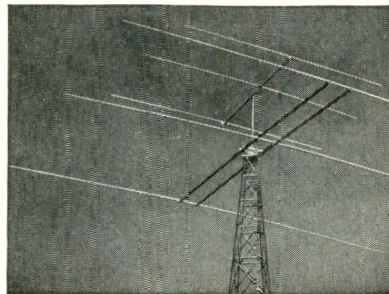



HEAD CUSTOM



DYNA-MYKE
Model 129



DYNA-METER
Model 144



UNI-BRIDGE
Model 128

Sign of

ADVANCED INDUSTRIAL INSTRUMENTATION

- ➔ Measuring
- ➔ Indicating
- ➔ Recording
- ➔ Controlling

DYNA-MYKE Model 129—A high speed dynamic micrometer capable of indicating displacements as small as 1 micro-inch at frequencies as high as 1000 cps. The system indicates, controls and records, using either differential transformer or strain gages.

DYNA-METER Model 144—When used with the DYNA-MYKE, indicates by neon lights the peak amplitude of transients as fast as 1 Millisecond. Indication may be instantaneous or a memory feature may be used to maintain reading. Built-in power relays provide on-or-off control to any plus or minus limits established by DYNA-MYKE.

UNI-BRIDGE Model 128—Universal DC power supply and bridge control system. Contains micro-ammeter, balancing and calibrating circuits, output jack and chopper.

CALI-POWER AC Model 132—A precision source of calibrated AC voltage. Provides 10 watts of power in full scales, ranges of 1 millivolt to 100 volts.

CALI-POWER DC Model 145—A precision source of calibrated DC voltage. Provides 10 watts of power in full scales, ranges of 10 millivolts to 100 volts. Like Model 132, AC, used for driving and calibrating amplifiers, voltmeters, resistance bridges, transducers, penmotors, galvanometers, etc.

CALI-BRIDGE Model 134—Combines CALI-POWER DC with the UNI-BRIDGE. A more versatile instrument for signal calibration, as well as for bridge control purposes.

THE USE OF THESE INSTRUMENTS can reduce manpower and eliminate causes of scrap at the source. Examples: measuring and indicating press vibration, micro-inch surface finish; indicating and controlling hydraulic or pneumatic pressure; measuring structural or metallic creep; gaging and controlling thickness of metals, plastics and fabrics.

Applications

LINEAR VARIABLE DIFFERENTIAL TRANSFORMERS for minute displacements. Employed as the sensing element in the DYNA-MYKE, which is designed for use with commercially available pickups, accelerometers, transducers, etc. Fig. 1.

STRAIN GAGES for use with the UNI-BRIDGE, CALI-BRIDGE, and DYNA-MYKE, self-contained instruments for all types of gaging and recording. Fig. 2.

ACCELEROMETERS for all ranges and natural frequencies, in miniature. Weight less than 1/2 ounce. Indicating, recording and controlling by DYNA-MYKE and DYNA-METER.

SURFACE FINISH GAGE HEADS, Standard and Custom Built, employing differential transformers as sensing element. Measuring, indicating, recording and controlling by DYNA-MYKE and DYNA-METER. Fig. 4.

VIBRATION PICKUP for direct reading of displacements as small as ± 1 micro-inch at frequencies from zero to 1000 cps. Fig. 5.

PRESSURE PICKUP for hydraulic or pneumatic application, custom built to your specifications. Fig. 6.

CONTROL BOX balancing network for use with UNI-BRIDGE, CALI-BRIDGE, or DYNA-MYKE, using either strain gages or differential transformers. Fig. 7.

SELECTOR SWITCH controlling as many as ten channels of measurement with one Selector Switch, ten Control Boxes, and one UNI-BRIDGE, CALI-BRIDGE or DYNA-MYKE. Fig. 8.

SCALE with sensitivities of one part in 10,000, using DYNA-MYKE system. Unlimited range. Fig. 9.

AND INFALLIBLE QUALITY CONTROL adaptable to most processes. Automatic precision inspection on the machine with DYNA-MYKE; instant acceptance, rejection, appropriate action when teamed up with DYNA-METER.



BUILT INSTRUMENTS



CALI-POWER
AC Model 132



CALI-POWER
DC Model 145

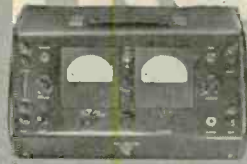

CALI-BRIDGE Model 134

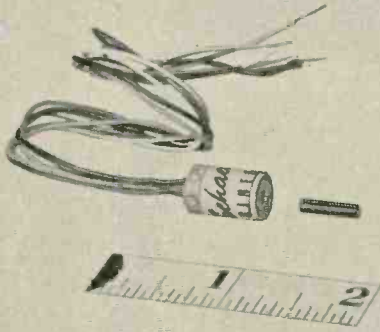

1. Linear Variable Differential
Transformer

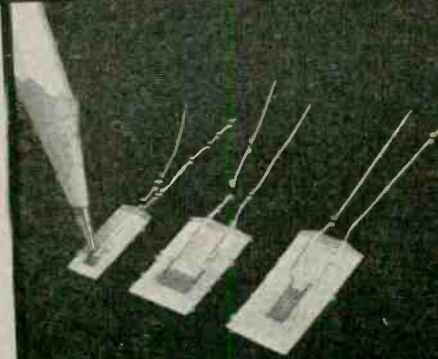

2. Strain
Gages



3. Accelerometer

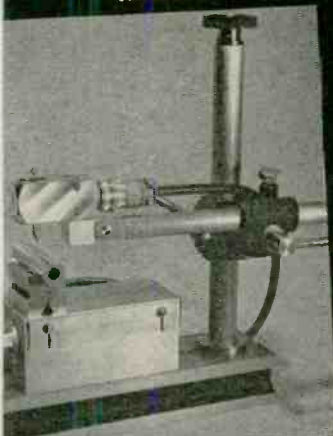

4. Surface Finish Gage Head

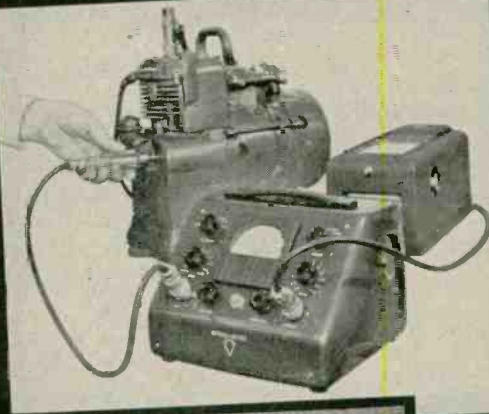

5. Vibration
Pickup

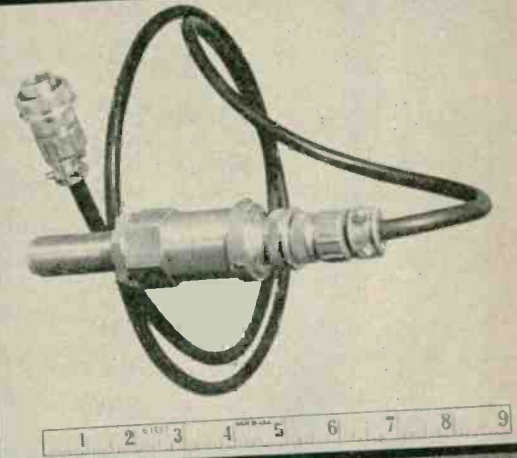

6. Pressure
Pickup



7. Control Box



8. Selector
Switch



9. Scale

INDUSTRIAL ELECTRONICS, INCORPORATED
8080 WHEELER STREET • DETROIT 10, MICHIGAN

IN BUSINESS

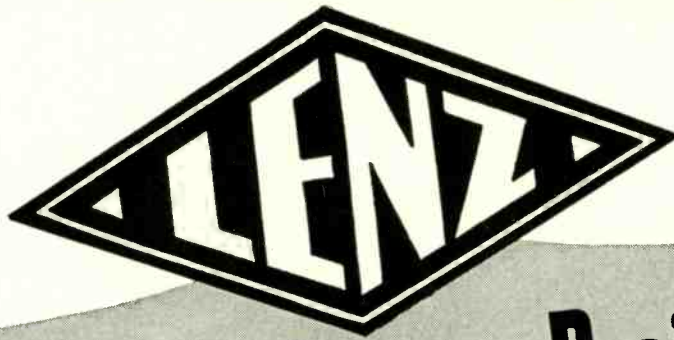

SINCE 1904

Wire for Defense Projects!

**HOOK-UP WIRES and CABLES
for COMMUNICATIONS EQUIPMENT
and ELECTRONIC INSTRUMENTS**

FOR almost a half century Lenz has been producing insulated Wires and Cables for the Communications Industries, wires that are engineered and designed under high quality standards.

Now, Lenz is prepared to furnish hook-up wire and cables for defense projects, conforming to Government specification JAN-C-76 TYPES WL, SRIR and SRHV.

These Thermo-Plastic Insulated Wires, with or without Lacquered Braids, and the cables constructed of same, are available for use in Communications Equipment and Electronic Instruments.

For a dependable source for your wire and cable requirements, consult Lenz.

CONFORMING TO
JAN-C-76
TYPES WL, SRIR and SRHV

IN THE AIR

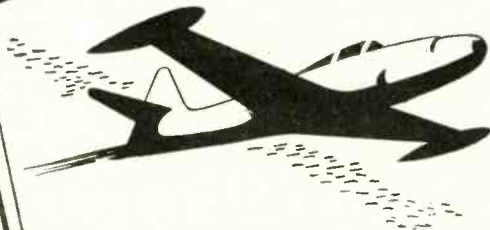

ON LAND



ON THE SEA

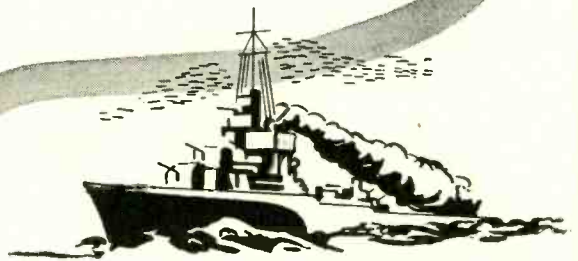

LENZ ELECTRIC MANUFACTURING CO.

1751 No. Western Ave. • Chicago 47, Illinois

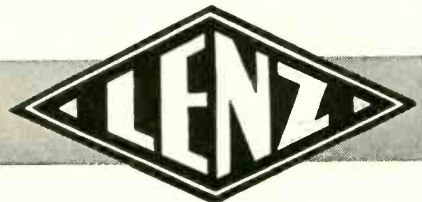

three new ways to

TELEX LISTENING COMFORT

TWINSET*



Nothing touches the ear!

Adjusts to any head without pinching or pressure... Adjustable sound arm need not touch ear... Entire unit weighs only 1.6 oz... Flexible, can be slipped into pocket... C. A. A. approved...

	List	Dealer Net
Twinset Only.....	\$12.95	\$7.77
Twinset with Cord.....	17.00	10.20
Monocord Only.....	4.05	2.43

SPECIFICATIONS

Sensitivity: 101 db. above .000204 dynes per sq. cm. for 10 microwatts input. *Impedances:* 1000 ohms—brown; 64 ohms—yellow. Coding visible inside female socket. *Construction:* Tenite plastic and bright nickel. Headband, Z-nickel steel wire cased in plastic. 5 ft. Monocord plugs into either receiver. Special cord with built-in volume control available.

MONOSET*



Direct Signal for Both Ears!

Stethoscope design eliminates tiresome pressure... Blocks out background noise... Weighs only 1.2 oz... Excellent for communications, dictation equipment, aircraft radio, etc...

	List	Dealer Net
Monoset Only.....	\$9.95	\$5.97
Monoset with Standard Cord.....	14.00	8.40
Monoset with Volume Control Cord.....	18.30	10.98
Standard Cord Only.....	4.05	2.43
Volume Control Cord Only.....	8.35	5.01

SPECIFICATIONS

Sensitivity: 88 db. above .000204 dynes per sq. cm. for 10 microwatts input. *Impedances:* 128 ohms, 500 ohms, 2000 ohms. *Construction:* Sealed magnetic receiver... Grey polished Tenite plastic... Removable plastic eartips... 5 ft. tinsel cord with standard plug... Built-in volume control optional.

EARSET*



Slips onto the ear!

Flat plastic frame slips onto ear, holds the sensitive receiver securely in place... Weighs only 1/2 oz... User's other ear is always free for phone calls or conversation... Fits either ear, may be worn by anyone...

	List	Dealer Net
Earset Only.....	\$7.75	\$4.65
Earset with Cord.....	11.80	7.08
Standard Cord Only.....	4.05	2.43

SPECIFICATIONS

Sensitivity: Comfortable listening level with 3 milliwatt input. *Impedances:* 120 ohms, 2000 ohms. *Construction:* Clear plastic ear frame. Sealed, rustproof receiver. 5 ft. Monocord with standard phone plug connection.

Standard of the World for Quality Headsets



TELEX hearing at its best

ELECTRO-ACOUSTIC DIVISION—DEPT. A-11
TELEX PARK—ST. PAUL 1, MINNESOTA
IN CANADA, ATLAS RADIO CORP., TORONTO

*TRADEMARK

Direct
marking
on

COMPONENT PARTS

is easy and
inexpensive
with these two
MARKEM
MACHINES

Both have been designed expressly for the electronic field. With them, you can imprint vital identification data and trade marks directly on cylindrical objects, thereby eliminating laborious and costly transfers. Either machine can be made part of your production line, cutting time and expense of marking components.



The MARKEM 13A—imprints the base of television and cathode ray tubes. It holds the tube completely immobile during the printing operation...uses sturdy rubber plates with quick-drying, heat-resistant inks.

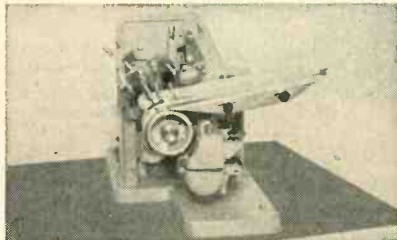

The MARKEM 20A—marks radio tubes, miniatures, resistors, capacitors, and other cylindrical objects clearly, durably with Markem rubber plates and quick-drying, heat-resistant inks.

Type changes can be made on either machine in seconds. Both make attractive, legible imprints and will not damage the most fragile surfaces. Write today, describing the components you are marking, and we'll send facts and costs about the machine best suited to your needs.

MARKEM machine company || Keene 27,
New Hampshire

**ALLIED
RCA**

world's largest distributor of



**ELECTRON TUBES
FOR INDUSTRY**

All types in stock

- Vacuum Power Tubes
- Thyratrons
- Vacuum & Gas Rect.
- Ignitrons
- Cold-Cathode Tubes
- Phototubes
- Oscillograph Tubes
- Camera Tubes
- Monoscopes
- Special Tubes

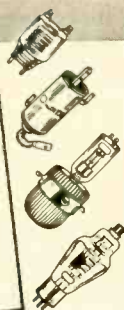

Quick, Expert Industrial Service

ALLIED maintains in stock for quick shipment the world's largest inventory of RCA special-purpose electron tubes—of all types. We specialize in supplying the tube needs of industrial, broadcast, governmental and other users. Shipments are made from stock to any part of the nation within hours after we receive your order. Save time, effort and money—fill all your tube needs from a single, dependable source.

FREE

**Interchangeability
Directory**

Valuable guide to selection of proper RCA tube type replacements. Lists 1600 type designations, covering non-receiving electron tubes. Write for your FREE copy of RCA Guide No. 37-046.

REFER TO YOUR ALLIED CATALOG

Make ALLIED your central supply source for all electronic supplies—parts, tubes, test instruments, tools, audio amplifiers, accessories—available for all your needs from the world's largest stocks. Order from your ALLIED Catalog—the leading Electronic Buying Guide.

ALLIED RADIO

833 W. Jackson • Chicago 7, Ill.



**Send for FREE
1951 CATALOG**

Everything in Electronics from ONE Source

**Want to know
about the...**

AUGETRON

ECCLES-JORDAN CIRCUIT

KATHETRON TUBE

MEKAPION TUBE

PERMATRON

PETOSCOPE

SCHLIEREN METHOD

SCOPHONY

SEMAGRAPH

SIRUFER

SYNDEC

THEREMIN

TRATONIUM

VODER

**or other early
electronic
developments?**

You can find out about
them in the early issues
of **ELECTRONICS**.

The cumulative index to
ELECTRONICS' first decade,
pages C-1 to C-36
in this book, tells you
where to look.

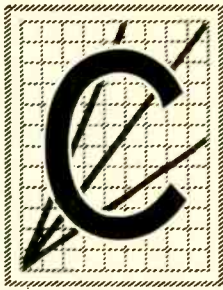

TRADE MARK

CALIDYNE VIBRATION TEST EQUIPMENT

for testing to
Air Force, JAN, MIL, and
other environmental test
specifications

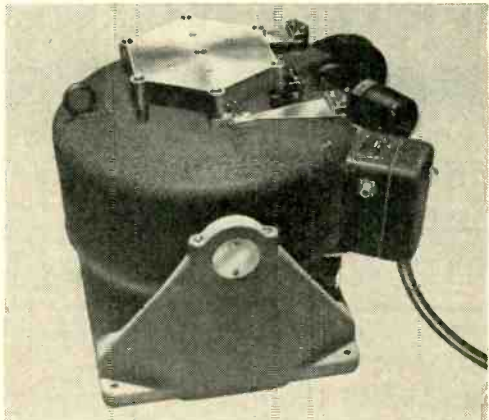

Model	Force rating	Maximum acceleration	Load for 20g (Pounds)	Load for 10g (Pounds)	Frequency range std. supply, cps	Signal generator
6	25	38.0	1/2	1-7/8	2 or 7 to 70,000	none
6C	25	34.5	1/2	1-7/8	2 or 7 to 70,000	velocity
6T	50	43.5	1-1/3	4-7/8	2 or 7 to 70,000	none
6CT	50	41.5	1-1/4	4-7/8	2 or 7 to 70,000	velocity
46	15	23.0	1/10	7/8	2 or 7 to 70,000	acceleration
49	25	34.5	1/2	1-7/8	2 or 7 to 70,000	velocity
44	450	54.5	14	36-3/4	2 to 500 or 2000	velocity (op.)
48	2500	38.0	50	185	3 to 500	velocity

Contact our representatives or consult our engineers regarding special requirements for cycling, monitoring, or controlling these shakers. We specialize in equipment for vibration testing, and offer many standard and special instruments for measuring, calibrating, and standardizing.



PICKUPS

Special pickups in ranges from 1g to 100g, and natural frequencies up to 1700 cps. Water-tight and pressure-tight cases available.

Model	g-range	Minimum natural frequency	Sensitivity volts/g
18B-5	5	110	3.0
18B-10	10	150	1.5
18B-25	25	250	0.6
18B-50	50	380	0.3

COUPLERS

Couplers for using pickups with recording oscillographs or cathode-ray oscilloscopes are available for single- or multi-channel use.

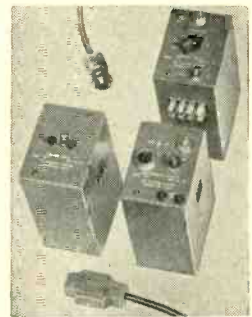

STANDARDS

Model 3 and Model 23
Calivolters

—for voltage standardization of amplifiers and monitors. A precise working standard which can be readily checked against primary laboratory standards.



CALIBRATORS

Model 1 and Model 6C
Calibrators

—for calibrating accelerometers and velocity pickups respectively, by use of a rapid and accurate ratio method. Bulletin on request.



METERS

Model 38 Vibroscope

Uses direct-coupled Model 18B pickup as input to combination vibration meter and calibrated oscilloscope for measuring acceleration, velocity, or displacement, and giving frequency and wave form indication.



Model 5 Vibration Meter

Direct-reading in acceleration, velocity, or displacement units when using velocity type pickups. A very compact, battery-operated unit.

Model 54 Signal Monitor

AC-operated unit for direct measurement of displacement or g output of shakers having velocity signal generators:



SALES REPRESENTATIVES IN

NEW YORK, N. Y.
G. C. Engel • Rector 2-0091

CHICAGO, ILLINOIS
H. W. Marsland • Andover 3-4984

FLORIDA
A. H. Lynch and Associates
Fort Meyers 5-6762

WASHINGTON, D. C.
F. R. Jordan • Union 8966
Republic 1635

PHILADELPHIA, PENNA.
D. J. Connor Co. • Locust 4-2870

DALLAS, TEXAS
J. A. Green Co. • Dixon 9918

THE
CALIDYNE
COMPANY

751 MAIN STREET WINCHESTER, MASSACHUSETTS

MINNEAPOLIS, MINN.
H. M. Richardson and Co. • Geneva 4078

HOLLYWOOD, CAL.
G. B. Miller Co. • Hollywood 9-6305

CLEVELAND, OHIO
M. P. Odell Co. • Prospect 1-6171

PORTLAND, OREGON
J. L. Kearns • East 4331

BARRYMOUNTS

ISOLATORS TO PROTECT
ELECTRONIC EQUIPMENT FROM

SHOCK and VIBRATION

FOR AIRCRAFT SERVICE

... under severe environmental conditions ... ALL-METL Unit Isolators Type 6600

LOAD RANGE pounds	MTG. CTRS. inches	HT. (no load) inches	WEIGHT ounces
2-35	1-15/16 × 1-15/16	1-9/16 ± 3/64	5



For complete load ratings see page 3, Catalog 509

ADVANTAGES

- ALL-METL construction
- Superior vibration isolation
- Good shock absorption
- Operation at extreme high and low temperatures
- Structural materials not subject to deterioration

CHARACTERISTICS

- Natural frequency — approximately 7½ cycles per second; low horizontal stiffness to give maximum isolation of horizontal vibration
- Transmissibility at resonance — 4½
- Meets the vibration requirements of specifications JAN-C-172A, MIL-E-5272 (USAF) and MIL-T-5422 (BuAer); may be used on equipment required to meet AN-E-19
- No snubber contact nor resonance carry-over when vibrated at government-specified amplitudes.

... for general aircraft service ... Air-damped Unit Isolators

LOAD RANGE pounds	MTG. CTRS. inches	HT. Max. Load inches	WEIGHT ounces	TYPE
2-35	1-15/16 × 1-15/16	1- 7/16	2¼	780
		1-19/32	2¼	896
1/4-9	1¾ × 1¾	1-9/32	1	770
		1-5/32	1	980
		1	1-1/16	860

For complete load ratings, see pages 4 and 5, Catalog 502

... with miniaturized apparatus ... Air-damped Unit Isolators

LOAD RANGE pounds	MTG. CTRS. inches	HT. Max. Load inches	WEIGHT ounces	TYPE
0.2-3.0	1-13/32 (2-hole)	1-1/32	5/16	6465
	1 × 1 (4-hole)	1-1/32	5/16	6690
	1-13/32 (2-hole)	1	5/16	6475
	1 × 1 (4-hole)	1	5/16	6695

For complete load ratings, see data sheets 605 and 606

ADVANTAGES

- Superior vibration isolation
- Low permanent set and drift
- Operation over wide temperature range
- Wide load range with uniform performance
- Excellent shock absorption
- Minimum side sway
- Low cost.

CHARACTERISTICS

- Vertical resonance — 7 to 9 cycles per second
- Vibration isolation well within U.S. government specified requirements
- No snubber contact nor resonance carry-over when vibrated at government-specified amplitudes
- Maximum amplification at resonance — 3.5
- Meets temperature requirements of JAN-C-172A (-67F to +170F)

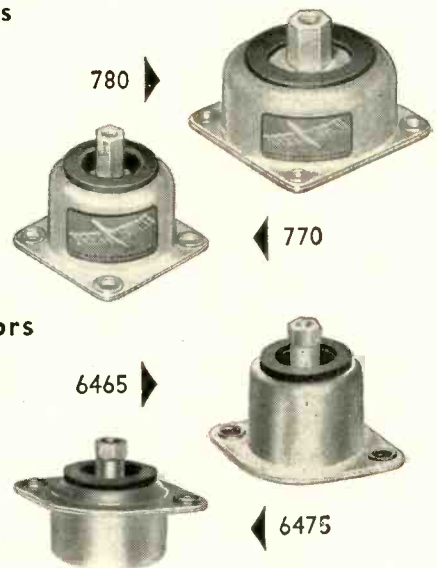

MOUNTING BASES



Mounting bases to meet dimensional and material specifications of JAN-C-172A, and the performance requirements of military applications, can be furnished with ALL-METL Barrymounts or with standard or miniaturized air-damped Barrymounts.

For complete data, see Catalogs 502 and 509



FOR INSTRUMENT SERVICE

General-purpose isolators . . . Type 990

LOAD RANGE pounds	MOUNTING CENTERS inches	LOADED HT. inches
2-30	1-15/16×1-15/16	1-13/32

For complete load ratings, see page 8, Catalog 504-A

APPLICATIONS . . . Particularly suited to protecting laboratory and industrial instruments.

Balloon-type isolators for very light loads . . .

Types 275, 302, 371, 372

For mounting sensitive vacuum tubes, radio sub-chassis, aircraft instruments, small motors, recorders, and record-changer turn-table assemblies. — 1/8 to 3 pounds.

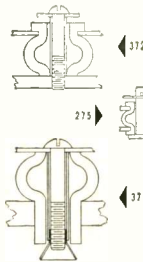
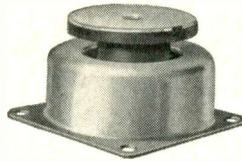

SHIPBOARD, RAILWAY, MOBILE SERVICE

Cup type . . . Types 1000-4000

TYPE	LOAD RANGE pounds	MTG. CTRS. inches	LOADED HT. inches
1000	7-100	1-15/16×1-15/16	1 1/8
2000	14-360	2 1/2×2 1/2	1 1/2
3000	150-1800	5 5/8×5 5/8	3-9/16
4000	70-900	4 1/4×4 1/4*	2 1/2

*Also 2-hole mtg. on 6" centers.

For complete ratings, see pages 6 and 7, Catalog 504-A

APPLICATIONS . . . For absorbing high impact shocks. Used with mobile and railway electric and electronic equipment.

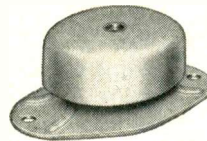
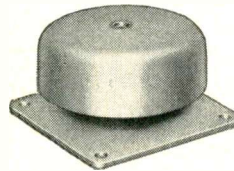

FOR INDUSTRIAL SERVICE

Plate type ... Type 5200	LOAD RANGE pounds	MOUNTING CENTERS inches
	3-48	1 3/8×1 3/8

For complete load ratings, see page 7, Catalog 504-A

APPLICATIONS . . . for impact absorption, with concurrent vibration isolation and general sound isolation.

Miniature industrial vibration isolator **Miniature industrial shock isolator . . .**
Type 6300 Type 6550

LD. RANGE pounds	MTG. CTRS. inches
1-11	1.414



LD. RANGE pounds	MTG. CTRS. inches
1-4 1/2	1.414

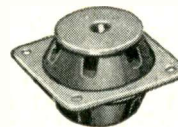

Other industrial mountings available for use with punch presses, grinders, millers, printing presses, and other machinery requiring good isolation and maximum shock absorption.

Write for data sheets giving complete load ratings

**FOR YOUR
UNUSUAL
PROBLEMS**

you'll find help available through our field engineering department. Just tell us in detail what your problem is. Our engineers can then determine what is needed to isolate vibration or absorb shock and they'll recommend the correct isolators for your use. There's no charge for this service to users of Barrymounts. Write to our main office — or telephone Watertown 3-1150.

SALES REPRESENTATIVES

CHICAGO

Bauman & Bluzat
2753 West North Ave.
Chicago 47, Illinois

ST. LOUIS

Harris-Hanson Company
208 North 22nd Street
St. Louis 3, Missouri

WASHINGTON

E. R. Hitchcock
903 Crescent Drive
Alexandria, Virginia

DAYTON

Jay Engineering Co.
1517 East Third St.
Dayton 3, Ohio

SEATTLE

Ron Merritt
217 Ninth Avenue North
Seattle 9, Washington

CALIFORNIA

E. V. Roberts & Associates
5068 W. Washington Blvd.
Los Angeles, California

TEXAS

Campion Sales Company
P. O. Box 4116, Station A
Dallas 8, Texas

NEW YORK

Jesse Markowitz
Queens Blvd. at 66th Ave.
Forest Hills, L. I., N. Y.

DETROIT

S. Sterling Company
13331 Linwood Avenue
Detroit 6, Michigan

ROCHESTER

Arthur C. Hansen
P. O. Box 271
Lakeville, Connecticut

CLEVELAND

Jay Engineering Co.
5413 Pearl Rd.
Cleveland 29, Ohio

PHILADELPHIA

Kenneth Randall
121 North Broad Street
Philadelphia 7, Penn.

NEW ENGLAND

Albert A. Schaal, Jr.
Great Road
Stowe, Massachusetts

MINNEAPOLIS

Fred B. Hill
256 First Avenue North
Minneapolis 1, Minnesota

ATLANTA

Henry W. Burwell Co
1133 Ponce DeLeon Ave., N.E.
Atlanta 6, Georgia

CANADA

Samuel C. Hooker
313 Montreal Trust Bldg.
67 Yonge Street
Toronto, Canada

THE **BARRY** CORP.

711 PLEASANT ST.
WATERTOWN 72, MASS.

HELDOR MIL-T-27 CANS

ARE STOCK ITEMS—

- NO DIE COSTS
- NO TOOLING
- FAST DELIVERY

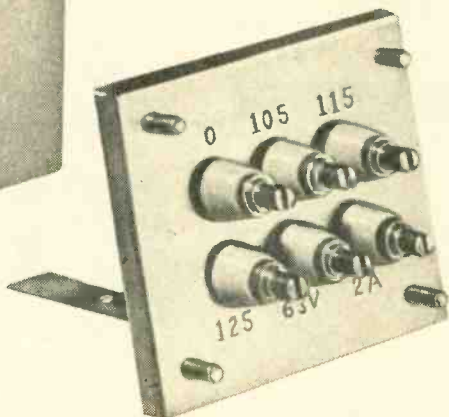
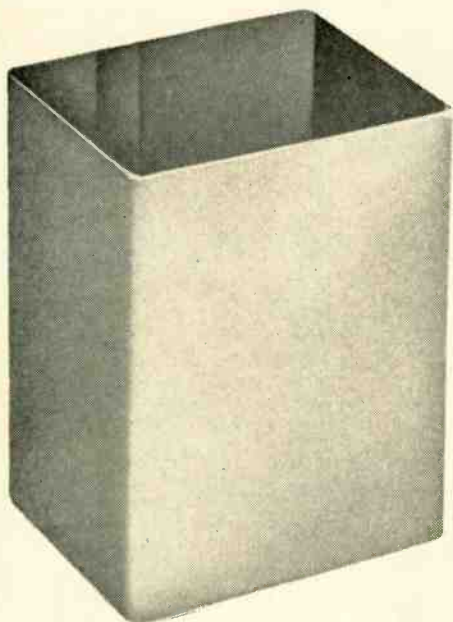

Now you can save die and tooling costs — and get fast delivery — when you specify MIL-T-27 cans from Heldor! These transformer cans are available in all standard sizes and can be supplied with or without brackets, weld studs, centrifugal hot tinned, blind inserts, compression-type hermetic bushings on $\frac{3}{8}$ ", $\frac{1}{2}$ ", $\frac{5}{8}$ ", $\frac{3}{4}$ " centers, and stamped ratings.

Custom sizes of these cans can also be supplied.

Write for specification, data and price bulletin.



HELDOR BUSHINGS

FOR POSITIVE HERMETIC SEALING

These steatite-insulator bushings resist thermal and physical shock . . . high dielectric strength. They are assembled with a new silicone type gland material or a newly developed, improved, Neoprene which meet government specifications and give exceptional results. They are easy to install and make for improved hermetic sealing.

Helder Bushings are regularly supplied in a choice of 10 styles and 28 types with a choice of 5 different stud types.

Ask for the new Helder *Bushing Bulletin!*

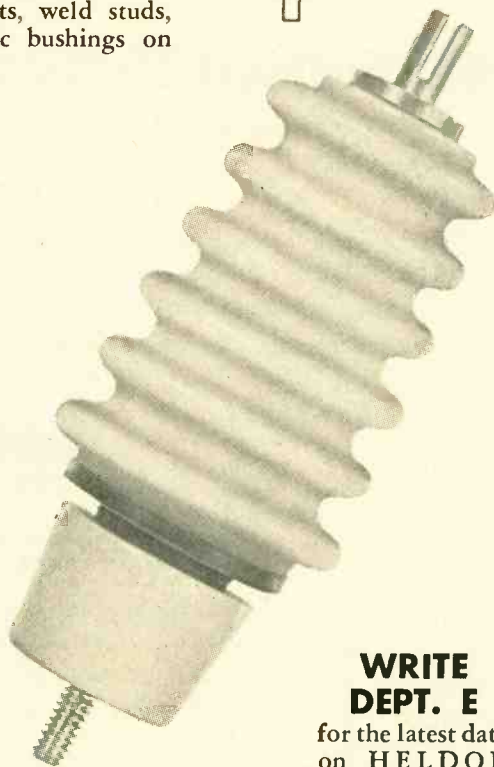

**WRITE
DEPT. E**

for the latest data
on HELDOR
MIL-T-27 CANS
and HELDOR
BUSHINGS.

LIC. UNDER RAYTHEON MFG. CORP.,
U. S. PAT. No. 2,447,489 —
CANADIAN PAT. No. 435,516



HELDOR MANUFACTURING COMPANY
Division of HELDOR BUSHING & TERMINAL CO., INC.
225 Belleville Avenue • Bloomfield, N. J.

dependable Electronic measurements

FOR LABORATORY—PRODUCTION TESTING—MAINTENANCE

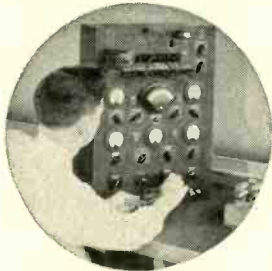

MUTUAL CONDUCTANCE TUBE ANALYZER

(Model 686 Type 9B) A complete "all purpose" tube analyzer that provides accurate testing of true mutual conductance of all receiving tubes in accordance with manufacturers rated operating conditions, as well as at other values not conforming to standard ratings and conditions. Ideal for electronic laboratories, and production quality control.



ULTRA SENSITIVE PORTABLE TEST INSTRUMENTS

(Model 622) High sensitivity, large scale A-C and D-C instruments of double pivoted type, ideal for precision measurement of low potentials and minute current. Available in single or multi range as D-C voltmeters, millivoltmeters, milliammeters, microammeters; and milliammeters and voltmeters in thermo and rectifier types for RF and A-C.



SUPER-SENSITIVE SENSITROL® RELAYS

(Model 705) Operate reliably on values as low as 1/2 microampere, direct from photocells, resistance bulbs, thermocouples and other generators of minute energy. Control up to ten watts at 120 volts on non-chattering magnetic contacts. No standby power required, no batteries, tubes, transformers. Available in single and double contact types—manual or solenoid reset.



HIGH FREQUENCY ELECTRONIC ANALYZER

(Model 769) A three-in-one instrument providing a self-contained Volt-Ohm-Milliammeter, a high impedance electronic D-C Volt-Ohmmeter, and a probe type vacuum tube voltmeter for use to 300 megacycles. Exceptionally stable and accurate. Has specially designed extremely small RF and D-C probes.



PANEL INSTRUMENTS OF HIGH SENSITIVITY

In all types, sizes and ranges for all critical measurements encountered in electronics, nuclear research and general testing. All D-C, rectifier type A-C and RF instruments have built-in magnetic shunts for minor adjustments if necessary.



INDUCTRONIC® D-C AMPLIFIER

(Model 1411) A new, stable D-C Amplifier which employs new Induction galvanometer and provides high degree of resolution even at fractional loads. Reaches steady, full-scale deflection in a fraction of a second. Interchangeable plug-in range standards for either microamperes or millivolts. Uses standard tube components.

Literature on these and other WESTON instruments for electrical and electronic requirements sent on request.
WESTON Electrical Instrument Corporation, 595 Frelinghuysen Avenue, Newark 5, New Jersey
... manufacturers of Weston and TAGliabue instruments.

WESTON Instruments

FAIRCHILD precision potentiometers

Expertly designed and built with extreme mechanical precision to meet individual specifications, Fairchild Precision Potentiometers offer:

COMPACTNESS • LONG LIFE • SUSTAINED ACCURACY • LOW NOISE LEVEL • HIGH RESOLUTION • MULTIPLE GANGING

Unique Facilities for Unsurpassed Precision

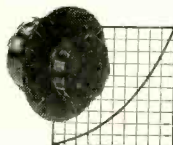

The outstanding performance of Fairchild Precision Potentiometers is the result of careful design and scrupulous attention to every phase of manufacture from the selection of materials to the precision machining of mechanical components.

Precision windings are custom-made by an exclusive technique on machines built expressly for the purpose. Wiper arm contacts are made of precious metal alloys. Mechanical parts are machined to extremely close tolerances. For example, diameters of shafts and pilot bushings are held to a tolerance of $\pm .0000$, $-.0005$ inch, and radial shaft play is held to a maximum of $.0005$ inch or better at full indicator reading. Taps are accurately located to within $\pm 1^\circ$, and in some cases to $\pm 0.5^\circ$.

Since performance requirements vary with each individual application, complete standardization of units is impossible. For this reason the facilities of the Fairchild Potentiometer Sample Laboratory and the services of its specially trained personnel are available for analyzing customers' application problems.

Described on this page are four basic designs now available with linear or non-linear windings tailored to meet the individual requirements of virtually any application.



FAIRCHILD TYPE 746 PRECISION POTENTIOMETER

This new unit offers a number of unusual features never before available to precision potentiometer users. It has low torque, a new, more accurate phasing adjustment, and a new method of stacking that permits ganging up to 20 cups on a shaft. Individual cups in a gang are easily replaced where necessary. Supplied with linear or non-linear windings to meet your specifications.

SPECIFICATIONS (Nominal Values)

Resistance—Linear, 100,000 ohms max.; non-linear, as specified
 Electrical Function Angle— $310^\circ \pm 1^\circ$ max.
 Electrical Contact Angle— 325° max.
 Mechanical Rotation—continuous
 Functional Tolerance (guaranteed)— $\pm 0.5\%$ (linear), $\pm 1.0\%$ (non-linear)
 Mechanical Accuracy—concentricity (shaft to pilot bushing)—.001 in. FIR max.; radial shaft play—.0009 in. FIR max.; shaft—centerless ground to .2500 diam. ($+.0000$, $-.0005$ in.) pilot hub—machined to .5000 ($+.0000$, $-.0005$ in.)
 Torque—1.5 oz.-in. per cup
 Wattage (rated at $+40^\circ$ C ambient temperature)—2.5
 Terminal Voltage—400 max.
 Voltage Breakdown at sea level (60 cycles)—900 RMS
 Taps—One per cup*; location accurate to $\pm 1^\circ$; $\pm 0.75^\circ$ max. width
 Operating Ambient Temp. Range— -55° C to $+71^\circ$ C
 Guaranteed Service Life (Nichrome Wire)—1,000,000 cycles
 Dimensions—diam. 1.750; length (1 cup) .800 in. $\pm .009$ in.; added length per unit ganged, .580 in. $\pm .002$ in.
 Case—grey anodized aluminum for greater accuracy
 *Two taps can be provided by slight design modification using terminal board clamp screw modified for wiper terminal; 19 taps can be provided by addition of dummy cup section.

FAIRCHILD TYPES 747 AND 748 PRECISION LINEAR POTENTIOMETERS



The Type 748 is a linear potentiometer with a guaranteed functional tolerance of $\pm 0.10\%$! The Type 747, similar in nearly all respects except size, has a guaranteed functional accuracy of $\pm 0.15\%$. Type 747 has a nominal diameter of about

2 inches, while the 748 is about 3 inches in diameter. Flexibility of these units permits their combination with other units having non-linear windings to meet special application problems.

SPECIFICATIONS (Nominal Values)

Resistance—747, 75,000 ohms max.; 748, 125,000 ohms max.
 Electrical Function Angle—747, $351.3^\circ \pm 1^\circ$; 748, $354.5^\circ \pm 1^\circ$
 Electrical Contact Angle—747, $351.3^\circ +4^\circ, -0^\circ$; 748, $354.5^\circ +4^\circ, -0^\circ$
 Mechanical Rotation—continuous
 Functional Tolerances (guaranteed)—748, $\pm 0.15\%$; 747, $\pm 0.10\%$
 Mechanical Accuracy—concentricity (shaft to pilot bushing)—.0025 in. FIR max.; radial shaft play—.0015 in. FIR max.; shaft—centerless ground stainless steel to .2500 diam. ($+.0000$, $-.0005$ in.); pilot hub—machined to .7500 ($+.0000$, $-.0005$ in.)
 Torque—1.0 oz.-in. per cup
 Wattage (rated at $+40^\circ$ C ambient temperature)—747, 4 watts; 748, 5 watts
 Terminal Voltage—400 max.
 Voltage Breakdown at sea level (60 cycles)—900 RMS
 Taps—747, 12 per cup*; 748, 16 per cup*; location accurate to $\pm 1^\circ$; $\pm 5^\circ$ max. width
 Operating Ambient Temp. Range— -55° C to $+71^\circ$ C
 Guaranteed Service Life (Nichrome Wire)—1,000,000 cycles
 Dimensions—diam., 747, 2.093 in.; 748, 3.093 in.; length (1 cup) 1.156 max.; added length per unit when ganged, .594 in.
 *Depends on spacing requirements. Without moving bridge or wiper terminal.

SPECIFICATIONS (Nominal Values)

Resistance—125,000 ohms, max.
 Electrical Function Angle— $354.5^\circ \pm 1^\circ$
 Electrical Contact Angle— $354.5^\circ +4^\circ, -0^\circ$
 Mechanical Rotation—continuous
 Functional Tolerance (guaranteed)— $\pm 0.10\%$
 Mechanical Accuracy—concentricity (shaft to pilot bushing)—.0025 in. FIR max.; radial shaft play—.0015 in. FIR max.; shaft—centerless ground stainless steel to .2500 diam. ($+.0000$, $-.0005$ in.); pilot hub—machined to .7500 ($+.0000$, $-.0005$ in.)
 Torque—1.0 oz.-in. per cup
 Wattage (rated at $+40^\circ$ C ambient temperature)—5 watts
 Terminal Voltage—400 max.
 Voltage Breakdown at sea level (60 cycles)—900 RMS
 Taps—number per cup* (see note); location accurate to $\pm 1^\circ$; $\pm 5^\circ$ max. width
 Operating Ambient Temp. Range— -55° C to 71° C
 Guaranteed Service Life (Nichrome wire)—1,000,000 cycles
 Dimensions—diam. 3.093 in., length 1.219 max.

*No slip rings provided for taps, but 16 taps can be provided within the cup depending on spacing requirements and without moving bridge or wiper terminal.

FAIRCHILD D-C-P*

*Differential Computing Potentiometer

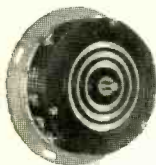

The Fairchild Differential Computing Potentiometer is virtually two precision linear potentiometers in one. With it, you can combine two input variables and obtain an

output that is proportional to their sum or difference. Instead of using terminal lugs, the D-C-P provides for external connections to winding ends and wiper by means of three coin-silver slip rings to permit continuous rotation of body as well as shaft.

WRITE TODAY FOR COMPLETE INFORMATION

FAIRCHILD oscilloscope cameras

For Permanent Oscilloscope Records—on the spot!

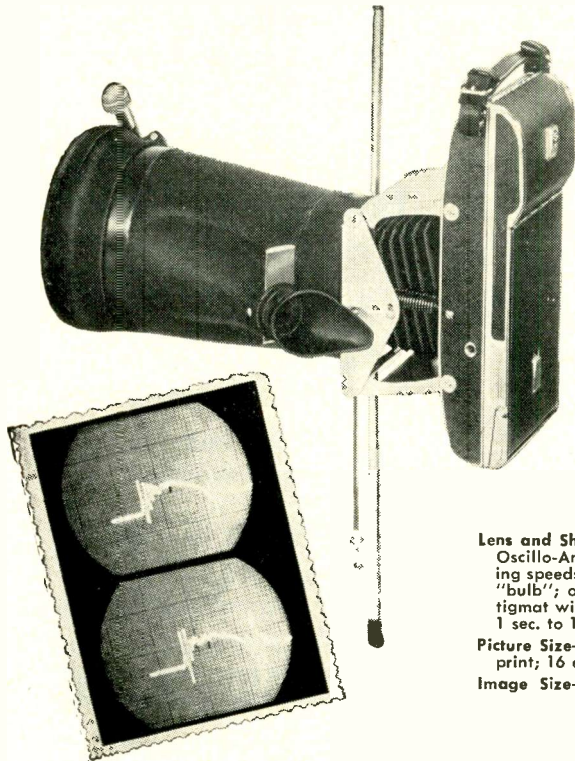

THE FAIRCHILD-POLAROID® OSCILLOSCOPE CAMERA PRODUCES A PHOTOGRAPHIC PRINT IN ONE MINUTE

When you need Oscilloscope records in a hurry, you can't beat this new camera. It's a special Fairchild adaptation of the Polaroid-Land principle of "a photographic print in one minute." Because these prints are immediately available to the engineer, lab work can proceed continuously without the interruptions or long waiting periods required with conventional methods.

For the first time, the camera makes it economically practical to record many traces that were formally sketched or carried in the engineer's memory. No focusing or special training is required—just snap the shutter, pull down a paper tab, and remove the finished print 60 seconds later. Each 2 1/4 x 3 1/4 print records two traces at exactly one-half life size for easy comparison and measurement.

SPECIFICATIONS

Lens and Shutter—Choice of 75mm f2.8 Wollensak Oscillo-Anastigmat with #2 Alphax shutter having speeds of 1/25 sec. to 1/100 sec., "time" and "bulb"; or, 75mm f1.9 Wollensak Oscillo-Anastigmat with #3 Alphax shutter having speeds of 1 sec. to 1/100 sec., "time" and "bulb".

Picture Size—3 1/4 x 4 1/4 in. (2 or more images per print; 16 exposures per roll of film.)

Image Size—One-half reduction of scope image.

Writing Speed—With f2.8 lens, up to 1 in./μsec at only 3000V accelerating potential; higher speeds at higher voltages. With f1.9 lens these values are approximately doubled.

Dimensions—Camera, 10 1/2 x 5 1/4 x 6 1/4 in.; hood, 11 in. length, 7 1/2 in. dia.; adapter, 2 in. width, 6 7/8 in. max. dia.

Weight—Complete, 7 3/4 lb.

For both still and continuous-motion Oscilloscope Recording on 35-mm film or paper THE FAIRCHILD OSCILLO-RECORD CAMERA

The Fairchild Oscillo-Record Camera is the first specifically designed for the purpose of recording cathode-ray oscilloscope images. The unit is designed for both still and continuous motion photography on standard 35 mm film. No special experience is necessary to set up the equipment.

Dynamic braking stops film instantly when switch is turned off. Remote control connection provides automatic means of monitoring random transients without necessity of having camera run continuously.

Other features: Written data record, film speed continuously variable from 1 to 3,600 in./min., remote control provision, protective interlock.

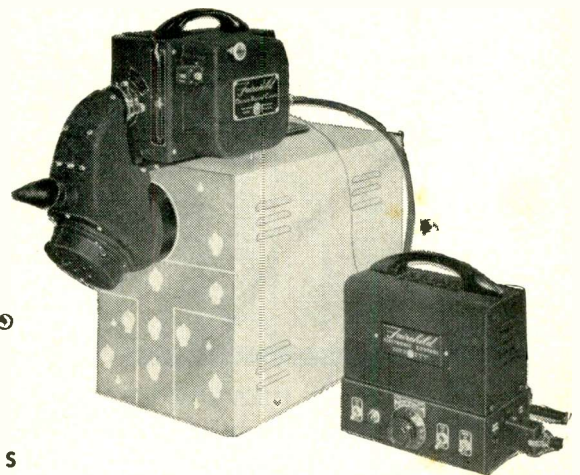

SPECIFICATIONS

Assembly—Consists of: (a) camera; (b) electronic film speed control unit; (c) periscope cone; (d) standard mount; (e) data card unit; (f) cables. Lens—50mm f/2.8 Wollensak Velostigmat; 50mm f1.5 Wollensak (optional at extra cost).

Shutter—Wollensak #2 Rapax Between-the-Lens Shutter; speeds from 1 second to 1/200th second. (Wollensak #3 shutter supplied with f1.5 lens; speeds from 1 second to 1/400 second.)

Film Size—Any standard 35mm motion picture negative film; or recording paper.

Film Capacity and Negative Size—(a) Standard 100-foot roll; (b) External Magazines (optional at extra cost)—400-ft. or 1000-ft. When single exposures are made on stationary film, negative

size is .953" high x .937" wide. However, film may be advanced from 1/4 of a standard 35mm frame height to the full advance of a double 35mm frame (5 to 39mm).

Data Record—Illuminated data card on which any data may be written is provided. Data may be recorded photographically at the beginning or end of each run.

Electronic Control Unit—Provides direct film speed settings over a range of 1 to 3,600 in./min.

Remote Control—Connector is provided for remote control of film-drive motor.

Spacing Bars—Permanently attached to oscilloscope for quick and easy attachment or removal of complete camera and mount assembly.

Approximate Weight—Camera, 15 lbs.; Electronic Control, 10 1/4 lbs.; Periscope and Mount Assembly, 7 3/4 lbs.; Total, 33 lbs.

Approximate Dimensions—Camera, 9 1/8 x 11 1/2 x 7 1/2 in.; Electronic Control, 9 1/4 x 10 x 5 1/2 in.; Periscope and Mount Assembly, 21 1/2 x 11 3/8 x 5 1/2 in.

Film Speed—Continuously adjustable from 1 in. per min. to 3,600 in. per min. Film movement is continuous, not intermittent.

Interlock—Prevents starting motor when camera is set for single exposures; and vice versa.

Power Requirements—Approximately 135 watts of 110 volt, 60-cycle a.c. are required for the variable speed drive.

FAIRCHILD
CAMERA AND INSTRUMENT
CORPORATION

88-08 VAN WYCK BOULEVARD, JAMAICA 1, N. Y.

NEY



PRECIOUS METAL ALLOYS

For ELECTRICAL and ELECTRONIC APPLICATION

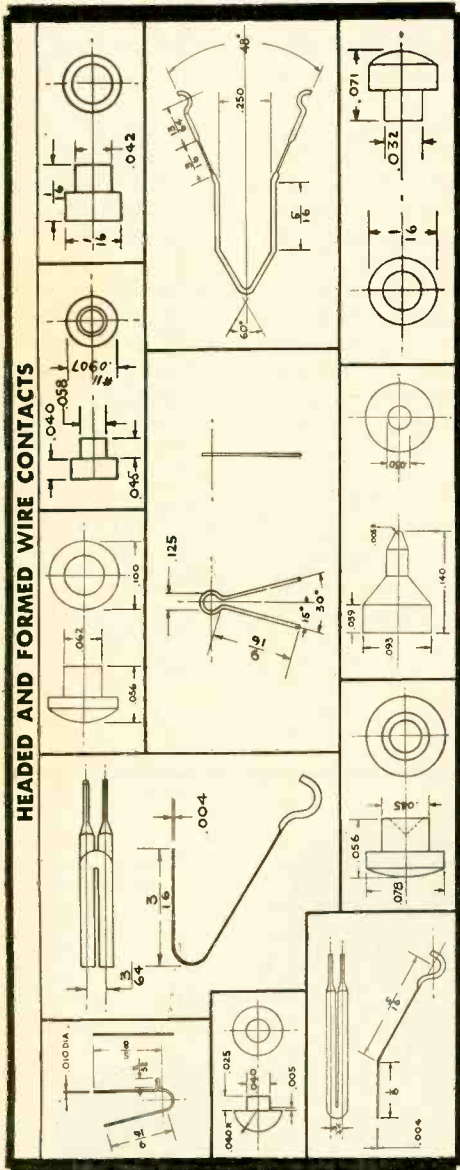

**TEST RESULTS INDICATE
LONGER LIFE AND
GREATLY IMPROVED
PERFORMANCE**

Shown below are typical test results of PALINEY* #7 . . . a typical Ney Precious Metal Alloy . . . being used for sliding contacts on nickel-chrome wire-wound potentiometers in comparison with phosphor bronze contacts. Figures show low initial error and maintained linearity typical of PALINEY* #7 performance. Condition of both contacts and windings after test indicated substantially reduced wear.

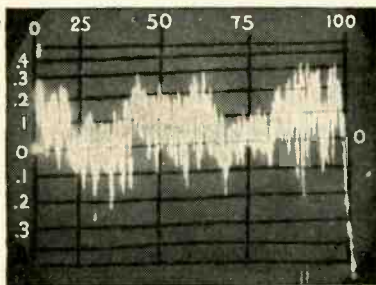

Cathode Ray Oscillograph showing percentage error of standard potentiometer after one million cycles or two million sweeps of phosphor bronze contact over the wire. Initial linearity was $\pm .17\%$ and the error increased to $\pm .28\%$ plus noise.

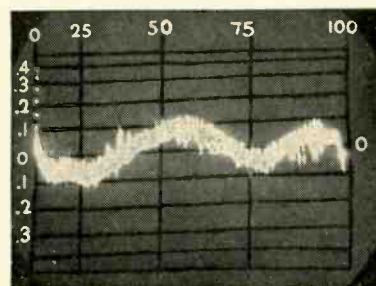

Performance of standard potentiometer modified by substitution of PALINEY* #7 contact after one million cycles or two million sweeps over wire. The initial error was reduced to $\pm .12\%$ and this linearity was maintained throughout the test.

* Reg. T.M. of J. M. Ney Co.

Exclusive



PATENT'S FINGER-GRIP STANDARD BAR KNOB

Patent Mold Guarantee



- Quality Molding
- Superior Service

Write for Samples and
Further Information

PATENT

BUTTON CO. OF TENNESSEE, Inc.
2005 Century St., Knoxville, Tenn.

Refer Stock No. C67

NOT...

until next year
will you get another

electronics BUYERS' GUIDE

Don't let it get away
from you.

It's the best source
of buying information
for electronic
and allied products
that has ever
been compiled.

When buying, or requesting product
information be sure to mention
ELECTRONICS BUYERS' GUIDE.

Standard NEY CONTACTS Simplify design problems

Chart shows form and overall dimensions of a few of the many types of contacts made from Ney Precious Metal Alloys for brush or wiping contact applications. Full technical and test data are available on request. Other Ney Precious Metal Alloys have solved many special industrial application problems. Consult us freely without obligation.

For complete data on Ney Precious Metals
Write for Bulletin R-12

The J. M. NEY COMPANY
179 ELM STREET • HARTFORD 1, CONNECTICUT
17NY49

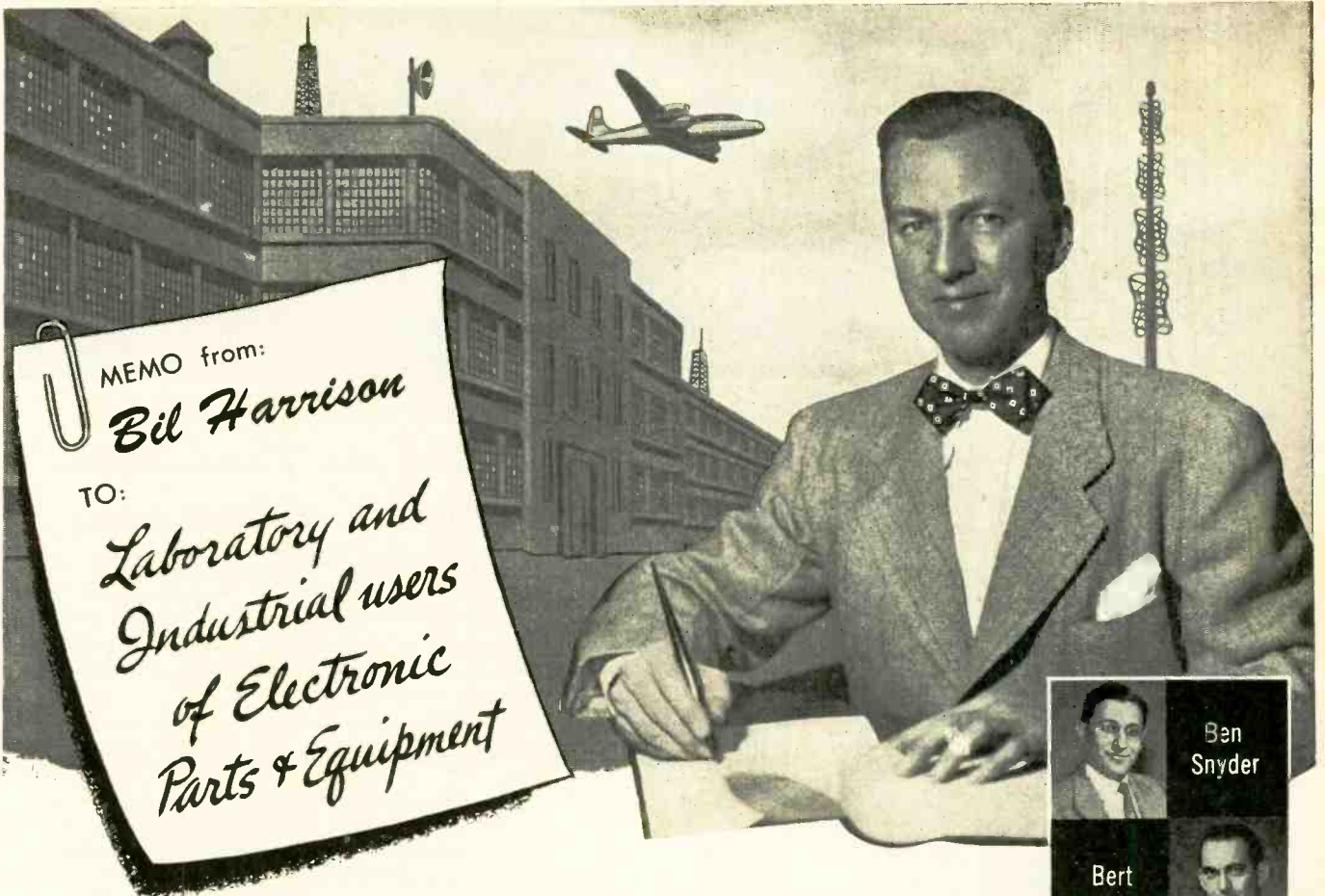

MEMO from:
Bil Harrison
 TO:
*Laboratory and
 Industrial users
 of Electronic
 Parts & Equipment*

*... Here's your single source for
 ALL your electronic materiel—if it's
 available anywhere... if it's of
 standard manufacture—HARRISON HAS IT!*

Small resistor or a complete broadcast installation... a single call insures prompt delivery. No more hunting for special parts or hard-to-get equipment. Let HARRISON'S Procurement Specialists save you precious time and money... help you speed up your development and production schedules. Call us on your next order to see for yourself.

New York Area Firms—Have you any purchasing problems? Just dial BA 7-7777—a member of our Industrial Department will be glad to call on you at your convenience. No obligation.

SINCE 1925 — ELECTRONIC PARTS AND EQUIPMENT DISTRIBUTORS

Cable Address — HARRISORAD



HARRISON RADIO CORPORATION

**225 GREENWICH ST. (10 West Broadway)
 NEW YORK 7, N. Y. • BARclay 7-7777**

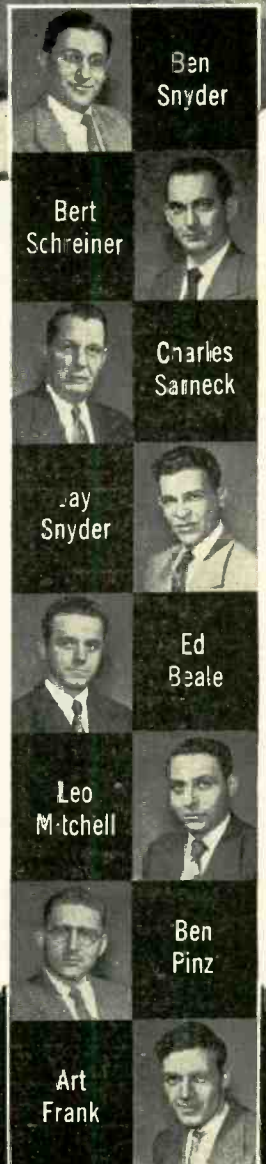

Ben Snyder

Bert Schreiner

Charles Sarneck

Jay Snyder

Ed Beale

Leo Mitchell

Ben Pinz

Art Frank

**TURBO****THE WM. BRAND AND CO., INC.**
WILLMANTIC, CONNECTICUT

Electrical • Electronic **INSULATING MATERIALS** **WIRE and WIRE MARKERS**

*Quality Products to Safeguard
Your Product Quality and Performance*

TURBO VARNISHED TUBING — All NEMA Grades

A cotton, rayon or glass braid impregnated with high quality insulating varnish. Recommended for general application requiring high tensile strength, flexibility, tear resistance, non-peeling and non-cracking qualities, low moisture absorption, oil and acid resistance. Radio Grade (NEMA B-1) and Magneto Grade (NEMA A-1) available from .022 I.D. Standard Lengths bundled as follows: No. 24 — No. 6½ mm., 500 ft.; No. 2 — No. 0, 250 ft.; 9 mm. to ¾" I.D., 100 ft.; ¾" and larger, 52½".

TURBO SATURATED SLEEVING — All NEMA Grades

Produced from select cotton, rayon or glass braid saturated with a specially formulated insulating varnish to assure desirable sealing properties with excellent flexibility. Recommended for low cost insulation where dielectric is not the major problem. Features absolute concentricity, high tensile strength, low moisture absorption and flexibility. Available from .022 I.D. standard lengths. Sizes 13 to 24 inclusive can be supplied in continuous lengths put up on spools. Stock colors up to size 12 include black, yellow, red, green, brown and blue. Black and yellow standard on larger sizes.

TURBOSIL GLASS TUBING

A flexible glass braid reinforced with superior silicone insulating varnishes and developed specifically for those applications demanding flexibility with high heat resistance and dielectric strength. Exceedingly popular for use with circuits in small space where optimum protection with least bulk is prime requisite. Provides maximum safeguard against low and high temperatures (−70°C. to +200°C.), moisture, oil and grease. Available in natural color from No. 20 to ¾" I.D., in 42" standard lengths in four grades: Single Saturated (NEMA H-C-3), Double Dip (NEMA H-C-2), Triple Strength (NEMA H-C-1) and Magneto Grade (NEMA H-A-1).

TURBO CAMBRICS, TAPES, CLOTHS, PAPERS

Broad line affords desired protection against voltage breakdown, oils, moistures and alkalis under the most severe operating conditions. All standard types, sizes, lengths and colors are available. TURBO line includes varnished cambric in sheets and rolls; varnished cambric tapes; dry and oil type splicing tapes; plastic backing tape; duplex cambric slot insulation; varnished duck; silicone varnished glass cloth; treated asbestos cloth; duplex glass slot insulation; extra thin varnished insulation of cambric, nylon, rayon and silk; and varnished papers. All tested in accordance with A.S.T.M. Specifications. Detailed data in TURBO Catalog. Write for samples.

THE WILLIAM BRAND AND COMPANY, INC.

Yours FOR THE ASKING -
complete product information and index of TURBO electrical insulating materials and wire plus helpful ordering information.

WRITE TODAY FOR YOUR COPY

SERVICE backed by quality products and experience of specialists is the keynote to the growing acceptance of TURBO products. The Brand research laboratories are continuously studying new materials, methods and machinery to improve standard products and introduce new products to keep step with increased demands placed on electricity. Whatever your insulation problem, look to The William Brand and Co., Inc. for study, recommendations, samples and SERVICE. Turbo-Technician in your territory will be happy to serve you.

TURBO EXTRUDED PLASTIC TUBING

Vinyl tubing for wide application wherever you require resistance to tear and abrasion, toughness, elasticity, flexibility for broad temperature range. Available in three classifications up to 1.5" I.D., 7 colors and clear in continuous lengths or cut to length. Samples on request.

HIGH HEAT: Turbofans 105 and Turbotherm 105 are U. L. approved for 105°C. uses. Turbofans is specially processed tubing of high quality used extensively for potting, baking, etc. Turbofans 105 is suitable at temperatures of -40°C.

LOW TEMPERATURE: Turbozone 47 is a non-corrosive tubing providing unusual flexibility at sub-zero temperatures. Specially compounded to meet AAF12047A requirements. Not recommended for oil use.

GENERAL PURPOSE: Turborex 63 meets JAN-1-631 requirements. Not recommended for high heat or oil use. Turborex 85 is recommended for service for moderate heat and occasional exposure to oil. Not recommended for temperature applications below -30°C.

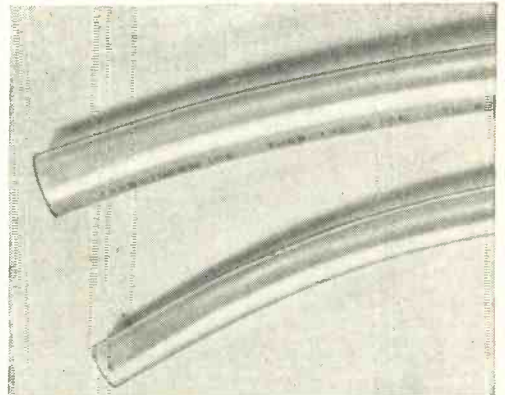

TURBO WIRE AND MULTI-CABLES

Multi-conductor cables up to maximum 3/8" O.D. Range of lays 1" to 10", right or left hand with fillers and cotton wraps if required. Can also pair conductors with range of lays 1/2" to 6". Manufactured to specifications.

TURBOTHERM 60: Radio and instrument hook-up wire. Approved for JAN-C-76-SR1R (1000 V.) and SRHY (2500 V.). Available with nylon jacket or lacquered glass braid in standard RMA colors. Nos. 16 to 24 solid or stranded.

TURBOTHERM 80: Radio, instrument and control hook-up wire. U. L. approved appliance wire for 80°C. - 300-600 V., with or without cotton, rayon or glass lacquered overbraid. Nos. 12 to 26 solid or stranded. Nos. 14, 16 and 18 stranded U. L. approved for 80°C. - 1000 V. Standard RMA colors. Available also as a thin-wall instrument wire. Meets Buships 15-W-9, Type LV. Nos. 22 to 28 in solid or stranded. Standard RMA colors.

TURBOTHERM 90: Radio, instrument and control hook-up and motor lead wire with or without lacquered braid. U. L. approved 90°C. - 600 V. Nos. 16 to 26 solid or stranded. Standard RMA colors.

TURBOTHERM 105: Motor lead and appliance wire. U. L. approved 105° C. - 600 V. Nos. 16 to 26 solid or stranded. Standard RMA colors.

TURBOTHERM 105: Hook-up and appliance wire with lacquered glass overbraid. U. L. approved 105°C. - 300 and 600 V. Nos. 16 to 26 solid or stranded. Standard RMA colors.

TURBOLENE PE: Low voltage (150 V.) loop antenna wire. Nos. 22 and 24, solid or stranded, with natural or brown insulation.

TURBOLENE NF: High voltage Appliance Wire. U. L. approved 10,000 and 20,000 V. Nos. 14 to 22 solid and stranded in natural white.

NEON SIGN CABLE GTO-15: U. L. approved 15,000 V. Nos. 12 and 14 stranded in natural color primary insulation with black jacket.

TURBO TWIN-LEAD TRANSMISSION LINE: Available in heavy duty outdoor and light weight indoor types. 300 ohm and 150 ohm Twin-lead are standard. Special combinations of conductor gage and web dimensions are available. Can be furnished with your imprint on the web.

Additional colors, contrasting color tracer stripes, other construction and special packaging on special request.



TURBO MICA PRODUCTS

Possessing ideal electrical properties, Mica is available in several grades and forms for every electrical need. TURBO Mica line includes: HEATER PLATE: can withstand direct contact with heat, 1000°F., 625 VPM. FLEXIBLE PLATE: soft mica bonded with non-hardening adhesive varnish can be bent or molded whether cold or warm. AMBER SEGMENT PLATE: soft edged for wearing down with copper commutator bars, 600 VPM. MOLDING PLATE: moldable at approximately 284°F., on flat sheets, 600 VPM up to .015" thickness, 450 VPM .015" and over. INDIA SEGMENT PLATE: distinguished from amber segment plate by increased hardness and higher thermal characteristics. B-H-1 and B-H-2 PLATE: built-up mica plate with high rigidity and good power factor suitable for condenser applications. BLOCK MICA to rigid specifications, all standard sizes. MICA FILMS for mica condensers.

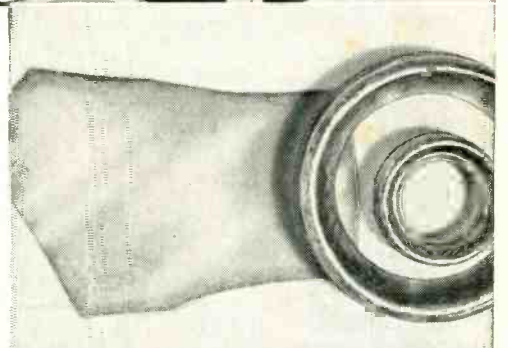

TURBO

WILLIMANTIC, CONN., U.S.A. TELEPHONE 3-1661

104 VALLEY STREET

TURBO IDENTIFICATION MARKERS

Slip-on identification sleeves in braided fabric or extruded plastic are available imprinted longitudinally or circumferentially in any diameter or length in any combination of colors. Dimensioned to precise limits to insure snug fit, these markers clearly identify electrical conductors, tubing, wiring, hose, cable, rod and similar connectors. Fadeproof, bleedproof and smearproof, TURBO Markers will last the life of any product.



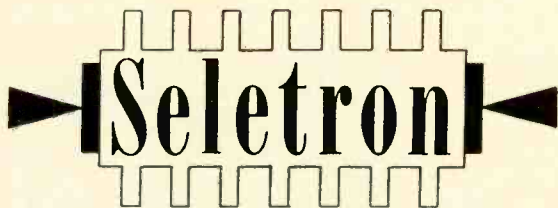

SELETRON RECTIFIERS

A PARTIAL LISTING OF RECTIFIER STACK TABULATIONS
TAKEN FROM THE LATEST SELETRON CATALOG

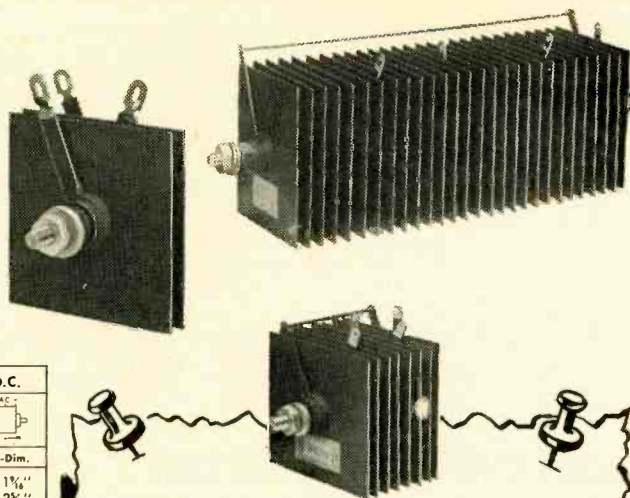

SINGLE PHASE BRIDGE		.15 Amps. D.C.		.22 Amps. D.C.		.30 Amps. D.C.		.45 Amps. D.C.	
Approx. D.C. Volts New	Max. A.C. Input	Code No.	B-Dim.	Code No.	B-Dim.	Code No.	B-Dim.	Code No.	B-Dim.
20	26	M1B1S1C	1 3/8"	M1B1S1C	1 3/8"	P1B1S1C	1 3/8"	P1B1S1C	1 3/8"
40	52	M2B1S1C	2 1/8"	M2B1S1C	2 1/8"	P2B1S1C	2 1/8"	P2B1S1C	2 1/8"
60	78	M3B1S1C	2 3/4"	WM3B1S1C	3 3/8"	P3B1S1C	3"	WP3B1S1C	3 3/8"
80	104	M4B1S1C	3 3/8"	WM4B1S1C	4 3/8"	P4B1S1C	3 3/8"	WP4B1S1C	4 3/8"
100	130	M5B1S1C	3 3/4"	WM5B1S1C	5"	P5B1S1C	4 3/8"	WP5B1S1C	5 7/8"

SINGLE PHASE BRIDGE		60 Amps. D.C.		.90 Amps. D.C.		1.0 Amps. D.C.		1.4 Amps. D.C.	
Approx. D.C. Volts New	Max. A.C. Input Volts	Code No.	B-Dim.	Code No.	B-Dim.	Code No.	B-Dim.	Code No.	B-Dim.
20	26	Q1B1S1C	1"	Q1B1S1C	1"	S1B1S1C	1 3/8"	S1B1S1C	1 3/8"
40	52	Q2B1S1C	2 3/8"	Q2B1S1C	2 3/8"	S2B1S1C	2 11/16"	S2B1S1C	2 11/16"
60	78	Q3B1S1C	3"	WQ3B1S1C	3 3/8"	S3B1S1C	3 1/2"	WS3B1S1C	4 3/8"
80	104	Q4B1S1C	3 3/8"	WQ4B1S1C	4 3/8"	S4B1S1C	4 3/8"	WS4B1S1C	5 1/2"
100	130	Q5B1S1C	4 1/8"	WQ5B1S1C	5 7/8"	S5B1S1C	5 3/16"	WS5B1S1C	6 3/8"

SINGLE PHASE BRIDGE		2.4 Amps. D.C.		3.2 Amps. D.C.		4.5 Amps. D.C.		6.0 Amps. D.C.	
Approx. D.C. Volts New	Max. A.C. Input Volts	Code No.	B-Dim.	Code No.	B-Dim.	Code No.	B-Dim.	Code No.	B-Dim.
20	26	U1B1S1C	2 5/8"	U1B1S1C	2 3/8"	W1B1S1C	2 5/8"	W1B1S1C	2 5/8"
40	52	U2B1S1C	3 13/16"	U2B1S1C	3 3/8"	W2B1S1C	3 3/8"	W2B1S1C	3 3/8"
60	78	U3B1S1C	5"	WU3B1S1C	6 7/8"	W3B1S1C	5"	WW3B1S1C	6 7/8"
80	104	U4B1S1C	6 3/8"	WU4B1S1C	8 1/8"	W4B1S1C	6 3/8"	WW4B1S1C	8 1/8"
100	130	U5B1S1C	7 3/8"	WU5B1S1C	9 13/16"	W5B1S1C	7 3/8"	WW5B1S1C	9 13/16"

SINGLE PHASE BRIDGE		6.7 Amps. D.C.		8.5 Amps. D.C.		8.0 Amps. D.C.		10 Amps. D.C.	
Approx. D.C. Volts New	Max. A.C. Input Volts	Code No.	B-Dim.	Code No.	B-Dim.	Code No.	B-Dim.	Code No.	B-Dim.
20	26	T1B1S1C	3"	T1B1S1C	3"	H1B1S1C	3"	H1B1S1C	3"
40	52	T2B1S1C	4 1/4"	T2B1S1C	4 1/4"	H2B1S1C	4 1/4"	H2B1S1C	4 1/4"
60	78	T3B1S1C	6 7/8"	WT3B1S1C	7 13/16"	H3B1S1C	6 7/8"	WH3B1S1C	7 13/16"
80	104	T4B1S1C	8 1/8"	WT4B1S1C	10 1/4"	H4B1S1C	8 1/8"	WH4B1S1C	10 1/4"
100	130	T5B1S1C	9 3/8"	WT5B1S1C	12 1/4"	H5B1S1C	9 3/8"	WH5B1S1C	12 1/4"

Listed above are full wave bridge rectifiers. Ratings are for continuous duty, resistive-inductive load, in an ambient temperature of 35°C.

For higher voltages and currents, other combinations are available. Send us specifications for other designs . . . Our engineers will be glad to aid you in the solution of your rectifier problems without obligation.

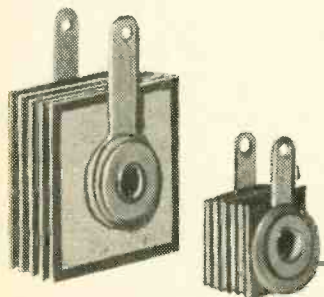

Seletron
MINIATURES FOR
RADIO, TV AND
OTHER ELECTRONIC
APPLICATIONS

For more complete listings write for Bulletin No. 104-BG

RR RADIO RECEPTOR COMPANY, INC. RR

Since 1922 in Radio and Electronics

MANUFACTURERS OF SELETRON SELENIUM RECTIFIERS • THERMATRON DIELECTRIC HEATING EQUIPMENT

Sales Dept.: 251 W. 19th St., New York 11, N. Y. • Factory: 84 N. 9th St., Brooklyn 11, N. Y.

Seletron Selenium Rectifiers are the choice of an increasing number of manufacturers in diversified fields because they are so thoroughly dependable under all types of grueling conditions . . . Available in the miniature sizes required for radio, TV and other electronic circuits, all the way up to heavy duty power stacks used in a wide range of industrial applications.

MODEL NO.	PLATE SIZE	STACK THICKNESS	MAX. INPUT VOLTAGE R. M. S.	MAX. PEAK INVERSE VOLTAGE	MAX. D.C. OUTPUT CURRENT
1M1	1" sq.	3/8"	25	75	100 MA
8Y1	1/2" sq.	9/16"	130	380	20 MA
16Y1	1/2" sq.	15/16"	260	760	20 MA
8J1	1 1/16" sq.	9/16"	130	380	65 MA
5M4	1" sq.	11/16"	130	380	75 MA
5M1	1" sq.	7/8"	130	380	100 MA
5P1	1-3/16" sq.	7/8"	130	380	150 MA
6P2	1-3/16" sq.	1-3/16"	156	456	150 MA
5R1	1 1/2" x 1 1/4"	7/8"	130	380	200 MA
5Q1	1 1/2" sq.	1 1/8"	130	380	250 MA
6Q1	1 1/2" sq.	1 1/8"	156	456	250 MA
6Q2	1 1/2" sq.	1 3/8"	156	456	250 MA
6Q4	1 1/2" sq.	1 3/4"	130	380	300 MA
5Q51	1 1/2" x 2"	1 1/8"	130	380	350 MA
6Q52	1 1/2" x 2"	1 1/4"	156	456	350 MA
5S1	2" sq.	1 1/8"	130	380	500 MA
6S2	2" sq.	1 3/8"	156	456	500 MA

as seen in National's
Research Laboratories,
raw materials and finished
products are constantly
checked for
performance standards.

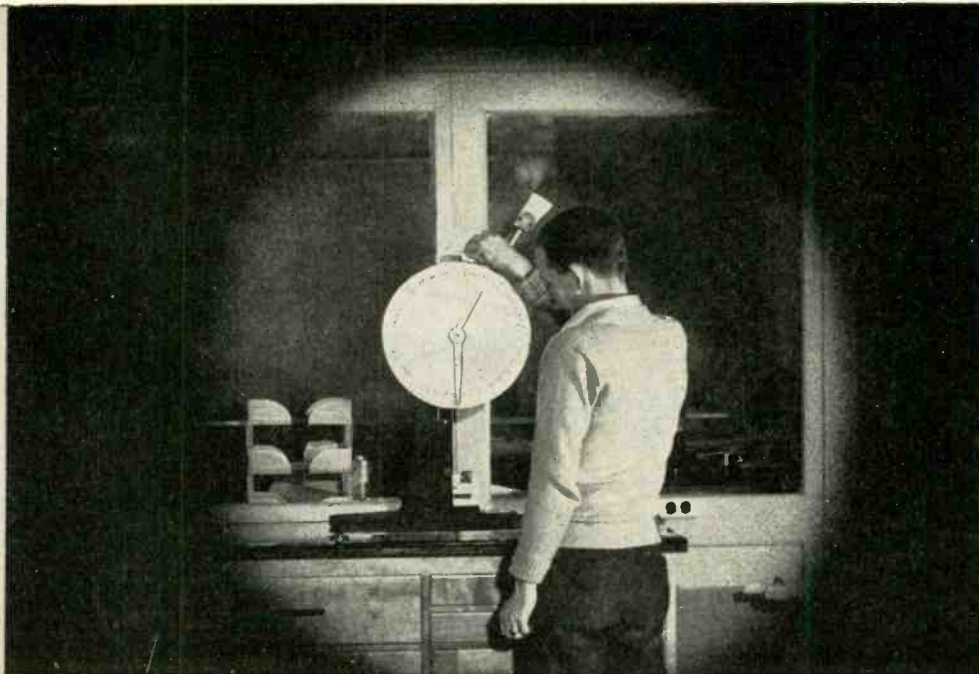

National's Continuous Research ... the answer to your Improved Profitable Products

Research to develop new materials to fit exactly the needs of industries, where plastics practically find efficient use, is a never-ending project at National. Here with the aid of the finest research devices and facilities, National's experimental men are constantly working to aid you.

It will pay you to use—

**NATIONAL
VULCANIZED
FIBRE**

—A tough, horn-like material with high dielectric and mechanical strength. Excellent machinability and forming qualities, great resistance to wear and abrasion, long life, light weight. Sheets, Rods, Tubes, Special Shapes.

PHENOLITE
Laminated PLASTIC

—About one-half the weight of aluminum, possesses an unusual combination of properties—a good electrical insulator, great mechanical strength, high resistance to moisture; ready machinability. Sheets, Rods, Tubes, Special Shapes.

**PEERLESS
INSULATION**

The first fish paper developed for electrical insulation. Strong, smooth, flexible, with excellent forming qualities. High dielectric strength. Sheets, Rolls, Coils.

*National Research and Engineering Service are available to you, without obligation—
to help you solve your specific development problem. Write us—*

NATIONAL VULCANIZED FIBRE COMPANY

WILMINGTON,
Offices in Principal Cities





DELAWARE
Since 1873

How **ALLEN** **HEAD** precision fastenings apply to...

RADIO • TELEVISION • INSTRUMENT AND GENERAL ELECTRICAL MANUFACTURING



For greater strength: Allen  Head Screws permit the use of smaller sizes. For instance a No. 6 Allen  Head Cap Screw is equivalent to a No. 8 conventional screw.



For space economy: Allen  Head Screws permit closer spacing of screws, eliminate projecting heads.

For greater holding power: Allen  Head Screws are insurance against avoidable costly service operations.

In hard-to-reach places: Allen  Head Screws, plus Allen Hex Keys and Drivers start screws easily and save awkward "fingering in."



For fine adjustments, close, snug fit between key and screw permits delicate adjustments that stay put.

For tamper-proof settings in gauges and instruments, Allen  Head Screws can be set below surface and wax sealed.



If vibration is a factor, the precise Class 3 fit of Allen  Head Screws will build longer trouble-free life into the product.

For a ready-made threaded hole, the new Allenut offers greater holding power and positive anchor in soft metals.



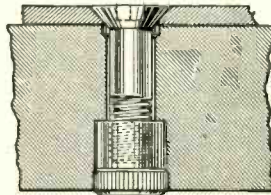

Allen  Head Screws are available as standard items in a wide range of sizes ranging upward from No. 4 x 1/8". NC and NF threads. Set screws stocked in cup, oval, flat, cone and half dog points (full dog; special). Popular sizes also available in 18-8 stainless steel; set screws, cup point only.

Sold only through leading distributors. Write the factory for technical information or regarding any special requirements.

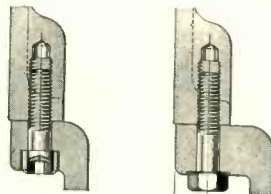

Allenut and Allen Flat Head Cap Screw used to hold thin metal plate to metal base. Allenut has been pressed into counterbored hole. Will not fall out or turn against driving action.



Allen  Head Cap Screws contribute to compact designing. Can be countersunk without allowing for wrench clearance.

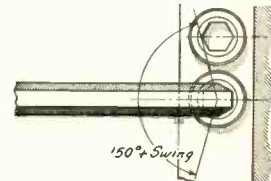

Allen  Heads permit close spacing impossible with conventional heads.

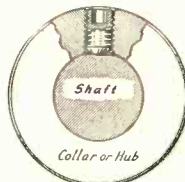

Firm grip without the use of weak slots or projecting heads.

If you make one or more of these products..

- Aircraft Components
- Bakery Machinery
- Business Machines
- Coin-Operated Machines
- Commercial Appliances
- Commercial Laundry, Dry Cleaning & Pressing Machinery
- Communication Equipment
- Electric Control Equipment
- Electric Motors, Generators, & Motor Generator Sets
- Electrical Equipment & Parts
- Electro-Medical Equipment
- Electronic Equipment & Devices
- Farm Equipment
- Food Processing Machinery
- Heating Equipment
- Household Appliances
- Industrial Machinery & Equipment
- Instruments & Test Equipment
- Lamps & Lighting Equipment
- Machine Tools
- Metal-Working Machinery
- Packaging Machinery
- Photographic & Projection Equipment
- Plating Equipment
- Portable Tools
- Printing Machinery
- Pumps & Compressors
- Radio & Radar Equipment
- Refrigeration & Air Conditioning Equipment
- Television Equipment
- Textile Machines
- Transportation Equipment
- Woodworking Machinery

... you can
improve it with
ALLEN  **HEAD**
SCREWS



ALLEN 
MANUFACTURING COMPANY
Hartford 2, Connecticut, U. S. A.

FOR 40 YEARS THE BUY-WORD FOR SOCKET SCREWS



Hi-Points in Hermetic Sealing!

PLUG IN TYPE HEADERS

OG-8 18 CHARACTERS .050 D. PIN .050 I.D. .040 6500V. PIN TO RIM 6000V. PIN TO RIM

OG-12 18 CHARACTERS .050 D. PIN .050 I.D. .040 6500V. PIN TO RIM 968

MULTIPLE TYPE HEADERS

1000 SERIES AVAILABLE WITH 2 TO 10 TERMINALS

18 CHARACTERS .050 D. PIN .050 I.D. .040 6500V. PIN TO RIM

2000 SERIES AVAILABLE WITH 2 TO 6 TERMINALS

18 CHARACTERS .050 D. PIN .050 I.D. .040 6500V. PIN TO RIM

NEO SIL HERMETIC SEALS
INDIVIDUAL TYPE TERMINALS

E-1 2500V FLASH OVER VOLTAGE

E-3 5500V FLASH OVER VOLTAGE

E-4 5500V FLASH OVER VOLTAGE

TEST DATA

The result of the Electrical Testing Laboratories Inc., Report #330655, dated March 18, 1949, on this material shows the following:

Volume Resistivity at 800 Volts d-c
Room Temperature 25°C R.H. 30 percent
Megohm-inches ohm-centimeters
 1.4×10^9 3.5×10^{12}

Dielectric Constant	Dielectric Dissipation Factor	Loss Factor
9.22 @ 60 cycles per second	.058	5.32
6.17 @ 1 megacycle per second	.0455	.28
5.35 @ 50 megacycles per second	0.20	1.1

Dielectric Strength at 60 cycles
Volts per mil — 370

Durometer Average — 80 ± 5
Temperature — Rated as a Class A material conservatively + 105° to -70° centigrade.

The Flashover Voltages indicated were taken at a temperature of 68° Fahrenheit, and 47% Relative Humidity.

HERMETIC SEAL TERMINALS — Applicable on MIL requirements. Will withstand thermal shock, vibrations, mechanical strains, and excessive pressures with no impairment of the seal or other functional characteristics. E-3LW terminals are now being used at 1000 psi static oil pressure and undergo 5000 psi tests for two minutes.

OCTAL TYPE PLUG IN HEADERS — Applicable for MIL requirements. These units can undergo sustained vibrations, large temperature changes, and other strains without impairment to the seal or other functional characteristics. Available with eight and twelve pins.

MULTIPLE PIN HEADERS — Applicable for MIL requirements. Presently being used on MIL-T-27 transformers. These units are available with 2 to 10 pins. These units can undergo conditions mentioned above with no impairment to the seal or other characteristics.

FUSE HOLDERS, HERMETICALLY SEALED — Available for 3-AG and 4-AG fuses. These units are completely sealed from moisture with or without the cap or fuse inserted. They are applicable on pressurized and gas filled components.

ROTARY WATERSEAL PANEL ASSEMBLIES — These units have an excellent five year customer history on gas filled pressurized components. They are available for 1/4" shafts and for potentiometers and switch bushings.

CABLES, HERMETICALLY SEALED — The cables are hermetically sealed at the plug on thru to the panel.

LINE CORDS WITH PLUGS FOR EUROPEAN USE, HERMETICALLY SEALED — These units are completely sealed at the plug and are being used on pressurized units.

GASKETS, METER, PANEL COVER, ETC. Molded from Neoprene for complete sealing.

ADAPTERS, U. S. TO EUROPEAN, AFRICAN, SOUTH AMERICAN SOCKETS — Our 200A and 300A together will adapt virtually all standard plugs, sockets, and lamp sockets of the above mentioned areas.

COIL FORMS, CRYSTAL CONTACTS, and other molded bakelite and Neo-Sil rubber units.

Your special problems are solicited.



26 CORNELISON AVE., JERSEY CITY 4, N. J.

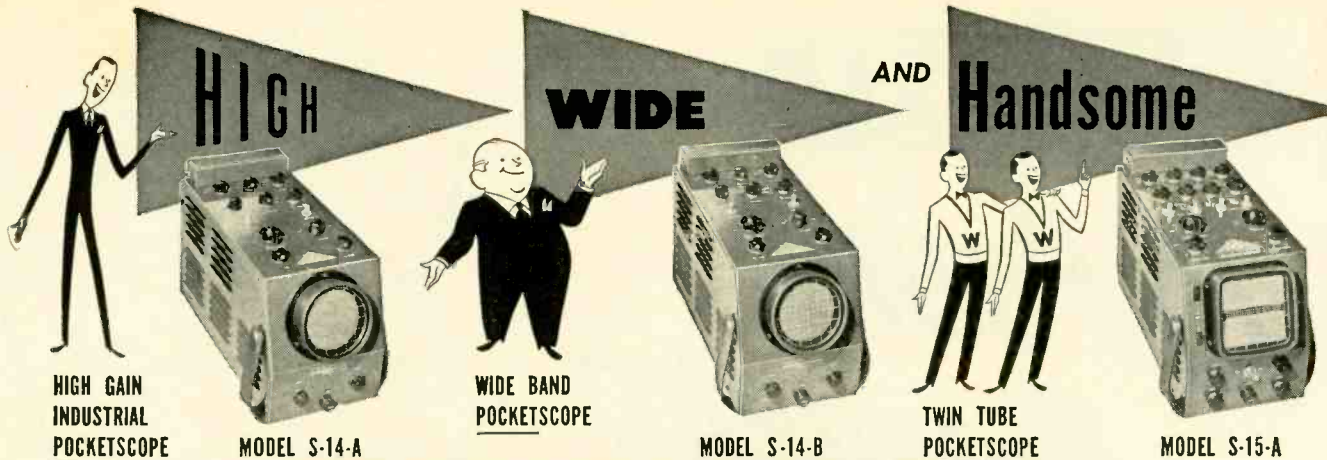

HIGH GAIN INDUSTRIAL POKETSCOPE

MODEL S-14-A

WIDE BAND POKETSCOPE

MODEL S-14-B

TWIN TUBE POKETSCOPE

MODEL S-15-A

THE WATERMAN LINE-UP

HI, WIDE and HANDSOME POKETSCOPES are characterized by small size, light weight, and outstanding electrical performance. All units have frequency compensated attenuators as well as non-frequency discriminating gain controls. All units have both periodic and trigger sweeps from 1/2 cycle to 50KC. The amplifiers are direct coupled thus frequency response starts from 0 cycles. No peaking coils are used, thus, the transient response is good. Full expansion of trace, both vertical and horizontal, is built in.

Combination filter and graph screens are used for better visibility, thus traces can be observed even under high ambient light condition. Binding posts for convenience of connections, with effective shield, are used. S-14-A has sensitivity of 10 mv/inch with pass band above 200KC. S-14-B has sensitivity of 50 mv/inch with pass band above 1 megacycle. S-15-A is similar to S-14-A except that it has two independent CR Tubes for multi-trace oscilloscope work. Accessories such as carrying cases and probes are available.



S-10-B



S-11-A



S-12-A



S-12-B



S-13-A



S-21-A

POKETSCOPES and RAKSCOPES have achieved a reputation for dependability and accuracy. The **LINEAR TIME BASE** can be used with the **S-11-A POKETSCOPE** or with any other oscilloscope to convert the scope to trigger operation from 1/2 cycle per second.



3SP

WATERMAN RAYONIC TUBE DEVELOPMENTS

Since the introduction of Waterman RAYONIC 3MP1 tube for miniaturized oscilloscopes, Waterman has developed a rectangular tube for multi-trace oscilloscopy. Identified as the Waterman RAYONIC 3SP, it is available in P1, P2, P7 and P11 screen phosphors. The face of the tube is 1 1/2" x 3" and the over-all length is 9 1/4". Its unique design permits two 3SP tubes to occupy the same space as a single 3" round tube, a feature which is utilized in the S-15-A TWIN-TUBE POKETSCOPE. On a standard 19" relay rack, it is possible to mount up to ten 3SP tubes with sufficient clearances for rack requirements. Photographic means of recording are under development and will be available shortly.



3MP

TYPICAL OPERATION

TUBE	VOLTS ANODE #2	VOLTS ANODE #1	VOLTS GRID #1	V/IN D1, D2	V/IN D3, D4	MAX. VOLT ANODE #2	MAX. VOLT ANODE #1	VOLTS HEATER	CURRENT HEATER
3SP	1000	165 to 310	-28 to -67	73 to 99	52 to 70	2750	1100	6.3	.6 Amp.
	2000	330 to 620	-58 to -135	146 to 198	104 to 140				
3MP	1000	200 to 350	0 to -68	140 to 190	130 to 180	2500	1000	6.3	.6 Amp.
	2000	400 to 700	0 to -126	280 to 380	260 to 360				

WATERMAN PRODUCTS CO., INC.

PHILADELPHIA 25 • PENNSYLVANIA • U.S.A.

Manufacturers of POKETSCOPES® • RAKSCOPES® • PULSESCOPES® and RAYONIC TUBES®

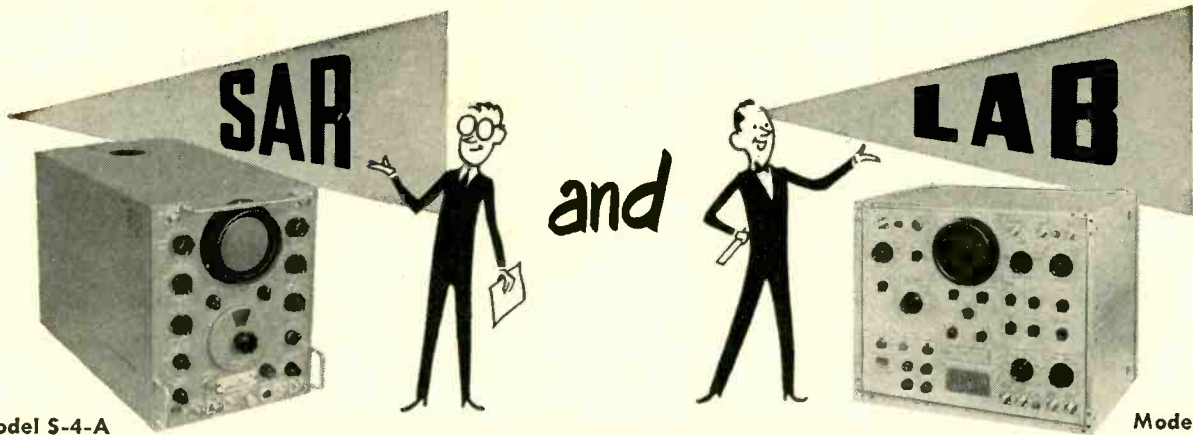

Model S-4-A

Model S-5-A

WATERMAN PIONEERING

WATERMAN INTRODUCES TWO NEW CATHODE RAY OSCILLOSCOPES

Compact, Portable Instruments For Precision Pulse Measurement Adaptable To All Electronic Work, Including TV . . .

The **PULSESCOPE**

TO PORTRAY THE ATTRIBUTES OF THE PULSE :
SHAPE, AMPLITUDE, DURATION AND TIME DISPLACEMENT

Video Amplifier up to 11 MC • Video Delay 0.55 μ s
Pulse Rise and Fall Time Better Than 0.07 μ s

S-4-A SAR PULSESCOPE

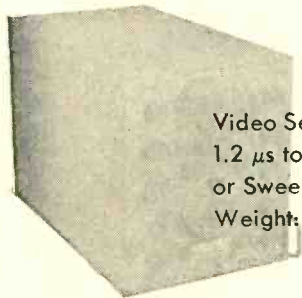

Video Sensitivity 0.5 v p to p/in. • S Sweep 80 cycles to 800kc, either trigger or repetitive • A Sweep 1.2 μ s to 12,000 μ s • R Delay 3 μ s to 10,000 μ s, directly calibrated on precision dial • R Pedestal or Sweep 2.4 μ s to 24 μ s • Internal Crystal Markers 10 μ s and 50 μ s • Size: 9 $\frac{1}{8}$ x 11 $\frac{1}{4}$ x 10 $\frac{1}{4}$ • Weight: Less than 32 pounds.

S-5-A LAB PULSESCOPE

Video Sensitivity 0.1 v p to p/in. • Sweep 1.2 μ s to 120,000 μ s with 10 to 1 expansion • Sweep either trigger or repetitive • Internal Markers synchronized with sweep from 0.2 μ s to 500 μ s • Trigger Generator and built-in precision amplitude calibrator • Completely cased • Size: 16 $\frac{1}{2}$ x 14 $\frac{1}{8}$ x 17 $\frac{1}{2}$ • Weight: Less than 60 pounds.



CABLE ADDRESS :
POKESCOPE, PHILA.



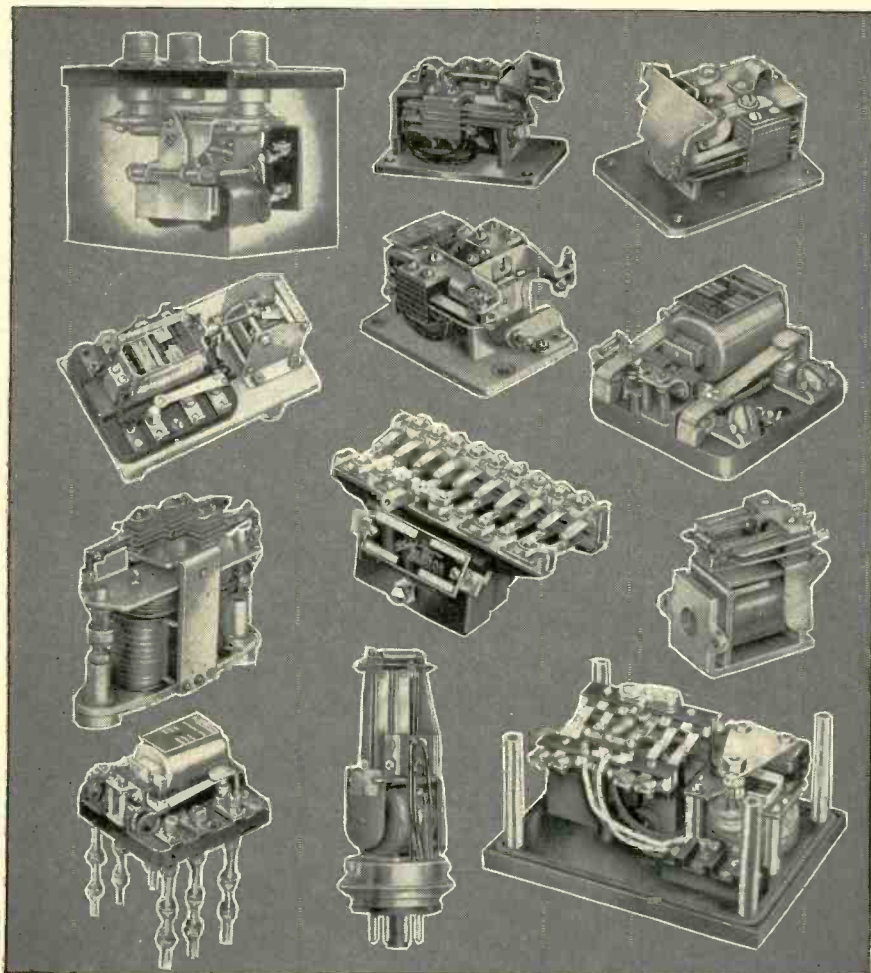

A RELAY for every application...

From extremely sensitive to heavy duty relays . . . whatever the need . . . you'll find Signal Engineering Relays built to meet the severest operating conditions.

Backed by a quarter-century of specialized engineering experience, each relay embodies design features which insure accurate, efficient and dependable operations to meet exacting standards of performance. That is why . . . whenever performance counts . . . Signal Engineering Relays are used as components by many of the largest manufacturers of electronic equipment and devices, and for other control operations by leading industrial firms everywhere.

Many of our standard relay assemblies can be modified to fit various Navy and Military applications.

Tell us your requirements and we will gladly submit our recommendations.

WRITE FOR LITERATURE EG-6
Engineering Representatives in Principal Cities

Wheelock RELAYS
SIGNAL
ENGINEERING & MFG. CO.
154 WEST 14TH ST. NEW YORK 11, N.Y.

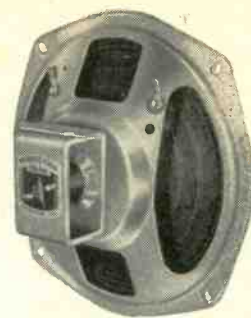

PERFECTION SPEAKERS

— For Rich, Clear Tones

- Flutter-proof cones
- Complete frequency range coverage
- Perfectly positioned voice coils
- Fully dust-protected — Individually tested
- For all types of radios and television sets—battery or AC-DC
- For all inter-com and P.A. systems
- Sizes from 2" to 8"

Write today for full details!

PERFECTION ELECTRIC CO.

2635 South Wabash Avenue, Chicago 16, Illinois

Makers of Perfection Ion Traps, BeamAdjusters and B. O. (Barkhausen Oscillation) Eliminators

this BOOK 11th year
now in its

has earned industry-wide acceptance as the only complete and accurate source of buying information for all types of electronic and allied products components and complete equipment

In Addition, this year . . .

V tells who has what in production or available in a reasonable time and unrestricted for general industrial use.

electronics BUYERS' GUIDE

Please mention this book when buying or inquiring from jt.

Browning INSTRUMENTS

Engineered for Engineers

The features described here are merely the highlights of this Browning equipment . . . write for data bulletins giving detailed specifications, circuit design, and operation of these instruments.

SWEEP CALIBRATOR



For use with oscilloscopes and synchrosopes, Model GL-22A accurately calibrates sweep time intervals. Markers provided at 0.1, 1, 10, and 100 microsecond intervals may be applied as deflection or as intensity modulation.

Operates from internal trigger, or may be triggered from external source.

OSCILLOSYNCHROSCOPE

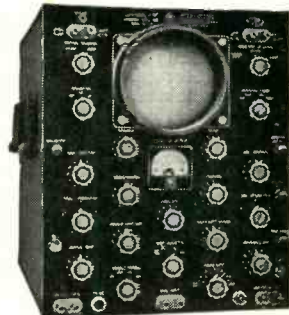

An outstandingly versatile instrument, Model OL-15B combines the functions of oscilloscope and synchroscope for application in laboratory and industrial testing in television, facsimile, pulse modulation, radar, nuclear physics, and communications circuits. Wide-range amplifiers assure faithful reproduction of 100 KC square wave rising or falling at 500 volts per microsecond.

LABORATORY AMPLIFIER



Model TAA-16A is designed for use with square-law-detector probes and slotted wave-guides in determination of standing-wave voltage ratio. Operating frequencies 500 to 5000 cycles, wide band or highly selective. Full-scale readings with less than 15 μ -volts at input with wide band, 10 μ -volts with selective operation.

POWER SUPPLY



Comprising a regulated power supply and square-wave modulator for low-powered velocity-modulated tubes, Model TVN-7 is the basic unit for laboratory type micro-wave signal generator. Modulation is square-wave, FM, or pulse. Cathode voltage 280-480 volts, continuously variable, reducible to 180-300 volt range.

OJ-17 OSCILLOSYNCHROSCOPE



An oscilloscope capable of producing satisfactory traces in work involving pulses of extremely short duration and in the study of complex wave forms having very high frequency components. The individual elements—scope, synchronizer, high-voltage power supply, low-voltage power supply, and control panel—are mounted in a standard vertical rack cabinet. Space is provided at the top of the cabinet for installation of a Fairchild Oscillorecord camera for making photographic records of scope traces. Vertical amplifier band width 16 Mc.; deflection sensitivity of .05 volts/inch at maximum gain; video delay circuit of 0.2 microseconds. Horizontal amplifier band width 2 Mc.; deflection sensitivity .25 volts/in.

ON-5 OSCILLOSYNCHROSCOPE



A low-priced instrument to serve as basic laboratory equipment for pulse and television work. Provides exceptional flexibility with 5 mc. bandwidth, high sensitivity, and sweep writing rate continuously variable over wide range; self-calibrating on X and Y axes; 5-inch 5U1 CR tube operates at accelerating potential of 2600 volts; sweep speed controls directly calibrated.

FM-AM AND FM TUNERS

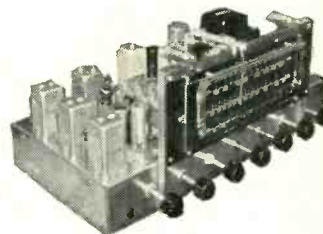

The model RJ-20A FM-AM tuner, built to meet highest performance requirements has Armstrong FM circuit, full frequency response to 15,000 cycles. Separate RF and IF for AM and FM. 9 kc. and 4 kc. bandwidths. Two-stage audio system, 20 db. boost in bass or treble.

• For use with existing high-fidelity audio systems: Model RJ-12B FM-AM Tuner; Model RV-10A FM Tuner.

FM MODULATION MONITOR

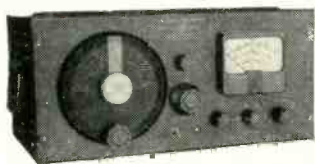

Model MD-25A . . . for monitoring the modulation of all FM transmitters operating in the communications bands from 30 to 162 Mc. A simple and inex-

pensive means for checking fixed or mobile transmitters for compliance with FCC plus-or-minus 15 KC. limit and for reduction of adjacent-channel interference. Flashing lamp indicates instantaneous modulation peaks exceeding 15 KC. Ranges: 30-40, 40-50, 72-76, 152-162 Mc.

In Canada, address Measurement Engineering Ltd., Arnprior, Ontario



BROWNING
Laboratories, Inc.
Winchester, Mass.
ENGINEERED FOR ENGINEERS

MYCALEX the ideal insulation

INJECTION MOLDED GRADES:

MYCALEX 410

MYCALEX 410 IS APPROVED FULLY AS GRADE L-4B UNDER NATIONAL MILITARY ESTABLISHMENT SPECIFICATION JAN-1-10 "INSULATING MATERIALS, CERAMICS, RADIO, CLASS L." CAN BE INJECTION MOLDED, WITH OR WITHOUT METAL INSERTS, TO EXTREMELY CLOSE TOLERANCES.

CHARACTERISTICS

Power Factor, 1 megacycle.....	0.0015
Dielectric Constant, 1 megacycle.....	9.2
Loss factor, 1 megacycle.....	0.014
Dielectric Strength, volts/mil.....	400
Volume Resistivity, ohm/cm.....	1×10^{15}
Arc Resistance, seconds.....	250
Impact Strength, Izod	
ft.-lb./in of notch.....	0.7
Max. Safe Operating Temp. °C.....	350
°F.....	650
Water Absorption, % in 24 hours.....	nil
Coefficient of Linear	
Expansion, °C.....	11×10^{-6}
Tensile Strength, psi.....	6000
Compression Strength, psi.....	27,000

★ ★ ★

MYCALEX 410X

MYCALEX 410X CAN BE INJECTION MOLDED, WITH OR WITHOUT METAL INSERTS, TO EXTREMELY CLOSE TOLERANCES.

CHARACTERISTICS

Power Factor, 1 megacycle.....	0.012
Dielectric Constant, 1 megacycle.....	6.9
Loss factor, 1 megacycle.....	0.084
Dielectric Strength, volts/mil.....	400
Volume Resistivity, ohm/cm.....	5×10^{14}
Arc Resistance, seconds.....	250
Impact Strength, Izod,	
ft.-lb./in of notch.....	0.6
Max. Safe Operating Temp. °C.....	350
°F.....	650
Water Absorption, % in 24 hours.....	nil
Coefficient of Linear	
Expansion, °C.....	12×10^{-6}
Tensile Strength, psi.....	6000
Compressive Strength, psi.....	28000

— a non-organic glass-bonded mica insulation featuring —

- LOW LOSS — HIGH EFFICIENCY
- HIGH DIELECTRIC STRENGTH
- IMPERVIOUS TO OIL OR WATER
- FREEDOM FROM CARBONIZATION
- PERMANENT DIMENSIONAL STABILITY
- WITHSTANDS HIGH TEMPERATURE
- IMMUNE TO HUMIDITY
- EXCELLENT MECHANICAL CHARACTERISTICS



AVAILABLE IN SHEETS, RODS, AND FABRICATED TO SPECIAL SHAPES

MYCALEX

LOW-LOSS MINIATURE TUBE SOCKETS

These sockets cost no more than ordinary phenolic types yet electrical characteristics are far superior. Dimensional accuracy and uniformity are unexcelled.

PRODUCED IN TWO GRADES

MYCALEX 410 is approved fully as Grade L-4B under N.M.E.S. JAN-1-10 "Insulating Materials, Ceramic, Radio, Class L." MYCALEX 410X is lower in cost but it's insulating properties greatly exceed those of general purpose phenolics.

Both types available in 7-pin, and 9-pin and subminiature. All are injection molded to high precision. For MYCALEX 410 and 410X physical properties see opposite page.



FOR LITERATURE, INFORMATION OR QUOTATIONS —



MYCALEX CORPORATION OF AMERICA

Owners of 'MYCALEX' Patents and Trade-Marks

for ALL frequencies

MYCALEX

—economical, widely applicable machines and molds to close tolerances

Mycalex is a highly developed glass-bonded mica insulation backed by over a quarter-century of continued research and successful performance. In its present high state of development, MYCALEX combines every important characteristic demanded of a modern, permanent, efficient electrical insulating material. MYCALEX is supplied in sheets or rods, can be injection or compression molded to close tolerance, is readily machineable, and can be fabricated in practically any size or shape. Dielectric losses are very low from 60 cycles to 24 kilomegacycles per second, arc resistance, volume resistivity and other electrical characteristics meet the most rigorous requirements. Physical properties are equally advantageous.



CAN BE TAPPED, DRILLED, THREADED
GROUND, OR MOLDED WITH INSERTS



MYCALEX

GENERAL
CATALOG

TUBE SOCKET
DATA SHEETS



Your copy of the new up-to-the-minute MYCALEX CATALOG and ENGINEERS HANDBOOK will be sent promptly on request. Tells the entire MYCALEX insulation story—contains 20 pages of factual information including design, engineering, and practical manufacturing data.

Available on request, these data sheets cover the entire line of MYCALEX tube sockets. MYCALEX tube sockets offer outstanding advantages over practically every other type yet are priced competitively with the cheapest sockets available anywhere. Get the facts today.

ENGINEERING COLLABORATION

MYCALEX engineers are always at your service for assistance in solving design problems with MYCALEX insulation.

Their wide experience can be helpful in reducing the cost and increasing dependability and saleability of your product.

—CALL, WRITE OR WIRE 60 CLIFTON BLVD., CLIFTON, N. J.

Executive Offices: 20 Rockefeller Plaza, New York 20
Plant and General Offices: Clifton, New Jersey

MACHINEABLE GRADES:

MYCALEX 400

MYCALEX 400 IS APPROVED FULLY AS GRADE L-4A UNDER NATIONAL MILITARY ESTABLISHMENT SPECIFICATION JAN-1-10 "INSULATING MATERIALS, CERAMIC, RADIO, CLASS L."

CHARACTERISTICS

Power Factor, 1 megacycle.....0.0018
Dielectric Constant, 1 megacycle.....7.4
Loss Factor, 1 megacycle.....0.013
Dielectric Strength, volts/mil.....500
Volume Resistivity, ohm/cm..... 2×10^{15}
Arc Resistance, seconds.....300
Impact Strength, Izod,
ft.-lb./in of notch.....1.85
Max. Safe Operating Temp., °C.....370
°F.....700
Water Absorption, % in 24 hours.....nil
Coefficient of Linear
Expansion, °C..... 10.2×10^{-6}
Tensile Strength, psi.....6000
Compressive Strength, psi.....35000

★ ★ ★

MYCALEX K-10

MYCALEX K-10 CONFORMS FULLY TO GRADE HIC5H4 UNDER NATIONAL MILITARY ESTABLISHMENT SPECIFICATION JAN-1-12.

CHARACTERISTICS

Dielectric Constant, 1 megacycle...10.6
Q Factor, 1 megacycle.....300
Loss factor, 1 megacycle.....0.034
Volume Resistivity, ohm/cm... 3.0×10^{14}
Dielectric Strength, volts/mil
(0.10 in. thickness).....270
Fractional Decrease of Capacitance
with Temperature Change.....0.0056
Fractional Increase of Capacitance
with Temperature Change.....0.0076
Max Safe Operating
Temperature, °C.....400

MYCALEX K embraces an entire series of capacitor dielectrics, each with specific characteristics. These can be supplied on special order in sheets 14" x 18" in area and from 1/8" to 1" in thickness, also available in rods. MYCALEX K can be machined to close tolerance or molded.



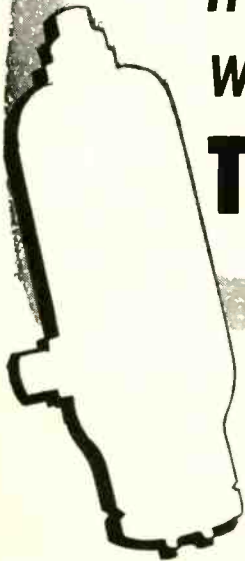

It's Powered Right . . .
When It's Powered with
TAYLOR TUBES

**These Taylor Tubes
Representatives are
at Your Service!**

Perry Saffler Associates, Inc.
53 Park Place
New York 7, New York

Harold A. Chamberlin
31 Milk Street
Boston 9, Massachusetts

Ray T. Schottenberg
152 Merion Avenue
Haddonfield, New Jersey

Tanner & Covert
600 Grant Street
Pittsburgh 19, Pennsylvania

Fred J. Stevens
15324 Mack Avenue
Detroit 24, Michigan

Southern Sales Company
1135 Lincoln Tower
Fort Wayne 2, Indiana

J. M. Cartwright & Son
1336 Madison Avenue
Memphis 4, Tennessee

J. M. Cartwright & Son
1145 Peachtree St., N. E.
Atlanta 5, Georgia

F. C. Somers & Company
18th and Grand Avenue
Kansas City 8, Missouri

J. Y. Schoonmaker Company
2011 Cedar Springs
Dallas 1, Texas

W. Bert Knight Co., Inc.
10373 W. Pico Boulevard
Los Angeles 64, California

Dale G. Weber
234 Sherlock Building
Portland 4, Oregon

J. Fred Whitehead
5403 Massachusetts Ave., N. W.
Washington 16, D. C.

CANADIAN FACTORY DISTRIBUTOR

Atlas Radio Corporation, Ltd.
560 King Street, West
Toronto 2-B, Canada
Cable: ATRADCO

EXPORT

Royal National Company, Inc.
75 West Street
New York 6, New York
Cable: NATVARNCO, N. Y.

★ **TRANSMITTING**

★ **RECTIFIER**

★ **INDUSTRIAL**

★ **ELECTRONIC**

As always, Taylor is producing tubes of superior quality and outstanding performance. The Taylor Representative nearest you is ready and willing to discuss your particular requirements. Call on him for information any time.

Taylor HEAVY **CUSTOM BUILT** DUTY **Tubes**

TAYLOR TUBES INC., 2312-18 WABANSIA AVE., CHICAGO 47, ILL.

THIS IS THE

ONE BOOK

**THE ONLY
ONE OF ITS KIND**

**In which
design engineers and
purchasing agents will find
a complete, accurate, and
up-to-date list
of the manufacturers
of all types of electronic
and allied products . . .
components and complete
equipment.**

**Keep it handy
for ready reference
throughout the year.**

When buying, or requesting
product information be sure
to mention . . .

electronics BUYERS' GUIDE

SHALLCROSS

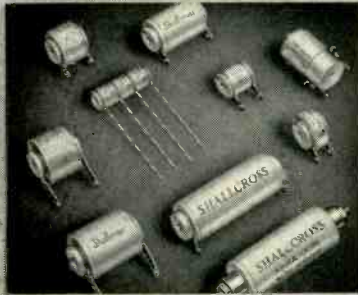

AKRA-OHM PRECISION RESISTORS

Not only are Shallcross Akra-Ohm wire-wound precision resistors made to extremely close tolerances; equally important, they are physically protected to maintain their accuracy under difficult operating conditions. Types, shapes, sizes,

and mounting styles for JAN and other exacting needs. Guaranteed tolerances from 0.1% to 0.02% and stabilities as low as 0.003% where required. Matched pairs and sets available. Write for Shallcross Resistor Bulletin R3A.

MULTI-POSITION SELECTOR SWITCHES

Shallcross regularly manufactures a wide variety of single or multi-deck selector switches having up to 180 positions and designed for dependable performance up to 250 volts 10 amperes or 2500 volts 1 ampere A.C. Contact resistance ranges

from a low of 0.0005 ohms to a maximum of 0.005 ohms depending upon the size and material of the contacts. Outline your requirements on Specification Sheet No. 6 for recommendation. Write for Data Bulletin L13.

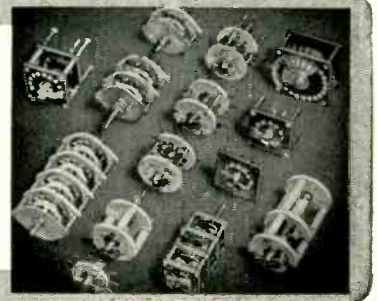

PRECISION ATTENUATORS

Improved materials and production techniques and careful quality control for Shallcross Attenuators have resulted in a line that sets new, higher standards of attenuation performance for practically every audio and communications use. Included are single and dual potentiometers, vari-

able impedance matching networks, V. U. meter multipliers, cueing attenuators, fixed pads, pre-emphasis and de-emphasis networks, attenuation boxes, ladder and balanced ladder controls, and bridged T, straight T, bridged H, and straight H attenuators. Write for Attenuator Bulletin 4.

PRECISE MEASURING INSTRUMENTS

As long-time specialists in standard and special electrical measuring instruments, Shallcross welcomes your inquiry for any desired type. Standard instruments include:

Resistance Standards • Decade Potentiometers • Decade Resistance Boxes • Bridges, Wheatstone • Bridges, Kelvin-Wheatstone • Bridges, Limit • Bridges, Megohm • Capacitor Analyzers • Decibel Meters • Tone Generators • Telephone Test Equipment • Low-Resistance Test Sets • Insulation Test Sets • High-Voltage Test and Measuring Equipment

Write for Shallcross Bulletin 10

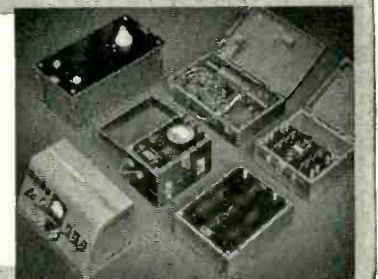

HI-MEG, HI-VOLTAGE RESISTORS

Special resistance elements hermetically sealed in ceramic tubes with ferrule terminals. Three standard sizes offer values to over 100 megohms. Write for Bulletin F.



HIGH-RANGE KILOVOLT METER MULTIPLIERS

Whether for direct high-voltage measurements or for use as standards, Shallcross KV meter multipliers combine close accuracy with safety and dependability. Various types are available for voltages up to 200,000 volts or higher if required. Write for Bulletin F.



HERMETICALLY-SEALED NETWORKS

Resistance, capacitance, bridge and inductance types available to meet critical electrical specifications and space requirements. Outline details of your requirements for recommendation by Shallcross Engineers.

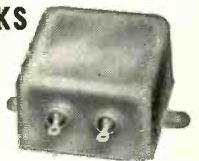

CUSTOM-BUILT SPECIALTIES AND ENGINEERING SERVICE

Sealed networks, high voltage measuring equipment, special test sets, thermally controlled networks, precise decades and networks for computer devices, high resistance standards, and critical coil assemblies are designed by Shallcross Engineers and built to meet your requirements. Forward your specifications for further information.

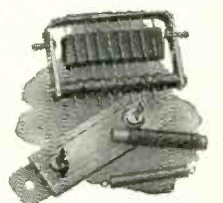

SHALLCROSS MANUFACTURING CO., Dept. EG-61 Collingdale, Pa.

Commerce and the Military write THEIR SPECIFICATIONS to...

The Industry's Complete Line of High Quality Communications Equipment

In war or peace, in Commerce or the Military, the men who make the decisions have always known the vital importance of the "nerve network". Now, in these days of modern high-speed telegraph and tele-printer radio communications equipment—especially unattended and multi-channel—these men demand the highest precision, speed and dependability—without compromise.

And they get it—from **NORTHERN RADIO!**

During and directly following World War II, the engineers at Northern Radio pioneered and concentrated research against the classic enemies of dependable communications—transients, parasitics, spurious and undesired side-bands, susceptibility to atmospheric, adjacent channel interference, static, fading, etc.

The result of this exhaustive, specialized research

was to demonstrate the superiority of the *Frequency Shift System* of transmission and reception. And today, many of the items in the complete Northern Radio line are based upon Frequency Shift.

Further, Northern Radio's consistent research continues to push Frequency Shift to newer, ever-greater heights of achievement.

—So that, when Commerce or the Military write their equipment specifications, they draw them directly from many of the features of Northern Radio units.

Around the globe today, from the Poles to the Equator, there is hardly an important station where Northern Radio equipment is not on day-after-day duty—serving the needs of Commerce and the Military with communications of the fastest speed and highest fidelity.

RADIO MULTIPLEX SYSTEM

Multi-Channel Equipment for Standard Communications Frequencies. Adapts existing transmitting and receiving facilities for radio multiplex.

The system illustrated is a four-channel unit, used for transmitting and receiving radio tele-printer, telegraph or other similar low speed keying intelligence, where a limited assigned carrier band-width may be utilized. The two bays at the right are the complete receiving units; left, the transmitter terminal and exciter facilities. The system may be adjusted for band widths of 3 to 12 kc and is intended to take advantage of periods of time where propagation conditions give signals which are better than the minimum required for one channel of normal frequency shift operation. Simple operation of key switches will insert as many channels as the conditions permit. These switches automatically maintain the pre-set bandwidth regardless of the number of channels in use. The system also provides front panel switching to standard 850 cycle frequency shift operation. However, experience indicates that when propagation conditions permit frequency shift operation, they will usually allow at least two channels of multiplex.

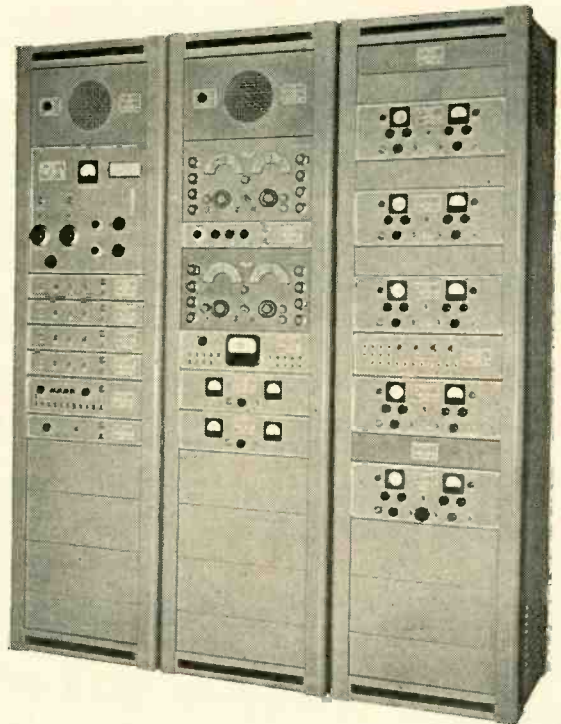

★ ★ ★ ★ ★

FREQUENCY SHIFT CONVERTER



TYPE 107 MODEL 2

A dual channel unit, used with frequency shift receiving systems to convert the mark and space tones from the output of single or diversity receivers, into DC pulses capable of operating a tele-printer, tape recorder or other device so operated. Also used as a demodulator when receiving make and break CW or ICW signals.

2" oscilloscope tuning pattern indicates proper receiver adjustment of both mark and space frequencies, either during initial setup or under actual keying conditions. This pattern and a specially designed discriminator, coupled with a high degree of limiting, make it the outstanding performer in its field.

INPUT FS LIMITS 100 to 1000 cps. frequency shift. Mark frequency set at 2975 cps.

CW-ICW INPUT... 400 to 7500 cps.

KEYING SPEED... Up to 600 w.p.m.

OUTPUT: 1. Neutral DC pulses. 60 ma in 1800 ohm external load. One side grounded.

2. Polar DC pulses \pm 30 ma in 1800 ohms load. Center grounded.

3. May be operated into any impedance from 100 to 100,000 ohms.

NORTHERN RADIO COMMUNICATIONS EQUIPMENT

RADIO MULTIPLEX SYSTEMS ★ MULTI-CHANNEL TONE SYSTEMS ★ DIVERSITY RECEIVERS
 STANDARD FREQUENCY SHIFT KEYERS ★ LOW FREQUENCY SHIFT KEYERS ★ FREQUENCY
 SHIFT CONVERTERS ★ TONE FILTERS ★ TONE KEYERS ★ DEMODULATORS ★ LINE
 AMPLIFIERS ★ MASTER OSCILLATORS ★ MONITORS

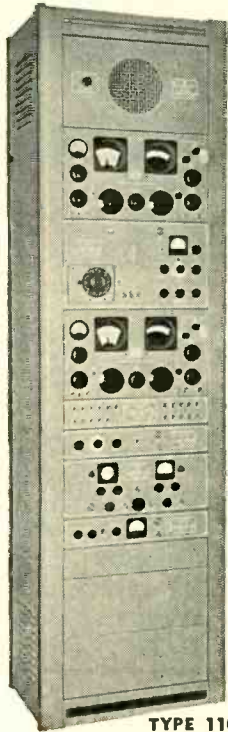

TYPE 110

DUAL DIVERSITY RECEIVER

Used for dual spaced diversity reception in high speed radio tele-printer, telegraph or telephone service, using any common modulation, such as FS, CW, ICW, phone, etc. Complete receiver is housed in a rack type, fully enclosed cabinet. Provided with specially modified receivers, monitor speaker, IF monitor, master oscillator, and the necessary patching arrangements. Can be supplied with any combination of terminal equipment for reception of radio tele-printer, undulator tape and program service, or for remote use where the intelligence is transmitted via land-line or UHF link.

Receiver is shown with terminal equipment as recommended for general communications usage. The units are (top to bottom) Monitor speaker, Receiver #1, Variable Master Oscillator, Receiver #2, Patching Panel, IF Monitor, Converter, Tone Keyer, Blank panels. For special features of this receiver see individual units described on this and the preceding page.

FREQUENCY and SHIFT MONITOR SYSTEM

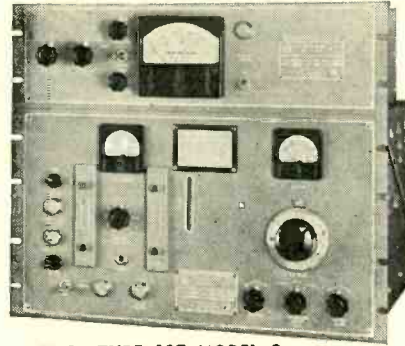

METER: TYPE 127 MODEL 2
 MONITOR: TYPE 106 MODEL 4

This system consists of a Type 106 Frequency and Shift Monitor and a Type 127 Frequency Meter. It is designed as a secondary standard to monitor the frequency and amount of shift of transmitter carrier outputs. It is particularly intended to measure the frequency shift of a mark and space (FS) signal either when setting up for traffic or under normal keying conditions.

The Monitor's stability is better than 2 cycles per megacycle over an ambient temperature range of 0-50° C—using crystals having a temperature coefficient of only 3 parts/million/degree C. Range is 2.5-30 mc with 10 crystal-controlled frequencies (separate panel trimmers for each); use of external oscillator also provided for. Frequency Shift range is 10-10,000 cps. Less than 100 millivolts RF input needed for 2 volts audio output.

The Frequency Meter is specially designed with selectable normal and fast-acting damping factors, permitting frequency measurements of signals while keying. Its accuracy is 2% of full scale for the ranges 0-200, 500, 2000, 5000, 20,000 cps.

FREQUENCY SHIFT KEYER

incorporates the following outstanding features:



TYPE 105 MODEL 4

Frequency shift dial adjusts "mark" and "space" frequencies equally above and below the carrier position, which remains fixed. • Simplified frequency setting permits only the upper side band tuning indication to be visible on the meter over substantially all of tuning range. • Direct reading frequency calibration of shift from 0 to 1000 cycles. • Direct reading frequency cali-

bration of mixer and output tuning dials from 2.5 to 6.7 mc. • Direct reading of calibration of output frequency vernier ± 600 cycles. • Pulse shaping circuit to permit operation within assigned bandwidth with no adjacent channel radiation. • Highly stable temperature controlled oven with temperature control of $\pm 0.1^\circ$ C. at 60° with heaters on 4 sides of inner oven. • Component ratings according to JAN Specs provide greater assurance of trouble-free operation.

TONE CHANNELING SYSTEMS

Complete package systems of Multi-Channel Tone Equipment (both AM and Frequency Shift) are available for application to land line or radio link systems.

VARIABLE MASTER OSCILLATOR

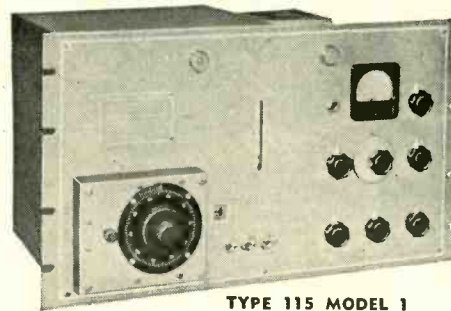

TYPE 115 MODEL 1

Principally used in diversity reception to supply local common oscillator injection voltage to receivers. Crystal oscillator for BFO. The Variable High Frequency section gives stability equivalent to that of non-temperature controlled crystal oscillators. It is

also equipped with three crystal controlled frequencies for operation of receivers on a fixed frequency basis. The variable high frequency oscillator is provided with local crystal oscillator for spot checking of twenty points within its range.

TECHNICAL DATA

Variable HFO output frequency	2-32 mcs continuous
Fixed Frequency crystals	2-4 mcs for output frequencies of 2-32 mcs
Output impedance	72 ohm coaxial cable
Output level	2 watts 2-4 mcs, 0.5 watts 4-32 mcs
Variable HFO Stability	20 cps per mc for ambient change of $\pm 25^\circ$ C.
	5 cps per mc for $\pm 10\%$ Line Voltage
	20 cps per mc for resetability
	20 cps per mc for readability

This unit can also be used as a transmitter exciter or for laboratory measuring purposes.

FOR FULL DATA ON THE COMPLETE LINE, WRITE NOW FOR CATALOG BG.

NORTHERN RADIO COMPANY, inc.

Pace-Setters in Quality
 Communication Equipment



143 WEST 22ND STREET, NEW YORK 11, N. Y.

WATKINS 9-9117

Save Time, Cut Tool Costs . . . with Rogan's
Stock Molded KNOBS

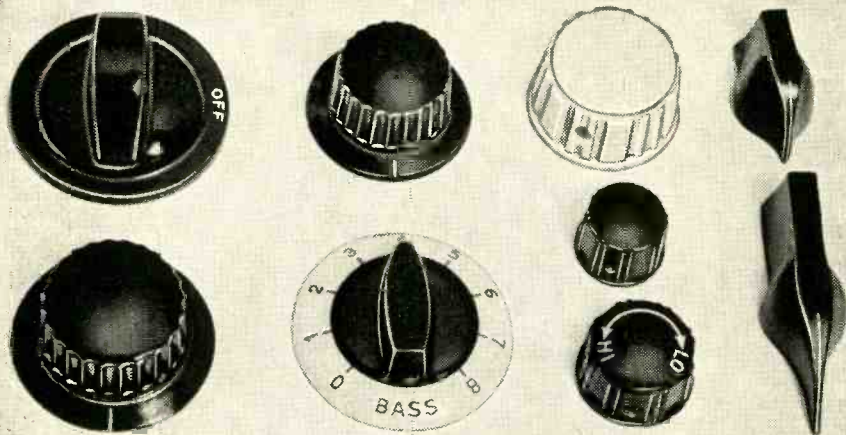

SEND FOR FREE CATALOG . . .

Illustration shows just a few of the many stock molded knobs available from Rogan's huge selection. Supplied without tool charge, ready for immediate delivery. Saves you time and money. Wide range of sizes, shapes, colors. Can be branded to specifications. Write for catalog now!

ROGAN BROTHERS 2504 IRVING PK. BLVD.
 CHICAGO, 18, ILLINOIS

Compression Molders and Branders of Plastics

FIRST WILDER

**ADJUSTABLE
 SOLDERING IRON
 HOLDER**



FOR *Safety*
 AND *Speed*

IN SOLDERING

AVAILABLE WITH WIPING PAD AS SHOWN ABOVE OR WITH BRACKET FOR BENCH AND SHELF MOUNTING

FOR COMPLETE INFORMATION WRITE
WILDER MFG. CO., INC.
 411 LEXINGTON AVENUE
 BROOKLYN 16, N. Y.

**HEATHKITS
 OFFER UNMATCHED ADVANTAGES**

Heathkit OSCILLOSCOPE KIT \$39.50

Heathkit TV ALIGNMENT GENERATOR KIT \$39.50

Heathkit SIGNAL TRACER KIT \$19.50

Heathkit CONDENSER CHECKER KIT \$19.50

Heathkit IMPEDANCE BRIDGE KIT \$69.50

Heathkit HANDI-ESTER KIT \$13.50

Heathkit TUBE C-CHECKER KIT \$29.50

Heathkit VACUUM TUBE VOLT-METER KIT \$23.50

Heathkit ELECTRONIC SWITCH KIT \$19.50

Heathkit AUDIOIC GENERATOR KIT \$34.50

Heathkit RF SIGNAL GENERATOR KIT \$19.50

Heathkit BATTERY ELIMINATOR KIT \$22.50

You'll find unmatched advantages in HEATHKITS—the most complete line of test equipment in kit form. Careful engineering and extensive laboratory testing in the development of each kit, coupled with the use of only highest quality components give you RUGGED, DEPENDABLE, and ACCURATE test equipment.

You SAVE MONEY when you build your own because all expensive factory wiring and construction costs are completely eliminated . . .

All kits are COMPLETE and a real pleasure to build—Every part necessary is furnished—and the clear, detailed instruction manual makes construction easy and educational. (And, the finished kits are truly professional in appearance.)

Order your HEATHKIT today and enjoy these tremendous advantages!

HEATH COMPANY
 BENTON HARBOR 14, MICHIGAN

EXPORT AGENT: ROCKE INTERNATIONAL CORP., 13 EAST 40th STREET, NEW YORK CITY 16

This Year
The
BUYERS' GUIDE

inaugurates

A

Where-to-find-it Guide

to the

1930-1939

**electronics'
 editorial
 contents**

A cumulative editorial index to the first ten years of **ELECTRONICS** Pages C-1 to C-36

Next ten years in next year's **GUIDE**.

MACHLETT ELECTRON TUBES

*for Broadcasting
and Industry*

TRANSMITTING AND INDUSTRIAL TUBES

TYPE	CATHODE		MU	MAX. ANODE RATING				FULL INPUT FREQ. MCS.	COOLING
	VOLTS	AMPS		VOLTS	AMPS	INPUT WATTS	DISS. WATTS		
ML-2C39A	6.3	1.0	100	1000	0.125	125	100	2500	Forced-Air
ML-207	22.0	51.0	20	15000	2.0	30000	10000	1.6	Water
ML-212E	14.0	6.0	16	3000	.350	—	275	1.5	Convection
ML-220C	21.5	41.0	40	15000	1.5	—	10000	4	Water
ML-220CA	21.5	41.0	40	15000	1.5	—	5000	4	Forced-Air
ML-228A	21.5	41.0	16	6000	1.5	—	5000	3	Water
ML-232B	20.0	60.0	40	20000	3.0	—	25000	3	Water
ML-240B	21.5	41.0	40	12000	1.7	—	10000	20	Water
ML-241B	14.0	6.0	16	3000	.350	—	275	7.5	Convection
ML-242C	10.0	3.25	12.5	1250	.150	188	100	6	Convection
ML-279A	10.0	21.0	10	3000	.800	—	1200	20	Convection
ML-298A	27	225	32	20000	11.0	—	100000	4	Water
ML-298B	27	225	57.5	20000	11.0	—	100000	4	Water
ML-342A	20.0	67	40	20000	2.5	—	25000	4	Water
ML-343A	21.5	57.5	40	18000	2.0	—	10000	4	Water
ML-343AA	21.5	57.5	40	18000	1.5	—	5000	4	Forced-Air
ML-356	7.5	170	20	12500	6.0	60000	22500	25	Water
ML-357B	10.0	10	30	4000	0.5	1600	400	110	Convection
ML-379A	10.0	21.0	10	3000	.800	—	1200	20	Convection
ML-381	6.3	1.0	100	3500	0.01*	35*	35*	3000	Forced-Air
ML-450TH	7.5	12.0	38	6000	0.6	—	450	40	Convection
ML-805	10.0	3.25	Var.	1500	0.210	315	125	30	Convection
ML-813	10.0	5.0	8.5	2000	0.180	360	100	30	Convection
ML-814	10.0	3.25	—	1250	.150	180	50	30	Convection
ML-833A	10.0	10.0	35	4000	0.50	1800	400	20	Forced-Air
ML-846	11.0	51	40	7500	1.0	7500	2500	50	Water
ML-880	12.6	315	20	10500	6.0	60000	20000	25	Water
ML-889A	11.0	120	21	8500	2.0	16000	5000	50	Water
ML-889RA	11.0	120	21	8500	2.0	16000	5000	40	Forced-Air
ML-891	22.0	60	8.5	12000	2.0	18000	6000	1.6	Water
ML-891R	22.0	60	8.5	10000	2.0	15000	4000	1.6	Forced-Air
ML-892	22.0	60	50	15000	2.0	30000	10000	1.6	Water
ML-892R	22.0	60	50	12500	2.0	18000	4000	1.6	Forced-Air
ML-893A	20.0	183	35	20000	4.0	70000	20000	5	Water
ML-893AR	20.0	183	35	20000	4.0	70000	20000	5	Forced-Air
ML-5530	5.0	55	26	5000	1.75	8750	3000	110	Forced-Air
ML-5541	7.5	57	26	8500	2.75	23000	10000	110	Forced-Air
ML-5604	11.0	176	19.5	12500	3.0	32500	10000	22.5	Forced-Air
ML-5606	22.0	60	50	15000	2.0	30000	10000	1.6	Water
ML-5619	11.0	176	19.5	12500	3.0	32500	20000	22.5	Water
ML-5658	12.0	310	20	12500	5.0	60000	20000	20	Water
ML-5666	11.0	120	21	10000	2.0	20000	12500	22.5	Water
ML-5667	11.0	120	21	10000	2.0	20000	7500	22.5	Forced-Air
ML-5668	22.0	60	50	14000	2.0	28000	20000	5	Water
ML-5669	22.0	60	50	14000	2.0	28000	10000	5	Forced-Air
ML-5681	12.0	220	23	15000	12.0	150000	75000	30	Water
ML-5682	16.5	325	32	16000	20.0	300000	100000	30	Water

*Duty cycle: 0.0033

HIGH-VOLTAGE RECTIFIERS

TYPE	CATHODE		ANODE RATINGS		INSULATION	COOLING
	VOLTS	AMPS	INV. PKV	PEAK AMPS		
ML-102	20	19.0	75	750	Air	Convection
ML-103	10	11.5	125	78	Oil	Convection
ML-106	11	19.0	140	157	Oil	Convection
ML-108	13	12.5	140	200	Oil	Convection
ML-110	10	11.5	140	78	Air	Convection
ML-115	10	11.5	125	100	Air	Convection
ML-120	13	12.5	140	200	Air	Convection
ML-121	10	11.5	140	100	Oil	Convection
ML-126	13	12.5	150	200	Air	Convection
ML-170	13	12.5	200	200	Air	Convection
ML-180	13	12.5	200	200	Oil	Convection
ML-222A	21.5	41	25	5000	Air	Water
ML-5575/100	20	24	150	1000	Air	Convection
ML-5576/200	20	32	150	2500	Air	Convection

MERCURY VAPOR RECTIFIERS

TYPE	CATHODE		TUBE VOLT. DROP	FIL. EXCIT.	COOLING	ANODE RATINGS		
	VOLTS	AMPS				INV. PKV	PEAK AMPS	AV. AMPS.
ML-255B	5.0	19	15	Quad.	Forced-Air	20	20.0	5.0
ML-266B	5.0	42	15	Quad.	Forced-Air	22	40.0	10.0
ML-267B	5.0	6.75	10	Quad.	Convection	7.5	8.0	2.0
ML-315A	5.0	10	15	Quad.	Convection	12.5	8.0	2.0
ML-319A	5.0	6.75	10	Quad.	Convection	7.5	8.0	2.0
ML-321A	5.0	10	15	Quad.	Convection	12.5	8.0	2.0
ML-575A	5.0	10	10	In-Ph.	Convection	15	6.0	1.5
ML-673A	5.0	10	10	In-Ph.	Convection	15	6.0	1.5
ML-857B	5.0	30	15	Quad.	Forced-Air	22	40.0	10.0
ML-866A	2.5	5.0	15	In-Ph.	Convection	10	1.0	0.25
ML-869B	5.0	19	15	Quad.	Forced-Air	15	20.0	5.0
ML-872A	5.0	7.5	10	In-Ph.	Convection	10	5.0	1.25
ML-800B	5.0	7.5	10	In-Ph.	Convection	10	5.0	1.25

Machlett Electron Tubes are distributed in the United States by Graybar Electric Company, 420 Lexington Avenue, New York 17, N. Y. and in South America, Europe, Asia and Africa by Westrex Corporation, 111 Eighth Avenue, New York 11, N. Y.

Note: For additional technical data or prices, write to Machlett Laboratories, Inc., Springdale, Conn., or contact your nearest Graybar or Westrex office.

MACHLETT

OVER 50 YEARS OF ELECTRON TUBE EXPERIENCE

For AC CURRENT
ANYWHERE
NO MAGIC just
use

ATR

INVERTERS



ATR

**STANDARD AND
HEAVY DUTY
INVERTERS**



For Inverting D. C. to A. C.

Specially Designed for operating A. C. Radios, Television Sets, Amplifiers, Address Systems, and Radio Test Equipment from D. C. Voltages in Vehicles, Ships, Trains, Planes and in D. C. Districts.

✓ NEW MODELS ✓ NEW DESIGNS
✓ NEW LITERATURE

"A" Battery Eliminator, DC-AC Inverters
Auto Radio Vibrators

See your jobber or write factory

ATR

AMERICAN TELEVISION & RADIO CO.
Quality Products Since 1931
SAINT PAUL 1, MINNESOTA-U. S. A.

Sensational New NYLON Lacing Cords
win approval
of "Big Name"
Companies*

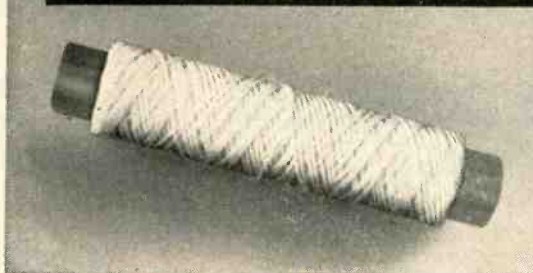

* names on request

"Never anything like it before", say the big companies in the electronics field. They're referring to Heminway & Bartlett's new fungus-proof Nylon Lacing Cords, specially coated to resist mold and micro-organisms and at the same time retain malleability.

With a tensile strength to suit your particular problem, and a synthetic resin finish with a melting point of over 190°, these new cords meet every installation requirement.

We'll be glad to give you complete information, including samples for field testing. No obligation, of course.

THE HEMINWAY & BARTLETT MFG. CO., 500 Fifth Avenue,
New York 18, New York. Branches: Chicago, Ill., St. Louis,
Mo., Cincinnati, Ohio, Charlotte, N. C., Gloversville, N. Y.

**HEMINWAY
& BARTLETT**

FUNGUS-PROOF

Nylon Lacing Cords.



DANO COILS
STAR IN ANY LEAGUE

- Form Wound
- Paper Section
- Acetate Bobbin
- Bakelite Bobbin
- Cotton Interweave
- Coils for High Temperature Applications

ALSO,
TRANSFORMERS
MADE TO ORDER



THE DANO ELECTRIC CO.
MAIN ST., WINSTED, CONN.

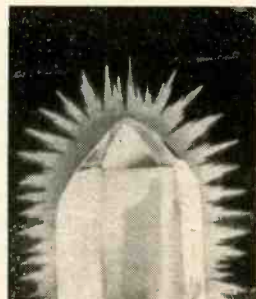

RAW BRAZILIAN
QUARTZ CRYSTALS
of the finest quality
for
ELECTRONICS and OPTICS

PAN AMERICAN TRADE DEVELOPMENT CORP.
40 WALL STREET
NEW YORK 5, N. Y.

Tel. Bowling Green 9-0290

ROBINSON engineered mounting systems

SHOCK MOUNTS and VIBRATION ISOLATORS

With



First All-Metal All-Weather MOUNTING SYSTEMS . . .

Robinson pioneered, in 1946, all-metal, all-weather vibration and shock mounting systems. Built for the electronic and instrument panel installations of today's high performance commercial and military aircraft, more than 50,000 all-metal systems have been delivered. Robinson MET-L-FLEX unit mounts and complete mounting systems meet specifications JAN-C-172A. Mounting systems in JAN form factors and special designs are available—write today for full engineering data.

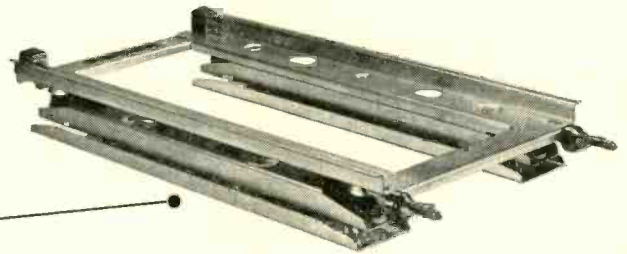

Dual Suspension Mounting Base—provides the ultimate in isolation efficiency. Dual Suspension Mounting Bases are specified for the ART-13, ARC-1, ARC-12 and many other widely known airborne equipments. More than two hundred thousand of these bases have been delivered to the armed services and commercial companies.

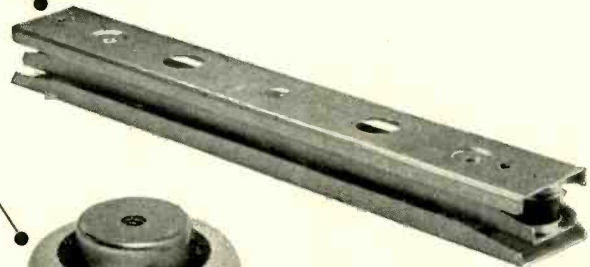

Dual Suspension and Single Stage Beam Assemblies—for direct attachment to equipment or mounting trays.



Cup Type Mount, providing performance and balanced equipment protection for sub-base mounting systems.

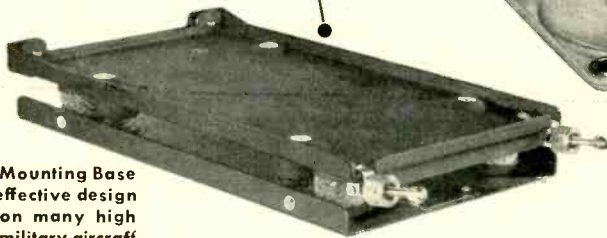

Single Stage Mounting Base—a rugged, effective design now in use on many high performance military aircraft to protect vital equipment.

ROBINSON AVIATION INC.

TETERBORO, NEW JERSEY

Vibration Control Engineers

The Development of CARBONYL IRON POWDERS

Carbonyl Iron Powder is an extremely pure form of iron, the metal content being over 99.99% iron, produced in the form of almost perfect spheres only one to fifteen microns in diameter—the average diameter being 8 microns (.00032 inches). It has been produced commercially for some years, primarily for use in magnetic cores for electronic equipment. Its production is therefore now under perfect control to give absolute reliability in quality and properties.

The production of Iron Carbonyl, from which Carbonyl Iron Powders are made, depends on a unique reaction, which was discovered in 1890 by the distinguished British chemist, Sir Ludwig Mond. When iron is treated with carbon monoxide it reacts to form iron pentacarbonyl, a rare case of a liquid compound of a metal. Each atom of iron combines with five molecules of carbon monoxide to give a compound with the formula $Fe(CO)_5$. This reaction leaves behind any impurities in the original iron.

This liquid is vaporized and the vapor heated above 200°C, when it decomposes into its constituents. The carbon monoxide is driven off and the iron separates from the vapor phase, first in the form of free atoms, then as ultramicroscopic crystals, finally as microscopic, almost perfect spheres. The particle size distribution can be controlled by temperature, pressure and other operating conditions.

Controlled purity and distribution of particle size is essential for use of the powder in electronics, where minor

variations in these properties have exaggerated consequences in delicate electrical and magnetic effects.

The only other elements present are non-metals such as carbon, oxygen and nitrogen. In G A & F Carbonyl Iron

Powder, they amount to not more than 0.8% carbon, 0.9% oxygen and 0.7% nitrogen.

The first large-scale production of Iron Carbonyl was undertaken in Germany shortly after 1920. By 1928 the process had been adapted to the continuous commercial production of Carbonyl Iron Powder. Subsequently, detailed studies and meticulous laboratory-type controls in the plant permitted accurate regulation of purity and particle size for the needs of the modern electronic industry.

The first commercial Carbonyl Iron plant in the United States was opened at Grasselli, N. J., in 1941 by the General Aniline & Film Corporation, primarily to meet the large wartime demand for electronic equipment. Newer and finer grades of the powder were developed for use in high-frequency electronic equipment for radar and television. Later a second plant was put into operation at Huntsville, Alabama.

Thus the G A & F Carbonyl Iron Process is now well established and in steady operation. It is an outstanding case of the successful precision control of a sensitive chemical reaction to produce a unique material that must meet extraordinary specifications of purity, particle shape and size, and uniformity.

Write today for a free book—fully illustrated with performance charts and application data. It will help radio engineers or electronics manufacturers to step up quality, while saving real money. Kindly address your request to Dept. # 69.

These unique properties tell why G A & F® Carbonyl Iron Powders are superior:

PROPERTY • ADVANTAGE

Spherical structure . . .	Facilitates insulation and compacting
Concentric shell structure (some types only) . . .	Low eddy current losses
High iron content . . .	Exceptional permeability and compressibility
Absence of non-ferrous metals . . .	Absence of corresponding disturbing influences
Relative absence of internal stress; regular crystal structure . . .	Low hysteresis loss
Spheres of small size . . .	Low eddy current losses; usable for high frequencies
Variations of sphere size . . .	Extremely close packing

ANTARA® PRODUCTS

DIVISION OF

GENERAL DYESTUFF CORPORATION

435 HUDSON STREET • NEW YORK 14, N. Y.

G A & F® Carbonyl Iron Powders



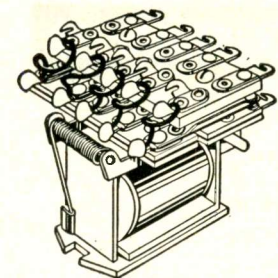

WANTED Tough Insulation Problems

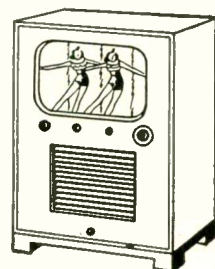
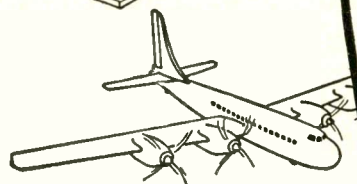
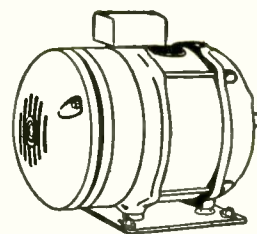

Put BH Fibreglas Sleeving or Tubing to work on tough insulation problems in your product or plant equipment and eliminate the possibilities of insulation breakdown. Whether the problem is excessive current load, vibration, extreme temperatures, greases, oils or moisture — or when flexi-

bility is essential — there is a BH product to solve it. Write for samples for laboratory and production testing. Include a few facts about your product, requirements, voltages and temperatures encountered. Let BH Fibreglas insulations do a better job for you. BENTLEY HARRIS MFG. CO., CONSHOHOCKEN, PA.

BH EXTRA FLEXIBLE FIBERGLAS SLEEVING

Remarkably flexible because no hardening varnish is used. Cuts without fraying and is non-combustible. Available in all colors. Basic sleeving withstands heat to 1200°F. Color unaffected up to 300°F.

BH SPECIAL TREATED FIBERGLAS SLEEVING

Heat resistant to 1200°F. Supplied in natural color only. Where colors are required, specify BH Extra Flexible. Cuts clean. Maximum flexibility. Unsaturated. Also available in 1/32" and 1/16" minimum wall.

OTHER BH FIBERGLAS PRODUCTS

Ben Har Special Treated Fibreglas Tubing: available in Grade A-1 — 7000V and Grade B-1 — 4000V. Flexibility combined with toughness. *Saturated Fibreglas Sleeving:* available in Grades C-1, C-2 and C-3. Special treated to prevent fraying.

BH "649"

A superior Fibreglas insulation at the price of ordinary cotton-base or rayon-base insulations. Available in Grades A-1, B-1, C-1. In all sizes from No. 24 to 5/8" inclusive.

Retains rated dielectric strength even after rough handling, severe bending. Often a less expensive grade of insulation can be used since there is little or no loss of dielectric strength in assembly or product use.

Non-burning, non-fraying, non-stiffening. Retains its remarkable flexibility in these heat endurance tests—15 minutes at 425-450° F., 24 hours at 302° F., 1500 hours at 220-230° F.

BH RAYON OR COTTON-BASE SLEEVING AND TUBING

Tubing: Magneto Varnished Tubing Grade "A-2"; Flexible Varnished Tubing Grade "B-2". *Sleeving:* Saturated Sleeving Grades C-1, C-2, C-3.



KNOT IT . . . Take a length of BH "649". Knot it. Pull it as tight as you can. Twist it. Then loosen the knot. There is no cracking. No change in the dielectric strength.

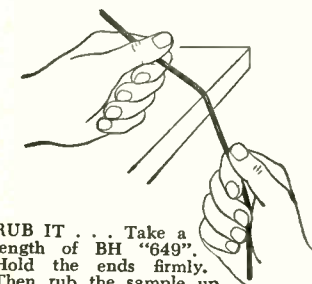

RUB IT . . . Take a length of BH "649". Hold the ends firmly. Then rub the sample up and down briskly in a sawing motion against the edge of a desk or chair. See how difficult it is to damage the coating.

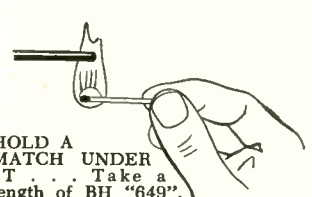

HOLD A MATCH UNDER IT . . . Take a length of BH "649". Hold a lighted match under it. BH "649" will not support combustion.

BH Fibreglas* SLEEVINGS

*BH Non-Fraying Fibreglas Sleeveings are made by an exclusive Bentley, Harris process (U. S. Pat. No. 2393530). "Fibreglas" is Reg. TM of Owens-Corning Fibreglas Corp.

Bentley, Harris Mfg. Co., Dept. E-13 Conshohocken, Pa.

COUPON

I am interested in BH Fibreglas Insulations _____ for _____ (size or I.D.) _____ operating at temperatures of _____°F. at _____ volts. Send samples _____ (product) so I can see how BH Fibreglas Sleeving stays flexible as string, will not crack when bent. NAME _____ COMPANY _____ ADDRESS _____

Send samples, pamphlet and prices on other BH Products as follows:

Cotton or Rayon-base Sleeving and Tubing

SIGNAL GENERATORS · BRIDGES · V.T. VOLTMETERS · Q-METERS
 AM · TV · RADAR · TELECOMMUNICATIONS · INDUSTRY

SIGNAL GENERATORS

WAVE
 AM

FOR YOUR BOOKSHELF . . .

SIGNAL GENERATORS · BRIDGES

WAVEMETERS · OUTPUT

AM · TV · RADAR · FM

SIGNAL · INDUSTRY

WAVE · Q-METERS

AM · TV · RADAR · FM

SIGNAL · MEDICINE

WAVEME · Q-METERS

AM · TV · RADAR · FM

SIGNAL G · MEDICINE

WAVEMETE · Q-METERS

AM · TV · RADAR · FM

SIGNAL GEN · MEDICINE

WAVEMETERS · Q-METERS

AM · TV · RADAR · FM

BRIDGES · V · MEDICINE

TELECOMMUNI · Q-METERS

OUTPUT METER · TELECOMMUNICATIONS

FACTORS



MASTERY OF MEASUREMENT

Marconi mastery of measurement is turned to account in a wide range of radio communication and allied measuring instruments. Embodying the skill born of years of experience, they nevertheless employ the latest techniques in circuits and contemporary styling. Write now for your copy of this 70 page, fully illustrated catalogue and find how the 30 preferred instruments can help you.

MARCONI INSTRUMENTS
 23-25 Beaver Street, New York, 4

CANADA: CANADIAN MARCONI CO., MARCONI BUILDING, 2442 TRENTON AVENUE, MONTREAL.
 ENGLAND: MARCONI INSTRUMENTS LTD., ST. ALBANS, HERTS.

OFFICIALLY APPROVED
 by the Nation's Foremost
ELECTRONIC MANUFACTURERS!

ANCHOR

★ EXCEEDS
 ASTM
 Specifications

★ Conforms with
 JAN (AN-S-62)
 Specifications

Activated Rosin-Core SOLDER

The SHURFLO Rosin: Speeds up solder flow 25%. Spreads as much as 30% further than ordinary rosin. Has superior wetting and oxide-removing action. Is non-corrosive, non-conductive, safe. Gives no unpleasant odor. Does not carbonize.

Specially designed for all electronic needs. Makes perfect joints to common and difficult metals. 30% more economical to use. Supplied in 1, 5, 20 lb. spools—gauges are fine as 0.020".

SEND NOW for generous **FREE SAMPLE** and **CATALOG EBG**

ANCHOR METAL COMPANY
 87 Walker St., N. Y. 13, N. Y.
 Phone WAlker 5-2569

a plus feature

Immediately following the
 Product Listings in the
DIRECTORY SECTION
 of this Issue
 is a list of more than

2500
TRADE NAMES
 of electronic and
 allied products.

They are intended for
 your use in determining
 the manufacturer's name
 when only
 a trade name is known.

Meissner

TRU SONIC

Victoreen

American Beauty

CLAROSTAT



hallicrafters



Eimac TUBES

THORDARSON

Jensen

AMPHENDL



Rauland



Belden

AEROVOX



SPRAGUE

GARRARD

RAYTHEON

MALLORY



Vector



OHMITE



Simpson JOHNSON

ASTATIC



B&W

EVEREADY



alliance

ALTEC



Pickering



KRAEUTER

Biley CRYSTALS



GREENLEE

WELLER ELECTRIC CORP.

ALPHA

TERMINAL

RADIO CORPORATION

Distributors of Radio & Electronic Equipment
85 CORTLANDT STREET
NEW YORK 7, N. Y. Phone: WOrth 4-3311



3M COMPANY

SHURE

SANGAMO

ElectroVoice

BURGESS

HICKOK

distributors
are known
by the products
they handle



RADIATION MEASURING INSTRUMENTS

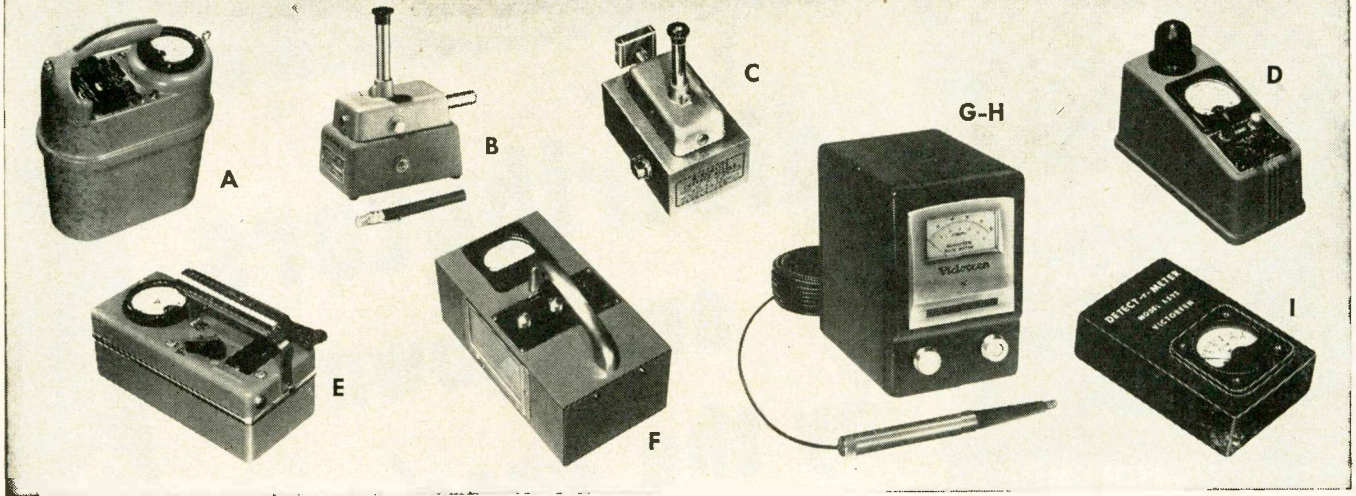

FIG. A. 247 SERIES.

A rugged, compact, ion-chamber type of gamma radiation survey meter. This stable and accurate instrument measures a wide range of intensities of radiation. Models 247C and D have a removable door in the bottom of the case to permit response to longer wavelength or lower energy radiation. The four ranges of sensitivity are color coded for ease of identification. The meter reads directly in milli-roentgens per hour. Complete with batteries, shoulder carrying strap, and instruction manual. Wt. 12 lbs. Size: 10" x 5" x 13". Shpg. wt., 15 lbs.

Model	Ranges of Sensitivity (milli-roentgens per hour)
247A	0-2.5, 0-25, 0-250, 0-25000
247B	0-5, 0-50, 0-500, 0-5000
247C	0-2.5, 0-25, 0-250, 0-25000
removable door	
247D	0-5, 0-50, 0-500, 0-5000
removable door	
247E	0-250, 0-2500, 0-25,000, 0-250,000

FIG. B. MODEL 287-MINOMETER.

A simple, efficient and accurate instrument for measuring stray radiation and extremely small gamma and x-ray quantities. Designed to aid in protecting medical and laboratory personnel who are exposed to gamma or x-ray radiation. Equipment includes the minometer charger-reader and a 0.2 roentgen pocket ionization chamber. The chamber is similar to a fountain pen in shape and size, with a pocket clip for easy carrying. The 0.1, 0.01 and 0.001 r chambers can also be supplied. Complete with Minometer, 0.2 r pocket chamber and instruction manual. Shpg. wt. 5 lbs.

FIG. C. MODEL 392-MINOMETER.

A pocket chamber and battery operated charger-reader for the measurement of large gamma or x-ray dosage. The Model 392 charger-reader is self contained and is adapted for use with either the 0-100 r or 0-200 r chamber. Designed for use in situations where there is risk of personnel receiving large doses of gamma or x-ray radiation. The pocket chamber resembling a fountain pen has a clip for easy carrying. The Minometer uses standard batteries. Size of Minometer, 8 x 5 x 9". Complete with batteries and instruction manual. Shpg. wt., 5 lbs.

FIG. D. MODEL 300-PROTEXIMETER.

An instrument to measure the accumulation of scattered gamma or x-ray radiation. The meter

indicates milli-roentgens directly with a full scale reading of 200. Applications are in radiation laboratories, industrial and therapeutic x-ray installations, and where radiation is present. Uses standard flashlight batteries which require infrequent changing. Complete with instruction manual, batteries, and one chamber. Size: 9 x 4 x 5". Shpg. wt., 12 lbs.

FIG. E. MODEL 389-THYAC.

A portable geiger counter survey meter for the laboratory and field. Three ranges of sensitivity: 0-800, 0-8000, and 0-80,000 counts per minute or 0-0.2, 0-2, and 0-20 milliroentgens per hour. Sensitive to beta and gamma radiation. Indication by earphones or ratemeter. Uses a 1.3 v. RM-4 mercury cell and a 4.5 v. Eveready #736 battery. A low current vibrator power supply provides regulated high voltage for better accuracy. Complete with counter tube, earphones, carrying strap, batteries and instruction manual. Size: 10 x 5 x 7". Wt. 5½ lbs. Shpg. wt., 12 lbs.

FIG. F. MODEL 356-PORTABLE SURVEY RATEMETER.

This lightweight, portable ionization chamber type instrument was designed for detecting and measuring alpha radiation. It is especially suited for detecting alpha contamination on benches, desks, tables and similar surfaces. The chamber, located in the bottom of the instrument, is provided with a thin plastic window to allow the radiation to penetrate. There are two ranges of sensitivity, X 1 and X 10, selected by a range switch on the top. Uses standard batteries. Complete with batteries and instruction manual. Size: 10 x 5 x 7". Wt. 8 lbs. Shpg. wt., 10 lbs.

FIG. G. MODEL 524-ISOTOPE RATEMETER.

A laboratory-quality counting ratemeter for detecting and measuring alpha, beta and gamma radiation. A large illuminated meter allows accurate measurements. A six position sensitivity or counting rate control gives a wide choice of counting rates: 0-300, 0-1000, 0-3000, 0-10,000, 0-30,000 and 100,000 counts per minute. A time constant selector allows the operator to select a 0.5, 5 or 25 second time constant. Audible counting is provided by a speaker in the side of the case. The probe with its six foot cable comes equipped with a 1B85 counter tube. Instrument supplied with probe, cables, and instruction manual. Size: 10 x 7 x 8". Shpg. wt., 35 lbs.

FIG. H. MODEL 510-ROENTGEN RATEMETER.

An accurate instrument for continuously monitoring the intensity of x-ray beams or gamma radiation in roentgens-per-minute. An ionization cham-

ber is used on the tip of a 12" by 1" diam, ½ lb. probe. The probe is connected to the main chassis by a 40 ft. flexible cable. A range selector switch and zero set knob are the only controls on the chassis. The selection of the four scales: 0-3, 0-10, 0-30 and 0-100 roentgens per minute permits the operator to make all readings on the upper two-thirds or more accurate portion of the meter scale. Complete with standard probe, cable, instrument, and instruction manual. Shpg. wt., 35 lbs.

FIG. I. MODEL 523-DETECT-R-METER.

A pocket gamma survey meter designed for field measurement of radioactivity rates. Sensitivity of 0-25 roentgens per hour. Intended for a working party that must enter a contaminated area. Will aid in determining the best path to be taken and length of time that party should remain in the area. The instrument reads the radiation rate and not total dose. Uses standard hearing aid batteries which require infrequent replacement. Complete with batteries and operating instructions. Size: 3 x 4 x 1¼". Wt. 9 oz. Shpg. wt., 3 lbs.

FIG. J.

MODEL 521-CAROMETER.

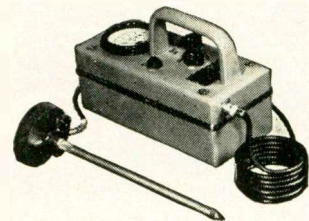

A compact, portable, sturdy instrument for the measurement of mechanical vibrations. Designed primarily for seismic or earth-shock measurements, it has many applications such as measuring mechanical vibrations in machines and buildings. The instrument reads the peak force or acceleration of the object being measured and holds this reading until reset to zero. It is essentially a peak reading voltmeter and may be used as such if the head is removed. Consists of a crystal probe or head with eight feet of cable and the instrument. The meter is calibrated directly in g's (units of acceleration). There is a range switch for the selection of the range: 0.1, 1.0, or 10 g's full scale, as well as a switch position for checking the condition of the batteries. A reset switch and zero position control are also provided. Uses standard batteries. Complete with crystal head, cable, carrying case for the head, instrument, batteries and instruction manual. Size: 10 x 5 x 7". Wt. 4 lbs. Shpg. wt., 10 lbs.



The Victoreen Instrument Co.

5806 HOUGH AVENUE
CLEVELAND 3, OHIO

SPECIALIZED INSTRUMENT COMPONENTS

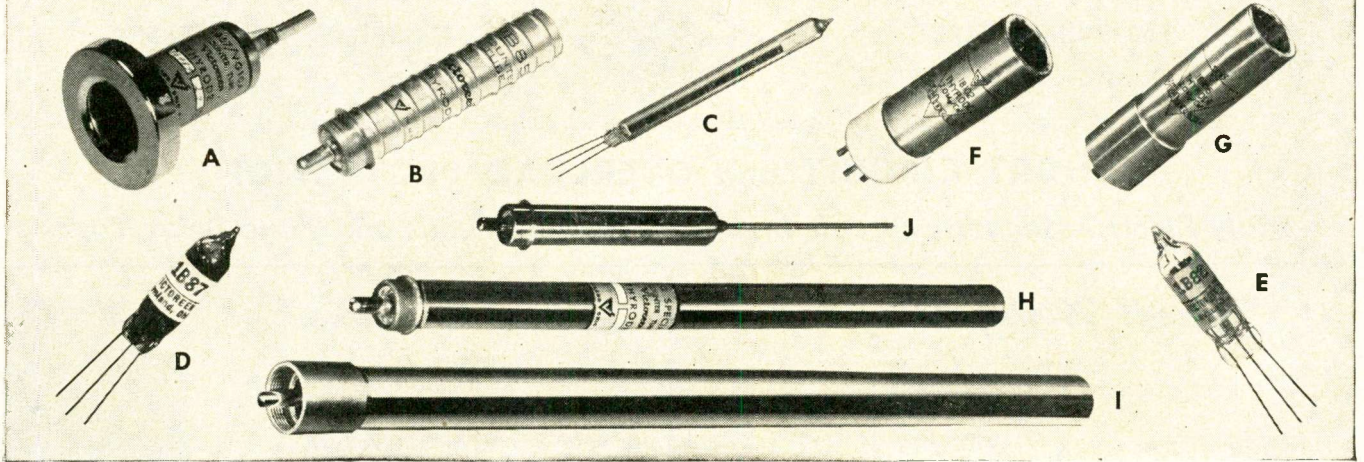

...COUNTER TUBES FOR EVERY PURPOSE

Fig.	Tube Type	Description	Operating Voltage	Threshold Voltage	Plateau Length	Plateau Slope per 100v	Active Length	Wall MG/CM ²	Life	Type Base	Shipping Weight	Price
A	1B67	Beta-Gamma Mica Window	1200	1100	200	5%	2.5"	2.0 to 2.6	10 ⁷	Leads	2 lb.	\$75.00
B	1B85	Beta-Gamma Aluminum Wall	900	800	200	3%	2.75"	30	10 ⁹	Coaxial	1 lb.	7.50
C	1B86	Miniature Gamma Glass Wall	300	280	60	10%	2.5"	200	5 x 10 ⁷	Leads	8 oz.	8.00
D	1B87	Sub-Miniature Gamma Glass Wall	900	850	100	10%/50v	0.5"	200	10 ⁸	Leads	8 oz.	8.00
E	1B88	Sub-Miniature Gamma Glass Wall	300	275	50	33%/50v	0.5"	200	5 x 10 ⁷	Leads	8 oz.	5.00
F	1B102	Beta-Gamma Mica Window	900	825	150	10%	1.7"	2	Unlimited by use	4 pin	2 lb.	60.00
G	1B106	Beta-Gamma Mica Window	900	825	150	10%	1.7"	2	Unlimited by use	Coaxial	2 lb.	60.00
H	1B124	Gamma Ray Chrome Brass	900	800	200	3%	12.5"	300	10 ⁹	Coaxial	2 lb.	30.00
I	1B125	Cosmic Ray Chrome Brass	900	800	200	3%	16"	300	10 ⁹	Coaxial	2 lb.	40.00
J	1B126	Needle Probe Chrome Brass	900	850	75	5%	10 mm	200	10 ⁸	Coaxial	2 lb.	100.00

... SUBMINIATURE ELECTRON TUBES



Tube Type	Typical Service	Volts E _{c1}	Volts E _{c2}	Volts E _b	μa I _b	μa	μmhos G _m	Grid current Signal grid	Price
*5800	Electrometer Tetrode	+3.4	-3	+4.5	12	1	15	3x10 ⁻¹⁵	\$12.50
*5803	Electrometer & D. C. Amp.	-1.7	...	+7.5	100	2.0	150	10 ⁻¹⁴	6.75
*5828	D. C. Amp.	-1.0	...	45	250	17.5	450	10 ⁻⁹	6.75
*5799	Half Wave Rectifier	Peak Inverse Voltage	Peak Plate Current	D. C. Output Current	Tube Voltage drop				
		3000v.	600μa	200μa	5.0v. (max.)	\$3.75			
		Striking Voltage	Regulating Voltage	Regulating Range	Max. Regulator Current				
5841	Corona Regulator	930	900	2.0-50.0 ma.	50 ma.	6.50			
5950	Corona Regulator	730	700	2.0-50.0 ma.	50 ma.	6.50			
VXR-130	Regulator	130	130	1.0-2.5 ma.	2.5 ma.	5.00			

*All filaments 1.25 volts at 10 ma

HI-MEG RESISTORS



For electrometer circuits where stability, accuracy, and high humidity operation are of prime consideration.

Characteristics
Resistance Range 10⁶ to 10¹⁴ ohms
Tolerance from labeled resistance
Temp. Coeff. ±1%
 .06 to 1.5%/C°
Volt. Coeff. -.02 to -.03%/V

STANDARD RESISTANCE VALUE	PRICE
10 ⁸ Ohms	100 Megohms \$ 4.50
10 ⁹ Ohms	1,000 Megohms 5.50
10 ¹⁰ Ohms	10,000 Megohms 5.50
10 ¹¹ Ohms	100,000 Megohms 5.50
5x10 ¹¹ Ohms	500,000 Megohms 7.50
10 ¹² Ohms	1,000,000 Megohms 12.00
10 ¹³ Ohms	10,000,000 Megohms 20.00
10 ¹⁴ Ohms	100,000,000 Megohms 25.00

Tolerances ±10% of Specified Value
For ±5% Tolerance From Specified Value, Add 10%
For ±2% Tolerance From Specified Value, Add 20%

Special Resistors Priced To Nearest Standard Value

The Victoreen Instrument Co.

5806 HOUGH AVENUE
CLEVELAND 3, OHIO



HEINEMANN ELECTRIC COMPANY

150 PLUM STREET



TRENTON, NEW JERSEY

Agents in Most Principal Cities

SHORT CIRCUIT and OVERLOAD PROTECTION

Fully Electro-Magnetic Circuit Breakers—Instantaneous and Time Delay Types

Typical Wiring Diagrams

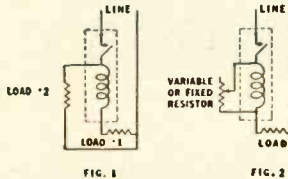

CALIBRATING TAP

Figure 1 illustrates two separate loads wired to a single pole calibrating tap Circuit Breaker. Both load #1 and load #2 are disconnected when an overload occurs in load #1.

Figure 2 illustrates the use of a variable or fixed resistor in parallel with the trip coil to gain an adjustable variation in the rating or different fixed ratings giving a wide range of calibration of the tripping point.

Innumerable combinations can be obtained by use of 2 and 3 pole Circuit Breakers.

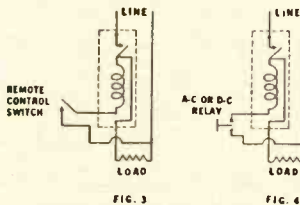

SHUNT TRIP

Figure 3 illustrates a shunt trip Circuit Breaker that can be tripped at some remote station.

Figure 4 illustrates a shunt trip Circuit Breaker that can be operated by an AC or DC relay operating a set of contacts upon which the line voltage is impressed.

These Circuit Breakers must be reclosed manually.

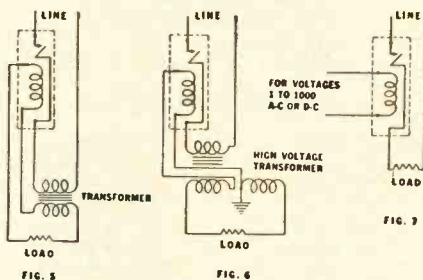

RELAY TRIP

Figure 5 illustrates a relay trip Circuit Breaker protecting a transformer by limiting the current in the secondary. When the Circuit Breaker is tripped the primary of the transformer is open circuited.

Figure 6 illustrates a relay trip Circuit Breaker protecting a high voltage transformer by having the relay coil inserted between the two secondary windings at the grounded terminal. When the Circuit Breaker is tripped the primary of the transformer is open circuited.

Figure 7 illustrates a relay trip Circuit Breaker operated by an independent source of current, either AC or DC, and for voltages of 1 to 1000.

Circuit Breakers

in ratings from 50 milliamperes to 50 amperes operating on circuits to 460 volts AC or 250 volts DC.

A complete line of circuit breakers furnished in both Instantaneous Trip and Time Delay types. The former trips instantly on short circuits and sudden overloads, opening the circuit even before an ammeter could indicate the amount of current.

The Time Delay Type also opens instantly on short circuits but eliminates unnecessary opening of the circuit on harmless overloads of short duration—such as that caused by inrush current when starting motor.

Time delay breakers are available in any one of 3 inverse time delays that match the characteristics of almost any circuit. The magnetic trip unit is hermetically sealed to prevent tampering. All breakers are calibrated, set and adjusted at the factory.

These breakers are available in single, two and three pole designs as illustrated; bakelite enclosed or in steel cabinets or explosion proof housings.

Send for NEW Catalog with complete engineering data.



1 Pole Breaker



2 Pole Breaker



3 Pole Breaker

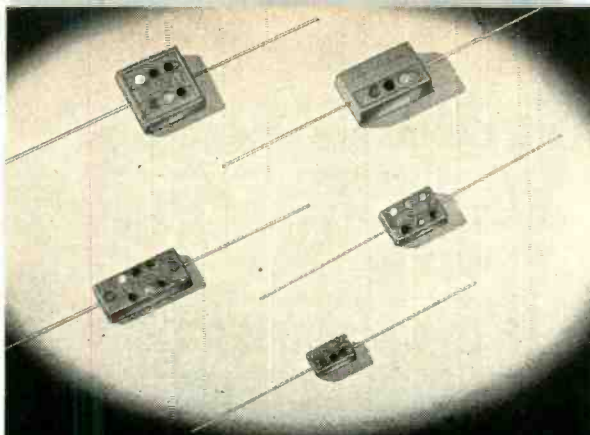

◀ **RECEIVER MICA**

Molded mica capacitors to meet either RTMA specifications, or MIL specification JAN-C-5.

TRANSMITTER MICA ▶

We can furnish most of the molded case types (as shown) of the capacitors listed under JAN-C-5.

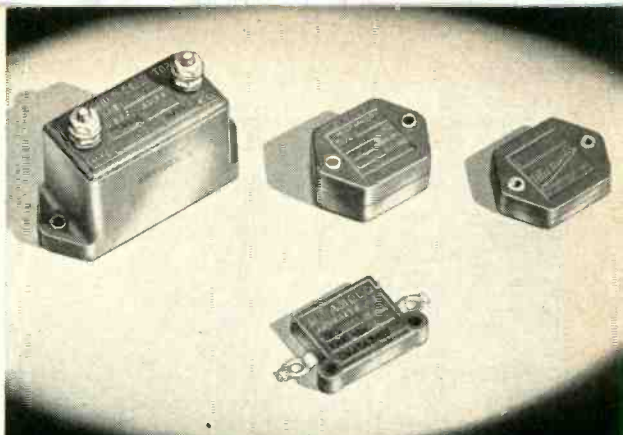

Micamold

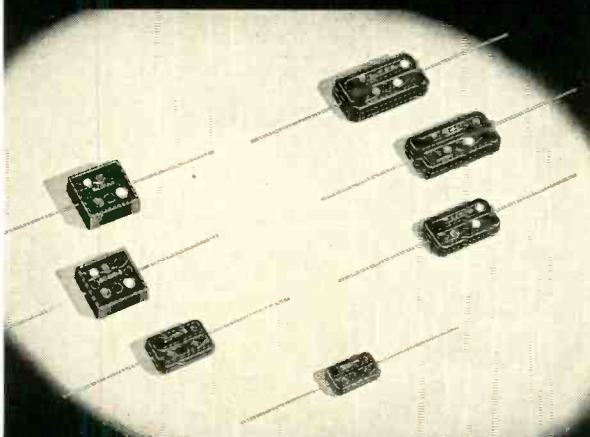

◀ **MOLDED PAPER**

We manufacture these capacitors in all case sizes, both to commercial specifications and MIL specification JAN-C-91.

SUBMINIATURE ▶

Solder sealed by glass bead headers to metal cases, in all standard capacities, voltage ratings, and temperature ranges including $-55^{\circ}\text{C}.$ to $+125^{\circ}\text{C}.$

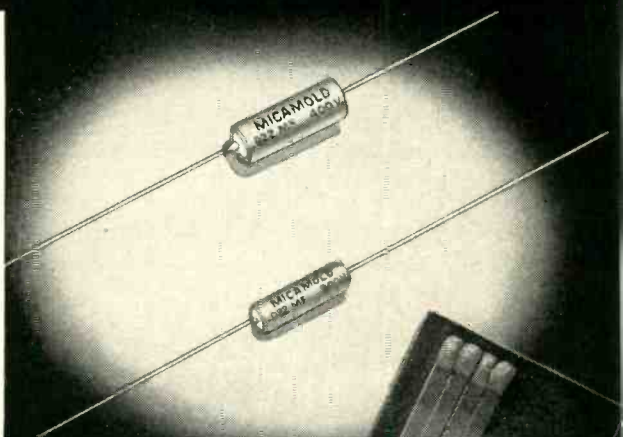

A Capacitor Leader for Over 25 Years Serving Commercial and Military Requirements

MICAMOLD manufactures a wide variety of standard and special types of capacitors for the industrial leaders in the radio, radar and electronics fields, as well as the armed forces.

MICAMOLD is prepared to develop and supply capacitors to meet unusual electrical and mechanical requirements for both commercial and military equipments. Also, radio

interference filters, pulse networks, small electronic assemblies, etc.

MICAMOLD factory and field engineers are ready to visit you promptly and work on your problems. We will appreciate your inquiries and gladly assist in your engineering designs and production plans.



MICAMOLD RADIO CORPORATION
1087 FLUSHING AVENUE, BROOKLYN 6, N. Y.

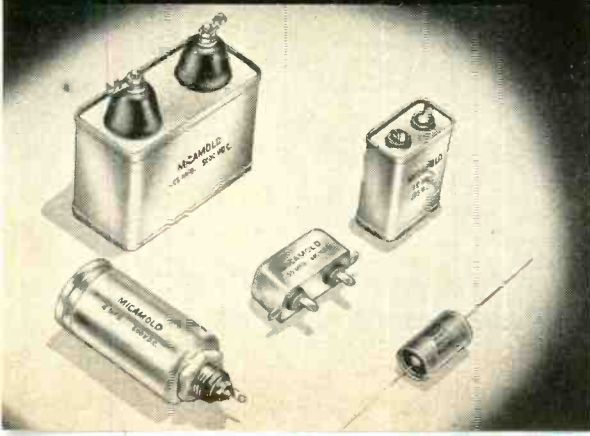

◀ **OIL FILLED**

All metal encased paper capacitors, as listed in MIL specification JAN-C-25, up to the 5000 VDC rating in the CP 70 case.

ELECTROLYTIC ▶

Manufactured to MIL specification JAN-C-62 and the RTMA specifications, including cardboard tubular types.





SMOOTH

ARALDITE RESINS used as smoothing compounds on bus bodies, train coaches, jet-type planes, etc. Hardens quickly . . . can be sanded . . . high alkali and acid resistance. Non-shrinking, deep indentations can be filled in one application.

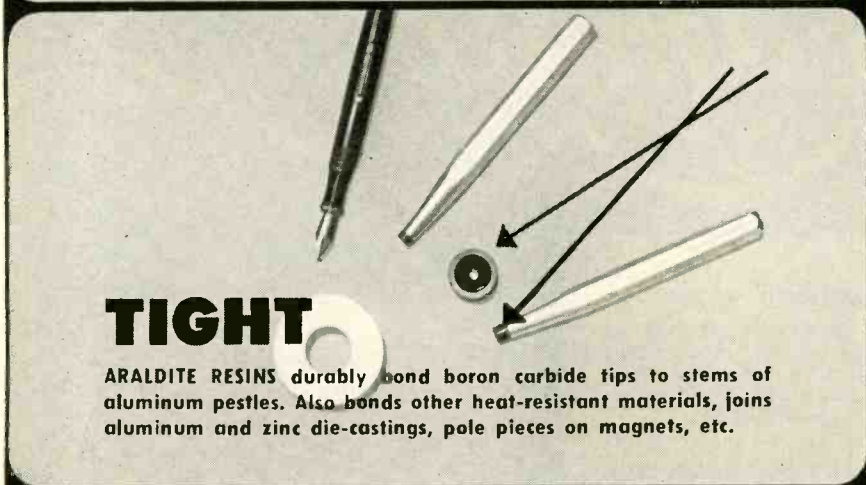

TIGHT

ARALDITE RESINS durably bond boron carbide tips to stems of aluminum pestles. Also bonds other heat-resistant materials, joins aluminum and zinc die-castings, pole pieces on magnets, etc.

 WITH **Araldite**^{*}
ETHOXYLINE RESINS

Fabricators seeking new, improved, simplified, time-and money saving bonding, casting and coating mediums, will find in these new but already extensively applied resins, an exceptional opportunity to put their ideas to work. Details of the properties and typical applications for Araldite Resins are fully described in newly published technical manuals, free upon request written on Company letterhead.

**Trade Mark of Ciba Company Inc.*



Giba

COMPANY INC.
PLASTICS DIVISION
627 GREENWICH ST.
NEW YORK 14, N.Y.

THE CLOSEST APPROACH

yet achieved to the ultimate in low noise, zero-drift and gain stability, for driving rugged meters and recorders direct from fractional- μ V inputs—

LISTON—FOLB

General-Motors Synchronous-Breaker Type

D-C AMPLIFIER



1. LOW NOISE LEVEL—approaches theoretical Johnson-Noise limit within factor of 2 or better.
2. HIGH ZERO STABILITY—0.005 μ V or better per 8 hours, for protracted accuracy of critical observations.
3. HIGH GAIN STABILITY—0.3% or better per 8 hours; 0.5% or better for line-voltage variations up to 10%.
4. HIGH GAIN—to actuate rugged meters and relays with fractional μ V inputs.
5. HIGH LINEARITY—output DC, same polarity as input; linear to 4V with 500-ohm load; to 14V with infinite-impedance meter.
6. LOW PRICE—other details on request.

LISTON-FOLB Instrument Co., Inc.

Department EB

Stamford, Connecticut, U. S. A.

Included in the
DIRECTORY SECTION
of this Issue
is a list of more than

850

DISTRIBUTORS OF
ELECTRONIC COMPONENTS

and

ELECTRONIC EQUIPMENT

They are ready and
willing to serve you.

When ordering, be sure
to mention the . . .

electronics
BUYERS'
GUIDE

HIGH VOLTAGE POWER SUPPLIES

MODEL PN-30
REVERSIBLE POLARITY Continuously VARIABLE 1-30 KV DC POWER SUPPLY
 A light, compact unit in wide use for insulation testing, precipitators and laboratory research. Polarity reversible from front panel. Current output—2 milliamperes at 20 KV; 250 microamperes at 30 KV. Input—110 V AC 60 cycles. Dimensions 14" x 11" x 12".

HIGH VOLTAGE POWER SUPPLIES

MODEL RG-30 CONTINUOUSLY VARIABLE 15-30 KV REGULATED DC POWER SUPPLY
 A high grade supply which incorporates a voltage tap in the range of 4 to 6 KV for use with 5WP4, 5TP4 and flying spot tubes. Regulations better than .5% at 1 milliampere. In wide use for theatre and transcription recording systems. Dimensions of HV unit—14" x 11" x 12". Separate low voltage DC Supply—14" x 6" x 8".

HIGH VOLTAGE POWER SUPPLIES

MODEL 2040
 VARIABLE 20-40 KV RF TYPE DC POWER SUPPLY

Ideal for TV, electrostatic paint spraying, insulation testing, etc. Current output—1 milliampere. Input—110 Volts AC 60 cycles. Dimensions 14" x 11" x 12"—Completely encased.

HIGH VOLTAGE POWER SUPPLIES

MODEL RG-15
 CONTINUOUSLY VARIABLE 5-15 KV REGULATED DC POWER SUPPLY

A compact well-built laboratory type of supply. Regulations at .1% at 1 milliampere. Low ripple content. Dimensions 14" x 11" x 12".

HIGH VOLTAGE POWER SUPPLIES

MODEL 4575

4½ KV POWER SUPPLY
 Complete Voltage Range—from 1 KV to 7½ KV.
 Current output—1 milliampere
 Input—250 Volts DC—50 milliamperes
 Dimensions—5½" x 4½" x 5"

PROJECTION EQUIPMENT FOR TV AND RADAR

- Plastic Rear Projection Screens
- Schmidt Optical Systems
- Projection Lenses

HIGH VOLTAGE RF STEP-UP COILS

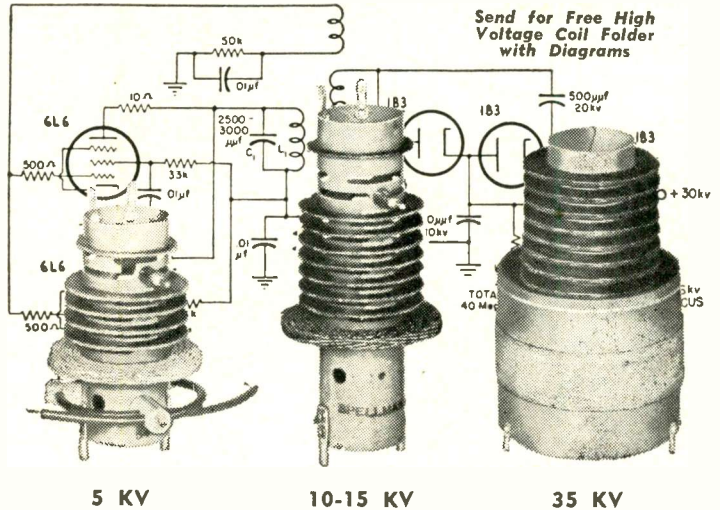

Send for Free High Voltage Coil Folder with Diagrams

5 KV	DIMENSIONS:		
	Secondary Height	3½"	Secondary Voltage Output 5 KV
	Secondary Windings	1¾"	Secondary Current 2 Milliamperes
	consisting of 4 Pie Windings		Approx. Frequency 175 KC
	Primary Diameter	2¼"	\$3.70 each
10-15 KV	DIMENSIONS:		
	Secondary Height	5¼"	Secondary Voltage Output 10-15 KV
	Secondary Windings	1¾"	Secondary Current 2 Milliamperes
	consisting of 7 Pie Windings		Approx. Frequency 175 KC
	Diameter	2½"	\$9.30 each
35 KV	DIMENSIONS:		
	Secondary Height	7"	Secondary Voltage Output
	Secondary Windings	3" dia.	35 Killovolts
	consisting of 10 Pie Windings		Secondary Current 5 Milliamperes
	Primary (separate from secondary)		Approx. Frequency 70 KC
	Height	4"	\$42.00 each
	Diameter	4¼"	25 KV—Same as 35 KV except
			Secondary Ht. 6"
			\$36.00 each



RF FILAMENT TRANSFORMERS

A self-resonant auto transformer for use with type 1B3 Rectifier tube. Will operate with Spellman HV coils. \$1.08
 TUNING PADDER for Filament Transformer. \$48c

NEW HIGH VOLTAGE FILAMENT TRANSFORMERS

Good for voltage ranges up to 100 KV

A spun metal corona shield which houses both socket and filament winding. A separate loop will operate 1B3 or 5825 tubes at distances in excess of 10". Full particulars in Spellman coil folder.

ALSO AVAILABLE:
 1B3 Type Tube net \$1.40 each
 5825 Type Tube net \$13.00 each
 500 MMFD. CENTRALAB
 20 KV Condensers net \$1.32 each
 30 KV Condensers net \$2.70 each

HIGH VOLTAGE UNIT WITH CHARGING ANODE FOR ELECTROSTATIC PAINT SPRAYING, COLLECTING DUST AND FUME SPECIMENS, ETC.

SPELLMAN custom builds regulated and unregulated RF types of DC Power Supplies in voltage ranges up to 100 KV. If you have a special requirement that needs quick action contact us.

SEND FOR DESCRIPTIVE LITERATURE
 including coil folder with High Voltage diagrams

SPELLMAN TELEVISION CO., INC. 3029 WEBSTER AVENUE
 BRONX, N. Y. Kingsbridge 7-0306

**CONTROLLED
QUALITY...**

**CUSTOM BUILT
FOR GOVERNMENT
AND INDUSTRY**

**TRANSFORMERS
REACTORS
RESONANT FILTERS**

Top Engineering and Workmanship

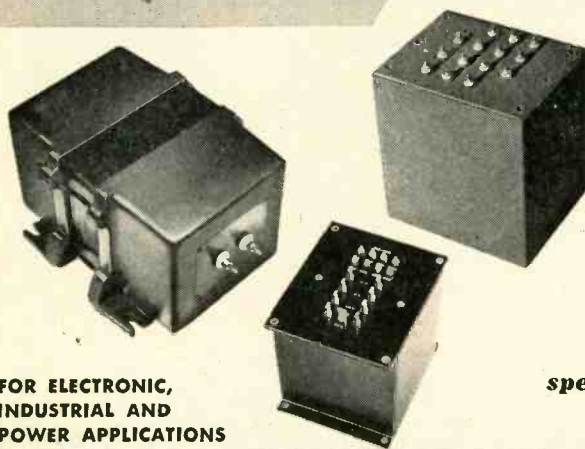

We have been solving the transformer engineering problems of government and industry since 1938!

Write or phone us regarding your special requirements.

FOR ELECTRONIC,
INDUSTRIAL AND
POWER APPLICATIONS

ELECTRONIC TRANSFORMER COMPANY, INC.
209 West 25th Street • WAtkins 4-0880 • New York 1, N. Y.

**MICRODIMENSIONAL
WIRE**

*Custom-
Enameled*

TO YOUR
SPECIFICATIONS

The enamel-insulation of our microdimensional wire meets the high standards of quality set by all our products. The enamel is uniform, tough, flexible and has high dielectric strength... Send us your specifications or inquire for further details.

Since 1901



SIGMUND COHN CORP. • 44 GOLD ST. NEW YORK 7

Hold on /
to this book

It will be
June 1952
before another
edition is published

IT IS THE MOST COMPLETE,
AUTHORITATIVE AND UP-TO-DATE
DIRECTORY OF ELECTRONIC AND
ALLIED PRODUCTS AVAILABLE.

It gives you the manu-
facturers of each of
more than fourteen
hundred electronic
and allied products.



... gives you information
as to where they are in pro-
duction or available in a
reasonable time and unre-
stricted for general indus-
trial use.

1951-1952

**electronics
BUYERS'
GUIDE**

Please mention this book when
buying or inquiring from it.

FASTENINGS for every need in electronic gear

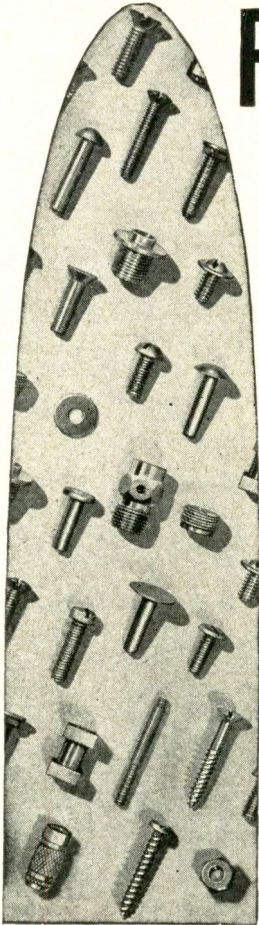

When you make Blake & Johnson your headquarters for small fastening devices, you benefit by more than a hundred years of manufacturing know-how. Since 1849, Blake & Johnson has been recognized as a dependable, one-stop source for all types of fasteners—in steel, stainless steel, copper, brass, bronze, everdur, nickel, nickel silver, monel, and aluminum.

STANDARD MACHINE SCREWS

Blake & Johnson Standard Machine Screws are available in flat, round, oval, fillister, hexagon, binding, pan, truss and unslotted (special) heads. Threads per inch range from 16-64; lengths, 1/8"-3". In steel or brass.

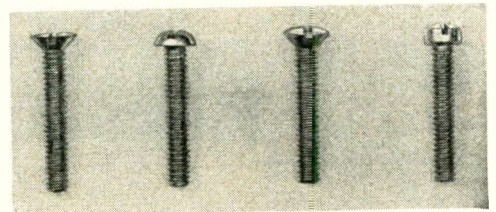

Typical B.&J. Machine Screws

MACHINE SCREW NUTS

Manufactured in steel or brass with coarse (16-56) and fine (24-64) threads. Width across flats—3/16" to 5/8". Hexagon or square. Nuts may be plated in nickel, brass, copper, cadmium, electro-galvanizing or zinc plate, bluing and parkerizing. Special finishes also available.

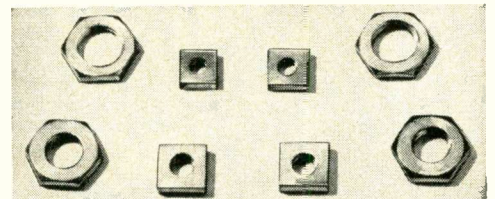

Typical B.&J. Machine Screw Nuts

TWIN-FAST WOOD SCREWS

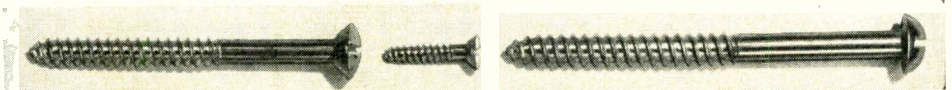

A twin thread screw for faster production—stronger fastening. Twin-Fast screws present 4 major improvements:
1. Relieved Shank Diameter—eliminates danger of setting up stresses that cause fractures or ruptures, assures perfect alignment. 2. Twin Threads—provide greater thread pitch. Cuts fastening time in half.

3. Cylindrical Construction—provides greater strength—more thread area. Holding power far exceeds that of ordinary tapered screws.
4. Single, Centered Point—specially designed twin threads terminate in a single, centered point where the two cutting blades meet. Screw bites into wood at first pressure and drives straight.

TAPPING SCREWS

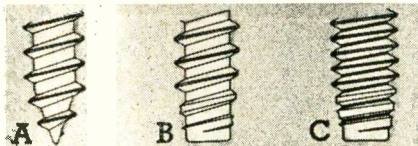

Available in three types shown above with flat, round, oval, truss, pan and hexagon heads. 1/8" to 2" in length with either plain or plated finish. Threads per inch range from: Type A, 32-9; Type B, 32-12; Type C, 24 to 40. Thread angle 60° included.

SPECIAL WIRE FORMS

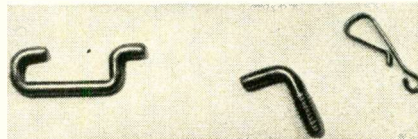

Typical of our manufacturing versatility is a line of special forms, for diverse industries, made from ferrous and non-ferrous wire, in such shapes as bent wires, threaded rods, eye bolts, "U" bolts, dowels, winder keys, and many others.

SPECIAL HEAD PRODUCTS

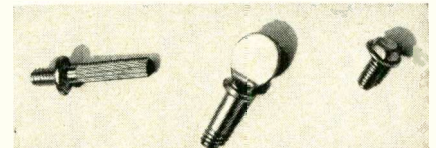

Our long manufacturing experience has made the company name and the term "Cold Heading Specialists" synonymous. In addition to our regular line of standard screws and bolts, production items of irregularly shaped heads are made special-to-order.

PHILLIPS HEAD Blake & Johnson standard machine screws, Twin-Fast wood screws, and tapping screws are available with Phillips head. They are manufactured in the various shape heads mentioned above and are either plain or plated finish. Metals include brass and steel.

FASTENERS TO SPECIFICATIONS

Our engineers are always glad to work with yours to help select or develop the fastening that provides quickest application, greatest holding power and soundest economy for your particular needs.



Send For Catalog

The Blake & Johnson fastenings catalog is complete in every detail—includes extensive technical information and prices. Send request on your company letterhead. Address Dept. G.

1849-1951

BLAKE & JOHNSON
Fastenings

THE BLAKE & JOHNSON COMPANY, WATERVILLE 48, CONN.

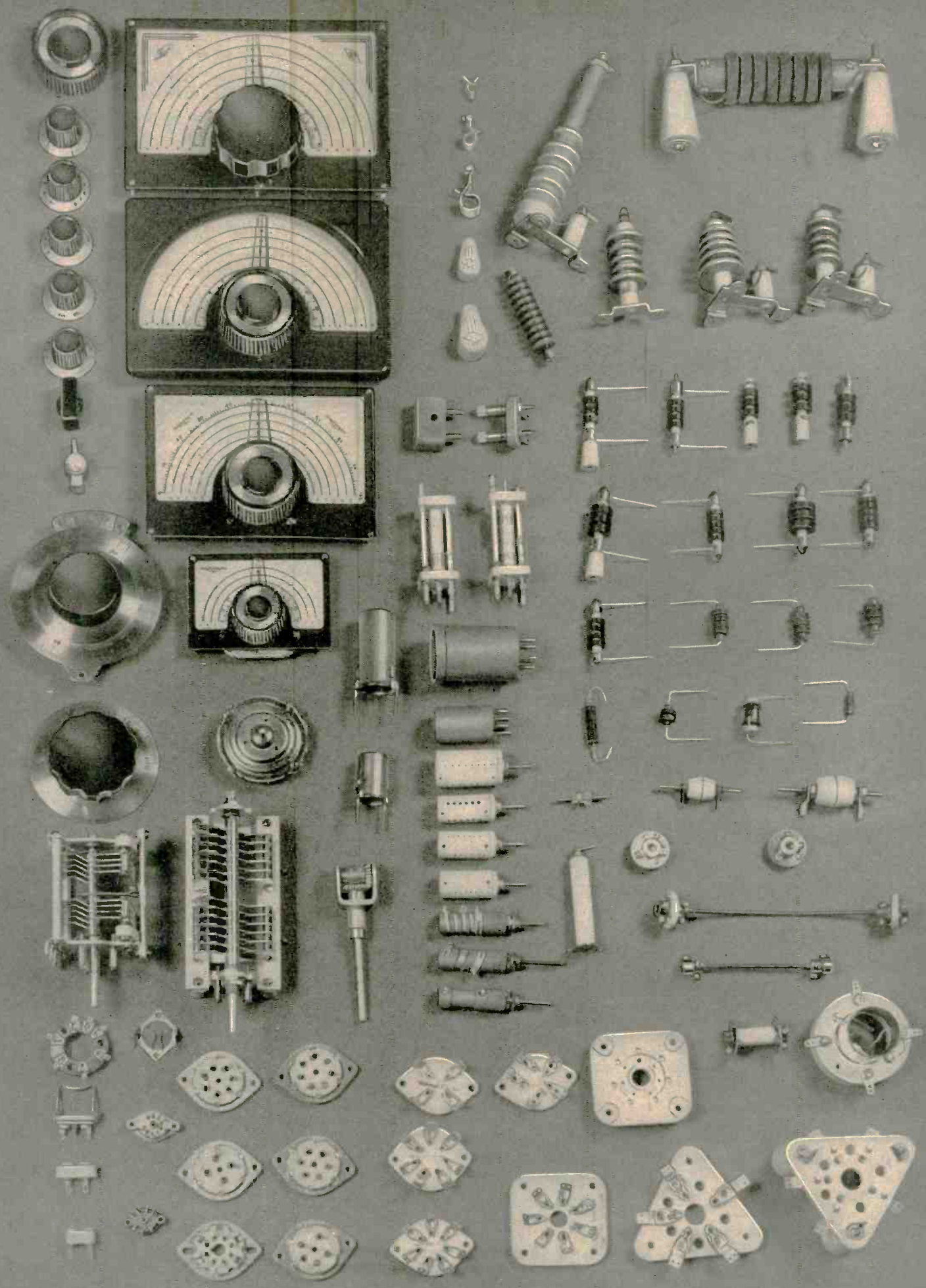

Famous



Components.

Coils High-Q, permeability tuned RF coils on low loss mica filled bakelite forms. Coils tune from 75 mc to 220 mc with capacities from 100 to 10 mmfd and from 37 mc to 110 mc with capacities from 100 to 10 mmfd. Inductive windings supplied may be replaced by other windings as desired to modify the tuning range.

Coil Forms Both bakelite and high-grade ceramic coil forms for a wide variety of uses. Many grooved for windings to provide permeability tuned coils. Meet JAN specifications.

Grid Grips and Plate Caps National safety grid and plate caps have a ceramic body which offers protection against high voltage caps on tubes. They provide secure and positive contact with tube caps, yet are easily released.

Terminals A wide variety of high quality molded bakelite and Victron terminals are available to meet every need. They have been engineered to meet a wide variety of practical applications.

Shafts and Shaft Couplings National Company makes flexible couplings and shafts for practically every requirement. Features of the various types include steatite insulation; angle connections up to 90°; excellent electrical connections between coupled shafts; elimination of adjustments for radial misalignment. Most types fit 1/4" shafts.

RF Chokes Regardless of the most rigid requirements, we have both the facilities and engineering staff for the quantity production of RF chokes of practically any type. Exceptionally close tolerances are guaranteed. Send us your specs for prices and delivery date.

Dials and Knobs National dials and knobs, having wide applications, are famous for practical design, rugged construction and smart appearance. Patented types include planetary and gear drives. Special colors can be supplied in quantity.

Vernier Mechanisms TYPE AN A vernier mechanism ratio 5-1 has an insulated output shaft coupling for 1/4" shafts. Drive shaft fits 3/16" knob. TYPE AVD Similar to AN. Output shaft coupling is non-insulated. There are many variations of the above types available for use in commercial or industrial applications. Complete details will be provided upon request.

Sockets High-quality steatite sockets for every application and tube type. Exclusive design and construction assure exceptionally good contacts and high current capacity.

Miniature Sockets and Shields 7-9 pin miniature tube sockets designed to meet rigid government and commercial requirements. Tube shields for both 7 and 9 pin sockets. Bases for shields available with spade bolts or holes for flush mounting. Either ceramic or mica-filled bakelite. Provide short leads and low inductance in uhf design. Silver plated beryllium copper contacts.

Miniature Tube Clamps Easy to assemble — just two pieces — a spring clip and a base of stainless steel. Base mounts in same holes, using same screws or rivets, as sockets. Easy to remove tube, simply snap off spring clip. Made to government specifications. Types available for all standard miniature tubes.

Crystal Sockets Crystal mounting sockets for crystal holders with mounting pins spaced 0.5000", 0.486" and .750" and pin dia. of 1/8", 3/32" and 1/8". Steatite insulation. Single screw mountings for all models.

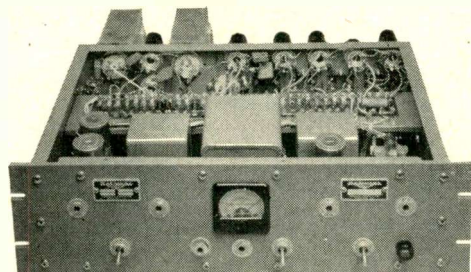

SCR-3B Single-Channel Receiver

Commercial Electronic Equipment

The National Company has designed and built many types of electronic equipment to rigid specifications for military, scientific and commercial purposes. The U. S. Navy and the nation's largest airports are among the many users of National equipment. Send inquiries to the Commercial Division

ADDRESS EXPORT INQUIRIES TO EXPORT DIV., DEPT. BG—51

WRITE FOR COMPLETE CATALOG AND SPECIFICATIONS OF
COMMUNICATION RECEIVERS • COMPONENTS • TELEVISION SETS

NATIONAL COMPANY, INC. 61 Sherman St., Malden, Mass.

PHALO

For All Your Electronic Wire Requirements!

TRANSMISSION LINE CABLES

Applications

72-Ohm cable for use with receiving antennas—high frequency.

100-Ohm cable for use with receiving antenna, link connection, matching transformer. Also for experimental use at high frequency.

150-Ohm cable for use with receiving antenna, matching transformer and high frequency experimental applications.

300-Ohm for use with FM and Television receiving antenna.

300-Ohm heavy-duty cable. Same applications as above and also for low power transmitting antenna.

300-Ohm shielded cable. FM and Television lead adaptable to noisy locations.

3, 4 & 5 Conductor Antenna rotator control cable.

75-Ohm cable for use with doublet receiving antenna—low frequencies.

Same as above with added shield to reduce noise pick-up.

72-Ohm coaxial cable for television antenna.

52-Ohm cable for pulse and radio frequency transmission, television.

75-Ohm coaxial low loss.

For extension speakers, control circuits and low frequency doublet receiving antenna.

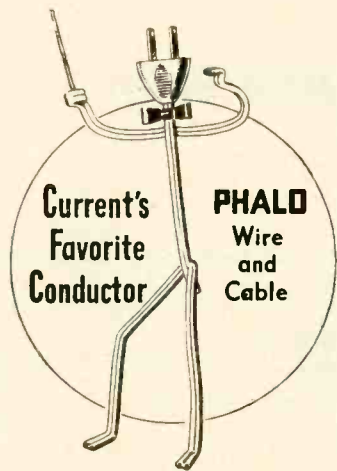

Multiple Conductor Paired and Unpaired Cables



For telephone and telegraph communication systems.

Microphone Cables



Cables for Intercommunicating and Public Address Systems



Three flexible stranded tinned copper conductors, vinyl plastic insulation; color-coded, cabled conductors; tinned copper braid shield; over-all cotton braid jacket.



One pair solid tinned copper conductors, vinyl plastic insulation, color coded; cabled construction; over-all cotton braid jacket.

PHALO Cord Sets

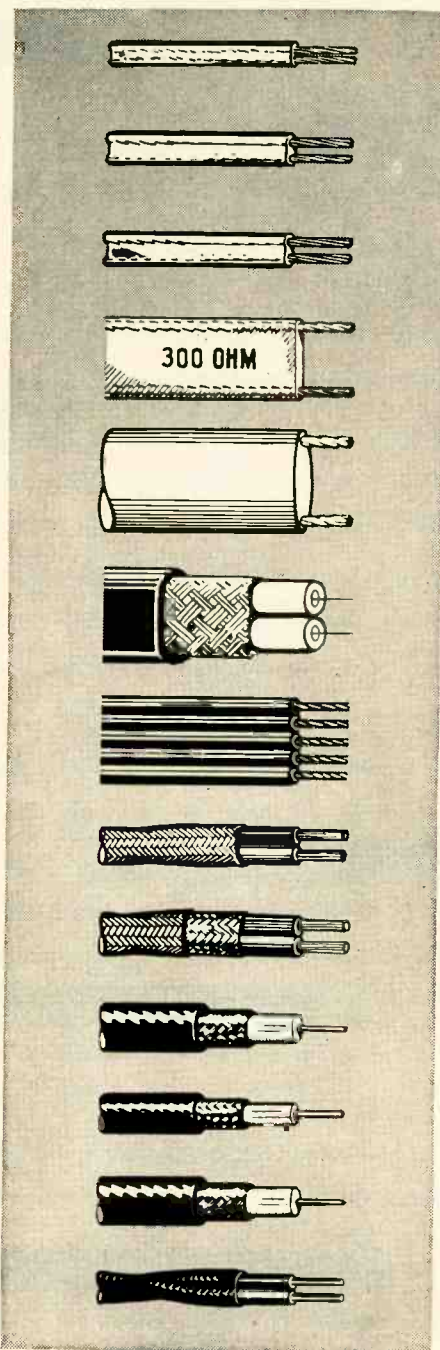
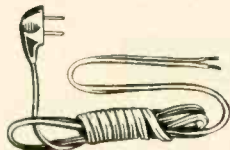

Cord Sets, Harness Assemblies, Special Assemblies, Multi-Conductor Cables, Shielded Wires for High Frequency Applications. PHALO for special wire requirements.

Hook up wires UL approved for 80°C, 90°C and 105°C operating temperatures.

Your Inquiries Will Receive Prompt Attention!

PHALO PLASTICS CORPORATION

Graphic Arts Building, Worcester, Massachusetts

Vector

SOCKET-TURRETS

A NEED FULFILLED

Vector Socket-Turrets are unique terminal structures whereby complete stage assemblies may be quickly, economically and compactly mounted with plug-in feature if desired.

SOCKET TYPES

CATALOG NUMBERS			HEIGHT	TURRET TERMINALS
Octal	7-Pin	9-Pin		
12-0-12	12-MB-12	12-NB-12	3"	12 (6 & 6 Spaced 1.87")
10-0-12	10-MB-12	10-NB-12	2 1/2"	12 (6 & 6 Spaced 1.37")
10-0-9T			2 1/2"	9 (6 & 3 Spaced 1.37")
8-0-12T	8-M-12T	8-N-12T	2"	12 (6 & 6 Spaced 1.0")
8-0-9T	8-M-9T	8-N-9T	2"	9 (6 & 3 Spaced 1.0")
6-0-6T	6-M-6T	6-N-6T	1 1/2"	6 (6 in single ring)

SHIELD BASES: #S7 for 7-pin and #S9 for noval sockets.

MILITARY TYPES: Add letter 'J' to catalog numbers for units with sockets similar to JAN types. Add 'G' for moisture and fungus impregnations.

SINGLE SOCKET PLUG-IN TYPES

CATALOG NUMBERS			CAN SIZE
Octal	7-Pin	9-Pin	
B-8-0	B-8-M	B-8-N	1.37" Sq. x 2.0"
B-10-0	B-10-M	B-10-N	1.37" Sq. x 2.5"
B-12-0	B-12-M	B-12-N	1.37" Sq. x 3.0"
C-8-0	C-8-M	C-8-N	2.0" Sq. x 2.0"
C-10-0	C-10-M	C-10-N	2.0" Sq. x 2.5"
C-12-0	C-12-M	C-12-N	2.0" Sq. x 3.0"

TWO SOCKET TYPES also available in 2" square (C Type) units add 'M' for second 7 pin socket or 'N' for 2nd 9 pin socket.

Combinations with can and plug only or can, plug and terminal turret only also available in above sizes.

Perforation of can for ventilation available. Add 'P' to number.

Types tabulated carry 8 prong mica-filled octal style plug. For 11 prong octal style plug add 'K' to catalog number. Other plug types to order.

PLUG-IN LOCKS (See figure) can be furnished which lock plug-in units to the chassis with a quarter turn of the handles at the top of the units. Handles also aid in withdrawal. To order add 'L' to catalog number and state chassis thickness.

SPECIAL PILOT PINS may be ordered which prevent plug-ins from being inserted in wrong socket. Add 'U' to catalog number for these and state pin orientation desired (as 1, 2, 3, 4, etc.)

SPECIALS to order, including anodized finishers, JAN type sockets, many can sizes, printed terminal designations, coil form mountings, etc.

Write For Catalog

Vector Electronic Company

1101 Riverside Drive
Los Angeles 31, California

REPRESENTATIVES

Anderson Sales Company, 172 State Street, Boston
John O. Olsen Company, 1456 Waterbury Road, Cleveland,
with branches in Pittsburgh, Columbus, Cincinnati
B. B. Taylor Company, 150 Broadway, New York
R. J. Magnuson, 2323 W. Devon Avenue, Chicago
David H. Ross Company, 1355 Market Street, San Francisco

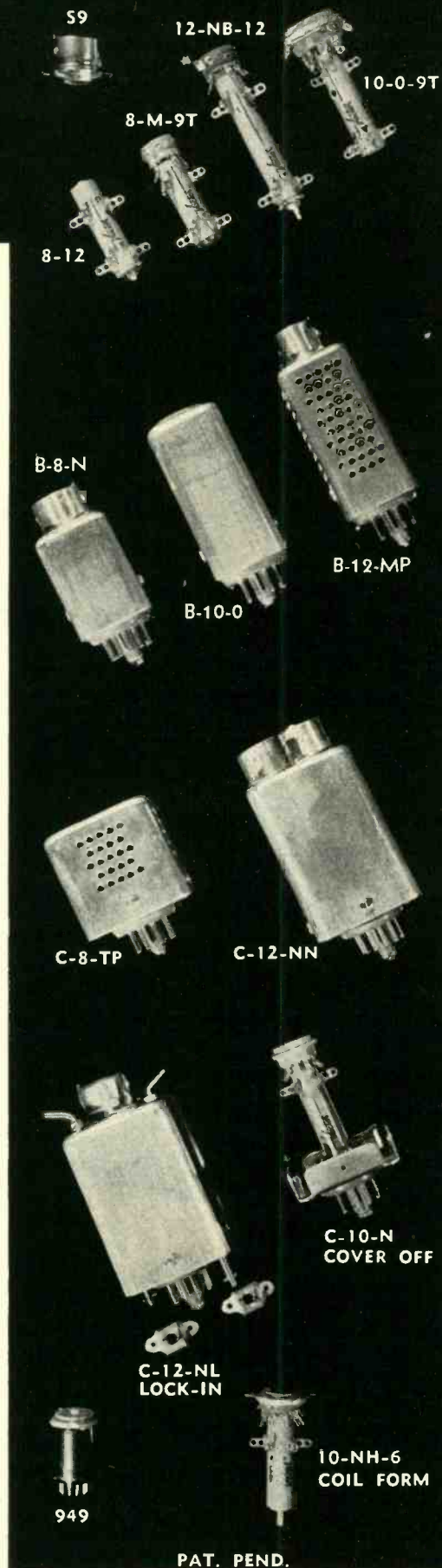

Ask **ADVANCE...**
GET A DEPENDABLE RELAY
FOR ANY APPLICATION

A complete line of relays for general circuit control, electronic, aircraft and marine applications. Crisp action, dependable and durable. ADVANCE offers sensitive, midget, midget telephone, keying, instrument, time-delay, overload, transmission line, impulse, hermetically sealed and ceramic insulated relays. Wide variations of these types for special applications. ADVANCE engineering will supply special relays to meet the most exacting requirements. Your inquiry will receive prompt and courteous attention.

Follow the Engineers to ADVANCE.



ADVANCE ELECTRIC & RELAY CO.
 2435 North Naomi Street ★ Burbank, California

PICKERING



SOLENOIDS

For DC Circuits

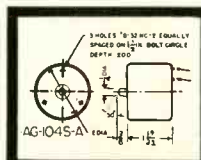

Pickering engineering service is available for special applications where Pickering standard Solenoids do not apply.

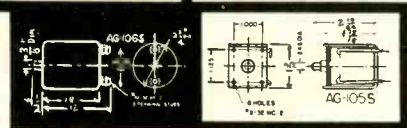

For details and literature address Department
PICKERING & CO., INC.
 Manufacturers of world-famous
*electro-magnetic phonograph
 cartridges and audio equipment.*
 Oceanside, L. I., New York



Steatite

for **ELECTRONIC**
Applications

You can specify LOUTHAN low-loss Steatite products with complete confidence in the high quality and dimensional accuracy of the parts. Made to exacting standards, Louthan Steatite insulations have the mechanical and electrical characteristics needed for electronics applications and other electrical service. They are formed to meet your needs and made to close tolerances. Surfaces are smooth, hard, clean and non-absorbent.

Write for Catalog 49-E, describing Louthan Insulations.

THE LOUTHAN MANUFACTURING COMPANY

A Subsidiary of Harbison-Walker Refractories Co.

EAST LIVERPOOL, OHIO

Representatives: H. B. Zeiger, New York 17, N. Y.

Glenn Garner Company, Chicago 6, Ill.

THIS BOOK...

The **electronics BUYERS' GUIDE**

tells you
 who makes each of
**fourteen hundred dif-
 ferent electronic and
 allied products.**

Keep it
 and use it
**for quick buying
 and technical reference
 throughout the year.**

When buying, or requesting product information be sure to mention **ELECTRONICS BUYERS' GUIDE.**

Chicago 40

LITTELFUSE

Precision Engineered Fuses



8 AG

361000 Series Instrument Littelfuses—You can rely on the efficiency and high speed action of these fuses—always “quicker than a short circuit”. Designed for high-speed action. For the protection of delicate electrical equipment—microammeters, galvanometers, milliammeters, wattmeters, radio “B” circuits, thermocouples, voltmeters, test equipment, telephone systems, small rectifier and power tubes, railway signal meters, set analyzers, therapeutic machines and general instrument protection.

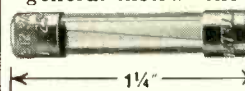

3 AG

312000 Series Littelfuses—Quick-acting fuses—for low time-lag applications. Protective-coated elements, on fuses to 3 amperes, prevent oxidation and promote clean break on fusion. Diagonal element alignment of this fuse assures accurate alignment and calibration, even when the fuse element is expanded by heat.

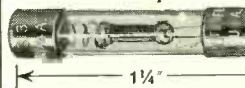

3 AG

313000 Series Littelfuses—Slo-Blo fuses with high time-lag to withstand heavy surges—quick on shorts. Designed for circuits with equipment having high inductive or capacitive surges, such as magnets, solenoids, etc., and for circuits with heavy starting currents, such as motors and lamp circuits. Anti-fatigue construction (compound element, with spring and resistor) makes these fuses ideal for intermittent-duty circuits on vibrators, control circuits, hi-tension electric fences, small magnets, coils, etc.

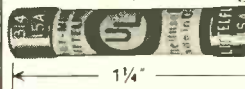

3 AB

314000 Series Littelfuses—The smallest Underwriters’ Laboratory approved fuses in ratings this high. Steatite enclosed, arc-quenching, powder filled fuses. Shatter-proofed against quick shorts. Medium time lag. Recommended for use with amplifiers, rectifiers, battery charging equipment, small generators, control panels, amusement devices, communication and electronic equipment, radios, signal apparatus, small motor circuits, etc.

Also, S.F.E., 4 AG, 4 AB, 5 AG, 5 AB Fuses, Fuse Extractor Posts, Fuse Mountings, Fuse Retainers, Fusible Binding Posts.

Edin instruments

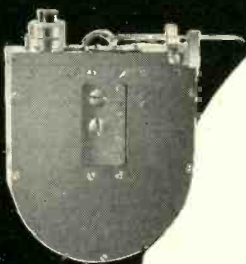

OSCILLOGRAPH GALVANOMETER

No's. 8001, 8002, 8003 and 8004 ink-writing galvanometers have sensitivities from 3.5 to 40 volts per cm., resonant frequencies from 15 to 120 cps., resistances from 1000 to 2000 ohms, frequency response up to 350 cps., and a single-jewel pivot construction. Units are designed for multiple operation up to 10 channels in a total width of 12 inches.



DIRECT-COUPLED AMPLIFIER

No. 8100 direct coupled amplifier has a voltage amplification of 13,000 with a maximum output of 70 volts. Frequency response from d.c. to 10,000 cps. is flat within 10%. Input impedance is 2 megohms; output impedance is 150 ohms. Input may range from 0.1 mv. to 100 volts. Stability is better than 0.1 mv. per thirty minutes, or 0.5 mv. per day. Attenuator is stepped for factors from 1 to 1000.



OSCILLOGRAPHS

Recorders can be supplied with 1, 3 or 9 chart speeds ranging from 0.1 mm./sec. to 250 mm./sec. See specifications of OSCILLOGRAPH GALVANOMETER for frequency range.

OSCILLOGRAPH AMPLIFIER

No. 8121 special amplifier has a time constant of 1 second, an exponential response to a square wave at high gain, input impedance of 1 megohm, and input from 0.1 mv. to 1000 volts. At low gain, No. 8121 becomes a DC amplifier with a voltage gain of 100 and an input of 10 mv./mm.

HIGH-GAIN AMPLIFIER

No. 8130 amplifier, has a voltage gain of 1,000,000 and includes a built-in pre-amplifier. Frequency response is from 1 to 200 cps. Input may range from 10 microvolts to 100 millivolts. This amplifier is particularly suited for Biological studies.

Many other types of recording and amplifier circuits are available and special equipment can be assembled to meet particular specifications.

EDIN COMPANY, INC.
207 Main Street
Worcester 8, Mass.

Please send complete information on:

- | | |
|---|--|
| <input type="checkbox"/> RECORDERS | <input type="checkbox"/> No. 8100 AMPLIFIER |
| <input type="checkbox"/> NO. 8121 AMPLIFIER | <input type="checkbox"/> No. 8130 AMPLIFIER |
| <input type="checkbox"/> GALVANOMETERS | <input type="checkbox"/> SPECIAL (Enclose details) |

.....
(NAME)
.....
(NO.) (STREET)
.....
(CITY) (STATE)
.....
COMPANY POSITION

REEVES- HOFFMAN

QUARTZ CRYSTAL UNITS

★ for all Military and
Commercial applications
from 16 kc to 100 mc

Reliability of performance of crystal units in
crystal controlled frequency devices is of the
utmost importance.

Reeves-Hoffman Quartz Crystal Units are
precision-built to meet the most
exacting requirements of both military and
commercial specifications.

They are the product of skilled engineers and
craftsmen . . . working with the finest materials
and the most modern facilities available.

When you buy . . . specify
Reeves-Hoffman, the
finest name in crystals.



REEVES-HOFFMAN
Corporation

Carlisle 2, Pennsylvania
THE FINEST NAME IN CRYSTALS



A compact, hermetically sealed unit with pressure mounted, capacity
coupled crystal. The capacity is less than four mmfd between pins.



Reeves-Hoffman her-
metically sealed, plated
crystal units are made to
tolerances so accurate as
to eliminate the need for
heater ovens in most ap-
plications. A variety of
cuts may be obtained in
small, universal holders,
with .050 and .093 pins
or with wire leads.



All other types of stand-
ard holders are available.

L I C E N S E D U N D E R P A T E N T S O F T H E B E L L S Y S T E M

Pyroferric

IRON CORES



you can depend upon
PYROFERRIC

Your best bet for
POWDERED IRON CORES

PYROFERRIC engineers are specialists and pioneers in the technique of powder metallurgy development and iron core manufacture. Consult with them on your iron core or powder metallurgy requirements . . . no requirement either too small or too large.



**OUR SPECIAL DEFENSE
CONTRACT DEPARTMENT
ASSURES PROMPT
SERVICE FOR ALL GOV-
ERNMENT WAR WORK.**



Pyroferric Co.

621 EAST 216 ST.,

NEW YORK 67, N. Y.

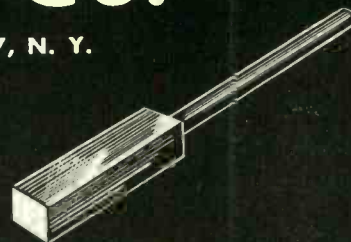

FULL RANGE OF MIL-T-27 TRANSFORMERS

HERMETICALLY SEALED UNITS

NYT hermetically sealed transformers are available in all standard sizes to meet MIL-T-27 specifications, and especially designed constructions for a wide variety of military as well as civilian applications. Designed and built to meet the most exacting specifications. Production facilities for quantity production of all sizes.

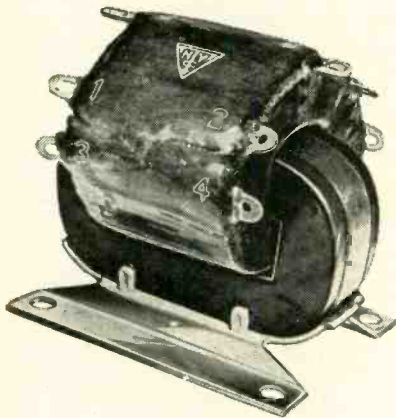
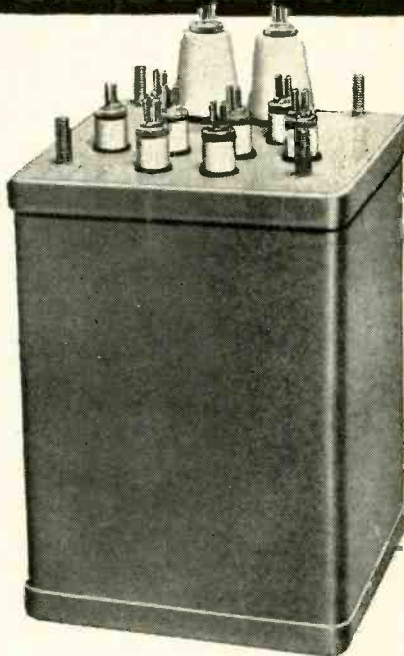

the HORNET

HORNET transformers, pioneered by NYT, are of open type construction, utilizing Class H insulating materials. Approximately one-fourth the size and weight of comparable Class A units. Filament and plate supply transformers and chokes. Units can be designed for ambients up to 190 deg. C., altitudes up to 60,000 feet; power ratings from 2VA to 5KVA.

**POWER, AUDIO, FILAMENT
and PLATE TRANSFORMERS
REACTORS • FILTERS • CHOKES
TV • RADIO • ELECTRONICS**



Engineering and development facilities

**NEW YORK
TRANSFORMER CO., INC.**
ALPHA, NEW JERSEY

Recommended for use in Army, Navy and Air Force equipment.

TOP HAT RETAINERS

... for holding tubes and other plug-in components securely in position ... are made in a variety of sizes to fit almost any type tube ... will not loosen under the most extreme condition of shock or vibration.

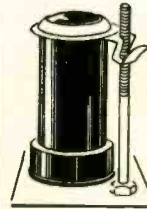

EASY TO APPLY

INSTANTLY RELEASED

POSITIVE LOCKING ACTION

Manufactured by

TIMES FACSIMILE CORPORATION

A Subsidiary of The New York Times Company

540 West 58th Street
New York 19, N. Y.

1523 L Street N. W.
Washington 5, D. C.

this BOOK tells you
the MANUFACTURERS
of over 1400 types of
ELECTRONIC and
ALLIED PRODUCTS
from .. ABRASIVES
to .. YOKES, Deflection
and this year ...



tells you where they are in production or available in a reasonable time and unrestricted for general industrial use.

**electronics
BUYERS'
GUIDE**

Please mention this book when buying or inquiring from it.

Aladdin
 Rubbed
 A Lamp



but all you have to do is specify

Airpax Products

That's the "magic" that's been turning "problem projects" into praiseworthy products. All your project may need is: the miniaturization you can get from an Airpax high-frequency vibrator power supply . . . the efficiency and lightweight of an Airpax 400-cycle inverter . . . the durability, ruggedness and safety of an Airpax chopper for servo applications! You can expect freedom from atmospherics and high altitude problems . . . nearly everything we make is hermetically-sealed. High acceleration stresses, vibration tests; other military and commercial specs are met by our equipment.

400
 cycle
 choppers

poly phase
 inverters

60 cycle
 choppers

400 cycle
 inverters

miniature
 power
 supplies



CML TEST EQUIPMENT PERFORMANCE

Model 1430 Variable Frequency Electronic Generator

Frequency Range: 0-5000 cps in 4 ranges.
Frequency Control: Single dial, direct reading, linear scale in 4 ranges: 50-180; 170-600 540-1800; 1700-6000 cycles.

Power Output: Nominal rating 1400 w continuous duty.

Output Voltage: The controlled output voltage is continuously adjustable from 0 volts to 140 volts. Normal performance is considered at the 120 volt RMS output where the change in output voltage from no load to full load of 1400 watts will not exceed 2%.

Waveform: The waveform varies slightly from no load to full load. At full load, the distortion is less than 10%.

Power Supply: Any 60 cycle single phase source between 208 and 260 volts capable of carrying a 3.5Kw. load with good regulation. A tapped auto transformer is provided to take care of this range of input voltages.



Model 1210B Stroboscope

Stroboscope lamp mounted in small probe. Range 480 to 60,000 rpm in 4 ranges individually calibrated on fundamentals 80-1000 cycles.

Vibrating reed for calibration.

Accuracy of reading better than 1%.

Overall maximum departure from calibration less than 3%.

Power Supply requirements: 105-125 volts, 50-60 cycles.



Model 1115 Regulated Power Supply

Regulated "B" supply 150-300 volts up to 70 mils.

Voltage variations under all load conditions less than 1%.

Output ripple voltage under all conditions less than 5 millivolts.

Regulated "C" supply 0-50 volts 0 current.

Output ripple less than 1 millivolt.

Output impedance maximum 50,000 ohms.

Unregulated heater supply 6.3 volts at 5 amp.

Power source requirements 105-125 volts 50-60 cycles.



Model 1010 Rotobridge

Automatic Inspector For Production Line Testing.

Checks equipment for opens or shorts in wiring. Checks tolerance of resistors at 5%, 10% or 20% as required.

Resistance Test Range: 200 ohms to 2 megohms at 5%. Tests smaller and

larger values at 10%.

Tests one circuit per second, up to 119 circuits in one cycle
 PROVIDES NUMERICAL indication of every defective circuit.

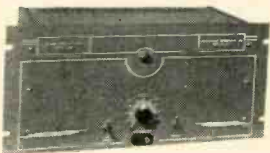

Model 1100-1110 Electronically Regulated Power Supplies

Power Source: 105-115-125 volts, 50-60 cycles.

D.C. Power Output: 200 ma from 225 volts to 300 volts. 180 ma from 300 volts to 320 volts.

Total noise content in output is less than 5 millivolts. Regulation: less than 1 volt change from no load to full load. Unregulated heater supply 6.3 volts at 5 amperes.

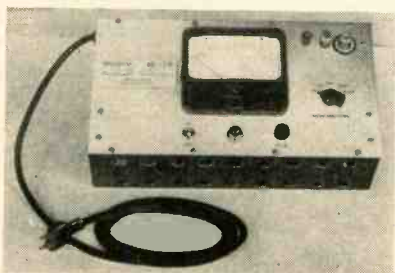

Model 1500 Megohm Meter

Range: 0.4 to 100,000 megohms in 5 overlapping ranges.
Test Voltage: 415 to 450 volts, depending on specimen resistance.

Indicating instrument: 4" panel meter hand-calibrated directly in megohms. Multiplication factor is given by meter multiplier switch.

Accuracy: better than 5% on all ranges at all points on the scale.

Guarding: The instrument is efficiently guarded on all ranges so that atmospheric conditions do not affect its accuracy.

Model 1420 Variable Frequency Electronic Generator

Frequency Range: 50-6000 cycles in 4 ranges. 50-180; 170-600; 500-1800; 1700-6000 cps.

Power Output: 250 watts continuous duty. Maximum distortion at full output into resistive load less than 10%.

Regulation no load to full load within 2%.

Nominal regulated voltage output 80-120-135-215-255 or 270 volts.

Power input 115 volts 60 cycles 1 Kw.

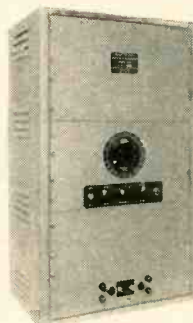

Model C-3 Virtual Height Ionosphere Recorder

A specialized instrument for use by Governments and Communications companies to measure the virtual height of the ionosphere.

Frequency Range in Continuous Sweep: 1 mc-25 mc.

Sweep Time: 7½, 15 or 30 seconds and 15, 60 or 120 seconds.

Sweep Interval: 5, 15, 30 or 60 minutes.

Pulse Recurrence Frequency: 10 to 90 PPS.

Height Ranges: 0-500; 0-1000; 0-4000 kilometers.

Automatic programmed operation.

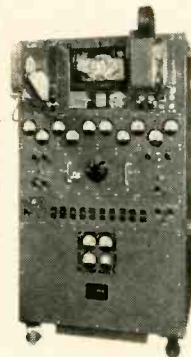

Model 1130 Regulated Power Supply

Power Input: 105 to 125 volts, 60 cycles.

D.C. Output: 210 volts to 310 volts 0 to 400 ma.

Regulation less than 1% from no load to full load at 310 volts.

Below 270 volts at any load, or below 300 ma. load at any voltage, regulation is better than 1 volt.

Total noise content in output does not exceed 10 millivolts at 310 volts-400 ma. at any load below 270 volts or at any voltage below a 300 ma. load noise output is less than 5 millivolts.

FOR FURTHER INFORMATION PHONE, WRITE OR CABLE:

COMMUNICATION MEASUREMENTS LABORATORY, INC.

Cable: "COMUNILAB" New York

120 GREENWICH ST., NEW YORK 6, N. Y.

Phone: REctor 2-2080

**S. S. WHITE PRODUCTS AND SERVICES
FOR THE ELECTRONIC INDUSTRY**

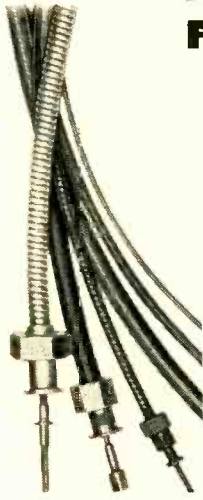

FLEXIBLE SHAFTS

*for Power Drive
for Remote Control*

S.S.White Flexible Shafts, in both power drive and remote control types, come in a large selection of sizes and characteristics. Combinations of selected flexible shaft, flexible casing and end fittings are made up to user's or government specifications in any length, ready for connection. Engineering cooperation on specific applications available without obligation.

WRITE FOR BULLETIN 5008

It gives up-to-the-minute facts and data on flexible shaft selection and application. Write for a copy.



FLEXIBLE SHAFT ADAPTERS



Used to connect flexible shafts in close quarters and where space conditions prevent a direct connection without bending shaft too sharply. Drawings and specifications on request.

"All-Weather"
MOLDED RESISTORS



Of particular interest to all who need resistors with inherent low noise level and good stability in all climates.

HIGH VALUE RANGE—10 to 10,000,000 megohms
This unusual range meets the needs of scientific and industrial control, measuring and laboratory equipment, and high voltage applications.

STANDARD RANGE—1000 ohms to 9 megohms
Used widely in commercial radio, telephone, telegraph, sound pictures, television, etc., and in a variety of U. S. Navy equipment.

WRITE FOR BULLETIN 4906

It gives full information on S.S. White Resistors, including construction, characteristics, dimensions, etc. Also describes S.S.White 80X High Voltage Resistors. Copy with price list on request.



PLASTIC SHIPPING CAPS AND PLUGS



THREADED TYPE

Provide inexpensive protection to threaded openings and studs during shipment, storage and maintenance. Made of tough, non-brittle plastic, they will not chip or break easily and can be used over and over again. Write for BULLETIN P-4601.

ELASTOPLASTIC TYPE

Slipped into or over the ends of plain tubing, elastoplastic plugs and caps seal out moisture and dirt and prevent damage. They hold by friction fit and are easy to apply and remove. Ask for BULLETIN P-4704.



OTHER PLASTIC PRODUCTS

S.S.White has a large range of stock plastic parts for protection of parts during production, shipment or storage. Also a custom molding service in Nylon and in all thermoplastic and thermosetting materials.

**THE S.S. White INDUSTRIAL DIVISION
DENTAL MFG. CO.**



**Dept. EG, 10 East 40th Street
NEW YORK 16, N. Y.**



**BETTER TOROIDS MAKE
BETTER FILTERS . . . AND**

B&W Makes Both

Precise engineering and careful design, coupled with highest grade materials and latest designed winding equipment enable B & W to manufacture Toroidal Coil Type Filter Units economically to most exacting specifications.

B & W offers to all communication fields, a performance-proved line of Filters, including High-Pass, Low-Pass, Band-Pass, and Band Suppression Types, in addition to supplying individual Toroidal Coils in a wide range of inductance values.

Coil Problems Solved!

Need an exacting coil type—one produced to critical specifications by coil specialists?

B & W coils in standard or special types range from single layer solenoid coils to universal units with single, multiple pie or progressive windings; RF, IF and oscillator coils; traps, discriminators, filters, RF and delay line chokes and others. For detailed information write to B & W Department EY-61.



BARKER & WILLIAMSON, Inc.

237 Fairfield Avenue

Upper Darby, Penna.

Want to know about the...

AUGETRON

ECCLES-JORDAN CIRCUIT

KATHETRON TUBE

MEKAPION TUBE

PERMATRON

PETOSCOPE

SCHLIEREN METHOD

SCOPHONY

SEMAGRAPH

SIRUFER

SYNDEC

THEREMIN

TRATONIUM

VODER

or other early electronic developments?



You can find out about
them in the early issues
of **ELECTRONICS**.



*The cumulative index to
ELECTRONICS' first decade,
pages C-1 to C-36
in this book, tells you
where to look.*

GOING TO MAKE NEW PRODUCTS SOON?

We're Ready to Help
with your
**SPRING, COIL and
WIREFORM**
Problems

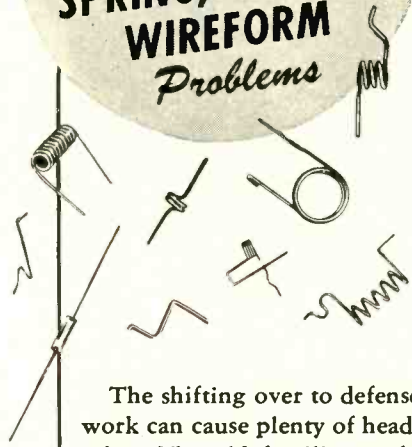

The shifting over to defense work can cause plenty of headaches. The old familiar problems of new specifications, shortages, manpower, equipment, schedules, etc., etc., are approaching us again. We can't help solve all your problems, but we probably can save you several aspirins when it comes to springs, coils and wireforms.

What can Lewis offer you?...

Extensive, modern facilities and equipment — experienced design and engineering personnel — skilled production workers — practical, economical manufacturing methods — unusual assistance in selecting the "right" springs for the job.

So, when you're ready, take advantage of the experienced help that Lewis Spring Engineers can offer — if possible, while your products are still in the blueprint stage. Phone, wire or write — no obligation.

**LEWIS SPRING &
MANUFACTURING CO.**

2656 W. North Ave. • Chicago 47, Ill.

Lewis
PRECISION
SPRINGS

THE FINEST LIGHT SPRINGS AND WIREFORMS
OF EVERY TYPE AND MATERIAL

You'll like this new type catalog, and you'll like doing business with Sun Radio — just as many industries, laboratories, universities, government agencies, broadcasters have enjoyed dealing with us for 30 years. So when you need goods or information, get it the "Easy Way" — call Sun Radio, America's "Complete Jobber".



**AT
LAST!**

A Jobber's Parts Catalog for the Engineer

A completely new concept in Catalogs, it will make buying easy for you. 132 pages full of electronic components by every major manufacturer. Compiled for the engineer with illustrations and complete specs on every item. Everything arranged in logical, easy-to-find sequence. Larger type means easier reading. You'll especially like the easy-to-use, easy-to-file, 8½ x 11" page size.

In other words, you at last have your needed components listed in a CATALOG, not a booklet. Make sure you have this important buying guide on your desk at all times. Write us for FREE copies for yourself and for those who work with you.

ONE ADDRESS — NO BRANCHES

Sun Radio & Electronics Co. of New York has no branches in any other city.



TWO BLOCKS NORTH OF CHAMBERS STREET
Established 1922 • Open Daily 9-6, Sat. 9-4:30



MIDGET CONDENSER MICROPHONE

for PRECISION SOUND MEASUREMENTS or HIGH QUALITY SOUND RECORDING

- Rugged Construction
- Exceptional Calibration Stability
- Unaffected by Variations in Humidity

Built to give years of service without adjustments and without change in calibration. Even without dessicators, Kellogg Midget Condenser Microphones show no detectable drift in laboratory service. Proven in use for optimum performance for over 15 years.

.....

This response is flat to within ± 3 db from 20 to 12,000cps and to within ± 3 db from 20 to 15,000 cps with the grill removed. The overload level for this model is approximately 130db.

MATERIAL—Diaphragm—.001" ST-17 aluminum alloy. All other major components are brass. External surfaces are bright gold plated and lacquered. **CAPACITY**—Approximately 40mmf. **INSULATION RESISTANCE**—100,000 megohms minimum measured at 250 volts. **POLARIZING VOLTAGE**—150-300 volts. 150-225 volts is the recommended range.

Users include government laboratories, universities, audio development laboratories, sound studios and industrial plants manufacturing sound equipment.

Model B is available either uncalibrated or with free field calibration. Prompt delivery on both models — be sure to specify type desired.

Send for full specifications today. Write Dept. 26-F.

KELLOGG

Established 1897

SWITCHBOARD AND SUPPLY COMPANY

MIDGET CONDENSER MICROPHONE

6650 SOUTH CICERO AVENUE • CHICAGO

SEALED TERMINALS : SEALED HEADERS

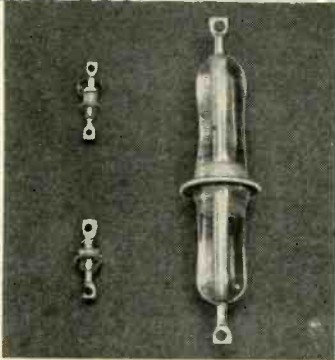

Smallest to Largest

Hermaseal manufactures Sealed Terminals in an extremely wide range of sizes, for very low or very high voltage, with tubular electrodes for high current carrying capacity—and with solid electrodes for moderate current requirements. Wide range of stock sizes available—write for catalog.

COMPLETE ASSEMBLIES—we have facilities for soldering terminals to your Transformer covers—evacuating and pressure-filling enclosures. Prices on request.

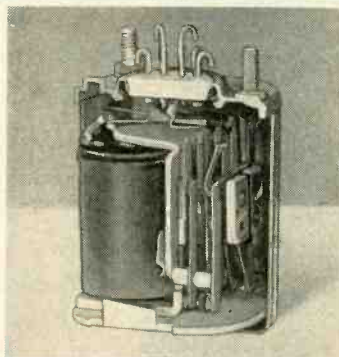

Simple to Complex

From a series of basic designs, Hermaseal can furnish you with a wide selection of styles and sizes in Sealed Headers, ranging from simple, 2- and 3-electrode, crystal holder bases, and standard octal headers, to 14- and 16-terminal headers for sealed Transformer and Relay applications. Write for catalog.

NOTE—We also manufacture a variety of special-design Headers and Terminals. We will be glad to quote on your special requirements.



HERMASEAL COMPANY, INC.
Elkhart 10, Indiana

THIS IS THE

ONE BOOK

THE ONLY
ONE OF ITS KIND

In which
design engineers and
purchasing agents will find
a complete, accurate, and
up-to-date list
of the manufacturers
of all types of electronic
and allied products...
components and complete
equipment.

Keep it handy
for ready reference
throughout the year.

When buying, or requesting
product information be sure
to mention...

electronics BUYERS' GUIDE

DC - AC CHOPPER

A model for every use.
10 — 500 cycles AC
Meets AN Specifications
also 60 cycles
Single pole and double pole
Make-before-break contacts
Contacts in air or in liquid



These Choppers convert low level DC into pulsating DC or AC so that servo-mechanism error voltages and the output of thermocouples and strain gauges, may be amplified by means of an AC rather than a DC amplifier.
They are hermetically sealed, precision vibrators having special features which contribute to long life and low noise level.

WRITE FOR THESE CATALOGS ...
#280 10-500 cycles
#246A 60 cycles

STEVENS ARNOLD INCORPORATED

22 ELKINS STREET
SOUTH BOSTON 27, MASS.

SA-4



BURGESS Can Solve Your Battery Problems!

COMPLETE BURGESS ENGINEERING FACILITIES AT YOUR DISPOSAL!



Yes, the complete Burgess facility ... engineering ... design ... production is available to provide the exact dry battery you need for your particular application. Make use of the know-how gained by Burgess engineers in over 25 years of special battery development and manufacture. There is no substitute for these many years of special battery production experience.

HUNDREDS OF BATTERY TYPES are available to you at your Burgess distributor ... the special battery you need may be among them! For your convenience, your nearby distributor also carries standard battery types for replacement.



BE SURE OF YOUR POWER SUPPLY!

If you are still in the design stage and need a special battery to meet your needs, it will pay you to mail the coupon below for a *free* check-sheet which will enable you to enter your specifications with Burgess engineers.

**MAIL THIS
COUPON TODAY**

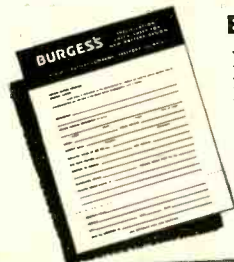

BURGESS BATTERY COMPANY DEPT. EBG FREEPORT, ILLINOIS

Please send free check-sheet for entering our dry battery specifications.

Name Title.....

Firm Name

Address

City Zone State.....

for
MILITARY
and
CIVILIAN
APPLICATION

Specify **N.U. TUBES**

Shown here are just a few general types of the many premium-quality tubes manufactured by National Union for military and civilian application.

Serving the entire television, radio and electronics field, N.U. tubes are backed by constant research and development. This is your assurance of tubes of consistent high quality and performance . . . of uniformity and proper design for the job.

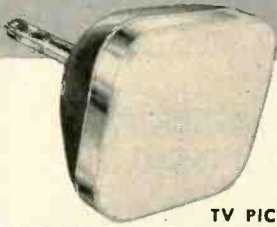

CATHODE RAY TUBES

Cathode ray tubes for military and other electronic applications ranging up to 22" in diameter. Videotron television picture tubes from 7" to 22", both round and rectangular all glass. Both electrostatically and electromagnetically deflected types.

TV PICTURE TUBE TYPE 20FP4

OCTAL TYPE RECEIVING and SPECIAL PURPOSE TUBES

An extensive line of G and GT series receiving tubes for radio, radar, and television equipments plus special-purpose electronic tubes for non-communications use and low-power transmitters.

BEAM
PENTODE
TYPE
6V6GT



HIGH-
VOLTAGE
TRIODE
TYPE
2C53

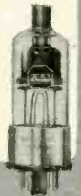

SUB-MINIATURE and MINIATURE TUBES



R-F BEAM
PENTODE
TYPE 5851



MINIATURE
PENTODE
TYPE 6AU6

A comprehensive line of T-5½ and T-6½ miniature receiving tubes and special-purpose tubes for radio, TV, radar, and non-communications uses to be available in early 1952. And currently available T-2 and T-3 sub-miniature types especially designed for military applications.

VACUUM TUBE RESEARCH

A separate division employing over 150 persons established to handle vacuum tube research on a contract basis for the electronics industry as well as to back up the N.U. manufacturing divisions.

30-ANODE
RADIAL BEAM
TUBE
TYPE 5730



RUGGEDIZED TUBES

In addition to standard construction tubes, ruggedized tube types for military applications and other special uses are available, having characteristics equivalent to the regular types. This series is constantly growing as developments in process are completed.

NATIONAL UNION RADIO CORP.

MAIN OFFICE: 350 SCOTLAND RD., ORANGE, N. J.

RESEARCH DIVISION: ORANGE, N. J. • PLANTS: NEWARK, N. J.—HATBORO, PA.

BIG ENOUGH TO
SERVE YOU —
SMALL ENOUGH TO
KNOW YOU

THE TOWER OF STRENGTH

IDEAL FOR
COMMUNICATIONS
MICROWAVE
TELEVISION
LIGHTING

Superior construction features give **LOW COST Vee-D-X sectional towers** the highest safety factor of any tower in its price class.

If you have an elevated installation problem, absolute permanency of your installation is assured when you use a **VEE-D-X sectional tower**. Strength is a major factor. Don't take chances with structural failure. Be sure with **VEE-D-X!**

- *Rugged, all-welded construction diagonally laced with angle iron for maximum rigidity.*
- *Can be erected on ground or on flat or peaked roof.*
- *Patented plate spaced at two foot intervals prevents twisting and affords rigidity found in no other tower.*
- *Safe and easy to climb.*
- *Completely galvanized, light weight tubular steel . . . 20 ft. section 72 lbs.*

PRE-ASSEMBLED for fast, inexpensive installation

VEE-D-X towers are designed for use at any height from 10 to 140 feet. They are self-supporting up to 20 feet and, where space is limited, *semi-guyed** type installations may be used at 30, 40, and 50 foot heights. Sketch at right shows the basic parts and necessary accessories for a complete installation. Three types of top mount are available. VEE-D-X towers may be ordered in separate units or as a complete package for a specific height. (Either guyed or semi-guyed.) Write the LaPointe-Plascomold Corporation of Windsor Locks, Conn. for complete information.

*Semi-guyed towers employ one set of guy cables attached at a height of 10 ft. up the tower and anchored at a 6 ft. radius from the base.

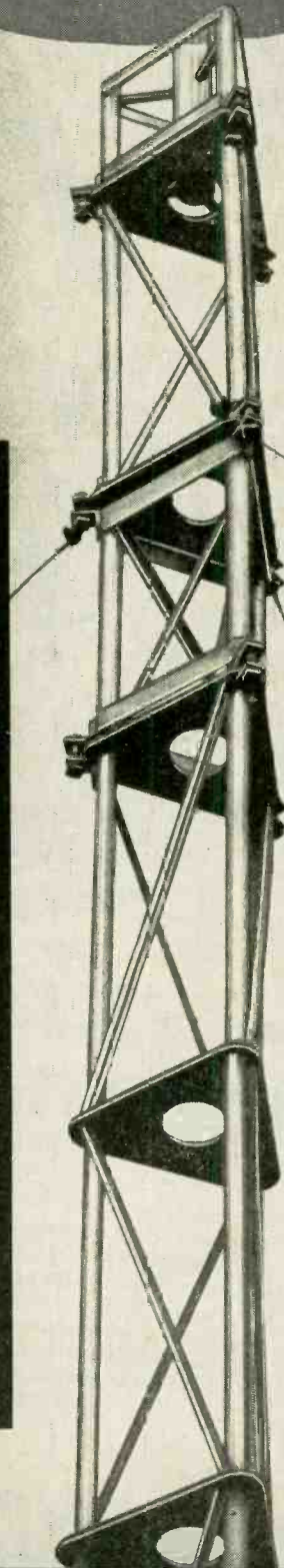
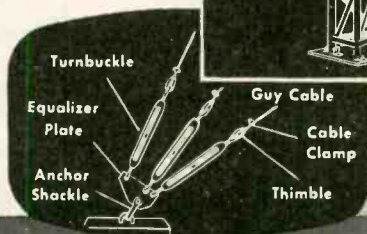
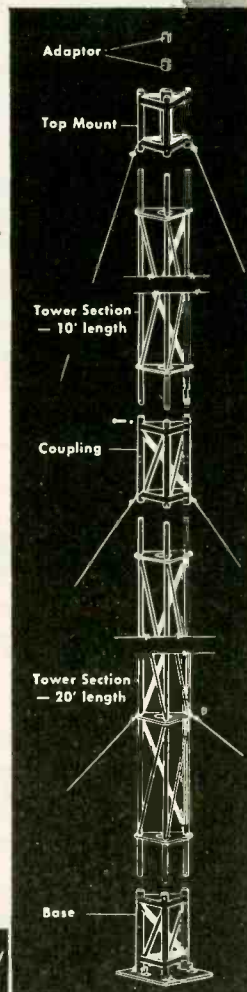

VEE-D-X

BUILDERS OF THE WORLD'S MOST POWERFUL ANTENNAS

SOMETHING

New!

UNDER
THE
SUN!

A LITTLE IRON
THAT DOES A

BIG JOB!



THE *Vasco* **PETITE**
SOLDERING IRON

A small iron that does an **INDUSTRIAL** Job. Designed and built for **INDUSTRIAL** Work! Used by industry throughout the nation. 25 Watts of efficient, conducted heat—at the **TIP** where it's needed. 6¼ inches long—3/16 inch tip—110 Volts. Extra Flexible Cord. Weighs only 1½ ounces!

WITH THE **Exclusive**
EGYPTIAN TIP!

The ancient Egyptian art of Hammer-hardening of copper has been applied by our engineers to the manufacture of modern soldering-iron tips, thereby eliminating one of the iron-user's greatest problems. This process, applied with present-day equipment and ingenuity extends the life of an otherwise ordinary tip ten times, by the virtual elimination of pitting. "The Greeks had a word for it" . . . "The Egyptians had a way to do it."

Manufactured by



VASCO division of **MITCHELL INDUSTRIES, INC.**

Mineral Wells, Texas

EL-Tronics INC.

2649 N. HOWARD STREET
PHILADELPHIA 33, PA.

UNSURPASSED PLANT & ENGINEERING FACILITIES AVAILABLE FOR PRODUCT DEVELOPMENT, MANU- FACTURE AND ASSEMBLY

Our completely equipped precision electronics plant and laboratories are at your service. Whether you are in need of tooling and production facilities to manufacture a product in accordance with your own designs or are confronted with a problem in product application requiring the development of one or many units, specifically made to fulfill your particular requirements, call on us.

America's Foremost Crafters
Of Scientific Equipment

SQUARE WAVE GENERATOR—Model SG5 An inexpensive step frequency type square wave generator for accurate high speed testing of response characteristics of wide band amplifiers, wide band oscilloscopes, television video amplifiers, etc.

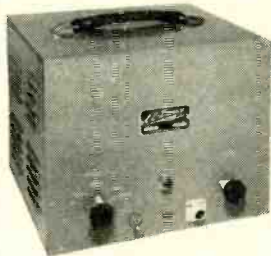

- FEATURES**
- Five fixed output frequencies of 50, 1000, 100,000 and 500,000 P.P.S.
 - Individual calibration control for each frequency.
 - Rise time .05 microseconds.
 - Output voltage 0.8 to 8 volts peak to peak.
 - Small, compact, portable—completely AC operated.

SIZE 9" x 11" x 11½" WEIGHT 20 lbs.

INSULATION RESISTANCE TESTER—Model MO5

A small compact portable battery operated insulation resistance tester employing a high quality vibrator power supply as a source of high potential. Operates completely from two self contained 1½ volt batteries.

Total current drain only 150 milliamperes.

- FEATURES**
- Resistance Range—5000 megohms at 2000 volts D.C. potential.
 - Meter—4½" rectangular type with 3⅞" scale length.
 - Small and light in weight.
 - Provided with leather strap for carrying.
 - Operates completely from two self contained 1½ volt dry batteries.

SIZE 5" x 5⅜" x 6" WEIGHT 2 lbs.



AUDIO OSCILLATOR—Model TE200K

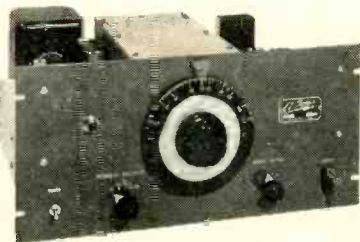

Frequency Coverage—20 cycles to 200,000 cycles in four ranges.
Frequency Dial—6" diameter, direct reading, with planetary drive.
Output Voltage—10 Volts maximum.
Calibration Accuracy ±2% of dial setting indication.
Distortion — 3% or less across standard load at any frequency setting and at any output voltage up to maximum.
Hum Level—Minus 50 DB or better.
Standard Load—1000 ohms resistive.
Frequency Response ± 1 DB from 20 to 200,000 C.P.S.
Drift ± 2% or better.

SPECIAL FEATURES

- Electronically regulated power supply for stable operation under varying line voltage conditions.
- No electrolytic capacitors are used.
- Designed for stable continuous operation under the most adverse conditions.
- Mounts in standard relay rack or table cabinet.

RADIATION SURVEY METER—Model PR-3

FUNCTIONAL DESCRIPTION:

Portable Beta-Gamma discriminating count-rate meter with thin glass wall G.M. tube in probe.

CHARACTERISTICS:

- Radiation Detected — Beta or Gamma.
- Discrimination — Rotating Shield on probe. (2mm Brass)
- Full Scale reading—
.2 MR/HR 2 MR/HR 20 MR/HR
- Meter—Navy Type sliding scale with individually colored ranges.
- Sensitive element—GM tube—30 mg sq/cm wall.
- Power Source—2 1½ V Eveready #742.
- Minimum Energy Beta detected—200 KEV.
- Waterproof Aluminum case.
- Fungus proofed.
- Shoulder straps provided.
- Provision for plug-in phones.

WEIGHT 9½ LBS.

SIZE 5¼" x 7½" x 9½"



WE HAVE MANUFACTURED EQUIPMENT OF THE FOLLOWING TYPES:

A Slight Modification of Existing Designs Might Fill Your Application

- | | |
|--|--|
| 1. Nucleonic Instruments | frequency, etc. (c) R.F., special applications (d) Magnetostriction (e) Diathermy and RF heating |
| 2. Radio Transmitters, 200 KC to 300 MC | |
| 3. Radio Receivers, 35 KC to 400 MC | |
| 4. Carrier current control equipment—transmitters and receivers for remote control operations | 10. Frequency Standards
(a) RF secondary standards (b) Audio standards |
| 5. Regulated Power Supplies (Electronic)
(a) Low voltage, high current
(b) High voltage, low current | 11. Oscilloscopes for special application |
| 6. Burglar Alarms—electronic, capacity operated | 12. Electronic Bridges: capacity, resistance, etc. for special application. Limit bridges |
| 7. Variable Frequency Electronic Generators—50 watts to 1,000 watts; 25 to 2500 cycles | 13. Ionization Gauges, electronic |
| 8. Audio Equipment
(a) Limiting amplifiers (b) Clipping amplifiers (c) Broadcast remote amplifiers (d) Modulators (e) High power P.A. for stadiums and rinks up to 1,000 watts (f) Church belfry chime systems (g) High fidelity amplifiers | 14. D.C. amplifiers |
| 9. Oscillators
(a) Audio, Wien-Bridge (b) R.F., beat | 15. Photo-electric control and counting devices |
| | 16. Vacuum tube voltmeters |
| | 17. Electronic high speed counting devices and time interval measuring equipment |
| | 18. Radio tuners—high fidelity broadcast, AM and FM |
| | 19. Television signal boosters |
| | 20. Pulse generators and square wave generators |

We maintain a fully equipped laboratory embracing the finest in modern high quality test instruments—complete facilities for testing every type of equipment manufactured—facilities for temperature and humidity tests from -80°F to +165°F and humidities up to 95%.
Take advantage of our 15 years of experience in the Specialized Electronics Field. We are one of the oldest commercial manufacturers of Nucleonic Instruments and Capacity Operated Electronic Burglar Alarms.

15,000 SQ. FEET OF FLOOR SPACE AND A MODERN, FULLY EQUIPPED PLANT TO SERVE YOU

For further details write

EL-TRONICS, INC.

2649 N. HOWARD ST.
PHILADELPHIA 33, PA.

High Quality Workmanship . . . Reasonable Prices . . . Speedy Delivery

GENERAL PLATE PRODUCTS FOR THE ELECTRONIC INDUSTRIES

COMPOSITE SHEET, WIRE, TUBE

General Plate Composite Metals are available in strips, sheets, bars, tubing or wire in various sizes and thicknesses. Made by permanently bonding precious metals, such as silver, gold, platinum to base metals, these composite metals give solid precious metal performance at a fraction of the cost of solid precious metal. The precious metal provides specific performance requirements such as electrical conductivity and corrosion resistance while the base metal reduces costs, provides workability, strength and solderability. General Plate manufactures all grades of silver solder, solder filled, flushed, burred, etc., with various flow points for

all types of electronic applications. General Plate engineers will gladly help you with your problems.

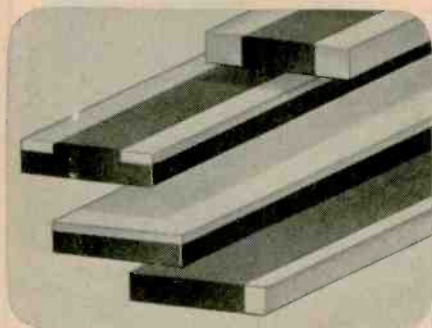
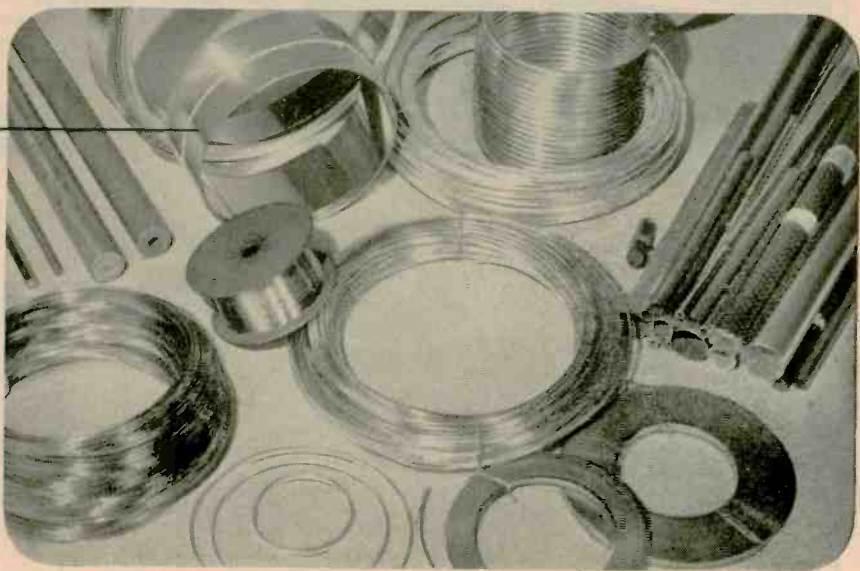

COMPOSITE CONTACT MATERIAL

Permanently bonded silver to base metal is available in the following stock — overlay, single and double edgelay, single and double inlay, toplay, ready for you to fabricate into contacts.

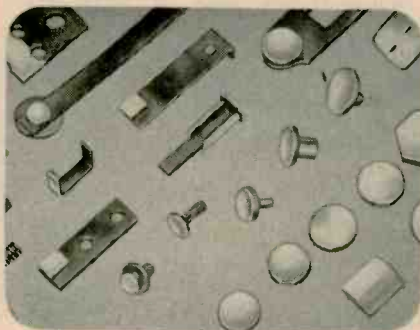

COMPOSITE CONTACTS

General Plate can supply all types of fabricated composite contacts, buttons, rivets, screws made to customer's specifications. These contacts give high electrical conductivity at reduced costs.

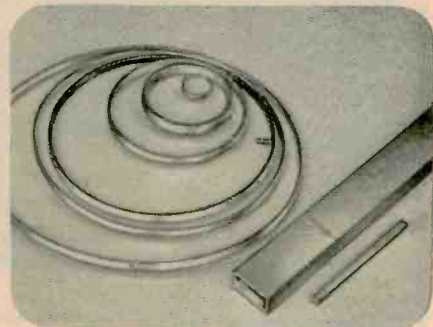

RIGID WAVE GUIDE

Solid silver, composite aluminum or copper with silver lining. Full range of sizes. COLLECTOR RINGS — solid silver or silver on base metal.

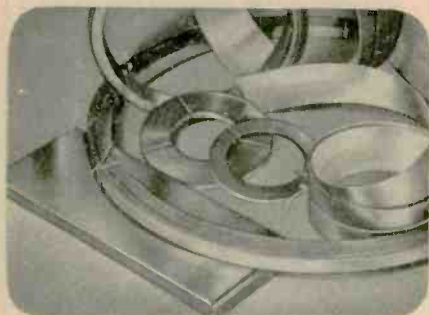

COMPOSITE METALS

Available in practically any combination of metals, such as precious to precious, precious to base or base to base metals. Combinations for electronics, such as aluminum clad iron, nickel clad iron for anode material, also available.

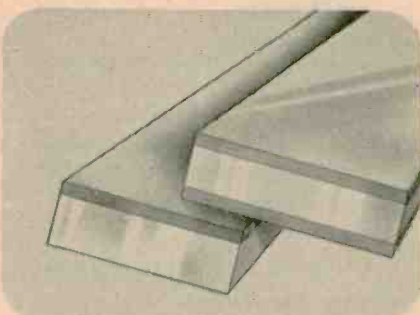

ALCUPLATE COPPER ON ALUMINUM

This composite metal makes aluminum solderable. The copper provides excellent conductivity, the aluminum light weight. Alsiplate (silver on aluminum) is available.



TRIFLEX METALS

These thermostat metals are manufactured in a wide variety of types, each with a different reaction to temperature. Write for information and engineering assistance.

GENERAL PLATE Division of Metals and Controls Corporation
300 FOREST ST., ATTLEBORO, MASSACHUSETTS

FREQUENCY SHIFT EQUIPMENT



TRANSMITTING TUBES

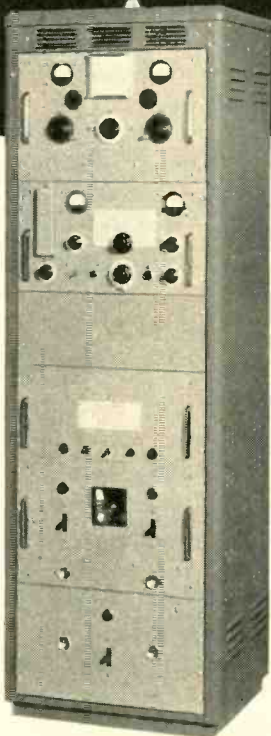

TYPE A-4912 TRANSMITTER FOR MARINE, AVIATION AND LAND USE

This general purpose transmitter is designed to serve a wide variety of communication needs.

FREQUENCY RANGE: 2 to 27 mcs. continuous coverage with an 8 band exciter and 5 band power amplifier. Space for 10 crystals.

5 TYPES OF EMISSION: A-1 (telegraph service), F-9 (frequency shift) and F-4 (facsimile) transmission, 400 watts output. A-2 (modulated c.w.), 250 watts. A-3 (telephone), 100 watts.

KEYING SPEED: Electronic make-break keying to 200 w.p.m. With minor changes in key-click filter, keying speed can be increased to 500 w.p.m.

Ask for Bulletin A-4912

HK - 257 B / 4 E 27 BEAM PENTODE



The low drive requirement of the HK-257B permits the design of lighter and more compact equipment, and also minimizes parasitics which cause TVI. Widely used as an h.f. or v.h.f. oscillator or power amplifier. Dissipation: 75 watts CCS, 125 watts ICAS.

Four page data sheet available

HK Frequency Shift EXCITER

TYPE A-4722



Basic keying unit for F-S transmission. Frequency shift is adjustable from 50 to 1000 c.p.s. Keying speed to 600 w.p.m. Output frequency range: optional, 1.6-5 mc., or 2-6 mc. Excellent stability.

Ask for Bulletin A-4722

HK IONIZATION GAUGES



Offered in four types with sensitivity ratings from 25 to 200 microamps per micron. VG-100 (illustrated) has tungsten elements which are easily outgassed in a single electrical operation.

FREE BOOKLET

Covers the use of ionization gauges in high vacuum systems. We will be glad to send you a copy of this manual without charge.



HK Frequency Shift CONVERTER

TYPE 4922



High selectivity permits operation within 1.5 kc. of strong adjacent channels. Converts audio output from two diversity receivers into d.c. for operation of teletype and multiplex printers.

Ask for Bulletin HK-4922

HK Communications Equipment Division
50 DRUMM STREET
SAN FRANCISCO, CALIF.

Export: The M. Simons & Sons Co., 25 Warren St., New York City

HEINTZ AND KAUFMAN Division
THE ROBERT DOLLAR CO.
947 BROADWAY
REDWOOD CITY, CALIF.

Cable: Simontrice

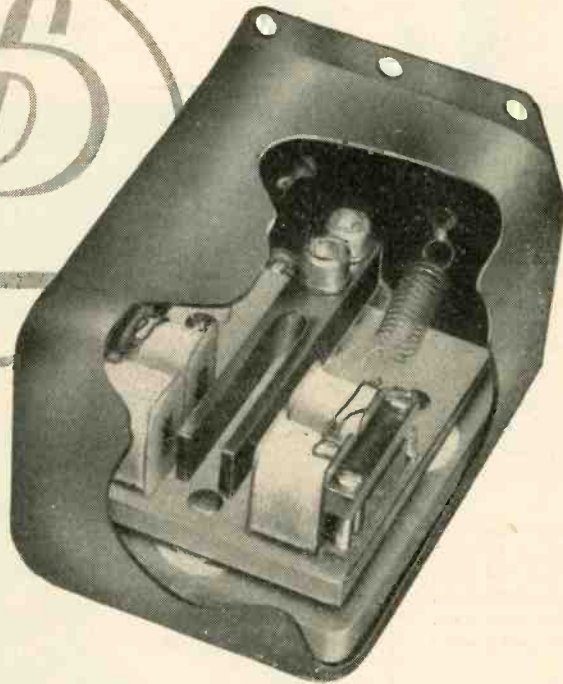

Tuning Forks

for precision frequency control

A complete line of tuning fork resonators to meet your reference standard . . . timing . . . or speed control requirements.

ACCURATE . . . Manufactured in accuracies up to 1 part in 10,000 for operation from -40 to $+75^{\circ}\text{C}$.—and up to 1 part in 100,000 for operation from 0 to $+75^{\circ}\text{C}$.

COMPENSATED . . . Thermal compensation method employed maintains fork accuracy throughout rated operating temperature range without benefit of oven control or warm-up time.

RUGGED . . . Internally shock-mounted using relatively permanent, semi-inorganic, silicone rubber—a desirable feature for stringent shock and vibration applications.

HERMETICALLY SEALED . . . Solder-sealed evacuated container prevents barometric pressure and relative humidity variations from affecting fork accuracy.

FREQUENCIES . . . 400 cycles and from 700 to 3,000 cycles for accuracies up to 1 part in 10,000—from 1,000 to 3,000 cycles for accuracies up to 1 part in 100,000.

Available individually—as a part of compact sub-assemblies—or in completely engineered equipment constructed to your specifications.

Write Dept. B for complete information or telephone HYacinth 2-4800.

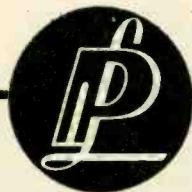

PHILAMON LABORATORIES
5717 Third Avenue Brooklyn 20, N. Y.

THE 6T-4

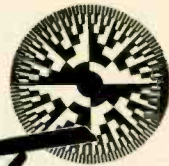

Strobocorr

MEASURES
FREQUENCIES
TO ACCURACY
WITHIN 0.05%
INSTANTLY—

direct reading
no computation



VISUALLY—

at the turn of a dial indicator knob.

- MEASURES transient vibrations.
- CHECKS, measures rotative speeds.
- COMPARES frequency ratios.
- CALIBRATES impulse generators.
- SERVES as precision audio frequency standard.

Write for additional material . . .

C. G. CONN LTD.

Electronics Division, Dept. 612
Elkhart, Indiana

NOT...

until next year
will you get another

electronics
BUYERS'
GUIDE

Don't let it get away
from you.

It's the best source
of buying information
for electronic
and allied products
that has ever
been compiled.

When buying, or requesting product information be sure to mention
ELECTRONICS BUYERS' GUIDE.

BERYLLIUM COPPER SPRINGS and STAMPINGS

heat treated in multiple fixtures to insure uniformity

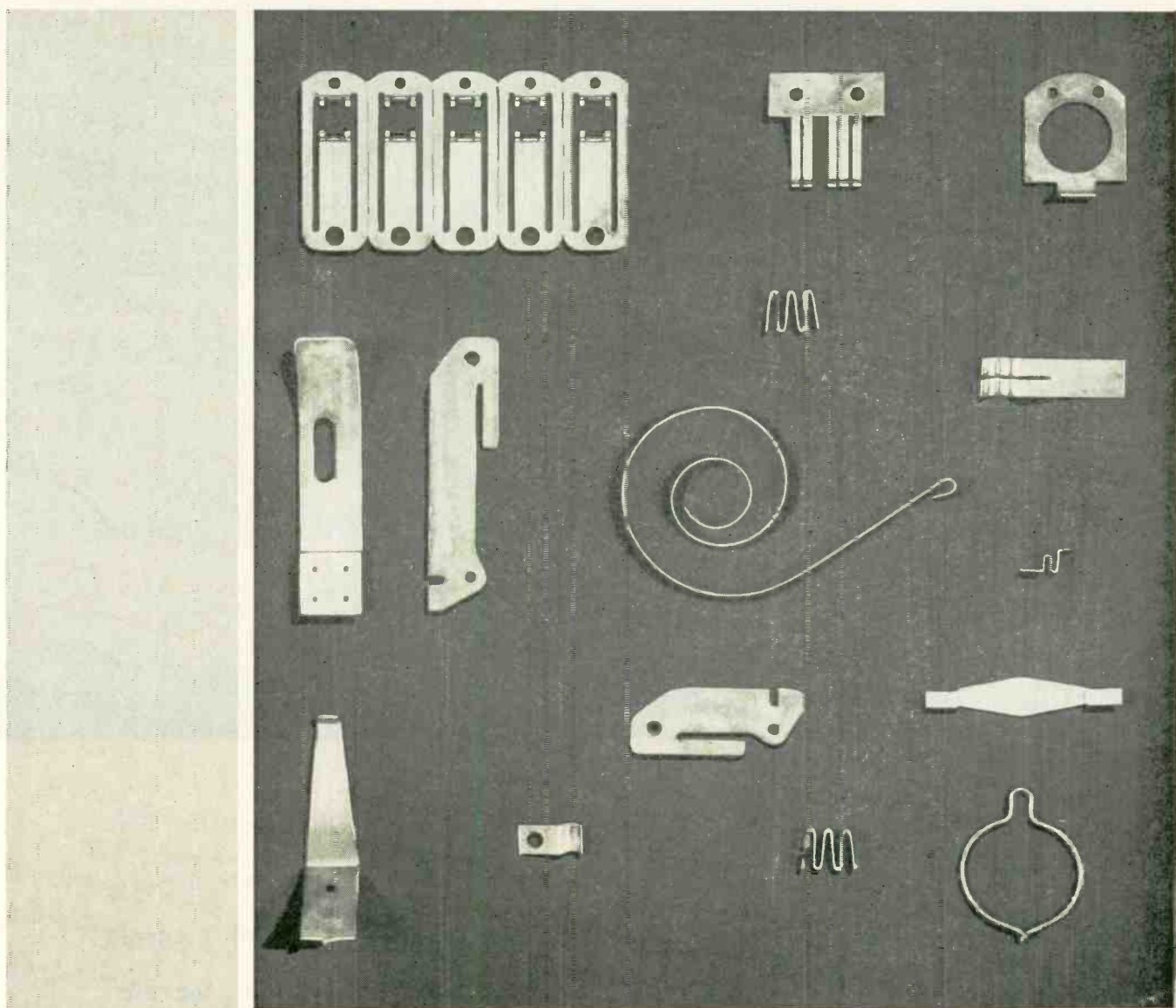

MECHANICAL LABORATORIES

ULster 5-7163

30 MAIN ST., BROOKLYN 1, NEW YORK

Let us quote on your requirements. Write for your copy of "Design Facts on Beryllium Copper Springs and Stampings".

A DIVISION OF LEE SPRING COMPANY, INC.

DEPENDABLE

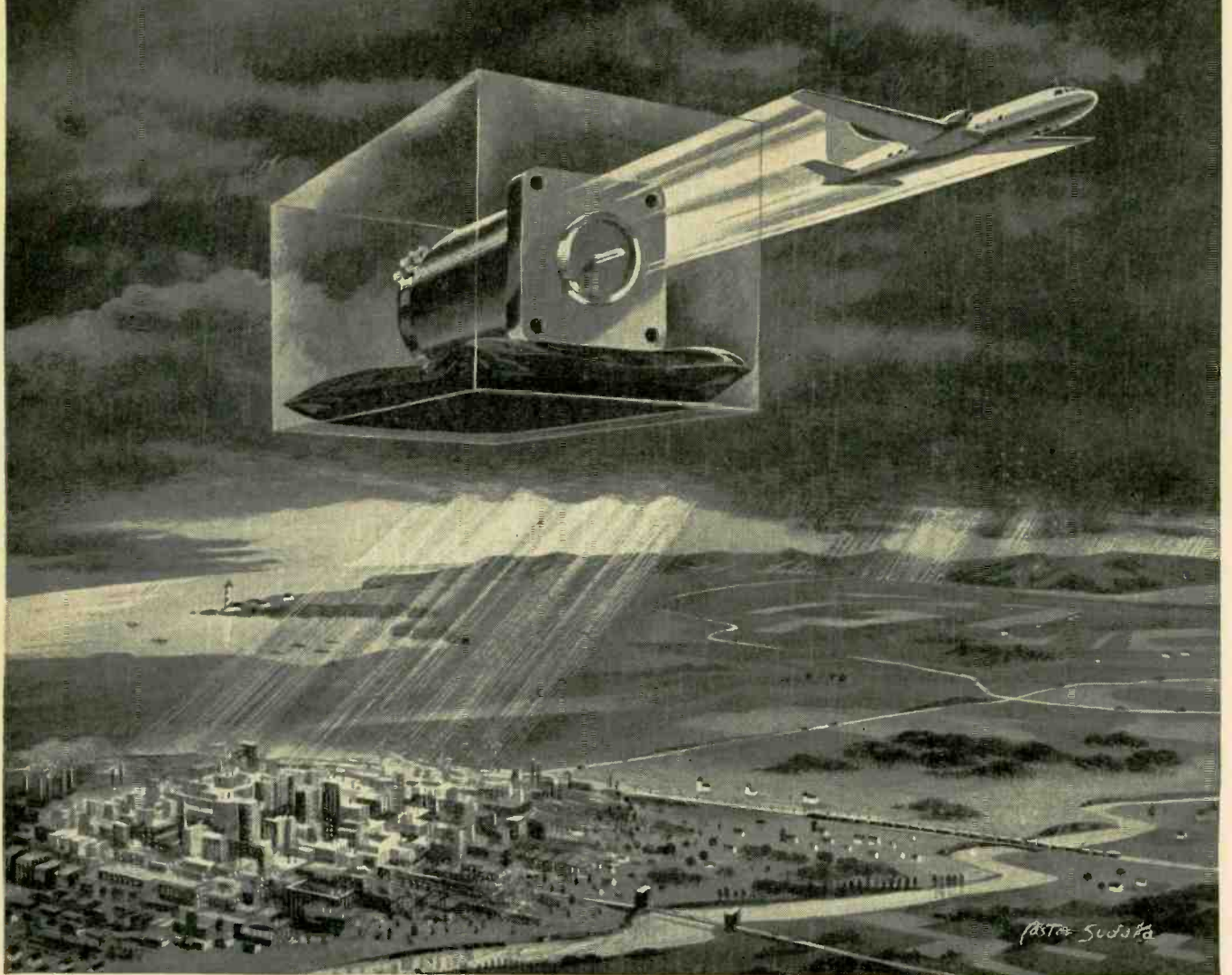

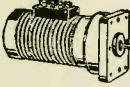
The last word You've said the last word when you say it's made by Kollsman—you've said the last word about a miniature motor. Engineers who specify aircraft instrument  and control systems have looked to Kollsman for more than twenty years for the last word in accuracy, in surety of performance, in dependability.

for precision and dependability
look to **KOLLSMAN**
INSTRUMENT CORPORATION
Elmhurst, New York • Glendale, California

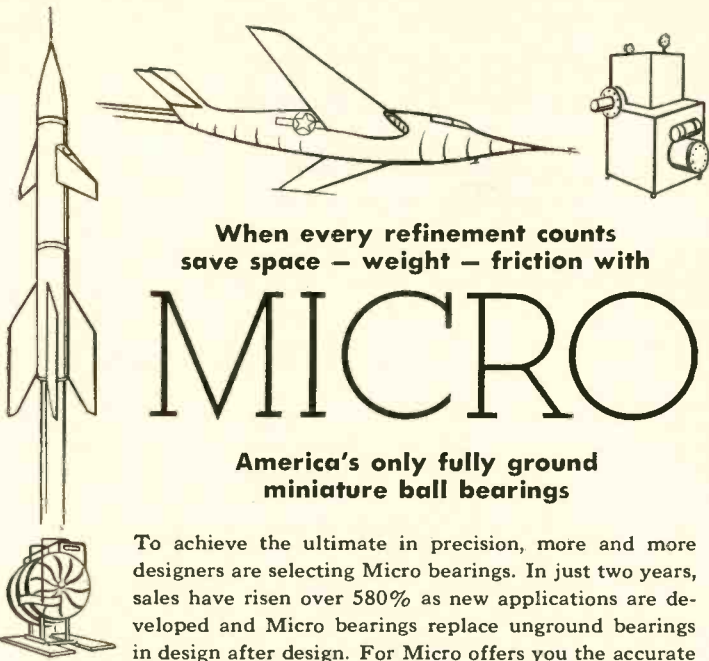

When every refinement counts
save space — weight — friction with

MICRO

America's only fully ground
miniature ball bearings

To achieve the ultimate in precision, more and more designers are selecting Micro bearings. In just two years, sales have risen over 580% as new applications are developed and Micro bearings replace unground bearings in design after design. For Micro offers you the accurate

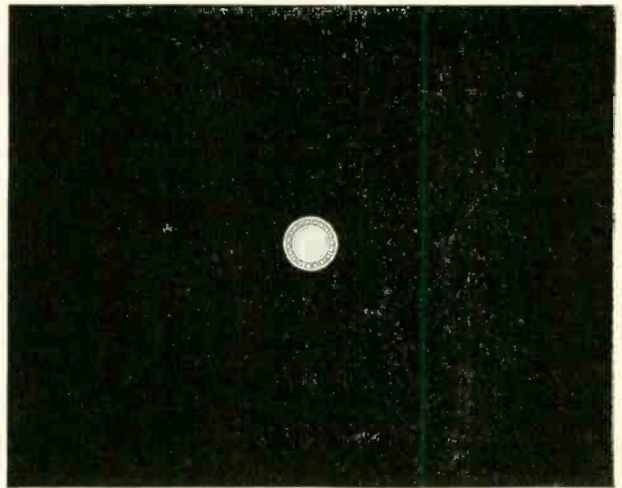

geometry, high capacity and smooth performance obtainable only in precision ground bearings. Available in sizes as small as $\frac{1}{8}$ " O.D. and with tolerances to the millionths inch refinement of ABEC-7, Micro bearings minimize weight, space and friction. Yet — size by size and type by type — they actually cost less than comparable unground bearings.

85 types and sizes to meet your specific design requirements

Full Race Radial



Designed for maximum radial load capacity, with consequent superiority under shock, vibration and general heavy duty. For moderate speeds, with thrust up to 40% of radial load. $\frac{1}{8}$ " to $\frac{3}{8}$ " O.D. Standard and extra-light types.

Conrad Radial



The only miniature Conrad bearings made in the U. S. By far the most economical and generally useful of all precision bearing types. For radial, thrust or combined loads. Wide speed range. Sizes from $\frac{5}{32}$ " to $\frac{3}{8}$ " O.D.



Angular Contact

A versatile, modern design, featuring lowest friction and highest speed limits, both improving as size is reduced. High capacity for radial, thrust in one direction, or combined loads. Sizes from $\frac{3}{16}$ " to $\frac{3}{8}$ " O.D.

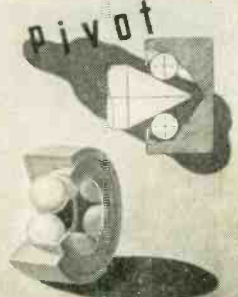

A special-purpose design widely used in the instrument field, offering substantial advantages in capacity, shock-resistance and anti-friction over the usual sliding friction, jeweled pivot arrangement. From $\frac{5}{32}$ " to $\frac{3}{8}$ " O.D.



Self Aligning

A single-row, internal self-aligning type, with outer raceway ground to a generated spherical surface, permitting 10° or more of misalignment between shaft and housing. Moderate radial, light thrust loads. $\frac{1}{4}$ " to $\frac{3}{8}$ " O.D.

Spring-Retainer



The first and only miniature bearing of its type made in the U. S. Offers outstanding advantages for consistent performance, particularly as to starting or breakaway torque. Values of .0006 in.-oz. and below with 70 grams thrust load.

Flanged



This recently developed design often makes possible considerable manufacturing economies by facilitating mounting and assembly. Available in both Full-Race and Conrad types. Sizes from $\frac{3}{16}$ " to $\frac{5}{16}$ " O.D.



Write for
Technical Bulletin No. 50
giving complete engineering
data and specifications

NEW HAMPSHIRE MICRO BALL BEARINGS, INC.

5 MAIN STREET, PETERBOROUGH, N. H.

The Smaller the Bearing - The Better it Runs

PRECISION POTENTIOMETERS

Sinusoidal Type

CONDENSED SPECIFICATIONS

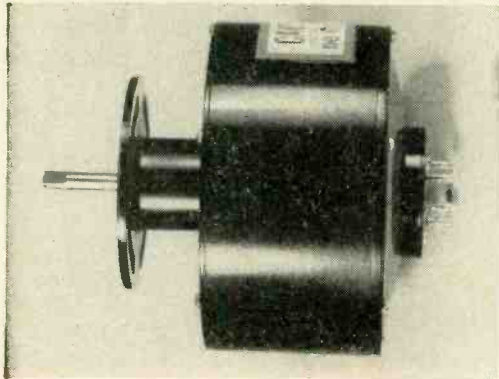

RL-14 MS

	RL11-C	RL-14 MS
Total resistance	16,000 ±10%	35,400 ±1%
Percent resistance within brush circle	Approx. 85%	99 ±¼%
Angle of rotation	360°	360°
Weight	4.75 oz.	1.8 lbs.
Torque (Approximate)	¾ oz. in.	2 oz. in.
Wire	80 Ni 20 Cr	80 Ni 20 Cr
Resolution	.4°	.2°
Angular accuracy	±.6°	±.5°
Amplitude accuracy	±.8%	±.6%
Maximum volts across winding	150	350
Maximum speed	60 rpm	60 rpm
Expected Life	350,000 cycles	200,000 cycles

Minor variations of these standard designs, available on special order, permit operation at high rotational speeds with some loss of accuracy.

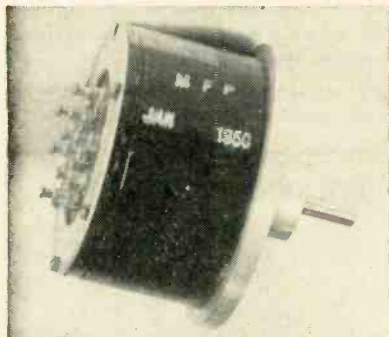

RL-11C

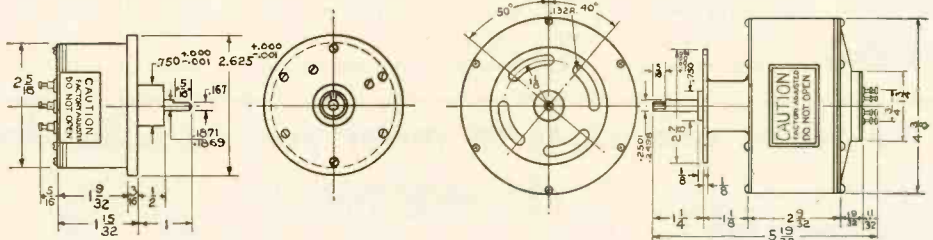

RL-11C

RL-14 MS

Toroidal Type

- Rating 15 watts
- Torque, max. 2 oz. inches
- Weight 14 oz.
- Resistance 500 to 25,000 ohms
- Useful angle 360° or less
- Resolution 0.06 to 0.2%
- Linearity ±1% with multiple taps;
±½% end taps only
- Brushes 2 (180° ± ½)
- External connections. 6 (4 winding taps
—2 brushes or 5
winding taps—1
brush)

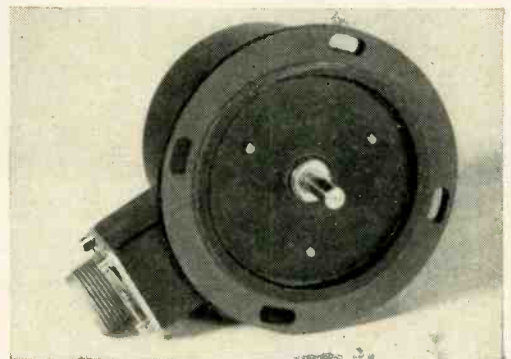
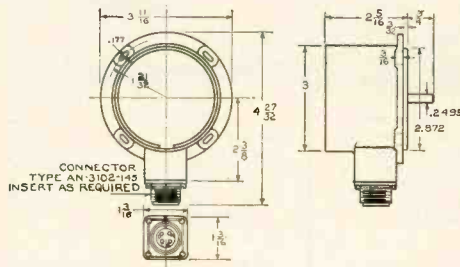

RL-270 Type

CONDENSED SPECIFICATIONS

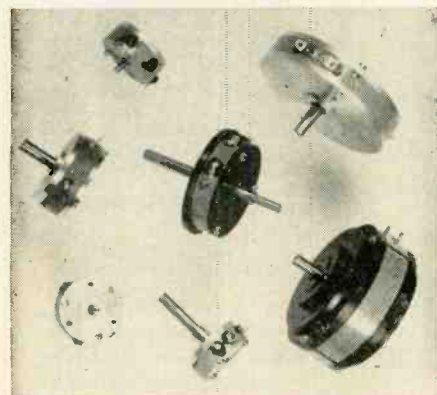

	RL-272	RL-270	RL-271	RL-275	RL-277
Diameter "A" (in)	5	3	2	1 5/8	1 1/4
Rating (watts)	12	6	3	2	1.5
Torque, max. (oz. in.)	1	1	1	1/2	1/2
Weight (oz.)	15	6	3	2	1
Mounting: 3 holes 1/8" deep	#8-32	#8-32	#8-32	#6-32	#4-40
Mounting circle diam. "B" (in)	3.250	1.750	1.250	1.000	1.000
Max. resistance (ohms) ±10%	500,000	275,000	160,000	105,000	64,000
Min. resistance (ohms) ±10%	460	250	150	105	80
Max. useful angle (deg.)	358 ± 1/2	356 ± 1/2	354 ± 1/2	352 ± 1/2	350 ± 1/2
Max. resolution (%)	0.05	0.08	0.15	0.2	0.25
Min. resolution (%)	0.01	0.015	0.025	0.04	0.05
Linearity (%)	±0.10	±0.10	±0.15	±0.25	±0.30

Standard Shaft: single end, ¾" extension; specify if otherwise.
 Double-ended shaft special; specify diameter and length.
 Multiple sections can be ganged; add 3/8" to the overall length for each additional section.
 Terminals will be positioned on the circumference as required for taps and winding angle.
 Expected life of all types over 1,000,000 cycles.

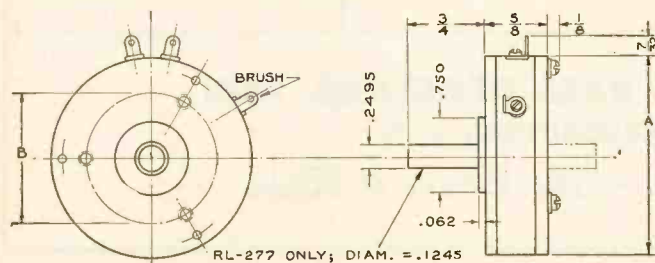

RL-277 ONLY; DIAM. = .1245

THE GAMEWELL COMPANY
 Newton Upper Falls 64, Massachusetts











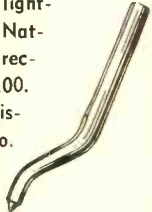

DUOTONE - famous for quality!

phono-needles and sound accessories

CUSTOM DESIGNED NEEDLES IN PRODUCTION QUANTITIES FOR TURNTABLE, RECORD CHANGER AND RADIO PHONO MANUFACTURERS—

Famous Duotone needle quality can be included in your players, economically. Duotone can supply special or standard type playback needles for factory installation at practical prices. For an estimate on your needle requirements, mail coupon below.

<p>FILTER POINT NO. 625-C</p> <p>Needle that filters scratch, retains brilliance. 15 plays each. 25 needles to package for 25¢. 50 packages to card—No. 625-C List \$12.50</p> 	<p>DURPOINT NO. 15</p> <p>Permanent needles for the record enthusiast. Up to 4000 plays. Available also for playing all three speeds, all grooves. List price \$1.00. 12 needles on display card—No. 15-C, list price \$12.00</p> 	<p>LIFETONE NO. 20-C</p> <p>Osmium tip made for record changers. Up to 5000 plays. In plastic case, List \$1.50. 12 needles on display card—No. 20-C List \$18.00. Also available with special radius to play all 3 speeds, all grooves. 12 needles on card—No. 20-AC, List \$18.00</p> 	<p>REGENT SAPPHIRE No. 13</p> <p>Finest jewel tip-up to 5000 plays. For light-weight pickups. Natural tone, low record wear. List \$2.00. 12 needles on display card—No. 13-C, List \$24.00</p> 
<p>SHOCKPROOF NYLON No. 25</p> <p>Dropping tone arm can't damage needle or record. Has Osmium tip on spring steel set into Nylon bumper. List \$2.50. 12 needles on display card—No. 25-C, list \$30.</p> 	<p>STAR Brand SAPPHIRE No. 19</p> <p>Finest jewel tip, hand polished for perfect reproduction. Handsome lucite case. List \$2.50. 12 needles in carton—No. 19-B list \$30.00</p> 	<p>ALL GROOVE SAPPHIRE No. 36</p> <p>One of the finest jewel tips, hand ground and polished for use on 3 speed players. List \$2.50. 12 needles in carton—No. 36-B, List \$30.</p> 	<p>CUTTING NEEDLES</p> <p>No. 8, Steel, 4 for \$1.00 No. 9, Stellite, \$2.00 each No. 11 Sapphire, \$7.25 each Standard or Microgroove No. 12, Sapphire, \$5.50 each</p> 
<p>DIAMOND NEEDLE</p> <p>Available for factory installation in new players or for replacement in all types of pickups. The nearest thing to a permanent needle ever produced. Outlasts jewel needles about 90 to 1.</p>  		<p>MAGNETIC RECORDING TAPE</p> <p>Features high, constant output, minimum background noise. Long life, no rub-off coating. Features constant tracking and winding with no snarls or backlashes. Wound on 6 spoke plastic wheel, or aluminum hub and nab reel.</p> 	<p>RECORDING BLANKS</p> <p>Professional quality nitrate coating. Available with Aluminum base in 6½, 8, 10, 12 inch at .40, .50, .80 or 1.00 list. Order in quantities of 50.</p> 

JEWEL BEARINGS AND PIVOTS



Precision made bearings of sapphire and glass and pivots of steel and non-magnetic precious metals. All parts made to close tolerances and rigidly inspected before shipment.

FILL OUT COUPON for "TECHNICAL SERVICE" information AND MAIL TODAY!

DUOTONE COMPANY, INC.

Keyport, New Jersey

Send complete engineering data on..... to:

NAME.....

TITLE.....

COMPANY.....

STREET.....

CITY..... ZONE..... STATE.....

REMARKS.....

NEGATIVE **T**EMPERATURE **C**OEFFICIENT **RESISTANCE MATERIAL**

Keystone Production now on a Commercial Basis

Our facilities have now been sufficiently expanded beyond the semi-laboratory and limited production stages, so that we are now in position to manufacture this product on a regular commercial basis, in any volume and in a wide range of resistance values.

For NTC Material



Think of Keystone!

KEYSTONE CARBON COMPANY
ST. MARYS, PA.

One of
these
3
materials



may cure your insulating headaches

Product designers and engineers with difficult insulating problems are invited to explore the possibilities of these 3 materials. They have limitless industrial and

electrical application. Judging by our experience with many extraordinary requirements, we feel that one of these 3 may hold the answer you are looking for

1. **TEFLON**

(tetrafluoroethylene resin)

The unique characteristics—extreme chemical inertness, high heat resistance and toughness over a wide temperature range—make this new plastic ideal for gaskets, packings, adaptors and specially molded and machined parts. Has many applications in the electrical industry. We stock it in sheets, rods, tubes and moldings—in all sizes.

2. **MYKROY**

(glass bonded mica)

Perfect for high frequency and high voltage requirements—because of its low loss, dimensional stability and its high dielectric strength in combination with a low power factor. MYKROY is light—yet its strength compares with cast iron. Resists arc heat carbonization. Gas, water and oil have no effect on it. Does not warp. Bonds easily with metals. Molds to any specifications and machines to close tolerances. Available in sheets, rods, fabricated parts and compression and injection-molded forms.

3. **KEL-F**

(Trifluorochloroethylene)

This high polymer is an unusually stable, high temperature, non-inflammable thermoplastic. Has exceptional resistance to chemical action, excellent high and low temperature properties and electrical resistance. Unaffected by humidity or tropical exposure. Available in rods, tubes, sheets, compression and injection-molded forms.

If any of these materials suggests the solution to your insulating problems, we shall be glad to help you pursue your investigation. Our plant has the equipment and our engineers have the experience to give you every assistance. A rough sketch of your requirements will bring you a prompt reply.

Sole Manufacturers of MYKROY - the finest in glass-bond MICA.

68 CLIFTON BOULEVARD, CLIFTON, NEW JERSEY

Arlington Heights Airport, Arlington, Ill.

EXPORT OFFICE: 89 Broad Street, New York 4, N. Y.



Moulders and fabricators
of TEFLON and KEL-F

INSUROK INSULATING PLASTICS



LAMINATED INSUROK

Available in sheets, rods, tubes, and fabricated parts, in many grades, sizes, and thicknesses. Meets practically any requirement for uniformity, machinability, dielectric and physical strength.

MOLDED INSUROK

Parts made to your specifications with various granular or chopped fabric base materials. Produced by compression, injection, or transfer process. Metal inserts can be molded into position.

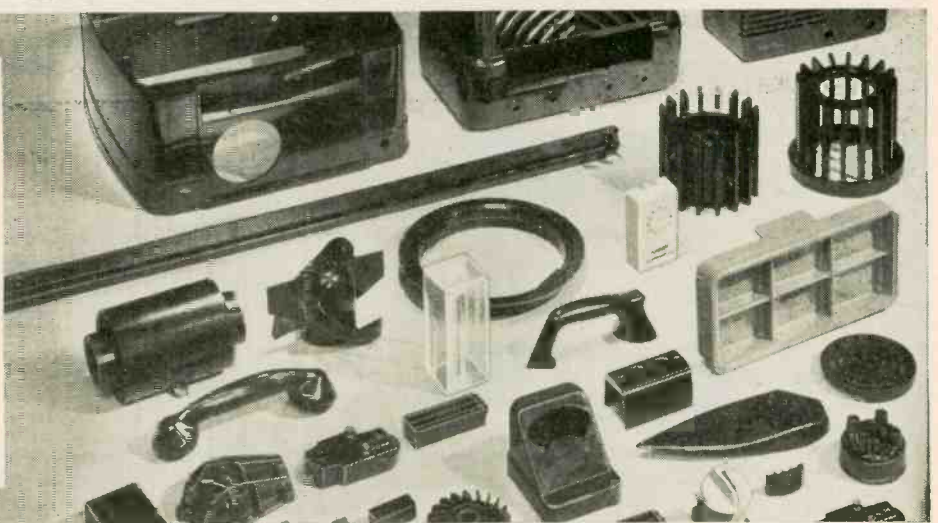

RICHARDSON OFFERS YOU A Complete Range of TECHNICAL SERVICES

Richardson offers the extensive services of its research, design and engineering staffs without cost or obligation. We provide custom molding, laminating, and fabrication facilities and techniques. This assures the correct selection of material and process for every application.

RESEARCH

For over one-quarter century, Richardson has pioneered in the development of new plastics and the improvement of old.

DESIGN

Experienced engineers analyze your requirements and help you select material, form, and process best suited to your needs.

PRODUCTION

Richardson has the plant equipment and know-how to handle even the largest, most difficult molded or laminated job.

FABRICATION

Complete facilities for punching or machining parts to your design and in any quantity.

SALES OFFICES

MELROSE PARK, ILL. (2767 Lake St., Chicago
Phone: MAnsfield 6-8900)
CLEVELAND 15, OHIO (315 Plymouth Bldg., 2036
East 22nd St.)
DETROIT 2, MICH. (6-252 General Motors Bldg.)

LOCKLAND, CINCINNATI 15, OHIO (67 S. Cooper
Ave.)
LOS ANGELES 23, CALIF. (3045 East 12th St.)
MILWAUKEE 3, WIS. (State Bank Bldg., 743 N. 4th St.)
NEW BRUNSWICK, N. J. (409 Codwise Ave.)
NEW YORK 6, NEW YORK (75 West St.)

NORTH BROOKFIELD, MASS. (16 Grant St.)
PHILADELPHIA 40, PA. (3728 W. Broad St.)
ROCHESTER 4, NEW YORK (1031 Sibley Tower
Bldg., 25 North St.)
SAN FRANCISCO 3, CALIF. (114-14th St.)
ST. LOUIS 12, MO. (5579 Pershing Ave.)

INSUROK Products Also Distributed by the Following:

GIBSONVILLE, N. C. (Engineered Plastics, Inc.)

KANSAS CITY 5, MO. (25 East 65th St.) B. H. Williams

The **RICHARDSON COMPANY**

Founded 1858

2767 Lake Street, Melrose Park, Illinois (Chicago District)

MILITARY REQUIREMENTS



COMMERCIAL APPLICATIONS

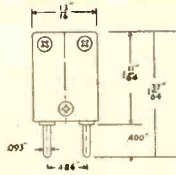

TYPE MC9

RANGE:
1.0-10.0 mc

Supplied per mil type
CR-5; CR-6; CR-8; CR-10
when specified.

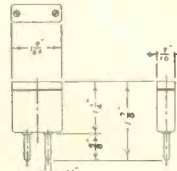
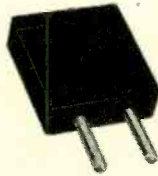
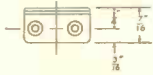

TYPE SR5A

RANGE:
2.0-15.0 mc

Supplied per mil type
CR-1A when specified.

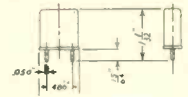

TYPE BH6A

RANGE:
0.8-75.0 mc

Supplied per mil type
CR-18; CR-19; CR-23;
CR-27; CR-28; CR-32;
CR-33; CR-35; CR-36
when specified.

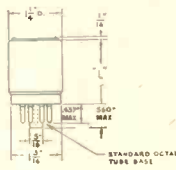

TYPE TCO-1

200-600 kc, 1-100 mc

Dimension "L" is 1 1/2" for
TCO-1 oven (single crystal)
Dimension "L" is 1 11/16" for
TCO-2 oven (two crystals)

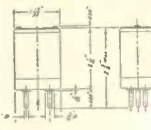

TYPE AR23W

RANGE:
0.080-0.19999 mc

Supplied per mil type
CR-15; CR-16; CR-29;
CR-30 when specified.

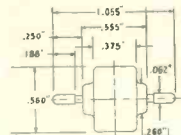
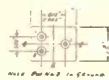

TYPE BH7A

RANGE:
15.0-50.0 mc

Supplied per mil type
CR-24 when specified.



BLILEY . . . THE STANDARD FOR COMMERCIAL APPLICATIONS FOR OVER TWENTY YEARS!



TYPE SR8



TYPE MC7



TYPE SR10



TYPE CF6



TYPE SR7



TYPE BH9



TYPE FM6



TYPE BC46T



TYPE TC92

Temperature Stabilizer

Whenever precision frequency control is needed, Bliley crystals are predominantly chosen for dependability and accuracy. For over 20 years Bliley has supplied the crystals used in fine equipment by research manufacturing and engineering organizations.

ULTRASONICS: Quartz blanks produced to customer specifications for ultrasonic application or research. Material carefully processed to individual requirements.

DELAY LINES: Fused quartz delay lines custom-built to specifications.

CUSTOM ASSEMBLIES: Facilities are available for volume production of complete crystal oscillator sub-assemblies in accordance with military specifications.

Bliley

ELECTRIC COMPANY
UNION STATION BLDG. • ERIE, PA.

REGULATED D. C. UP TO 1000 VOLTS AT 500 M. A.

*Featuring continuously variable
output voltage Without Switching*

● Here are four power supplies especially designed to cover a wide range of applications in development and production. These instruments feature continuously variable output voltage, good regulation, low hum level, good stability and overload protection. Models 200-B, 204-A, 205-A and 207-B will operate from line input of 105 to 125 volts A.C. 50-60 cycles and provide rated regulation within this change. Examine the specifications carefully and you may find that one or more of these units has an application in your research or production program.



MODEL 204-A 0-500v D. C. at 300 MA.

Output Voltage:
0-500v D.C. at 300 Ma. regulated
6.3v A.C. at 6 Amps. unregulated
Regulation: Within 1% from 30-500 v
Hum: Within 10 millivolts at full load
Meters: 0-500v D.C.
0-300 Ma. D.C.
Negative or positive side of
high voltage output may
be grounded.

MODEL 207-B 200-1000v D. C. at 500 MA.

Output Voltage
200-1000v D.C. at 500 Ma. regulated
Regulation: Within 1% from 200-1000
Volts
Hum: Within 20 millivolts at full load
Meters: 0-1000v D.C.
0-500 Ma. D.C.
Negative side of high voltage
grounded.

MODEL 205-A 100-325v D. C. at 150 MA.

Output Voltage:
100-325v D.C. at 150 Ma. regulated
0-150v D.C. at 5 Ma. regulated by VR tube
6.3v A.C. at 6 Amps. unregulated
Regulation: Within 1% from 100-325v D.C.
Hum: Within 10 millivolts at full load
Meters: None
Negative or positive side of high voltage
output may be grounded.

MODEL 200-B 0-325v D. C. at 125 MA.

Output Voltage:
0-325v D.C. at 125 Ma. regulated
6.3v A.C. at 6 Amps. unregulated
Regulation: Within 1% from 20-325 V
Hum: Within 10 millivolts at full load
Meters: 0-500v D.C.
0-150 Ma. D.C.
Negative side of high voltage grounded.

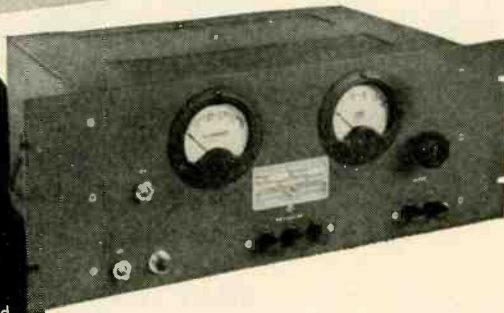

Detailed information on any or all of the instruments above will be sent upon request. Price and delivery information will also be forwarded at the time of your request. Send for Catalog "A"—there is no obligation.

ELECTRONIC MEASUREMENTS COMPANY

Red Bank



New Jersey

REGULATED POWER SUPPLIES — VACUUM TUBE VOLTMETERS — SIGNAL GENERATORS

VOLTAGE REGULATING TRANSFORMERS

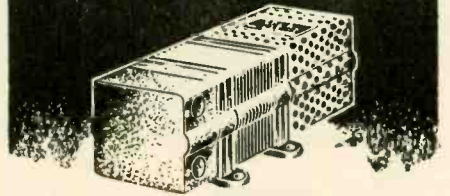

Patented SOLA Constant Voltage Transformers provide the following advantages: Automatic, instantaneous regulation within $\pm 1\%$ regardless of primary variations of 30%. No moving or expendable parts . . . no manual adjustments or maintenance . . . self-protecting against short circuit . . . available in a complete range of capacities and special types.

Write for Bulletin DCV-102. We welcome any inquiries regarding specific applications to your requirements.

SOLA *Constant Voltage*
TRANSFORMERS

SOLA ELECTRIC CO.

4633 W. 16th Street, Chicago 50, Illinois

a plus feature

Immediately following the
Product Listings in the
DIRECTORY SECTION

of this Issue

is a list of more than

2500

TRADE NAMES
of electronic and
allied products.

They are intended for
your use in determining
the manufacturer's name
when only
a trade name is known.

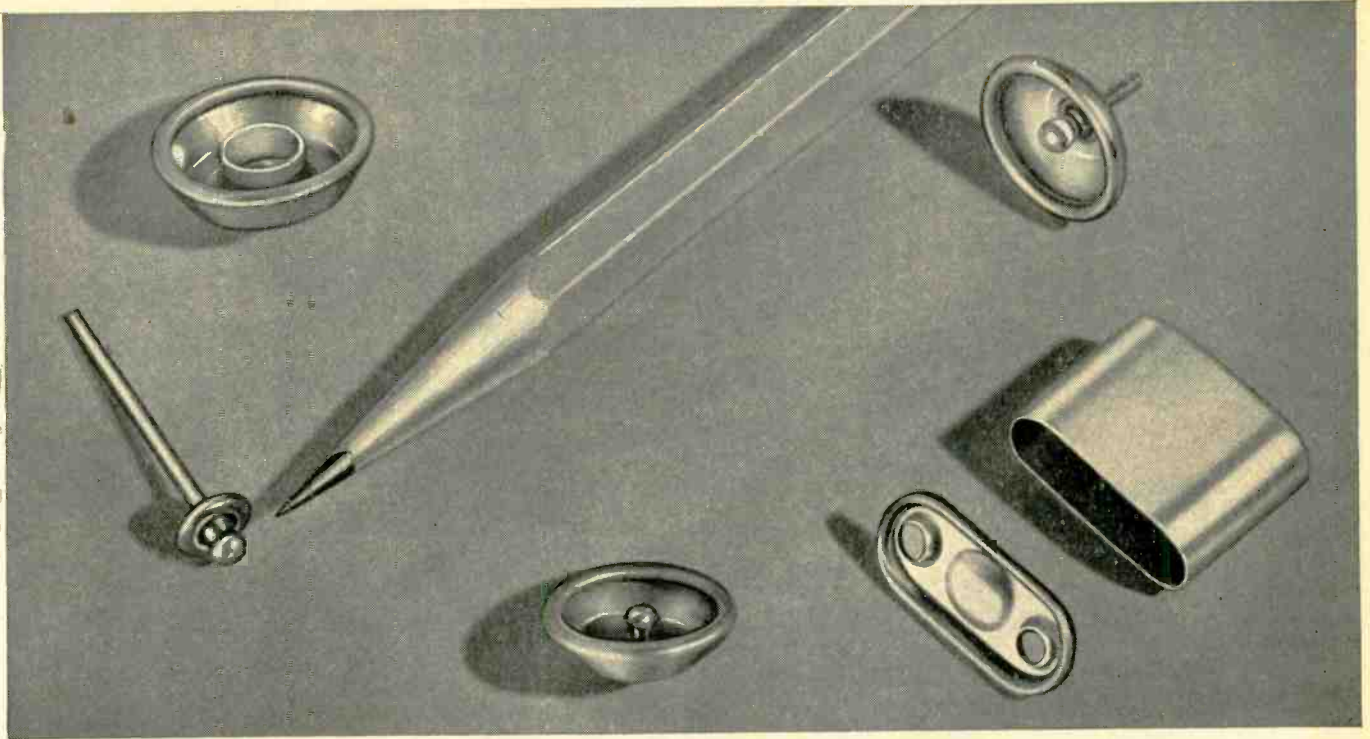

Hair-line Leakers are Eliminated in these cathode-ray tube parts and crystal cartridge components for glass-to-metal sealing. Standard Volkert items, they are formed to close tolerances from Allegheny HC-4 Sealmet and Kovar.

Volkert offers you Precision...Volume...Low Cost in Stamped Metals

A pioneer in the application of stamping and forming techniques to electronic components, Volkert is well equipped to help you solve unusual parts problems when difficult-to-form materials are involved.

For other difficult glass-sealing applications, Volkert can furnish you with engineering help...design necessary dies, no matter how complex...mass produce high-quality parts.

Write today for your copy of the 16-page brochure, "3-Way Facilities for Precision Stampings." It tells how Volkert can serve you with facilities for design engineering, tooling and production—all combined under a single roof.

JOHN VOLKERT METAL STAMPINGS, INC., 222-34 96th Ave., Queens Village 8, N. Y.



Volkert

PRECISION STAMPINGS



*Selenium Rectifiers
Associated Parts
D.C. Power Supplies*



We are in a position to furnish selenium stacks, transformers, filtered and unfiltered power supplies and rectifier sub-assemblies to specifications. Quotations forwarded promptly.

Opad-Green
COMPANY

71-5 Warren St. New York 7, N. Y.

Phone: BEekman 3-7385-6

OVERLAY

TUBING

STRIPE

WIRE

The Finest of Laminated Materials . . .

We are providing manufacturers with a complete line of precious metals laminated to non-precious base metals made to their exact specifications within the following limitations:

SHEET STOCK: Maximum width—5"
Minimum width—1/4"
Thickness—down to .003"

TUBING: Maximum diameter 1" x .050" wall

WIRE: All sizes down to .0045" diameter also squares, rectangular and odd shapes.

In addition to laminated materials we also furnish alloyed gold and silver in sheet, wire or tubing form.

The many varied applications of our materials cannot be listed here, but you are cordially invited to inquire for information regarding your requirements.

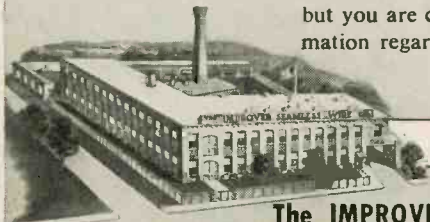

The Home of IMPROVED Service

The IMPROVED SEAMLESS WIRE COMPANY
INCORPORATED 1898
775 Eddy Street, Providence 5, Rhode Island

HEINZE BLOWERS



TYPE DD

Double blowers for applications requiring 100 CFM of air. Powered by Type D shaded pole induction motor. Requires infrequent oiling. Non-radio interfering. For 115 volts, AC, 60 cycles. 35 watts. 3150 RPM (free air). Other voltages and frequencies on request.

TYPE DS

Single blower, with all the advantages of Type DD, but approximately half the air delivery. 115 volts, AC, 60 cycles. For CW and CCW operation. 35 watts. 3100 RPM (free air). Other voltages and frequencies on request.



TYPES ZSD AND ZRD

Quiet, dependable units, delivering 100 CFM. 4 pole motor and large balanced air rotor. ZRD has absolute minimum of vibration. 115 volts, AC, 60 cycles. 1650 RPM (free air) 45 watts. Available for 230 volts or 50 cycle operation.



TYPES ZSS AND ZRS

Most compact 50 CFM blowers available. Sturdy low speed Z shaped pole induction motor, 3 3/8" balanced air rotor. 115 volts, AC, 60 cycles. 1650 RPM (free air) 40 watts. Can be supplied for 230 volt operation. Various mountings.



TYPE F

For cooling electronic tubes in transmitters, induction heaters and diathermy equipment. 115 volts, AC, 60 cycles. 3000 RPM (free air). F2S, single blower, 10 CFM. F2D, double blower, 20 CFM.

SUB-FRACTIONAL HORSE POWER MOTORS

10 standard types. Special blowers or motors made to your specifications.

Heinze Electric Co
685 Lawrence Street
LOWELL, MASS



**Leads the Field
in Analog Computers
and Servo System Components**

REAC
(Electronic Analog Computer)

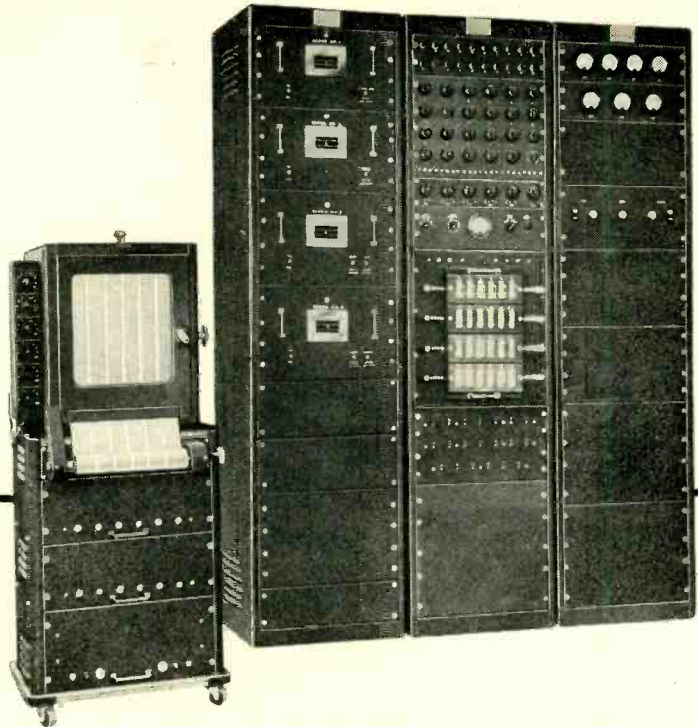

for use as a
SIMULATOR • TESTER • COMPUTER

REAC is the improved electronic differential analyzer for speedy, dynamic solution of simultaneous linear and non-linear differential equations which makes completely practical the mathematical approach to research and engineering problems.

REAC Computer installations are capable of expansion to an as yet undetermined degree simply by adding of extra units—there is no “dead end.” All components and computers are flexibly interconnected by means of the portable pre-patch panels, permitting rapid program-

ming of the most complex problems. The REAC and its associated equipment form a complete and diversified Computer and Simulation Laboratory. Now under development is an electronic multiplier and resolver for high-speed applications.

Also included in the REAC Computer Line is a wide variety of recorders, plotting units, electro-mechanical and electronic input function generators and similar equipment.

**universal
precision
resolvers**

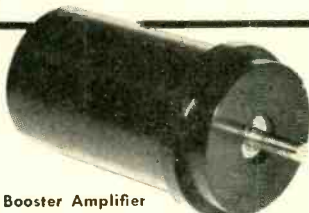

Available with or without Booster Amplifier

- Minimum functional error
- Minimum inter-axis error
- Minimum null and buckout voltages
- Minimum variation of transformation ratio

resolver capable of operation within frequency range of 10 to 40,000 cps.

**standard
breadboard
instrumentation
parts**

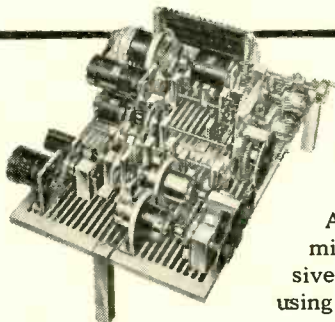

Reeves Instrument Corporation manufactures a complete line of precision breadboard parts for economical construction of experimental servos and computers, including precision gears, component hangers, bearing hangers, slotted mounting plates, etc.

All parts are highly standardized for maximum flexibility, permitting changes and additions to be made quickly and inexpensively. Drafting and machine shop time is completely eliminated using this unique precision mechanical breadboard system.

Reeves Instrument Corporation also possesses complete facilities for production of high-precision gears, and offers expert engineering development service in all applications of electronic and electro-mechanical systems.

For complete information and catalogs please write:

REEVES INSTRUMENT CORPORATION, Dept. E
215 East 91st Street • New York 28, N. Y.

8131

The leaders specify
Tensolite

TYPICAL
MINIATURE WIRES and CABLES

Plastic Insulated HOOK-UP

SIZE 32 AWG
(7/40)
O.D.—.030"

CODE 1507 A-1

Cotton Covered SHIELDED LEAD

SIZE 30 AWG
(6/38)
O.D.—.075"

CODE 1919 D-1

SHIELDED 4-Cond. TWISTED CABLE

SIZE 27 AWG
(7/35)
O.D.—.120"

CODE 2059 F-4

OTHER CONSTRUCTIONS IN STRANDED
SIZES FROM #40 TO #20 AWG

• Free wire samples and information on request. Special constructions made to your specifications.

MINIATURE
FLEXIBLE INSULATED
WIRE & CABLE

CABLES { TWISTED
PARALLEL
BRAIDED

BARE COPPER }
TINNED COPPER } **SHIELDS**
SILVER PLATED }

BRAIDS { COTTON
NYLON
PLASTIC*

*TENSOLITE'S exclusive plastic
film-covered Fiberglas

Leading engineers specify TENSOLITE
Miniature Wire and Cable

because- miniaturization
programs demand less weight, less space
and greater flexibility. Only TENSOLITE is
devoted exclusively to this field — assuring
you of faster service, lower cost, supreme
quality, advanced design and know-how,
and specialized facilities.

TENSOLITE
INSULATED WIRE CO., INC.
196 MAIN STREET, TARRYTOWN, N. Y.
Tarrytown 4-2616

Hold on /
to this book /

It will be
June 1952
before another
edition is published

IT IS THE MOST COMPLETE,
AUTHORITATIVE AND UP-TO-DATE
DIRECTORY OF ELECTRONIC AND
ALLIED PRODUCTS AVAILABLE.

It gives you the manu-
facturers of each of
more than fourteen
hundred electronic
and allied products.

Measure Time Intervals



From 10 Microseconds to 3 Seconds

The time interval between any two components in electrical, mechanical or electro-mechanical systems can now be measured, simply and accurately, with American Chronoscope Equipment.

The Model 211 Input Adapter used in conjunction with the Model 110 American Chronoscope separates the functions of STARTING and STOPPING the measurement of time. Simply connect the Start and Stop leads from the adapter to any two components of a system under test. Only the first complete elapsed time interval presented is accepted. This reading is indicated on the Chronoscope and remains fixed until reset.

PRICES

Model 110 Chronoscope \$475
Model 211 Input Adapter . . . \$265

For complete description on these
and other Chronoscopes and
Adapters, write for Bulletin 200 A



American Chronoscope

CORPORATION
MOUNT VERNON, N. Y.

316 WEST FIRST ST.



. . . gives you information
as to where they are in pro-
duction or available in a
reasonable time and unre-
stricted for general indus-
trial use.

1951-1952

electronics
BUYERS'
GUIDE

Please mention this book when
buying or inquiring from it.

**Simplify Your Wiring With
KULKA TERMINAL BLOCKS**

Eliminate Splicing • Stop Leaks and
Shorts • Increase Insulation

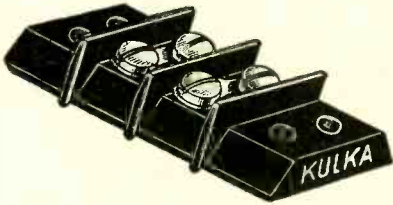

Blocks of high tensile strength Bake-
lite (or other plastics to gov't spec.)
and come in 4 sizes—with 1 to 23 ter-
minals. Screws and solder lugs of
nickled brass. Lugs in several
styles, also eyeleted to block.
Marker strips come plain or printed,
or blocks can be engraved.

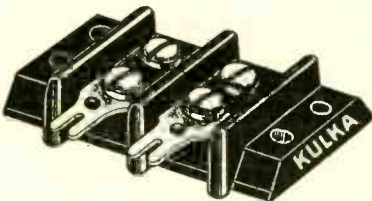

Write Dept. E for Catalogue

KULKA

ELECTRIC
MFG. CO. INC.
Mt. Vernon, N. Y.

**This Year
The
BUYERS' GUIDE
inaugurates**

**A
Where-to-find-it Guide
to the
1930-1939
electronics'
editorial
contents**

A cumulative editorial
index to the first ten
years of **ELECTRONICS**
Pages C-1 to C-36

Next ten years in next
year's GUIDE.

Airtron

DESIGNS AND PRODUCES

Flexible and Rigid

WAVEGUIDE

COMPONENTS

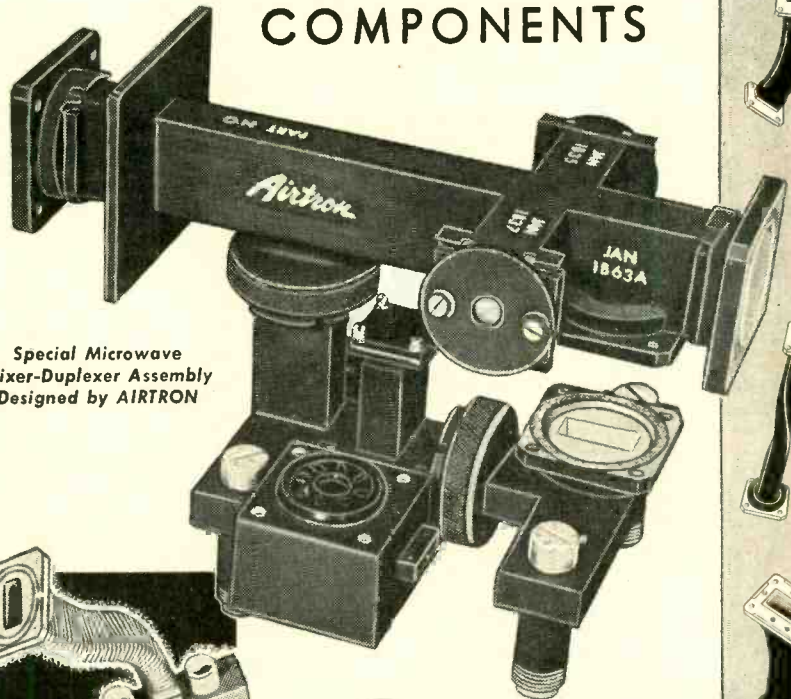

Special Microwave
Mixer-Duplexer Assembly
Designed by AIRTRON

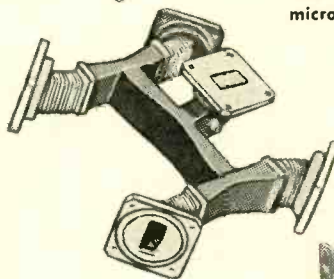
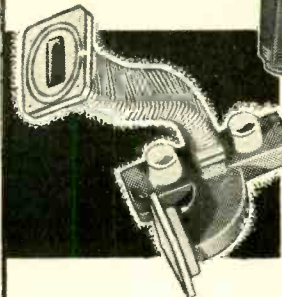

From the smallest waveguide compo-
nent to complete transmission systems...
from the first "doodle" memo or blueprint
to the finished precision product... make
AIRTRON your FIRST source for all types of
microwave plumbing. Unique in back-
ground, technical savvy, plant
facilities and the WILL to
SERVE, this organization is
prepared to engineer and
manufacture your staple or
special requirements in:

- Mixers
- Duplexer Assemblies
- Magic Tees
- Waveguide Switches
- Elbow Bends
- Elbow Miters
- Twisted Sections
- Rigid Twists
- Choke Fittings
- Flexible Waveguides
- Straight Section
- Rotary Joints

Send for AIRTRON
Engineering Data on
Microwave Plumbing



Airtron
INC.

105 East Elizabeth Ave., Linden, New Jersey
BRANCH OFFICES
Baltimore Los Angeles New York
Boston St. Louis Dallas Dayton



NEW! FREQUENCY AND TIME MEASUREMENTS
ACCURATELY . . . CONVENIENTLY!

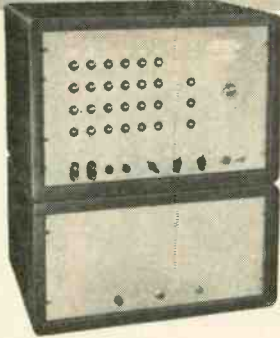

-using $f = \frac{N}{t}$

ANY FACTOR
MAY BE
MEASURED
FOR FIXED
VALUE OF
THE OTHER

**Universal 6-in-One
MEGACYCLE
FREQUENCY-TIME
COUNTER**

Model 801
by **Potter**

Now, the Potter Instrument Company offers all in one equipment, the features heretofore available only in separate counting systems. Two complete counting channels, a 100 kc crystal oscillator time base and unique gating circuits are combined to provide the new FREQUENCY-TIME COUNTER.

FREQUENCY MEASUREMENTS	0 to 1 mc range by counting cycles per pre-selected time or by measuring time per pre-selected count. Accuracy 0.001% minimum.
TIME INTERVAL MEASUREMENTS	0 to 10 seconds \pm 10 microseconds.
FREQUENCY RATIO MEASUREMENTS	Ratio of two external frequencies can be measured.
SECONDARY FREQUENCY	100 kc crystal oscillator with divided frequencies available at 10, 1 kc and 100, 10, 1 cps.
TOTALIZING COUNTER	Six decades, pulses 0 to 1 mc, sine wave 10 cps to 1 mc.
DIRECT RPM READING TACHOMETER	Through the use of an external 60 count per revolution photoelectric disc generator an accuracy of \pm 1 rpm is obtained.

Please address inquiries to Dept. 6-A



POTTER INSTRUMENT COMPANY
INCORPORATED
115 CUTTER MILL RD., GREAT NECK, NEW YORK

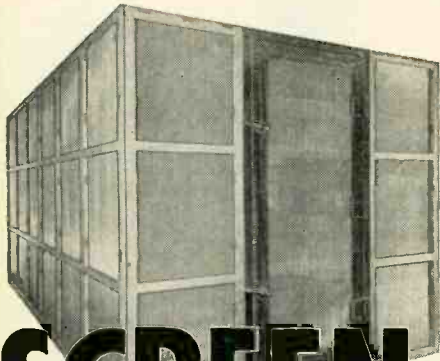

**HIGHER ATTENUATION
. . . at no greater cost**

Built to match the most exacting requirements for radio interference reduction, ACE SCREEN ROOMS cost little or no more than home-made rooms of far lower filtering and shielding efficiency. Used and approved by leading laboratories and plants.

SCREEN ROOMS

READY-BUILT • READY TO INSTALL

- ✓ Provide attenuations of 100 to 140 db. —at frequencies from 0.15 to 10,000 mc.
- ✓ Easy to install—easy to move to a new location or to enlarge.
- ✓ Fully proved in more than 6 years of use.
- ✓ Standard and special types available for every need.



ACE ENGINEERING and MACHINE CO., INC.

3644 N. Lawrence St.

Philadelphia 40, Pa.

Telephone:
REgent 9-1019

Want to know
about the...

AUGETRON

ECCLES-JORDAN CIRCUIT

KATHETRON TUBE

MEKAPION TUBE

PERMATRON

PETOSCOPE

SCHLIEREN METHOD

SCOPHONY

SEMAGRAPH

SIRUFER

SYNDEC

THEREMIN

TRATONIUM

VODER

or other early
electronic
developments?

You can find out about
them in the early issues
of ELECTRONICS.

The cumulative index to
ELECTRONICS' first dec-
ade, pages C-1 to C-36
in this book, tells you
where to look.

SIGMA

Sensitive Relays









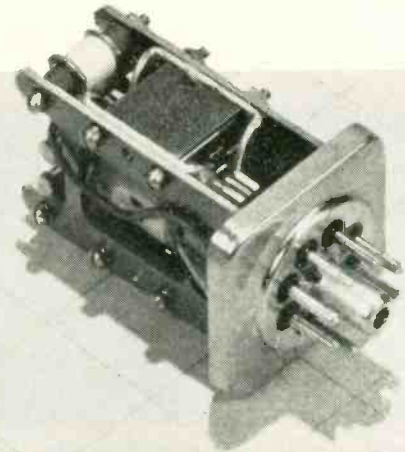
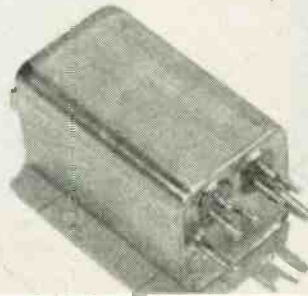
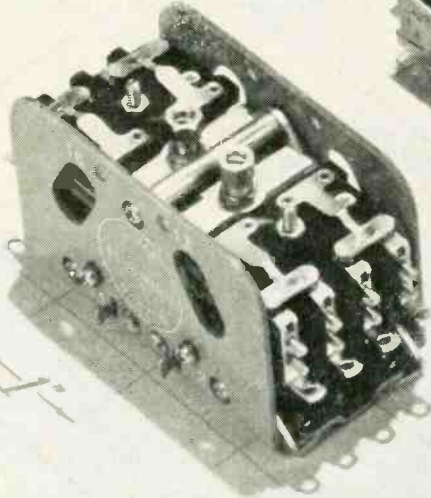
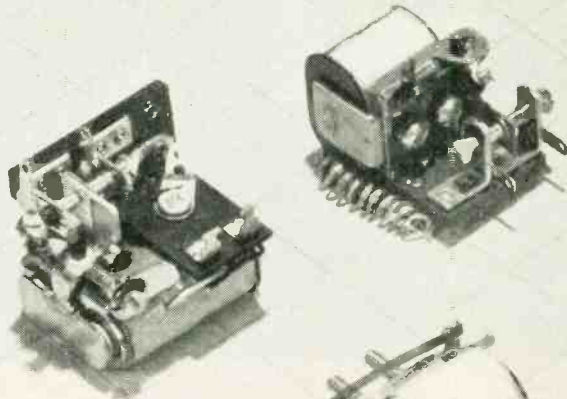

















AVAILABLE SERVICE

1. Selection from six basic designs, each with many enclosure and mounting styles. Each such selection may be ordered with a coil resistance and adjustment chosen from a list of standard codes. The classification chart below, from the new catalog, calls attention to the most obvious points of comparison between design series.

2. Specification by our application engineers of the relay they would use if faced with your problem.* This includes selection of type and enclosure as well as design of special adjustment and electrical characteristics, all subject to your approval and test. The resulting specification is your property and will be disclosed only at your request.

*Don't fail to describe all of it, so as to reduce to a minimum our guesswork!



RELAY SERIES	SWITCH TYPE (MAX. CONTACT ARRANGEMENT)	SWITCH RATING*	SENSITIVITY		MAXIMUM COIL RESISTANCE OR IMPEDANCE	MAXIMUM COIL DISSIPATION (40° C rise)†	SPEED RANGE**	MOUNTINGS, ENCLOSURES, AND DESIGNATIONS			PARTICULAR FEATURES
			Maximum (Standard)	**Aircraft**††				Open Frame	Dust Cover	Hermetic Seal	
4	SPDT (1-C)	2 amp.	.02 watt DC	.04 watt DC	12,000 ohms	1.5 watts 85° C	.002-.015 sec.	4F 	4A  4R 	4RJ 	Medium price, sensitivity, and precision.
5	SPDT (1-C)	2 amp.	.001 watt DC	.010 watt DC	16,000 ohms	2.0 watts 100° C	.004-.020 sec. Slow release, with slug, available.	5F 	5AH  5R 	5RJ  5JO 	High sensitivity, shock resistance, stability, and vibration resistance.
			.007 watt AC, internal rectifier	.015 watt AC, internal rectifier							
41	SPDT (1-C)	2 amp. some styles 5 amp.	.04 watt DC	Not generally recommended	12,000 ohms	1.5 watts 100° C	.002-.015 sec. Operates in 1st half cycle.	41F  (other open mountings available)	41R  41RO 	41RJ  41JO 	High AC sensitivity, long mechanical life, fast—good for pulsing; high load ratings possible; low price.
			0.1 VA AC 60 cps.	Not generally recommended	190,000 ohms	2.5 VA 100° C					
6	4PDT (4C)	2 amp. 5 amp. with SPDT DPDT	.05 watt — 4C contacts .012 watt — 1C contacts DC POLARIZED		25,000 ohms (12000/12000 in dual coils)	3.0 watts 85° C	.007-.05 sec.	6FX  6FY  6FZ 		6HX  6HY  6HZ 	Polarized; biased, latching or 3-position (null-seeking); high gain (load power/operating power ratio); multi-contact.
7	SPDT (1-C)	2 amp.	.001 watt, switching, gen'l .0001 watt, keying setting DC POLARIZED		12,000 ohms (3200/3200 in dual coils)	1.5 watts 85° C	.001-.007 sec.		7AOX  7AOY  7AOZ 	7JOX  7JOY  7JOZ 	Polarized; biased, latching or 3-position (null-seeking). For teletype and keying or pulsing, also switching and control functions.
22	DPDT (2-C)	2 amp.	.04 watt DC — 2C contacts .02 watt DC — 1C contacts		12,000 ohms	1.0 watts 100° C	.004-.020 sec.			22RJ 	Miniature, double-pole; maximum shock resistance and precision.

* Nominal, 24VDC or 115VAC resistive; medium-duty life, eg. 100,000 operations.

** Approximate, as governed by normal variations in driving circuit.

† Any duty involving vibration up to 10g while in use.

†† At operate voltage, operated. Unoperated, approx. 1/2 this value. Varies inversely with applied voltage.

§ Sum of ambient plus temperature rise not to exceed temperature given for each relay. Thermal time constant varies from 10 to 30 minutes. For higher temperatures, inquire of factory.

Write for fully descriptive catalog

SIGMA INSTRUMENTS, INC., 180 PEARL STREET, SOUTH BRAINTREE 85, MASS.





I/S Micro-Processed Springs hold shape—dimensions and elastic properties 2 to 10 times more accurately than conventionally made springs. Our entire facilities are devoted exclusively to the fabrication of Beryllium Copper springs. Our Engineering Department is available at all times to assist manufacturers and designers in solving their problems in the application of Micro-Processed Beryllium Copper Springs.

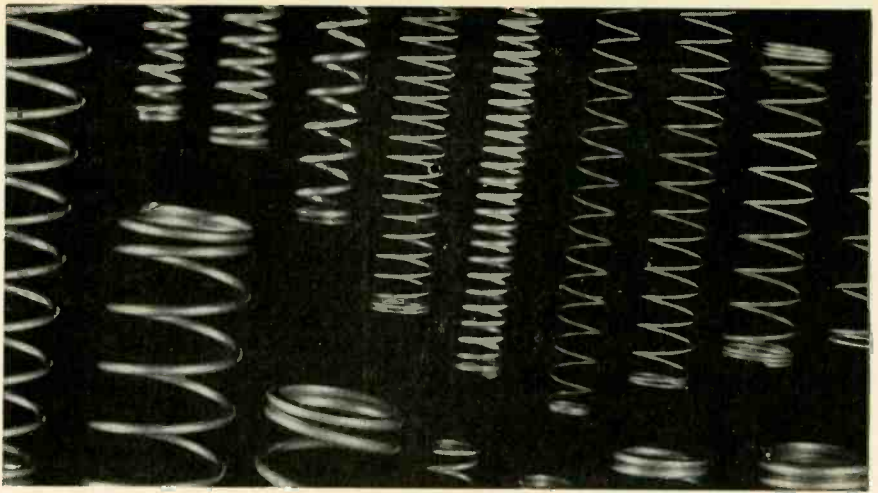

■ Helical Compression Coil Springs are custom made from 2% Beryllium Copper, and hardened after forming to a tensile strength of 185,000 to 220,000 psi.

Micro-Processed Beryllium Copper Springs

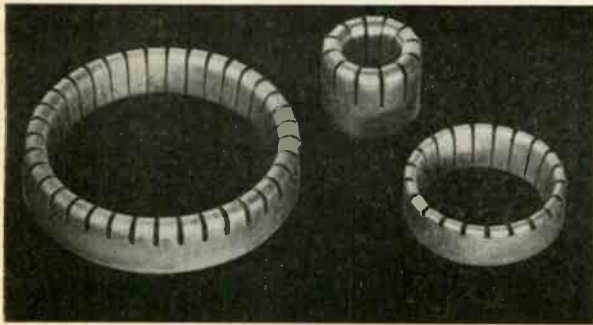

■ Standard Rings for 2C39 tube, available on short notice. Similar rings available to order.

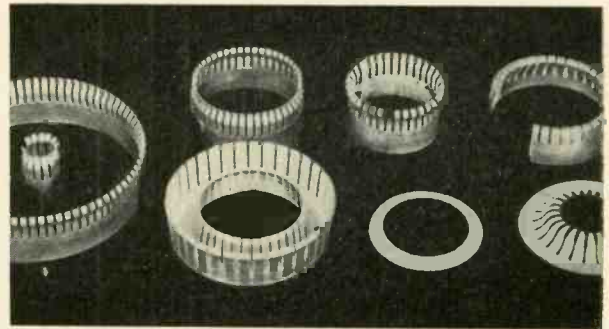

■ Micro-Processed UHF Contact Rings—made to order—truly circular—insure equal pressure from all fingers.

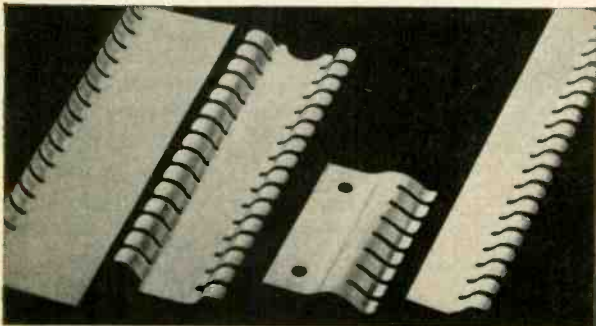

■ Grounding Strips for electronic equipment, available in a variety of contours without tool cost. Length—width—mounting holes—and finish optional.

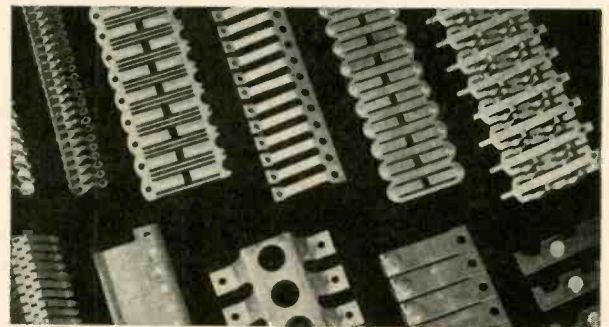

■ Beryllium Copper Springs produced in strips extend the high-quality level of Micro-Processed flat springs into mass production quantities.

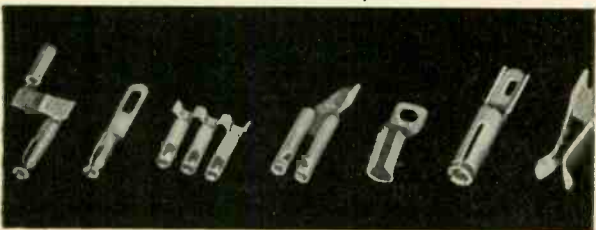

■ Contacts for Miniature Socket and Plug Boards are produced with automatic tooling. Pressure on plug pins and tab ductility controlled within close limits.

For full information on I/S Micro-Processed Springs—write, today for your free copy of our catalog . . . "Micro-Processed Springs of Beryllium Copper". Phone Little Falls 4-0280— or write to:

INSTRUMENT SPECIALTIES CO., INC.

258 Bergen Boulevard Little Falls, New Jersey

★ Specialists in the design and manufacture of precision

AUDIO COMPONENTS
MINIATURES AND SUBMINIATURES

MRB-3 miniature dynamic receiver and microphone



Model MRB-3

has excellent wide-range frequency response characteristics, maintained flat by the Patented Permoflux acoustical damping method. Utilizes a self-formed voice coil. Sensitivity—115 db in 6 cc

coupler with 1 m.w. input. Overall diameter 1" height 11/16". Can be supplied with miniature input or output transformers in any impedance.

TRANSFORMERS

Type T1 and T2: These subminiature units provide power efficiency from 80-90% with high voltage breakdown characteristics and extremely low susceptibility to electrolytic deterioration. Frequency response is ± 2 db from 100 to 8000 CPS. Impedances up to 200,000 ohms and windings with inductive reactances up to one megohm. Ideal for use with Permoflux microphone-receiver units and headsets. T1 and T2 transformers are available magnetically shielded, either with or without the hermetically sealed feature.

PT and PTS Series: Identical in efficiency, construction and features to T1 and T2, except that they are completely encased in a wax filled metal container. The container is capped with a small fibre panel. Leads are brought out at the bottom of the cans unless otherwise specified. PTV, PTH and PTS transformers can be supplied hermetically sealed with lead out construction through fused glass insulators.

HT and VT Series: Are Standard Output transformers for Radio and Television use. Unusually high efficiency is gained by use of bobbin windings.

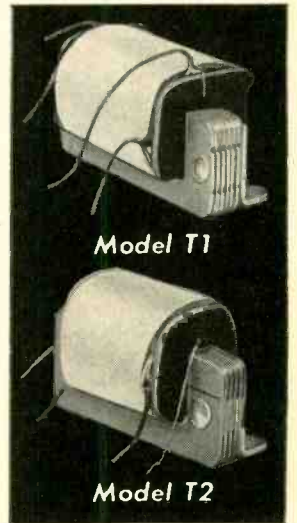

Model T1

Model T2

STANDARD AND HIGH FIDELITY DYNAMIC HEADPHONES

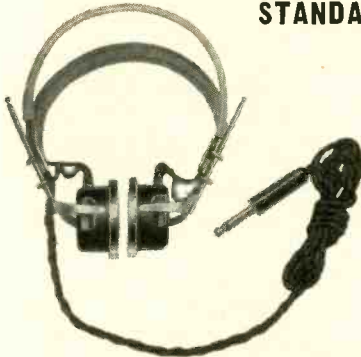

Are world famous and quality-recognized products of Permoflux Corporation. Sturdy and comfortable, they are built to withstand excessive shock, high humidities and a wide range of temperatures without impairing their high efficiency and dependable performance. Patented acoustical damping provides a flat frequency response to 4500 CPS in standard models and through 10,000 CPS in Super High Fidelity models. Unparalleled in performance for broadcast studio, aviation, laboratory, and audiometer work.

Model	Ohms Total impedance	Earphone	Ohms impedance per phone
DHS-28 (Hi-Fidelity)	24	PDR-10	12
DHS-1 (Std. Fidelity)	24	FDR-1	12
DHS-17 (Hi-Fidelity)	600	PDR-8	300
DHS-15 (Std. Fidelity)	600	PDR-3	300
*DHS-31 (Hi-Fidelity)	4000	PDR-19	2000
*DHS-8 (Hi-Fidelity)	50	PDR-9	25
*DHS-22 (Hi-Fidelity)	8000	PDR-14	4000
*DHS-32 (Hi-Fidelity)	100,000	PDR-20	50,000

* Note: These and other special models manufactured to quantity order.

High Fidelity DYNAMIC EARPHONES



PDR Series: Offer improved performance under practically all operational conditions. Particularly outstanding is their smooth broad frequency response, articulation, power handling and ability to meet the rugged requirements of strenuous combat service where extreme noise exists. At high altitudes, in extreme temperatures and in regions of intense humidity, Permoflux DYNAMIC Units are daily proving their unflinching superiority.



EAR CUSHIONS

Model No. 1505 designed for use in aircraft provides exceptionally good seal against external noises but is comfortable for wear. Has kapok filled chamois doughnut on inner side of cushion. NA designation NAF-48490-1. Model No. 1250, small compact molded black rubber. Minimum pressure on ear, yet provides good acoustical seal. Army designation M-162.

PDR CATALOG No.	1	3	8	10	Also special Models on quantity order
OHMS IMPEDANCE	12	300	300	12	

8-INCH SPEAKER

"ROYAL EIGHT" compares with any 12-inch speaker. This average laboratory response curve of the Permoflux 8T-8-1 proves that it compares with the finest regardless of size or price. This is but one of a very complete line of loudspeakers ranging from 2 1/2" to 15".



DYNAMIC 2"

A midget dynamic speaker developed for use on the battlefield. It has proven its ability to withstand rugged treatment and extremes in temperature and humidity. Designed to be readily adaptable to two-way "hand held" communication equipment, small inter-office systems, "pocket" radios or any apparatus where a small highly efficient, light in weight speaker with smooth flat frequency response is required. This speaker is particularly adapted to close coupled response, such as provided by hand set or earphone use, and also makes an excellent MICROPHONE. Acoustic damping built into the speaker eliminates the usual resonance characteristics. EFF Factor, 1; Watts Max.—1.5; Voice Coil Diam.—9/16".

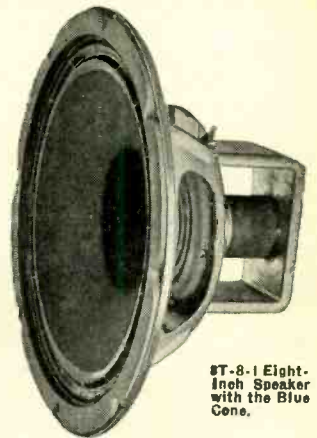
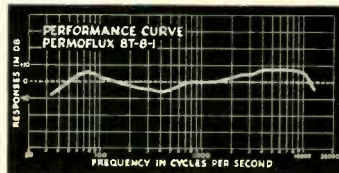

8T-8-1 Eight-Inch Speaker with the Blue Cone.

**COMMERCIAL
and MILITARY**
1" and 1½"
sub-miniature
**electrical
meters**

For industry, communications, aircraft, guided missiles and instrumentation. Smallest, lightest, most compact and accurate.



100-W 150-W



SPECIFICATIONS

100-W 1"	150-W 1½"
1500 V. Dielectric Strength RMS at 60 Cy.	1500 V. RMS at 60 Cy.
Lance Type Standard Pointer .770"	Lance Type 1.322"
1 oz. Approx. Weight	1½ oz.
Black Standard Scale	Black
White Markings	White
Ground	Ground
Zero Left (Center or Right Special)	Zero Left (Center or Right Special)

DIMENSIONS

100-W	150-W
A-1.250"; B-.328"; C-.687"; E-1";	A-1.688"; B-.328"; D-.875"; F-.500";

Feature sub-miniature D'Arsonval movement, black anodized aluminum case for easy mounting and sealing. Designed to meet applicable sections of government specs; self-contained; ready for use; accuracy held to within 3% full scale deflection.

1½" VU METER 153-W

Basic ii movement with rectifier and resistors self-contained; ready for use. Watertight seal units designed to meet applicable sections of government specs.

**MULTITESTER COMBINATION
OHMMETER & VOLTMETER
(A.C. & D.C. 4¾" x 5¼" x 2½")**

Write for engineering data for all items listed

**international
instruments**
INCORPORATED

333 EAST STREET
NEW HAVEN
CONN.



**An Insulating Varnish
for every ELECTRICAL UNIT**

FOR EVERY ELECTRICAL WINDING, there is a Borthig Insulating Varnish that will efficiently do the job including several special materials for television components and custom built coils.

BAKING VARNISHES:

No. K-252 Clear Synthetic Baking Varnish and No. F-150 Black Synthetic Baking Varnish: These excellent, general purpose baking varnishes are modern, polymerizing types and offer the maximum efficiency.

AIRDRYING VARNISHES:

No. 308 Black Synthetic Airdry and No. 353 Clear Synthetic Airdry: Where baking facilities are not available and also for application to shallow coils where deep penetration is not essential.

FINISHING TYPE INSULATING VARNISHES:

No. 400 (Homogenized) Red Enamel, No. 354 Clear Synthetic Airdry and No. 301 Black Oilproof Spirit Varnish: These protective coatings are generally applied over previously treated motor and transformer units as additional protection.

The No. 400 and No. 354 with a suitable fungicide added will meet the Army-Navy requirements for tropicalization. Ask for No. 400 F-5-X or No. 354 F-5-X.

No. 613 Red Masking Compound: For masking metal surfaces—just brush it on, allow 5 or 10 minutes to dry and peel it off after baking cycle—surface will be clean.

No. 545 Clear Lacquer: A special material for TV deflection yokes and small coil applications.

SOLVED PROBLEMS are another product we deliver!

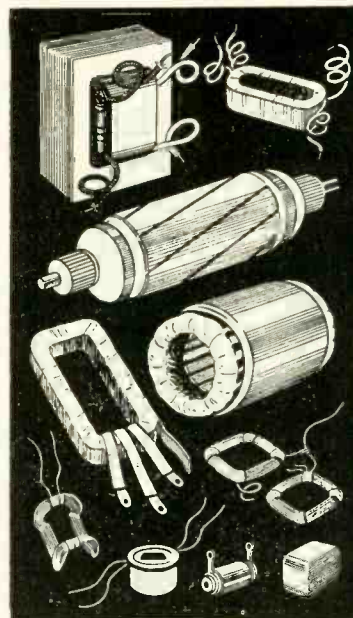

GEORGE C. BORTHIG CO., INC.



Insulating Varnishes
EAST RUTHERFORD, N. J. • P. O. BOX 115

HOBSON PRECISION COMPONENTS

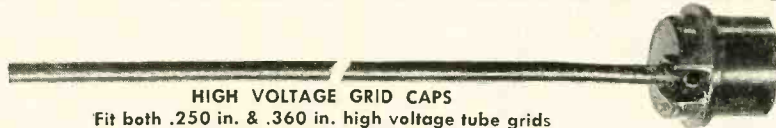

HIGH VOLTAGE GRID CAPS
Fit both .250 in. & .360 in. high voltage tube grids



ELECTROSTATIC PICTURE TUBE CONNECTOR
ELECTROLYTIC MOUNTING PLATES Fit 1 in. & 1 3/8 in. condenser cans

HOBSON BROS. • 4049 W. Fullerton St. • CHICAGO 39, ILL.

WALKIE-RECORDALL
• ON THE SPOT •
BATTERY RECORDER

RECORDS
Conferences
Interviews
Reports
Dictation
Inventory
Lectures
Sales Talks
2-Way Phone
Conversations
While
**WALKING,
RIDING,
FLYING**

THE ELECTRONIC SECRETARY

8 lb. Miniature
BATTERY RECORDER-PLAYBACK
Up to 4 hrs. of continuous, permanent, accurate indexed recording at a total cost of only 3¢ per hr. Instantaneous, permanent playback at no extra cost. Picks up sound up to 60 ft.
RECORDS IN CLOSED BRIEFCASE WITH "HIDDEN MIKE".

Write for FREE Illustrated Catalog No. 66

MILES REPRODUCER CO., INC.
812 Broadway New York 3, N. Y. Spring 7-7670-1



AMPERITE

HERMOSTATIC METAL TYPE

Delay Relays



PROVIDE DELAYS RANGING FROM 1 TO 120 SECONDS

FEATURES: — Compensated for ambient temperature changes from -40° to 110° F... Hermetically sealed; not affected by altitude, moisture or other climate changes... Explosion-proof... Octal radio base... Compact, light, rugged, inexpensive... Circuits available: SPST Normally Open; SPST Normally Closed.

PROBLEM? Send for "Special Problem Sheet"

Regulators

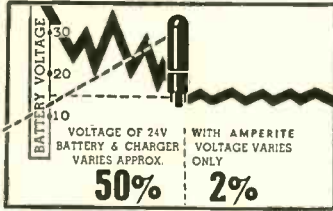

Amperite REGULATORS are the simplest, lightest,

cheapest, and most compact method of obtaining current or voltage regulation... For currents of .060 to 6 Amps... Hermetically sealed; not affected by altitude, ambient temperature, humidity.

Write for 4-page Illustrated Bulletin.

AMPERITE CO., Inc., 561 Broadway, New York 12, N. Y.

In Canada: Atlas Radio Corp., Ltd., 560 King St., W. Toronto

PAPER CAPACITORS

HERMETICALLY SEALED METAL CASE,
MOLDED, AND PAPER TUBULAR
RANGE 0.001 TO 2MFD
100 TO 2500 VOLTS

NATIONAL CAPACITOR COMPANY

1830 WESTMINSTER ST.

PROVIDENCE 9, R. I.

MANUFACTURERS

MOLDED AND FABRICATED

INDUSTRIAL RUBBER PRODUCTS

BUMPERS • BUSHINGS • EXTRUSIONS
GASKETS • GROMMETS • MOLDS • RINGS
ROLLS • SHEET • SLAB • SPRING • SPONGE
TIRES • TUBING • VACUUM CUPS • WASHERS
THOUSAND OF ITEMS IN CHICAGO STOCK—Est. 1919

DEFENSE ORDERS
GIVEN PROPER
ATTENTION

ATLANTIC INDIA RUBBER WORKS, INC.
571 WEST POLK STREET • CHICAGO 7, ILLINOIS.

Write Dept. E for Complete Catalog #44—All Phones: HARRISON 7-8290

INDUSTRIAL
RUBBER
PRODUCTS

RELY
on

desco

for Quality Engineering!

Desco-Coils to JAN Specs

... waxed, varnished, baked, thermo-setting plastic coated, vacuum impregnated, potted, etc.

UNIVERSALS

All types I. F., R. F., B. F. O. coils, etc. conforming to latest military design • All sizes Cup Core coils • Special coils—Permeability Tuned—Shielded—Unshielded • Oscillator coils—Video coils—Chokes.

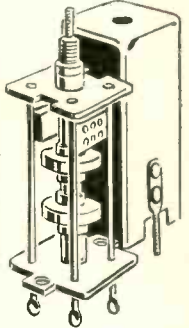

SOLENOIDS

All types—Single and Multiple Layer • Relay Coils • Audio-power transformer windings Bobbin Coils—Magnetic Head Coils—Recorder Erase Coils Paper Interleaved Coils Hermetically Sealed units in standard transformer cases.

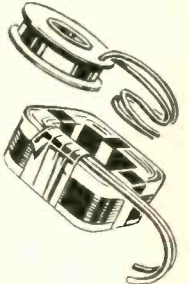

TOROIDS

All sizes including wedding rings—cased or uncased—wound on stabilized cores and heat cycled • Hermetically sealed Filters & Transformers of all types.

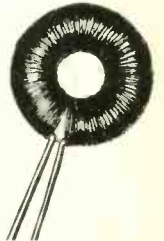

Coils also available to usual commercial requirements for TV, FM, AM receivers, etc.

Plug-in Housings — 30 Models



Versatile aluminum plug-ins, with threaded bases for stud mounting coils, relays, filters, crystals, resistors, condensers, etc. • Special models with permeability tuned coil forms—various pin arrangements—etc.

Your inquiries handled promptly...

DIETZ DESIGN
and Manufacturing Company
INDUCTANCE SPECIALISTS—Grandview, Missouri
FACTORY REPRESENTATIVES

Midwest Area Eastern Area
Withers & Ropek, 2400 W. Progressive Marketers, 41
Madison, Chicago 20, Ill. Union Sq., New York 3, N.Y.
Phone: Monroe 6-3498 Phone: Oregon 5-0775

Cable Assemblies for Electronic Defense Production . . .

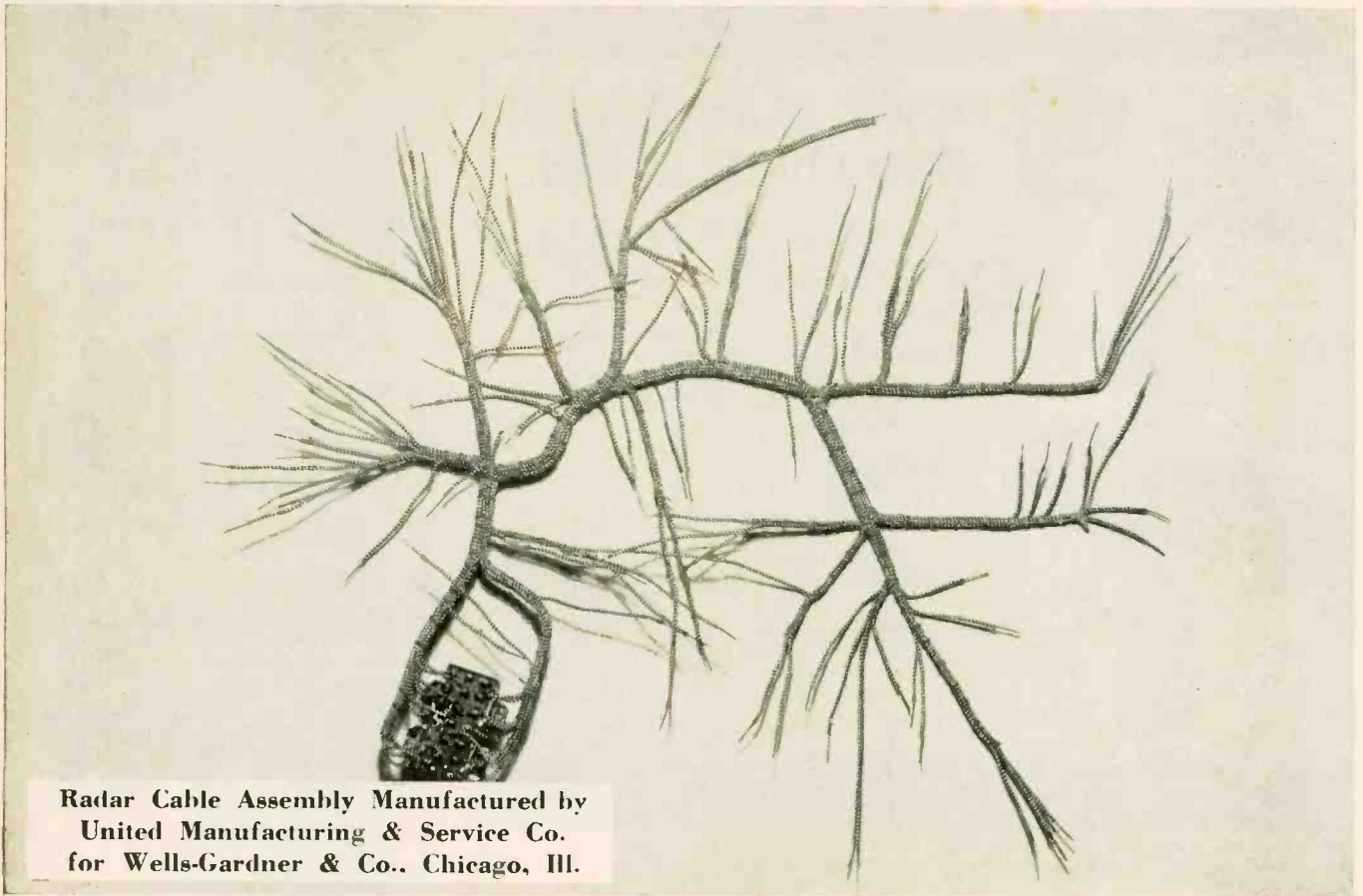

Radar Cable Assembly Manufactured by
United Manufacturing & Service Co.
for Wells-Gardner & Co., Chicago, Ill.

UNILECTRIC OFFERS YOU . . .

WAR PRODUCTION EXPERIENCE

Producing cable assemblies, harnesses, power cords, communication equipment, and leads for RADAR, FIRE CONTROL MECHANISMS, TANKS, TRUCKS, MOTORCYCLES, INSTRUMENTS and other equipment for such leading manufacturers as:

Wells-Gardner & Co., Chicago, Ill. • Waukesha Motor Co., Waukesha, Wis. • Lee Engineering Co., Milwaukee, Wis. • The Four Wheel Drive Auto Co., Clintonville, Wis. • Globe Union, Inc., Milwaukee, Wis. • Paragon Electric Co., Two Rivers, Wis. • Harley-Davidson Motor Co., Milwaukee, Wis. • Jacobsen Mfg. Co., Racine, Wis. • Cutler-Hammer, Inc., Milwaukee, Wis.

POST WAR EXPANSION OF FACILITIES AND EXPERIENCE

UNILECTRIC'S nation-wide peacetime operations have included designing and producing millions of wiring systems for hundreds of leading manufacturers of electronic controls, radios, automatic dryers, refrigerators, home freezers, displays, and many others.

This combination of engineering talent, factory facilities and production know-how is available NOW to cut your costs in your DEFENSE PRODUCTION. It costs you nothing to find out how UNILECTRIC can help you! Write or wire for details.

Ample skilled labor supply available.

UNILECTRIC WIRING SYSTEMS

MANUFACTURED BY

UNITED MANUFACTURING & SERVICE CO. • 415 SOUTH 6TH STREET, MILWAUKEE 4, WIS.

25
YEARS

ONE OF THE OLDEST NAMES IN
TRANSFORMERS...

KENYON

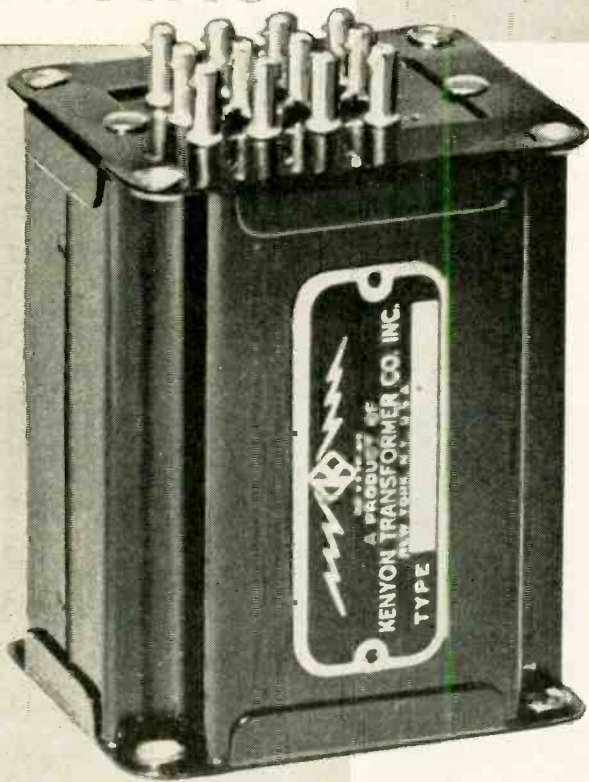

FOR OVER TWENTY-FIVE YEARS, KENYON has been selling engineering ability and know-how, as well as transformers and associated products. Yes, the KENYON "K" is a sign of quality, dependability and sound construction.

Whether it be the standard KENYON "T" Line or "specials" custom-built to your requirements — practically at catalog prices, you are always assured of skillful engineering, progressive design and rugged construction.

Leading manufacturers and engineers specify KENYON Transformers for many industrial, communication, sound and electronic applications such as:

- | | |
|----------------------|---------------------------|
| JAN APPLICATIONS | AUDIO AMPLIFIERS |
| BROADCAST | RADAR |
| INDUSTRIAL MACHINERY | EXPERIMENTAL LABORATORIES |
| AUTOMATIC CONTROLS | ATOMIC ENERGY EQUIPMENT |

Consult our engineering staff on any of your "special" problems at no obligation. Call or write now for our engineering representative.



For a complete story about specific ratings on KENYON transformers, send for your copy of the latest KENYON catalog edition now!



KENYON TRANSFORMER CO., Inc.
840 BARRY STREET • NEW YORK 59, N. Y.

VARIABLE DC HIGH VOLTAGE! RADIO FREQUENCY TYPE DC POWER SUPPLIES



MODEL 101A—Covers a range from below 5KV to 50KV with a maximum power output of 40 watts and an internal resistance of approximately 40 megohms. 500 microamperes of current are available over the entire range. For voltages up to 30 KV, 1 milliampere of current can be obtained. Can also develop voltages higher than 60KV under light load.

THE CAPACITY LOAD OF A LONG OUTPUT CABLE WILL NOT DISTURB THE RADIO FREQUENCY OSCILLATOR

ALSO AVAILABLE—MODEL 86—Capable of producing from 1 to 20KV at a maximum power output of approximately 10 watts and an internal resistance of about 30 megohms. This unit can furnish 250 microamperes of current over the entire range. For voltages up to 10KV, currents of 500 microamperes may be obtained.

OPTIONAL MODIFICATIONS TO MEET YOUR REQUIREMENTS
ARE AVAILABLE ON THE ABOVE STANDARD MODELS

.....
 ● SPECIAL NOTE: We are equipped to manufacture power supplies of any voltage or current ●
 ● within limitations of RF type circuit, on a "Built-to-Specifications" basis. Your inquiries are ●
 ● welcome. ●

INDUCTOGRAPH PRODUCTS, INC.

236A W. 55th Street, New York 19, N. Y. • JUdson 6-1549
Plant—Brookfield, Conn.

THIS IS THE

ONE BOOK

THE ONLY
ONE OF ITS KIND

In which
design engineers and
purchasing agents will find
a complete, accurate, and
up-to-date list
of the manufacturers
of all types of electronic
and allied products...
components and complete
equipment.

Keep it handy
for ready reference
throughout the year.

When buying, or requesting
product information be sure
to mention...

electronics BUYERS' GUIDE

GOVERNMENT APPROVED

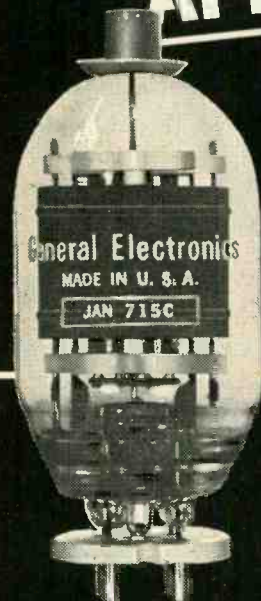

power tubes

Some of the power tubes on which General Electronics holds Jan-type approval:

- DR-3B29 Clipper Diode
- DR-250th Amp. osc. mod. (Hi Mu Triode)
- DR-809 R.F. Amp. Osc. Mod. Triode
- DR-808 R.F. Amp. Osc. Modulator Triode
- DR-3E29 Transmitting twin pentode amp.
- Other special tubes for the Services: 829B, 832A, 719A, 250TL

GENERAL ELECTRONICS' 715C PULSE AMPLIFIER TETRODE

Rated for inductive load application. Peak anode current — 15 amps. 15000 operating voltage. Max. duty cycle .001 microseconds.

For further information, write to:



101 HAZEL STREET PATERSON 3, N. J.

Also manufacturers of
television tubes with
vacuum-baked screens.

In Connectors... it's Alden First

The tremendous expansion in electronic equipment, uses and design call for connectors and connecting devices that are more than just holdovers from the battery set era. Here at Alden's we feel we are approaching the connector component problem with a conception most in keeping with the advanced electronic trends.

Our cable connector design avoids heavy plumbing type housings and rat nest wiring. Through the use of the exclusive Alden Top Connected Contacts, our connectors can be quickly supplied in volume—completely furnished with tailored leads—in designs that pack greater performance, higher quality into less space at lower cost.

In a whole new series of designs, Alden has engineered Components for Plug-in Unit Construction that allow the engineer to design electronic equipment so that it can be grouped as individual plug-in unit, sub-assemblies. These components can give electronic equipment instant accessibility for ease in manufacture and in service.

The same Alden design techniques and production approach used in our connectors and connecting devices is proving invaluable in computer component manufacture—as the Static Magnetic Memory, a new pulse handling and storage device best illustrates.

For engineered connections of the most timely design—look to Alden.

CONNECTORS

Carefully designed, low resistance contacts make top connections to wire leads to give you these exclusive features (1) 100% molded insulation around each clip and lead (2) no bulky housings or waste metal—require less space, less material (3) each lead has individual strain relief (4) mechanical hold means less danger of cold solder joints.

CRT 211/214 Series

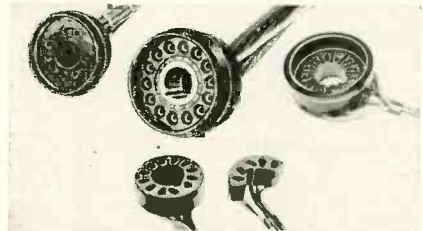

Pioneers in cathode ray tube connectors magnal, duo decal, diheptal—meet highest standards for gov't. instrument or TV work.

Non-Interchangeable 100 200/11 Series

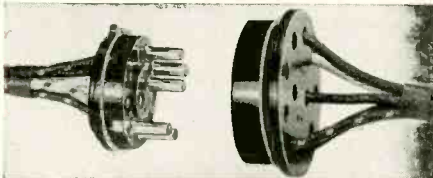

Multiwire connectors with 2 to 11 contacts in variable pin layouts. . . . Commercial replacement for AN connectors.

Plugs & Sockets 200FC/SH Series

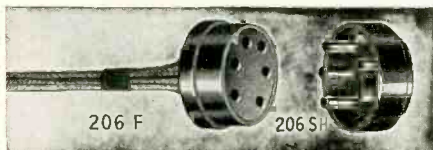

Ideal detachable terminal connectors—3 to 7 contacts—UL collars—top engineering.

ELECTRICAL SPECIALTIES



Smallest, most rugged UL approved AC convenience outlets available, 402 AC Series—Saves space and critical material.

RUGGED DIAL LIGHT SOCKETS



80 Series with exclusive Na-ALD "center file" contacts—hold each strand of wire tip against bulb base—for cutting through corrosion—crimps around wire insulation for strain relief.

MINIATURE PLUGS and SOCKETS

For all modern designs . . . recognized by top production men and engineers for their design—rivet or eyelet to chassis—UL collars—high voltage breakdown—top appearance.

Metal Seal 121/5 P441/5 Series

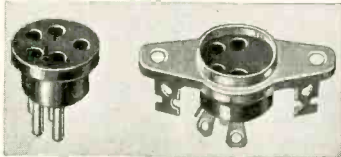

Ideal miniature 2 to 5 contact metal seal plugs and sockets for carrying power or signal—extremely compact and rugged.

Cable Connectors 907/9C 407/9P

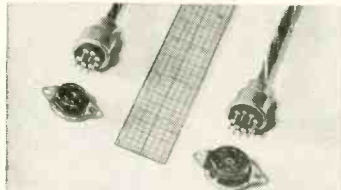

Ultra-compact 7 or 9 pin layout for low voltage applications—less than 3/4" diameter—with or without leads—metal shell for easy gripping.

Disconnects 500 Series

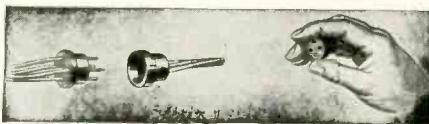

Most compact connector for AC current or signal—2 to 4 contacts.

Antenna 902/3PC 402/3BT-5 Series

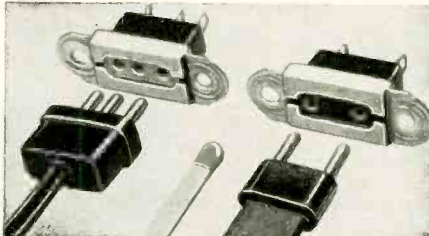

In wide use for low voltage connections on instruments and all types of electronic equipment.

High Voltage Disconnect 8101M/F



Leads and Body molded as one homogeneous unit in low loss polyethylene. Rated at 1500 volts AC or DC peak.

PLUG-IN COMPONENTS

Alden is pioneering a whole series of components for plug-in unit construction . . . (1) accessible, back connected, slide-in lock-in chassis (2) rugged, color coded back connectors (3) dress up housings (4) rugged bases for plug-in units and (5) quick acting, easily operable fastenings and locks for plug-in units (6) terminal card mounting system which allows related circuits to be wired rapidly in open as straight line bench work.

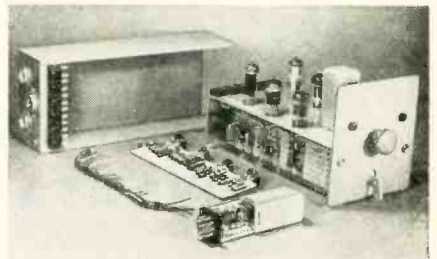

Extremely flexible plug-in kits allow you to design circuits and mount components as ultra assembly basis. Send for catalogue "Components for Plug-in Unit Construction."

COMPUTER COMPONENTS

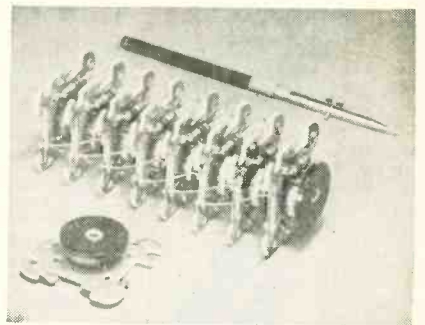

Manufacture of the revolutionary Static Magnetic Memory (a new device for pulse handling and storing developed by Harvard Computation Laboratory) is typical of Alden's ability to take the problem in the idea stage, develop a working production design and get into volume production. For further information, write for special technical bulletins on the Alden SMM.

UNIT CABLING

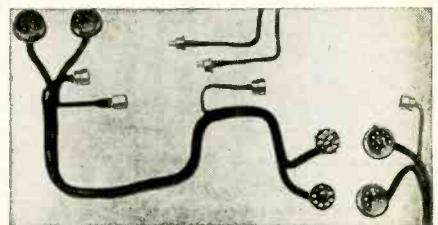

Alden can take your equipment and design and engineer to your requirements economic and efficient unit cables of good appearance. Cabling built as units allows instant continuity check and rapid replacement in the field.

TUBE CAPS FOR EVERY PURPOSE

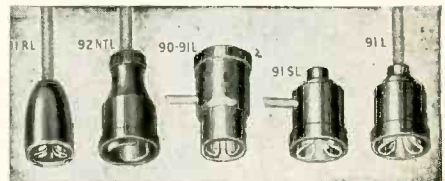

Alden has a tube cap connector to meet any need you might have. Contacts are carefully designed; leads have complete strain relief; connectors are fully insulated.



ALDEN PRODUCTS COMPANY

Dept. BG, 117 N. Main St.

Brockton 64, Mass.

SETTING EVER HIGHER STANDARDS OF PERFORMANCE

JK STABILIZED CRYSTALS

Performance is proof of product quality, and that's why JK STABILIZED CRYSTALS are held in such high esteem by those who depend on them.

Listed here are only a few of the many, many high quality crystals and ovens produced by the JAMES KNIGHTS COMPANY — the company that is constantly pioneering improved crystal performance.

Write now for complete catalog that lists them all, including the outstanding FS 344 Frequency Standard.

H-17

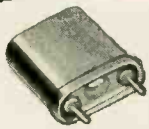

- Frequency Range 200 kc to 100 mc
- Hermetically sealed metal holders
- Wire mounted, silver-plated crystals
- Two type H-17 holders fit loctal socket.
- H-17 is military type HC6/U, CAATC No. 3R1-3

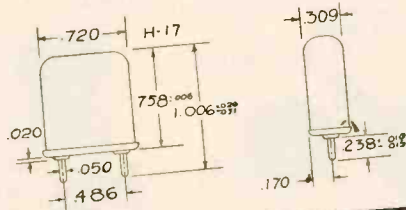

JKO-2



- Holds two type H17 (Military HC6/U)
- Normal temperature $75^{\circ} \pm 2^{\circ}\text{C}$
- Ambient range -55 to $+70^{\circ}\text{C}$
- Heater 6.3 volts, under 1 amp.
- Standard octal base

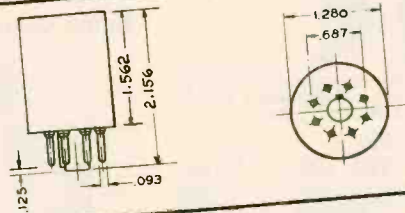

H-18



- Frequency range 80 kc to 2 mc
- Hermetically sealed metal holder
- Wire mounted silver-plated crystals
- H-18 has octal base.
- H-18-5 has standard 5 pin tube base.

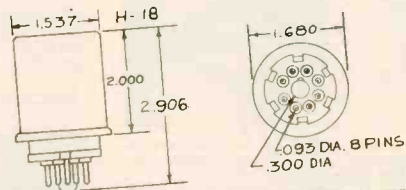

THE JAMES KNIGHTS COMPANY, SANDWICH, ILLINOIS

JK-57-MT



- Frequency range 400 kc to 1750 kc adjustable $\pm .01\%$
- Normal temperature $60^{\circ}\text{C} \pm 2^{\circ}\text{C}$ (adjustable $\pm 10^{\circ}\text{C}$)
- Ambient range for 60°C operation, -20 to $+58^{\circ}\text{C}$
- Heater 6.3 volts at 1-1/2 amp
- JK-57-M has standard 5 pin base, JK-87-M has octal base
- Low temperature coefficient plate will stay within FCC tolerance during warmup from normal room temperature
- FCC approved for broadcast use
- JK-57MT & JK-87MT have thermometer

JK-07



- Will hold any JK type crystal except H-6, H-18T and H-19
- Normal operating temperature $50^{\circ}\text{C} \pm 2^{\circ}\text{C}$
- Will hold temperature as much as 75°C above the ambient
- Supplied complete with Johnson No. 237 socket
- JKO-7E has sealed-in-glass thermostat for greater precision and longer life
- Available as JKO7 or JKO7E with 6.3 volt 10 watt heater or 115 volt 12 watt heater on either model
- Ideal for frequency standards and broadcast (FM & TV) FCC approved



CRYSTALS FOR THE CRITICAL

TRUSCON... a name you can **build** on

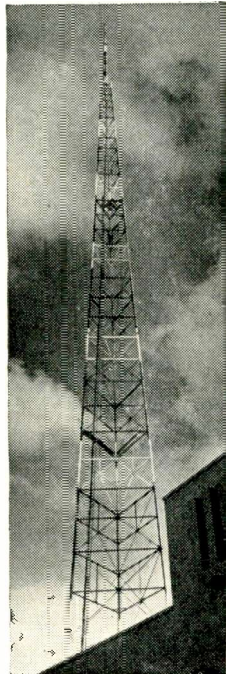

WOW, Omaha, Nebr., Truscon Self-Supporting Radio Tower, 500 feet high overall.

world leader in **better** radio tower engineering

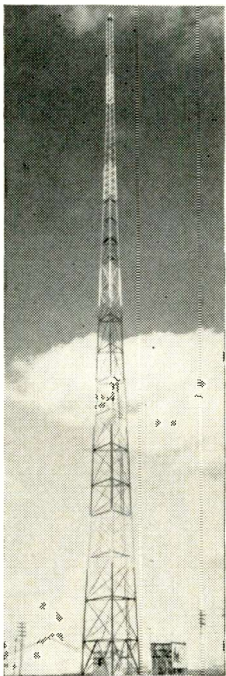

KAA-234, Owatonna, Minnesota, Northern Natural Gas Co. Truscon Self-Supporting Tower, 260 feet high.

Truscon experience in radio tower engineering is world wide... meeting all types of topographical and meteorological conditions... and supplying many different tower types—guyed or self-supporting... tapered or uniform in cross-section... for AM, FM or TV transmission.

Your phone call or letter to any convenient Truscon district office, or to our home office in Youngstown, will bring you immediate, capable engineering assistance. Call or write today.

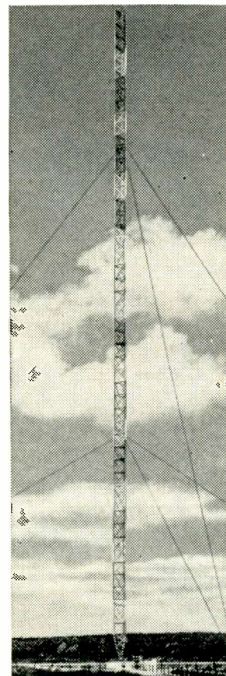

WHDH, Boston, Mass. Three Truscon Guyed Towers; 565 feet, 605 feet, and 645 feet high.

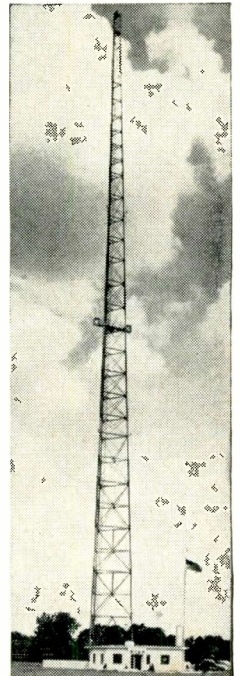

WSAM AM-FM, Saginaw, Mich. Truscon Self-Supporting Tower, 386 feet high.



WXEL-TV Cleveland, Ohio. Truscon Self-Supporting Tower, 437 feet high.

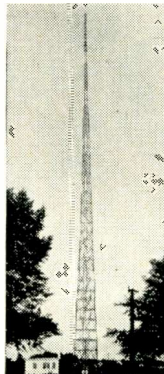

WTCH, Shawano, Wisconsin. Truscon Self-Supporting Tower, 240 feet high.

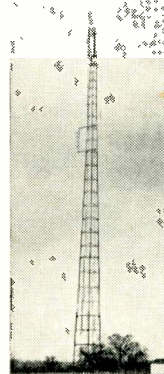

WMRI-FM, Marion, Indiana. Truscon Self-Supporting Tower, 336 feet high.

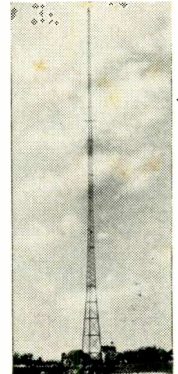

WEMP-FM, Milwaukee, Wisconsin. Truscon Self-Supporting Tower, 456 feet high.

TRUSCON® STEEL COMPANY Youngstown 1, Ohio
Subsidiary of Republic Steel Corporation



Eyelets? Eyelet machine products?

Here, illustrated full size, are some examples of the parts we make—in a wide variety of metals and finishes. Some are of simple design . . . others are intricate, precision-made parts for industrial, electrical and scientific purposes.

We'll be glad to quote on your requirements, and have thousands of stock too's which may save tooling-up charges. Just send us a sample, drawing or description, together with quantity and other pertinent information.

THE AMERICAN BRASS COMPANY,
Dept. WBG, Waterbury 20, Connecticut. ⁵¹²⁶⁹

for eyelet machine products

it's **ANACONDA**

COPPER • BRASS • BRONZE • NICKEL SILVER
NICKEL • IRON • STEEL • STAINLESS • ALUMINUM

TERMALINE Coaxial Line Instruments

TERMALINE Direct-Reading RF Wattmeters 30 mc-2500 mc; 50 ohms; 1/2w.-5kw.

Model 67

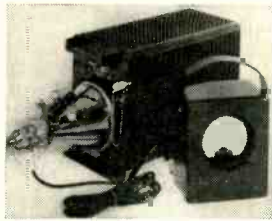

Model 612

The TERMALINE wattmeter is a direct-reading, absorption type instrument for simple, fast and accurate power measurement of transmitters operating between 30 mc and 2500 mc. With the TERMALINE coaxial load resistor dissipating all power applied, a crystal voltmeter circuit built into the input connector of the wattmeter feeds a dc meter which is calibrated directly in RF watts. Accuracy of 5% of full scale or better is assured. Model 611 is the commercial version of the Army-Navy ME-11/U RF wattmeter, widely used by all government services. Most transmitter manufacturers use the TERMALINE wattmeter for production and field test work and recommend it to maintain performance. Frequency Range... 30 to 2500 mc. (See Table) Power Range 1/2 watt to 5000 watts Impedance 50 ohms Accuracy 5% of full scale. VSWR less than 1.1

STANDARD MODELS

(Standard calibration is 30-500 mc. If 30-1000 mc calibration is desired it must be specified)

Model	Freq. Range	Max. Power	Ranges	Scales	Input Connector	Special Features
611	30-500 mc or 30-1000mc	60 W	2	0-15 0-60	Female N. Takes UG-21/U plug	Same as AN-ME-11/U Portable
612	30-500 mc or 30-1000mc	80 W	2	0-20 0-80	Female N. Takes UG-21/U plug	Portable
67	30-500 mc or 30-1000mc	500 W	3	0-25 0-100 0-500	Coplanar. Adaptor to take UG-21/U plug supplied	Meter is shock mounted in aluminum housing separate from termination
67C	30-500 mc or 30-1000mc	2500 W (Water cooled)	3	0-100 0-500 0-2500	Coplanar. Fittings and cable assys to all flexible & rigid lines available	Tap water cooling is required above 500 watts
824	30-220 mc	5000 W (Water cooled)	1	0-5000W	Coplanar. 10 ft of RG-19/U cable with 1 5/8" fitting is supplied	Water cooling

Engineering models available for use between 500-2500 mc. Special scale Model 61 for low powers such as 0-1, 0-5 watts also available.



TERMALINE-Coaxial Terminations

0-11mc

50 ohms

5w.-2500w.

The Termaline coaxial load resistor is designed to have a constant 50 ohm impedance over a wide frequency range. Its unique design puts reactance to work and produces an almost purely resistive load, with little or no sensitivity to frequency change. The active power dissipating portion is the outer surface of a cylindrical film-type resistor, which forms the center conductor of a special self-terminated coaxial structure. Constant impedance properties depend upon shape of coaxial assembly and distribution of resistance along length of outer surface of resistor.

Major use is as a dummy load for high frequency transmitters. Being non-radiating, adjustment of transmitters can be made without violation of FCC rules. Thousands are now being used in military equipment. It is incorporated as standby in many commercial transmitters and as a test load.

Model	Max. Power	Best Freq. Range	VSWR	Input Connector
80-5F	5 W	0-11 KMC	1.15	Type N Female
80-5M	5 W	0-11 KMC	1.15	Type N Male
80A	20 W	0-500 MC	1.1	Type N Female
81	50 W	0-4 KMC	1.2	Type N Female
81B	80 W	0-4 KMC	1.2	Type N Female
82	500 W*	0-3 KMC	1.2	Coplanar. Adaptor to UG-21/U supplied
82A	500 W	0-3 KMC	1.2	Coplanar. Adaptor to UG-21/U supplied
82C	2500 W**	0-3 KMC	1.2	Coplanar. Fitting and cable assemblies for all flex and rigid lines available

* At max rating fan necessary

** Water cooled

COAXWITCH—Coaxial Selector Switch

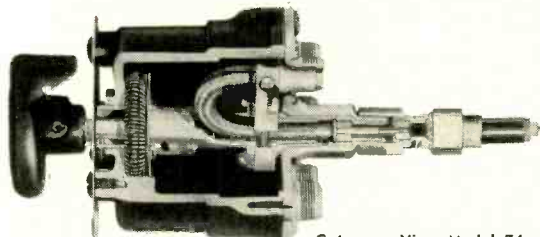

Cut-away View Model 74

This is a 50 ohm switch for use in coaxial circuits. Characteristic impedance is maintained through all switch details and low standing wave ratios result. In V.S.W.R., switch is comparable and as good as the connectors and cable with which it is used.

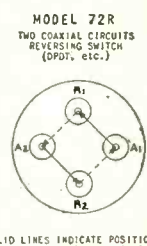
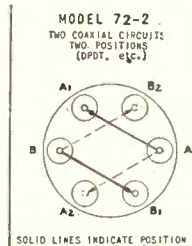
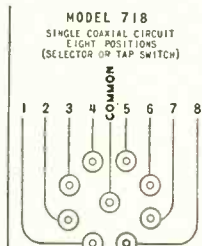
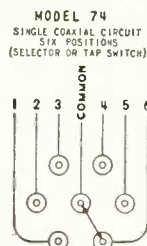

SOLID LINES INDICATE POSITION 1
DOTTED LINES INDICATE POSITION 2

Type N female connectors are standard on all models to receive UG-21/U series plugs. Adaptors may be used to enable switch to be used with other cable and connectors.

LOW PASS RF FILTERS

Suppression of low order harmonics in VHF and UHF transmitters may be handled thru use of these filters. Insertion loss and VSWR are very

low thru pass band. Rugged construction thruout assures reliability. All are of 50 ohms impedance and are reversible with equal results. Attenuation in pass band is less than 1/2 db and in stop band 40 db or better is realized.

MODEL	PASS BAND	STOP BAND	MAX. POWER	VSWR	CONNECTORS
844	0-400 MC	500-2000 MC	150 W	1.35	One male and one female N
819-1200	0-1200 MC	1900-4000 MC	100 W	2 to 1	Two female N for use with Models 611 and 612
819-7	0-1200 MC	1800-4000 MC	3.5 KW	2 to 1	Coplanar. For use with Models 67 and 67C

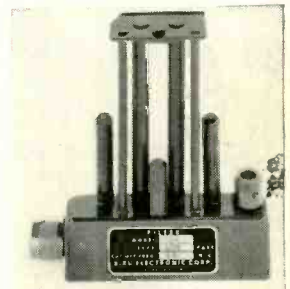

Model 844



BIRD ELECTRONIC CORPORATION

• TERMALINE COAXIAL LINE INSTRUMENTS •

1800 East 38th Street Cleveland 14, Ohio Express 1-3535

In the West

NEELY ENTERPRISES — Sacramento — Hollywood — San Francisco — Albuquerque

Complete line
TV & RADIO
COILS
for manufacturers

Modern, precision equipment and personnel for producing extremely specialized custom-types or volume requirements. Conventional and hermetically sealed coils for military application, television, radio, incidental reception-transmission and industrial electronic purposes. Precise adherence to critical government specifications or individual requirements.

AUTOMATIC WIRE CUTTING & STRIPPING FACILITIES AVAILABLE

VACUUM TUBE VOLTMETER-OHMMETER

FOR VISUAL DYNAMIC SIGNAL TRACING

Enables laboratory engineers and radio service technicians to measure every voltage required in the design laboratory and radio servicing.



The VTVM is supplied in individual black steel cases, 9 5/16" high, 6" wide, 4 3/4" deep. Shipping weight 10 1/2 lbs. complete.

110 - 120 Volts, 50-60 cycles.

FEATURES OF THE VTVM

1. D.C. Ranges: 0 to 3-10-30-100-300 and 1,000 volts. All ranges have a constant input resistance of 11,000,000 ohms. Accuracy 3%±.
2. A.C. Ranges: 0 to 10-30-100-300 and 1,000 volts. Sensitivity: 1,000 ohms per volt. Accuracy 5%±.
3. Ohmmeter Ranges: 0-1,000 ohms, 0-10,000 ohms, 0-100,000 ohms, 0-1 megohm, 0-10 megohms, and 0-1,000 megohms.
4. R. F. Voltage Ranges: 0/3-10 30-50. 50 Volts to be measured on 100 Volt range (using the Ediprobe.)
5. Improved bridge amplifier circuit. Bridge Amplifier Circuit Meter individually calibrated for use with set of test leads, D.C. probe and batteries.

LIST PRICE \$52.50

EDIPROBE—THE PENCIL THIN R.F. PROBE



FEATURES:

1. Smallest R.F. probe made, 1/2" diameter x 4 1/2" long, low loss lamitex.
2. Standard phone plug will fit into D.C. jack of VTVM.
3. Frequency range 60 Cycles to over 100 Megacycles.
4. R.F. Voltage ranges 0/3-10-30-50. 50 Volts to be measured on 100 Volt range.
5. Effective circuit loading: 3 mmf. and 1 megohm.
6. Can be used as an output meter.
7. Can be used for measuring decibels.
8. Tests condensers for open circuits.

LIST PRICE \$7.00

HIGH VOLTAGE PROBE—Model PR-30

Overall range up to 30,000 Volts. Calibrated for Electronic Designs VTVM Model 100. Used in Television Circuits, Experimental High Voltage Applications, Industrial Electronics and Transmitter Power Supplies. Send for full information.

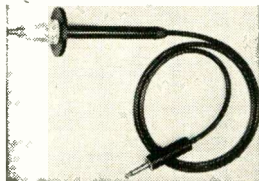

List Price \$14.25

28 School St., Yonkers, N. Y.
Telephone: YONkers 9-7199

ELECTRONIC DESIGNS, INC.

**400-800
CYCLE
AC**

From 5.5v to 230v
DC Input

New Carter* High Frequency

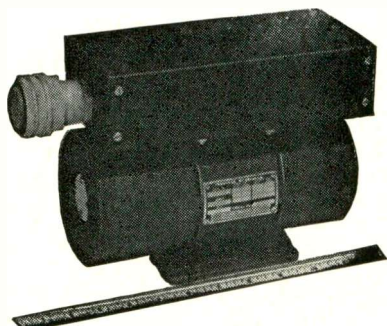

INDUCTOR ALTERNATOR

Newly developed in the Carter research and engineering departments, this new rotary power supply is ideal for aircraft, geophysical, government and laboratory research, and other applications demanding a small, mobile source of up to 100 watts high frequency AC. Primarily designed for 24-29v. DC airborne equipment, but available at any input voltage 5.5v to 230v. Inductor principle eliminates slip rings and brushes. Electrically isolated input and output units. Separate DC plate output also available in addition to the h.f. AC.



2646 N. Maplewood Ave., Chicago

WRITE for Bulletin #350. Contains complete illustrated information on the New Carter Inductor Alternator, mechanical and electrical specifications, performance chart, etc. Yours FREE for asking!

- **LIGHT WEIGHT**
Filter Model Shown Weight only 22 lbs.
- **SMALL SIZE**
10" x 4 1/2" x 7 3/4"
(Filter Model as shown)
- **PRECISION BUILT**
Shaft and bore fits held to less than .0002"
- **ARMATURE**
Triple and quadruple insulated windings statically and dynamically balanced
- **BALL BEARINGS**
Require no maintenance or lubrication in normal service
*T.M. Reg. U.S. Pat. Off.

A COMPLETELY INSULATED

SPLICE
in 3 simple steps



CLOSE TOOL FOR pres-SURE-cripp
CUT WIRES WITH FLUSH SECURITY RING
PUSH ON INSULATOR. TURN UP RED SECURITY RING



A PERFECT WIRE TERMINATION in 1 easy operation



SIMPLY PLACE "TERMEND" IN TOOL—INSERT WIRE & CLOSE TOOL

ALL installed with
UL
EIA
"pres-SURE-tool"

'Bepco' HEAVY DUTY
molded terminal blocks

600 VOLTS • 35 AMPS
4, 8 and 12 CIRCUITS

- ✓ RUGGED ONE PIECE MOLDINGS
- ✓ BASES OFFSET FOR CREEPAGE
- ✓ HIGH REINFORCED BARRIERS
- ✓ MOLDED-IN RIVETS & INSERTS
- ✓ REVERSIBLE MARKING STRIPS
- ✓ HOLES FOR COVER MOUNTING



Also Available—Covers, with attaching screws. Numbered Marking Strips (1 to 4, 1 to 8, 1 to 12).



a plus feature

Immediately following the Product Listings in the DIRECTORY SECTION of this Issue is a list of more than

2500

TRADE NAMES
of electronic and allied products.

They are intended for your use in determining the manufacturer's name when only a trade name is known.

Hold on to this book

It will be
June 1952
before another
edition is published

IT IS THE MOST COMPLETE,
AUTHORITATIVE AND UP-TO-DATE
DIRECTORY OF ELECTRONIC AND
ALLIED PRODUCTS AVAILABLE.

It gives you the manu-
facturers of each of
more than fourteen
hundred electronic
and allied products.



... gives you information
as to where they are in pro-
duction or available in a
reasonable time and unre-
stricted for general indus-
trial use.

1951-1952

electronics BUYERS' GUIDE

Please mention this book when
buying or inquiring from it.

HICKOK *new model* 640 OSCILLOGRAPH

STABLE • VERSATILE
OUTSTANDING RANGE



Model 640

For Industrial and
Electronic
Laboratories

The new HICKOK Model 640 Oscilloscope with its exceptional design features and characteristics provides an outstanding versatile instrument for the engineer in observing regular recurring or transient phenomena.

Wide Band Amplifier: Frequency response DC, 0 to 4.5 mc. (down 3 db.).

Vertical DC and AC Amplifier: 10 MV per inch with sensitivity switch in high position. 25 MV per inch in low position.

Frequency Response: 0 to 1,000,000 cycles, (3 db point), in high position. 0 to 4,500,000 cycles, (3 db point), in low.

Maximum Input Potential; 1000 volts peak.
Input Impedance; 2 megohms, 50 mmf.

Horizontal Amplifier: Deflection Factor—Direct: 20 volts RMS per inch.

Full Gain Setting; 50 millivolts RMS per inch.
Frequency Response; 0 to 200,000 cycles, (3 db down).

Test Signals: Line Frequency, 3 volts RMS per inch.

Sawtooth available from front panel. Direct connection to both horizontal and vertical deflection plates.

Linear Time Base: Recurrent and Driven Sweep; 2 cycles to 30,000 cycles.

Provision for external capacities for slower frequency sweeps of 10 seconds and slower. Sweep Speeds; Faster than 0.75 inch per microsecond.

Television Fixed Frequencies; 30 and 7,875 for observing blanking and sync waveforms in the horizontal and vertical circuits of TV receivers.

Synchronization at line or 2-times line frequency.

"Z" Axis Modulation: Capacitively coupled to the grid of the cathode ray tube. 15 volts will blank trace fully at normal intensity.

Shielded, Shock Mounted, Built-in Calibrating Voltages, Excellent Stability and Expandable Sweep (6 times expansion) are several additional features of this highest quality instrument. Write for further information today. Price \$355; Subject to change without notice.

Manufacturers of a complete quality line of electrical indicating instruments and test equipment. Complete information available on request.

DYNAMIC MUTUAL CONDUCTANCE TUBE TESTER

HIGHLY ACCURATE
Laboratory Model

Model 539

- Dynamic Mutual Conductance circuits . . . Readings in micromhos.
- Permits choice of 3 AC signals, .25, .5 and 2.5 volts.
- Vernier adjustment permits accurate setting of grid voltage.
- Separate AC meter measures line voltage at all times.
- Provision for insertion of plate millimeter for measuring plate current.
- Optional self-bias arrangement.
- Tube life and tube gas test.

Write for additional information today!

THE HICKOK ELECTRICAL INSTRUMENT CO.
10527 DUPONT AVENUE • CLEVELAND 8, OHIO

THE STANDARD OF QUALITY FOR OVER 40 YEARS

STEVENS HERMETICALLY SEALED THERMOSTATS

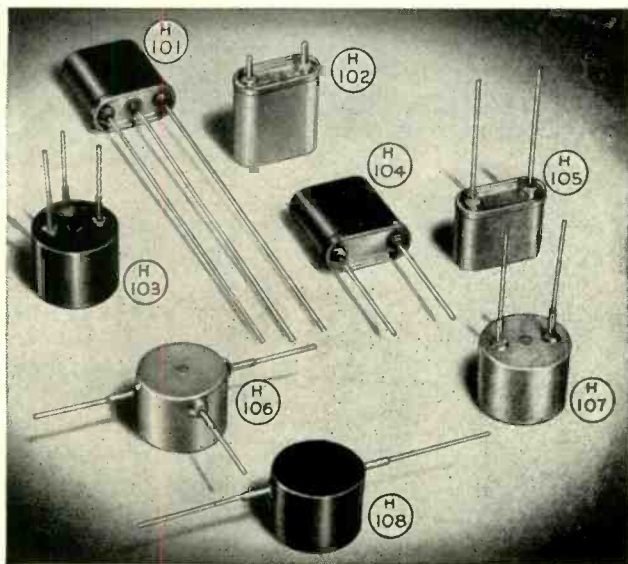

Bright-plated or dull-black finish. Terminals to customer specification.

- fast response
- close control
- operation from -60° to 600°F
- dust, moisture and explosion-proof

Specially engineered for precision control of radio and electronic devices, instruments, cameras and other equipment subjected to dust, moisture or corrosive atmospheres, Stevens hermetically sealed thermostats are enclosed in corrosion-resistant metal cans.

Carefully precalibrated in pots simulating your actual service conditions, Stevens* hermetically sealed

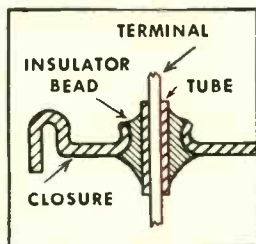

thermostats have a tight, permanent seal that prevents deterioration or sulphiding of contacts. They can also be sealed in helium or other inert gas atmosphere. Terminals are sweat-soldered into inert alloy tubes interfused with inorganic glass insulator bead.

Stevens hermetically sealed thermostats—featuring an electrically independent bi-metal element that eliminates artificial cycling or life-shortening "jitters"—are available in disc types for controlling higher-wattage circuits, or in strip types for controlling low-wattage circuits or for use in conjunction with disc thermostats.

To insure the satisfactory performance of your product, specify Stevens hermetically sealed thermostats—they perform better . . . last longer.

A-2914

*Stevens also makes a complete line of semi-sealed and standard bi-metal disc and strip thermostats. Write for data.

STEVENS manufacturing company, inc.
MANSFIELD, OHIO

Hold on to this book

It will be
June 1952
before another
edition is published

IT IS THE MOST COMPLETE,
AUTHORITATIVE AND UP-TO-DATE
DIRECTORY OF ELECTRONIC AND
ALLIED PRODUCTS AVAILABLE.

It gives you the manu-
facturers of each of
more than fourteen
hundred electronic
and allied products.



. . . gives you information
as to where they are in pro-
duction or available in a
reasonable time and unre-
stricted for general indus-
trial use.

1951-1952

electronics BUYERS' GUIDE

Please mention this book when
buying or inquiring from it.

To your specifications
by **COMAR**

Hermetically
SEALED
Telephone Type
RELAYS

Meets U. S.
Government
Specifications

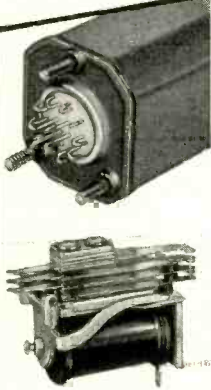

Standard
or Special
RELAYS
Light, Medium,
or Heavy Duty



SOLENOIDS
To Meet A
Wide Range
of
Requirements

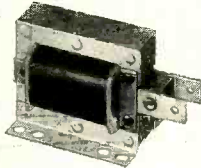

Standard
or Special
**SWITCH
ASSEMBLIES**

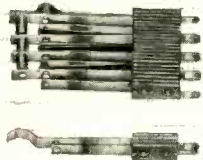

Custom Built
**TRANSFORMERS
AND CHOKES**

Cased or
Uncased

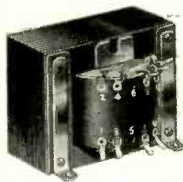

WHAT DO YOU NEED?
Comar Engineers will help you.
Send for Free Catalog



COMAR
ELECTRIC COMPANY
3349 ADDISON ST., CHICAGO 18, ILLINOIS

EXPERIMENTAL TYPE

5JP11A

551G



Why Limit Testing or Research?

ETC multi-gun cathode ray tubes and multi-channel oscilloscopes pave the way to test and research activities far beyond the limitations imposed by single-gun or single-channel models. By registering 2, 4, 5—and even more—related or independent wave forms simultaneously on the same screen they permit far faster and more accurate comparative analyses than are possible by any other method. Whether in industrial, medical, geophysical or other applications, send details of your problem for recommendation by ETC engineers.

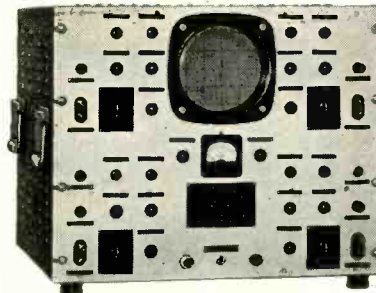

H-43 Four-channel oscilloscope for strip film recording.

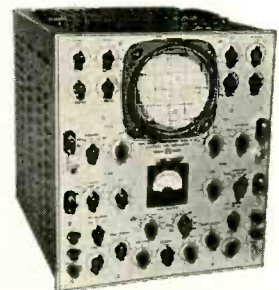

H-21 dual-channel oscilloscope.

... for high-frequency STRAIN ANALYSIS

Utilizing ETC 4-channel oscillographic equipment, this H-42A Strainalyzer contains complete equipment for simultaneous measuring, analyzing, and recording of four static or dynamic strains from 0 to 50,000 cycles. Includes four calibration bridge circuits, power supplies, recording camera, ready to connect directly to strain gages—a complete testing laboratory in one instrument. Write for Bulletin H-42A.

ETC

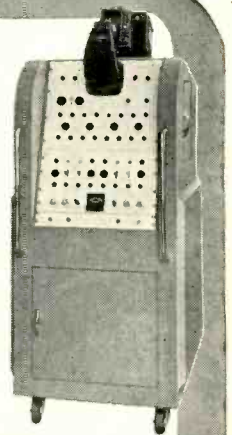

electronic tube corporation

PHILADELPHIA 18, PENNSYLVANIA

COILS WOUND to Your Specifications

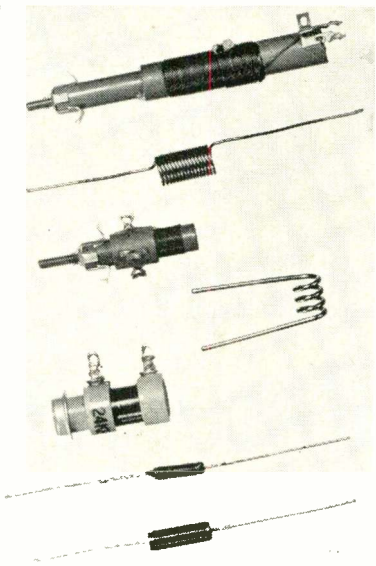

SOLENOIDS

Self Supporting
Close Wound
Space Wound
Bifilar Wound
Motor Coils
Magnet Coils

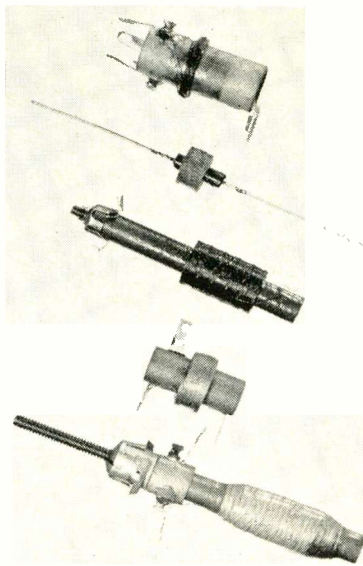

UNIVERSALS

Progressive
Oscillator
Antenna
R.F.
Chokes
Video Peaking

THE T. J. HOULIHAN COMPANY
2508-14 WEST LAWRENCE AVE. CHICAGO 25, ILL.

Mail & Inquiries For:

- AIRMEC LABORATORIES LTD.
- BELLING & LEE LTD.
- THE DU BOIS CO. LTD.
- ELECTRO-ACOUSTIC INDUSTRIES LTD.
- GENERAL ACCESSORIES CO. LTD. (GLIX)
- PAINTON & CO. LTD.
- PARMEKO LTD.
- TRIX ELECTRICAL CO. LTD.

Should Be Addressed:

BRITISH ELECTRONIC GROUP
366 Madison Ave.
New York 17, N. Y.

Resident Agents For
The Above Manufacturers

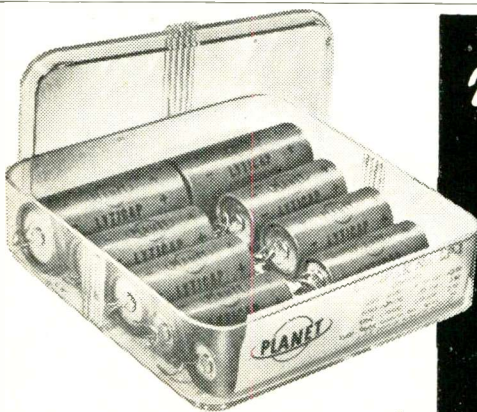

**Planet Capacitors
Lead the Way**

When You Want

FINEST MATERIALS

BEST WORKMANSHIP

LONG DEPENDABILITY

You'll Find That

The Planet trademark on a dry electrolytic condenser assures you of satisfaction plus. Each unit is quality controlled from design to finish to give you the highest quality at the lowest cost.

All Planet capacitors carry a 1-year replacement guarantee. They are attractively packaged, and are manufactured in specifications and mounts best suited to your needs.

Send for our new catalog C-2 for complete information.

PLANET MANUFACTURING CORPORATION
225 Belleville Avenue, Bloomfield, N. J.



Included in the
DIRECTORY SECTION
of this Issue
is a list of more than
850
DISTRIBUTORS OF
ELECTRONIC COMPONENTS
and
ELECTRONIC EQUIPMENT

They are ready and
willing to serve you.

When ordering, be sure
to mention the . . .

electronics
BUYERS'
GUIDE

KEITHLEY INSTRUMENTS

Manufacturers • Consultants



VACUUM TUBE ELECTROMETER, Model 200

Potential measurements with low current drain; measures currents to 10-14 ampere; quickly measures insulation and dielectric resistances 2 and 20 volt ranges, dc.
 10 $\frac{1}{2}$ ohms, 6 mmf input impedance.
 Grid drift current less than
 5 x 10⁻¹⁴ ampere on the 2 volt range
 5 x 10⁻¹³ ampere on the 20 volt range

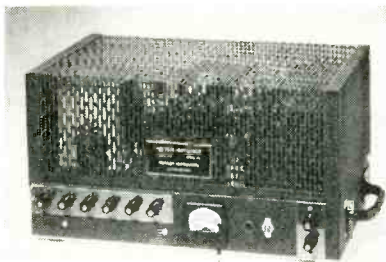

METER MATCHER, Model 105

Gives highly accurate dynamometer and iron vane meters a high impedance input. Raises a 15 ohms/volt movement to 6000 ohms/volt. Delivers 150 volts rms into a 2000 ohm resistive load, from 20 cps to 2000 cps. Inputs of 15, 75, 150, 300 and 600 volts to give 150 volts output. 0.15% error. Draws 150 microamperes maximum from circuit being tested.

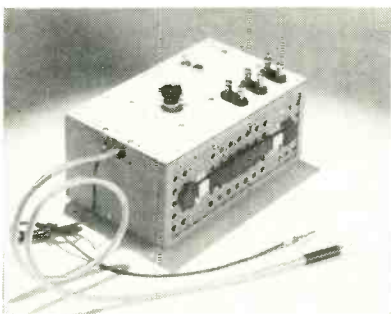

PHANTOM REPEATER, Model 102

Bridging amplifier for test instruments. Input impedance: 200 megohms — 6.5 mmf
 Output impedance: 350 ohms
 Gains of 1, 10, and 100.
 2% accuracy from 5 cps to 150 kc.

Write for descriptive literature

KEITHLEY INSTRUMENTS
 1507 WARRENSVILLE CTR. RD
 CLEVELAND 21, OHIO

R&S

EVER-LOK

PLUGS, RECEPTACLES and CORD CONNECTORS

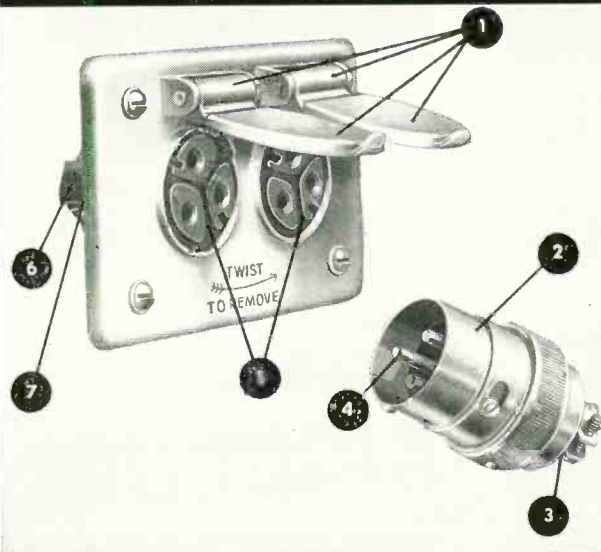

Available in a complete Midget Line... and many combinations from 10 to 200 amperes!

- 1 Spring hinged, gasketed covers close receptacle when not in use.
- 2 Plated steel housings fully protect the contacts.
- 3 Adjustable Cord Grips eliminate strain on connections.
- 4 Contacts are precision-made, self-wiping, and self-aligning.
- 5 Rigidly constructed, all interiors of molded arc-resisting composition.
- 6 Heat-treated beryllium copper contacts and terminals... an advanced EVER-LOK feature.
- 7 Compact design provides ample capacity, yet allows for easy wiring.

WRITE FOR CATALOG EL49-6



RUSSELL & STOLL COMPANY, INC.

125 BARCLAY STREET • NEW YORK 7, N. Y.

C5

RUSSELL & STOLL

PRECISION-BUILT ELECTRICAL EQUIPMENT—SINCE 1902

TYPICAL APPLICATIONS FOR Midget EVER-LOK DEVICES in the Electronic and allied industries
 • Adaptable as components for:

- Accelerometers.
- Amplifiers: Audio Frequency, Audio Input Systems, Keying, Ultrasonic, and Vibration Pickup, etc.
- Battery Chargers.
- Blowers, Small.
- Broadcast Input Control.
- Cameras: Cathode Ray Oscillograph, Television, and X-Ray.
- Chambers, Humidity Test.
- Chronoscopes.
- Communication Systems: Airport Traffic Control, Portable Installation, Radioteletype, etc.
- Controls: Counter, Sorting, and Register, etc.
- Converters: Frequency Shift.
- Detectors.
- Electrocardiographs.
- Electroencephalographs.
- Gages: Measuring, and Electronic Inspection.
- Geophysical Apparatus.
- Indicators.
- Inverters.
- Machines.
- Meters: Sound Level, etc.
- Monitors.
- Oscillographs.
- Radar Systems, & Equip't.
- Receivers: Communication, Portable and Mobile; Radio Direction
- Recorders: Facsimile, Materials Thickness, Sound and Phonograph, Sound Level, and Strain.
- Spectrometers, Mass.
- Television Systems.
- Transmitters.
- Turntables: Recording and Transcription.
- Vibration Analysis Equipment.
- X-Ray Equipment.

**HIGH - PRECISION
INSTRUMENT - TYPE**

MOTORS & GENERATORS

SPECIALLY-DESIGNED & MANUFACTURED • RATINGS FROM 1/3000 - 1/6 hp

GOVERNOR-CONTROLLED

SELF-SYNCHRONOUS

DRAG CUP

DC & AC TACHOMETER

SHUNT

SERIES

COMPOUND

PERMANENT-MAGNET

SPLIT-FIELD

SEPARATELY EXCITED

UNIVERSAL

INDUCTION

RELUCTANCE

HYSTERESIS

ONE-, TWO- & THREE-PHASE

DC & AC SERVO

TOTALLY ENCLOSED

AC DYNAMICALLY BRAKED

REELMOTORS

ONE-, TWO-, THREE- & FIVE-SPEED
SYNCHRONOUS MOTORS

STABILIZED HYSTERESIS

IN A WIDE VARIETY OF FRAME TYPES AND SIZES

THERE ARE OVER 600 BASIC MODELS TO MEET YOUR NEEDS

Though we do not carry units in stock, the wide range in types and specifications of the over 600 basic models will usually allow a customer to select one that meets his specifications; or a basic model may be easily varied to meet the most unique and exacting specifications. Every unit is designed and manufactured to order and individually tested to insure meeting specified requirements in every respect.



When inquiring or requesting quotations, you must submit detailed description of your problem so we may forward the proper literature and information promptly.

ELECTRIC INDICATOR CO.
PARKER AVENUE STAMFORD, CONN.

NOTE:

Our business is solely in the design, engineering, and production of special units. They are for use, and are economical, only when the highest standards of performance are required. Every unit is a high precision instrument manufactured with appropriate skill and care. We do not "sell from stock" or compete with low-cost, mass-production units (i.e.: for appliances, low-cost tools, etc.). If your requirements demand a manufacturer of proven ability, with a reputation over many years for designing and producing to the highest standards and most exacting specifications, Elinco can then serve your needs.



HARVEY

... SINCE 1927

DEPENDABLE

SUPPLIER OF

ELECTRONIC NEEDS!

**HARVEY... Headquarters
For These Famous
and Reliable Brands:**

National Co.
Hallicrafters
RCA
General Electric
Precision
Hickok
Simpson
Ohmite
Cornell-Dubilier
Sprague
Mallory
UTC
Aerovox
Stancor
Chicago Transformer
Millen
Johnson
Cardwell
Leece-Neville
Cannon
Amphenol
Magnecord
McIntosh
Western Electric
Altec
Carter
Triad
Lansing
Advance
REL
Precision Apparatus
Shallcross
Bell
Weston
Thordarson
Triplett
And Many Others

You'll hear it everywhere... HARVEY has it, or can get it for you. Tubes, transformers, condensers, test equipment, recorders, speakers, receivers, transmitters — in fact, the whole wide world of electronic equipment is

here waiting for you. We know your problems, and can help you solve them. 24 years of experience are at your service. Get to know the benefits of dealing with HARVEY now, right now!

HARVEY "+ SERVICES

- Expert attention of personnel thoroughly experienced in the electronic field.
- Every order, large or small, filled within the shortest possible space of time.
- We will be glad to consult with you on individual problems... no charge or obligation.
- Everything GUARANTEED in perfect condition. Money cheerfully refunded if you are not satisfied.

For Civilian Defense!
HARVEY, as with all other needs in the field, can supply your complete requirements for Civilian Defense... Mobile transmitters, Power Supplies, Antennas, Microphones, Etc. . .

FREE! Big 140-Page Catalogue of Electronic Equipment!

A valuable ready-reference of everything that's good and desirable in electronic needs. YOU SHOULD HAVE IT. Use this handy coupon.

HARVEY RADIO COMPANY, Inc.
103 W. 43rd St., New York 18, N. Y.

Please send me your FREE 140-Page Catalogue of Electronic Equipment.

NAME.....
TITLE.....
ADDRESS.....
CITY.....ZONE.....STATE.....

Telephone:  LUXemburg 2-1500

HARVEY
RADIO COMPANY INC.

103 West 43rd St., New York 18, N. Y.

NEW KAY TIME-SAVING INSTRUMENTS PRESENTED WITHIN THE PAST YEAR

These six instruments have been developed and engineered in the interests of providing laboratories and production lines with the newest in instrumentation techniques. A postal card or letter will bring you a copy of our new catalog A-51 with complete specifications. Write for it today.



THE MARKA-SWEEP Model Video

An electronically swept video sweep oscillator covering frequencies up to 20 mc. Crystal positioned marks of pip type are provided at 1, 2, 5, 10, 15 and 20 mc. By use of external signal generator a variable frequency pip type marker is available. Output maximum is 0.3 volt from a 72 ohm internal impedance. Price \$495.00.

THE CALIBRATED MEGA-SWEEP



The Widest Range Sweeping Oscillator Available. Single control tuning from 100 kcs to 900 mcs. Approximate center frequency indicated on dial. Sweep width variable 0-30 mcs. Sawtooth sweep—no phasing. Easily pulse modulated. Output approximately 100 mv max. Precision micrometer wavemeter included. Price \$425.00.



THE VIBRALYZER

Analyzes signals in the 5-4400 cps region in three frequency ranges, with broad and narrow analysis filters on each range. It is useful for studies of transient and steady state signals on aircraft, ships, rotating and reciprocating machinery, and in fields such as ordnance, ballistics, seismology and acoustics. Displays: 1. Amplitude vs. frequency vs. time; 2. Amplitude vs. frequency at selected times. Price \$2500.00.



THE RADA-SWEEP

An all electronic sweeping oscillator for use in aligning Radar IF strips. It is swept by a symmetrical sawtooth which is also available for sweeping the oscilloscope. Marks may be individually switched on and off and attenuators are available on the pip and high frequency outputs. A true zero level reference baseline is provided. Price \$395.00.

THE SONALIGNER



A very stable and accurate oscillator in the ultrasonic range; suitable for use in determining the pass band of narrow band ultrasonic filters and other accurate work in this range. Calibration: Crystal Check Points Accurate to 0.01% included—may be externally calibrated—marks every 2, 10, 50, 200 kcs.—Timing "comb" may be used for accurate alignment of Radar range circuits. Output level meter and attenuators included. Price: \$695.00.

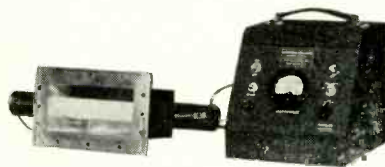

MICRO-WAVE MEGA-NODE L-Band, New Model

Provides a primary source of random noise for the L-Band. May be used for measurement of noise figure, receiver gain, and calibration of standard signal source. The specifications are as follows:

Waveguide RG-69/U
Flange UG-417/U

Noise Power Output..... at 20° C.—15.84 db
Frequency Range..... 1200 to 1400 mc.
Information on Microwave Mega-Nodes and other frequency ranges within the L-Band may be obtained on application.

All Prices F.O.B. Factory. 10% higher outside U.S.A. and Canada



KAY ELECTRIC COMPANY

25 Maple Avenue

Phone CAldwell 6-4000

Pine Brook, New Jersey

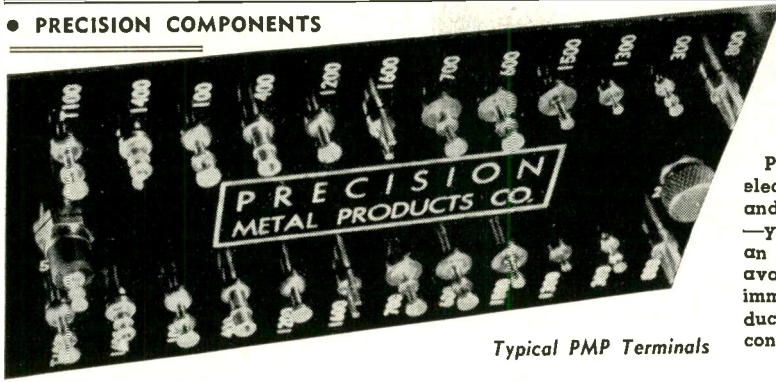

Typical PMP Terminals

PRECISION TERMINALS

PMP designs and fabricates terminals for every conceivable electronic requirement. Their unusual production methods and engineering skill provides products of far better quality — yet at costs below competition. Base material is brass with an approved silver plated finish. Centrifugal tin dipped finish available at no extra cost. Their standard line is available immediately and specially designed terminals can be produced within any reasonable requirement. Before you buy consult PMP.

HAND SWAGING TOOLS

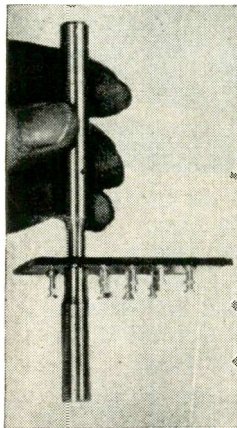

Precision hand swaging tools are correctly designed for fast smooth assembly of terminals into terminal board. They are made of tool steel and tempered for long life. For production, they can be used in a standard kickpress.

PMP also furnishes bench type swagers

SPECIAL TERMINAL ASSEMBLIES

PMP has fabricated thousands of special terminal assemblies and mounting boards for manufacturers of electronic equipment to meet rigid military and industrial requirements. Any type of material or marking can be furnished. Wax and fungicidal treatment in accordance with specifications.

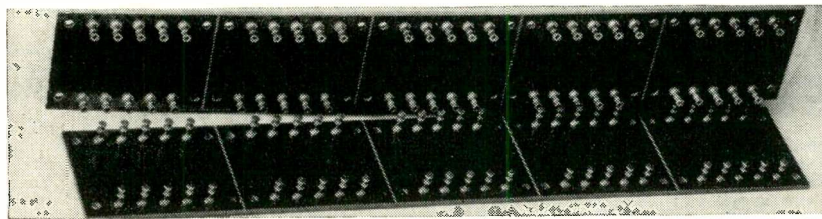

STANDARD UNIVERSAL SECTION BOARDS

Precision universal section boards have met with enthusiastic approval. Engineers, Laboratory Technicians, and Designers find it invaluable as a low cost aid in development and prototype work.

Available in 4 widths, each board has 5 sections, complete in itself, with 10 terminals and 4 mounting holes. One or more sections can be easily separated to suit a particular job. PMP offers a choice of 2 terminal types: No. 100 (Double Turret) or No. 400 (Tubular Turret). Also choice of board material: LE or XXX phenolic. XXX phenolic as board material has found wide acceptance and use in high frequency applications.

TUBULAR TURRET TERMINALS

PMP Tubular Turret terminals permit mounting of components on both sides of a terminal board. Where compactness is necessary these tubulars have found wide use in electronic circuitry.

INSULATED STAND-OFF TERMINALS

PMP insulated stand-off terminals are engineered and manufactured to the highest specifications. The insulating material is Grade XXX phenolic. Bases are nickel plated brass and are furnished in 2 types: Threaded or riveting. Terminals are silver plated.

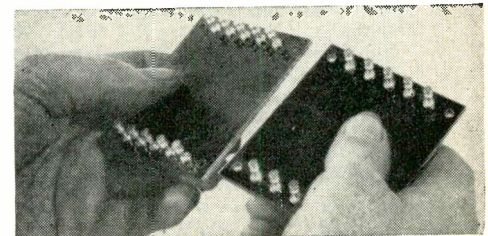
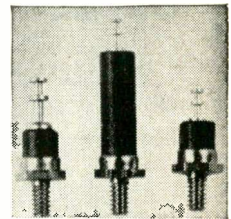

SECTION SCORING

The illustration above clearly shows the ease with which one or more of the five sections of the PMP Universal Board may be used. The scoring is deep enough to make a clean break but not too deep to remain rigid if all five are used.



STANDARD HANDLES

*Designed for use on electronic gear
3", 4½" and 6½" Widths*

These handles are especially designed for use on electronic equipment of all types. Handles are furnished in electro-polished stainless steel and hand buffed nickel plated brass. Matching ferrules which add much to rigidity and appearance can be furnished with handles or separately.

FOR COMPLETE DATA & PRICES on all PMP products send for Catalog No. 20. Requests on company letterhead promptly answered.

PRECISION HARDWARE: Many items in the Electronic Hardware field, such as handles, ferrules, thumb screws, stand-offs, etc., are kept in stock. Many years of experience in all types of metal fabrication, enables PMP to offer manufacturers a specialized service in the designing and production of custom components. Quality and PMP are synonymous, and production "Know-how" has kept PMP prices down with the lowest.



PRECISION

METAL PRODUCTS CO.

OF MALDEN
41 Elm St., Stoneham 80, Mass.

Do You Have WAVEGUIDE PROBLEMS?

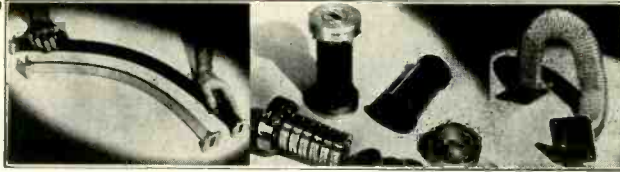

Let **TECHNICRAFT** Be Your Guide

FOR . . .

FLEXIBLE WAVEGUIDE ASSEMBLIES

TYPE L, Interlocked, the most rugged and stable flexible waveguide made which is both bendable and twistable, is fabricated by spirally winding a sturdy, formed, silver-coated, metallic strip about a rectangular arbor, folding in and truly interlocking the edges to produce full four wall interlocked flexible metal tubing. Unlike some other constructions loosely described as "interlocked", Technicraft Type L has three parallel silver-to-silver contact surfaces, held together by spring pressure, joining each convolution to the next. It flexes by virtue of a sliding motion between convolutions rather than by bending of the metal as the guide is stretched, compressed, bent or twisted. Provides fairly sharp bends and a large amount of twist, also appreciable extension and compression. Twist may be had simultaneously with E and H plane bends. Flexes freely without significant change in attenuation or VSWR.

Unexcelled for connecting two pieces of equipment, particularly where there is considerable misalignment or where a change in polarization is desired. Available in continuous lengths up to 50 feet, or more, tape wrapped if desired, to mate with practically all standard rigid waveguides. Where internal pressurization is required, Type L Assemblies up to 8 feet in length, with molded synthetic rubber jackets, can be had.

TYPE S, Seamless-Corrugated, the only convoluted Flexible Waveguide without contact surfaces, soldered convolutions, or seams, is made by annularly convoluting a thin-wall, seamless, rectangular metal tube to produce a bellows-like flexible metal tubing. It flexes accordion-fashion, by a bending of its pleated walls. Provides exceptionally sharp E and T plane bends and considerable extension and compression. Bent Type S assemblies will also twist appreciably. Flexes easily with small change in attenuation and VSWR. Has absolutely no detectable R.F. leakage at operating frequencies. Air tight, moistureproof and rugged enough to be pressurized without a jacket, an advantage for elevated and very low temperature applications. Will withstand appreciable vibration and repeated flexure of moderate amplitude.

Makes an excellent flexible coupling; widely used in short lengths for detachable couplings to fragile components such as magnetrons. Often superior and more economical than rigid guide for corners, elbows, complicated bends and twists. Type S assemblies, preformed to specifications, will retain their desired shape. Presently available in sizes to mate with X-band guides RG-51/U and RG-52/U, in lengths from one to 42 inches. Assemblies normally are supplied silver plated, with or without external lacquering. Where extra ruggedness is desired, Type S assemblies can be had with a tape wrapping or molded synthetic rubber jacket.

Technicraft Type S Flexible Waveguide Transformers provide a well matched, broad-band transition between RG-51/U and RG-52/U rigid guides, plus all the desirable mechanical characteristics of a Seamless-Corrugated flexible waveguide assembly.

TYPE V, Vertebra, possesses more degrees of mechanical freedom than any other type of Flexible Waveguide. Consisting of a series of slightly separated aluminum plate-choke wafers inserted into a synthetic rubber jacket, this type flexes by deformation of its pliable jacket. Consequently, it has practically unlimited life under vibration and repeated flexure and is *unexcelled for applications involving difficult shock mount problems*. It bends and shears easily and equally well in any direction in the transverse plane, being the only rectangular flexible waveguide possessing circular deflection symmetry. This characteristic makes the vertebra *ideally suited for applications involving conical motion*. It stretches and compresses appreciably and provides a large amount of twist, or repeated twist, in a comparatively short length.

Type V assemblies are air tight and moistureproof and can be had with a flexible metal armor for pressurized applications. Presently available in certain fixed lengths to mate with X and K band rigid guides RG-52/U and RG-53/U.

RIGID WAVEGUIDE ASSEMBLIES

Technicraft makes a variety of rigid waveguide assemblies, many designed to customers' specifications. Included are precision built assemblies incorporating straight, bent and twisted waveguide, fabricated bends, electroformed elbows, mitered corners, tees, and the like. Electrically tested assemblies can be had if desired. Presently available materials include brass, aluminum, silver and silver plated or silver lined brass and aluminum. Rigid assemblies are made in all standard waveguide sizes.

COMBINATION RIGID-FLEXIBLE ASSEMBLIES

In addition to the flexible waveguide assemblies described above, Technicraft custom builds combination rigid-flexible assemblies for specific applications or to customers' specifications. By the use of Technicraft combination rigid-flexible assemblies, many advantages can be realized. Skilled craftsmen in Technicraft's own plant attach Type L or Type S flexible waveguides to brass or aluminum rigid waveguide WITHOUT the use of flanges. The reduction of weight, saving of space, and decrease in cost in such a combination assembly opens new fields in microwave plumbing design. Technicraft is prepared to fabricate the entire assembly, or attach the right type of flexible waveguide to rigid plumbing supplied by the user. Before saying it can't be done, consult Technicraft. You will be surprised what has been done!

CUSTOM BUILT MICROWAVE PLUMBING AND COMPONENTS

Technicraft Laboratories are specialists in the fabrication of Custom Built Microwave Plumbing and Components. Whatever your requirements are for microwave plumbing, or waveguide components, Technicraft can manufacture the entire assembly to the most rigid military or commercial specifications. Just send us accurate drawings and specifications and we will be glad to quote prices and delivery date.

Technicraft maintains a capable technical staff and well equipped laboratory for engineering and testing its products.

WEST COAST OFFICE: 1102 South Western Ave., Los Angeles, Calif.

TECHNICRAFT LABORATORIES

INCORPORATED

Thomaston-Waterbury Road, Thomaston, Conn.

Phone: Thomaston 1222

DANDUX

CANVAS & LEATHER PRODUCTS



BAGS and CASES
BG BAGS
CW BAGS
RADIO EQUIPMENT
ELECTRONIC EQUIPMENT
RADAR EQUIPMENT
TOOL ROLLS

C. R. DANIELS, INC.

75 West St., New York 6, N.Y.
549 W. Randolph St., Chicago 6, Ill.

THIS BOOK...

The electronics BUYERS' GUIDE

tells you
who makes each of
fourteen hundred dif-
ferent electronic and
allied products.

Keep it
and use it
for quick buying
and technical reference
throughout the year.

When buying, or requesting prod-
uct information be sure to mention
ELECTRONICS BUYERS' GUIDE.

KOBZY PRODUCES THAT ALL IMPORTANT QUALITY

(STANDARD OR SPECIAL TYPES)

- LAMINATIONS
- COVERS
- CHANNEL FRAMES
- HOUSINGS
- METAL STAMPING PARTS

★ The variety of Kobzy Standard Products is so extensive that most requirements for television or other electronic purposes are easily met. We are geared to give prompt cooperation in the matter of special parts, in accordance with your definite specifications.

This experienced, modernly equipped organization has worked closely with engineers and designers in the radio and electronic industries for years. Get the benefits that come thru the use of Kobzy practical designs — get Kobzy quality into your quality products.

Keep a copy of the Kobzy Catalog handy for reference. We'll gladly send you one upon request.

**KOBZY
TOOL CO.**
1539 DAYTON ST.
CHICAGO 22, ILLINOIS

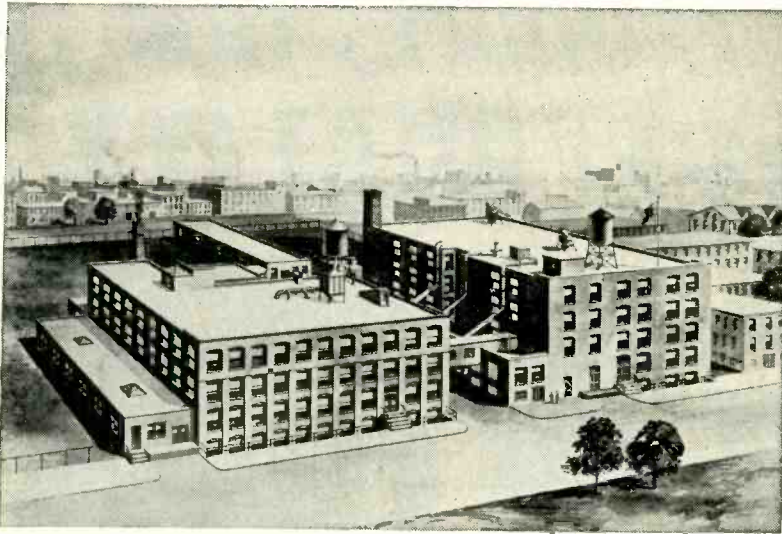

FME for **ELECTRONIC TEST EQUIPMENT** ranging from **10 kc. to 4000 mc.**

During the present national emergency, practically our entire output of test equipment goes to the armed services; but Federal has traditionally been a government supplier, a relationship which has existed over a period of many years, dating back to well before the last war. During World War II, Federal received five successive Army-Navy E Awards—for its achievements in both the electronic and mechanical fields.

We now manufacture precision electronic equipment as follows:

SIGNAL GENERATORS
10kc. to 4000mc.

HETERODYNE FREQUENCY METERS
100mc. to 10,000mc.

RADIO RECEIVERS
.54mc. to 54mc.

HIGH FREQUENCY COMMUNICATION SYSTEMS
PRECISION BUTTERFLY CAPACITORS, ETC.

F. M. E. has a completely integrated plant consisting of 125,000 square feet of production space, with unusually complete engineering and tooling facilities, and combining under one roof every requirement for fabricating, assembling and testing electronic instruments from the raw materials to the finished product.

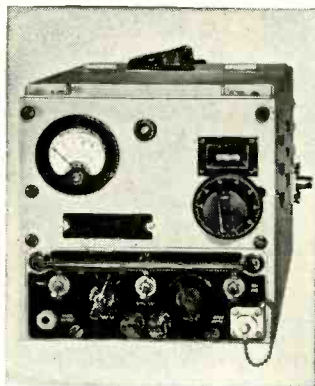

Signal generators and frequency meters, typical of the test equipment developed and manufactured by Federal.

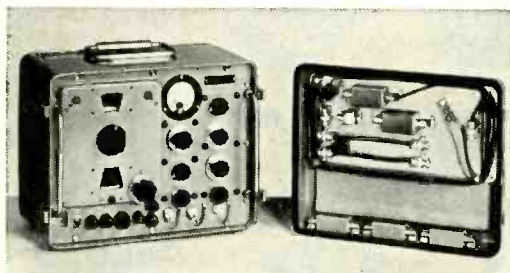

FEDERAL MANUFACTURING & ENGINEERING CORPORATION

Photographic and Electronic Instruments

213 STEUBEN STREET

BROOKLYN 5, NEW YORK

Want to know about the...

AUGETRON

ECCLES-JORDAN CIRCUIT

KATHETRON TUBE

MEKAPION TUBE

PERMATRON

PETOSCOPE

SCHLIEREN METHOD

SCOPHONY

SEMAGRAPH

SIRUFER

SYNDEC

THEREMIN

TRATONIUM

VODER

or other early electronic developments?

You can find out about them in the early issues of **ELECTRONICS**.

The cumulative index to **ELECTRONICS'** first decade, pages C-1 to C-36 in this book, tells you where to look.

WIDE ACCEPTANCE OF E-V PRODUCTS
 adds to the acceptance of your product or service

• **Electro-Voice Research-Engineering and Full Internal Manufacturing Facilities Bring You Products of Advanced Design, Finest Quality, Utmost Value! Experienced Staff and Complete Laboratory for Original Research Projects.**

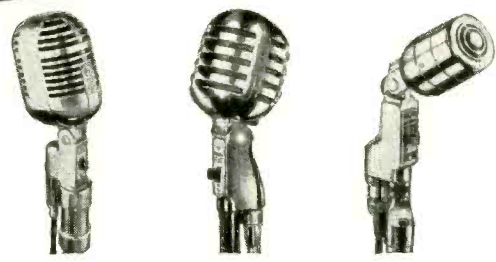

MICROPHONES
 For TV... Broadcasting...
 Recording... Public Address...
 and Communications

Whatever the application...you find your best answer in today's top microphone line! From the *Slim-Trim* to the *Century*...E-V microphones are recognized everywhere...in every field...for their superior *quality, performance and value*. Each model is outstanding in its class. Each is proved by use. What's more...you get the full benefit of exclusive E-V developments such as the *Acoustalloy Diaphragm*, the *Mechanophase Principle*, the *Differential* Principle*, and many others.

Choice of *Dynamic, Crystal and Carbon models...in Omnidirectional, Unidirectional, Bi-directional and Differential types. Just a few are shown here.*

*Pat. No. 2,350,010. Other Pat. Pend.



PHONO CARTRIDGES

For Single-Speed and Multi-Speed
 78, 45 and 33 1/3 RPM

First truly modern crystal cartridge, E-V *Torque Drive** gives you everything you want, exactly as you want it! Has low mass, direct drive system, extra-high voltage-compliance product, and other advantages. Readily adaptable to all speeds and all requirements. That's why it is used today in original equipment by so many leading manufacturers...and for replacement in existing players. Laboratory control assures consistent uniformity in quantity production. Single and dual styli models, in regular, twilt, and turnover types.

E-V Ceramic cartridges also available for all three speeds.

*Pat. No. 2,540,851



SPEAKER SYSTEMS

For High Fidelity P.A.
 and Home Reproduction

Unique new E-V *Radax* principle of high-frequency propagation and dispersion... heavier "pound-rated" magnets for more driving power and generous distortion damping factors...separate 2-, 3-, and 4-way reproducing systems for the home...acoustically-correct Klipsch licensed* folded corner horn speaker enclosures with authentic furniture styling...these and other E-V exclusives create a totally new experience in the enjoyment of sound reproduction.

*Klipsch licensed. Pat. No. 2,310,243 and No. 2,373,692



TV BOOSTERS and DISTRIBUTION SYSTEM

Tune-O-Matic and *Tenna-Top* automatic, self-tuning boosters with uniformly high *usable* gain, for all TV channels. Also, TV Distribution System that provides complete isolation for 4 receivers and can be used in multiple.

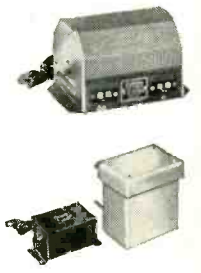

Electro-Voice
 418 CARROLL STREET • BUCHANAN, MICHIGAN
 Export: 13 East 40th Street, New York 16, N. Y., U.S.A., Cables: Arlab

Crystal Products licensed under Brush patents. E-V Pat. Pend.

WE MAKE A Complete Line of FREQUENCY STANDARDS

for

LABORATORIES . . . ARMED FORCES
GOVERNMENT AGENCIES
OBSERVATORIES . . . INSTITUTIONS
MANUFACTURERS' SUBASSEMBLIES
HIGH SPEED TELETYPE MULTIPLEXING
COMMERCIAL FIRMS

and many other applications based on
precision timing, sidereal and mean
time.

FOR A MORE COMPLETE LISTING OF
MODELS SEE OUR AD IN THE 1950
ELECTRONIC BUYERS GUIDE. LOOK FOR
THE DESCRIPTION OF MODEL 105 AND
OTHERS.

We now have 25 standard models and we are
expanding our line at the present time.

Catalog or further information gladly furnished on request.



ERNST NORRMAN *Laboratories*

WILLIAMS BAY, WISCONSIN

20 Years of Specialization in Constant Frequency



Model 127. This is a unit on an 11½ x 4½ inch mounting plate COMPLETE WITH POWER SUPPLY. It can be had with an output frequency as low as 60 cps. Temperature controlled crystal if required.

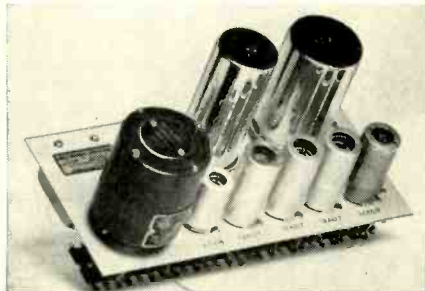

Model 125. This unit is built on a mounting plate 9 x 4½ inches. It has sinewave outputs at BOTH 400 CPS AND 60 CPS.

10 CUBIC FOOT PORTABLE ELECTRIC OVEN



30" Wide
25" Deep
24" High



Model PL-1 \$92.50

REMOVABLE SHELVES
FOR PREHEATING—DRYING
—BAKING

- An individual oven for each operator
- Eliminates handling and hauling
- Can be operated in groups or banks
- Costs less than 5¢ per hour to operate
- Plugs into any 110 V outlet
- Holds 8—2" x 12" x 23" drying pans (extra)

OTHER MODELS \$79.50 AND UP
WRITE—WIRE—ORDER TODAY

GRIEVE-HENDRY CO., Inc.

1650 W. Haddon Street
Chicago 22, Illinois



MAGNETIC AMPLIFIERS • INC

Affiliate of GENERAL CERAMICS & STEATITE CORP.
11-54 44th DRIVE, LONG ISLAND CITY, NEW YORK

A N N O U N C E S

PACKAGED

MAGNETIC AMPLIFIERS



- Standard Units
- Push-Pull or Single
- Completely Self-contained
- As Easy to Install as a Transformer

Other Standard or Specially Engineered Units:
SATURABLE REACTORS, SATURABLE TRANSFORMERS,
PRE-AMPLIFIERS, PHASE SENSITIVE DEMODULATORS,
HIGH FREQUENCY MAGNETIC AMPLIFIERS

THIS BOOK...

The

electronics BUYERS' GUIDE

tells you
who makes each of
fourteen hundred dif-
ferent electronic and
allied products.

Keep it
and use it
for quick buying
and technical reference
throughout the year.

When buying, or requesting prod-
uct information be sure to mention
ELECTRONICS BUYERS' GUIDE.

Plastic & Metal Electronic Components

METHODE, under one roof, offers complete and modern facilities for precision production of plastic and metal electronic components. Methode's products, some of which are shown below, are well recognized by the leading firms in the industry as outstanding in performance and close adherence to specifications. Production experience and engineering know how are now ready to tackle new component problems.

Combining the most modern facilities for . . .

TOOLING • FABRICATING • MOLDING • ASSEMBLY

The modern Methode plant integrates these four essentials to precision and quantity production. Each phase is under the direct supervision of a skilled specialist and mechanized production and test techniques assure prompt deliveries without variation in quality. Our engineering staff will gladly cooperate in solving new design or production problems wherein our facilities can be employed in the manufacture of plastic and metal electronic components or related items.

**. . . METHODE PRODUCTS THAT PROVE
 PRODUCTION AND PRECISION SKILLS**



Molded Phenolic & Ceramic Electron Tube Sockets: Combine space savings and maximum mechanical and electrical performance. Subminiatures mounted by press-fit or "Crimp-in" to plate and feature loop type easily soldered terminals. Miniatures, octals and noval sockets mounted to top or bottom of chassis with rivets. Both 7 and 9-Pin sockets available in combination with "Snap-in" or "J Lock" types of tube shields and bases. Receptacles are general purpose or mica-filled low loss phenolic or steatite. Contact materials are spring brass, phosphor bronze or beryllium copper. Finish on soldering terminals and metal parts in Cadmium plate.

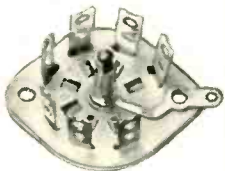

Laminated Wafer Electron Tube Sockets: Designed for minimum cost with large wiring radii permitting easy access for soldering. Sockets feature husky contact with maximum tube retention to withstand difficult shock and vibration. Mounting centers are 7/8", 1", 1 1/8", and 1 5/16". Wafers are of N.E.M.A. Grade XP or XXP Natural or Chocolate. Contacts .013" 70-30 brass or phosphor bronze. Terminals in Cadmium plate finish. Impregnated with cerise wax AA when specified.



Terminal Blocks, Connectors, Terminal Boards: Tooling and production for special terminal boards to customer's specifications performed accurately and promptly. Standard molded connectors and terminal blocks to fill a variety of equipment requirements or custom made for users special purpose needs. Forward your drawings or description of application for immediate attention with no obligation.



Military Type Sockets and Shields: Made to the exacting mechanical and electrical standards of government specifications. Sockets furnished in low loss mica-filled phenolic and grade L-5 steatite. Silver plated beryllium copper contacts with hot tin dip. Tube shields furnished in brass, nickel plated.

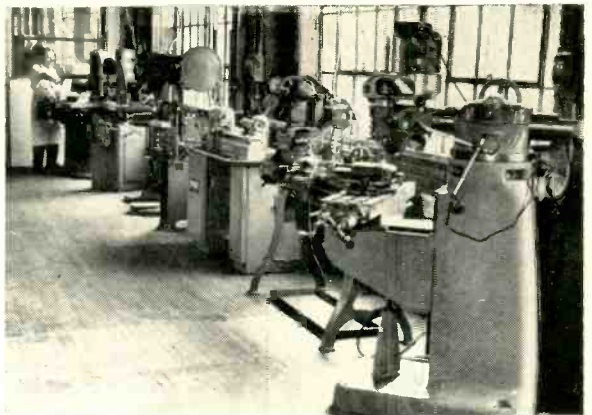

Section of modern toolroom where experienced craftsmen develop and build precision tools, dies, jigs and fixtures.



View of assembly department where carefully selected and trained operators provide large capacity for customers' volume requirements

**PRODUCTION
 DESIGNED TO THE
 MOST RIGID
 GOVERNMENT
 OR INDUSTRY
 SPECIFICATIONS**

The entire facilities of Methode are available for volume production for both government and industry. Our line is being rapidly broadened and the products shown are merely indicative of the type of work and materials with which we are familiar. Our plant is geared to go into large production on specially designed components or assembly work. All inquiries treated with customary Methode promptness.

METAL FABRICATION

TO YOUR SPECIFICATIONS

CHASSIS — PANELS — ENCLOSURES

- instrument panels
- chassis of all kinds
- high voltage cages
- metal assemblies
- spare parts boxes
- foldaway and hinged chassis
- multi-rack cabinets
- brackets and small stampings
- receiver and transmitter housings
- transformer laminations

Complete, up-to-date facilities for metal fabrication, welding, enameling, and baking. Large stock of dies on hand. Engineering facilities and expert production supervision. Prompt deliveries.

We welcome the opportunity to deliver prompt quotations to your blueprints. Close adherence to specifications avoids costly delay and insures trouble-free assembly of your finished product in the finest stylized housings.



Abalon

25 YEARS OF EXPERIENCE
IN METAL FABRICATION

PRECISION MFG. CORP.

540 CASANOVA STREET

NEW YORK 59, N. Y.

LUdlow 9-5682

Millions of Coils

wound on **PARAMOUNT Paper Tubes**

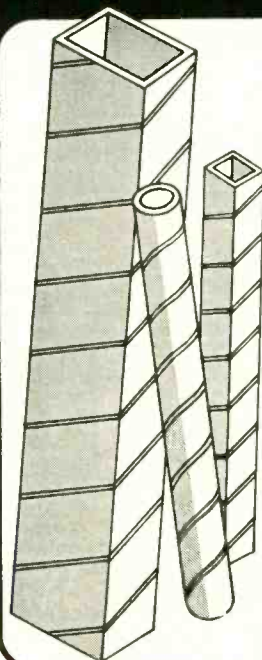

Stock Arbors or Special Tubes to Meet Every Need

SQUARE, ROUND, RECTANGULAR

.450" to 25" I.P. 1/2" to 30" long. Tolerances $\pm .002$ "

You find PARAMOUNT Spiral Wound Paper Tubes at the core of coil dependability in nationally known products and equipment. That's proof they're made right to wind right and stay right on the job. Hi-Dielectric. Hi-Strength. Kraft, Fish Paper, Red Rope, or any combination, wound on automatic machines.

NEW! Shellac-Bound Kraft paper tubing. Heated shellac forms an adhesive bond between the laminations. Absolutely moisture resistant.

SEND FOR ARBOR LIST
OF OVER 1000 SIZES

Write on company letterhead for stock arbor list. Includes many odd sizes.

Paramount

PAPER TUBE CORP.

616 LAFAYETTE ST., FORT WAYNE, IND.

Mfrs. of Paper Tubing for the Electrical Industry

Langevin

AMPLIFIERS



For broadcast, public address, recording, and music services — custom designs for special applications.

Langevin

TRANSFORMERS



Open-core, enclosed, hermetically sealed, high-temperature. Built to your own or MIL-T-27 specifications.

Langevin

ENGINEERING



Available for the development and manufacture of special electronic devices.

For detailed information on our products and services, write to

Langevin

MANUFACTURING CORPORATION

37 W. 65th St., New York 23, N. Y.

NOT...

until next year
will you get another

electronics BUYERS' GUIDE

Don't let it get away from you.

It's the best source of buying information for electronic and allied products that has ever been compiled.

When buying, or requesting product information be sure to mention **ELECTRONICS BUYERS' GUIDE.**

BRADLEY RECTIFIERS

UNIFORM IN RATING • VACUUM PROCESSED

BRADLEY SELENIUM RECTIFIERS

Bradley manufactures selenium rectifiers for operation from a few microamperes to many thousands of amperes and from fractions of volt to thousands of volts.

Our exclusive vacuum process insures low cost rectifiers with uniformity of rating. Power conversion is predictable, accurate and efficient.

On any rectification application involving special problems, consult Bradley. Our engineers can quickly specify the right rectifier for your requirements.

HIGH CURRENT USES

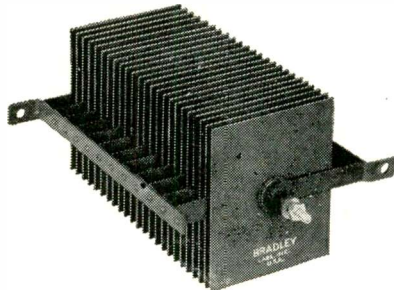

SE11X Series
These large power stacks provide good efficiency and stability. Plate sizes up to 5" x 6". Rated up to thousands of amperes.

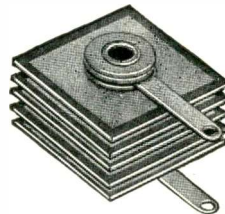

ELECTRONIC APPLICATIONS

BRADLEY RS MINIATURE RECTIFIERS replace most rectifier tubes in radio, television, amplifier and other DC power requirements. Rated 130 Max. RMS volts input, 380 volts peak inverse Max.

HIGH VOLTAGE USES

SE8 Series

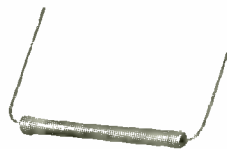

These rectifiers are designed to provide maximum rating and efficiency with minimum size. One model — SE8L, rated 1.5 ma — is smallest completely sealed rectifier in class.

PHOTOELECTRIC CELLS

Bradley Luxtron[®] photocells convert light directly into electric energy to operate meters and meter relays. No external power source is required. Luxtron photocells are rugged, true to rating, and assure stability of calibration. No current drain when not in operation. Wide range of models, sizes and shapes to meet any requirements involving the use of light.



BRADLEY COPPER OXIDE RECTIFIERS

INSTRUMENT RECTIFIERS



Bradley Copper Oxide Instrument Rectifiers have vacuum-processed gold contacts for maximum efficiency and minimum temperature error. Precision made to meet the most rigid matching and balancing requirements, yet low in cost. Universal type rectifier shown for all replacements or AC meter conversions. Rated up to 12 volts AC, 5 ma DC.

HERMETICALLY SEALED RECTIFIERS

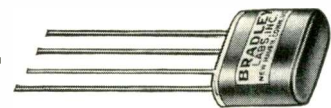

CX 23 Series. Miniature Hermetically Sealed Rectifiers. Modulators and bridges with matched sections for detecting phase differentials in AC currents and small DC potentials applied to balanced AC circuits. Maximum 2 volts continuous as modulators, 6 volts as bridges. Size 5/16" x 11/16" x 3/4".



← Write for your copy of "The Bradley Line", booklet showing many additional rectifier and photo-cell models.

BRADLEY LABORATORIES, INC.

82 MEADOW STREET, NEW HAVEN 10, CONN.

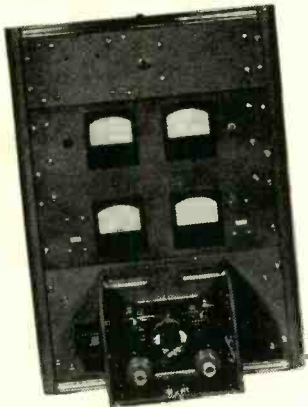

211 Type Yoke Test Set

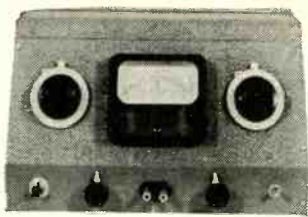

204 Type RF Cond. Test Set

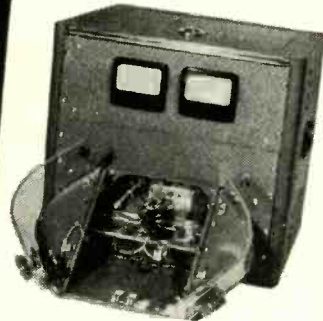

210 Type
Flyback Coil Test
Set

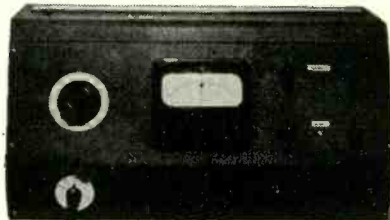

205 RF Coil Test Set

PENNSYLVANIA TESTING LABORATORY

DOYLESTOWN, PENNSYLVANIA

A Timely Service For Solving Complex Production Testing Problems for Companies With Government or Commercial Contract Specifications

Now, more than ever before, many manufacturers are discovering that in meeting testing apparatus requirements, they lack the proper engineering and productive facilities.

This is where we enter the picture, with our highly specialized engineering staff, well trained in the designing of manual, semi-automatic, and automatic testing equipment for all possible kinds of product testing. We maintain accurate calibrating

equipment in addition to operating a complete machine shop for the construction of necessary jigs and fixtures.

Our expert services can save you both time and money. From raw material to end-use application, we can solve your product testing problems. Please write and we will gladly submit a proposal and estimates at no obligation whatsoever.

Pennsylvania Testing Laboratory Is Cleared For Classified Work.



218 Type
Vacuum Tube
Aging Rack

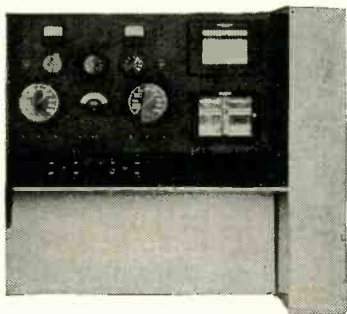

219 Type
Control Panel

226
Synchro
Error
Tester

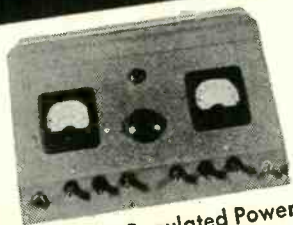
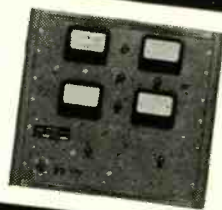

200 Type Regulated Power
Supplies

216
Kinescope
Gas
Detector



VIBRATING REED

FREQUENCY METERS



ROTARY

SELECTOR SWITCHES

Panel Mounting or Portable, for use when constant or known frequency is important to efficient operation of equipment.

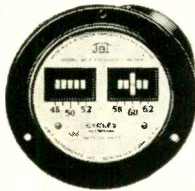

3 1/2" SEALED Frequency Meters

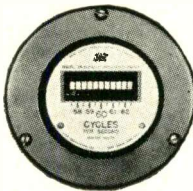

- Permanently Accurate within $\pm 0.3\%$ or better, depending on the model. This accuracy is not affected by poor wave form, external magnetic disturbances, or voltage fluctuations.
- Size and Type for Every Service. Made in a wide variety of portable and panel case styles, reed groupings and frequency ranges from 12 to 525 cycles and above; 100-130 volts is standard.
- Rugged Construction of simplified, patented design, with no moving parts to wear out or get out of calibration. Ideal for field and mobile applications.

Ask for Bulletins VF-43, VF-43-1A-1B-1C-1D, and General Catalog 451

NEW DEVELOPMENT

400 Cycle Dual Range — 2, 5 and 10 Cycle Steps



Model 41-FX — Designed originally for high-quality electrical analyzers of heavy aircraft, this 4" meter is finding many additional applications. The top window with 13 reeds gives a vernier effect indicating 380-420 cycles, with 2 cycle increments in the critical range of 396-404 cycles. The bottom window frames 21 reeds 300-500 cycles in 10 cycle steps for a general idea of the frequency under test. When used with external switching, three voltages: 200-240; 115; and 30 volts can be supplied.

Where 400 cycle readings are important, the Model 41-FX is the all-round working standard — precise for the laboratory, rugged for shop and field.

ELAPSED TIME METERS

For Maintenance, Tube Life Data, and Operating Time Records—on Motor Generators, Transmitters, Receivers, Rectifiers, Test Set-ups, etc.

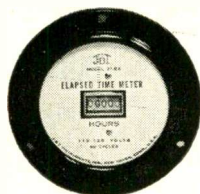

Model 31-EX (illustrated) also known as running-time or total time meter, registers in 1/10 hours to 9,999.9 hours, then automatically resets. Normally stocked for 60 cycles, 110-130 volts. 3 1/2" standard meter mounting. Variations such as 50 cycles; 230 volts; 0-99,999 hours; and 3" rectangular case available on special order.

SEALED TIME METERS

Model 31-EHXX—Completely sealed meter, reading 0-9,999.9 hours, same as Model 31-EX above. Glass-to-metal construction, solder terminals, and 3 1/2" detachable flange, all match XX metal frequency meter case. For mounting, use Sketch SK-53. While not presently stocked, these meters are in production.

FHXX Type Meters, sealed, glass-to-metal construction, with solder terminals, meets or exceeds the sealing and electrical requirements of JAN-1-6 and MIL-M-6A including the 3000 volt breakdown, and uses the front mounting dimensions specified. Max. barrel diameter, 2 11/16"; 2 7/8" overall depth behind flange. Various reed groupings and frequency ranges from 12 to 525 cycles and above; 100-130 volts standard. While not regularly stocked, these meters are in production. See print SK-51, and Catalog 451.

1 1/2" SEALED Frequency Meters

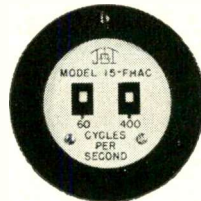

Model 15-FHAC (illustrated half actual size). 60 and 400 cycles, 2 reeds, 8-10 volts, for cathode follower circuit. Widely used on audio oscillators to standardize output. Meets intent JAN-1-6 and amendments on sealed meters. Barrel, 1 1/2" diameter; detachable flange, 2.094" diameter; solder terminals.

Model 15-FH (not illustrated)—same case, sealed, 5 reeds, 58-62 cycles, 100-130 volts. Variations such as 6 reeds, 25 or 400 cycle ranges and higher voltages available on special order.

NOTE ON METER VOLTAGE

J-B-T Vibrating Reed Frequency Meters of all sizes normally are made with two studs and are designed to be connected across one phase of a multi-phase line. The single phase voltage where the meter will be used thus becomes the voltage to be specified for the meter. Special meters with extra studs are made only for the purpose of reading two or more voltages, not additional phases.

FREQUENCY-TIME METERS

Combination Reed-Type Frequency-Elapsed Time Meters — One Meter Does The Work of Two

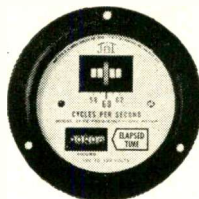

Model 31-FE (illustrated) pioneered by J-B-T, saves panel space and cost. Useful on electrical and electronic equipment, also power units, where both frequency and periodic maintenance are important. 3 1/4" flange, metal case, 4 11/32" overall depth standard. 3 1/2" case, known as 31-FEX-1 supplied on custom orders. 5 reeds, 60 cycle range, standard; 7, 9, 11 reeds or 50 cycle range on special order. For other details, see Elapsed Time Meters in column to the left.

INSTRUMENT TYPE MOLDED SWITCHES

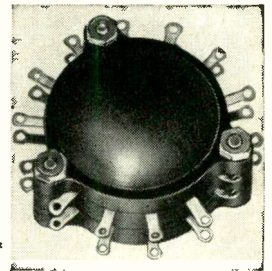

Fully Enclosed Single and Multi-Gang Shorting and Non-Shorting* 14 and 20 Positions 1 to 6 Decks

Model MS-14-2

- All moving contacts enclosed — eliminates dirt and corrosion.
- Contact lugs permanently integrated into switch assembly.
- Sturdy construction with 3-post deck suspension, double-grip collector arms, and rectangular drive shaft through decks for precision indexing.
- Interchangeable, electrically and mechanically with J-B-T Series SS-14 and 20 position Laminated Switches, widely used by industry and the Armed Services.

Normal carrying capacity (not make-and-break) 1 amp.; maximum momentary capacity (not make-and-break) 5 amp.; maximum voltage between contacts and ground, 1000 volts R.M.S.; between decks and ground, 2000 volts R.M.S. Average contact resistance 0.007 ohms or less.

*Ask for Catalog 451

INSTRUMENT TYPE LAMINATED SWITCHES

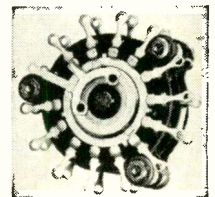

Model SS-14-2

Used widely in quality test equipment, portable instruments, inspection setups and avionics where trouble-free, dependable performance is of major importance. Available in two basic types — 14 and 20 position — the design gives extra contacts in minimum space. One to six decks.

LEVER ACTION SWITCHES

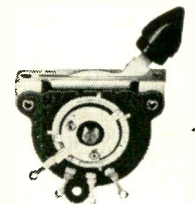

Model SS-14-16H

Excellent for test equipment and communications systems, these switches use the same high quality parts as the SS-14 series. Bracket mounting holes 1 5/8" apart; may be mounted in groups 3/8" between centers. Individually boxed with knobs. Positive indexing type. Available with 3 pos. or 4 pos., Shorting or Non-Shorting.

OTHER J-B-T PRODUCTS

APPLIANCE TEMPERATURE TESTERS
TEMPERATURE INDICATORS
LABORATORY GALVANOMETERS
VACUUM TUBE FREQUENCY METERS

DISTRIBUTOR SERVICE

Standard J-B-T items are available through authorized electronics parts distributors.



J-B-T INSTRUMENTS, INC.

443 CHAPEL STREET

NEW HAVEN 8, CONN.





SAFE Capacitor Specifications

• From tiniest metallized-paper capacitor symbolizing *miniaturization*, to giant oil capacitor for atom-smashing Betatron, you are SAFE in specifying Aerovox. For Aerovox makes *all* categories, types, sizes and ratings. More than that: with a background experience second to none, Aerovox engi-

neers are always ready to study your circuitry, components, operating conditions and anticipated life. Thus capacitor selection is custom-fitted to your exact requirements. And that is why Aerovox capacitors have such outstanding service records.

• *Literature on request. Submit that capacitance problem for engineering aid and quotations.*

INTERFERENCE FILTERS

For military and civilian needs, particularly aircraft and radio-equipped vehicles.

MICA CAPACITORS

Dozens of different types, including low-loss molded casings and the silver micas.

MOLDED PAPER TUBULARS

For extra-severe service. Aerolene impregnant eliminates necessity of stocking both oil and wax tubulars. No deterioration in stock.

OIL CAPACITORS

From tiniest tubulars to giant steel-case units in ratings up to 50,000 volts.

HIGH-TEMPERATURE MINIATURES

Hermetically-sealed with vitrified ceramic seal, in tubular metal case.

METALLIZED-PAPER

Full utilization of space-saving factor, together with self-healing feature,

MICRO-MINIATURES

Molded thermo-plastic tubulars. Two sizes: 3/16" d. x 7/16" l.; 1/4" d. x 9/16" l.

ELECTROLYTICS

Widest choice of containers, terminals, mountings, combinations. In 85° C. and higher temperature ratings.



THE HOME OF CAPACITOR CRAFTSMANSHIP

AEROVOX CORPORATION, NEW BEDFORD, MASS., U. S. A.

Export: 41 E. 42nd St., New York 17, N. Y. • Cable: AEROCAP, N. Y. • In Canada: AEROVOX CANADA LTD., Hamilton, Ont.

SALES OFFICES IN ALL PRINCIPAL CITIES

PARTS

For Cathode Ray Tubes
For Electronic Component
Applications...

ACTUAL
SIZE



SUB-MINIATURE TUBE PARTS

J & H is prepared to supply your requirements for close tolerance parts for tubes specified in equipment for the defense program. Experienced for almost two decades in the design, fabrication and application of these highly precise components.

Our TV gun parts are available for quick delivery in a wide range of lengths, angles, and aperture sizes. Designed for both tilted and straight gun application. Parts feature no visible seams, exclusive high polish finish and mass produced to a high standard of quality and uniformity. Samples available on request.

We also specialize in general metal and mica precision stampings for other electronic applications. Our completely equipped tool and die shop in conjunction with high speed automatic production facilities is prepared to undertake your most critical and exacting parts problems from design to completed product.

Consult with J & H on large or small production requirements.

Your inquiries will receive prompt attention.

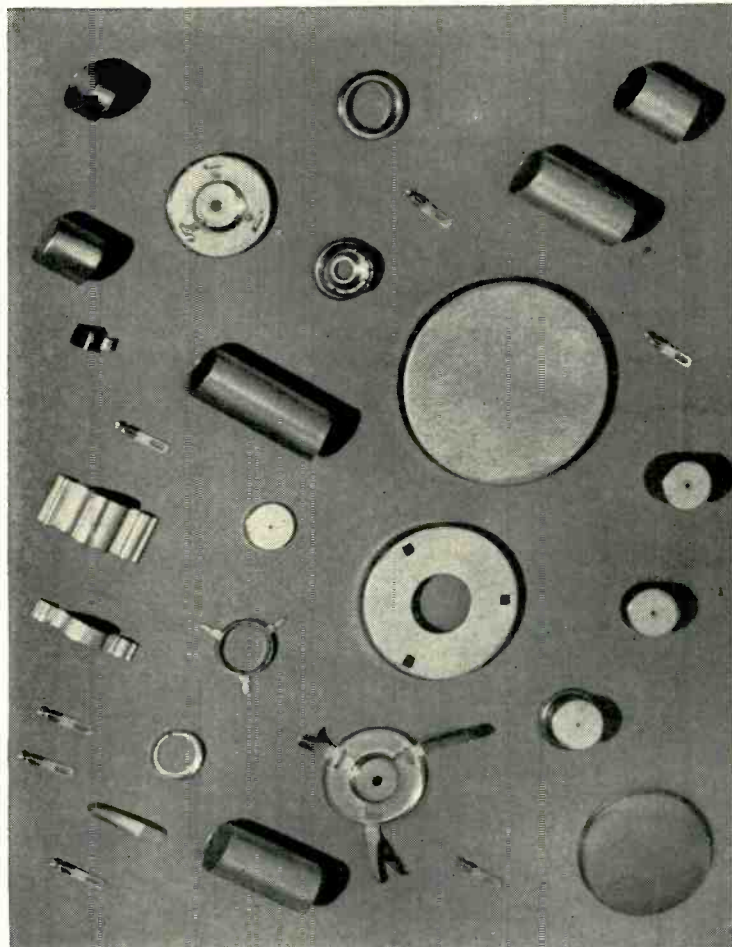

Illustrated are typical examples of our line of Cathode Ray Tube gun parts and other electronic specialty items currently being produced for leading manufacturers.

CATHODE RAY TUBE PARTS • RECEIVING AND TRANSMITTING TUBE PARTS • DEEP DRAWN STAINLESS STEEL PARTS • METAL STAMPINGS • MICA STAMPINGS • TUBE SOCKET METAL PARTS • TOOLS & DIES • JIGS & FIXTURES

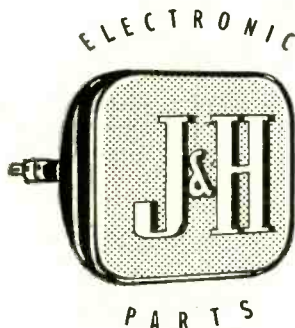

JOHNSON & HOFFMAN, INC.
65 ONGLEY STREET • ROCKVILLE CENTRE, N.Y.

Telephone: Rockville Centre 6-0500

ELECTRONIC AND MECHANICAL ENGINEERING CONSULTING SERVICE AVAILABLE

SWITCHCRAFT

QUALITY COMPONENTS USED BY LEADING MANUFACTURERS OF ELECTRONIC EQUIPMENT



JACKS—FOR MILITARY AND INDUSTRIAL EQUIPMENT DEMANDING A QUALITY PRODUCT

"LITTEL-JAX"—require minimum panel space—available in most common circuits. Military types such as JK-33A (JJ-033), JK-34A (JJ-034), and JJ-089.

"SF-JAX"—short frame design—all circuits. Also to Military Specs.

"LF-JAX"—long frame design for maximum spring life—all circuits.

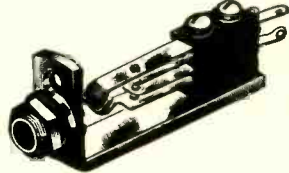

TELEPHONE & MILITARY JACKS

"T-JAX" — a conventional telephone switchboard design—in all standard circuits and to meet military specifications.

"M-JAX"—(illustrated) a heavy duty design used in heavy industrial equipment and as Military Types JJ-079, JJ-081, JJ-082 and JJ-083, per specification JAN-J-641.

PHONE JACKS • PHONE PLUGS

SWITCHES: Push Button, Rotary and Lever Action

Illustrated are representative parts of the regular line. Send for catalogue No. S-51.

Inquiries on custom-made components will receive our prompt attention.

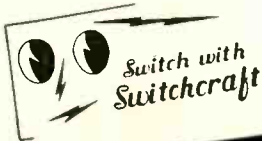

"EXTENSION JAX" — for cable extensions, features "Switchcraft" clamp type terminal for ample cable support. Available in 2- and 3- conductor circuits; Bakelite or Shielded Handles.



"FLAT PLUG"—radically new design—removable cover permits use with screw or solder lug terminals. Available in 2- or 3- conductor types; red or black covers. Ideal for business machines, hard of hearing installations, where projecting handle of conventional plug is objectionable.



"LEV-R-SWITCH"—a lever action switch, unusual because of size, and requires only single hole for mounting. Available in numerable circuits; various contact materials.

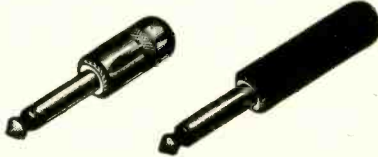

PHONE PLUGS—THE MOST COMPLETE LINE OF STYLES, SIZES AND TYPES.

"LITTEL-PLUG" — small, fits standard Jacks — features clamp type terminal for cable support.

"LUG-PLUG" — small — low cost — high quality.

"STANDARD"—conventional size—heavy terminals—rugged design.



"LITTEL-SWITCH"

Rugged yet small, a Push Button switch available in simple circuits; contacts to suit. Various colors of Buttons.



"FF-SWITCH"

Flat frame support spring "pile-up" in various circuits and contact combinations. "Easy" action of colored push buttons.



"RS-SWITCH"

Rotary switch, rugged frame supports spring "pile-ups"; minimum panel depth. 2-or-3 position; locking or non-locking action.

SWITCHCRAFT, INC. 1328 N. Halsted St., Chicago 22, Ill.

CANADIAN REPRESENTATIVE: Atlas Radio Corporation Ltd., 560 King Street, W., Toronto 2B, Canada. Phone Waverly 4761.

What the 'SCOPE shows...



RAHM Oscillograph RECORDS...

Specifications:
1-2-4 or 6 CHANNELS

Sensitivity:
3 volts/mm
0.9 ma/mm

Freq. Response:
Flat, 0-70 cps.
Down 1/2 at 140 cps.

instantly, accurately, for immediate analysis!

IT'S NEATER! No ink required... no pens to clean. Records dry on non-blurring, heat sensitive DURATAPE. It's handier! Controls easily accessible. Paper supply always visible...

VERSATILE...

Records strains, vibrations, temperatures, freq. displacement, radiation, synchronization.

Folder on request



RAHM INSTRUMENTS, Inc.
12 West B'way, N. Y. 7, N. Y., BArlay 7-3817

this BOOK 11th year now in its

has earned industry-wide acceptance as the only complete and accurate source of buying information for all types of electronic and allied products components and complete equipment

In Addition, this year . . .



tells who has what in production or available in a reasonable time and unrestricted for general industrial use.

electronics BUYERS' GUIDE

Please mention this book when buying or inquiring from it.

AEROLITE

Manufacturers of
**STANDARD & SPECIAL
TELEVISION, RADIO AND
ELECTRONIC COMPONENTS**

Dial Light Assemblies
Terminal Boards & Strips
Harness & Cable Assemblies
Battery & TV Anode Connectors
Fuse & Grid Clip Assemblies
Test Instrument Accessories
Test Prods & Leads
Instrument Plug & Jacks
Assorted Hardware Items
R.F. Inductors & Coils
Lugs and Brackets

We manufacture to government specifications on

Metal & Plastic Parts
Assemblies
Machining and Drilling
Stampings
Designing & Tooling Parts

For Literature Write

AEROLITE

ELECTRONIC HARDWARE CORP.
507-26th St. Union City, N. J.

**This Year
The
BUYERS' GUIDE**

inaugurates

**A
Where-to-find-it Guide**

to the
**1930-1939
electronics'
editorial
contents**

A cumulative editorial
index to the first ten
years of **ELECTRONICS**
Pages C-1 to C-36

Next ten years in next
year's **GUIDE**.

TRAD

WHERE QUALITY BEGINS



**FREQUENCY
SHIFT KEYS**
Model FSK 45

Meets all current military and commercial specifications...operates directly off teletypewriter. Circuits provided for phototransmission. For operation in frequency range 2.0 mcs. to 4.0 mcs. Send for free copy of descriptive brochure.

**MOBILE TRANSMITTER
AND RECEIVER**

Available in 30 or 60 watts output. FM or AM modulated. For use by police, ship-to-shore, amateur or civilian defense units. Frequencies available in the range 2 to 144 mcs. Available with or without receiving equipment. Descriptive information on request.



**VARIABLE FREQUENCY
POWER SUPPLY**

Designed as a power source over a wide frequency range for test purposes. Will deliver an output voltage of 115 volts plus or minus 10% over a frequency range 50 to 6000 cycles. Available in 250 or 500 watt units. This power source was designed to meet requirements of Military Specification MIL-T-945. Complete information on request.



TRAD
TELEVISION CORP.

1001 FIRST AVE., ASBURY PARK, N. J.

*Industrial
Electro-mechanics*

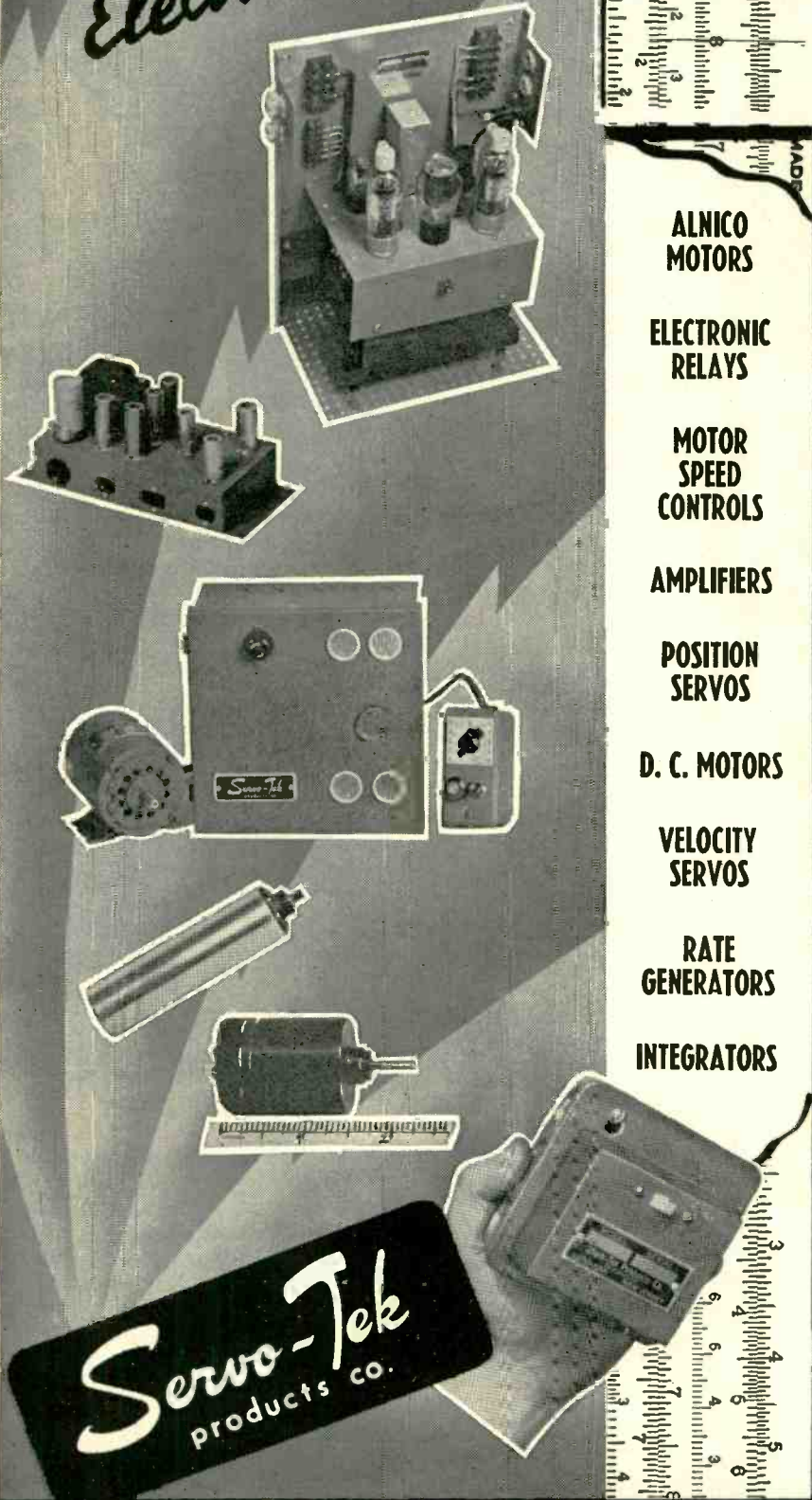

ALNICO
MOTORS

ELECTRONIC
RELAYS

MOTOR
SPEED
CONTROLS

AMPLIFIERS

POSITION
SERVOS

D. C. MOTORS

VELOCITY
SERVOS

RATE
GENERATORS

INTEGRATORS

Servo-Tek
products co.

4 GODWIN AVE. ARMORY 4-3366 PATERSON 1, N. J.

THIS IS THE **ONE BOOK**

THE ONLY
ONE OF ITS KIND

In which
design engineers and
purchasing agents will find
a complete, accurate, and
up-to-date list
of the manufacturers
of all types of electronic
and allied products...
components and complete
equipment.

Keep it handy
for ready reference
throughout the year.

When buying, or requesting
product information be sure
to mention...

electronics BUYERS' GUIDE

famous

KESTER SOLDER PRODUCTS

For The Television, Radio, And Electronics Industry



KESTER "RESIN-FIVE" CORE SOLDER

Formulated especially for Radio and TV; will easily solder such metals as brass, zinc, and ferrous alloys. It is non-corrosive and non-conductive.



KESTER PLASTIC ROSIN-CORE SOLDER

The most widely used solder in the TV and Radio fields. All Kester Solders are made from the finest tin and lead available.

Kester Solder PREFORMS

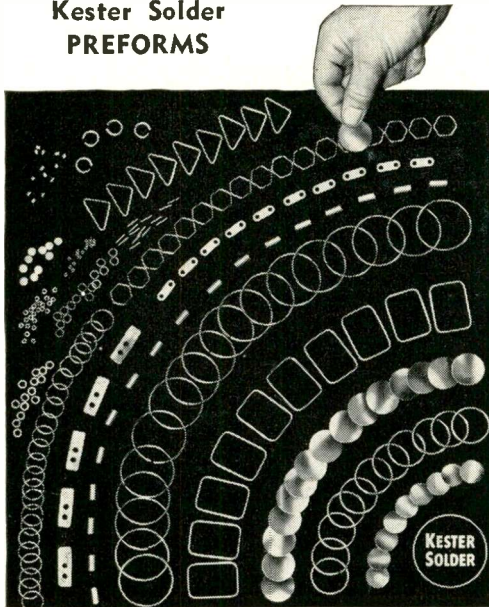

Use Kester Soft Solder Preforms for flame, oven, and induction soldering. Write today for samples and complete information.

OTHER KESTER PRODUCTS

- ★ Kester Radio Solder
- ★ Kester Acid-Core Solder
- ★ Kester "A" Flux-Core Solder
- ★ Kester Nosput Flux-Core Solder
- ★ Kester Knorust Flux Core Solder
- ★ Specialized Flux-Core Solders (over 100,000 different types and sizes)
- ★ Solid Wire and Bar Solders
- ★ External Rosin Soldering Fluxes
- ★ Other Fluxes
- ★ Kester Soldering Iron Brackets

A TECHNICAL SERVICE FOR MANUFACTURERS

If you are not getting peak efficiency or have a specific problem in your soldering operations, take advantage of the facilities of Kester's Technical Department . . . It costs you nothing.

STANDARD FOR THE RADIO AND TV FIELDS

KESTER SOLDER

KESTER SOLDER COMPANY

4204 WRIGHTWOOD AVENUE, CHICAGO 39, ILLINOIS • FACTORIES ALSO AT NEWARK, NEW JERSEY • BRANTFORD, CANADA

ELECTRONICS BUYERS' GUIDE — June, 1951 — MID-MONTH

357

HOUSINGS

for the

ELECTRONICS INDUSTRY

Your choice of height in more than 44 panel sizes, designed to afford greatest utilization of space and weight . . . Streamlined appearance . . . Sturdy . . . Economical . . . Olympic "S" series, "A" series and MIL-T-27 series, with or without snap locks, shipped from stock.

more than
44
panel sizes

for
relays
vibrators
amplifiers
capacitors
instruments
transformers

Case bodies fabricated to any length required. Hot tin dipped to your specifications. Covers and cases modified with hole patterns, cut-outs, mounting brackets or other special requirements.

Facilities available for fabrication of sub-assemblies.



OLYMPIC

METAL PRODUCTS COMPANY INC.
P. O. Box 71A
Phillipsburg, N. J.

TERMINAL BLOCKS

now available for industrial use...

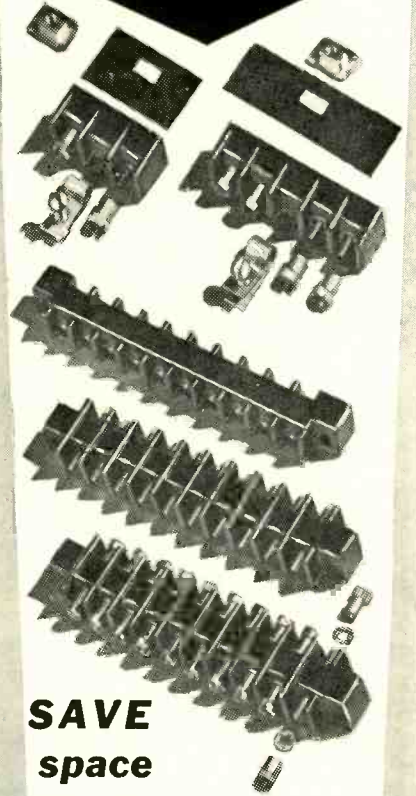

SAVE
space
servicing costs
installation time

Shaw developed these terminals to highest standards for the Navy. They're designed to eliminate non-functional material and take advantage of minimum space. Their maximum strength, high voltage insulation, and quick easy installation make them ideally suited for industry. Send for complete information today.



MOLDERS
SINCE 1892

SHAW INSULATOR CO.
160 COIT ST., IRVINGTON 11, N. J.



If you're looking for **MAGNETIC** and **ACOUSTIC** **DEVICES**



For TV or MILITARY USE

Call **GLASER-STEERS**

Special-purpose, large quantity magnetic devices, precision built to customer specification, are the strong points of GLASER-STEERS engineers.

That's why leading electronics and television manufacturers throughout the nation are now relying on GLASER-STEERS for solving difficult problems involving the use of magnetic and acoustic devices for numerous applications.

Prove for yourself how you can benefit directly from GLASER-STEERS leadership in this field.

Our engineering service is always at your disposal. Just call our office or submit your specifications.

ELECTROMAGNETIC DEVICES
To Your Specifications

**PRECISION HEADPHONES, MICROPHONES AND
LOUD-SPEAKERS BUILT TO SPECIFICATIONS**

PERMANENT MAGNET FOCUSING DEVICES
TV and Military Applications

PERMANENT MAGNET CENTERING DEVICES
For Use With Electrostatic Tubes

PICTURE STRAIGHTENERS
For Correcting Pin Cushion Effect of Deflection Circuit

GLASER-STEERS Corporation

Engineers and Manufacturers of Magnetic and Acoustic Devices

2 Main Street, Belleville 9, New Jersey • BELLEVILLE 2-4480



HIGHLAND ENGINEERING

TRANSFORMERS

for all Industrial and Electronic Applications. Open or cased. Capacities 5VA-50 KVA. Specializing in—**QUALITY—SERVICE—DELIVERY**—on Transformers and Inductors to suit your particular needs. Special units built from standard parts at competitive prices and deliveries.

Send us details of your specifications or requirements which will have our prompt attention.

HIGHLAND ENGINEERING CO.

MAIN & URBAN, WESTBURY, N. Y.

Telephone: Westbury 7-2933

PEAKING COILS

Ceramic Coated to prevent damage to the coil and eliminate all lead breakage.

Another example of our successful effort to insure the best possible supply of **High Quality** coils and transformers.

Coilcraft INC.

3716 N. CICERO AVE.

CHICAGO 41, ILL.

and

CARY, ILLINOIS

INDUSTRIAL DELIVERS . .

to keep your production rolling at top speed.

As specialists in the field of electronic devices, we are prepared to place at your service, our extensive facilities for the design and production of special connecting devices, including those required for military equipment.

Our representatives are located in principal cities throughout U. S. A. Call or write for samples and information.

- SOCKETS
- TERMINAL STRIPS
- BATTERY PLUGS
- ELECTRONIC Connecting Devices

PHONE: ORegon 7-1881

INDUSTRIAL HARDWARE

Manufacturing Co., Inc.

109 PRINCE STREET • NEW YORK 12, N. Y.

a plus feature

Immediately following the Product Listings in the **DIRECTORY SECTION**

of this Issue

is a list of more than

2500

TRADE NAMES

of electronic and allied products.

They are intended for your use in determining the manufacturer's name when only a trade name is known.

WILKOR . . . Resistors

CARBOFILM RESISTORS

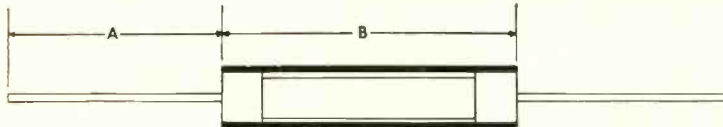

CARBOFILM RESISTORS are manufactured to specifications as to value desired, and furnished to 1% tolerance. This affords a greater degree of flexibility in application without restriction to standard values.

The resistance element consists of pure crystalline carbon, deposited on specially formulated ceramic rods, with film deposit protected by several coatings of Glyptol and vinylite sleeving.

VOLTAGE COEFFICIENT: Maximum change shall not exceed -0.05% when voltage is changed from 1/10 rating to full rating.

HUMIDITY CHARACTERISTICS: Under normal atmospheric

conditions, changes are negligible, and under extreme conditions a change of 5% may be expected.

DEVIATION UNDER LOAD: When operated at full wattage rating, a change of -1.8% may be expected in the CP-1/4 to CP-1 watt resistors. In the CP-2 watt line a change of -1.5% will occur.

AGING: Average change in resistance is approximately 0.2% per year.

NOISE CHARACTERISTICS: Resistance element is terminated by bands of silver over which silver-plated brass caps are fitted to assure positive contact and low noise level which will not exceed $\frac{1}{4}$ microvolt per volt at rated load.

Both CARBOFILM and BORO-CARBOFILM are also available in 5%, 10% and 20% in RMH values only.

* Furnished lacquered. All other sizes furnished with vinylite sleeve.

Types	A	B	C	Minimum	Peak Volts
*CP-1/4 watt	.020 x 1 1/2"	3/8"	.065"	50 ohms	500 K
*CP-1/3 watt	.020 x 1 1/2"	9/16"	.065"	50 ohms	1 meg.
CP-1/2 watt	.031 x 1 1/2"	5/8"	.162"	90 ohms	3 meg.
CP-1/2 watt	.031 x 1 1/2"	11/16"	.230	100 ohms	5 meg.
CPL-1/2 watt	.031 x 1 1/2"	15/16"	.230	100 ohms	10 meg.
CP-1 watt	.031 x 1 1/2"	7/8"	.293	100 ohms	50 meg.
CP-2 watt	.031 x 1 1/2"	2"	.292	150 ohms	200 meg.

BORO-CARBOFILM RESISTORS

WILKOR is also in production on the most advanced development in film type resistors. It is the BORO-CARBOFILM resistor. It involves the introduction of Boron in the making of deposited carbon resistors.

BORO-CARBOFILM has the added advantage of increased range of resistance, extremely low temperature coefficient,

improved stability and lower noise level, with nil effect due to aging.

BORO-CARBOFILM has provided access to resistance ranges heretofore impossible to attain in film-type resistors.

Available in 1/4, 1/3, 1/2, 1 and 2 watt types in the same size as the above listed CARBOFILM line.

In writing, kindly give your requirements in sizes and volume.

COROHM WIRE WOUND RESISTORS

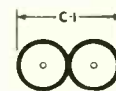
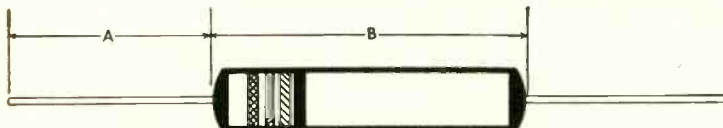

Now available is a new line of WILKOR wire wound resistors that are molded and completely insulated. Uniforming wound to the highest standards using nichrome and #180 alloy, providing low temperature coefficients and

high stability. Furnished in tolerances of 5%, 10% and 20%. This new line is thermo-shockproof and designed for long extreme atmospheric conditions. Manufactured to JAN 184 specifications. (Approval applied for)

For closer tolerance the WILKOR DUOHM resistor is available consisting of matched pair resistors molded as one unit.

Available from:
 *1 to 7 ohms, 2%
 *7 to 500 ohms, 1 or 2%
 **2 to 10 ohms, 2%
 **10 to 1000 ohms, 1 or 2%

Types	A	B	C-1	C	Maximum	Minimum
WCSM 1/2 watt	.031 x 1 1/2"	7/16"	.125		750 ohms	10 ohms
WCM 1/2 watt	.031 x 1 1/2"	5/8"	.218		1000 ohms	10 ohms
WCM 1 watt	.031 x 1 1/2"	1-1/4"	.281		2000 ohms	20 ohms
WCM 2 watt	.031 x 1 1/2"	1-3/4"	.328		4000 ohms	30 ohms
WCM 5 watt	.040 x 2"	2-3/8"	.625		15000 ohms	40 ohms
*WPM 1 watt	.031 x 1 1/2"	5/8"	.218	x .375		
**WPM 2 watt	.031 x 1 1/2"	1-1/4"	.218	x .375		

WILKOR PRODUCTS INC.
 2882 Detroit Avenue • Cleveland 13, Ohio



HILLBURN

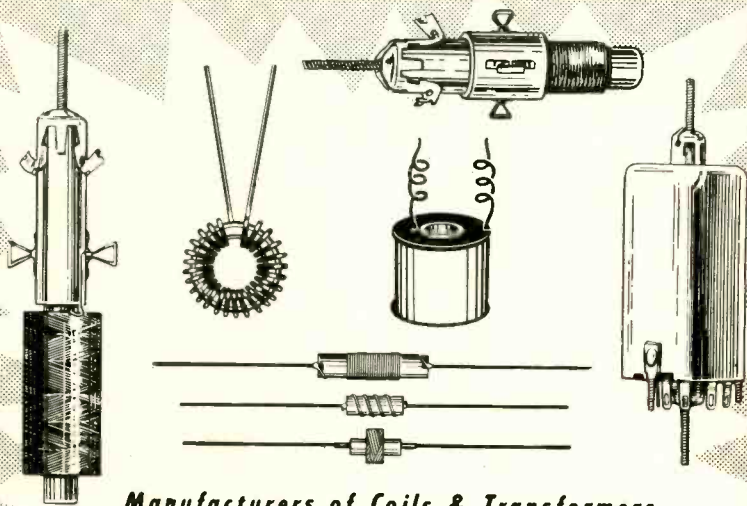

Manufacturers of Coils & Transformers

- I. F. Coils and Transformers
- Linearity and Size Coils
- Peaking Coils and Plate Chokes
- Loading Coils • Torroids • Bobbins
- Solenoid, Universal, Random and Space Winding to Commercial or Military Specifications

HILLBURN ELECTRONIC PRODUCTS, 55 NASSAU AVE., BROOKLYN 22, N. Y.

Prodelin

MICROWAVE ANTENNAS AND TRANSMISSION LINES



Prodelin Microwave Antennas

Designed to provide maximum physical and optimum electrical properties for consistently reliable service at frequencies to 3500 mcs., Prodelin microwave antennas are available with spun or screen reflectors. All antennas are supplied with rugged mounting brackets and Prodelin "Air-Tite" couplings which adapt to solid or air dielectric coaxial cables of various sizes through standard Prodelin adapters.

Prodelin Transmission Lines

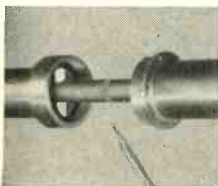

There is a Prodelin "New Series" transmission line designed to meet virtually every communication requirement.

Series 800. A premium broadband coaxial transmission line, designed for continuous service at any frequency up to 3500 mcs. Nominal impedance, 50 ohms; hard temper OFHC copper tubing; Teflon insulated. Electrically transparent, can be cut at any point without regard for frequency. Military versions available in $\frac{7}{8}$ " or $1\frac{1}{8}$ " sizes under separate AN nomenclature. Commercial lines to $6\frac{1}{8}$ " diameter.

Other "New Series" lines for AM, FM, TV, and telephone microwave relay service are also available.

Job Packaged Engineering

Prodelin Job Packaged Engineering saves valuable time and reduces installation costs. Our long line radio relay link experienced engineers are always ready to discuss your job packaged signal transmission equipment problems.

For Latest Literature Write Dept. B



PRODUCT DEVELOPMENT COMPANY, INC.

ARLINGTON, NEW JERSEY

Hold on to this book

It will be
June 1952
before another
edition is published

IT IS THE MOST COMPLETE,
AUTHORITATIVE AND UP-TO-DATE
DIRECTORY OF ELECTRONIC AND
ALLIED PRODUCTS AVAILABLE.

It gives you the manu-
facturers of each of
more than fourteen
hundred electronic
and allied products.



... gives you information
as to where they are in pro-
duction or available in a
reasonable time and unre-
stricted for general indus-
trial use.

1951-1952

electronics BUYERS' GUIDE

Please mention this book when
buying or inquiring from it.

EQUIPMENT FOR AM-FM-TV STATION USE—BY



GRAY professional equipment for broadcast station use is conceived, designed, engineered and built by specialists in the audio-video field. The products here described are widely used, approved and recommended by networks and independent stations. Broad acceptance by the industry is our best testimonial to the high quality and serviceability built into equipment manufactured by Gray.

Gray TELOP (TELEvision Optical Projector)

Makes PROFITS GROW for TV Stations. The Gray Telop projects low-cost, easily produced TV 'commercials.' Without keystoneing, any two photos, titles, slides, etc., or small objects may be broadcast with superimposition, lap dissolve or fade-out. Four optical openings. Strip material may be used horizontally or vertically with Stages #2 and #3. (For full details write for Bulletin T-101.)

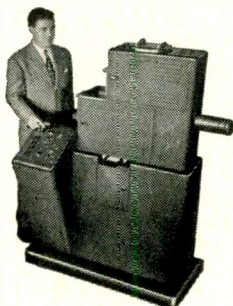

Gray STAGE #2

Attaches to three optical openings of the Telop. Accommodates roll stock vertically to televise commentary or the commercial in the same way movie introductions are projected.

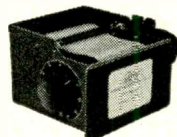

Gray STAGE #3

Attaches to optical openings of the Telop. News ticker tape fed from 8-mm reels is projected on any part of the screen, top to bottom, horizontally. May be used with test pattern or other commercial.



Gray TV CAMERA TURRETS

Enable a Single Camera to Serve up to 8 Projectors

MODEL 556

Centered on a rugged 'square' pedestal, requires a minimum of space. Heavy duty ball bearings. Rotates 360°.



Gray LIGHT BOX for Transparencies

Provides back lighting for Telop use.



Gray REVERSE READING CLOCK

For use where reversal is required. Designed to permit superimposing of the commercial or other copy.

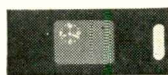

Gray MULTIPLEXER Model 600

A precision arrangement of mirrors for operation of pairs of projectors simultaneously into a single TV camera or individually into two separate cameras. Enables a greater number of projectors to be used with fewer highly expensive TV cameras.

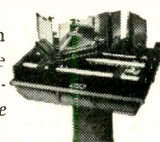

Gray TRANSCRIPTION ARMS

NEW Viscous-Damped Model 108-B Arm

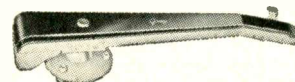

For all records — 33 $\frac{1}{3}$, 45 and 78 r.p.m. Radically new suspension development on the viscous damping principle for perfect tracking of records and elimination of tone arm resonances. Instant cartridge change with automatic correct stylus pressure. Solves all transcription problems. IDEAL FOR LP RECORDS. For Pickering and GE cartridges.

Model 106-SP Arm

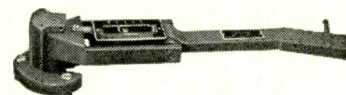

Designed to meet strictest requirements of modern highly compliant pickup cartridges. Three cartridge slides furnished enable GE 1-mil, 2 $\frac{1}{2}$ -mil or 3-mil cartridges or Pickering cartridge to be slipped into position in a jiffy. No tools or solder! Superb reproduction of 33 $\frac{1}{3}$, 45 or 78 r.p.m. records. Low vertical inertia, precisely adjustable stylus pressure.

Gray EQUALIZERS

MODEL 602 EQUALIZER has been specially engineered to provide constant velocity frequency response for both conventional and LP records. Four steps—flat, transcriptions, good records, poor records. Gray Equalizers used as standard professional equipment by broadcast stations.

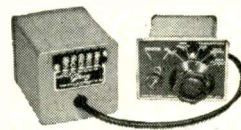

MODEL 603 — Has 5 control positions. For both GE and Pickering cartridges.

Gray Color Television Monitor

This latest product of Gray Research was developed for professional monitoring of color telecast of the CBS field sequential system.



Gray MILITARY PRODUCTS

Illustration shows typical airplane controls made for Hamilton Standard, Division of United Aircraft Corporation. Other military developments and products include video indicators, intricate mechanisms, trainers, electronic-mechanical development contracts.

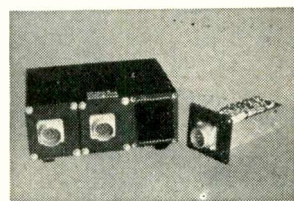

Please write for bulletins describing the above equipment.

GRAY RESEARCH

and Development Co., Inc., 16 Arbor St., Hartford 1, Conn.

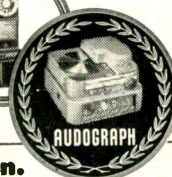

Walter C. Ostrowski
President

Division of The GRAY MANUFACTURING COMPANY—Originators of the Gray Telephone Pay Station and the Gray Audograph

**SPECIALTY
MASS PRODUCTION
PRECISION FABRICATION
OF SHEET METAL PRODUCTS
TO YOUR OWN OR
GOVERNMENT SPECIFICATIONS**

COMPLETE facilities under one roof for quality mass production—including Heliarc welding, baking and finishing. Whistler and Wiedermann equipment for short runs. Tool and die engineering and designing. Completely conveyerized finishing facilities.

Large assortment of stock and special dies for the radio, television and electronic field. Production and engineering under the direction of a competent executive who has had over 36 years experience in sheet metal fabrication backed up by a substantial organization and personnel with Know-How.

Chassis	Instrument Housings
Enclosures	Panels—Boxes
Metal Cabinets	Sample Models
Consoles	Water Tight Boxes
Spare Part Boxes to Army-Navy Specifications For Immediate Delivery	

Expert Design Consultation on your sheet metal requirements
QUOTATIONS CHEERFULLY GIVEN UPON REQUEST

ART-LLOYD METAL PRODUCTS CORP.
2973 Cropsy Avenue Brooklyn 14, N. Y.

Telephone: ESplanade 3-2400-1

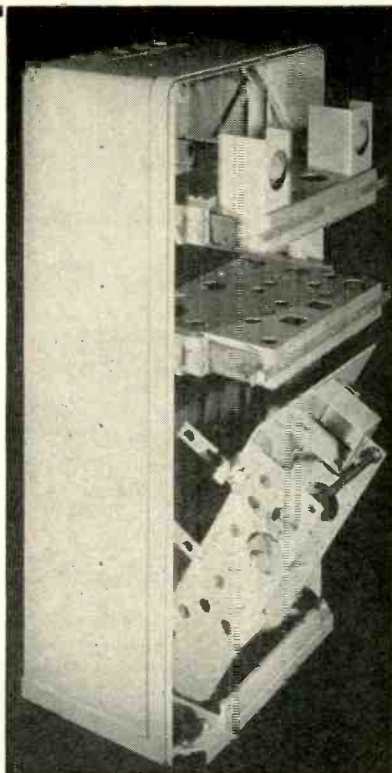

COILS

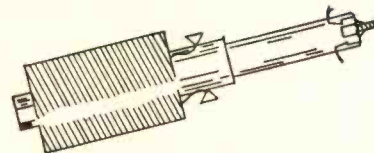

TO YOUR SPECIFICATIONS

For TV — Radio — FM or any other application you desire.

For quick dependable service.

For long or short production runs.

Write, wire, phone or send your prints. No obligation of course.

Complete facilities and experience available to complete your entire sub-assembly

CENTRONICS CO.

Leader in the field of electronic design and manufacture

5065 Broadway, New York, N. Y.
LOrraine 9-4540



PECIALTY OFFERS



LAB-BILT DRY BATTERIES Standard or Custom-made



INDUSTRY

LABORATORY



RADIO AND
IGNITION



Write for **FREE CATALOG**

This catalog gives complete specifications of 78 Lab-Bilt Batteries of industrial and hard-to-get types.

CUSTOM-MADE BATTERIES

Battery Specification Sheet illustrated in catalog enables you to get any type dry battery designed and made to your individual specifications — even in small quantities!

SUPER SERVICE

Specialty Battery Company is specially equipped to make all Lab-Bilt Batteries FRESH for each order and ship immediately. Give your customers this valuable service. Write for a new catalog today.

SPECIALTY BATTERY COMPANY

A Subsidiary of the **RAY-O-VAC** Ray-O-Vac Company

MADISON 10, WISCONSIN

Included in the
DIRECTORY SECTION
of this Issue
is a list of more than

850

**DISTRIBUTORS OF
ELECTRONIC COMPONENTS**

and

ELECTRONIC EQUIPMENT

They are ready and
willing to serve you.

When ordering, be sure
to mention the . . .

**electronics
BUYERS'
GUIDE**

THE MB MANUFACTURING COMPANY, INC.

1070 State Street, New Haven 11, Conn. • Products for the Measurement, Reproduction and Control of Vibration

MB VIBRATION EXCITERS and CALIBRATORS

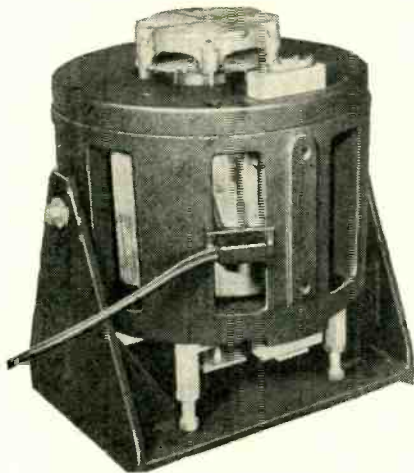

S-3 EXCITER

These MB products have shown themselves to be valuable, versatile test and quality-control tools to industry. Producing results quickly, dependably, and often *visually*, they have many important applications. For example: (1) Fatigue testing of mechanical and electrical structures to destruction under dynamic loads . . . (2) Determination of noise sources in automobiles, bodies and chassis, air conditioning equipment, blowers and similar equipment . . . (3) Shake testing of light electrical components such as relays, switches or radio chassis to determine the ability of components to operate under high vibratory loads. . . (4) Determination of damping characteristics of rubber, steel, brass, plastics and other materials. . . (5) Identification of resonant frequencies and modes. These exciters also provide a convenient means for determining natural modes of wings, stabilizers, fin and control surfaces on aircraft structures.

The Model C-1 and C-31 Vibration-Pickup Calibrators listed below have been specifically designed for the requirements of calibration work. Not only can they be used for calibration of vibration pickups over wide frequency range, but also as vibration exciters.

These exciters are designed to conduct vibration tests to MIL-E-5272 specifications.

Model No.	Rated Force	Total Stroke	Power Supply	Usable Range c.p.s.
S-D	10 lb.	1/2 in.	Electronic	20 to 20,000
C-31	25 lb.	1/2 in.	Electronic	4 to 70,000
C-1	50 lb.	1/2 in.	Electronic	4 to 70,000
S-3	200 lb.	1 in.	Rotating	3 to 500
C-5	500 lb.	1 in.	Rotating	3 to 2000
C-25	2500 lb.	1/2 in.	Rotating	3 to 500

T112031 POWER SUPPLY (for Model C-1)

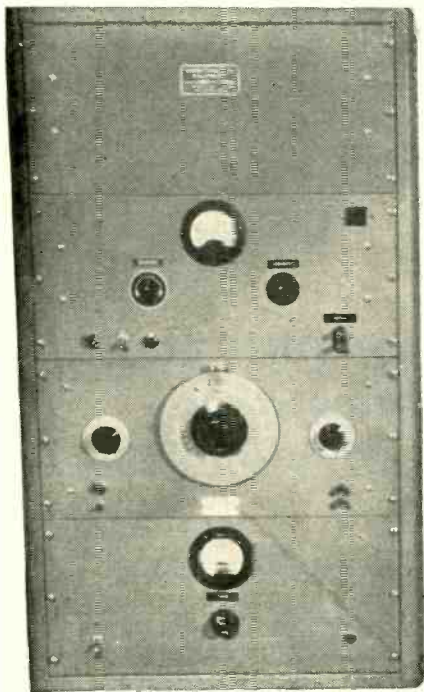

MB VIBRATION PICKUP

An aid to vibration control and production inspection . . . sensitive to low amplitude vibration . . . can be used with wide range of equipment . . . simple field adjustment converts from horizontal to vertical use . . . electrically damped . . . maintains calibration over wide temperature ranges . . . resonant frequency below 5 c.p.s.

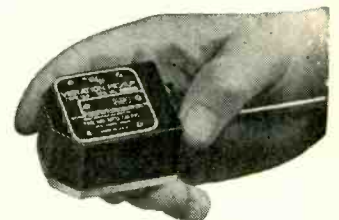

MB VIBRATION METER

This precision Model "M-1" meter offers a complete, compact unit for vibration measurements when used in conjunction with the MB vibration pickup. It provides for accurate readings of accelerations, velocities, amplitudes. Simple, rugged, battery-operated, and portable, it is outstanding for quality control or research.



ISOMODE* COMPRESSION-TYPE ISOLATORS

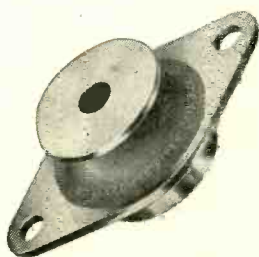

These units utilize the properties of rubber in balanced compression and shear. They provide large deflection ratings together with high load capacity, small size, and exceptional stability. Have equal spring rates in all directions—mount at any angle—absorb vibrations for every plane. Unit load-range 50 lbs. to 2500 lbs. Write for the *Isomode* Design Chart.

STANDARD PLATE-TYPE ISOMODE* MOUNTS

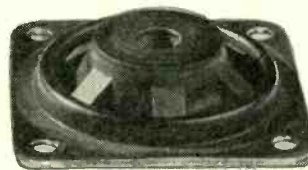

These vibration isolators are built with standard mounting dimensions—are available for loadings of 1/2 to 100 pounds per unit. An outstanding feature is the equal spring rate in every direction. No matter at what angle they are installed, they will absorb vibration with same high efficiency. Conform to MIL-I-5432 (AN-I-16a) Drawing AN 8008 Insulator-Vibration.

*Reg. U. S. Pat. Off.



Specify CLARK CRYSTALS; CRYSTAL OVENS AND ASSOCIATED EQUIPMENT FOR MILITARY APPLICATIONS

*Specify Crystal Oven CO-10 for use with these types.
**Specify Crystal Oven CO-13 for use with these types.

Freq. Range	Tol.	Temp. Range	Circuit	Cap.	Type	Jan Spec.	Designation	Holder	Pins	Spacings
75-150 Mc.	±.005%	-55 to +90°C	ser. res.	HSM-2UH	MIL-C-3098	CR-23/U	HC-6/U	.050"	.482"
15-75 Mc.	±.005%	-55 to +90°C	ser. res.	HSM-2H	MIL-C-3098	CR-32/U*	HC-6/U	.050"	.482"
15-75 Mc.	±.002%	75 ±5°C*	ser. res.	HSM-2HO	MIL-C-3098	CR-33/U	HC-6/U	.050"	.482"
10-75 Mc.	±.005%	-55 to +90°C	par. res.	32mmf	HSM-2HP	MIL-C-3098	CR-24/U	HC-10/U	.050"	.482"
15-50 Mc.	±.005%	-55 to +90°C	ser. res.	HSM-3H	MIL-C-3098	CR-19/U	HC-6/U	.050"	.482"
1-20 Mc.	±.005%	-55 to +90°C	ser. res.	HSM-2MS	MIL-C-3098	CR-28/U*	HC-6/U	.050"	.482"
8-20 Mc.	±.005%	75 ±5°C*	ser. res.	HSM-2MS	MIL-C-3098	CR-19/U*	HC-6/U	.050"	.482"
1-15 Mc.	±.005%	-55 to +90°C	par. res.	32mmf	HSM-2M	MIL-C-3098	CR-18/U	HC-6/U	.050"	.482"
1-15 Mc.	±.005%	75 ±5°C*	par. res.	32mmf	HSM-2MO	MIL-C-3098	CR-27/U*	HC-6/U	.050"	.482"
3-15 Mc.	±.004%	75 ±5°C*	par. res.	28mmf	HSM-1M	USN-16C13	CR-7/U*	CR-7	.050"	.482"
2-15 Mc.	±.02%	-55 to +90°C	par. res.	32mmf	PM-5M	MIL-C-16B	CR-1A/AR	DC-8	.125"	.500"
2-15 Mc.	±.02%	-55 to +90°C	Pierce	54mmf	HSM-8M	AF71-1165A	DC-8	DC-8	.093"	octal
2-10 Mc.	±.02%	-55 to +90°C	par. res.	25mmf	PM-9P	MIL-C-239B	CR-5/U	FT-243	.093"	.486"
2-10 Mc.	±.02%	-40 to +70°C	par. res.	19mmf	PM-2	MIL-C-10405	CR-8/U	FT-243	.093"	.486"
5.000 Mc.	±.005%	-40 to +70°C	par. res.	25mmf	PM-2P	MIL-C-10405	CR-10/U	FT-243	.093"	.486"
5.250 Mc.	±.02%	-40 to +70°C	filter	PM-2F	MIL-C-10405	CR-13/U	FT-243	.093"	.486"
1-10 Mc.	±.02%	-40 to +70°C	ser. res.	PM-2S	MIL-C-10405	CR-8/U	FT-243	.093"	.486"
1-10 Mc.	±.01%	-40 to +70°C	par. res.	PM-4P	SCdata Sh.	HC-1/U	DC-34	.125"	.750"
1.5-6 Mc.	±.02%	-40 to +70°C	par. res.	30mmf	PM-3LT	MIL-C-10405	DC-34	DC-34	.155"	.750"
1.5-6 Mc.	±.02%	-40 to +70°C	par. res.	96mmf	PM-3LR	MIL-C-10405	DC-35	DC-35	.155"	.750"
1.2-6 Mc.	±.02%	-40 to +70°C	par. res.	40mmf	PM-11T	MIL-C-10405	FT-171-B	FT-171	.750"	.750"
1.8-2.8 Mc.	±.02%	-40 to +70°C	par. res.	40mmf	PM-11R	MIL-C-10405	FT-171-B	FT-171	.750"	.750"
.455 Mc.	±.02%	-40 to +70°C	filter	25mmf	PM-9FL	MIL-C-10405	CR-13/U	FT-243	.093"	.486"
2-5 Mc.	±.002%	75 ±5°C*	ser. res.	HSM-2LF	MIL-C-3098	CR-25/U	HC-6/U	.050"	.482"
.080-.2 Mc.	±.01%	-40 to +70°C	par. res.	32mmf	HSM-2LO	MIL-C-3098	CR-26/U*	HC-6/U	.050"	.482"
.080-.2 Mc.	±.01%	-40 to +70°C	par. res.	LF-7P	MIL-C-3098	CR-15/U	HC-5/U	.156"	3 prong
.080-.2 Mc.	±.002%	75 ±5°C**	par. res.	32mmf	LF-7O	MIL-C-3098	CR-16/U	HC-5/U	.156"	3 prong
.080-.2 Mc.	±.002%	75 ±5°C**	ser. res.	LF-7SO	MIL-C-3098	CR-29/U**	HC-5/U	.156"	3 prong

Data sheets on request

SPECIAL CRYSTALS FOR ANY ELECTRONIC, OPTICAL, OR ULTRASONIC APPLICATION. OVENS FOR CRYSTALS AND ASSOCIATED EQUIPMENT. FREQUENCY MEASURING EQUIPMENT.

CLARK CRYSTAL COMPANY Marlboro, Mass., U.S.A.

Successor to Precision Crystal. Cable—Crystal. Phone 1268

Export Dept. Rocke International Corp. N.Y.C.

Want to know about the...

- AUGETRON
- ECCLES-JORDAN CIRCUIT
- KATHETRON TUBE
- MEKAPION TUBE
- PERMATRON
- PETOSCOPE
- SCHLIENEN METHOD
- SCOPHONY
- SEMAGRAPH
- SIRUFER
- SYNDEC
- THEREMIN
- TRATONIUM
- VODER

or other early electronic developments?

You can find out about them in the early issues of **ELECTRONICS**.

The cumulative index to **ELECTRONICS'** first decade, pages C-1 to C-36 in this book, tells you where to look.

AMP

SOLDERLESS WIRING DEVICES for the electronics industry

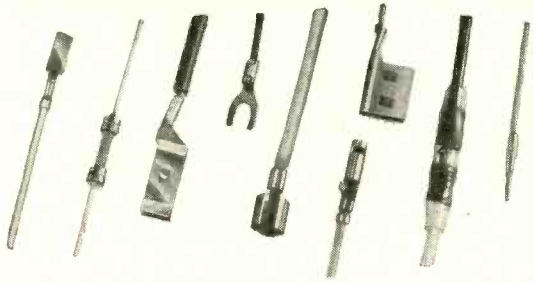

SPECIAL SOLDERLESS PINS, PLUGS, CONTACTS, AND CONNECTORS

Eliminate unnecessary parts, speed production, and reduce costs by designing with AMP'S special connectors in mind. We stock many unusual items, and can make new ones for your particular needs. These terminals are all applied to wire at high speed (from 2,000 to 4,000 per hour) by special AMP Automatic Machines. (see below)



PRE-INSULATED DIAMOND GRIP Trade-Mark SOLDERLESS TERMINALS

No extra insulation sleeving necessary. One operation installs completely insulated, vibration-proof connection.

Plastic insulation of high dielectric properties is bonded to full-length copper sleeve—cannot slip or be removed. Min. breakdown voltage: 2500 volts D.C. in air at sea level. Will withstand high pressure crimp, temperatures at 350° F. for 10 hours without damage. Wire is supported to prevent fraying of wire insulation and torsional stress. Color-coded in wire size ranges from # 22 to # 10. Available in a variety of tongue shapes and connector styles.

U. S. Patents # 2,410,321; 2,379,567; 2,405,111; 2,468,169; other U. S. Patents Pending.

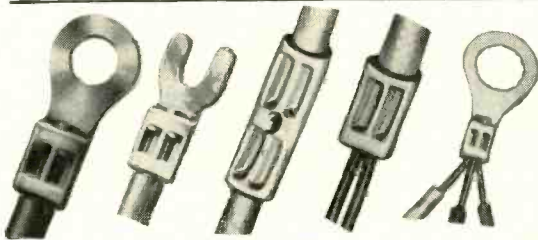

SOLISTRAND SOLDERLESS TERMINALS Trade-Mark U. S. Patents Pending

Unique crimp makes this non-insulated terminal equally valuable for solid, stranded, square, or irregular shaped wire. Brazed seam. One piece construction of high conductivity pure copper, electro-tinned for corrosion resistance. Available in a wide variety of tongue shapes and connector styles from # 22 to # 4/0

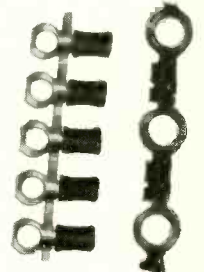

TOOLING

Whatever your production requirements, there is an AMP tool for the purpose. Strong, positive-action hand tools; light weight, compact pneumatic tools; bench presses; dies; hydraulic tools; and Automatic Machines. Terminals feed into AMP Automatic Machines in strip form to yield crimping rates up to 4,000 complete terminations per hour.

WRITE FOR COMPLETE "WIRE SIZE" CATALOG

98 page catalog lists
all AMP tools and terminals.
BY WIRE SIZE RANGES.
Send for your copy today!

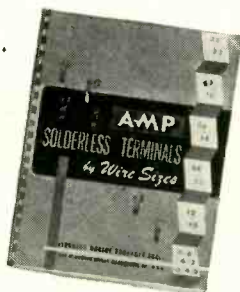

AMP Trade-Mark Reg. U. S. Pat. Off

AMP

AIRCRAFT-MARINE PRODUCTS INC.
ELECTRONICS DIVISION

2100 Paxton Street, Harrisburg 10, Pa.

DO YOU HAVE REQUIREMENTS FOR

JAN C25 CAPACITORS?

if so—write or wire us.

We are presently producing (under contract and sub-contract) a great variety of capacitor types listed in JAN C25 SPECIFICATIONS as well as non-standard units tested to the performance requirements of these specs. If your contracts specify capacitors to meet JAN C25 please contact us immediately for prices and delivery.

If you have other specialized requirements for paper-dielectric (Oil or Wax) and Film-dielectric capacitors or heavy-wire (No. 10 to 20 AWG) r-f CHOKE COILS we welcome your inquiries. Please send your drawings and specifications—we will do out best to serve you.

Who are we? . . . That is a fair question which we can answer to your satisfaction. We are the oldest manufacturer of quality capacitors under the same name and management having been established in 1919—just one year short of a *Third of A Century*.



JOHN E. FAST & CO.

Quality  Capacitors

3101 NORTH PULASKI ROAD

CHICAGO 41, ILLINOIS

When You Think of Capacitors—Think Fast

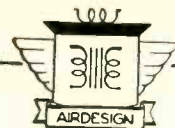

Quality—Specialty

TRANSFORMERS

For years we have supplied leaders of the Electronic and Electrical industries with superior specialty transformers.



Let us quote on your special commercial and military requirements.



A reliable source since
1941



Write us today—or
telephone Granite-4-8000

AIRDESIGN, INC.

241 Fairfield Avenue
Upper Darby 2, Pa.

→ → → →
PROTECT

YOUR PRODUCT

at point of strain

Protect product saleability too—by insuring long life for cords, cables and conductors. Genuine "GRIPMASTER" Strain Reliefs provide these vital features—

- ★ Anchor cords to housings
- ★ Eliminate taping or threading
- ★ Prevent unraveling
- ★ Prevent cord pull damage
- ★ All sizes and styles
- ★ Easy to apply
- ★ Inexpensive

Gripmaster Strain Reliefs are "tremendous trifles" that make good products better!

Ask for samples.

4 WAYS TO END ALL CORD AND CABLE SERVICE FAILURES

Economically



ALL-METAL TYPE

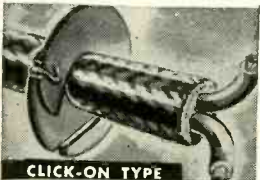

CLICK-ON TYPE

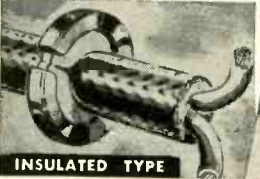

INSULATED TYPE

WIRE BINDING SLEEVES—Preventing fraying of cord ends, these specially-treated rubber tubes are available in five sizes to fit wires to .790



GRIPMASTER STRAIN RELIEFS

Interruptions due to cable and cord connection failures are eliminated because they anchor the cord to the product at the point of strain. GRIPMASTER Strain Reliefs can withstand pulls up to 100 lbs., and are acceptable to Underwriters Laboratories. All types Reg. U. S. Pat. Off.

WRITE FOR SAMPLES AND LITERATURE TODAY!

GEORGE WALKER COMPANY

STRAIN RELIEF SPECIALISTS

118 AMSTERDAM AVE., PASSAIC, NEW JERSEY

this BOOK tells you the MANUFACTURERS of over 1400 types of ELECTRONIC and ALLIED PRODUCTS from . . ABRASIVES to . . YOKES, Deflection and this year . . .



tells you where they are in production or available in a reasonable time and unrestricted for general industrial use.

electronics BUYERS' GUIDE

Please mention this book when buying or inquiring from it.

Kahle equipment for manufacturing sub-miniature, miniature, power and cathode-ray tubes

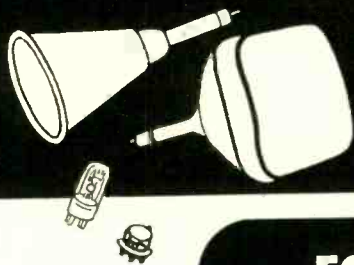

FOR SUB-MINIATURE TUBES

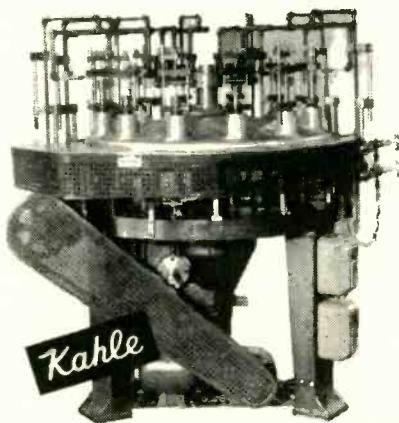

**#1384
12-HEAD BUTTON
STEM MACHINE**

Button $\frac{1}{4}$ " in diameter with 5 long wires. Hand loading and unloading. Dual motor drive. Available for any number of heads and automatic feeds.

**#1375
12-HEAD
SEALING MACHINE**

Also for hearing aid tubes. Kahle Standard Dual Motor Drive. Indexing by barrel cam and rollers. Heads have self-centering bulb holders.

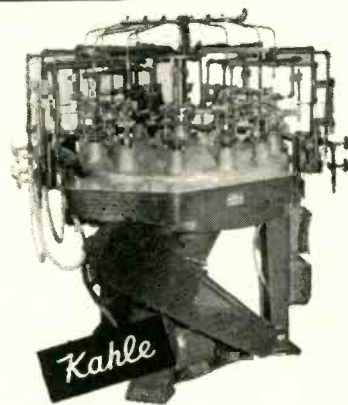

**#1502
AUTOMATIC GLASS TUBING
CUTTING MACHINE**

Vertical type; for soft glass, chill cut, 8-head; indexing. Dual motor drive; variable speed. Single or double cut-off stations. With or without upper structure glass guard. Cap. 1-3,000 pcs. per hour.

Also available for manufacture of sub-miniature tubes:
TUBING (BULB) FLATTENING MACHINE to produce tubulated flattened bulbs. **TUBULATED BULB CONSTRICTING MACHINE** to produce a definitely shaped and sized constriction between the top of the flattened bulb and the tubulation position.

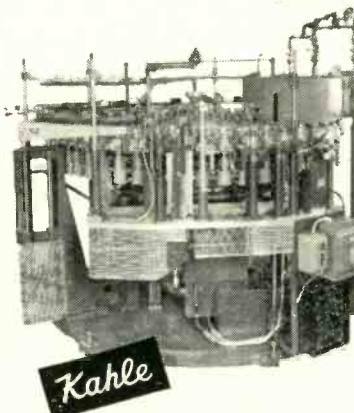
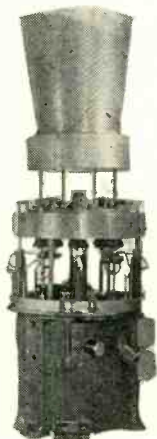

**#1463
40-POSITION
EXHAUST MACHINE**

All degrees of operation from manual to completely automatic. Production limited only by pump equipment or loading speed of operator. Also available with 12 and 32 positions.

FOR MINIATURE TUBES

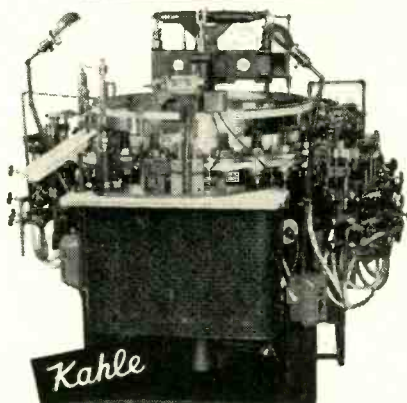

**#1197
24-HEAD BUTTON
STEM MACHINE**

For 7-pin and 9-pin miniature tubes. Available with automatic wire feed, glass feed and unloading of incompletely filled heads. Cap. 1200 per hour.

Complete range of manufacturing equipment for miniature tubes to be produced.

FOR CATHODE RAY TUBES

**#1414
CATHODE RAY TUBE
BUTTON STEM
MACHINE**

Turns out 400-500 TB stems per hour. Fine adjustment of speed, pressure, heat, sequence of operations. Labor saving development for automatic tubulation flaring.

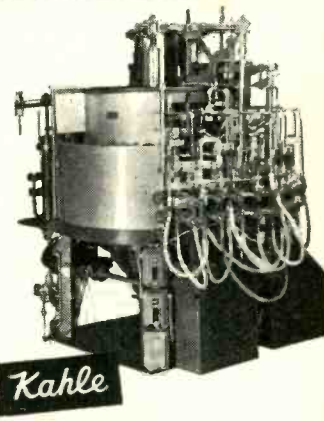

We welcome your consultation
Write for our new catalog.

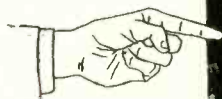

KAHLE ENGINEERING CO.

1309 SEVENTH STREET • NORTH BERGEN, NEW JERSEY

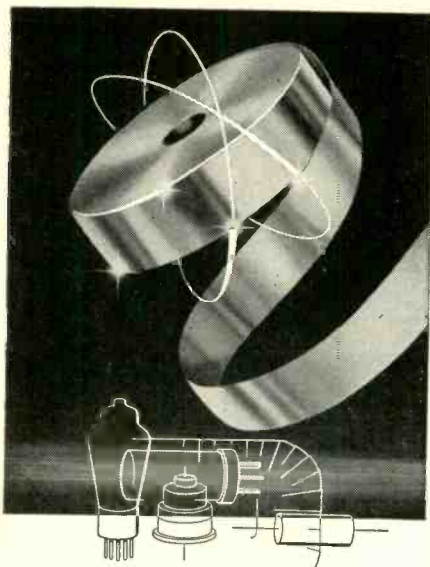

REPUBLIC CONDENSER FOIL

Republic's condenser foil with clean, straight-cut edges, accurate gage and uniformly high quality is custom made for your machines and specific applications. Quality control through every step of manufacture provides true economy in holding work stoppages and rejections to the minimum. Production goes up and costs come down.

ALUMINUM FOIL IN ROLLS SPECIFICATION INDEX

Gage in Inches	Yield in Sq. In. Per Pound	Gage in Inches	Yield in Sq. In. Per Pound
.0002	51,000	.00080	12,800
.00023	44,600	.00090	11,350
.00025	41,000	.0010	10,250
.00030	34,000	.0015	6,800
.00035	29,200	.0020	5,100
.00040	25,600	.0025	4,100
.00045	22,700	.0030	3,400
.00050	20,500	.0035	2,930
.00065	15,700	.0040	2,550
.00070	14,600	.0050	2,050

All commercial widths available from 1/4" mounted on standard 1-5/16" I.D. metal cores. Non-returnable steel cores are available without charge.

INQUIRIES INVITED

REPUBLIC FOIL and METAL MILLS INCORPORATED

DANBURY CONNECTICUT

Telephone 3-2731



BRANCH SALES OFFICES
in Chicago, Ill.
209 W. Jackson Blvd.
in San Francisco, Calif. 666 Mission St.

ELECTRONIC TUBE COMPONENTS

METAL STAMPINGS
POLISHING - PLATING
SCREW M'C'H PRODUCTS
ASSEMBLY WORK

We specialize in the manufacture of all types of lead-in wires for vacuum tight seals for lamps, radio tubes, electronic devices and other special applications. Precision machines, capable of holding these fine wires so that they are accurately located and carefully spaced, assure high operating efficiency and uniformity in the finished product.

CAPS - BASES
LEADWIRES
ALL TYPES
TUNGSTEN LEADS
MOLY NICKEL
KOVAR PLATINUM
AND ALL ALLOYS
NICKEL GLAD COPPER

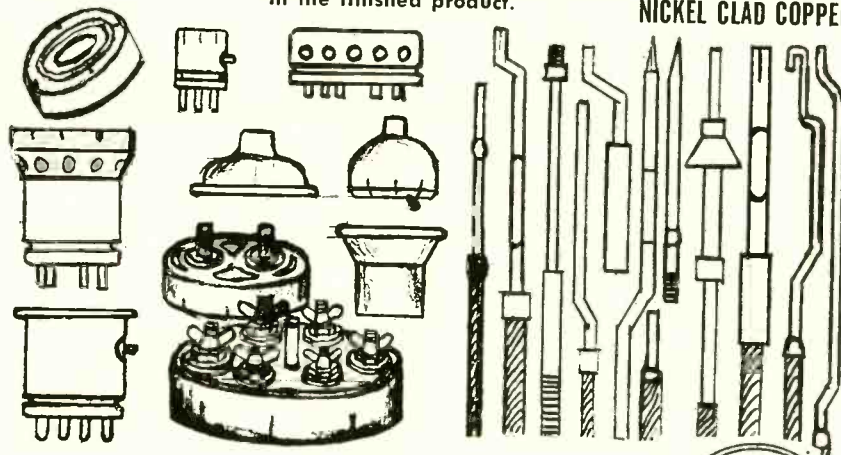

THE ENGINEERING CO.

Daniel Kondakjian

27 Wright St.

Newark 5, N. J.



GOV'T. CONTRACTORS



SPARE PARTS BOXES

CONFORMING
TO

Federal
Specifications
Military
Specifications
Air Force—
Navy Aeronautical
Specifications
Navy Department
Specifications

WRITE FOR FURTHER INFORMATION



MANUFACTURING CO.
OWATONNA, MINN.

SELENIUM RECTIFIERS BY PRECISION

PLASTISEL — A line of moulded-in selenium rectifiers rating from 40 to 150 mills. at 30 volts R.M.S. Half-wave, doubler and center tap configurations. Special configurations on request.

MINISEL — A line of sub-miniature encased selenium rectifiers developed for military applications. Standard half-wave ridge or center tap and voltage doubler configurations—others on request. Ratings up to 20 mills. D.C. and output voltages up to 12,500 units D.C. Plate temperature up to 100°C., 2,000-hour life. Rectifiers are constructed in phenolic tubing, glass tubing and hermetically sealed cans. Free engineering service.

PRECISION RECTIFIER CORP.—Dept. EE

195 Grand Street

Brooklyn 11, N. Y.

PRECISION INSTRUMENTATION

by

Belock Instrument Corporation



DESIGN, DEVELOPMENT, AND PRODUCTION OF
COMPUTERS AND GUN FIRE CONTROL EQUIPMENT

BELOCK INSTRUMENT PARTS

Gears, differentials, dial units, clutches and a complete line of standard parts designed and manufactured to a high degree of precision by experienced computer and control engineers.

BELOCK INSTRUMENT CORPORATION

111th St. and 14th Ave. • College Point, New York

Telephone: FLushing 3-4200

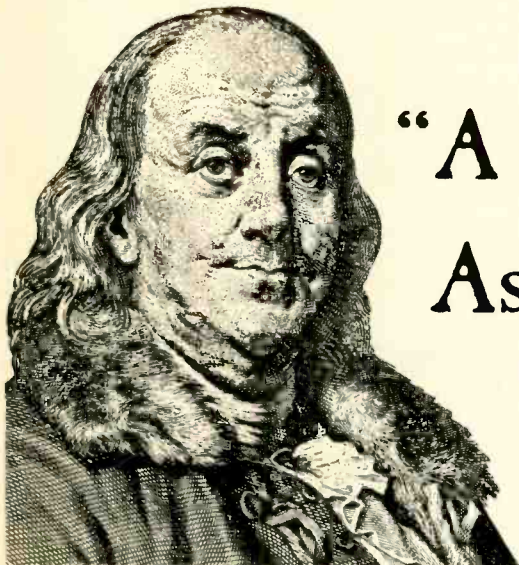

“A Craftsman Is Only
As Good As His Tools!”

—*Benjamin Franklin*

YOU will find the best in Television Picture Tubes and recording apparatus come from the Reeves Soundcraft Laboratories. Magnetic tape with ten distinct features that contribute to its higher efficiency and fidelity; an assortment of recording discs to answer every requirement — a sensational line backed by the greater integrity and experience of the Reeves name, foremost manufacturer of recording and electronics accessories.

Soundcraft rectangular neutral-density filter tubes available in 16", 17" and 20" sizes. ▶



◀ Soundcraft tape is made in all types and lengths to accommodate all tape recorders.

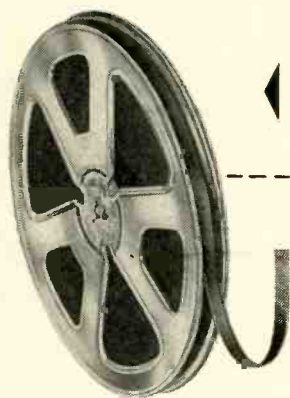

Soundcraft recording discs available in a variety of sizes, single and double face. ▶

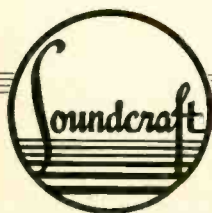

REEVES *Soundcraft* CORPORATION

REEVES—"20 YEARS WITH SOUND RECORDING MEDIA"

10 EAST 52nd ST., NEW YORK 22, N. Y.

EXPORT—REEVES EQUIPMENT CORP., 10 EAST 52nd ST., NEW YORK 22, N. Y.

CORNING GLASS WORKS

Electronic Sales Department — Electrical Products Division

CORNING, N. Y.

ELECTRONIC AND TELEVISION TUBE BLANKS — ELECTRONIC GLASSWARE — METALLIZED GLASS

CORNING TELEVISION TUBE BLANKS



Corning Television Tube Blanks are made of strong, lightweight, lead-free glass with electrical properties ideal for television reception. They are produced automatically to uniformly close tolerances in both round and rectangular design. One-piece construction of neck and funnel provides additional strength. This also improves alignment, eliminating neck shadow and interference with yoke assembly. Large face plates are electrically sealed to prevent distortion, boiling or unsightly variations and again increase overall strength. Round T. V. bulbs—8½", 10", 12½", 16" and 19" in diameter; rectangular 14", 16" and 20" diagonal.

CORNING ELECTRONIC TUBE BLANKS



Electronic Tube Blanks are available in hundreds of sizes and shapes which are low in cost and of uniform high quality. Special glass formulas insure bulbs with desirable electrical properties for

applications involving high frequency, high voltage, and ultraviolet transmission. In addition, special sealing characteristics for temperature requirements can be obtained.

CORNING ELECTRICAL GLASS TUBING

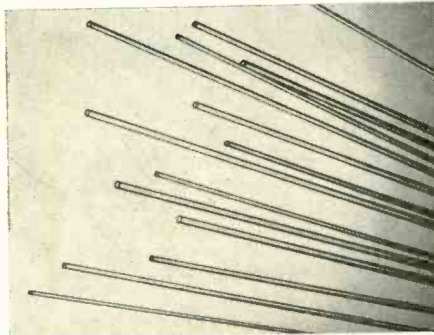

Electrical Glass Tubing performs a multitude of services in the Electronics Industry from supporting and sealing tube elements to providing inductance and capacitor forms. It is available in a wide range of diameters and at low cost. It provides an unusually versatile material for the design engineer.

CORNING HERMETICALLY SEALED BUSHINGS

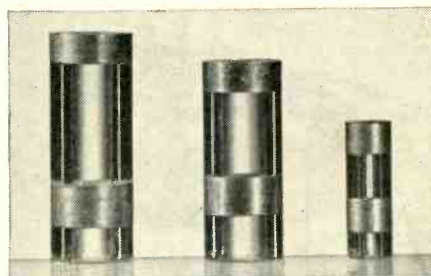

Corning Metallized Glass Bushings provide high quality hermetically sealed terminals for high voltage transformer and capacitor applications. Reliable and accurate, they are moisture and dust free. Ease of installation reduces production costs. Although a complete standard line is available, special designs can be made to individual requirements.

CORNING HIGH FREQUENCY INDUCTANCES

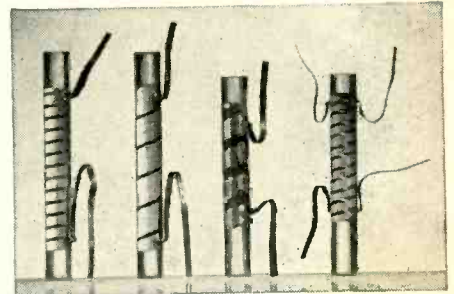

Metallized Glass Inductances and delay line coil forms have high temperature stability and low loss—contribute negligible drift characteristics. They can be obtained with uniform, variable, or double pitch windings and for fixed tuned, permeability tuned or permeability tuned inductance trimmer combinations. They are easily duplicated within very close tolerances in any quantity.

CORNING MIDGET TRIMMER CAPACITORS

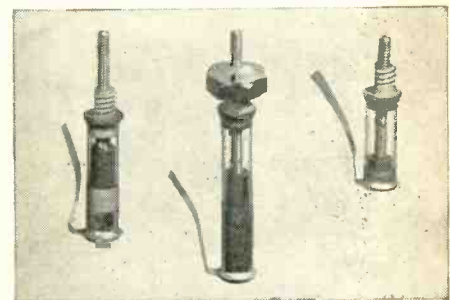

Metallized Midget Trimmer Capacitors are especially suitable for high frequency work where co-axial trimmers are desirable. Small size saves space. Low temperature coefficient insures stability. Design is arranged to make fine adjustments possible.

TECHNICAL SERVICES

Specialists in glass working, quality control, product engineering or design are available to tube and set manufacturers on glass problems.

Specify **BUCK** DESIGN-ENGINEERING

Buck has the capabilities and facilities to work with your engineering staff from the initial planning stage. Also, Buck can work out construction details using your rough sketches or specifications. Either way, you are assured of sound, practical design on special equipment or production pieces. Buck experience solves your problems economically, by painstaking attention, from start to finish. Write for folder.

-for practical solutions to problems of

-IN PRODUCTION ORDNANCE TESTING RESEARCH

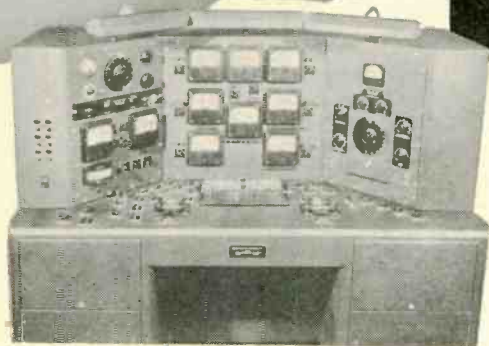

Power output Test Set. Laboratory unit designed and built for Sperry Gyroscope Co. Measures AC gain and power output of receiving tubes.

R.F. Universal Power Output Test Set built for Evans Signal Laboratories. Measurements from 20 to 4000 watts; from 2.5 mc to 60 mc.

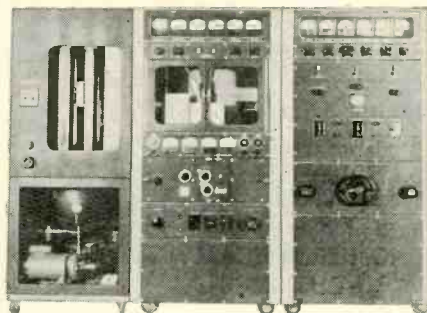

Noise Set, measuring audio frequency noise output of receiving type tubes. Typical of many small special equipments built by Buck to customer's requirements.

BUCK STANDARD TUBE CARRIERS

Designed to facilitate TV tube production by providing safe handling of costly tubes. One of the many standard Buck developments available to manufacturers. Complete catalog on request.



BUCK engineering co., inc.

DESIGNERS AND BUILDERS OF ELECTRONIC,
ELECTRICAL AND MECHANICAL INSTALLATIONS
37-41 MARCY STREET, FREEHOLD, NEW JERSEY

ELECTRONICALLY REGULATED LABORATORY POWER SUPPLIES



• STABLE
• DEPENDABLE
• MODERATELY PRICED

MODEL 28
STANDARD
RACK
MOUNTING

PANEL SIZE
5 1/4" x 19"
WEIGHT 16 LBS.

- **INPUT:** 105 to 125 VAC, 50-60 cy
- **OUTPUT #1:** 200 to 325 Volts DC at 100 ma regulated
- **OUTPUT #2:** 6.3 Volts AC CT at 3A unregulated
- **RIPPLE OUTPUT:** Less than 10 millivolts rms

For complete information write for Bulletin EBG



LAMBDA ELECTRONICS
CORPORATION
CORONA NEW YORK

THIS BOOK...

The electronics BUYERS' GUIDE

tells you
who makes each of
fourteen hundred different electronic and allied products.

Keep it
and use it
for quick buying
and technical reference
throughout the year.

When buying, or requesting product information be sure to mention ELECTRONICS BUYERS' GUIDE.

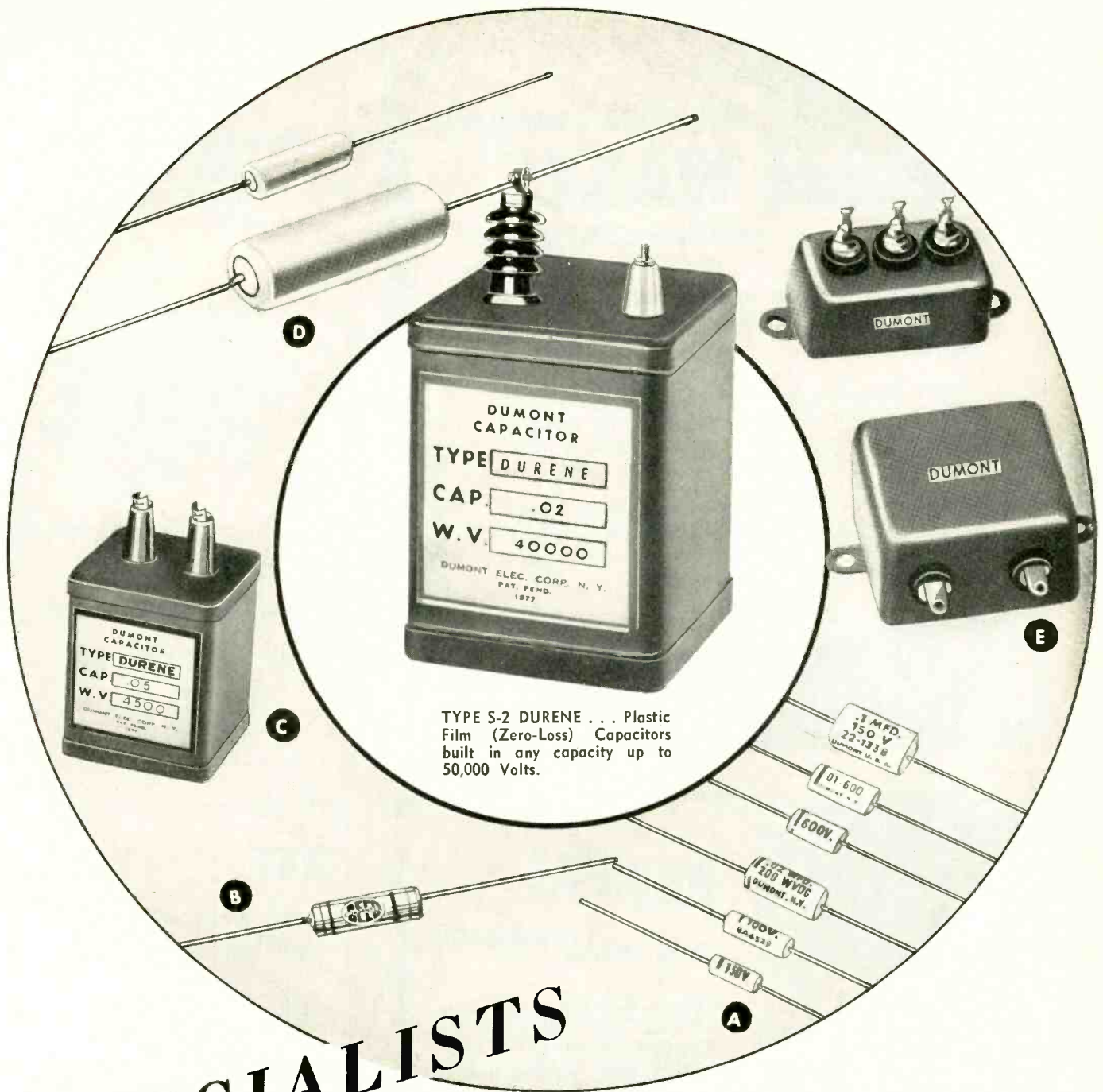

TYPE S-2 DURENE . . . Plastic Film (Zero-Loss) Capacitors built in any capacity up to 50,000 Volts.

SPECIALISTS IN SPECIAL CAPACITORS

Let DUMONT solve your special capacitor problems

- A. TYPE FPI and RP2 . . . NEW 125° Continuous . . . for use where space is at a premium.
- B. TYPE PCST . . . Dumont "Stabilizer" . . . highly stable molded paper units in Ceramic Tubes.
- C. TYPE "DURENE" . . . Tubular shape or in metal cans. (Zero-Loss) Capacitors.
- D. TYPE P20-P21 "METALCAN" . . . hermetically sealed glass ends. For use 125° continuous.
- E. TYPE P22 . . . BATHTUB . . . 85° C to 125° C. Available at no extra increase in size.

Write for descriptive literature and prices.

DUMONT ELECTRIC CORP.

**308 DYCKMAN STREET
NEW YORK, N. Y.**

HI-TEST

INSULATING COMPOUNDS

WAXES

SEALING COMPOUNDS

For dipping, potting, impregnating and sealing of radio components and all types of electrical units

HI-TEST can supply you with materials for highest and lowest temperature applications, with a wide range of melting points, and varying degrees of hardness, flexibility and toughness.

HI-TEST is ready to serve you with products developed and made according to YOUR specifications. If you have a problem requiring a product with special or unusual characteristics, we invite your inquiry.

HI-TEST

CHEMICAL CORPORATION

722 64TH ST., BROOKLYN 20, N. Y.

CERAMIC CAPACITORS

Piezoelectric Ceramics
BARIUM TITANATE
DIELECTRICS

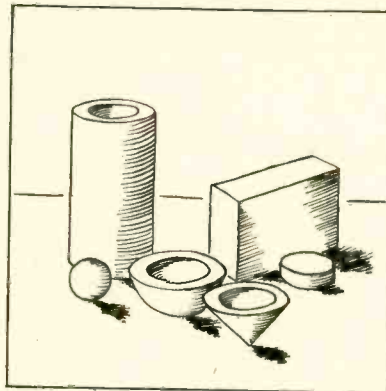

Special Designs
to meet
Specific Requirements

THE U. HANSELL, INC.
50 LIBERTY STREET
WESTERLY, R. I.

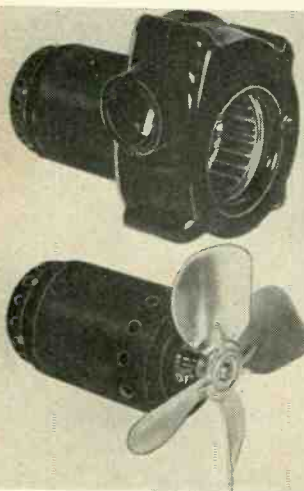

POWER! IN A SMALL PACKAGE

Ruggedly constructed durable motors (precision designed for 400 cycles—60 cycles—variable frequency) operating dependably in equipment requiring specialized performance, are being produced with superior accuracy through the advanced ideas of our designing engineers.

Experimental production, made possible through flexible engineering experience plus experienced production, has resulted in production designs that include motors for fan and blower duty as well as power and drive motors; this will be made exclusively for the electronic industries supplying equipment for military applications.

Ours is an experienced organization with engineering model shop and electrical laboratory for prototypes—this means you gain personnel with "know how" to solve your special motor and A.C. power problems.

WRITE OR CALL

Rugged construction of our motors demands a one piece solid die cast housing with machined cover for back bearing (ball type used throughout), thru bolts, and riveted stator. This insures a continuation of excellent performance after high impact tests by maintaining a concentric air gap at all times.

We are stocked with fans and blowers of the standard types (as illustrated), and are constantly developing special models to meet your exacting needs.

NOT...

until next year
will you get another

electronics BUYERS' GUIDE

Don't let it get away
from you.

It's the best source
of buying information
for electronic
and allied products
that has ever
been compiled.

When buying, or requesting product information be sure to mention
ELECTRONICS BUYERS' GUIDE.

AIR MARINE MOTORS, INC.

2183 JACKSON AVENUE,

WAntagh 2-7309

SEAFORD, L. I., N. Y.

DeJUR

30 YEARS OF PRECISION

ELECTRICAL EXPERIENCE is the heritage behind all DeJUR products engineered and manufactured to meet rigid government requirements. Actual performance records prove that DeJUR components stand up under adverse conditions of vibration, tropical heat and moisture. There's a type to fill your individual need. We can and do produce these units to your design. Your specifications are invited and our engineers will be glad to assist you.

PRECISION

Potentiometers

SERIES L-400 and L-140

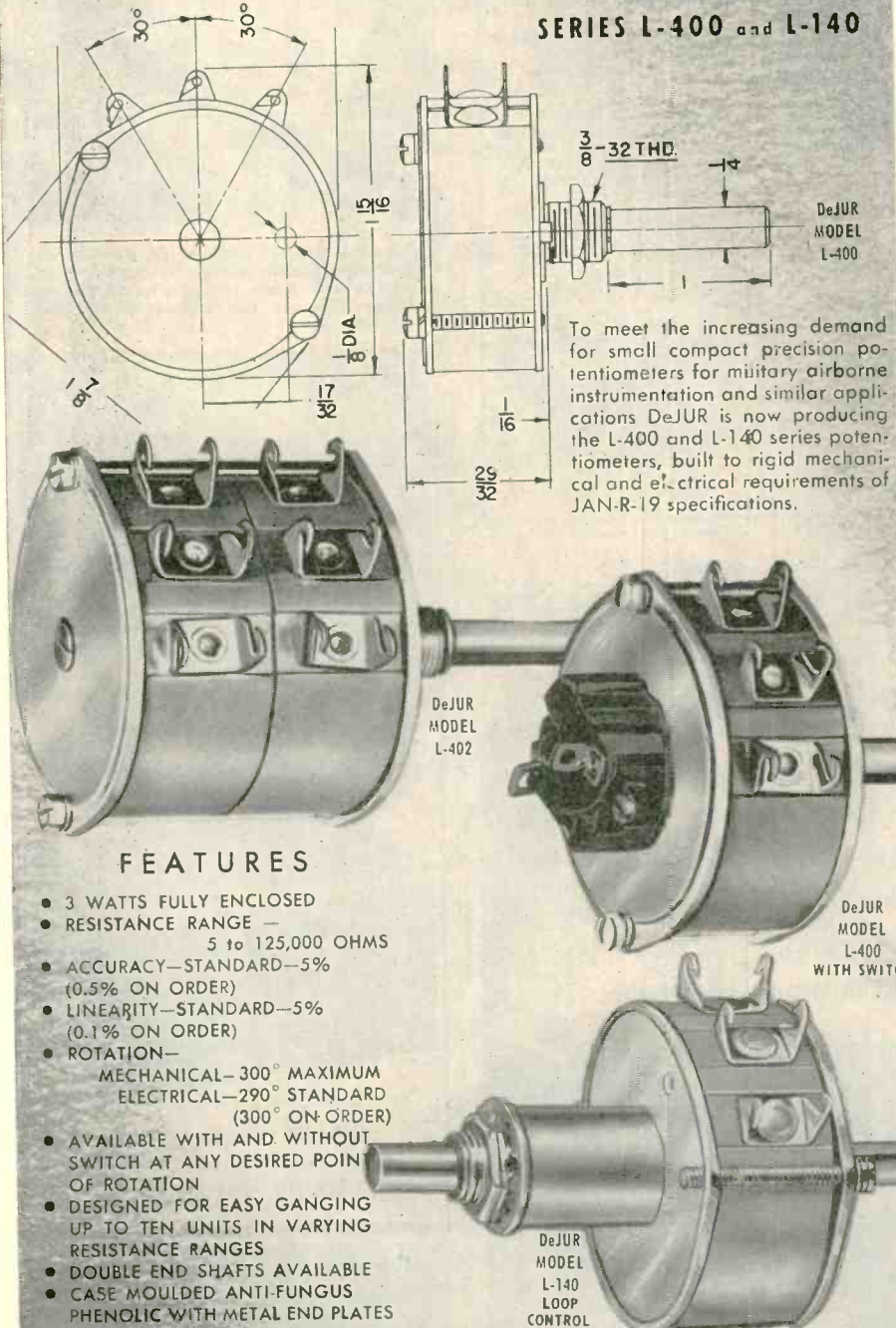

To meet the increasing demand for small compact precision potentiometers for military airborne instrumentation and similar applications DeJUR is now producing the L-400 and L-140 series potentiometers, built to rigid mechanical and electrical requirements of JAN-R-19 specifications.

FEATURES

- 3 WATTS FULLY ENCLOSED
- RESISTANCE RANGE — 5 to 125,000 OHMS
- ACCURACY—STANDARD—5% (0.5% ON ORDER)
- LINEARITY—STANDARD—5% (0.1% ON ORDER)
- ROTATION—MECHANICAL—300° MAXIMUM ELECTRICAL—290° STANDARD (300° ON ORDER)
- AVAILABLE WITH AND WITHOUT SWITCH AT ANY DESIRED POINT OF ROTATION
- DESIGNED FOR EASY GANGING UP TO TEN UNITS IN VARYING RESISTANCE RANGES
- DOUBLE END SHAFTS AVAILABLE
- CASE MOULDED ANTI-FUNGUS PHENOLIC WITH METAL END PLATES

CATALOG EB ON REQUEST • WRITE COMPLETE DETAILS OF YOUR REQUIREMENTS



AMSCO CORPORATION
45-01 NORTHERN BOULEVARD, L. I. C. 1, N. Y.
MANUFACTURERS OF SCIENTIFIC PRECISION EQUIPMENT FOR OVER A QUARTER OF A CENTURY
• CAMERAS • PROJECTORS • ENLARGERS • EXPOSURE METERS •

POWER RHEOSTATS

FEATURES

- New aluminum die cast case
- Maximum heat dissipation
- Aluminum winding core
- Copper graphite brushes
- Linear and non linear tapers
- Resistances: # 241 up to 75,000 ohms # 245 up to 50,000 ohms These extremely high resistances are possible because of new developments in materials, design and winding techniques
- Built to JAN-R-22 specifications



MODEL #241
50 WATT



MODEL #245
25 WATT

DUAL GANGED RHEOSTATS

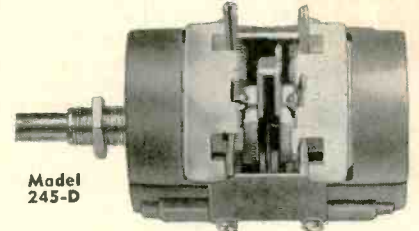

Model
245-D

- BOTH MODEL 241 AND 245 ARE AVAILABLE AS DUAL UNITS IN ANY COMBINATION OF RESISTANCES

PANEL INSTRUMENTS

1 1/2" METERS

FEATURES

- Precision built DeJUR 1 1/2" instruments extensively used in applications where space must be conserved
- DeJUR rugged construction
- Both models in all ranges and sensitivities
- Available either as DC or AC rectifier type instruments (self contained) external shunts and multipliers available for various ranges
- Complete magnetic shielding and methods of lighting scale
- Approved source for government services
- Meets JAN specifications



Model S112



Model S-120

- FULL LINE OF 2 1/2", 3 1/2" AND 4" PANEL METERS IN ALL STANDARD RANGES. BUILT TO COMPLY WITH JAN I-6 SPECIFICATIONS

Write for details



MODEL S-210

2 1/2"



MODEL S-212

4"

MODEL S-310



MODEL S-422



MODEL S-312

3 1/2"



MODEL S-422

Founder of
EISLER PRODUCTS
Established 1920



**DR. CHARLES EISLER,
M. E.**

Professional Engineer
New Jersey License

Member A.S.M.E.

1945 President R.W.M.A.

**EQUIPMENT FOR
MANUFACTURE OF**

- Incandescent Lamps
- Miniature, Standard
- Vacuum, Gas-Filled
- Photo-Flash, Surgical, Special
- Fluorescent
- Hot & Cold Cathode, Neon
- Electronic Tubes
- Glass & Metal
- Receiving, Transmitting,
- Power, Therapeutic, X-Ray,
- Television, Neon,
- Photo Electric Cells
- Wire Forming & Cutting
- Tungsten, Molybdenum
- Copper Glad Wire
- Bases for Lamps & Radio Tubes
- Metal, Bakelite
- Pharmaceutical Glassware
- Ampules, Vials, Test Tubes
- Hydrometers, Thermometers
- Syringes, Eye Droppers,
- Lenses, Coquille Shapes,
- Stirring Rods, Vacuum
- Flasks, Thread Rollers

**A WORD TO
OUR FRIENDS**

For the past thirty-one years Eisler has supplied the most important equipment used in the production of radio tubes, incandescent lamps, television tubes and allied products.

We thank each and every one of our customers—not only in the United States, but in all parts of the world—who have patronized our business for the past 31 years and have used Charles Eisler's machines. Many of these companies have become the world's largest and most outstanding industries, starting with Eisler's equipment. We thank them for their past patronage and hope that we will receive their continued support for many years to come.

With best wishes from

Dr. Charles Eisler M.E.

**EISLER
ENGINEERING CO., INC.**
750 South 13th Street
Newark 3, New Jersey
Tel: Blgelow 3-5310

EQUIPMENT

- Ovens and Furnaces
- Gas & Electric, Induction,
- Vacuum, Hydrogen
- Gas Purifiers
- Argon, Nitrogen, Hydrogen
- Glass Cutters & Slicers
- Glass, Ceramics, Crystal
- Burners & Torches
- Gas, Air, Oxygen, Hydrogen
- Natural & Artificial Gas
- Lathes for Glass Working
- Generator for illuminating Gas
- Vacuum Systems
- High Vacuum Pumps
- Manifolds, Valves
- Electric Resistance Welders
- Spot, Press, Butt, Seam,
- Brazing
- Timers & Contractors
- Electrodes, Dies & Rolls,
- Tips, Job Spot Welding
- A.C. Arc Welders
- Electric Transformers
- 1/2 to 500 KVA
- all types and sizes
- Laboratory & Student Units
- Lamp & Radio Tubes
- Watch Crystal Machines

We make the largest and most complete assortment of Gas-Air-Oxy Burners for the Electronic Tube, Neon Sign, Hot and Cold Cathode Industry.

Order Direct from
**EISLER ENGINEERING CO.,
Inc.**
Newark 3, N. J., U.S.A.



Laboratory & Factory

**HIGH-FREQUENCY
ANTENNA ENGINEERING
AND KNOW HOW**

• 18 years of pioneering work in AM, FM, TV and radar antenna design and production rolled into one source of engineering and production know-how. Field and laboratory facilities with no equal in the antenna field, along with a modern, well-equipped factory with excellent transportation facilities make up the Taco organization in Sherburne, N. Y.

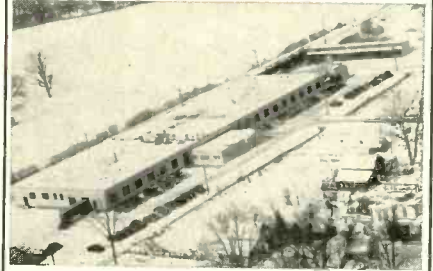

Taco has set the pace in TV antenna design specializing in the first all-band antennas and more recently in fringe-area types that are the acknowledged best-performers.

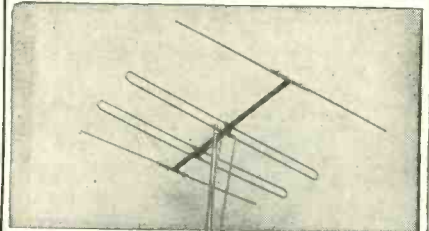

Newest Taco developments have been Master Antenna Distribution Systems that lend themselves to apartment house, store, or community installations.

Extensive experience in furnishing antennas and associated equipment for the armed forces during World War II, as well as the present rearmament program is reflected in the efficiency of the Taco Special Contracts Division.



**SUBMIT YOUR ANTENNA
PROBLEMS FOR DEVELOPMENT
AND PRODUCTION IN QUANTITY**

TECHNICAL APPLIANCE CORP.
SHERBURNE
N. Y.

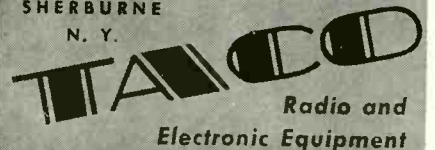

In Canada: Stromberg-Carlson Co., Ltd., Toronto 4, Ont.

When Precision Counts

You can count on THOR

Thor industrial ceramics are as machine workable as metal. Because of higher firing, their greater density permits close-tolerance precision production plus extreme hardness (crush resistance factor of 100,000 lbs. p.s.i.). Write today for specific information and illustrated brochure.

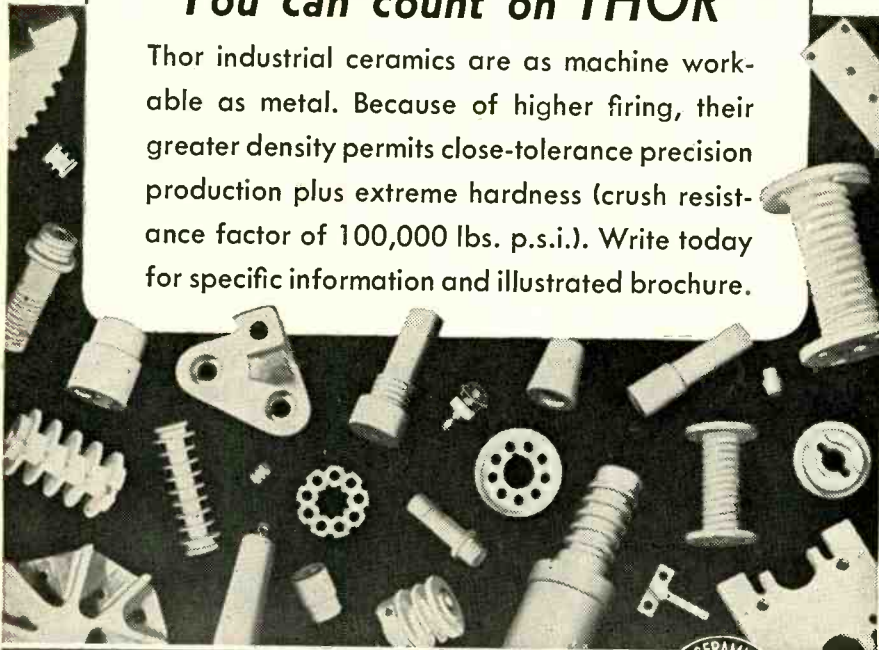

Thor Ceramics, Inc.

225 Belleville Avenue

Bloomfield, New Jersey



THIS IS THE

ONE BOOK

THE ONLY ONE OF ITS KIND

In which design engineers and purchasing agents will find a complete, accurate, and up-to-date list of the manufacturers of all types of electronic and allied products... components and complete equipment.

Keep it handy for ready reference throughout the year.

When buying, or requesting product information be sure to mention...

electronics BUYERS' GUIDE

rpc

RESISTORS

CONDENSED DATA

- HIGH VOLTAGE
- HIGH MEGOHM
- HIGH FREQUENCY
- WIRE WOUND PRECISION

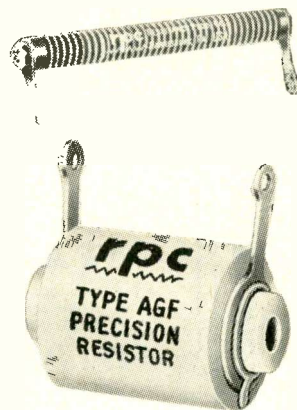

STYLE	TYPE	WATTS Max. (com- mer- cial)	VOLTS Max.	DIMENSIONS		RESISTANCE		
				Length	Diam- eter	Min.	Max. Megohms	
								Inches
WIREWOUND PRECISION RESISTORS % Tolerances 1, 1/2, 1/4, 1/10, 1/20, 1/50	* AFB*	0.5	125	15/32	9/6	0.1 Ohm	0.75	
	AGC*	0.5	250	5/8	5/8	0.1 Ohm	2	
	AGF*	1.0	500	1	5/8	0.1 Ohm	4	
	AJS*	1.0	500	1-9/32	3/4	0.2 Ohm	5	
	ALP*	2.0	750	2-1/32	7/8	0.5 Ohm	7.5	
	CAF*	0.5	250	3/4	1/4	1.0 Ohm	0.4	
HIGH VOLTAGE RESISTORS % Tolerances 15, 10, 5, 3 Matched Pairs 2%	BBF	1	3500	1	5/16	.05 Meg.	10,000	
	BBM	2	7500	1-3/4	5/16	.10 Meg.	25,000	
	BBR	3	15,000	3	5/16	.20 Meg.	25,000	
	BBV	5	30,000	5-1/2	5/16	.40 Meg.	25,000	
	BFQ	4	15,000	2-1/2	9/16	.20 Meg.	25,000	
	BFT	6	25,000	4	9/16	.40 Meg.	25,000	
	BFW	10	40,000	6-1/2	9/16	.70 Meg.	25,000	
	Type T — 20% Only	DPW	20	35,000	6-1/2	1-1/8	1 Meg.	50,000
	Type B and T — Lugs Only	DPX	30	65,000	10-1/2	1-1/8	2 Meg.	50,000
		DVY	50	90,000	14-1/2	1-1/2	4 Meg.	100,000
DZW		30	40,000	6-1/2	2	3 Meg.	35,000	
DZZ		90	125,000	18-1/2	2	7.5 Meg.	100,000	
Type D — Bands and Ferrules	TBR	2	15,000	3	5/16	1 Meg.	10	
	TFQ	3	20,000	2-1/2	9/16	1 Meg.	10	
HIGH MEGOHM RESISTORS % Tolerances 10, 5	HBF	1	3500	1	11/32	10 Meg.	2 Million	
	HBM	2	7500	1-3/4	11/32	10 Meg.	10 Million	
	HBR	3	15,000	3	11/32	10 Meg.	50 Million	
HIGH FREQUENCY RESISTORS % Tolerances 20, 15, 10, 5	FAC	1/4	250	9/16	0.10	30 Ohms	10	
	FBF	1	375	1	5/16	20 Ohms	25	
	FBM	2	750	1-3/4	5/16	35 Ohms	50	
	FBR	3	1400	3	5/16	65 Ohms	100	
	FBV	5	2600	5-1/2	5/16	120 Ohms	100	
	Type F — Lugs Only	FFQ	4	1100	2-1/2	9/16	30 Ohms	50
		FFT	6	1900	4	9/16	50 Ohms	75
		FFW	10	3100	6-1/2	9/16	80 Ohms	100
	Type FAC Axial Leads	GPW	20	2750	6-1/2	1-1/8	35 Ohms	50
		GPX	30	4750	10-1/2	1-1/8	60 Ohms	100
Type G — Bands and Ferrules	GVY	50	6750	14-1/2	1-1/2	65 Ohms	100	
	GZW	30	3000	6-1/2	2	25 Ohms	35	
	GZZ	90	8500	18-1/2	2	60 Ohms	100	

* Equiv. JAN TYPE-AFB (RB-10), AGF (RB-12), ALP (RB-14)
AGC (RB-11), AJS (RB-13), CAF (RB-51)

rpc

RESISTANCE PRODUCTS CO.

714 RACE ST., HARRISBURG 2, PA. • PHONE 2-4245



COMPOUNDS

FOR

IMPREGNATING

- radio coils • transformer coils
- ignition coils • wire coverings
- paper tubes and forms • porous ceramics

SEALING

- condensers • batteries • switch
- base terminals • socket terminals
- light fixtures

DIPPING

- coils • transformers • condensers

POTTING

- radio transformers • light units
- loading coils • condensers

BIWAX Compounds are scientifically prepared from waxes, resins, asphalts, pitches, oils, and minerals for specific applications.

BIWAX is available in a wide range of melting points and hardnesses. Special potting compounds are heat conducting and crack resistant at extremely low temperatures.

We will furnish—on request—samples, specific data, and recommendations. Let us give you complete details—write!

BIWAX CORPORATION

3445 HOWARD STREET

SKOKIE, ILLINOIS

OhmWeve RESISTORS

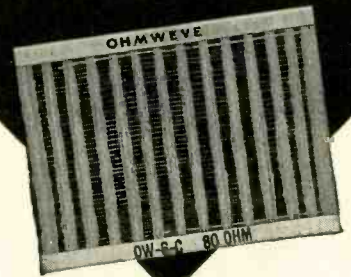

NEW non-inductive resistors

50% less resistance variation with frequency and 50% less inductance than conventional woven resistors.

- for Rf Loads
- for Pulse Work
- for Hydrogen Thyatron Loads

Also other types for crystal oven heaters, etc.

Write for Bulletin



THE OHMWEVE COMPANY
43 DARCY ST., WEST HARTFORD 6, CONN.

GRAYHILL SWITCHES and RELAY



**GRAYHILL NO. 2000
SNAP ACTION SWITCHES**
Momentary contact, single pole, single throw type. Audible click when switch is activated. Approx. .050" pre-travel, virtually no over-travel. Contact gap .015". Single hole panel mounting. Two hex nuts. Bushings 15/32"—32 thread.

NO. 2201 NORMALLY OPEN
NO. 2202 NORMALLY CLOSED
Rating—10 Amps., 115 volts AC
1 Amp., 115 volts DC



**GRAYHILL NO. 4000
PUSH BUTTON SWITCH**
Non-snap action. Momentary contact, single pole, single throw type. Over-travel approx. .046", pre-travel .078". Single hole panel mounting. Bushing (15/32"—32 thread) and hex nut assembly.

NO. 4001 NORMALLY OPEN
NO. 4002 NORMALLY CLOSED
Rating—1/2 Amp., 115 volts, AC

Grayhill No. 3000 ROTARY TAP SWITCH



For special-circuit-combination applications. 1 to 12 decks. 2 to 11 contacts per deck. Rated at 20 Amps., 115 Volts AC.

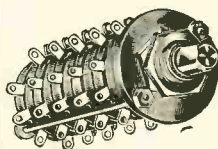

GRAYHILL NO. 5000 MINIATURE ROTARY TAP SWITCH

SHORTING (make before break) and NON-SHORTING (break before make). From 1 to 10 decks. Accommodates up to 10 contact positions on each deck. With 10 positions, switch rotates 360° in either direction. When 9 or less positions—stops permit rotation only through required positions. Nickel-plated brass rivet contacts—silver-plated rotor blade. Exterior metal parts are cadmium-plated. Bushing, 3/8"—32 thread. Behind panel length from 27/64" (1 deck) to 4 1/2" (10 decks).

Rated to break—1 Amp., 115 Volts AC
to carry—5 Amps., 115 Volts AC

Grayhill PLUG-IN RELAY

No wires. Plug connectors for rapid insertion. Contact arrangements—SPST, SPDT, DPST, DPDT. Range, 6-230 Volts AC or DC.



Silver contacts rated at 10 Amps. per pole on a resistance load.

Grayhill

4536 W. Madison Street
Chicago 24, Illinois

this BOOK 11th year
now in its

has earned industry-wide acceptance as the only complete and accurate source of buying information for all types of electronic and allied products components and complete equipment

In Addition, this year . . .



tells who has what in production or available in a reasonable time and unrestricted for general industrial use.

electronics BUYERS' GUIDE

Please mention this book when buying or inquiring from it.

MICO

Precision Apparatus
ENGRAVERS



FEATURES

1. Four reduction ratios, 1.5:1, 2:1, 3:1, and 4:1.
2. Ball-bearing micrometer spindle.
3. Absolute accuracy in three-dimensional reproduction.
4. Copy and work right-side-up; always in direct view of operator.
5. Many attachments available to increase versatility.
6. Wide selection of type.

Catalogue on request

UHF COAXIAL WAVEMETERS



2-75
Centimeter
Range

- MODEL 433 20 to 75 Centimeters
 MODEL 501 4 to 20 Centimeters
 MODEL 402A 2 to 10 Centimeters
 MODEL 402B 2 to 10 centimeters (Reaction Type)

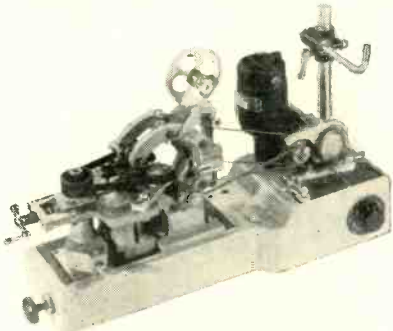

TOROID COIL WINDERS

Wide-range, laboratory-type machines available for winding samples and small production runs of toroid coils. Production machines built to meet specific requirements.

MICO INSTRUMENT CO.
77 Trowbridge St., Cambridge, Mass.

THE ACCEPTED STANDARD HEYCO STRAIN RELIEF BUSHINGS



C. S. A.

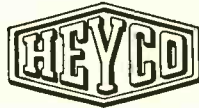

Save time—reduce costs—increase product life. Securely anchor wires to chassis without injury. Heycos absorb push, pull and torque. Eleven sizes clock wire to S-10/3 cable.

Specification Sheet on Request

**HEYMAN
MANUFACTURING CO.**
KENILWORTH 2, N. J.

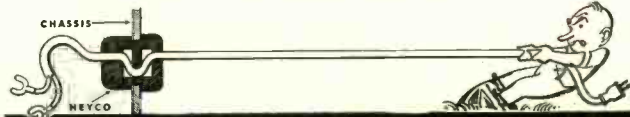

HEYCO ELIMINATES STRAIN ON TERMINALS!

TAPE WOUND CORES

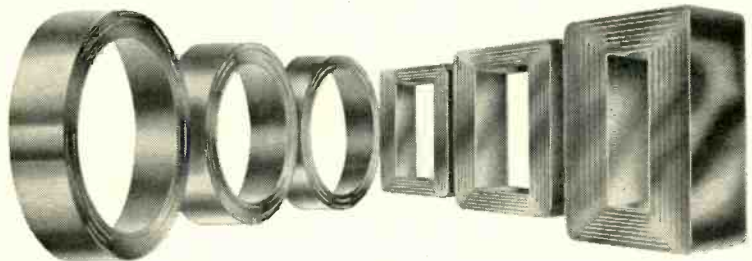

Custom made in size and shape . . . of all high permeability magnetic materials, including ORTHONOL* the new rectangular loop material . . . cased in protective plastic boxes . . . annealed in hydrogen by our exclusive techniques . . . but competitively priced.

ULTRA-THIN CORES—in tapes of less than one mil thickness.
Ask for samples wound to your specification.

*A DEVELOPMENT OF THE NAVAL ORDNANCE LABORATORY

MAGNETICS, INC.

Specializing in High Permeability Magnetics

WRITE FOR LITERATURE

BUTLER, PENNSYLVANIA

PHONE 54-145

MOLDED PLASTIC COIL FORMS AND BOBBINS

for

- DEFLECTION YOKES • HORIZONTAL
- OUTPUT TRANSFORMERS • SPEAKERS
- HEADSETS • SOLENOIDS • MOTORS
- RELAYS • VIBRATORS • TRANSFORMERS
- FOCUS COIL AND EVERY COIL REQUIREMENT

TESTED AND APPROVED BY LEADING ELECTRONIC,
RADIO AND TELEVISION MANUFACTURERS

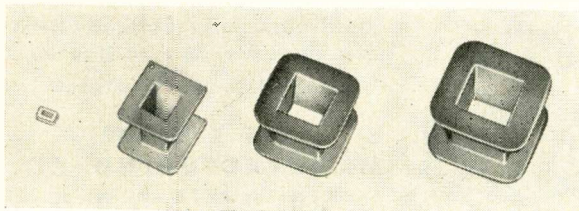

Eliminates electrolysis

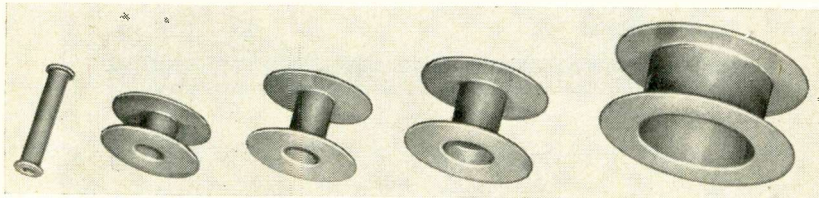

Higher insulating characteristics

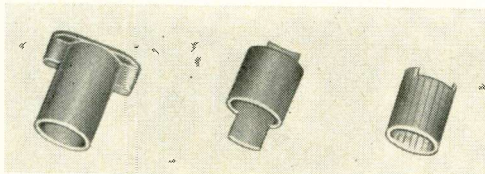

Accurate construction reduces winding costs

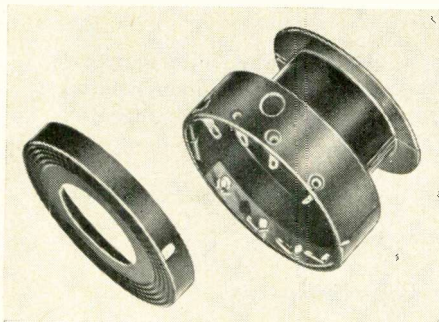

Deflection Yoke Cases & Cover

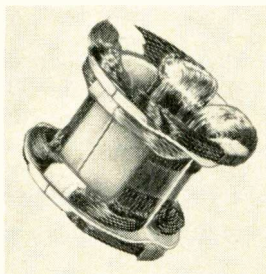

Insulating Shell between vertical and horizontal Coils

IMMEDIATE DELIVERY FROM STOCK ON MANY SIZES
Write, wire or telephone for samples. Send us prints or
samples on stock size requirements. No mold cost.

American Molded Products Co.

1646 N. HONORE STREET

TELEPHONE: AR 6-3235

CHICAGO 22, ILLINOIS

Hold on / to this book

It will be
June 1952
before another
edition is published

IT IS THE MOST COMPLETE,
AUTHORITATIVE AND UP-TO-DATE
DIRECTORY OF ELECTRONIC AND
ALLIED PRODUCTS AVAILABLE.

It gives you the manu-
facturers of each of
more than fourteen
hundred electronic
and allied products.



... gives you information
as to where they are in pro-
duction or available in a
reasonable time and unre-
stricted for general indus-
trial use.

1951-1952

electronics BUYERS' GUIDE

Please mention this book when
buying or inquiring from it.

QUICK EASY
ACCURATE

**SPECTRUM
AND WAVEFORM
ANALYSIS
WITH
PANORAMIC
INSTRUMENTS**



Audio Wave
Analysis
in 1 Second

Panoramic Sonic Analyzer, Model AP-1
Automatically measures frequency and magnitude of wave components for high speed analysis of vibrations, harmonics, noises, acoustics, and intermodulation under static or dynamic conditions.
*Optimum Frequency Resolution
Range 40—20,000 c.p.s.*

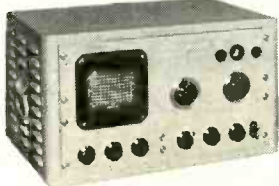

High
Speed
Spectrum
Analysis

Panoramic Ultrasonic Analyzer, Model SB-7
Continuously variable scanning width, 200KC to zero, for channel monitoring, telemetering and investigation of ultrasonic waveform content. Allows overall observation of wide bands; 500 c.p.s. resolution for highly detailed examination of selected narrow bands.
*2KC-300KC, Linear Scale
1mV-50V Input Voltage*



Maximum
Resolution
of RF Spectrum

Panadaptor, SA-8 • Panalyzer SB-8
Variable resolution; variable scanning width. Synchronous and non-synchronous scanning; variable scanning rates. Linear and Log Amplitude scale. Long persistence display. Three types of instruments, maximum scanning widths of 200 KC, 1 MC and 10 MC.
Resolutions down to 100 C.P.S. available

Write for complete
specifications and prices



8 South Second Ave., Mount Vernon, N. Y.

To: **PRIME CONTRACTORS**
and **SUB CONTRACTORS**
on **GOVERNMENT WORK . . .**

Invitation
TO RECEIVE A
PRODUCTION SAMPLE
Transformer
BUILT TO YOUR SPECIFICATIONS

this is our offer to you . . .

WE WILL, without cost or any obligation whatever, design a **PRODUCTION SAMPLE** transformer (hermetically sealed to JAN-T-27 or MIL-T-27 Government specifications), or open type construction, if unit is to be used for awarded prime or sub-contract work. Our approach stresses quality of product, efficiency in service and an alertness to techniques that discard the old for more functional methods.

James M. Blackledge

PRESIDENT

TYPICAL **GRACOIL** PRODUCTS



INPUT TRANSFORMER



REACTOR



POWER
TRANSFORMER



PLATE TRANSFORMER SHOWN (1 to r)
WITH POWER, FILAMENT, CHOKE, DRIVER,
FILAMENT AND SMALLER PLATE TRANSFORMERS
ALL BUILT TO MIL-T-27 SPECIFICATIONS.



POWER
TRANSFORMER
BUILT TO MIL-T-27
SPECIFICATIONS

**SEND YOUR
B/P
SPECIFICATIONS**

GRAMER

TRANSFORMER

CORPORATION
2734 N. PULASKI ROAD • CHICAGO 39, ILLINOIS

TUNGSTEN RIBBON

Sizes: Widths from .004" up to .125"
Thicknesses from .040" down to .001"

Down to .0008" at widths up to .060"
Down to .0005" at widths up to .015"
Down to .0002" at widths up to .006"
Tungsten ribbon made to above sizes is manufactured from round, ductile wire.
CHEMICAL PURITY: 99.9% pure
FINISH: Roll finish—black or cleaned
CAMBER: Approximately 1/16" in 2' lengths
EDGES: Slightly rounded and smooth

TOLERANCES:

Thicknesses:	.0005" to .001" ± .00005"
	.002" ± .0001"
	.003" ± .0002"
	.004" ± .00015"
	.005" to .006" ± .00025"
	.007" to .010" ± .00035"
	.011" to .030" ± .0005"
	.031" to .040" ± .001"
Widths:	.006" to 0.10" ± .0005"
	.011" to .020" ± .001"
	.021" to .030" ± .0015"
	.031" to .060" ± .002"
	.061" to .093" ± .003"
	.100" to .125" ± .005"

Supplied to mg. wgt.—if required.

STRIP

Widths up to 1½" with thickness down to .001" in random lengths 6" and up. This is rolled from heavy strip.

THORIATED

Widths up to .125" down to .001" thick
Widths up to ½" down to .002" thick
Wgt. per Sq. In. at .001" Thickness is 0.316 Grams

TANTALUM RIBBONS are available in sizes and tolerances similar to those shown for molybdenum. STRIP .001" down to .0005" at widths up to 2".

INQUIRIES ON FORMED PIECES MADE OF TUNGSTEN OR MOLYBDENUM RIBBON AND STRIP, OR THORIATED TUNGSTEN WILL RECEIVE PROMPT ATTENTION.

H. CROSS CO.

15 BEEKMAN STREET
NEW YORK 38, N. Y.

MOLYBDENUM RIBBON

Sizes: Widths from .006" up to .250"
Thicknesses from .060" down to .0006"

Molybdenum Ribbon made to above sizes is manufactured from round, ductile wire.

CHEMICAL PURITY: 99.9% pure

FINISH: Roll polished finish, cleaned

CAMBER: Approximately 1/16 in 2' lengths

EDGES: Slightly rounded and smooth

TOLERANCES:

Thicknesses:	.0006" to .001" ± .00004"
	.0011" to .010" ± .00025"
	.011" to .030" ± .0003"
	.031" to .060" ± .0005"
Widths:	.006" to .010" ± .0005"
	.011" to .020" ± .001"
	.021" to .030" ± .0015"
	.031" to .090" ± .002"
	.091" to .125" ± .003"
	.126" to .160" ± .0035"
	.161" to .250" ± .005"

Supplied to mg. wgt.—if required.

STRIP

Widths up to 2" with thicknesses down to .001" in random lengths 6" and up. This is rolled from heavy strip.

Wgt. per Sq. In. at .001" Thickness is 0.167 Grams

New

High Temperature DEE SOLDER POT

ADJUSTABLE THERMOSTAT

TIN "FORMEX" WIRES WITHOUT STRIPPING



Temperature Range

Model 11 800° to 1200° F.

Model 12 700° to 1000° F.

Model 16 400° to 600° F.

\$24.50 each

f.o.b. Chicago

- ADJUSTABLE THERMOSTAT—maintains the one optimum temperature for any job in the temperature range.
- DETACHABLE SPLASH GUARD—easy salvage of solder. Receptacle for dross. Clean area around the pot.
- TAPERED CAST IRON CRUCIBLE—outer sides taper down 45° for easy accessibility to solder.
- HEATING ELEMENT EMBEDDED IN PORCELAIN—encircles crucible. Two windings. Long life.
- LONG LIFE THERMOSTAT—non bi-metal. Operated at less than 20% of capacity.

ORDER TODAY OR WRITE

DEE ELECTRIC COMPANY

MELTING POTS

1101 N. Paulina St. Chicago 22, Ill.

VSWR and RF WATTMETER

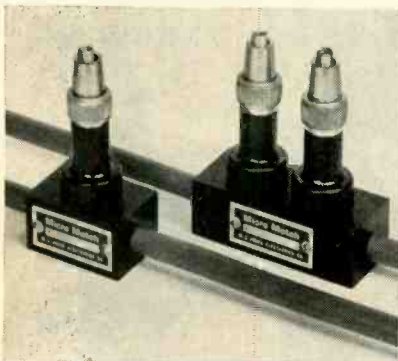

MM 570 Series



MM 700 Series

MicroMatch models are available as components for incorporating directly into the transmitters or as complete independent test equipments for measuring RF power and VSWR from 500 KCS. to over 2000 MCS., and power levels from 10 milliwatts to 50,000 watts. They are now being used by Government Agencies and Industry as laboratory test equipment; peak power monitors for TV video transmitters; commercial FM stations; fixed and mobile police, aircraft, utilities, etc., transmitters.

Write for complete descriptive literature on

The MicroMatch
Dummy Load Resistors

RF Absorption Type Wattmeters
Thermistor Bridges

Station Guardian for Transmitter Protection

M. C. JONES ELECTRONICS COMPANY, BRISTOL, CONN.

Distributed outside of U. S. A. by RCA International Div. N. Y., N. Y.

This Year
The
BUYERS' GUIDE
inaugurates
A
Where-to-find-it Guide
to the
1930-1939
electronics'
editorial
contents

A cumulative editorial
index to the first ten
years of **ELECTRONICS**
Pages C-1 to C-36

Next ten years in next
year's **GUIDE.**



Terminals FOR HERMETIC SEALING

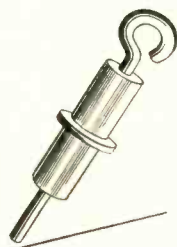

• M.C.A. Terminals meet all classes of the sealed components specifications, JAN-T-27.

• M.C.A. Terminals are made from the exceptionally stable thermoplastic, KEL-F... a high polymer of trifluorochloroethylene which is chemically inert, unaffected by high humidity and tropical exposure, has zero water absorption, and has high resistance to electricity and thermal shock.

• M.C.A. Terminals are designed for use wherever compactness, highest resistance to heat and cold, imperviousness to moisture, acids, oils, etc. are paramount.

• Available in a variety of sizes with single or multiple leads of standard or special design to customer's specifications.

Your sealed product is more compact and remains sealed under the most severe conditions when you use M.C.A. Terminals.

Let us know your problem — write for full information.



**MOLDING CORPORATION
OF AMERICA**
Office: 58 WEYBOSSET ST., PROVIDENCE, R. I.
Factory: 40 CHURCH ST., PAWTUCKET, R. I.

MALCO... LUGS and TERMINALS CORONA RINGS

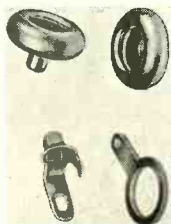

• Standard to the Television and Radio Industries

• Why not write us about your problems?

Perhaps our engineering department can help you as they have helped others

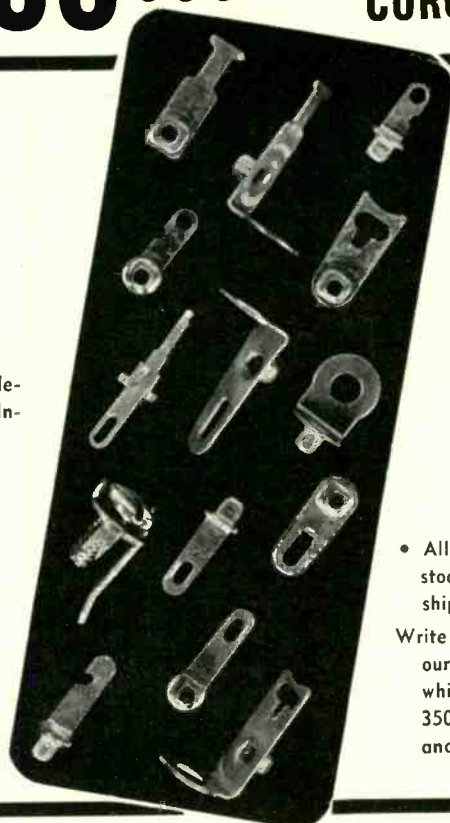

• Designed and held to very close tolerances to meet individual requirements

• All standard lugs are stocked for immediate shipment

Write for your copy of our parts catalogue which illustrates over 350 Lugs, Terminals, and Brackets

MALCO TOOL & MANUFACTURING COMPANY
4025 West Lake Street Chicago 24, Illinois

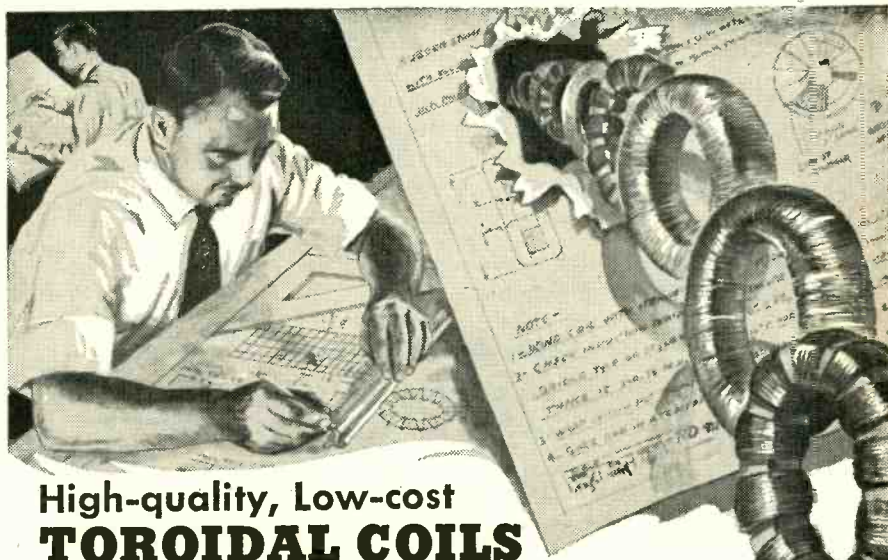

High-quality, Low-cost TOROIDAL COILS

Universal-developed coil-winding machines produce a better toroidal coil, custom-built to your blueprint specifications, at considerably lower unit cost! Wound on any type cores (any I.D. to 3/8"), in any size wire, Universal toroidal coils are perfectly uniform and fully insulated. Send your blueprint specifications today, and let us quote the lower cost of better Universal toroidal coils on your next order.

Address:



Toroidal Coil Division
Universal Manufacturing Company, Inc.
404 Hillside Avenue Hillside, N. J.

**STOP MOISTURE
INFILTRATION**

INSULATE WITH INSL-X

**INHIBIT
FUNGUS ATTACK**

A COATING FOR EVERY APPLICATION

A partial list of INSL-X product groupings is given below: literature and samples gladly furnished on request.

FUNGICIDAL COATINGS that prevent moisture infiltration and effectively inhibit organic attack. All of the coatings are easy to apply, non corrosive, biologically effective, and non toxic to humans. INSL-X fungicidal coatings meet rigid Government specifications.

ARC RESISTING COATINGS that in addition to arc resistance, possess very high dielectric strength, water resistance, and the ability to withstand high intermittent temperature up to 400° F. or prolonged temperature up to 300° F.

COIL COATINGS that are rapid drying, have high dielectric strength and are chemically neutral to fine wire. They are thermally stable, and suitable for long lived applications. Outstanding anti-corona properties are highly desirable for *TELEVISION INSULATION*.

TOOL INSULATION. A tough, high dielectric acid resisting, waterproofing compound designed for the insulating of tools. It may be reinforced and built up to practically any dielectric and mechanical strength by the use of glass, asbestos or fabric sleeving or tape. This method provides a foundation capable of withstanding severe impact and abrasion.

INSULATING VARNISHES. A series of air drying and baking materials designed for various applications.

INSL-X AGENTS

NEW YORK
B. B. Taylor
150 Broadway
New York, N. Y.

CALIFORNIA
J. C. Van Groos
1436 North Serrano Ave.
Hollywood 27, Cal.

ILLINOIS
R. A. Stemm
21 East Van Buren St.
Chicago 5, Ill.

Robert P. Kennedy
182 Mayflower Drive
Rochester 18, N. Y.

PENNSYLVANIA
Dan J. Connor Co.
1036 Broad St. Sta.
Philadelphia 7, Pa.

MASSACHUSETTS
Holliday Hathaway Sales Co.
238 Main Street
Cambridge 42, Mass.

OKLAHOMA
C. B. Anderson Co.
712 Oil Capital Bldg.
Tulsa 3, Oklahoma

Chas. A. Englert
1516 Grandin Ave.
Pittsburgh 16, Pa.

TEXAS
H. W. Zuch
402 Nalle Bldg.
Austin, Texas

CONNECTICUT
R. E. Powell
Box 797
Canaan, Conn.

MICHIGAN
H. C. Sweet Co.
12085 Woodbine Ave.
Detroit 28, Mich.

J. E. Rogers
102 Thomas Bldg.
Dallas 1, Texas

THE INSL-X COMPANY • INC.

MANUFACTURING ENGINEERS OF INSULATING, FUNGICIDAL AND PROTECTIVE ELECTRICAL COATINGS

WATER STREET • OSSINING • NEW YORK

Want to know
about the...

AUGETRON

ECCLES-JORDAN CIRCUIT

KATHETRON TUBE

MEKAPION TUBE

PERMATRON

PETOSCOPE

SCHLIEREN METHOD

SCOPHONY

SEMAGRAPH

SIRUFER

SYNDEC

THEREMIN

TRATONIUM

VODER

or other early
electronic
developments?

You can find out about
them in the early issues
of **ELECTRONICS**.

The cumulative index to
ELECTRONICS' first decade,
pages C-1 to C-36
in this book, tells you
where to look.

COMMUNICATIONS TOWERS

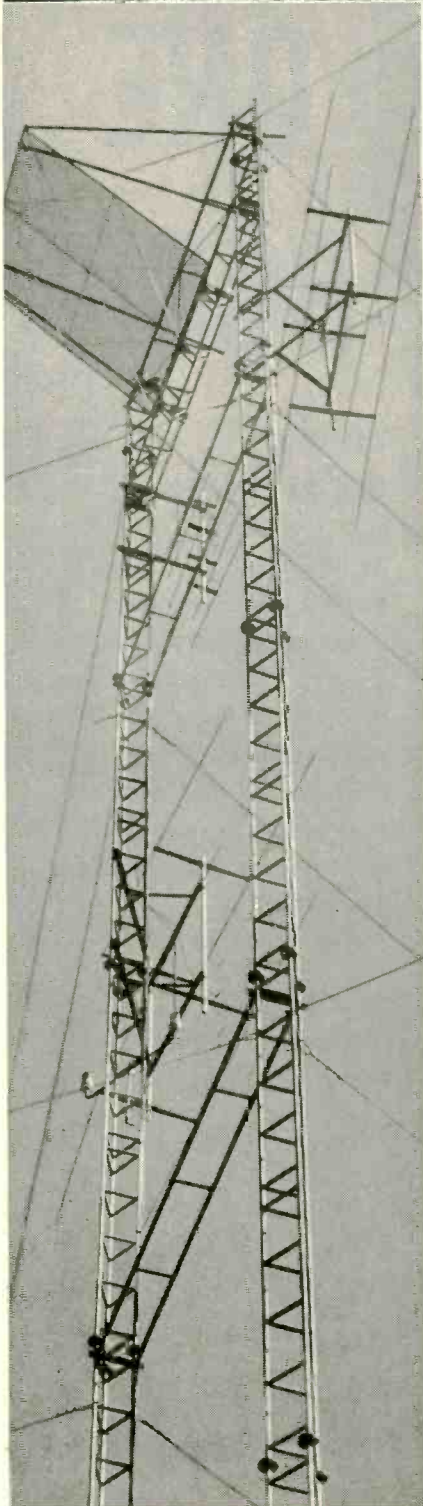

Towers
by

STAINLESS, INC.
NORTH WALES, PA.
PHONE: NORTH WALES 874

Finest for ELECTRONIC CONTROL

Phil-trol RELAYS

Phillips offers a complete selection of relays particularly suited for applications in the electronic field. Phil-trol Relays are engineered to the highest standards for quality, dependability and long life.

All Phil-trol Relays have "built-in" features which permit versatility in application. Units can be adapted as engineered parts to meet exact requirements.

Write for full information on these and other A-N approved Phil-trol relays.



Telephone
Type 2 QA



Power Relay
Type 27 QA



Power Relay
Type 33 AC



Miniature Telephone
Type 4 QA



Hermetically Sealed
Type 40015



Hermetically Sealed
Type 43005-1



Hermetically Sealed
Type 20366-1

Phil-trol ACTUATORS

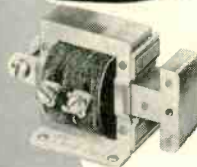

Laminated Frame



Solid Frame

Phil-trol Actuators are made for commercial and industrial applications to meet requirements for a small, compact solenoid that will develop unusual power. Exclusive Phil-trol design and engineering assure finest quality and greatest power. There is a complete line of Phil-trol Actuators for most requirements. Ask for details.

Send for

- ✓ Relay Catalog
- ✓ Relay Characteristics Sheet
- ✓ Actuator Catalog

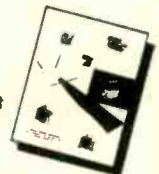

Phil-trol PRODUCTS

PHILLIPS CONTROL CORPORATION

84 W. JEFFERSON ST. JOLIET, ILL.

OFFICES IN PRINCIPAL CITIES

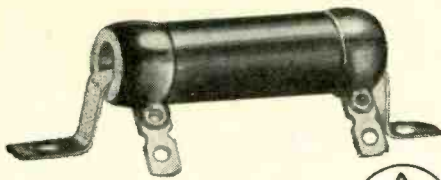

VITREOUS ENAMEL RESISTORS

The Cima Corp. manufactures a complete line of tested and approved vitreous enamel, tapped and ribbon-wound resistors. We also manufacture RF plate and power line chokes.



All types of standard and special vitreous enameled resistors available. All are wound on steatite cores. Copper terminals, solder coated for ease of soldering; resistance wire brazed to terminals. Vitreous enamel coated to dissipate heat. They are available in fixed, tapped and adjustable units with or without hardware mounting. Adjustable units supplied with screw driver type or bakelite knob adjustable terminals. Ranges from 5 w to 200 w. Special mountings, brackets and terminals to order. Tolerances plus or minus 10%—closer tolerances available. Many types can be furnished with pigtail leads.

Additional Precision CIMA PRODUCTS

Tapped Resistors . . .
Available in all sizes. Quotations furnished to your specifications.

Ribbon-Wound Resistors . . .
Heavy Duty Resistors for low resistance and high current and wattage.

Special Windings . . .
For heating elements and other special applications. Quotations upon request.

R.F. Plate Chokes . . .
Four types for amateur band meters: 5, 10 & 20, 20 & 40, 20-40-80-160. Micro-Henries, 5.4 to 220. .85 to 9. ohms.

Power Line Chokes . . .
Three types: 13.5, 14.0, 16.5 Micro-Henries. 0.15 to 0.045 DC ohms. 5-20 amps.

PRECISION RESISTORS



Accuracy—1% to 0.1%
Temperature Coefficient—0.002%/°C to 0.017%/°C
Full Moisture Protection
Non Inductive Winding
Full range of resistance values available

CIMA

CORP.

91 BOYLSTON ST.
JAMAICA PLAINS
BOSTON 30, MASS.

THIS IS THE

ONE BOOK

THE ONLY ONE OF ITS KIND

In which design engineers and purchasing agents will find a complete, accurate, and up-to-date list of the manufacturers of all types of electronic and allied products... components and complete equipment.

Keep it handy for ready reference throughout the year.

When buying, or requesting product information be sure to mention . . .

electronics BUYERS' GUIDE

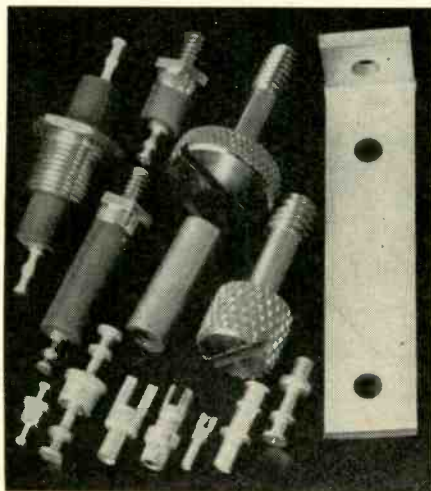
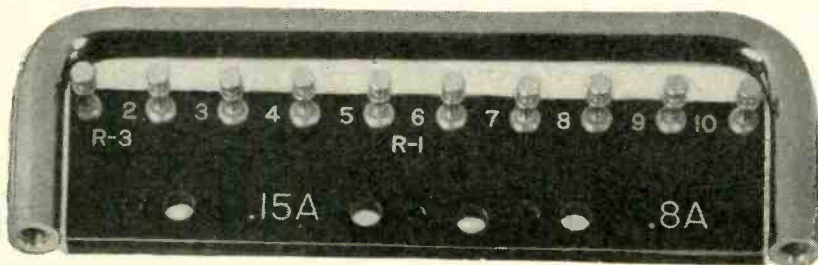

- A full line of terminal lugs, insulated terminals, and electronic hardware — handles, captive screws, spacers, brackets.
- Completely assembled terminal boards to meet all government specifications.
- Immediate delivery from stock or to order on all items.

CITATION PRODUCTS CO.

233 EAST 146th ST., NEW YORK 51, N.Y.
Telephone: MEIrose 5-4873

Complete Engineering and Production Service for Manufacturers

PLASTIC EMBEDMENT of CIRCUITS and COMPONENTS

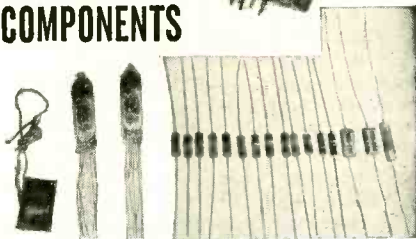

Illustrated above is an example of Emerson & Cuming Co., plastic embedment showing component parts embedded.

Manufacturers and development engineers bring us their ideas, problems or designs and we translate them into the finished product.

Emerson & Cuming Co., 4-point Service Program to the Electronic Industry

1. Preparation of sample embedments in our laboratories at a nominal charge.
2. Production of embedments at our plant on a contract basis.
3. Engineering service to use plastic techniques for producing superior electronic equipment and/or components.
4. Direct sale of embedment plastics developed and manufactured at our plant.

A few of the finished products are—

Hermetically sealed precision resistors, polyethylene embedded antennas, molded synchro windings, high voltage bleeder assembly, polystyrene embedment of microwave systems, solid plastic impregnated components, heavy plastic coated transformers, complete plastic encasement of undersea electronic system.

Write for more information, specifically mentioning the problem at hand.

Emerson & Cuming Co.

Engineers and Manufacturers

126 Massachusetts Avenue
Boston 15, Mass.



ENGINEERING PLASTICS
FOR ELECTRONICS PRODUCTION

TERMINAL EQUIPMENT

RANGE: Mark or space bias distortion 0 to 50%.

ACCURACY: ± 3%.

INPUT: 30 or 60 M.A. neutral or polar, 60 WPM teletype signal.

INPUT IMPEDANCE: 200 ohms.



TELETYPE DISTORTION INDICATOR Model 22

A portable unit that measures bias distortions. May be connected in any teletype circuit with teletype-writer printer without disturbing its operation.



DIPLEX RECEIVING KEYER or Regenerative Repeater

Type CA-1447

Double the Number of Teletype Messages on Any Circuit by Time Division

INPUT: 500-10,000 cps tone keyed with diplex signal ODBM to -40DBM level. Compression amplifier permits uniform operation with varying line levels with or without filters in line. Input distortion may exceed 40%. Manual adjustment will allow unit to tolerate over 50% distortion.

OUTPUT: Two simplex neutral outputs each in form of relay contacts. Output distortion—less than 2%. **POWER:** 105-130 V., 80 watts, 50-60 cps. **CONSTRUCTION:** Rack panel 19" long x 8-3/4" high x 10 1/4" deep. Vertical chassis with tubes in rear. All parts available from front door.

TELETYPE TONE KEYER

The Model TTK-10 Tone Keyer provides keyed tone at its output when keyed DC neutral or polar circuit is connected to the input. Keying speeds of 500 wpm are possible with unit. Only vacuum tube keying is employed.

Specifications INPUT: 20 to 60 ma. neutral operation with remote or local (from the unit) battery; either side of line may be grounded. 30 ma polar operation with remote battery; either side of line or center point may be grounded.

OUTPUT: Level -15 DBM to +15 DBM. Tone frequency 400 to 5000 cps. Keying speed to 180 dot cycles. Output tone wave form—less than 5% distortion. Output impedance—600 ohms balanced or unbalanced to ground. Bias distortions of ± 20% at input of unit may be corrected to less than 2% at output. Line voltage variations of ± 10% will not affect local battery current by more than 1% or output distortion by more than 2%. Metering is provided in unit to measure input line current and output tone level.

POWER REQUIREMENTS: 115 or 230 VAC, 50 to 60 cps.—90 watts.

TUBES: 1—Type 6Y6-G 1—Type 12AT7
1—Type 5R4-GY 1—Type 6AU6
1—Type 6X4 1—Type OB2
4—Type 12AU7 1—Type OB3

Physical: 19" x 8 3/4" panel for rack mounting. Chassis extends 12" behind panel. All operating controls available from front panel. Weight—25 lbs. Construction and components—to Govt. specifications.

TELETYPE TONE DEMODULATOR

The Model TTD-10 Teletype Tone Demodulator is designed to receive a keyed tone signal and supply either neutral or polar output. Vacuum tube keying circuits use throughout. Output current is regulated to 1% for line voltage variations of ± 10%. Keying speeds of up to 500 words per minute are possible with the unit.

Specifications INPUT: Keyed tone, 300 to 10,000 cps. Line level -25 DBM to +10 DBM. Balanced or unbalanced

Write us on your letterhead for a descriptive bulletin, including information and prices on standard units, together with helpful design data.



C. G. S. LABORATORIES, INC.
393 LUDLOW ST. STAMFORD, CONN.

600 ohm. Keying speed—180 dot cycles.
OUTPUT: Neutral, 20 to 60 ma., 120 v., either side of line may be grounded or open; battery supplied from unit. Neutral, 20 to 60 ma., either side of line may be grounded or open; remote battery. Polar, 20 to 30 ma., 120 v., either side of line may be grounded or open; battery supplied from unit. Adjustment is provided so that input bias distortions of ± 20% may be corrected to less than 2% at output. Input level variations of ± 5 DBM will cause less than 2% change in output bias distortion. (For square wave keying).
POWER REQUIREMENTS: 115 v. or 230 v. 50-60 cycle AC—130 watts.

TUBES: 4—Type 6Y6-G 1—Type 6AU6
1—Type 5R4-GY 1—Type 6X4
3—Type 12AU7 2—Type OB2
2—Type 6AL5 1—Type OAS

Physical: 19" x 8 3/4" panel for rack mounting. Chassis extends 12" behind panel. All operating controls available from front panel. Meter provided for input level and output current measurements. Weight—30 lbs. Construction and components—to Govt. regulations.

* Model TTD-11 Teletype Tone Demodulator is available with a compression amplifier instead of a clipping amplifier and will provide an output with bias variations under 5% for ± 10 DB line level variations with standard filters in tone line.

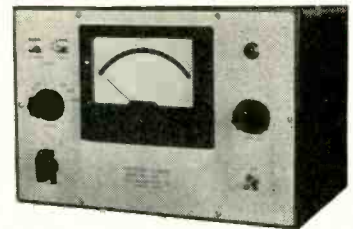

PEAK PULSE VOLTMETER Model 80A

VOLT RANGES: 0-10, 0-50, 0-100, 0-500, 0-1000, 0-5000 volts.

PULSE WIDTH: 0.25 microseconds to 50 milliseconds.

REPETITION RATES: 10 to 20,000 pps.

ACCURACY: ± 3% of full scale.

INPUT IMPEDANCE: 200,000 ohms.

An automatic slideback instrument which secures rapid and accurate readings at pulse widths of .25 microseconds and at 10 pps. Controls include on-off switch, range selector switch, input polarity switch, zero-set control, and peak to peak switch.



INCREDUCTOR

Newest Component in the Electronic Field

INCREDUCTOR is trademark of new type variable inductor that is:

- electrically controlled—no moving parts.
- variable over useful inductance range of 100 to 1—or 200 to 1—or even more in some applications.
- low in loss—maintains high Q even at megacycles.
- controlled with minimal power, compact and light in weight.
- result of years of intensive research by C. G. S. engineers.

These valuable characteristics of the INCREDUCTOR are attained by use of separate control and signal windings, specially arranged on ceramic core having unusual magnetic properties.

Alternating or direct current variations, through the low power control winding, produce corresponding variations in inductance of INCREDUCTOR signal winding.

The standard line of C. G. S. INCREDUCTORS now available includes units with wide range of starting inductances and frequencies. For applications in which standard C. G. S. INCREDUCTORS will not provide requisite characteristics, C. G. S. will design and produce INCREDUCTORS to meet your specific requirements.

PATTON-MAC GUYER

PROBLEMS MASTERED

SMALL METAL STAMPINGS

In Accordance With Your Prints

Extensive modern plant, complete equipment, engineering and toolmaking skill for producing your stamped metal parts accurately, economically, promptly. Moderate die charges. Facilities for large volume production. We welcome stamping problems.

TERMINALS for ELECTRIC WIRES

Specialists in the terminal field, we have dies to produce over 400 different kinds of separate terminals. Every modern facility to meet your standard or special requirements.

PATTON-MacGUYER COMPANY
Edgewood Station Providence 5, R.I.



RUGGED • ATTRACTIVE • MODERATELY PRICED

TYPES—ammeters, milliammeters, voltmeters, AC and DC. Resistance meters.

ACCURACY—well within 5%. AC meters are double-vane, repulsion type; DC meters are polarized-vane solenoid type.

CASES—three basic styles, round or rectangular, all requiring 2-5/32" hole. Zero adjuster available on some D.C. models. Also pocket types.

DIALS—all metal—age and moisture resistant. Special calibrations, one to five colors.

USES—plate current and voltage readings; battery charging and emergency lighting units; TV antenna rotator indicators; voltage regulators; polarity indicators; plating sets, etc.

STOCKED—by leading electronics parts distributors. Ask for Bulletin F-53-SH.

SHURITE METERS

35-A Hamilton St. • New Haven 8, Conn.

HIGH VOLTAGE POWER Supplies

Up to 250,000 volts

A.C. or RECTIFIED and FILTERED

SPECIAL INDUSTRIAL X RAY EQUIPMENT
FOR INSPECTION • GAGING • ANALYSIS . . .

We Will Design, Engineer and Manufacture to your requirements.
SEND FOR BULLETIN 131

BRACKE-SIEB X RAY COMPANY INC.

293 B THIRD AVENUE

NEW YORK 10, N. Y.

for Results



Mc GRAW-HILL
DIRECT MAIL LIST SERVICE

If You Are Having Difficulty Maintaining Your Mailing Lists...

Probably no other organization is as well equipped as McGraw-Hill to solve the complicated problem of list maintenance during this period of unparalleled change in industrial personnel.

McGraw-Hill Mailing Lists cover most major industries. They are compiled from exclusive sources, and are based on hundreds of thousands of mail questionnaires and the reports of a nation-wide field staff. All names are guaranteed accurate within 2%.

When planning your direct mail advertising and sales promotion, consider this unique and economical service in relation to your product. Details on request.

McGraw-Hill Publishing Co., Inc.

DIRECT MAIL DIVISION

330 West 42nd Street

New York, 18, New York

a plus feature

Immediately following the

Product Listings in the

DIRECTORY SECTION

of this Issue

is a list of more than

2500

TRADE NAMES

of electronic and allied products.

They are intended for

your use in determining

the manufacturer's name

when only

a trade name is known.

Hold on / to this book

It will be
June 1952
before another
edition is published

IT IS THE MOST COMPLETE,
AUTHORITATIVE AND UP-TO-DATE
DIRECTORY OF ELECTRONIC AND
ALLIED PRODUCTS AVAILABLE.

It gives you the manu-
facturers of each of
more than fourteen
hundred electronic
and allied products.



... gives you information
as to where they are in pro-
duction or available in a
reasonable time and unre-
stricted for general indus-
trial use.

1951-1952

electronics BUYERS' GUIDE

Please mention this book when
buying or inquiring from it.

SANBORN 1, 2 and 4 channel RECORDING SYSTEMS

DIRECT WRITING • NO INK
RECTANGULAR COORDINATES
PERMANENT RECORDS

RECORDERS AND AMPLIFIERS
AVAILABLE SEPARATELY

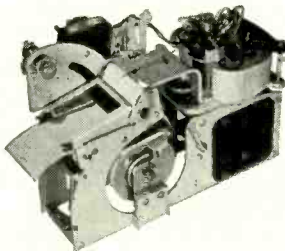

In all Sanborn recorders, tracings are produced by a heated writing stylus in contact with heat sensitive, plastic-coated paper. The paper is pulled over a sharp edge in the paper drive mechanism, and the stylus wipes along this edge as it swings; thus producing records in true rectangular coordinates. The writing arm is driven by a D'Arsonval moving coil galvanometer with extremely high torque movement (200,000 dyne cm/cm deflection). Standard paper speed for the Model 51-600 recorder assembly, shown above, is 25 mm/sec. Slower speeds are available. Paper width 6 cm with 5 cm recording area. The assembly shown above is used in Models 128 and 141 (described above right) and provides the basic principles and methods on which recorders for the 2- and 4-channel systems are designed.

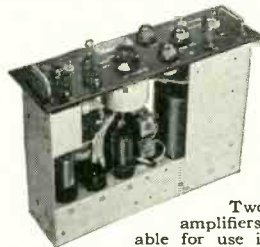

Two types of amplifiers are available for use in Sanborn recording systems—a DC General Purpose Amplifier, and a Strain Gage amplifier (shown above). The amplifiers used in the 2- and 4-channel systems are generally identical with those in the 1-channel system, which are available, as are also all the recorders, for separate application.



For complete descriptions, illustrations, tables of constants, and prices, write for catalog.

1 CHANNEL RECORDING SYSTEMS



Model 128 comprises a DC General Purpose Amplifier in combination with the Recorder Assembly shown below left, to which is added panel, transformer, and controls. Both instruments are contained in a single hardwood carrying case. The complete system is a vacuum tube recording voltmeter capable of reproducing in rectangular coordinates any electrical phenomena from the order of a few millivolts to more than 200 volts. When a Strain Gage Amplifier is specified, the system becomes Model 141. Amplifiers are readily interchangeable. When a built-in timer is included for either, the Model numbers become 128T or 141T.

2 CHANNEL RECORDING SYSTEMS



The two channels of Model 60 operate independently of each other, but record simultaneously. Ten paper speeds are standard equipment, in pairs of: 5 and 0.5, 10 and 1, 25 and 2.5, 50 and 5, 100 and 10 mm/sec. Ready interchangeability of amplifiers (DC and Strain Gage) and preamplifiers (DC and AC) makes possible the availability of a variety of input circuits. Timing and coding are built-in features. Each channel has a 5 cm recording width.

4 CHANNEL RECORDING SYSTEMS



Model 67 provides for the direct, simultaneous registration of up to four phenomena on one record, using the same principles and methods as the two systems described above. In addition, there is a selection of eight paper speeds: 50, 25, 10, 5, 2.5, 1.0, 0.5, and 0.25 mm/sec., and provision for the use of 4-, 2-, or 1-channel recording Permapaper. As in Model 60, above, amplifiers and preamplifiers are readily interchangeable.

INDUSTRIAL DIVISION

Sanborn Company

CAMBRIDGE 39, MASSACHUSETTS

IN-RES-CO
TYPES SM-15 & SM-30 WIRE WOUND
RESISTORS

SUB-MINIATURE
 Weather-tested midgets

Type SM-15 and SM-30 Resistors offer three vital advantages — sub-miniature size, weather resistant construction and high resistance. The elimination of center hole mounting and the inclusion of axial leads increases winding area and results in 25% greater resistance value than resistors of standard design. Special coating is moisture and fungus proof and designed to meet JAN-R-53 specifications. Sealed in Bakelite construction affords additional climatic protection. As ratings are conservative, types SM-15 and SM-30 can be specified with confidence for service under rigorous conditions.



TYPE SM-15
 5/16" DIA. x 3/8" LG.



TYPE SM-30
 5/16" DIA. x 3/4" LG.

ASK FOR THE NEW
 RESISTOR HANDBOOK —

Contains complete data on resistors for every purpose and their recommended applications. Please make request on company letterhead.



INSTRUMENT RESISTORS CO.

COMMERCE AVENUE



UNION NEW JERSEY

APPLICATION-DESIGNED RESISTORS FOR ELECTRONICS AND INSTRUMENTATION

IN-RES-CO
TYPES CX & BX WIRE WOUND
RESISTORS

FEATHERWEIGHT!
 —another IN-RES-CO solution for CIRCUIT DESIGNERS

SEALED IN MOLDED BAKELITE PLUS LIGHTWEIGHT

The dependable resistive elements that combine positive sealing with the important advantage of lightweight. Molded Bakelite core reduces weight by one-half compared to ceramics. Positive seal effectively protects the winding against harmful climatic conditions. Additional IN-RES-CO features include long life stability, hard soldered connections to terminals and extra-sturdy, vibration proof terminal leads. Both CX and BX Resistors include space-saving terminal supported axial terminals of tinned wire.



IN-RES-CO
 TYPE CX
 NON-INDUCTIVE
 RESISTOR



IN-RES-CO
 TYPE BX
 NON-INDUCTIVE
 RESISTOR

ASK FOR THE NEW
 RESISTOR HANDBOOK —

Contains complete data on resistors for every purpose and their recommended applications. Please make request on company letterhead.



INSTRUMENT RESISTORS CO.

COMMERCE AVENUE



UNION NEW JERSEY

APPLICATION-DESIGNED RESISTORS FOR ELECTRONICS AND INSTRUMENTATION

Specify **GM** D'ARSONVAL PORTABLE
GALVANOMETERS
 AND MOVEMENTS...



Series 570-400
 in All Metal Case

A complete instrument, proved through years of rugged use in production testing, ideal for industrial and student laboratories. Its G-M mirror-type movement is both rugged and highly sensitive, uniformly accurate and easy to read. For 110-120 V. 50/60 cy. A.C. Available at your nearest supply house in choice of five sensitivities. Or write us for name of distributor.

GM LABORATORIES, Inc.

4336 N. Knox Ave.

Chicago 41, Ill

IN CANADA: COSSOR (Canada) LIMITED
 301 Windsor St., Halifax, N. S.

Included in the
 DIRECTORY SECTION
 of this Issue
 is a list of more than

850

DISTRIBUTORS OF
 ELECTRONIC COMPONENTS
 and
 ELECTRONIC EQUIPMENT

They are ready and
 willing to serve you.

When ordering, be sure
 to mention the . . .

**electronics
 BUYERS'
 GUIDE**

two-channel



flight carrier

For TRUE dynamic air-pressure measurements of flutter, buffeting, and gust loads. Automatic-zero circuit corrects for static-temperature and pressure variations, gives real unattended operation. High gain with low noise combine sensitivity with clean hash-free oscillograph records.

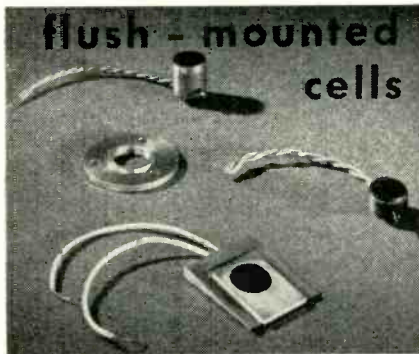

Flush-mounted pressure cells in a wide variety of forms and dynamic ranges give TRUE phase and amplitude measurements. Insensitive to vibration and acceleration. Diameters as small as $\frac{3}{8}$ in. Mount as close as $\frac{1}{2}$ in. from trailing edge. No error-inducing connecting tubes or instrument volume. Send for full information on your particular problem.

ELECTRONIC ENGINEERING ASSOCIATES, LTD.

Manufactured by Sierra Electronic Corp.
1048 Brittan Avenue
San Carlos, California

sub-miniature AND moisture-proof

THE ECONOMICAL SOLUTION where moisture proof resistive elements of comparatively small size are required for commercial applications. Type S-15 is $\frac{3}{8}$ " long by $\frac{1}{4}$ " diameter; type S-30 measures $\frac{3}{4}$ " by $\frac{1}{4}$ " diameter. Both types are moisture proof and capable of high performance over long periods of continuous service. IN-RES-CO Resistors for every ordnance or civilian requirement are available at a cost that solves circuit design problems both performance-wise and cost-wise. Check up now, on the complete line of IN-RES-CO quality wire wound resistors.

IN-RES-CO S-15 & S-30 WIRE WOUND RESISTORS



TYPE S-15
 $\frac{1}{4}$ " DIA. x $\frac{3}{8}$ " LG.



TYPE S-30
 $\frac{1}{4}$ " DIA. x $\frac{3}{4}$ " LG.

INSTRUMENT RESISTORS CO.

COMMERCE
AVENUE



UNION
NEW JERSEY

APPLICATION-DESIGNED RESISTORS FOR ELECTRONICS AND INSTRUMENTATION

FOR JAN SPECIFICATION RESISTORS — consult the new illustrated literature describing the complete In-res-co line. Write for your copy today!



SPACE SAVERS FOR MODERN CIRCUITRY — MONEY SAVERS FOR PRODUCTION ECONOMICS —



IN-RES-CO TYPE IR WIRE WOUND RESISTORS

The practical, low cost solution for circuit designers striving for the sub-miniature. Type IR units offer precision resistance values capable of retaining stability through long periods of continuous or intermittent service. Type IR resistors are available at prices based on mass production methods of manufacture. Wound to a tolerance of $\pm 1\%$, they are permanently accurate. Conservative ratings allow ample safety margin in all classes of service. Special Bakelite forms eliminate shrinking, swelling and temperature effects. IN-RES-CO moisture and fungus proof coating offers absolute protection against climatic extremes. Specify IR Type resistors for all applications where precision performance and limited space are important determining factors.

INSTRUMENT RESISTORS CO.

COMMERCE
AVENUE



UNION
NEW JERSEY

APPLICATION-DESIGNED RESISTORS FOR ELECTRONICS AND INSTRUMENTATION

WRITE FOR NEW RESISTOR HANDBOOK — Contains complete data and recommended applications for resistors for every purpose.



PRECISION SPRINGS

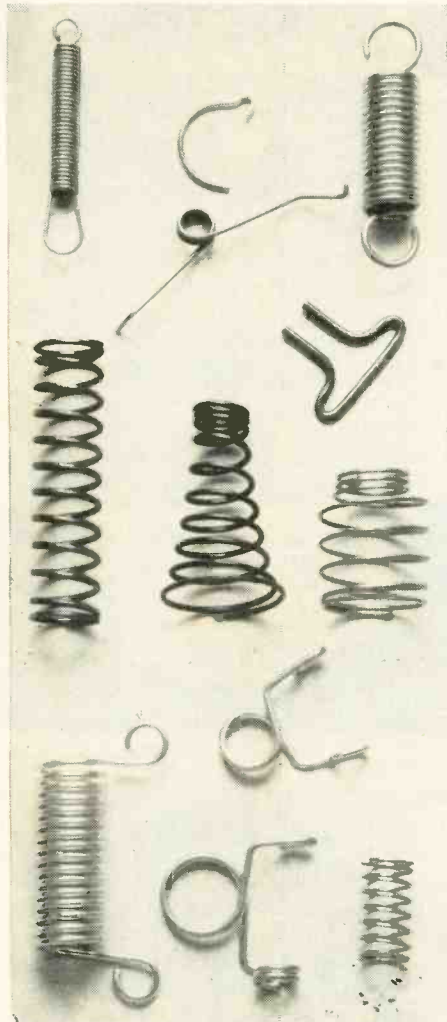

WEBSTER SPRING CORPORATION

... with its complete and modern plant, expertly trained personnel, and production "know-how", supplies the foremost electronic manufacturers with precision mechanical springs OF ALL TYPES.

**EXTENSION
COMPRESSION
TORSION
WIRE FORMS
FLAT - CLOCK**

WHY NOT AVAIL YOURSELF of WEBSTER'S experience, which makes possible the quantity production of these springs at the most economical level consistent with high quality standards?

Our sales engineering staff will welcome the opportunity to discuss your spring requirements, and will gladly submit quotations per your sample spring or blueprint.

We also manufacture channel, filament choke, contact, and band-tuning coils for the television industry.

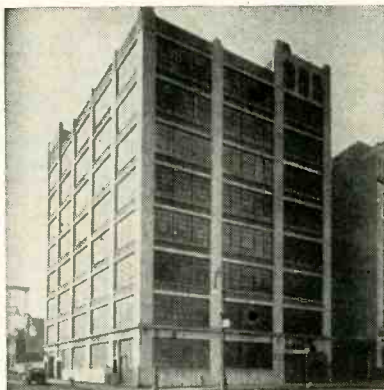

WEBSTER SPRING CORPORATION

176-182 Johnson Street, Brooklyn 1, N. Y.

Phone: ULster 5-3196 • ULster 5-4830

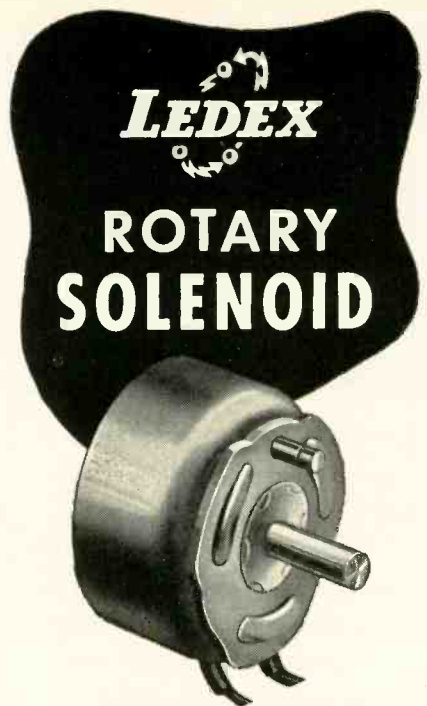

SOLVES MANY REMOTE CONTROL PROBLEMS

The many production applications of Ledex Rotary Solenoids vary from the dependable, snap-action tripping of airborne bomb releases to the actuation of rugged, hydraulic valves in heavy duty materials handling equipment.

Five Ledex Rotary Solenoid models are manufactured. Diameters range from 1 1/8 to 3 3/8 inches. Predetermined rotation up to 95° can be engineered to suit your product's requirements. Starting torques for 45° stroke range from 1/4 pound-inches to 50 pound-inches.

We supply to quantity users and solicit the opportunity to be of assistance in engineering a Ledex Rotary Solenoid to meet your product's requirements.

MODEL NO.	2	5	6	7	8
Diameter	1 1/8"	1 7/8"	2 1/4"	2 3/4"	3 3/8"
Torque lb./inches	1/4	5	10	25	50
Weight lbs.	1/8	1/2	1	2 1/4	4 1/4

Magnetic action moves the armature along the solenoid axis. This action is converted into a rotary motion by means of ball bearings on inclined races.

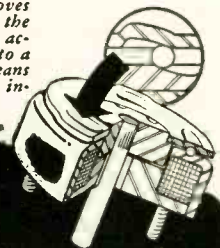

WRITE DIRECT TO

G. H. Leland INC.

118 WEBSTER STREET

DAYTON 2, OHIO

LEDEX

**RELAYS and
CIRCUIT
SELECTORS
ROTARY SOLENOID
OPERATED**

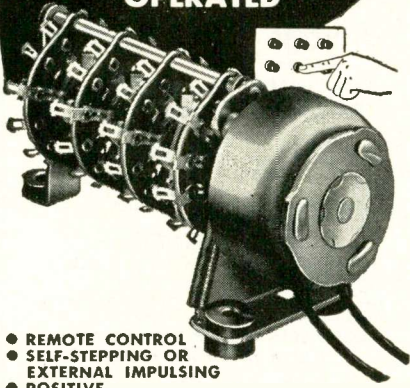

- REMOTE CONTROL
- SELF-STEPPING OR EXTERNAL IMPULSING
- POSITIVE DETENT ACTION

for REMOTE CONTROL of MULTIPLE COMPLEX CIRCUITS

Many versatile designs of stepping, counting, adding and subtracting, latching, and *circuit selecting* relays are made possible by the combination of the Ledex Rotary Solenoid and wafer type rotary switches. Self-stepped or externally impulsed, the device is immediately adaptable to many remote control applications. A choice of wire sizes permits a wide range of operating voltages and power requirements. Various types of mountings further increase its adaptability. In addition to its positive control of multiple, complex circuits, a reserve of mechanical power is available for the performance of duties other than switching operations.

We supply to quantity users and solicit the opportunity to be of assistance in solving multiple circuit relay problems.

WRITE DIRECT TO

G. H. Leland INC.

118 WEBSTER STREET

DAYTON 2, OHIO

Electron Tube GETTER *Specialists*

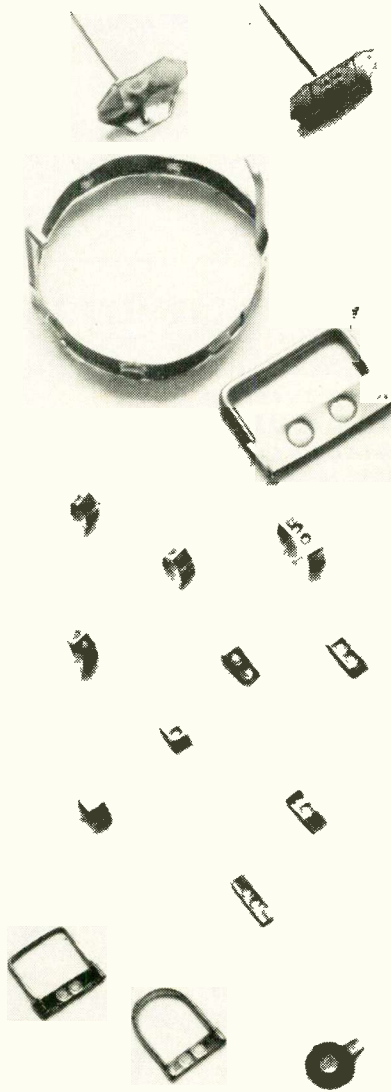

KING LABORATORIES, INC. has been a leading supplier of GETTERS for *electron tube* production for many years. Throughout tube development we have produced better and more economical GETTERS to the most stringent specifications.

Typical examples of KING LABORATORIES firsts are in the Subminiature and Cathode Ray tube fields. As further subminiaturization and the electrostatic Cathode Ray tube developments place even more exacting requirements on tube performance, KING LABORATORIES fundamental research and production facilities can be the answer to your most critical needs.

For all your
GETTER
PROBLEMS

come to . . .

KING LABORATORIES, INC.

127 Solar Street

Syracuse 4, New York

MICRODIAL

TEN TURN-COUNTING DIAL

Microdial is composed of two concentrically mounted dials... one for counting increments of each turn and the other for counting turns. The incremental dial has 100 equal divisions and is attached rigidly to the shaft so there is no backlash. Thus the contact position is indicated to an indexed accuracy of 1 part in 1000. Rotation is continuous in either direction. There are no stops on the Microdial assembly.

COMPACT... Microdial has same O.D. as Micropot... requires no more panel space.

CLEAR READING... Forced fast-reading tests showed only 1/20th as many errors with Microdial open window as with next most legible dial. Turn counter distinguishes between 0 and 10 turn readings, and accelerates to avoid confusion on readings near integral turns. Precise readings are made from larger dial with maximum separation of graduations and wide angle visibility.

CONVENIENT... delivered completely assembled with dials synchronized. Easily mounted in a few seconds. All dials may be locked.

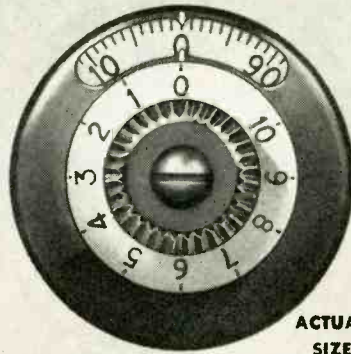

ACTUAL SIZE

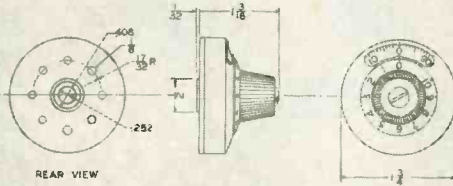

Microdial... turn-counting dial, primarily designed for use on Micropot ten turn linear potentiometers... use it on any multiturn device having ten turns or less.



BORG EQUIPMENT DIVISION
THE GEORGE W. BORG CORPORATION
DELAVAN • WISCONSIN

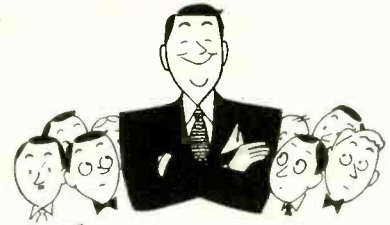

Columbia
Outstanding SOURCE
for your **WIRE** needs!

ANACONDA TELEVISION and RADIO WIRES and CABLES

- Guy Wire
- RG 59U cable
- Shielded TV Lines
- Aluminum Ground Wire
- 300 ohm line
- Rotator Cable
- All types of plastic hook-up wire

We specialize in Wire Harnesses, Cords and Cable for all Electronic Applications

COMPLETE STOCK of:

- Hook-up wire
- Push-back wire
- Wire and Antenna kits
- Antenna wire
- Plugs, Outlets, Connectors
- Intercom wire and cable

CORD SETS to YOUR specifications

WRITE for our new catalog!

Columbia
WIRE & SUPPLY COMPANY

2850 West Irving Park Road
Chicago 18, Ill.

"National Distributors and Warehouse for Anacoda Densheath Television and Radio Wire and Cables"

ENGINEERED IRON CORES

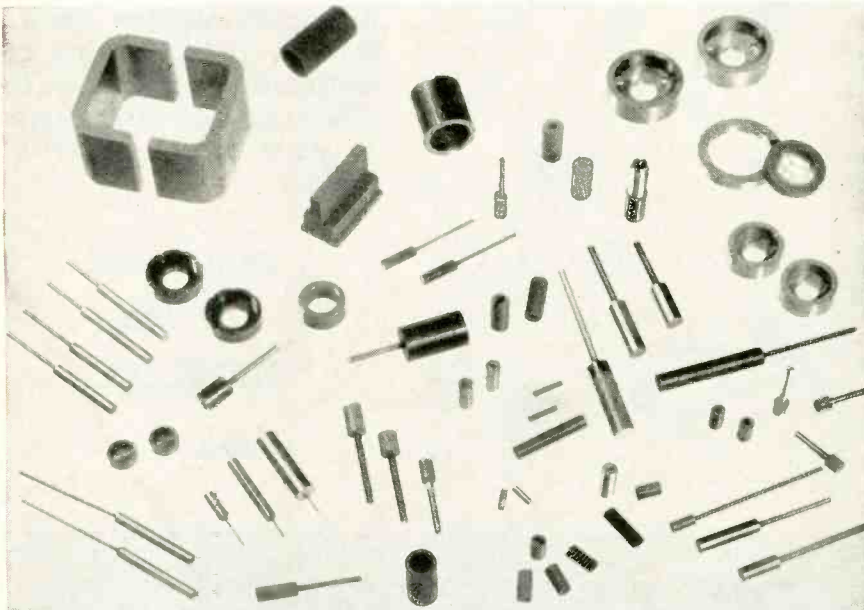

ENGINEERED — TO THE CUSTOMERS SPECIFICATIONS FOR RADIO — T V
— COMMUNICATIONS MINIATURIZATION — GUIDED MISSILES
RADAR — AND SPECIAL APPLICATIONS

WRITE FOR LATEST DATA SHEETS

RADIO CORES, INC.

9540-50 TULLEY AVENUE OAK LAWN, ILLINOIS

this **BOOK** tells you
the **MANUFACTURERS**
of over 1400 types of
ELECTRONIC and
ALLIED PRODUCTS
from .. **ABRASIVES**
to .. **YOKES, Deflection**
and this year ...



tells you where they are in production or available in a reasonable time and unrestricted for general industrial use.

electronics
BUYERS'
GUIDE

Please mention this book when buying or inquiring from it.

For plywood remember Keller will render complete service

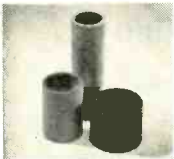

Molded plywood seamless tubing for radar masts



Cabinet wrapper of curved molded plywood



Coil forms of plastic impregnated cloth



Electronic unit housing or container



Radome of low pressure plastic impregnated cloth

Keller designs, engineers and fabricates molded plywood

... from very light to heavy gauge shapes in nearly any practical size, gauge and veneer.

Metal shortage problems have been solved with molded plywood —

In the electronics field Keller renders many services ... to name a few:

- Curved plywood cabinet panels and structural chassis members.
- Lead plywood in X-Ray and Atomic shielding.
- Plywood tubing for masts, rods and antennae.
- Low pressure Plastics reinforcing fibre glass, glasscloth and mats.

Write, wire or phone Keller with your problems.

Keller

PRODUCTS, INC.

38 Union Street
Manchester, N. H.

MICROPOT

PRECISION TEN-TURN POTENTIOMETER

1. You get permanent accuracy because the resistance wire is locked in place. It is precision positioned and moulded integrally with the housing.
2. You get permanently accurate settings, smooth action and low uniform torque provided by the stainless steel, precision ground, double thread lead screw guiding the moving contact.
3. You get precise positioning of the moving contact because of the two bearings supporting the rotor assembly.
4. You get good rigid terminals because they are moulded integrally with the housing.
5. Terminals soldered to ends of resistance element before moulding. Entire resistance circuit is an integral part of the housing.
6. You get accurate setting and re-setting due to anti-backlash spring in contact guide.
7. You get a fine resolution because of the $43\frac{1}{2}$ " length of resistance wire in the spiral element.
8. You get a resistance output directly proportional to shaft rotation within $\pm 0.1\%$ of the total resistance. Every potentiometer is automatically machine tested for linearity at 101 points.

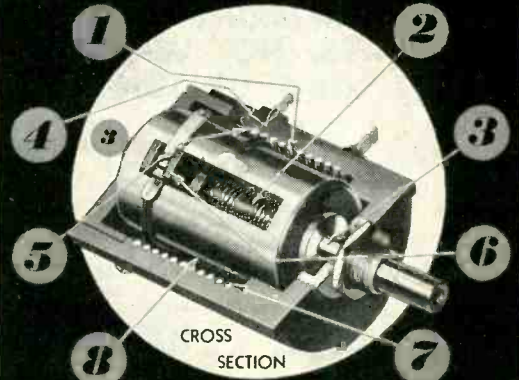

LINEARITY ACCURACY $\pm 0.1\%$

Units for immediate shipment:
1,000 to 30,000 ohm range.
Special resistance values made to order.

WRITE TODAY FOR
ENGINEERING INFORMATION



BORG EQUIPMENT DIVISION
THE GEORGE W. BORG CORPORATION
DELAVAN • WISCONSIN

ZOPHAR

WAXES
COMPOUNDS

Anti-Corona high heat-resistant compounds for Fly Back Transformers.

Waxes and compounds from 100° F to 285° F
Melting Points for electrical, radio, television,
and electronic components of all types.

Pioneers in fungus-resistant waxes.

Our efficient and experienced laboratory staff
is at your service.



ZOPHAR MILLS, INC.
112-130 26th Street,
Brooklyn 32, N. Y.

EDWARD E. ROBINSON

METERING PUMP for HOT WAXES and CEMENTS

- Filling
- Sealing
- Potting
- Insulating
- Cementing
- Impregnating
- Weather Proofing



Robinson Metering Pump being used to forcibly eject metered amounts of cement into wire brush handle. Reservoir temperature 350° F.

- | | |
|--------------|----------------|
| Transformers | Sockets |
| Condensers | Switches |
| Rectifiers | Wiring Devices |

Not a gravity dispenser — Forcibly ejects hot waxes and cements. Thermostatically controlled heat — Variable with a maximum reservoir temperature of 450° F. Motor driven, clutch actuated — 2/3 second per ejection. Variable discharge — Ejections changed in 2 seconds, without tools. Reduces unit casts — No skilled operator required. Saves material — reduces rejects. Easily installed — Adaptable to any production set-up. For complete information on this modern production tool and its possible application to your requirements, write for Bulletin No. 1A-R.

EDWARD E. ROBINSON
INCORPORATED
95 PARK AVENUE • NUTLEY 10, N. J.

We Specialize in Developing WIRE STRIPPING METHODS

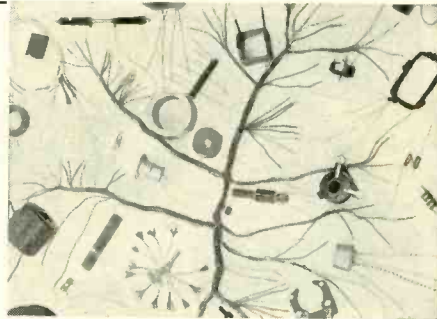

Because of the number of variables involved, every wire-stripping operation must be considered as an individual problem if best results are to be obtained.

Based on specific samples and production data, we apply our experience and research facilities to the problem of finding the most efficient method of stripping the particular wire you are using—and

the most efficient method of handling the parts during the stripping operation. This service is offered without charge.

We manufacture a wide variety of mechanical wire strippers and also frequently recommend other (non-mechanical) methods of stripping based on the results of careful and complete tests.

Write for "Request for Wire Stripping Analysis" or Have Your Methods Engineer Visit Our Plant

No Cost or Obligation

Rush Wire Stripper Division
The Eraser Company, Inc., 104 S. State St., Syracuse 2, N. Y.

Want to know about the...

- AUGETRON
- ECCLES-JORDAN CIRCUIT
- KATHETRON TUBE
- MEKAPION TUBE
- PERMATRON
- PETOSCOPE
- SCHLIERN METHOD
- SCOPHONY
- SEMAGRAPH
- SIRUFER
- SYNDEC
- THEREMIN
- TRATONIUM
- VODER

or other early electronic developments?

You can find out about them in the early issues of **ELECTRONICS**.

The cumulative index to **ELECTRONICS'** first decade, pages C-1 to C-36 in this book, tells you where to look.

BETA

for the finest
HIGH VOLTAGE
POWER SUPPLIES

Beta power supplies, from 200 volts to 250,000 volts, are available from standard designs THAT HAVE ALREADY BEEN BUILT and are in continuous use by satisfied customers.

Below are listed some of the scores of designs available:

- 250—300 Volts, 600 ma—Model 252
- 0—1000 Volts, 500 ma—Model 246
- 0—2000 Volts, 2 ma—Model 223
- 0—5000 Volts AC, 1 ma—Model 236
- 0—10,000 Volts AC/DC, 30 ma—Model 231
- 0—15,000 Volts, 300 microamperes, regulated—Model 501-E
- 0—30,000 Volts, 2 ma, Series 201, portable units
- 0—30,000 Volts, 30 ma—Model 245
- 0—40,000 Volts, 2 ma—Model 224
- 0—50,000 Volts, 2 ma—Model 242
- 0—60,000 Volts, 25 ma cable tester—Model 2011
- 0—100,000 Volts, 2 ma—Model 217
- 0—150,000 Volts, 100 ma cable tester—Model 219
- 0—250,000 Volts, 5 ma—Model 213

Also available are kilovoltmeters, up to 200 KV DC; electronic microammeters, 0.001 microamps. sensitivity; portable projection oscilloscopes; electronic rheostats.

Write for further details about any of the above or for a quotation on a power supply custom-built to your exact specifications.

CONSULT OUR LOCAL FIELD ENGINEERS

Field engineers throughout the country and abroad are available for consultation.

- | | |
|---------------------------------------|--|
| Northeast | Brujac Electronic Corp.
11 Park Place
New York 7, N. Y. |
| Ohio, Mich.,
Western Penn. | Neal Bear Corp.
West Richfield, Ohio |
| Chicago-
Midwest | James E. Everett Assoc.
2202 West Touhy Ave.
Chicago 45, Ill. |
| Southwest | Earl Lipscomb Assoc.
3561 Marquette St.
Dallas, Texas |
| California | E. V. Roberts & Assoc.
5068 W. Washington Blvd.
Los Angeles 16, Calif. |
| Canada | Stark Electronic Instr. Ltd.
Ajax, Ontario, Canada |
| Overseas | Rocke International Corp.
13 East 40 St.
New York, N. Y. |

Or Call
ENright 9-8520

BETA

ELECTRIC CORP.

333 EAST 103 STREET
NEW YORK 29, N. Y.

ELECTRO TEC SLIP RING ASSEMBLIES & COMMUTATORS

for GYROS, COMPUTERS
RESOLVERS, MOTORS,
SELSYNS, INSTRUMENTS

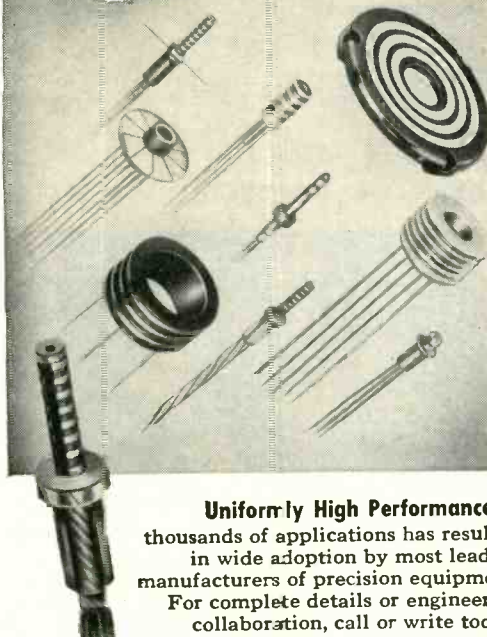

- ABSOLUTE MINIMUM TORQUE FRICTION
- DIAMETERS FROM .05" TO 24.0"
- MINIMUM 1000 V.A.C. HI-POT INTER CIRCUIT
- HARD SILVER RINGS PLATED TO PRECISION MACHINED PLASTIC FORM
- SPECIAL SURFACE DEPOSITS MINIMIZE FRICTION, PREVENT TARNISH

Electro Tec Miniature Slip Rings and Commutators are the product of an exclusive manufacturing technique that results in precision concentricity, higher dielectric strength, longer life.

Uniformly High Performance in thousands of applications has resulted in wide adoption by most leading manufacturers of precision equipment. For complete details or engineering collaboration, call or write today.

... PRECISION CRAFTSMANSHIP

(PATENTS PENDING)

ELECTRO TEC CORPORATION



SO. HACKENSACK, NEW JERSEY

RADIO FREQUENCY COILS

TO YOUR SPECIFICATIONS

HARNETT

We stand prepared to serve your most exacting needs with windings that function under the most diversified and demanding operating conditions of both commercial and military requirements.

HARNETT ELECTRIC CORPORATION

138 Haven Ave., Port Washington, Long Island, N. Y.
Telephone: Port Washington 7-3334

Electronic Coils, Inc.

OFFERS

COILS and COIL ASSEMBLIES

TO MANUFACTURERS' SPECIFICATIONS

Write Us Your Requirements

BOBBIN TYPES—Random or Layer

for

- CLOCKS • TIMERS • RELAYS
- MOTORS • SPEAKERS • HEADSETS

RADIO & TELEVISION

- R.F. and Filament Chokes
- Peaking Coils
- Slug Tuned Coils
- Solenoid and
- Progressive Windings, etc.



Electronic Coils, Inc.

P. O. Box 1641
SPRINGFIELD, MASS.
Tel. 6-6339



with **SIGNAL GENERATORS**
by AIRCRAFT RADIO CORPORATION

TYPE H-14

108-132 Megacycles
24 omni courses

Left-center-right
phase localizer

Left-center-right 90/150 cps localizer

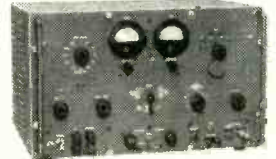

Signal source for bench or ramp testing of VHF airborne omnirange and localizer receivers. RF output for ramp checks, 1 volt into 52 ohms; for bench checks, 0-10,000 microvolts.

Price \$885.00 net, f.o.b. Boonton, N. J.

TYPE H-12 900-2100 mc. RF signal source, CW or pulse amplitude-modulated. Equal to military TS-419/U.

Price: \$1,950.00 net, f.o.b. Boonton, N. J.



WRITE FOR DETAILS AND SPECIFICATIONS

AIRCRAFT RADIO CORPORATION
Boonton New Jersey

Dependable Electronic Equipment Since 1928

MIL - JAN - AN - C - CCC - MIL - JAN - AN - C - MIL

A VITAL TESTING SERVICE FOR GOVERNMENT SUPPLIERS

The specifications of most Government contracts make it advisable to pre-test components and related equipment before submitting to Government test. We offer Government suppliers testing programs in the following Environmental and Functional Testing Fields, designed to meet official contract specifications:

- **VIBRATION** (Standard High Frequency)
- **SALT SPRAY** (Corrosion)
- **FUNGUS**
- **HUMIDITY** (Varying Condition)
- **SAND & DUST**
- **LOW PRESSURE** (Altitude Testing)
- **HIGH & LOW TEMPERATURE**

Write or call, and we will arrange technical discussions without obligation.

UNITED STATES TESTING COMPANY, INC.
Established 1880
HOBOKEN, NEW JERSEY

PHILADELPHIA • BOSTON • WOONSOCKET • CHICAGO • NEW YORK • LOS ANGELES • DENVER • MEMPHIS
Member of American Council of Commercial Laboratories



NOT...

until next year
will you get another

electronics BUYERS' GUIDE

Don't let it get away from you.

It's the best source of buying information for electronic and allied products that has ever been compiled.

When buying, or requesting product information be sure to mention **ELECTRONICS BUYERS' GUIDE.**

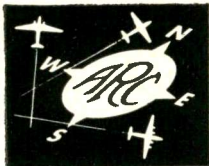

WHEREVER YOU
GO
WHATEVER YOU
FLY

ARC EQUIPMENT

Meets Your Operational Needs

ARC Type 11A meets basic needs by providing VHF transmission, LF range reception suitable for the exacting requirements of night instrument operation, and rotatable loop navigation.

ARC Type 17 is 2-way VHF equipment, including tunable VHF receiver and one or more 5-channel, crystal controlled VHF transmitters.

ARC Type 12 (illustrated) gives you advantages of both Type 11A and Type 17 systems.

All ARC airborne equipment is designed for reliability and performance, not to meet a price.

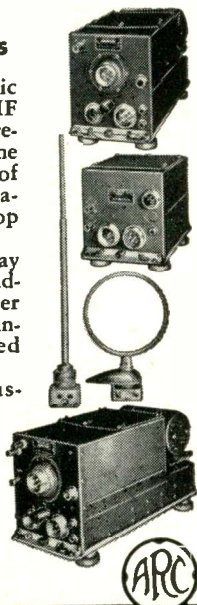

AIRCRAFT RADIO CORPORATION
Boonton New Jersey
Dependable Electronic Equipment Since 1928

THIS BOOK...

The electronics BUYERS' GUIDE

tells you
who makes each of
fourteen hundred dif-
ferent electronic and
allied products.

Keep it
and use it
for quick buying
and technical reference
throughout the year.

When buying, or requesting product information be sure to mention
ELECTRONICS BUYERS' GUIDE.

Your wholesale distributor stocks these items
MICRO CIRCLE CUTTER for Metal - Wood - Plastics

- Micrometer type size control
- Extra heavy duty beam
- Special beam locking mechanism

Model	Type	Size	Price
1	Round Shank	4 inch	\$5.00
1A	Square Shank	4 inch	\$5.00
5	Round Shank	6 inch	\$7.50
10	Round Shank	14 inch	\$15.00

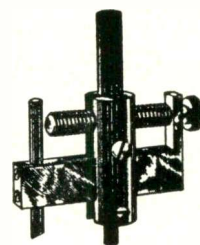

ELECTRO GRAPHIC RECORDER

Most convenient size graphic recorder available. Mounts like any standard panel meter. No messy inks, pens or chemicals are used. All writing is fadeproof. Standard sensitivity 0-1 Ma. Other ranges available on order.

Model 50 Recorder 0-1 Mill Price 85.00

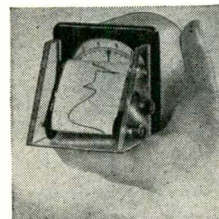

We invite your inquiry on other Precise products:

Meter Scale Printing Machines—Rubber Circuit Stamps
Kilovoltmeters to 100Kv—RF Power Supplies
Infra Red Viewers' SNOOPERSCOPIES—Cesium Vapor Lamps
Infra Red Filters—Ultra Violet Filters
Electrostatic Generators
Image Converter Tubes—Infra Red Phosphors

literature on request

PRECISE MEASUREMENTS COMPANY

942 Kings Highway DEPT. E Brooklyn 23, New York

Completely Accessible from operating surface

dependable instruments



Type A-708...24-channel

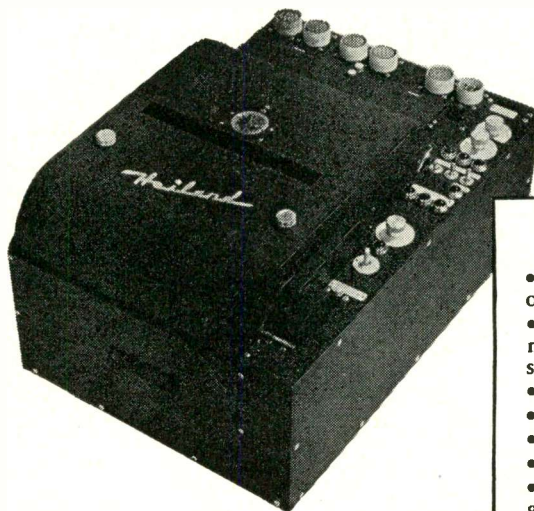

FEATURES

- Completely accessible from operating surface
- Compact...can be mounted in a minimum of space...lightweight
- Can be panel mounted
- 6 to 24 channels
- Paper widths 5", 8", 12", 18"
- Simplicity of loading
- Direct monitoring of galvanometer light spots
- Flexibility of operation
- Simultaneous viewing, recording and scanning
- Trace identification...zero mirror...synchronizing reference trace
- Adjustable automatic record length

AUTOMATIC OSCILLOGRAPH RECORDER

Affording complete accessibility from operating surface and requiring only a minimum of space for mounting, the HEILAND A-708 meets the exacting specifications of research and development personnel in aircraft flight testing, laboratory and industrial testing.

Write for complete details

HEILAND RESEARCH CORPORATION • 130 East Fifth Ave. • Denver, Colo.

HAVE YOU EVER SEEN
PERFORMANCE LIKE THIS?

Revolutionary
D. C. TIMING MOTORS
with **CHRONOMETRIC**
GOVERNORS
BY A. W. HAYDON



A PRIMARY TIME-POWER SOURCE OF EXTREME ACCURACY, PRACTICALLY UNAFFECTED BY VARYING VOLTAGE, LOAD OR TEMPERATURE.

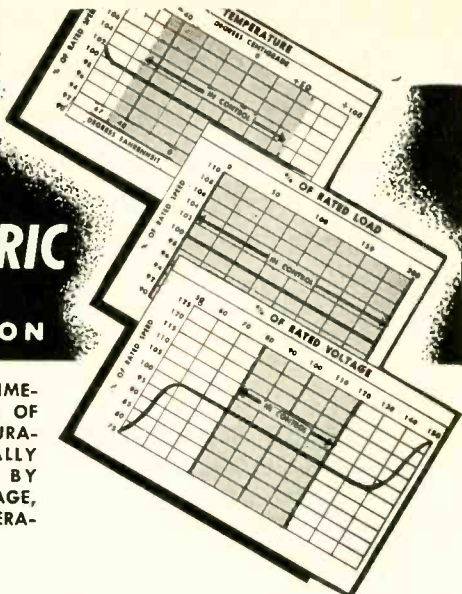

TIME DELAY RELAYS—Single and multiple switch, adjustable dial, and hermetically sealed, both A.C. and D.C.

REPEAT CYCLE TIMERS—Compact multiple switch, both A.C. and D.C. in aircraft and hermetically sealed housings.

ELAPSED TIME INDICATORS—A.C. and D.C. with chronometric governor and sealed in aircraft instrument housings.

D.C. TIMING MOTORS—Variable speed and low current for operation in vacuum tube circuits and use as tachometer generators.

A.C. SYNCHRONOUS TIMING MOTORS—Slow speed hysteresis type with enclosed gear train.

Send for Catalog sheet on D. C. Timing Motor with Chronometric Governor . . . Our staff is at your service.



The
A.W. HAYDON
COMPANY
238 NORTH ELM STREET
WATERBURY 20, CONN.

Design and Manufacture of Electrical Timing Devices

THIS IS THE

ONE BOOK

THE ONLY
ONE OF ITS KIND

In which
design engineers and
purchasing agents will find
a complete, accurate, and
up-to-date list
of the manufacturers
of all types of electronic
and allied products . . .
components and complete
equipment.

Keep it handy
for ready reference
throughout the year.

When buying, or requesting
product information be sure
to mention . . .

electronics BUYERS' GUIDE

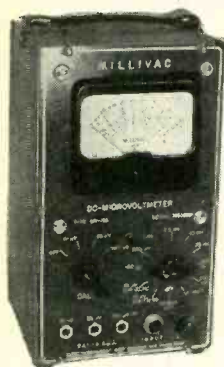

Millivac Instruments Emphasize SENSITIVITY and STABILITY

Indicating Instruments

MV-11A DC MICRO-MICRO-AMMETER: Range 10×10^{-12} A to 10A.

MV-15A DC MICROVOLTMETER: Range 1 microvolt to 1 V.

MV-17B DC MILLIVOLTMETER: 1 mV full scale to 1000 V, 6-60 megohms input impedance.

MV-18B RF MILLIVOLTMETER: Range 1 mV to 1000 V, 1 MC to 200 MC flat within 10%.

MV-73B: Most complete multi-purpose meter, DC, AC, RF millivolts; AC, DC microamperes; ohms.

RECORDING INSTRUMENTS

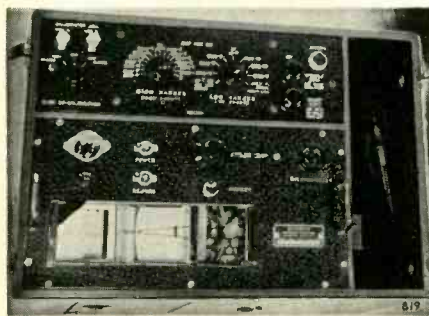

MR-61A: Micromicro-Amperes, DC to 20 cps, 3×10^{-12} A/cm.

MR-65A: Microvolt, DC to 10 cps, 0.2×10^{-6} V/cm.

MR-67A: Millivolt, DC to 20 cps, 20×10^{-6} V/cm, 6 megohms.

Recorders use Sanborn heat writing recorder with Millivac sensitive amplifiers.

MILLIVAC INSTRUMENT CORP.

BOX 3027
NEW HAVEN, CONN.

FEATURING TRANSDUCERS

**ROANWELL
DELIVERS
MANY ITEMS
FROM STOCK**



HANGERS

- Patented Spring-lock type switchbox hangers.

ROANWELL HANDSETS

- Standard Cartridge Components.
- Long-life push-to-talk switches with "detent" action.
- Noise cancelling Transmitters.
- Special Cordage strain reliefs

Equipped with "confidencer" for noise free telephoning. Technical data on request.



MOBILE MICROPHONES

- High-gain transmitters
- Non-loosening hang-up buttons.
- Special cord strain reliefs.
- Approved by leading manufacturers of mobile and fixed station equipment.
- Interchangeable with existing types.

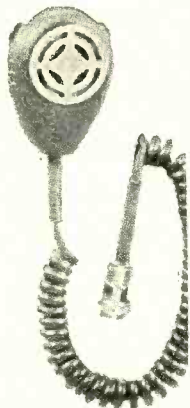

SPECIALISTS IN SPECIFICATION HEADSET-MICROPHONES



**IN COMBINATION
FOR RADIO,
MOBILE AND
TELEPHONE
SERVICE**

For Information on New Military Items address, "Contract Sales."

**ROANWELL
CORPORATION**

662 Pacific St. Brooklyn 17, N. Y.
Telephone: MAin 2-2121

Miniaturize NOW with **Bond** precision wire wound RESISTORS

OUR WIRE WOUND RESISTORS are always specified where performance under the most severe conditions of temperature, voltage, and humidity is required for stability and long life.

All standard units are protected at no extra cost from humidity and fungi by a special process incorporating two layers of varnish impregnation. After labeling, all resistors are coated with a third layer of a BOND exclusive material protecting the labels and resistors from flame, oil, abrasive material, salt water and extreme thermal shocks.

Miniature type 503 (shown at the bottom of the photograph) rated at a maximum resistance of 125,000 ohms and 1/5 watt dissipation is the smallest non-inductive unit now being manufactured.

The entire BOND line of resistors is manufactured in accordance with JAN-R-93 specifications.

Hi-quality COILS custom built to customer's specifications

BOND coil facilities now available:

- TOROIDAL
- BOBBIN
- INDUSTRIAL
- RADIO
- SOLENOID
- TELEVISION

Send Today for Complete Catalog and Engineering Bulletin

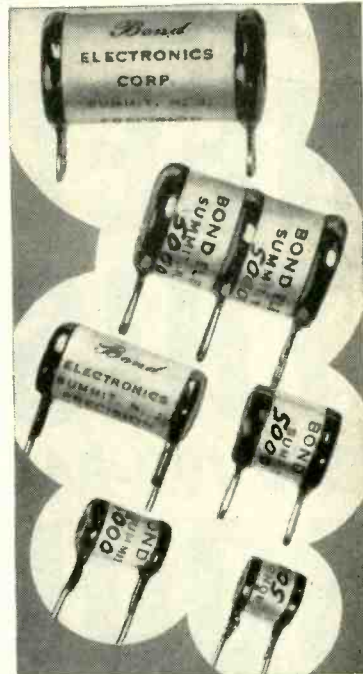

Bond ELECTRONICS CORP.

88 Franklin Place • SUMMIT, NEW JERSEY

Permanent Magnet Problems Can Be Simple... If You Have:

- ✓ Quality Magnets
- ✓ Prompt Delivery
- ✓ Complete Engineering Service
- ✓ Low Unit Cost

For 49 years Thomas & Skinner has geared its facilities to provide the answer to all permanent magnet problems.

Why not let Thomas & Skinner engineers work with you in the design and production of the right permanent magnet for your application? Write or call us today.

THOMAS & SKINNER — Specialists in magnetics; permanent magnets and laminated cores



THOMAS & SKINNER Steel Products Company
1120 East 23rd Street • Indianapolis, Indiana

YOU NEED THIS FREE 192-PAGE BOOK

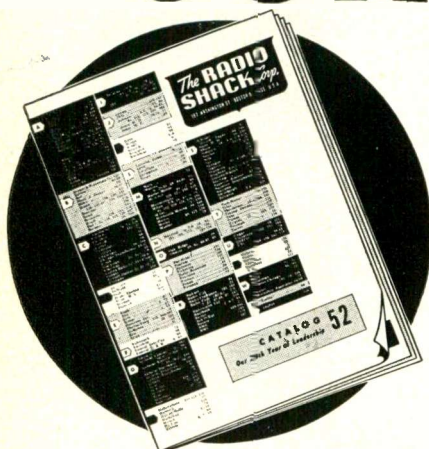

It's your "single source" buyer's guide and reference to parts and instruments for every need.

Planned for use right from the unique, front-cover index, this *ALL NEW* 192-page catalog will save you hours of searching for materials sources. And Radio Shack's huge stocks of nationally advertised parts and equipment save time and trouble in filling your orders for industrial, JAN-spec., ham, TV, audio, and radio items.

WRITE TODAY
for your **FREE COPY**
of Catalog E-52

RADIO SHACK

CORPORATION

167 Washington St., Boston 8, Mass.

UNICON

A Dependable Source for SPECIAL CAPACITORS

When special capacitors with unusual characteristics are required, we can fulfill your requirements and give excellent delivery. Some outstanding types are as follows:

POLYSTYRENE CAPACITORS



Characterized by extremely high insulation resistance and Q, and very low power factor and dielectric absorption. Ratings from 200 volts to 50,000 volts. Ideal for use in computers, radiation equipment and timing circuits. Write for catalog ED giving full technical information.

MOLDTITE MOLDED CAPACITORS

- HIGH TEMPERATURE
- MOISTURE PROOF

MOLDTITE paper capacitors are sealed in a high temperature compound which will not soften at 100° C. Excellent for all-around use in all television and electronic applications. Ideal for export to hot humid climates.

MOLDTITE (molded tight against moisture) maintains high insulation resistance under severe humidity and temperature conditions. There are no "air voids" or cardboard tubes to absorb moisture. Write for catalog EP giving our low prices and other information.

HIGH VOLTAGE PLASTIC DIELECTRIC CAPACITORS

Available in a wide variety of capacities, voltage ratings, and housings. Featured by small bulk, light weight, and absence of oil seepage troubles. Write giving your exact requirements for a prompt quotation.

UNICON PRICES ARE EXTREMELY ATTRACTIVE. UNICON DELIVERIES ARE EXTREMELY GOOD. WHEN YOU NEED A SPECIAL CAPACITOR IN A HURRY, CALL ON UNICON.

UNITED CONDENSER CORP.

337 East 139th St., New York 54, N. Y.
CYpress 2-5180-1

PRECISION ELECTRONIC TEST EQUIPMENT

MODEL 77 OSCILLOSYNCHROSCOPE

For the study of short duration pulses and micro-second time intervals, the Hycon Model 77 Oscillosynchroscope is unexcelled. Great flexibility for all types of pulse and delay measurements is provided. Sweeps of 10 μ s, 30 μ s, 100 μ s, 300 μ s, 1000 μ s, and 3000 μ s on internal or external trigger. Any 10 μ s or 30 μ s portion may be selected and expanded to 4 inches. P.R.F. is variable from 10 to 2000 CPS. Crystal controlled markers spaced 10 μ s and 50 μ s, are locked with internal trigger. Self calibration of Y axis from a square wave generator whose amplitude is directly calibrated on a dial reading in 1/10th volts. Delay calibration micro-vernier dial readable to .05 μ s. Video amplifier gain of 350 times, flat to 5 megacycles from 20 CPS, with six-step frequency-compensated attenuation up to 1000:1.

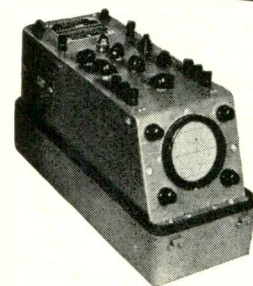
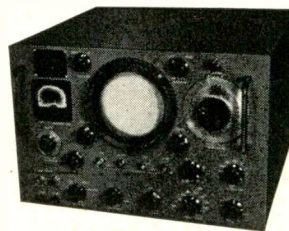

MODEL 49 MINIATURIZED OSCILLOSCOPE

A rugged, shock-resistant, light-weight, waterproof instrument with wide band and linearity features normally found only in laboratory equipment. Faithfully portrays a high frequency square wave in excess of 100 KC. Sweep frequency, 3 CPS to 60 KC. Horizontal frequency response uniform within 2db from zero to 100,000 CPS. Vertical amplifier uniform within 3db at all frequencies between zero and 2mc. Deflection sensitivity, horizontal and vertical, .075 volts per inch. Weighs only 17½ lbs. Supplied in large quantities to the Navy and Air Force.

Hycon
Mfg.
Company

2961 E. Colorado St.
Pasadena, California

For Top-Quality Pictures

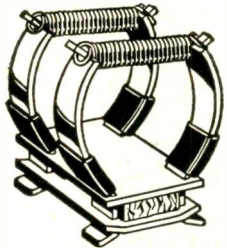

Simplest to install. Wobble-free. Single or double units.

— USE PERFECTION ION TRAPS

Now Standard on Leading TV Sets

Admiral Corp.	Philco
American	RCA Victor
Bendix	Regal Electronics
Dewald	Sentinel
Emerson	Stewart-Warner
Garod	Stromberg-Carlson
General Electric	Teleking
Hallicrafters	Teletone
Hoffman	Telequip
Jackson	Trad
Meck	Warwick
Motorola	Wells-Gardner
Muntz	Westinghouse
Olympic	Wilcox-Gay

Zenith

Write today for full details!

PERFECTION ELECTRIC CO.

2635 South Wabash Avenue, Chicago 16, Illinois
Makers of Perfection Speakers, Beamjusters and B.O. (Barkhausen Oscillation) Eliminators

JELLIFF RESISTANCE WIRES are very much AT HOME IN A HOT SPOT

ALLOY	OHMS PER CMF	MAX. OP. TEMP.	WIRE DIAM. RANGE	FORMS†	USES
1000	1000	500°F	0.0010 0.0009	W-R	Compact, stable precision Resistors
C	675	1700°F	0.2890 0.0008	W-R	Appliances and Resistors
A	650	2100°F	0.0410 0.0010	W-R	High-temp. Furnaces and Resistors
45	294	930°F	0.2890 0.0010	W-R	Precision Applications

†—W, wire—R, ribbon—S, strip.

Whether the *heat* is literal (up to 2460F), or figurative in the sense that performance under difficult conditions is a "must", we have an alloy for almost any conceivable requirement. The above Table may suggest possible applications to your products.

Complete Technical Data are available from Department 17.

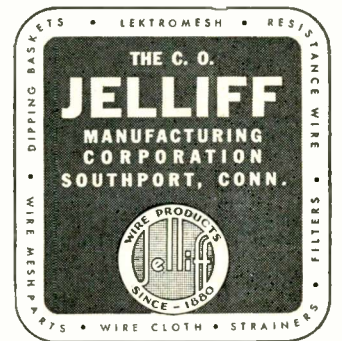

this BOOK 11th year now in its

has earned industry-wide acceptance as the only complete and accurate source of buying information for all types of electronic and allied products components and complete equipment

In Addition, this year . . .



tells who has what in production or available in a reasonable time and unrestricted for general industrial use.

electronics BUYERS' GUIDE

Please mention this book when buying or inquiring from it.



QUALITY
QUANTITY
QUICKLY

Radio Frequency CONNECTORS

• Our specialty is solving your special problem in connectors requiring precision machine work, high temperature and low loss insulation, silver soldered assemblies, silver plated bodies and contacts—waterproofed—pressurized.

ARMED SERVICES APPROVED TYPE "N" CONNECTORS (as illustrated) now in production.

We are prepared to meet your requirements for type "BNC", "MC", or any type RF connector—standard or special—can be set up quickly and produced efficiently.

Phone BLackstone 1330, or write GEO. H. FATHAUER

Dage Electric Company

4007 E. MICHIGAN ST., INDIANAPOLIS 1, INDIANA

Accurate FABRICATION of FUSED QUARTZ PRECISION FABRICATED TO SPECIFICATIONS

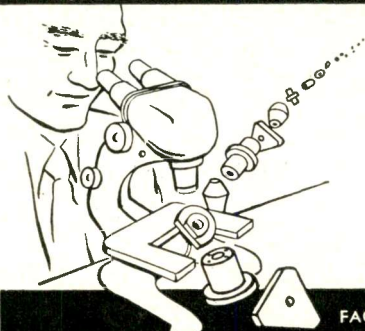

Specialists in the fabrication of FUSED QUARTZ, ceramics, alumina, norbide, sapphire or any other hard material to closest tolerance. All sizes and shapes for production and research in chemistry, electricity, and physics.



FACTORY AT 26 IRVING COURT, MALDEN, MASS
SYNCOR PRODUCTS CO. BOX 51, MALDEN 48, MASS.

SPEER
ELECTRONIC COMPONENTS

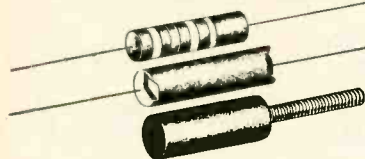

FIXED CARBON COMPOSITION RESISTORS ½ to 2 watts; insulated.
COIL FORMS molded from mineral filled material, iron powder or metallic oxides with 2 to 6 terminals. And with the exclusive patented Speer notch for anchoring leads.
IRON CORES for permeability tuning, high frequency coils, high-resistivity applications and as sleeves, caps and threaded cores.

SPEER
Resistor **CORP.**

A SPEER CARBON COMPANY SUBSIDIARY
 St. Marys, Pa.

JEFFERS
ELECTRONIC COMPONENTS

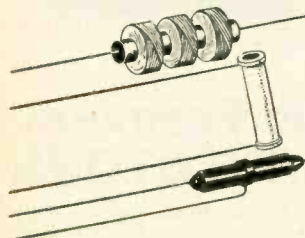

COILS — RF chokes, tapped coils, other RF coils and special windings, with or without molded insulation.
CAPACITORS — Tubular ceramic with neg. temp. coefficients. Capacities 3.0—1,000 MMF. Insulated and non-insulated.
 —TUBULAR ceramic high K material. Capacities 150—20,000 MMF. Insulated and non-insulated.
 —MOULDED. Capacities 0.10—4.7 MMF insulated, 4.7—100 MMF non-insulated.
 —HI VOLTAGE. Capacities 51—1200 MMF, working voltage 10,000—20,000; up to 600 MMF in 30,000 working voltage. Plain, threaded or tapped terminals.
 —SPECIAL TYPES, bypass, standoff, etc.
CAPRISTORS —Combination capacitor and resistor. Single capacitor unit to 20,000 MMF or dual units to 5,000 MMF each. Resistance up to 10 meg. in ½ watt type.

JEFFERS
Electronics **INC.**

A SPEER CARBON COMPANY SUBSIDIARY
 Du Bois, Pa.

Over 125 manufacturers have adopted
ZIP-GRIP*
Self-Locking
SET SCREWS
 in one year's time

Send for
FREE
DEMONSTRATOR
 that Shows
 You Why.



Dramatically demonstrates ZIP-GRIP's* three-way Self-Locking effect including exclusive Contra-Thrust Action. See for yourself how ZIP-GRIP* may be the solution to your puzzling set screw problems.
 With the FREE Demonstrator we'll also send you illustrated Data Sheet and tell you how to get Engineering Test Samples for your application, without any cost or obligation to you. Write us today for your FREE ZIP-GRIP* Action Demonstrator.

*Pat. Pending

5550

Makers of



SET SCREWS

Set
Screw
 & Mfg. Co.

470 Main St. Bartlett, Ill. (Chicago suburb)

We specialize in Solving Puzzling Set Screw Problems.

SPECIFICATION

ELECTROPLATING

GOLD • SILVER • RHODIUM • PALLADIUM

Complete modern plant. Unlimited production facilities, highly skilled workers plus 40 years of background and experience, your guarantee of complete satisfaction. All required GOVERNMENT SPECIFICATIONS maintained. Also ELECTROPLATING ON ALL PLASTICS.

Write, phone for representative

COHAN-EPNER CO., INC.

142 West 14th St.,

New York 11, N. Y.

Phone CHelsea 3-3411

RECOGNIZED . . FOR SERVICE TO THE INDUSTRY



A Complete
 Line of
 Radio and
 Television
KNOBs

Ceramic
 Stand-off, Feed Thru,
 & Tie Terminals
 Army-Navy Approved



Designers-Engineers

• **KNOB**s • **PLASTIC EMBOS**SING • **TERMINALS**

4739 Montrose Ave.

Chicago 41, Ill.

Bliley 100 KC FREQUENCY STANDARD

THE Bliley BCS-1A Frequency standard provides a 100 KC frequency source with stability approaching that of a primary standard. This high stability reference instrument is ideally suited for research, development and industrial laboratories working on electronic applications.



PERFORMANCE: The BCS-1A instrument maintains a stability over a twenty-four hour period of TWO PARTS IN TEN MILLION, even with line voltage fluctuations up to ten percent. The long term stability is two parts in one million over any thirty day period without resetting. Rugged construction assures reliable operation over adverse service conditions, including wide ambient temperature and air pressure changes, humidity, and line voltage fluctuations. Special emphasis has been placed on long service life features which include the use of high rated capacitors and resistors, and the use of red base 10,000 hour tubes in the oscillator section, the gain control circuit and the buffer circuit.

APPLICATION DATA: The BCS-1A has a self-contained power supply for operation on 110 volts AC, 60 cycles. The standard instrument is provided with dust covers and a 19" panel for rack mounting. Shipping weight: 36 pounds. Cabinet mounting for the BCS-1A is available on special order. Please specify.

Bliley ELECTRIC COMPANY
UNION STATION BLDG. • ERIE, PA.

THE WORLD'S LEADING TWIN LEAD TELEVISION LIGHTNING ARRESTER

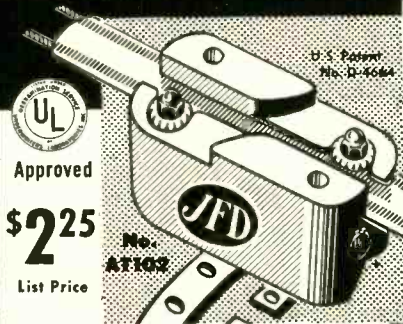

JFD completely waterproof
SAFE TV GUARD

Protects television sets against lightning and static charges. Simple to install everywhere and anywhere... no stripping, cutting or spreading of wires. More than 500,000 in use today!

See your jobber or write to —

JFD MANUFACTURING CO., INC.
6154 16th Ave., Brooklyn 4, New York
FIRST in Television Antennas and Accessories

Connect small control wiring in one simple operation!

CURTIS TYPE "E" TERMINAL BLOCKS

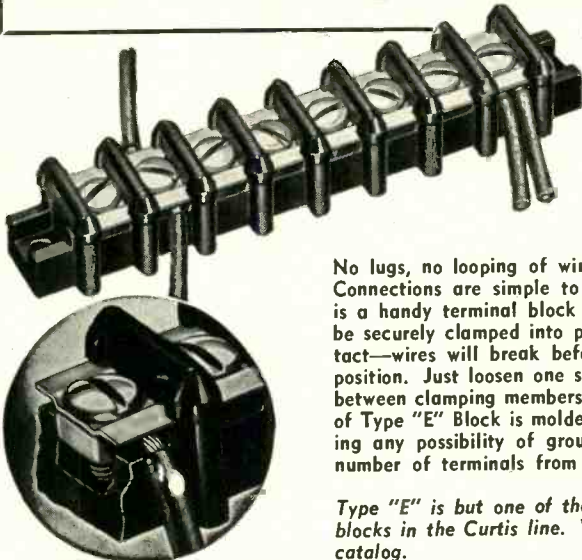

For
#18 Stranded
or
#16 Solid Wire
or Smaller

No lugs, no looping of wires, no screws to remove. Connections are simple to make. Curtis Type "E" is a handy terminal block that allows two wires to be securely clamped into position with positive contact—wires will break before they can pull out of position. Just loosen one screw, insert stripped wire between clamping members and tighten screw. Body of Type "E" Block is molded in solid form, eliminating any possibility of grounding. Available in any number of terminals from 1 to 22.

Type "E" is but one of the many types of terminal blocks in the Curtis line. Write today for complete catalog.

CURTIS DEVELOPMENT & MFG. CO.

Terminal Block Sales—4536 W. Madison St., Chicago 24, Ill.
Factory—Milwaukee 16, Wisconsin

JFD



Pioneers In The Radio Parts and Antennae Industries Since 1929

Your SINGLE Source of Supply For Radio and Television Parts and Accessories...

JFD manufactures the world's largest selection of items for the Radio and Television servicing trade. Why shop around when you can get what you want, when you want it, and at the price you want to pay, from ONE single, dependable source of supply?



LIGHTNING ARRESTERS • DETENTS • SNAP-ON STAND-OFFS • TOGGLE SWITCHES • ANTENNA LOOPS • AUTO ANTENNAS • BATTERY PLUGS • NOISE FILTERS • DIAL POINTERS • SUPPRESSORS • RADIO WIRE • DIAL BELTS • TEST LEADS • DIAL CORD • "SOCKETTE" RADIO TUBE ADAPTERS • EXACT DUPLICATE BALLAST TUBES • SERVICEMEN'S ALIGNMENT TOOLS • TELEVISION & F-M ACCESSORIES • FLEXIBLE SHAFTING & CASING • BATTERY ADAPTER HARNESSES • STEPDOWN RESISTANCE CORDS • RESISTANCE CORD ADAPTERS • SPEAKER CEMENT & SOLVENT • TELEVISION & F-M BRACKETS • TELEVISION & F-M ANTENNAS • REMOTE-CABLE REPLACER • PHONO ADAPTER SWITCHES • MICROPHONE CONNECTORS • TELEVISION & F-M LEADS • STEPDOWN TRANSFORMERS • WIRE WINDING MACHINES • TELEVISION & F-M WIRE • AUTO RADIO FITTINGS • BAKELITE DIAL KNOBS • PHONOGRAPH NEEDLES • RADIO TUBE SOCKETS • NEUTRALIZING TOOLS • STEPDOWN BALLASTS • RESISTANCE CORDS

Write Today for Complete JFD Radio and Television Catalogs.

JFD MANUFACTURING CO., Inc.
6154 16th AVENUE, BROOKLYN 4, N. Y.
FIRST in TELEVISION ANTENNAS AND ACCESSORIES

"The 'Exclusiveness' Of JFD Is The Quality Of Its Products"

CHASSIS and DUST COVERS

**ARMY-NAVY
SPECIFICATION
JAN-C-172A**

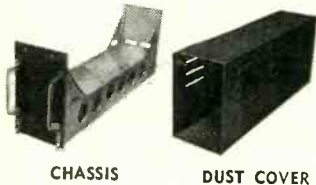

POTENTIAL USES
Aircraft Equipment
Industrial Electronics
Marine Equipment
Portable Test Equipment
Radar Apparatus
Radio Apparatus
Sound and Signal Systems

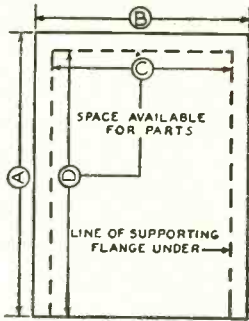

DECK PLATE PLAN-FIG. 1

On standard types, dimension from bottom of chassis to under surface of deck plate is 2 15/16" — on specials it is 1 1/4" minimum.

MATERIAL
SAE201—1/2 H Aluminum
SAE30915 Stainless Steel

JAN DESIGNATION	APPROX. DIMEN.			FIG. 1 DIMENSIONS			
	W	H	L	A	B	C	D
A1-C	5	7 1/8	15 1/2	15 1/2	4 1/2	3 3/8	14 3/4
A1-D	5	7 1/8	19 1/2	19 1/2	4 1/2	3 3/8	18 3/4
B1-B	10 1/4	7 1/8	12 1/2	12 1/2	9 3/4	8 3/8	11 3/4
B1-C	10 1/4	7 1/8	15 1/2	15 1/2	9 3/4	8 3/8	14 3/4
B2-C	10 1/4	10 7/8	15 1/2	15 1/2	9 3/4	8 3/8	14 3/4
B1-D1	10 1/4	7 1/8	19 1/2	19 1/2	9 3/4	8 3/8	18 3/4
B1-D2	10 1/4	7 1/8	19 1/2	19 1/2	9 3/4	8 3/8	18 3/4
B2-D1	10 1/4	10 7/8	19 1/2	19 1/2	9 3/4	8 3/8	18 3/4
B2-D2	10 1/4	10 7/8	19 1/2	19 1/2	9 3/4	8 3/8	18 3/4
C1-C	15 1/2	7 1/8	15 1/2	15 1/2	15	14 1/2	14 3/4
C2-C	15 1/2	10 7/8	15 1/2	15 1/2	15	14 1/2	14 3/4
C1-D	15 1/2	7 1/8	19 1/2	19 1/2	15	14 1/2	18 3/4
C2-D	15 1/2	10 7/8	19 1/2	19 1/2	15	14 1/2	18 3/4
S-1	5 1/8	7 3/8	9 3/8	9 3/8	4 1/4	3 1/4	8 1/4
S-2	4 3/8	7 3/8	13 3/8	12 3/8	4 1/4	3 1/4	12 3/8

FINISH—Chassis: Aluminum anodized, Front panel black wrinkle on face and edges, Hold-down hooks stainless steel passivated.

DUST COVER Aluminum anodized, Black wrinkle outside, Flat black bake inside

• SPECIAL UNITS FURNISHED TO CUSTOMER'S SPECIFICATIONS •

CHURCHILL CORP.

7 NORTH AVENUE
WAKEFIELD, MASS.

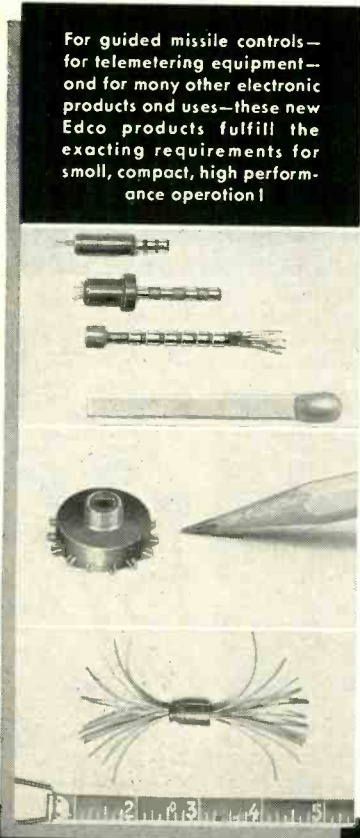

For guided missile controls— for telemetering equipment— and for many other electronic products and uses—these new Edco products fulfill the exacting requirements for small, compact, high performance operation!

Tiny, new **EDCO**

MINIATURE COMPONENTS

SLIP RINGS—These incredibly small Edco slip rings are smooth, highly polished to reduce friction—and Rhodium plated to retain their lustre and reduce wear—they're sturdy and tested to 1,000 volts.

SWITCHES—Edco rotary switches are less than 1/10th the size of conventional switches. Completely versatile for use in complex circuits—maximum of 15 positions, 1, 2 or 3 poles.

CONNECTORS—Pressure tight—12 No. 27 gauge coated conductors—dia. 3/8"—length 2 1/2"—contacts, silver and gold plated brass. Positive polarization.

ELECTRO DEVELOPMENT CORP.
6014 W. Washington Blvd., Culver City, Calif.

WRITE NOW for complete literature and prices to...

Hold on to this book

It will be
June 1952
before another
edition is published

IT IS THE MOST COMPLETE,
AUTHORITATIVE AND UP-TO-DATE
DIRECTORY OF ELECTRONIC AND
ALLIED PRODUCTS AVAILABLE.

It gives you the manu-
facturers of each of
more than fourteen
hundred electronic
and allied products.



... gives you information
as to where they are in pro-
duction or available in a
reasonable time and unre-
stricted for general indus-
trial use.

1951-1952

electronics BUYERS' GUIDE

Please mention this book when
buying or inquiring from it.

*Waltham
Horological*

MANUFACTURING & DELIVERING
ON TIME — AS PROMISED
Made to Army-Navy Specifications

RF CONNECTORS
in wide variety

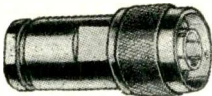
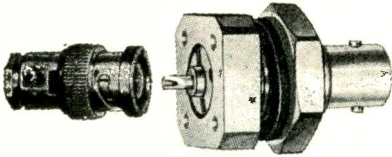
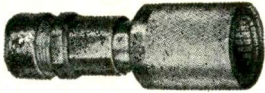

TELEPHONE PLUGS
Many Types



Turret Type
Terminal Lugs and Boards

SWISS
Screw Machine Products

STRICT ADHERENCE TO
MILITARY & CONTRACT
SPECIFICATIONS

Field Engineers Available to help you

Further Details on Request

WHC

**WALTHAM
HOROLOGICAL**

CORPORATION
899 Main Street

Waltham 54, Mass.

Telephone: Waltham 5-4105

D. C. POWER SUPPLIES

Selenium Rectifier Power Units Power Conversion For

- Production and laboratory testing of D.C. apparatus from A.C. power lines, allowing continuous variation of D.C. voltage and current to simulate changing battery or line voltage conditions.
- High current selenium rectifier plate power supplies.
- Commercial operation of D.C. motors, dynamotors, vibrator power packs, relays and other devices which require D.C.
- Replacing storage or primary batteries
- Battery charging
- Electrolytic processing and electroplating

INPUT: 115 volts, 60 cycle, single phase

OUTPUT: (Variable) 0-30 volts at up to 24 Amperes of Filtered D.C.

RECTIFIER: Full wave bridge selenium stack.

FILTER: Single section choke input followed by capacitor. 3% ripple, excellent regulation

\$350.00

Net F.O.B. Brooklyn

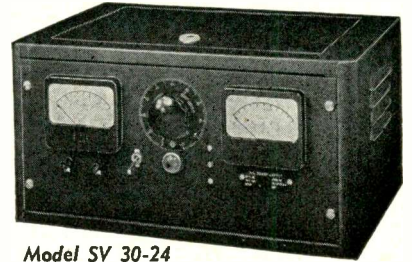

Model SV 30-24

This unit is representative of one of the types we supply. The majority of D.C. power supplies we manufacture are designed to the exact requirements of the user, thereby achieving superior results, yet effecting maximum economy. Prompt delivery of units for your specific job. Thousands of our power supplies now in service attest to the quality and durability of our equipment.

Upon receipt of your requirements we will promptly furnish quotations.

MODEL RECTIFIER CORP.

1510 Nostrandt Ave.

Brooklyn 26, N. Y.

Tel. BUckminster 7-0029

Under One Roof!

THE WORLD'S
FINEST ELECTRONIC
PARTS AND
EQUIPMENT

The **LUKKO SALES Corp.**

ASTATIC

STANBOR

MALLORY

AEROVOX

RCA

Flickox

Simpson

AMPHENDL

IRC

ElectroVoice

Cinch Jones

Meissner

OHMITE

TRIPLET

PRECISION

LSC
EST. 1922

GE

Centralab



LUKKO SALES CORPORATION

5024 IRVING PARK RD., CHICAGO 41, ILLINOIS

Just off the Press! Write, wire or phone
for your copy of our new 1951 Catalog.

Jensen

SHURE

Rauland

BUD

The Lundey Line

HERMETIC TERMINAL ASSEMBLIES*

Developed at Raytheon Manufacturing Company in 1942 to meet military specifications, and in continuous production since its inception, the Lundey Line is a contained insert type of hermetic lead-through terminal assembly.

As a result of continued engineering and research, these terminals have proved to be particularly applicable to the following components: transformers, capacitors, oil-immersed selenium rectifiers, sealed motors and motor/compressor assemblies and relays.

FEATURES

Stability under high mechanical and thermal shock.

Wide variety of styles for most applications:

Diameters (base) from 3/16" to 2 7/8"

Temperature range from -70°C to +200°C

Voltages to 40 KV operating

Amperages to 250 operating (semi-special to 500 amps.)

Maximum flexibility of electrode types and materials
 long life freedom from surface tracking tendencies.

We have national representation and offer field engineering service when required.

Lundey Associates

WALTHAM 54, MASSACHUSETTS

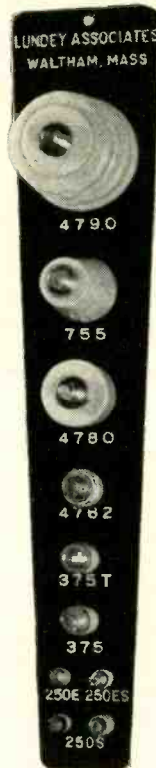

*U. S. Patent
 2,447,489
 Canada 435,516

A COMPLETE LINE OF EXPERTLY DESIGNED ELECTRONIC COOLING COMPONENTS



AIRFLOW INTERLOCK SWITCHES

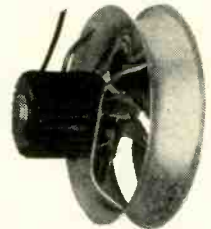

CABINET FLUSHING FANS



MINIATURE BLOWERS AND FANS



HI-PRESSURE LIGHTWEIGHT BLOWERS SPECIALLY ADAPTED TO VARIOUS TUBES



HI-VELOCITY BLOWERS MATCHED TO STANDARD TRANSMITTING TUBES

Write for complete catalogue including valuable data sheets

ROTRON MFG. CO.

ENGINEERING SALES OFFICE
 7-9 Schoonmaker Lane
 WOODSTOCK, N. Y.

ATOMIC MODEL 510 Pulse Height Analyzer

Choice of top-flight research laboratories

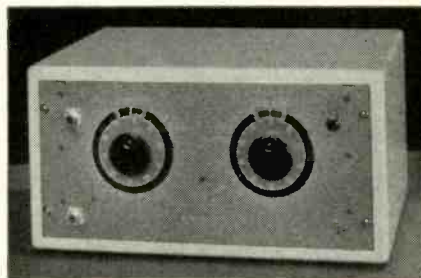

Choose the instrument that's desired by leading laboratories everywhere—the Atomic Differential Pulse Height Analyzer. A truly precise instrument built especially for fine research, the Model 510 makes it possible for you to study amplitude distribution of electrical impulses in the range from 0-100 volts. Used with linear or calibrated particle detecting device, linear amplifier and a scaler or any other counting means, the Model 510 makes your study of the energy distribution of nuclear particles easier and more efficient.

Precise upper and lower level voltage controls permit formation of a narrow adjustable channel through which only input pulses of desired amplitude may pass and be transmitted to output. Many other outstanding features. Bulletin on request. Power supplies—Models 306, 316, 326 . . . low current, low energy . . . negative or positive grounded . . . suitable for most research work . . . 500-3000 volts

Scaler—Model 1060 Multiscaler—latest Atomic Scaler . . . one of famous "Building Block" Scalers. No other quite matches it. Write for details—also for Model 1070 with built-in linear amplifier.

Anticoincidence Analyzer—Model 503B . . . new, yet proven in heavily shielded counting of extremely weak activities with short or long half-life . . . built-in register . . . register drive circuit . . . many other exceptional features

Linear Amplifier—Model 204C . . . selectable input time constant and rise time . . . built-in discriminator.

Count Rate Survey Meters—Model 409 and 410 . . . 409 has 5% accuracy . . . small-size—ideal for routine laboratory contamination monitoring. 410 has 2% accuracy . . . use with geiger probe input or alpha scintillation probe.

Scale of 64—Model 101M . . . includes vacuum tube diodes and built-in precision discriminator.

Scaler—Model 1010 Series . . . Atomic's "Building Block" Scalers . . . many types with choice of decade or binary scale . . . custom features at production prices.

Write for free indexed catalog.

ATOMIC INSTRUMENT COMPANY
 84 MASSACHUSETTS AVE. CAMBRIDGE 39, MASS.

ALLISON RADAR

NAVIGATIONAL AID
For MULTI-ENGINE
TRANSPORT AIRCRAFT
& HELICOPTERS
MILITARY—CIVIL

**SMALL—COMPACT
LIGHTWEIGHT
EFFICIENT**

**SEES Thru FOG
DAY and NIGHT**

- Sees Thunderstorm, Cores, Snow, Hail, Rain in advance.
- Promotes smoother flying for passenger safety and comfort.
- Warns of approaching aircraft in line of flight.
- Sees obstructions in true outline and/or direction.

**ALLISON
RADAR CORPORATION**
11 W. 42 St. N.Y. 18 PEnn 6-5811-12

This Year
The
BUYERS' GUIDE
inaugurates
A
Where-to-find-it Guide
to the

1930-1939
electronics'
editorial
contents

A cumulative editorial
index to the first ten
years of **ELECTRONICS**
Pages C-1 to C-36

Next ten years in next
year's **GUIDE**.

Engrave

... PANELS UP TO **25"** WIDE
IN YOUR OWN SHOP WITH THE
NEW ENGRAVOGRAPH

Portable Model 1-S

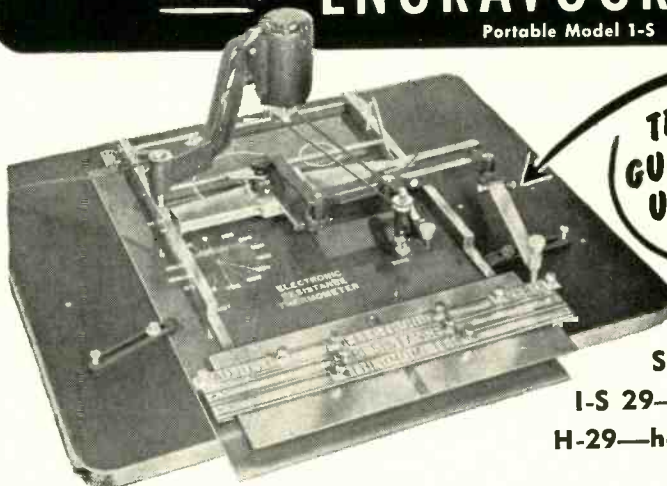

**TRACER
GUIDED FOR
UNSKILLED
LABOR**

Send for Booklets
I-S 29—portable model
H-29—heavy duty model

NEW HERMES, Inc. • 13-19 University Place, New York 3, N. Y.
CANADA: 359 St. James St., Montreal

new hermes
Engravo
graph

- The only portable machine which reproduces 15 sizes from one master alphabet.
- The only one with adjustable copy holding slides for multiline engraving in one set-up.
- Self-centering holding vise for nameplates and dials.

NEW HERMES, Inc. • 13-19 University Place, New York 3, N. Y.
World's Largest Manufacturer of Portable Engraving Machines

Send for **NEWARK'S NEW**
160 PAGE CATALOG



THE MOST
COMPLETE CATALOG
IN THE INDUSTRY

Foremost Distributor of
ELECTRONICS EQUIPMENT
FOR INDUSTRY • LABORATORIES
INSTITUTIONS • BROADCAST
AND THE ENTIRE RADIO, TV AND ELECTRONICS FIELD

- ★ Complete Lines
- ★ Widest Selections
- ★ Nationally Known Manufacturers

NEWARK
ELECTRIC COMPANY
323 WEST MADISON STREET
CHICAGO 6, ILLINOIS PHONE STate 2-2950

to the most exacting specifications -

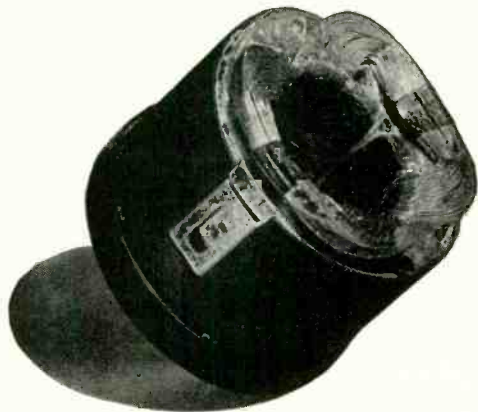

DEFLECTION YOKES and ELECTRONIC COMPONENTS

Our large plant in a low-cost labor market assures YOU of better delivery, better production, lower cost.

We now serve many satisfied customers . . . why not you?

We are experienced in manufacturing Deflection Yokes to meet the most exacting requirements of the leading manufacturers. Our experience and modern facilities are available to produce electronic components for military or manufacturing operations.

We invite your inquiries and specifications for quotation.

Tel-Rad Mfg. Co., Inc.

RADIO and TELEVISION COMPONENTS

PHONES: Office 270

Purchasing Dept. 271

7 Madison Street—Fennimore, Wisconsin



BEAM for quality products



Cossor
Double Beam
Precision
Oscillographs

Model 1035 General Purpose instrument

- Double beam C.R.T., flat 90 mm screen.
- Time base has directly calibrated time scale, 15 microseconds—150 milliseconds in 9 ranges. Repetitive or triggered operation, internal or external synch. by selection, suppressed fly-back, calibration waveform provided.
- Y1 Amplifier. Response 7 mcs. to 20 c.p.s. directly calibrated voltage scale with 7 ranges.
- Y2 Amplifier. 100 Kcs. to 20 c.p.s. directly calibrated voltage scale with 5 ranges.
- All necessary circuitry accessible on front or side panels.

Model 1019 Oscillograph with D.C. Amplifiers

- Double Beam flat face C.R.T. 90 mm dia.
- Time base. Directly calibrated time scale, response 150 microseconds to 1.5 seconds in 9 ranges. Internal or external synch., repetitive, triggered or single stroke T.B. operation, by selection.
- Y1. D.C. Amplifier. D.C.—100 Kcs., with directly calibrated Y shift control. Gain 900.
- Y2. D.C. Amplifier. Calibrated switch attenuator for Y2 sensitivity. Gain 25.
- Beam Trigger operation facilities, off, electrical and time marking, mechanical sources and from power supply or push button.
- All necessary circuitry accessible on front or side panels.

MODEL 1037 (Portable). A general purpose double beam oscillograph. Y1 amplifier direct coupled. Y2 amplifier A. C. connected. Power supply: 80-230 VOLTS INPUT AT ANY FREQUENCY FROM 25 TO 3400 CYCLES.

MODEL 1428 — Camera. Manual or power driven.

MODEL 1429—Motor drive for camera.

MODEL 1430—D. C. amplifier. (Trolleys and usual accessories available.)

Vacuo Junctions (Thermocouples)

Best Products,
U.H.F. Types—5 MA. to
1000 MA.
Standard Types—1.25 MA.
to 1000 MA.



Toroidal Powder Iron Cores in a wide variety of types and sizes for use over a broad range of frequencies.

Wound Toroidal Coils available with taps and multiple windings; cased or uncased according to your specifications.

Electric-Wave Filters of low-pass, high-pass, band-pass and band-rejection types. Response characteristics and housings to your specifications. Hermetically-sealed units illustrated.

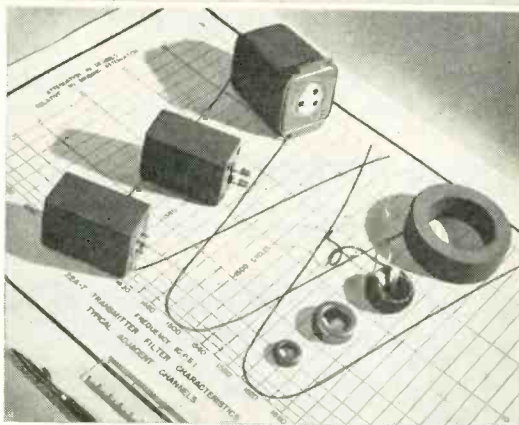

Let Lenkurt help with your special core and coil problems; write:

Lenkurt

LENKURT ELECTRIC CO.
SAN CARLOS • CALIFORNIA

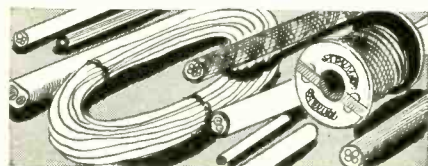

Wires and Cables

A full range of electrical and radio wires and cables available. Manufactured by Sterling Cable Company.

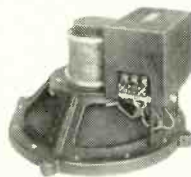

Tannoy Audio Equipment

Tannoy dual concentric loud speaker systems with cross-over networks. Substantially flat response between 40 and 20,000 cycles. 15" and 12" diameter models. Also fidelity response microphones, loud speaking microphones, etc.

See Your Jobber or write for complete descriptive literature to:

BEAM INSTRUMENTS CORPORATION

350 Fifth Avenue New York 1, N. Y.

Tel. LO 4-0844

STABILITY

HUNT CR-7 CRYSTAL

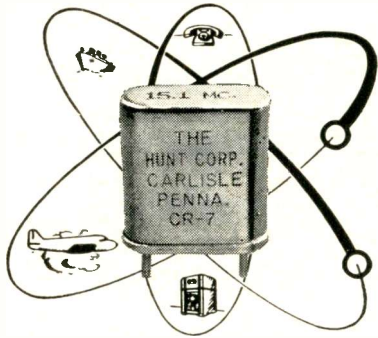

Miniature Type CR-7
Crystal Unit

(Illustration is actual size)

THE Hunt
CORPORATION

CARLISLE 2, PENNSYLVANIA

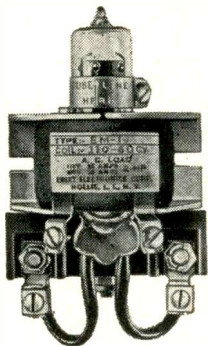

**Plunger Type
MERCURY
RELAYS**

UL APPROVED

★ **POSITIVE**—Hermetically sealed mercury-mercury contact assures silent flickerless operation . . . no pitting, no sticking!

★ **DEPENDABLE**—Hermetically sealed . . . no dust, no dirt, no oxidation . . . means no servicing, no cleaning!

They ALWAYS Work

Available in single, double and triple groups operated by one coil. Coil ratings for every application. Contacts rated conservatively at 35 Amp. 115 V. AC; 25 Amp. 220 V. AC. Available normally open or normally closed.

Write for Catalog

EBERT ELECTRONICS CO.

185-09 Jamaica Avenue, Hollis 7b, L. I., N. Y.

THE MOST COMPLETE LINE OF

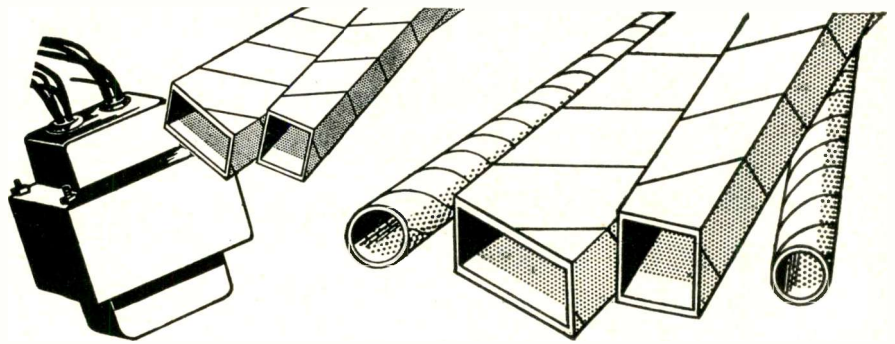

**PAPER, CELLULOSE ACETATE, GLASS CLOTH
and ASBESTOS TUBES***

KRAFT	for Class A transformers . . . immediate delivery on standard sizes
CELLULOSE ACETATE	made in all cellulose acetate or laminated on Kraft
* QUINTERRA	Johns-Manville insulating materials
* QUINORGO for Class B & H transformers
GLASS CLOTH	silicone impregnated glass cloth . . . for temperatures up to 300° C.

Square, rectangular and round tubes in any of the above materials . . . full range of sizes . . . square and rectangular tubes from 1/16" x 1/8" to 10" x 10" . . . round tubes from 1/4" ID to 1" ID.

ACCURATE PAPER TUBE CO.

853 N. NOBLE ST.

CHICAGO 22, ILLINOIS

PLATINUM

and other

PRECIOUS METALS
in Wire Ribbon Foil & Tubing

J. A. SAMUEL & CO., INC

220 Broadway, New York 38

Telephone: COrtlandt 7-4567

HEPPNER for Precision Parts . . .

• CIVILIAN • MILITARY

Facilities and "KNOW HOW" for Prime and Sub-Contracts.

Our own tool shop—presses, winding equipment, vacuum impregnation, welding, silver plating.

Present Civilian Products—Ion Traps—Radio Loud Speakers—PM Focusing Devices—Centering Devices for Electrostatic Tubes—Horizontal Output Transformers.

Present Military Products—Machine Gun Heaters—Shock Mounts—Cord Assemblies—Coils.

For further information call or write:

HEPPNER MFG. CO.

ROUND LAKE, ILLINOIS

Powder Metal

- PERMANENT MAGNETS
- MAGNETIC IRON TOROIDS
- THREADED CORES
- CUP CORES
- FILTER CORES
- RADAR CORES
- ANTENNA CORES
- COMMUNICATION IRON CORES

Contact us for samples and engineering information.

MAGNETIC CORE CORP.

Manufacturers of Electronic Powder Metallurgy

142 SOUTH HIGHLAND AVENUE, OSSINING, NEW YORK
Ossining 2-0222

DEPENDABLE

D. C. POWER SUPPLY

FULL WAVE SELENIUM RECTIFIER

INDUSTRIAL, GOVERNMENT
ELECTRONIC & RESEARCH

PRODUCTION LINE TESTING



D. C. OUTPUT: 24 to 32 volts, 30 amperes. Continuously variable by rheostat control. Six-phase connections.
A. C. INPUT: 220 volts, 3 phase, 60 cycles.
REGULATION: $\pm 4\%$.
RESPONSE TIME: 0.4 second.
DIMENSIONS: 18"x14"x15".
CABINET: Aluminum.
WEIGHT: 150 lbs.
PRICE: Model A (D. C. Ripple 1½%) \$410.00; Model B (D. C. Ripple 3%) \$360.00.



RICHARDSON-ALLEN
CORPORATION
RECTIFIER SPECIALISTS



116-15 15TH AVE., COLLEGE POINT, L. I., N. Y.

MANUFACTURERS • RESEARCH and DEVELOPMENT ENGINEERS

Rectifiers - Switches - Electronic Timers - Oscillators - Saturable Reactors

Want to know about the...

AUGETRON

ECCLES-JORDAN CIRCUIT

KATHETRON TUBE

MEKAPION TUBE

PERMATRON

PETOSCOPE

SCHLIEREN METHOD

SCOPHONY

SEMAGRAPH

SIRUFER

SYNDEC

THEREMIN

TRATONIUM

VODER

or other early electronic developments?

You can find out about
them in the early issues
of **ELECTRONICS**.

The cumulative index to
ELECTRONICS' first decade,
pages C-1 to C-36
in this book, tells you
where to look.

Long Life - High Speed

COIL WINDING MACHINES

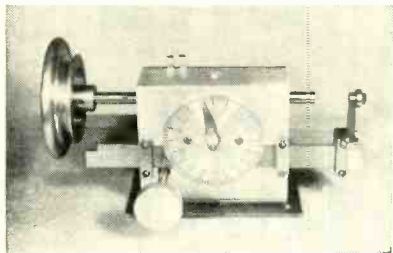

Model B

Designed specifically for the rapid production of all types of single layer coils; this machine is being used for the winding of low inductance and resistor type components on both flat and round or rectangular forms.

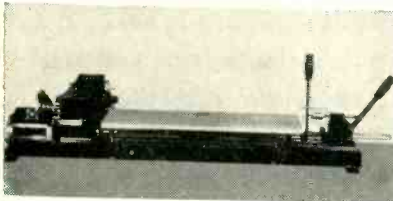

Model AL

This model is designed for the winding of all types of coils in which paper is inserted between layers. It combines unusual original accuracy with provision for adjustment when wear occurs. Micrometer adjustment of traverse is but one of the many features not found on machines costing many times as much.

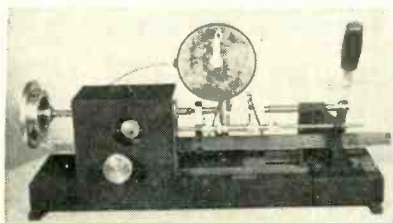

Model W

Model W is used for the manufacture of all types of lattice and pi wound coils, progressive universal, space wound, and hand wound solenoids without extra attachments. It also winds small layer wound coils of all descriptions, including filter chokes, transformers, speaker voice coils and field coils, as well as machine spaced bobbin type coils, small motor fields, etc.

Eleven other models not illustrated are available for special applications.

COIL WINDING EQUIPMENT CO.

37 West Main St., Oyster Bay, N. Y.
Tel. Oyster Bay 6-1285

LOJACK TRANSFORMER CASES

DESIGNED TO MEET MIL-T-27 CASE DIMENSION SPECIFICATIONS

1. MOUNTING STUDS SPOT WELDED AND TERMINAL HOLES PUNCHED TO SPECIFICATION
2. WRAP-AROUND CASE BODY WITH SPOT WELDED SEAM
3. CONTINUOUS COVER STOPS AND SOLDER BARRIER
4. TAPERED INSIDE COVERS

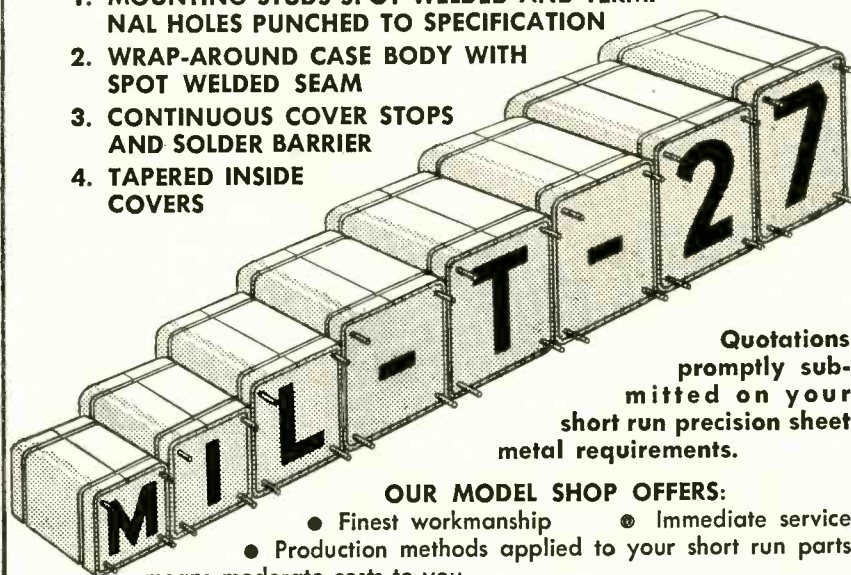

Quotations promptly submitted on your short run precision sheet metal requirements.

OUR MODEL SHOP OFFERS:

- Finest workmanship
- Immediate service
- Production methods applied to your short run parts means moderate costs to you.

LOJACK PRECISION CORPORATION

32-60 62nd ST., WOODSIDE, N. Y.

RA 8-7543

Here's Why it Pays You . . . to Read the Advertising

The advertising is a rich source of valuable information. In this magazine it offers you ideas and products that may well apply advantageously to your business.

Every issue is a catalog of goods, materials, and services — quickly available to you — just for the reading.

Leaders in business and industry turn to the advertising because they've discovered it helps them run their businesses more profitably.

When you read all the ads in this magazine, the chances are good that you'll get a lead that will materially help you do a better job. For example, you may find a specific piece of equipment that will be a profitable time-saver. Or a tool that will increase worker efficiency. That's why it pays to read the advertising. It's good business.

HEADQUARTERS FOR BUSINESS INFORMATION

McGRAW-HILL publications

STEP-UP
Soldering Operations
on your
Production Line
 by
15%

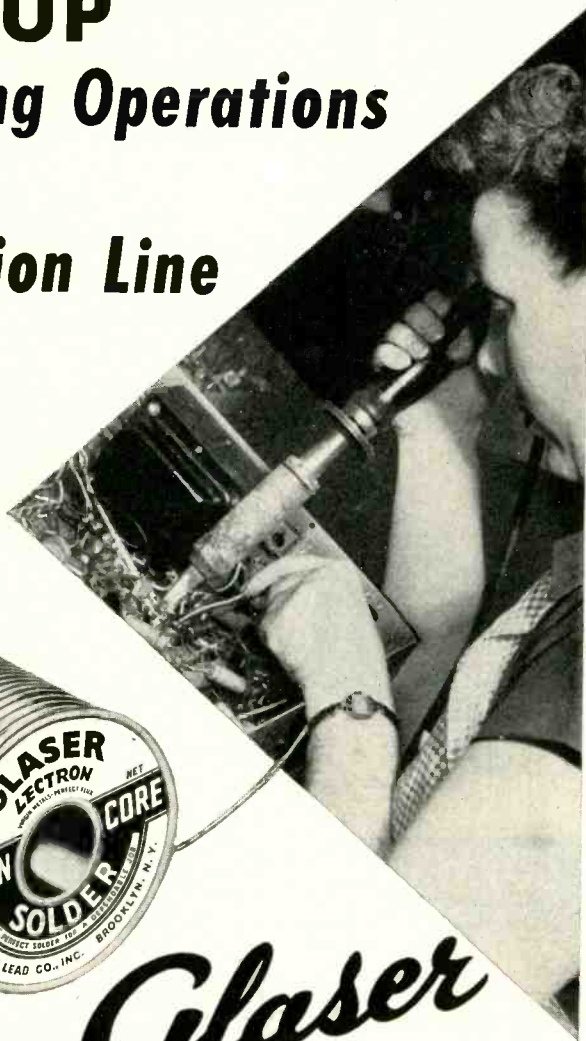

Glaser
LECTRON
ROSIN CORE
SOLDER

Every month, production on TV, radio, and electronic equipment is pushed to greater volume. To help meet this increased demand, engineers and production chiefs, from coast to coast, are specifying and insisting upon GLASER LECTORON ROSIN CORE SOLDER. They agree, GLASER LECTORON is the best* activated rosin core solder for speeding soldering operations.

Made with an exclusive activated rosin flux, GLASER LECTORON ROSIN CORE SOLDER is more efficient and faster than plain rosin core solder. Bonds copper and brass and other metals perfectly and permanently—yet is non-corrosive and non-conductive.

*Satisfied users of Glaser Lectoron Rosin Core Solder report gains of 15% or better in soldering speed on their production lines.

GLASER PLASTIC ROSIN CORE SOLDER

Both Glaser Lectoron Rosin Core and Glaser Plastic Rosin Core Solders are made of virgin tin and lead and perfect flux. Available in any tin-lead alloy and wire gauge.

Write our Engineering Department for assistance on any of your soldering or flux problems.

GLASER LEAD CO. INC.

21-31 WYCKOFF AVENUE, BROOKLYN 27, N. Y.



RENDERING DEPENDABLE SERVICE TO AMERICAN INDUSTRIES SINCE 1922

THIS IS THE

ONE
BOOK

THE ONLY
 ONE OF ITS KIND

In which design engineers and purchasing agents will find a complete, accurate, and up-to-date list of the manufacturers of all types of electronic and allied products... components and complete equipment.

Keep it handy for ready reference throughout the year.

When buying, or requesting product information be sure to mention...

electronics
BUYERS'
GUIDE

PROFESSIONAL SERVICES

GEORGE P. ADAIR

Consulting Radio Engineers

Quarter Century Professional Experience
Radio-Television-Electronics-Communications
1833 M Street, N. W., Washington 6, D. C.
Executive 1230 — Executive 5851
(Nights-Holidays, Lockwood 5-1819)
Member AFCEE

Consulting Engineers can give needed advice regarding most any problem for they see each separate department in its relations to the whole plant—and they sell nothing but their broad experienced services.

PICKARD AND BURNS, INC.

Consulting Electronic Engineers

Analysis and Evaluation of Radio Systems
Research, Development & Design of Special Electronic Equipment
240 Highland Ave., Needham 94, Mass.

CROSBY LABORATORIES, INC.

Murray G. Crosby & Staff

Radio-Electronic Engineering, Research & Development
FM, Communications, TV Test Equipment
Offices, Laboratory & Model Shop at:
126 Herricks Rd., Mineola, N. Y.
Garden City 7-0284

R. W. HODGSON

PATENT-INVENTION RESEARCH & DEVELOPMENT ENGINEER SPECIALIZING IN ELECTRONICS

Gadget-of-the-Month Club Bldg.
6800 Lexington Ave., Hollywood 32, Calif.
All mail to Box 874, Sherman Oaks, Calif.
GLadstone 9680 HUDson 2-2311 STate 4-9318

ROBERT G. REED

Electronic Engineer

7446 Schoyer Ave., Pittsburgh 18, Pa.

DUBROW DEVELOPMENT CO.

Design — Development — Mfr.

Quality Electronic Equipment
347 High St., Burlington, N. J.
Burlington 3-0446

McINTOSH & INGLIS

Consulting Radio & Television Engineers

Design, Installation, Research
710 14th Street N. W., Washington 5, D. C.
Metropolitan 4477

The Robert H. Streeter Co.

Electronic Design Specialists

Engineering Consultants
Representing Manufacturers of Electronic Equipment in Southern United States
Specialists in the design and construction of specialized pieces of equipment for specific applications
Tel. 97 Greenwood, Miss.

EDGERTON, GERMESHAUSEN & GRIER, INC.

Consulting Engineer

Research Development and Manufacture of Electronics and Stroboscope Equipment
Specialists in High-Speed Photography
160 Brookline Avenue, Boston 15, Mass.

MEASUREMENTS CORPORATION

Research & Manufacturing Engineers

Harry W. Houck Jerry B. Minter
John M. van Beuren
Specialists in the Design and Development of Electronic Test Instruments
Boonton, N. J.

THE TECHNICAL MATERIEL CORPORATION

Communications Consultants

Systems Engineering
General Offices and Laboratory
121 Spencer Place, Mamaroneck, N. Y.

ELECTRONIC ENGINEERING CO. of CALIFORNIA

Radio and Electronic Consulting and Designing.

180 S. Alvarado Los Angeles
DUNKirk 2-7353 California

Eugene Mittelman, E.E., Ph.D.

Consulting Engineer & Physicist

High Frequency Heating—Industrial Electronics
Applied Physics and Mathematics
549 W. Washington Blvd. Chicago 6, Ill.
State 2-8021

TELECHROME, INC.

Electronic Design Specialists

COLOR TELEVISION EQUIPMENT
Flying Spot Scanners, Color Synthesizers, Keyers, Monitors, Oscilloscopes and Related Apparatus
J. R. Popkin-Curman, Pres. & Ch. Engr.
88 Merrick Rd. Amityville, L. I., N. Y.

ERCO RADIO LABORATORIES, INC.

Radio Communications Equipment

Engineering - Design - Development - Production
Pioneers in Frequency Shift Telegraph
Garden City • Long Island • New York

National Radio Research Laboratories

Consulting Electronic & Mechanical Engineers

RECORDING DESIGN CONSULTANTS TO THE FILM & DISK INDUSTRIES
Communications Equipment Designs, Electromedical Instrument Development
Industrial Electronic Controls
74 West 68th Street New York 23, N. Y.
TRafalgar 7-4443

ALFRED W. SUTTER

Purchasing Engineer

PURCHASING • EXPEDITING • CONTRACT NEGOTIATIONS
CONSULTING AND ADMINISTERING Systems and Methods • Inspecting Facilities Surveys • Budgets
141 E. 44th St., N. Y. 17, N. Y. Murray Hill 2-2655

HERMAN LEWIS GORDON

Registered Patent Attorney

Patent Investigations and Opinions
Warner Building, Washington 4, D. C.
NAtional 2497

NIAGARA ELECTRON LABORATORIES

CONSULTATION - DESIGN - CONSTRUCTION MFG. THE THERMOCAP RELAY

Specializing in solution of problems of electronic and electro-physical instrumentation for the research or analytical laboratory. Industrial plant problems also invited.
Andover, New York Cable Address: NIATRONLAB

FREDERICK P. WARRICK

Engineering Consultant

Development & Manufacture of High Speed Moving Film Cameras for Oscillography & Stroboscopic Photography.
1960 Graefield Road Birmingham, Michigan

HANSON-GORRILL-BRIAN INC.

Products & Mfg. Development

ELECTRICAL - ELECTRONIC
HYDRAULIC - MECHANICAL

One Continental Hill Glen Cove, N. Y.
Glen Cove 4-1922

GEORGE A. PHILBRICK

Research & Development Consultant

Regulating and Computing Instruments; Feedback Techniques and Applications.
Affiliated with
G. A. Philbrick Researches, Inc.
230 Congress St., Boston 10, Mass.

WHEELER LABORATORIES, INC.

Radio and Electronics

Consulting—Research—Development
R-F Circuits—Lines—Antennas
Microwave Components—Test Equipment
Harold A. Wheeler and Engineering Staff
Great Neck, N. Y. Great Neck 2-7806

S. V. HART ASSOCIATES

Design and Construction of Industrial Electronic Equipment

Photo-electric applications. Automatic Gaging.

8430 Grand River Ave. Detroit 4, Mich.
TYler 7-2342
Write for brochure entitled "Electronics in the Factory"

PHYSICAL RESEARCH ASSOCIATES

Consulting Physicists & Engineers

Arthur M. Vigilante, Director
Research, Development, Design and Manufacture of Detection and Recording Systems. Industrial and Analytical electro-physical instrumentation. Dynamic Condenser Electrometers.
#1 Azurelee Drive Malibu 8444 Malibu, Calif.

YARDNEY LABORATORIES, INC.

Research - Design - Development

Electro-Chemical Generators of Energy
105 Chambers Street WOrth-2-3534, 35, 36
New York 7, N. Y.

How's Your Surplus Coverage?

We've Got What It Takes



- Audio Transformers

- Bathtubs
- Binding Posts
- Cable
- Ceramicons
- Chokes
- Circuit Breakers
- Coil Forms
- Condensers
- Crystals
- Dynamotors
- Fuses
- Insulators
- Inverters
- Jacks
- Lugs
- Micacs
- Networks
- Pilot Lights
- Plugs
- Standoffs
- Switches
- Trimmers
- Tubes

- Power Transformers
- Relays
- Shock Mounts
- Sockets
- Wafers
- UG Connectors
- Wavemeters
- 400 Cycle Transformers

Thousands of Other Items For Your Contract Needs

YOU NEED IT — WE'VE GOT IT!

PAUL PLISHNER

COMMUNICATIONS EQUIPMENT COMPANY

350 Pearl Street

Brooklyn 1, N. Y.

Main 4-8373

RADAR SETS SONARS

Radar Systems and Components in Stock

- APS-2 10 CM AIRBORNE
- APS-3 3 CM AIRBORNE
- APS-4 3 CM AIRBORNE
- APS-6 3 CM AIRBORNE
- APS-6A 3 CM AIRBORNE
- APS-10 3 CM AIRBORNE
- APQ-13 3 CM AIRBORNE
- APS-15 3 CM AIRBORNE
- APS-31 3 CM AIRBORNE
- CPN-8 10 CM GROUND BEACON
- CEXH 10 CM GROUND BEACON
- FD-MARK 4 800 MC SHIP GUNLAYING
- MARK-10 10 CM SHIP GUNLAYING
- SA 200 MC SHIP AIR SEARCH
- SC 200 MC SHIP AIR SEARCH
- SD 200 MC SUBMARINE
- SE 10 CM SURFACE SEARCH
- SF 10 CM SURFACE SEARCH
- SG 10 CM SURFACE SEARCH
- SJ 10 CM SUBMARINE
- SK 200 MC AIR SEARCH
- SL 10 CM SURFACE SEARCH
- SN 10 CM PORTABLE
- SO (ALL SERIES) 10 CM SURFACE SEARCH
- SQ 10 CM PORTABLE
- SW 200 MC PORTABLE
- SCR 518 400 MC ALTIMETER
- SCR 520 10 CM AIRBORNE
- SCR 533 200 MC AIR SEARCH
- SCR 545 10 CM TRACKING 800 MC SEARCH
- SCR 663 SEARCHLIGHT TRACK

Sonar Systems and

Components in Stock

- QBF QCO
- QBG QCS
- QC QCU
- QCJ QCU
- QCL WEA

Bench Test Plumbing

All Type Wave Guide Plumbing

Several Types Rotating Joints

General TEST EQUIP.

Micro Wave Antennas

Magnetrons

Thermistors

Varistors

Pulse Xformers

Pulse Networks

Gun Laying Radar Equip.

Delay Lines

RF Equipment Modulators

X Band Equip.

K Band Equip.

Air-Borne Compasses

Klystrons

Xformer Tubes

FM 1000 W Station

1 250 W Trans. Receiving Station

Jan Components

Transmitters & Receivers

• CONTACTS •
FOR THE FIELD OF ELECTRONICS

ALUMINUM

Sheets—Circles
2S/3S/52S

Mill Certification for Defense Orders from warehouse stock

HENRY B. LUST

310 West 85th St. New York 24, N. Y.
Telephone: TRAtalgat 7-6329

FOR MAINTENANCE OF MOBILE COMMUNICATIONS SYSTEMS
MICROMETER FREQUENCY METER
FM MODULATION METER
LAMPKIN LABORATORIES, INC.
Bradenton, Florida

Write for Literature:

- PULSE CALIBRATORS
 - PROJECTION OSCILLOSCOPES
 - AUDIO OSCILLATORS
 - TELETRONICS LABORATORY, INC.
- Westbury, L. I., N. Y., Westbury 7-1027

PANEL METERS — TEST EQUIPMENT

Repaired—Calibrated—Designed

Modern, fully equipped Laboratory-Skilled Personnel. Internationally authorized primary standards.

AMERICAN ELECTRONICS

29 South Park Ave.

ROCKVILLE CENTRE, L. I. Tel. RO. 6-0207

use this
CONTACTS SECTION

to

- PROMOTE NEW USES
- PROMOTE NEW USERS
- GET NEW SALES OUTLETS
- REACH ALL BUYING INFLUENCES
- EFFECTIVELY ** ECONOMICALLY

**BRAND NEW SURPLUS
OFFERED BY A LEADING
SUPPLIER OF ELECTRONIC
AND AIRCRAFT EQUIPMENT**

**INVERTERS, AUTOSYNS, PRECISION
AUTOSYNS, RATE GENERATORS, SINE-
COSINE GENERATORS, SYNCHROS,
GYROS, A. C. MOTORS, D. C. MOTORS,
ALNICO FIELD MOTORS, SERVO
MOTORS, TORQUE UNITS, TORQUE
AMPLIFIERS, FREQUENCY METERS,
AND BLOWER ASSEMBLIES.**

cruise all overlap.
The tentative Y. R. A. schedule:
1-22, New York; 28, Horseshoe Harbor;
30, Amherst, Mass.; 31, Hagerstown, Md.
*forhasset
Ort

leader. Bert
Haven. Conn
for the comd
Shiels is
sangs

WRITE FOR COMPLETE LISTINGS
WESTERN UNION ADDRESS:
W U X GREAT NECK, N. Y.
U. S. EXPORT LICENSE — 2140
ALL PRICES F. O. B. GREAT NECK, N. Y.

**INSTRUMENT
ASSOCIATES**

**363 GREAT NECK ROAD, GREAT NECK, N. Y.
Telephone Great Neck 4-1147**

Write for Catalog NE100

RELAYS FOR EVERY PURPOSE

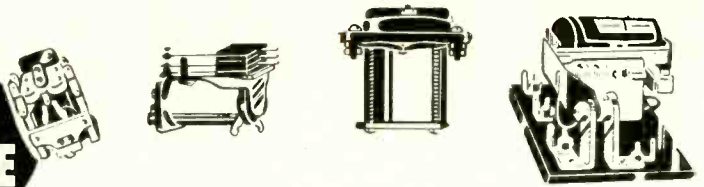

Over a Million in Stock!

Whether you require large quantities of relays for production runs or single units for laboratory or amateur work, Wells can make immediate delivery and save you a substantial part of the cost.

Our capable engineering staff is prepared to offer assistance in the selection of correct types to suit your exact

requirements.

Each relay is brand new, standard make, inspected, individually boxed and fully guaranteed.

The following list represents only a tiny portion of our relay stock. Write or wire us for information on types not shown.

STANDARD DC TELEPHONE RELAYS

Stk. No.	DC Voltage	Ohmage	Contacts	Unit Price
R-806	115 *	900	1A	\$2.05
R-161	6	10	2B & 1A	1.10
R-100	24	600	2A & 1C	2.45
R-289	40	3300	5A	2.20
R-518	85/125	6500	1C	3.60
R-266	150	6500	1A	2.45
R-633	180/350	10,000	1C & 5 Amps.	2.90
R-664	110 *	2B & 1A/oct. akt.	2.45
R-684	115 *	1C	2.45
R-264	220 *	1B	2.45
R-564	220 *	1B & 3A	2.45
R-667	6	.75	1B/10 amps. 1A/3 amps.	1.45
R-632	6	12	5A & 1C	1.25
R-154	6/12	200	1A	1.50
R-517	12	250	2A	1.50
R-777	12/24	70	1A & 1B	1.50
R-578	24/48	2500	1B & 1A	1.30
R-116	85	3000	1B	3.05
R-583	110	3300	1A	2.20
R-631	100/125	3300	2A	1.90
R-827	150	6500	2A, 1B	2.45
R-623	150	6500	1C & 2A	2.45
R-571	150	7000	1B	2.45
R-565	150	7000	1B & 2B	2.45
R-545	110/250	7000	1C	2.45
R-124	300	12,000	1A	1.55
R-511	24	200	W/Micro N.O.	3.05
R-160	6	12	3C & 3A	1.30
R-591	6	40	1B & 1C	1.35
R-592	12	160	1B & 2C	1.35
R-155	12	100	4A & 4B	1.45
R-520	200/300	14,000	2C	3.45
R-159	6	50	2A	1.35
R-158	6	50	4A	1.35
R-576	12	200	2A	1.35
R-153	12	200	1C & 1A	1.55

SHORT TELEPHONE RELAYS

R-635	12	100	1C & 1A	1.35
R-648	12	170	1E	1.35
R-926	12	150	2C, 1B	1.55
R-770	24	150	1A/10 amps.	1.45
R-538	24	180	2A	1.55
R-771	24	200	1A/10 amps.	1.45
R-603	18/24	400	2A	1.55
R-575	24	500	2C	2.40
R-764	48	1000	2C & 2A	1.85
R-563	60/120	7500	1A	1.70
R-801	115 *	None	1.45
R-213	5/8	2A	3.10
R-690	115 *	2C	2.45
R-589	12	125	2A	1.30
R-113	12	150	4A	1.55
R-689	12/24	255	1A	1.55
R-799	24	500	None	1.00
R-114	24	500	4A	1.60
R-115	24	500	1C	1.70
R-110	24/32	3500	1C	1.70
R-121	150	5000	2A & 1C	2.05
R-634	150/250	6000	1A & 1B	2.45
R-800	12	150	2C & 1A	1.55
R-537	12/24	150	2C & 1B	1.55
R-750	12/24	400	1A	1.60

SLOW ACTING

R-547	24	200	1C—Slow Break	\$1.80
R-548	48	1000	1B—Slow Make	2.00
R-128	50	2100	1C—Slow Break	2.80
R-525	1/2 24	200	1C/10 amps. S. Mk.	1.55
R-794	12	3 coils, 16 ohms ea.	3B & 3A/15 amps. S. Mk.	3.35

CONTACTORS

Stk. No.	DC Voltage	Ohmage	Contacts	Unit Price
R-188	24	200	1A/75 amps.	\$3.70
R-183	24	60	1A/50 amps.	3.45
R-187	24	100	1A/50 amps.	3.70
R-554	24	85	2A/100 amps.	5.90
R-788	100 *	3B & 2A	5.45
R-682	115 *	35	5A/10 amps.	6.10
R-767	24 *	20	2A/10 amps.	3.70
R-180	12	25	1A/50 amps.	4.05
R-657	24	50	4A/100 amps.	6.95
R-265	24	60	1A/100 amps.	3.45
R-535	24	70	1A/100 amps.	4.80
R-556	24	70	1A/100 amps.	4.80
R-557	24	100	1A/50 amps.	3.85
R-178	24	100	1A/100 amps.	4.80
R-727	10	20	1A/20 amps.	1.85
R-608	24	125	1A/200 amps.	2.80
R-184	28	50	1A/100 amps.	4.90
R-719	24	10	1A/200 amps.	4.90
R-182	28	80	1A/25 amps.	2.40
R-244	75 *	265	1A/50 amps.	2.20
R-659	12	7.2	2A/20 amps.	1.70
R-681	12/15	16	2A/15 amps.	1.55
R-552	24	70	4A/50 amps.	5.35
R-185	24	100	1A/50 amps.	3.45
R-186	24	132	1A/50 amps.	4.35
R-817	24	150	1A/50 amps.	3.45
R-534	14	45	1A/30 amps.	2.05
R-223	28	150	1A/40 amps./48 VDC.	1.70
R-680	6	3	1A/50 amps.	3.90
R-677	6	3.5	1A/50 amps.	3.90
R-532	6	15	1A/50 amps.	3.90
R-676	12	16	1A/50 amps. 1 aux./25A	3.90
R-678	12	18	1A/50 amps.	3.90
R-656	12	100	1A/100 amps.	2.60
R-553	24	55	1A/5 amps.	4.05
R-679	24	80	1A/50 amps.	3.90
R-610	24	80	1A Double Break	2.05
R-555	24	100	1A/50 amps.	4.80
R-533	24	150	1A/50 amps.	4.05
R-717	24	200	1A/50 amps.	3.45
R-703	12	20	2A/25 amps.	2.80
R-748	24	60	1A/30 amps.	2.45
R-655	24	80	1A/50 amps.	6.05
R-654	24	150	2A/40 amps.	2.40
R-742	24 †	70	1A/25 amps.	3.05

ROTARY RELAYS

Stk. No.	DC Voltage	Ohmage	Contacts	Unit Price
R-709	6/8	1	12 Pos. 3 Wafer	\$3.90
R-197	9/16	70	2C	1.45
R-713	9/14	125	1C & 1A	2.05
R-198	9/14	125	3B, 3A, 1C	2.05
R-616	28	7	5B & 1A	1.90
R-712	24	200	2B	2.05
R-711	24	200	2C & 1B	2.05
R-573	28	200	1C & 1B	2.05
R-284	28	200	4C & 1B	1.45
R-200	24/32	275	3C & 1B	2.05
R-766	24	230	12 Pos. 8 Deck	4.90
R-809	28	7	1B & 12 Pos. W/7" Shaft for Wafers	2.45

W-E TYPE "E" RELAYS

R-736	18/24	600	3C	\$1.50
R-585	12	650	2C	1.30
R-287	12/24	650	2C	1.30
R-164	24/32	1000	1A	1.50
R-646	24/48	1300	1B	1.50

DIFFERENTIAL RELAYS

R-208	120	2000	2C/3 amps.	\$2.45
R-209	220/250	8000	1C/3 amps.	3.10

SEALED RELAYS

R-658	6	35	2C/Octal Plug	\$3.45
R-125	24	300	2C/Octal Plug	3.45
R-261	12/24	1900	1C/5 Pin Plug	3.75
R-673	48/150	7500	1C/5 amps.	2.80

VOLTAGE REGULATORS

R-745	6 ; 2	350	1A/10 amps.	\$1.05
R-780	24	350	1C/6 amps.	1.05
R-509	6/12 ; 35	35	1B/2 amps.	1.05

SPECIAL RELAYS

R-503	12/32	100	3A/2C	\$2.80
R-749	600	Max. 28 amps.	7.45
R-804	550 *	1B/38 amps.	4.35
R-250	115 *	Adj. Cir. Bk.—04-16A	17.50
R-579	270 *	1B	8.70
R-294	220 *	200	1B	5.35

* A. C. † A. C./D. C.

WIDE SELECTION OF ELECTRONIC COMPONENTS AT WELLS

- Tubes
- Resistors
- Condensers
- Wire and Cable
- Volume Controls
- Co-ax Connectors
- Relays
- Rectifiers
- Transformers
- Chokes
- Micro Switches, Toggles
- Antennas
- Accessories
- Electronic Assemblies
- Dial Light Assemblies

SPECIAL

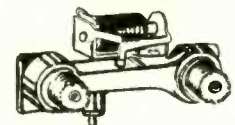

CO-AXIAL RELAY

D153766 SPDT, 6 VDC. 19 ohm coil. Designed to accommodate 75 watts maximum. Perfect for all types of antenna switching. Designed for using standard 83-TSP coaxial fittings. Part of RAX-1 equipment. No. R-845-\$6.95 ea.

BASIC CONTACT ASSEMBLIES SHOWN IN UNOPERATED NORMAL POSITION

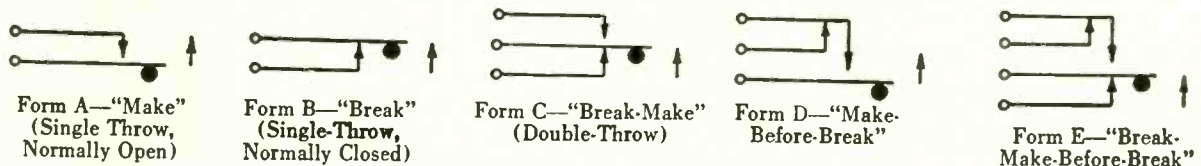

WRITE FOR WELLS CATALOG

TELEPHONE SEeley 8-4143



833 W. CHICAGO AVE., DEPT. G, CHICAGO 22, ILL.

MICROWAVE TEST EQUIPMENT

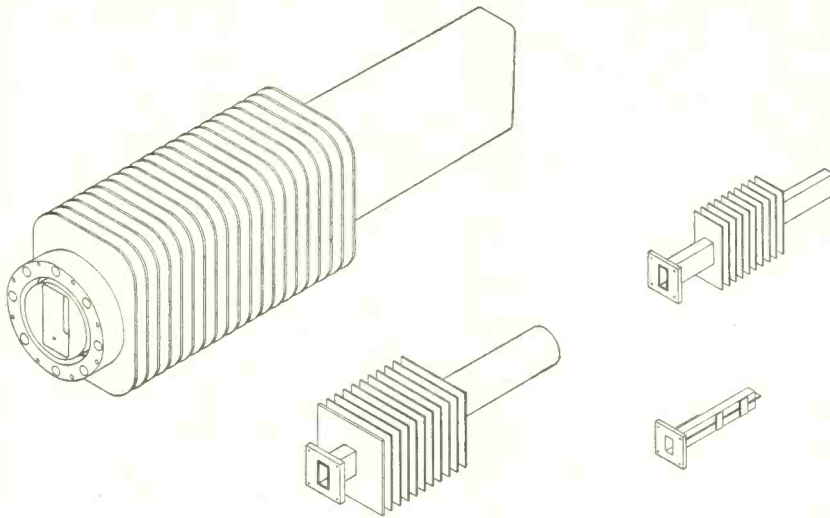

HI POWER X BAND TEST LOAD, dissipates 350 watts of average power for $\frac{3}{8}$ " x $1\frac{1}{4}$ " waveguide, VSWR less than 1.15 bet. 7 and 10 KMC.

HI POWER S BAND TEST LOAD, dissipates 1000 watts of average power, for $1\frac{1}{2}$ " x 3" waveguide. Range 2500 to 3700 MC. VSWR less than 1.0.

K Band Test Load, low power.

X Band Test Load, 50 watts, average power $\frac{1}{2}$ " x 1" waveguide. Sand load TS 108.

X Band attenuator, $1\frac{1}{4}$ " x $\frac{5}{8}$ " guide, single quillotine type, 0-30 db. V.S.W.R. 1.2 maximum, calibrated.

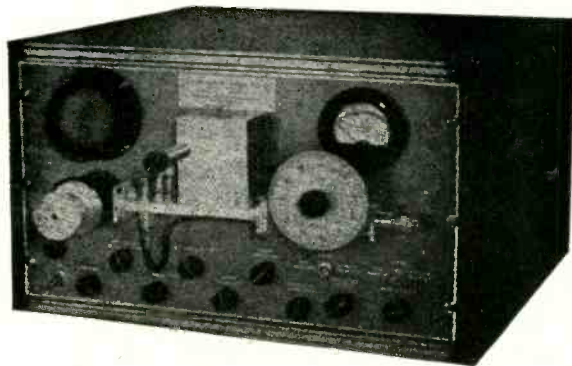

X Band Spectrum Analyzer 8500-9600 Mc., calibrated linear below cut-off attenuator, calibrated frequency meter, tuned mixer, 4 i.f. stages, 3 video stages overall gain 125 db., reg. power supply.

S Band Spectrum Analyzer 2700-3900 Mc., similar to above.

Frequency Meter, 8500-9600, variable, absorption type for either $\frac{1}{2}$ " x 1" or $\frac{5}{8}$ " x $1\frac{1}{4}$ " waveguide. Direct reading with correction

calibration, ± 4 MC. precision ground thread.

X Band Thermistor Mounts, VSWR less than 1.4 8500-9600 MC Fixed triple tuned, $\frac{1}{2}$ " x 1" waveguide.

30 MC I.F. STRIP, VIDEO, and AUDIO AMPLIFIER AND 110 Volt 60-2600 cps POWER SUPPLY, Bandwidth 10 mc. new, part of SPR-2 Receiver.

AMPLIFIER STRIP AM-SSA/SPR-2 contains, I.F. amplifier, detector, video am-

plifier, pulse stretcher and audio amplifier and Rectifier Power Unit PP-155A/SPR-2 bandwidth 10 mc. center frequency 30 mc, sensitivity 50 microvolts for 10 milliwatts output. Power supply 80/115 V ac, 60-2600 cps 1.3 amps. Send for schematic.

TS-33 X Band Frequency Meter, 8700-9500 Mcs. Crystal detector and 50 micro-amp. meter. Indicates Resonance. Connection for scope available.

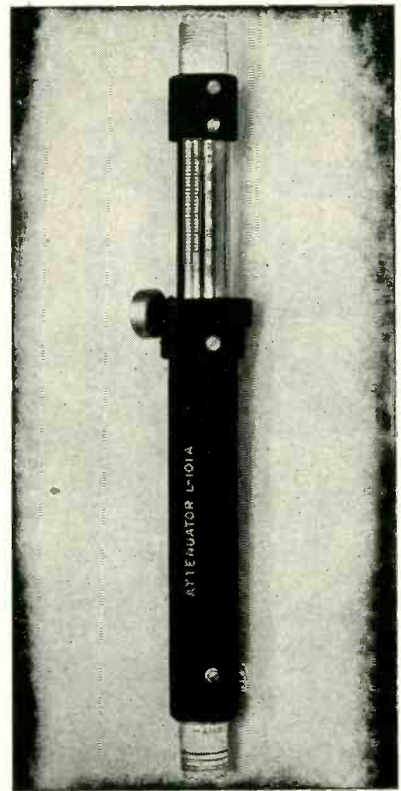

Waveguide Below Cut-off Attenuator L-101-A U.H.F. Connectors at each end, calibration 30-100 db.

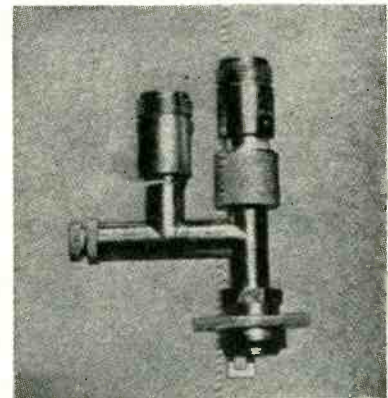

S Band Crystal Mixer, variable oscillator injection, illustrated.

S Band Mixer, tunable by means of slider, type N connector for the R.F. and local oscillator input, U.H.F. connector for the I.F. output, variable oscillator injection.

X Band VSWR TEST SET, TS-12/AP, Unit 2, slotted wave guide with gear driven travelling probe, matched termination and various adapters, with carrying case.

Electro Impulse
LABORATORY

62 White Street

Red Bank 6-0404

Red Bank, N. J.

We BUY

ALLEN BRADLEY

RESISTORS

TYPES EB - GB - HB

and

POTENTIOMETERS

"J" - "JJ" - "JJJ"

in all values

LEGRI S COMPANY

158 W 99th St. New York 25, N. Y.

ACademy 2-0018

We SELL

RESISTORS

Types: EB - GB - HB

POTENTIOMETERS

Types: J - JJ - JJJ

CERAMIC CAPACITORS

CERAMIC TRIMMERS

SILVER BUTTON MICAS - RHEOSTATS

LEGRI S COMPANY

158 W 99th St. New York 25, N. Y.

ACademy 2-0018

DISCOUNTS AND SAVINGS

OF 25 - 40 - 60 %

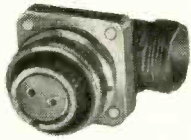

AN 3108



AN 3106



AN 3102



AN 3101



AN 3100



AN 3057

THE ABOVE SHELLS ARE AVAILABLE
WITH ANY OF THE FOLLOWING INSERTS

8S-1P	16S-6P	18-23S	20-27P	22-32P	28-4S	36-1P
8S-1S	16S-6S	18-24P	20-27S	22-32S	28-5P	36-1S
10S-2P	16S-8P	18-24S	20-28P	22-36P	28-5S	36-2P
10S-2S	16S-8S	18-25P	20-28S	22-36S	28-7P	36-2S
10SL-3P	16-2P	18-25S	20-29S	24-1P	28-7S	36-3P
10SL-3S	16-9P	18-26P	20-30P	24-1S	28-8P	36-3S
10SL-4P	16-9S	18-26S	20-30S	24-2P	28-8S	36-6P
10SL-4S	16-10P	18-27P	22-1P	24-2S	28-9P	36-6S
12S-1P	16-10S	18-27S	22-1S	24-3P	28-9S	36-7P
12S-1S	16-11P	18-28P	22-2P	24-3S	28-10P	36-7S
12S-2P	16-11S	18-28S	22-2S	24-4P	28-10S	36-8P
12S-2S	16-12P	18-29P	22-3S	24-4S	28-11P	36-8S
12S-3P	16-12S	18-29S	22-4P	24-5P	28-11S	36-9P
12S-3S	16-13P	18-30P	22-4S	24-5S	28-12P	36-9S
12S-4P	16-13S	18-30S	22-5P	24-6P	28-12S	36-10P
12S-4S	18-1P	18-31P	22-5S	24-6S	28-13P	36-10S
12-5P	18-1S	18-31S	22-6P	24-6P	28-13S	36-11P
12-5S	18-2P	20-1P	22-6S	24-7P	28-15P	36-12P
12S-6P	18-2S	20-1S	22-8P	24-7S	28-15S	36-15P
12S-6S	18-3P	20-2P	22-8S	24-9P	28-16P	36-15S
14S-1P	18-3S	20-2S	22-9P	24-9S	28-16S	36-16P
14S-1S	18-4P	20-3P	22-9S	24-10P	28-16S	36-16S
14S-2P	18-4S	20-3S	22-10P	24-10S	28-17P	36-17P
14S-2S	18-5P	20-4P	22-10S	24-11P	28-17S	36-17S
14S-4P	18-5S	20-4S	22-11P	24-11S	28-18P	36-18P
14S-4S	18-6P	20-5P	22-11S	24-12P	28-19P	36-19S
14S-5P	18-6S	20-5S	22-12P	24-12S	28-19S	36-21P
14S-5S	18-8P	20-6P	22-12S	24-15P	28-20P	40-1P
14S-6P	18-8S	20-6S	22-13P	24-15S	28-20S	40-1S
14S-6S	18-9P	20-7P	22-13S	24-16P	32-1P	40-2P
14S-7P	18-9S	20-7S	22-14P	24-16S	32-1S	40-2P
14S-7S	18-10P	20-8P	22-14S	24-18P	32-3S	40-9S
14S-9P	18-10S	20-8S	22-15P	24-19P	32-5P	40-11P
14S-9S	18-11P	20-9P	22-15S	24-19S	32-5S	40-11S
14S-10P	18-11S	20-9S	22-16S	24-20P	32-6P	40-13P
14S-10S	18-12P	20-10S	22-17P	24-21S	32-6S	44-1P
14S-11P	18-12S	20-11S	22-17S	24-24P	32-7P	44-1S
14S-11S	18-13P	20-13P	22-18P	24-24S	32-7S	44-2P
14S-12P	18-13S	20-13S	22-18S	24-25P	32-8P	44-2S
14S-12S	18-16P	20-14P	22-19P	24-25S	32-8S	44-4P
14-3P	18-16S	20-14S	22-19S	24-26P	32-9P	44-4S
14-3S	18-17P	20-15P	22-20S	24-26S	32-9S	44-4S
16S-1P	18-17S	20-15S	22-21S	24-28P	32-10P	44-5P
16S-1S	18-18P	20-16P	22-21S	24-28S	32-10S	44-5S
16S-3P	18-18S	20-16S	22-23S	28-1P	32-13S	44-6P
16S-3S	18-20P	20-17P	22-24P	28-1S	32-14P	44-6S
16S-4P	18-20S	20-17S	22-24S	28-2P	32-14S	44-6S
16S-4S	18-22P	20-24S	22-27P	28-2S	32-16P	44-9S
16S-5P	18-22S	20-25S	22-27S	28-3P	32-16S	48-1P
16S-5S	18-23P	20-26P	22-30P	28-3S	32-20S	48-1P
		20-26S	22-30S	28-4P	32-101P	48-3S

16-15P
16-15S
16-16P
16-16S
20-11P
20-25P
20-29P

We Are Continuously Adding New Types To Our Stock

WE SPECIALIZE IN PROMPT DELIVERY

SUBJECT TO PRIOR SALE

28-21P
28-21S
32-13P
32-20P
36-11S
36-12S
36-20P

SPECIAL ATTENTION GIVEN TO "DO" ORDERS

WILGREEN

99 MURRAY ST. N.Y.C. TEL BARCLAY 7-4862

AVAILABLE *from* STOCK



AN 3100



AN 3101



AN 3102



AN 3106



AN 3108

"AN" TYPE CONNECTORS

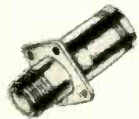

UG 22 B/U



UG 290/U



UG 306/U



UG 88/U



UG 274/U

I P C KINGS • ALL JAN APPROVED UG CONNECTORS



83-1SP



83-IR



83-IT



83-IJ



83-IAP

ALL TYPES IN STOCK • ALL JAN APPROVED "UHF" COAXIAL CONNECTORS

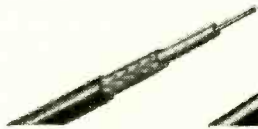

RG 5/U

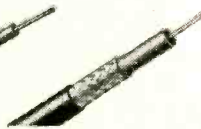

RG 11/U

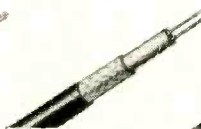

RG 22/U



RG 58/U

FEDERAL, ETC.

ALL JAN APPROVED • 40 "RG" TYPES IN STOCK COAXIAL CABLE

Prices on request — Indicate
type and quantity required

*Prompt answer, efficient accurate service
from one of the largest stocks anywhere*

SINGLE J DOUBLE JJ TRIPLE JJJ POTENTIOMETERS



SINGLE POTENTIOMETERS TYPE "J" AND "JL"

Ohms	Ohms	Ohms	Ohms
50	1300	30,000	500,000
60	1500	35,000	600,000
100	2000	50,000	750,000
150	2500	60,000	1.0 Meg
200	3000	75,000	1.3 Meg
250	5000	100,000	2.0 Meg
300	6500	150,000	2.5 Meg
400	10,000	200,000	3.0 Meg
500	15,000	250,000	4.0 Meg
600	20,000	300,000	6.2 Meg
1000	25,000	350,000	

DUAL POTENTIOMETERS TYPE "JJ"

Ohms	Ohms
60/60	25,000/25,000
200/200	25,000/400,000
300/300	30,000/30,000
600/600	50,000/50,000
700/700	75,000/75,000
1000/1000	100,000/100,000
1500/1500	250,000/250,000
1800/1800	500,000/500,000
2500/2500	100,000/ 1 Meg
3000/3000	1 Meg/ 1 Meg
10,000/10,000	2 Meg/ 2 Meg
10,000/25,000	2.5 Meg/ 2.5 Meg
20,000/20,000	3 Meg/ 3 Meg
20,000/30,000	5 Meg/ 5 Meg

TRIPLE POTENTIOMETERS TYPE "JJJ"

Ohms
20,000/ 180,000/ 15,000
150,000/150,000/150,000
500,000/500,000/500,000
1 MEG/1 MEG 5 MEG

RESISTORS

EB 1/2 Watt

GB 1 Watt

HB 2 Watt

All Standard Values
in $\pm 5\%$ and $\pm 10\%$
Available from Stock

LIFE ELECTRONIC SALES

DI gby 9-4154

345 BROADWAY

NEW YORK 13, N. Y.

NEW YORK'S RADIO TUBE EXCHANGE

TYPE	PRICE	TYPE	PRICE	TYPE	PRICE	TYPE	PRICE	TYPE	PRICE	TYPE	PRICE
OA2.....	\$2.00	2J32.....	69.95	5CP1.....	4.95	312A.....	3.95	723A/B...	24.95	876.....	.90
OA3.....	1.50	2J36.....	105.00	5CP7A....	15.00	323A.....	25.00	724A.....	4.95	878.....	1.95
OA4G....	1.35	2J38.....	17.95	5D21.....	27.50	327A.....	3.95	724B.....	6.95	884.....	1.95
OB2.....	3.00	2J42.....	150.00	5J29.....	19.95	350A.....	7.95	725A.....	9.95	885.....	1.75
OC3.....	1.75	2J49.....	109.00	5JP1.....	27.50	350B.....	5.95	726A.....	6.95	889R.....	199.50
OD3.....	1.50	2J50.....	69.50	5JP2.....	17.50	357A.....	27.50	726B.....	56.00	913.....	12.95
C1A.....	4.95	2J61.....	75.00	5JP4.....	27.50	368AS....	6.95	726C.....	69.00	914.....	75.00
C1B.....	6.95	2J62.....	75.00	5LP1.....	18.95	371B.....	1.95	728AY....	27.00	931A....	6.95
1B21A....	2.75	2K25.....	47.50	5LP1A....	19.50	385A.....	4.95	730A.....	8.95	954.....	.35
1B22....	3.95	2K28.....	42.50	5R4WGY..	3.75	388A.....	2.95	801A.....	1.00	955.....	.55
1B23....	9.95	2K29.....	27.50	6C21.....	29.50	393A.....	8.95	802.....	4.25	956.....	.69
1B24....	17.95	2K41.....	99.00	C6A.....	3.95	394A.....	8.95	803.....	5.95	957.....	.29
1B26....	2.95	2K45.....	299.50	C6J.....	7.95	MX408U..	.75	804.....	13.50	958A....	.69
1B27....	19.50	2V3G.....	2.10	7BP7.....	7.95	417A.....	17.95	805.....	5.95	959.....	.69
1B32....	4.10	3B24.....	5.50	7DP4.....	10.00	434A.....	6.95	806.....	25.00	975A....	17.95
1B38....	33.00	4L3C.....	5.95	12AP4....	55.00	446A.....	1.95	807.....	1.69	991.....	.45
1B42....	19.95	3C22.....	72.00	15E.....	2.95	450TH....	45.00	808.....	3.50	E1148..	.29
1B56....	49.95	3C24.....	1.95	15R.....	.95	450TL....	45.00	809.....	2.45	1280....	1.95
1B60....	69.95	3C31.....	5.95	NE16.....	.45	464A.....	9.95	810.....	11.00	1611....	1.95
1N21.....	1.35	3C45.....	13.95	FG17.....	6.95	471A.....	2.75	813.....	8.95	1613....	1.08
1N21A....	1.75	3DP1/A... 3E29.....	10.95 15.50	RX21.....	3.95	527.....	15.00	814.....	3.95	1616....	2.95
1N21B....	4.25	3E29.....	15.50	35T.....	4.95	WL530... WL531... 700A.....	22.50 12.50 25.00	815.....	4.50	1619....	.89
1N22.....	1.75	SN4.....	5.50	45 Special. RK39.....	.35 2.95	701A.....	7.50	816.....	1.45	1620....	5.95
1N23.....	2.00	4A1.....	1.75	VT52.....	.35	703A.....	6.95	829.....	9.95	1622....	2.75
1N23A....	3.75	4C27.....	25.00	RK72.....	1.95	705A.....	3.95	829A....	11.95	1624....	2.00
1N23B....	6.75	4C28.....	35.00	RK73.....	1.95	706AY....	48.50	829B....	15.95	1625....	.45
1N27.....	5.00	4E27.....	17.50	100TH....	9.00	706CY....	48.50	830B....	11.50	1629....	.69
1N48.....	1.00	4J25.....	199.00	FG105....	19.00	707A.....	17.95	832.....	5.95	1851....	1.85
1S21.....	6.95	4J26.....	199.00	F123A....	8.95	707B.....	27.00	832A....	9.95	2050....	1.85
2B22....	4.95	4J27.....	199.00	203A.....	8.95	714AY....	5.95	833A....	49.95	2051....	1.80
2B26....	3.75	4J30.....	395.00	211.....	.75	715A.....	7.95	834.....	7.95	8012....	4.25
2C34.....	.35	4J31.....	99.00	217C.....	18.00	715B.....	15.00	836.....	4.95	8013....	2.95
2C39.....	32.00	4J32.....	99.00	242C.....	10.00	715C.....	25.00	837.....	2.95	8013A... 8014A... 8020.... 8025.... 9001.... 9002.... 9003.... 9004.... 9005.... 9006....	5.95 29.95 3.50 6.95 1.75 1.50 1.75 .75 1.90 .35
2C40.....	27.00	4J33.....	99.00	249C.....	4.95	717A.....	1.75	845.....	5.59		
2C43.....	27.00	4J37.....	99.00	250TL....	19.95	718A/YEY 719A..... 720A/B/C/D/Y	48.50 29.50 93.00	849.....	52.50		
2C44.....	.90	4J38.....	89.00	274B.....	3.00	721A.....	3.95	851.....	80.50		
2D21.....	1.75	4J39.....	99.00	304TH....	15.00	722A.....	3.95	860.....	4.95		
2E22.....	3.75	4J41.....	99.00	304TL....	14.50			861.....	39.50		
2E30.....	2.75	4J52.....	350.00	307A.....	4.95			866A....	1.79		
2J26....	27.75	C5B.....	2.95	310A.....	7.95			869B....	37.50		
2J27....	29.95	5BP1.....	4.95	311A.....	7.95			872A....	3.95		
2J31....	39.95	5BP4.....	4.95								

ATTENTION PURCHASING AGENTS AND BUSINESS MANAGERS

WE PURCHASE COMPLETE INVENTORIES AND ELECTRONIC PARTS AND TUBES FOR CASH.
CAN WE HELP YOU TO OBTAIN URGENTLY NEEDED ELECTRONIC MATERIAL?
OUR ORGANIZATION IS DEDICATED TO SERVE THE ELECTRONIC FIELD.
YOU CAN REACH US TWX NY1-3235

TEST EQUIPMENT

This Month's Special
4C28..... \$35.00

ATTENTION PURCHASING AGENTS AND BUSINESS MANAGERS

WE BUY—WE SELL—WE EXCHANGE—WILL PAY CASH FOR YOUR INVENTORY NO MATTER HOW SMALL OR LARGE.
—TURN YOUR OVERSTOCKED ITEMS INTO CIRCULATION

Test Equipment Microwave K Band 24,000 MC.

TSKI-SE Spectrum Analyzer
K Band Flap Attenuator

X Band

4X X Band Spectrum Analyzer
TS 12 Unit 1 USWR Measuring Amplifier, 2 channel
TS 12 Unit 2 Plumbing for above
TS 83 X Band Power and Frequency Meter
TS 35 X Band Pulsed Signal Generator
TS 36 X Band Power Meter
TS 45 Band Signal Generator
TS 146 X Band Signal Generator
TS 263 Navy Version of TS 146
TS 62, TS 102, TS 168

X Band Magic T Plumbing
X Band Tunable Crystal Mounts
TVN #3EV Bridge, Cy 94

S Band

4S S Band Spectrum Analyzer
TS 102, TS 270
TS 125, TS 155, TS 127
RF 4 Electrically Tuned S Band Echo Box
BC 1277/60ABQ S Band Pulsed Signal Generator
PE 102 High Power S Band Signal Generator

L Band

Hazeltine 1030 Signal Generator 145 to 235 Megacycles
Measurements Corp. type 84 Standard Signal Generator
TS 47, 40 to 400 MC Signal Generator
TS 226, AN/UPMI

Audio Frequencies

RCA Audio Chanalyst

Broadcast Wave Bands

162C Rider Chanalyst
Short Wave Adapter for 162C
TS 174 Signal Generator

Oscilloscopes

TS 239A Lavoie APA10, APA28
BC 1287A used TS 34 Oscil-
in LZ sets loscopes WE
Supreme 564

Other Test Equipment and Meters

TS 15/A Magnet Flux Meter
General Radio V T Voltmeter 728A
Calibrator WE 1-147
General Radio 1000 cycles type 213
Limit Bridges
Boonton Standard Instructions
Weston Meters types 430, 429, 741
Model 40 Pyrometer
Rawson, meters 0-10 Microampere 0-2 Millivolt

RADAR Sets & Parts

APS 3—APS 4—R-111/APR5A

Minimum Order \$25.00



PHONE WORTH 4-8262

135 LIBERTY ST., NEW YORK 6, N.Y.

K-RK-ARPC-UG-PL-AM

CONNECTORS

**IN STOCK FOR IMMEDIATE DELIVERY
DISCOUNTS OF 25 - 40 - 60%**

SPECIAL ATTENTION GIVEN TO "DO" ORDERS

DAVID GREENBERG

WORTH 2-7423 99 MURRAY ST. NEW YORK CITY

● **TUBES**
BUY-SELL-EXCHANGE

Large Stocks of Radio, TV, Special Purpose, and Transmitting types in stock at low prices for fast delivery—

● **EQUIPMENT**
SMALL and LARGE ORDERS EXPEDITED; Test LAB Certification

Radar, Test Sets, Components, and Selected Surplus

● **RECTIFIERS**
HIGH QUALITY
LOW, LOW PRICES

Selenium Stacks from 1 to 24 amps. in stock. Special types to order for 48 hour delivery—

● **EXPORT**
MANUFACTURERS DEALERS

We can completely and reliably expedite many of your foreign orders. Let us show you how we may represent you as export agents and/or Mfr's Representatives Abroad or in the USA.

Barry Electronics Corp.

136 Liberty St., New York 6, N. Y.

RE ctor 2 ²⁵⁶³ ₂₅₆₄ ₂₅₂₈

CABLE: BARRYLECT, N.Y.

**THOUSANDS OF SURPLUS BARGAINS
IN OUR HUGE WAREHOUSE**

CONDENSERS • TRANSMITTING MICAS
BATHTUBS • UPRIGHTS • SOCKETS
CONTROLS - RHEOSTATS - MANY OTHERS

SEND US YOUR NEEDS FOR OUR QUOTATION

**TELEPHONE
RELAYS**

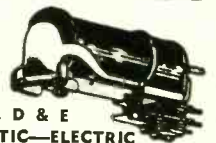

CLARE, TYPES C, D & E
COOKE, AUTOMATIC—ELECTRIC
ALL TYPES of COILS and PILE-UPS
Send Us Your Specifications For Our Quote

Chase

Electronic Supply Co.
222 Fulton St.
N. Y. C. 7, N. Y.
HOllis 4-5033

SURPLUS COMPONENTS FOR SALE

Bathtubs, oils, micas, xformers, chokes, relays, trimmers, sockets, odd items, etc.

Surplus lots purchased.

EMPIRE ELECTRONICS
Box 41, Midwood Stat., Brooklyn 30, N. Y.
Phone BRyant 8-1228

IF THERE IS

Anything you want

that other readers of this paper can supply

OR—

Something you don't want

that other readers can use, advertise it in the

SEARCHLIGHT SECTION



from
the

LARGEST INVENTORY IN THE COUNTRY

over 3,500,000 to choose from

We Invite Inspection of Our Complete Line of:



K CONNECTORS



AN CONNECTORS

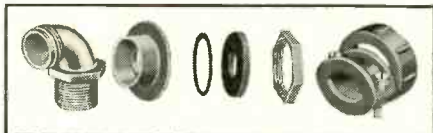

AN CLAMPS AND HARDWARE

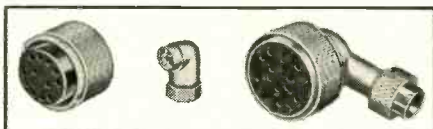

BRITISH PLUGS



UG CONNECTORS



UHF COAXIAL CABLE "83 SERIES" CONNECTORS

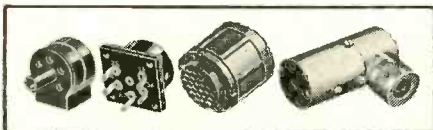

ARC-NAF-PL PLUGS

WRITE, PHONE or WIRE Your Needs AT ONCE

TELEPHONE

**BEekman
3-5780**

Prices quoted on request; simply state type and quantities required. All inquiries receive PROMPT ATTENTION. Industrial needs served ACCURATELY and EFFICIENTLY. Write to our Mr. Ellis.

AVNET

ELECTRONIC SUPPLY CO.
6 WEST BROADWAY N.Y.7,N.Y.

ELECTRONIC, TELEVISION & RADIO COMPONENTS

Surplus—New
INSTRUMENTS
&
ACCESSORIES

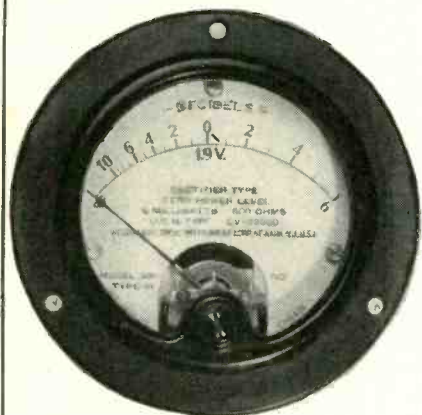

We carry a complete line of surplus new meters and associated equipment such as portable, panel switchboard, aircraft, laboratory standards etc.

- VOLTMETERS
- AMMETERS
- MICROAMMETERS
- MILLIAMMETERS
- FREQUENCY INDICATORS
- RADIO FREQUENCY
- DECIBEL METERS
- POWER LEVEL
- METER TRANSFORMERS
- THERMOCOUPLES
- SHUNTS

**OVER
75,000
METERS
IN STOCK**

Many made to following specifications:

- Jan (MR-) Navy (CV-)
- SC (IC-) NAP (1091-)
- etc.

Let us know your requirements. We may have just the item you need.

Send for Bulletin

**MARITIME SWITCHBOARD
INSTRUMENTS & ACCESSORIES**

338 Canal St. New York 13, N. Y.
WOrth 4-8217

ELECTRONIC SURPLUS

HEADQUARTERS FOR

TUBES

- Receiving
- Transmitting
- Cathode Ray
- Photo Cell
- Magnetron
- Klystron
- Thyratron
- Ignitron
- Special Purpose

COAXIAL CONNECTORS
ALL JAN APPROVED TYPES

COAXIAL CABLE

TYPE "J" POTENTIOMETERS

CRYSTAL DIODES
SILICON & GERMANIUM

PULSE TRANSFORMERS
UTAH, G.E., W.E., ETC.

PULSE NETWORKS

CAPACITORS
OIL-FILLED & MICA

SYNCHROS

SELENIUM RECTIFIERS

SERVO MOTORS

—IMMEDIATE DELIVERY—

COMPLETE STOCKS OF GOVERNMENT SURPLUS

ELECTRONIC COMPONENTS AND EQUIPMENT

SEND US YOUR INQUIRIES

ELECTRONIC RESEARCH LABORATORIES

715-19 ARCH ST.

PHILA. 6, PA.

Telephones - MARKET 7-6771-2-3

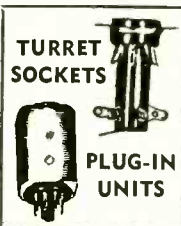

TURRET
SOCKETS

PLUG-IN
UNITS



AN CONNECTORS
IN STOCK AT
50% DISCOUNT

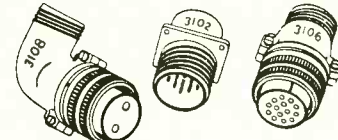

AN
3100, 3101, 3102, 3106,
3108 with any
SUFFIX

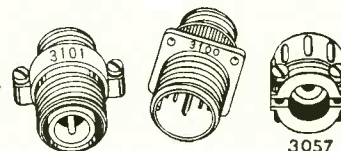

Widely Known for Fair Dealing
and Good Service

HAROLD H. POWELL

632 Arch Street

Philadelphia 6, Pa.

Market 7-5650

☆☆ SEE OUR FULL PAGE ADS EACH MONTH IN "SEARCHLIGHT SECTION" ☆☆
☆☆ OF "ELECTRONICS" MAGAZINE FOR THE BIGGEST VALUES IN ELECTRONIC ☆☆
☆☆ SURPLUS — — — AN AND COAX CONNECTORS; CAPACITORS; ☆☆
☆☆ COAX CABLE; RESISTORS; SELSYNS ETC. ☆☆
☆☆ Get On Our Mailing List! ☆☆

RELIANCE MERCHANDIZING CO.

Arch St. Cor. Croskey Phila. 3, Pa. Telephone RIttenhouse 6-4927

SAVE With New Surplus!

LARGEST VARIETIES AT
GREAT SAVINGS

• OIL CAPACITORS

LARGE RECTANGULARS
SMALL RECTANGULARS
BATHTUBS; TUBULAR

• MICA SILVER TRANSM. 61-2-3-4

• ELECTROLYTIC FP CANS

• AMPHENOL-CANNON

• AN-IJC-UHF CONNECTORS

• LORD SHOCKMOUNTS

• BIRTCHEr Tube CLAMPS

• JONES PLUGS—SOCKETS BARRIER STRIPS

• POWER RHEOSTATS

• SWITCHES TOGGLE, ROTARY MICRO, PUSH-MOM.

• POTENTIOMETERS J. JJ. JJJ.

• OTHER CARBON WIRE-WOUND POTS

• MOSSMAN LEVER SWITCHES

• AIRCRAFT NOISE FILTERS

• RESISTORS GLASS FERRULE PRECISION

• FUSEHOLDERS-MOUNTS

• INSTRUMENT KNOBS

• MANY OTHER ITEMS

Write-Wire-Phone Your Specs.

Alexander Mogull Co. Inc.

161 Washington St., N. Y. 6. N. Y.

WORTH 4-0865

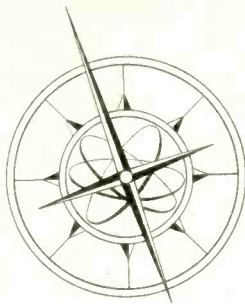

COMPASS

COMMUNICATIONS COMPANY

393 GREENWICH STREET

NEW YORK 13, N. Y.

BEekman 3-6510

CABLE ADDRESS: COMPRADIO

We stock

• RADAR

Marine, Ground & Airborne

• SONAR

• TRANSMITTERS

from 25 watts to 5 kilowatts

• RECEIVERS

• BEACONS

• LORAN

• RADIOTELEPHONES

• TUBES

New, Standard Brands Only

—MAGNETRONS

—KLYSTRONS

—TRANSMITTING

and other Special Purpose Tubes

• CONVERSION EQUIPMENT

—MOTOR GENERATORS

—CONVERTORS

—DYNAMOTORS

—INVERTORS

—POWER SUPPLIES

—RECTIFIERS

• TEST EQUIPMENT

• TELEPHONE EQUIPMENT

PORTABLE AND STATIONARY SWITCHBOARDS AND SUPPLIES

OUR EXPORT DEPARTMENT AVAILABLE FOR SPECIAL SERVICE
TO OVERSEAS CUSTOMERS

WE MAINTAIN OUR OWN FULLY EQUIPPED TESTING
LABORATORY IN THE SAME BUILDING AS OUR MAIN
WAREHOUSE TO TEST ANY ITEM WE SELL.

WE GUARANTEE EVERYTHING WE SELL



WE HAVE LARGE
QUANTITIES OF

RADIO TUBES

TRANSMITTING & RECEIVING

AM—FM and Television Broadcast

All Tubes are brand new—standard brands

Immediate Delivery

Write—Wire or Telephone for detailed list

MANUFACTURERS: Interested in EXPORT?

Contact Michel Levit

METROPOLITAN OVERSEAS SUPPLY

MANUFACTURERS AND DISTRIBUTORS
OF ELECTRONIC PRODUCTS



1133 BROADWAY, NEW YORK 10, N. Y.



CORPORATION

CHELSEA 3-1105

SURPLUS RADIO

- PLUGS
- RESISTERS
- AIRCRAFT RADIO PARTS
- BRUSHES

Spares for most surplus aircraft radios carried in stock

LONG ISLAND RADIO COMPANY

P. O. Box 474 Montrose, Penn.

RED ARROW BARGAINS !!

TRANSMITTING MICAS
 .0025 @ 1200 V, .005 @ 1200 V, .04 @ 1200 V, .01 @ 1200 V, .004 @ 1200V49¢ each
 .027 @ 2500 V Test, .001 @ 2500 V59¢ each
 .0035 @ 5000 V, .0001 @ 5000 V, .00025 @ 5000 V79¢ each

DYNAMOTORS
 PE73—Used, F/BC 375\$4.95
 PE94—Used, F/SCR 522\$4.95

Tinnerman Clamps	Heavy Duty Line Cord
Various Sizes \$9.50	3 ft. lengths with
per thousand	molded rubber plug
	11¢ each

TURBO
 Flexible varnished sleeving (saturated). Color: Blue. No. 20 inside ID, 888 feet per roll. ONLY\$7.25 per roll

BC 929 Radar Scope	SCR 625 Mine Detector
Excellent condition	Brand New, export pack-
\$17.95	ed. SENSATIONAL
	VALUE!\$59.95

BC 456 Modulator	BC 433G Compass
Good, used, with tubes	Excellent condition with
ONLY \$1.89	all tubes. SPECIAL \$29.95

RA 10D or RA 10 LB
 Excellent, complete with all tubes and Dynamotor\$24.95

MN 26C or MN 26V
 Excellent, with all tubes and Dynamotor... \$23.95

TUNING EQUIPMENT	BK 22 RELAY
IE 6A F/BC-358-A	Brand New\$4.89
TRANSMITTER \$39.95	

FP TYPE CONDENSERS
 10 MFD @ 400 V, 20-20 MFD @ 50 V49¢
 1000 MFD @ 15 V, 49¢ 10 MFD @ 250 V, 39¢

MACKAY TRANSMITTER 149-A
 Excellent, less tubes.....\$79.00

INDICATOR BC-704A
 Very good condition—terrific value\$19.95

BENDIX TYPE TA-3B TRANSMITTER
 Frequency Range: High—2,500 to 15,000 KC.
 Low—300 to 600 KC. Brand New, complete with Cradle\$235.00

MINIMUM ORDER—\$2.00. Send 25% deposit with order, balance C.O.D. Shipped F.O.B., N.Y.C. (N.Y.C. residents add 3% sales tax.)

RED ARROW SALES CO.

Dept. T, 214 Stanton St., N. Y., N. Y.
 Phone—COrtland 7-5425

TIME DELAY RELAYS

Cramer TD2-120S 115v 60cy adjtbl to 2 minutes, TD2-60S adj to 1 min. New \$9.95, w/damaged covers.....\$7.95

LINK MOBILE TRANSMITTERS

Type 25 UFM, 30-42 mc. FM 6 vdc in. used good cond. No cables, w/tubes easily modified to AM\$69.50

RADAR EQUIPMENT MARK II

Navy Type 46ABW, RF to IF converter uses 446A in cavity osc. driven by 1 RPM Bodine 115v 60cy rev. motor. New in original cartons\$49.50

ISOLATION XFORMER 35 WATTS

115-115v 60cy. sec. w/6.3 tap.....\$2.45

SILVER CERAMIC TRIMMERS

Erie TS2A 1.5-7, 4-30, 7-45......39¢

Type J pot 1 meg w/switch.....\$1.75
 HYVOL #7512 .1mfd 7500v dc.....\$3.55

EMPIRE ELECTRONICS CO.

Box 41 Midwood Stat. Brooklyn 30, N. Y.
 BRyant 9-1220

SURPLUS

tubes, condensers, wire, hardware, resistors, ceramic components, pots, etc.

WANTED

everything used in ELECTRONICS.
 Fast action on a CASH BASIS.

GOULD GREEN

252 Greenwich St. New York 7, N. Y.

WE SPECIALIZE IN

RELAYS

of all kinds • and we are loaded with more coming daily

OVER 200,000

IN OUR VAST STOCK

WATCH OUR MONTHLY ADS IN THE SEARCHLIGHT SECTION FOR OUR BARGAINS

We Also Have Large Stocks of

- | | | |
|----------------|----------------|--------------|
| AN Connectors | Dental Lab. | Relays |
| APC's | Resistors | Resistors |
| Blinding Posts | Filters | Servo Xfmrs. |
| Cable | Fuses | Solenoids |
| Capacitors | Hardware | Shock-Mounts |
| Ceramics | Hi-Voltage | Sockets |
| Ceramics | Glass | Spaghetti |
| Chokes | Feedthrus | Switches |
| Circuit | Iron Core | Tie-Posts |
| Breakers | Slugs | (H.P.) |
| Coils | Knobs | Transformers |
| Connectors | Potentiometers | Tubes |
| Controls | (sine-cosine) | And Others |
| Crystals | Pulse Xfmrs. | |

Write Us Your Needs for Immediate Quote
 PRICES FOB OUR PLANT. Min. Order \$5.00

Universal/general corp.

324 Canal St. N. Y. C. WA lker 5-9642

Use National

CLASSIFIED ADVERTISING

for bringing business needs or opportunities to the attention of men associated in administrative, executive, management, sales and responsible technical, engineering and operating capacities with the industries served by McGraw-Hill publications.

For advertising rates or other information address:

Classified Advertising Division

McGraw-Hill Publishing Co., Inc.

330 W. 42nd St., New York 18, N. Y.

LERU *has it!*

RADAR EQUIPMENT

RECEIVERS, TRANSMITTERS, CONTROL BOXES,
ANTENNAE, INDICATORS, AMPLIFIERS, ETC.

TEST EQUIPMENT

RECEIVERS, TRANSMITTERS, GENERATORS,
METERS, MAGNETRONS, ETC.

Write for Listings _____

• LERU LABORATORIES, INC.

360 Bleecker St., New York 14, N. Y., Oregon 5-3525

ARE YOU A MANUFACTURER or SUBCONTRACTOR

USING

"AN" "K" CONNECTORS
and other Electronic Components?

If so, we can assist you in filling your immediate needs.

Write us your current requirements.

Advise "DO" rating if any.

P J SALES

99 Murray Street

Phone: WOrth 2-7425

New York City

RESISTORS

Immediate Delivery from our stock in all values from
fractional ohms to 47 megohms

American made Carbon Resistors (all brands) in 1/2, one, and two watts.
Tolerances of 5%, 10%, and 20%.

Advise us of your requirements. Samples submitted on request.

STANLEY ENGINEERING & MFG. CO.

114 Liberty St., New York 6, N. Y.

Phone: Digby 9-0454

TO HELP YOU

*Sell Equipment You No Longer Need
Use*

"Searchlight" Advertising

RECTIFIER POWER SUPPLY

McColpin Christie Model MH 24-25, input
230 v 60 cy. 3 ph. Output 25 amps, 24-28 v
DC. Continuous duty, fan cooled. 13" x 13" x
19". Price \$75.00 each net. New. \$215.00 value.

LEO SAGAL CO.

860 Glenmont, L. A. 24, Calif.

"TAB"

THAT'S A BUY

SAVE Time Money Effort
on DEFENSE CONTRACTS

for a "MILLION and ONE" parts

SEE "TAB" FIRST

**JAN and STANDARD
IN STOCK . . .**

- | | |
|---------------------------|-------------------------------|
| 9,000 Antennas | 2,500 Meadssets |
| 4,000 Batteries | 2,300 Line Filters |
| 300,000 Capacitors | 27,000 Pilot Lights |
| 20,000 Chokes & Coils | 2,000 Selsyns |
| 15,000 Circuit Breakers | 1,000 Blowers |
| 1,000 Clock Motors | 1,100 Tach Generators |
| 40,000 Connectors | 2,500 Rectifiers |
| 12,000 Piezo Xrals | 20,000 Relays |
| 1,700 Dynamotors | 250,000 WW Resistors |
| 15,000 ft. Film | 2,500,000 Precision Resistors |
| 1,250,000 Fuses & Holders | 65,000 Potentiometers |
| 10,000 ft. Spaghetti | 23,000 Rheostats |
| 45,000 Insulators | 6,000 Tech Manuals |
| 5,500 Meters | 50,000 Tube Sockets |
| 25,000 Rotary Switches | 500,000 pcs Telephone |
| 20,000 Toggle Switches | Equip (jacks, |
| 15,000 Microswitches | plugs, lamps, etc.) |
| 100,000 ft. Wire & Cable | 40,000 Transformers |
| 5,000,000 pcs Hardware, | 250,000 Tubes |
| Lugs | Millions of Odds N Ends |
- Government Contractors, Quantity Users—Write for Your
Needs On Your Company Letterhead

BRAND NEW, GUARANTEED



**VARISTORS, THERMISTORS
CRYSTAL DIODES**

1N21 .. \$.89	1N29 .. \$3.50	1N52 .. \$.95
1N21A .. 2.00	1N32 .. 18.00	1N60 .. .60
1N21B .. 4.95	1N34 .. .79	10 for 5.59
1N22 .. 2.00	10 for 7.50	100 for 49.98
1N23 .. 1.29	1N35 .. 1.95	1N64 .. .75
1N23A .. 3.98	1N46 .. .89	10 for 6.95
1N23B .. 5.95	1N48 .. .70	100 for 62.50
1N25 .. 7.45	1N51 .. .52	1N67 .. 1.95
1N26 .. 5.20	10 for 7.70	CK705 .. .77
1N27 .. 3.50	100 for 45.00	CK707 .. 1.80

D167019 Volume Limiter.....\$2.95
D168391 Thermal Compensator..... 1.00
D170395 Hi-Freq Power Meas..... .90
1C Bulb Time Delay..... .90
CW/20259 USN 38C Varistor..... 2.95
WEco 40A Varistor \$1.50; WEco 41A Varistor 1.50



RECTIFIERS

30Vin/26Vout/150Ma Selen w/mtr
Range, 2 units can connect in C.T.
for Full Wave; 4 units usable as
Full Wave Bridge. Ea. Unit, 36c; 2
for 60c; 4 for \$1.00
Sensational BRADLEY Double Bridge, Balanced
Current & Temp 1% from -40° to +68° C. Int
to 4.5VAC, output to 3VDC/5Ma. .98c
Full Wave Bridge Selen for Relays or PWR Inpt
115 to 150 vac; output 115vdc/40 Ma
Ea. 69c; 10 for \$5.98
75 Ma Selen..... 59c; 200 Ma..... 98c
Copper Oxide VDBlr 155m/30Vout/100 ma. 98c

Volts In	Volts Out	Amps	Each
HALF-WAVE			
18	12	.15	\$.69
130	120	.075	.59
130	120	.09	.69
130	120	.2	.98
130	120	.225	1.29
Full-Wave Bridge			
118	14	2	2.45
18	14	4	3.98
18	14	8	5.98
18	14	12	7.98
18	14	24	15.95
36	28	1	3.69
136	28	4	5.98
36	28	12	15.98
120	100	1	3.98
130	120	2.4	12.29

Top Dollar Paid for SURPLUS TUBES & EQUIPMENT—Send List & Prices



BLOWERS
40 CFM 28vacdc.....\$4.98
70 CFM 115v/40vac..... 4.49
250 CFM 28vacdc..... 9.95
250 CFM & 28 to 115vac
Transformer..... 11.95
100 CFM 115vacdc..... 7.98
175 CFM 220vac..... 11.98
\$5. Min. FOB NYC. Add Postage, 25% Deposit.
Money Back Guarantee, Return Risk, Prepaid.
Prices Subject to Change.

"TAB"

Dept. 6EB
6 Church St.
New York 6, N.Y., U.S.A.
WOrth 2-7230

SYLVANIA RADIO AND TELEVISION TUBES

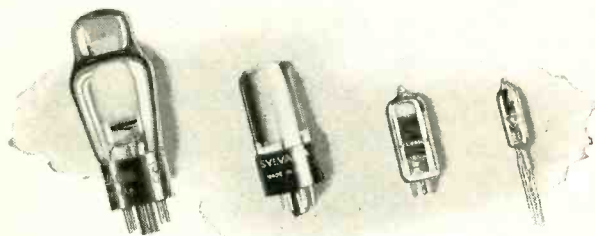

RECEIVING TUBES

Even the small parts—pins, plates, grids, and powders for cathode surfaces—that go into Sylvania radio and television receiving tubes are made by Sylvania in its own plants. Whether for the large 5U4G or for tiny subminiatures like the 6BF7, 6K4, and 5642, every step of the way is quality controlled.

Sylvania research has brought about many important advances in radio receiving tubes, making it possible to offer you a *complete line* that is unsurpassed in quality.



TRANSMITTING AND RUGGEDIZED TUBES

To augment its comprehensive line of top quality receiving tubes, Sylvania has marketed a line of more than 20 high quality transmitting tubes and numerous ruggedized types.

Typical of these comprehensive lines is Sylvania's Type 5933/807W, a ruggedized version of a popular transmitting type. The 5933/807W is smaller, has shorter internal leads and excellent shielding, evidences remarkable stability, and is designed to withstand vibration and shock while in service. Electrical operating ratings are identical to those of the conventional Type 807.

TV PICTURE TUBES

Sylvania's complete line of high quality television picture tubes includes round and rectangular types, of both glass and glass-metal construction in all popular sizes. Face plates of clear, frosted, and neutral-gray glass.

Sylvania Cathode Ray Tubes for every purpose include electromagnetic types from 5-inch to 20-inch and larger; magnetically deflected types with electrostatic focus and electrostatic types in screen sizes from 2-inch to 7-inch. Screen persistences from long and medium to short are available with blue, green and white fluorescence.

Write for detailed information and latest data sheets on the complete line of Sylvania Cathode Ray Tubes.



SYLVANIA ELECTRIC

1740 Broadway, New York 19, N. Y.

SYLVANIA TEST EQUIPMENT



Television Oscilloscope. An Exceptionally High-Gain, Wide-Band Oscilloscope Designed for Television. Accurately displays any TV pulse or wave-shape on a large, eye-saving 7" screen. Sensitivity: 0.01 v./in. Vert. response useful to 4.0 mc. Hard-tube sweeps to 50 kc.; phasing control; pos. or neg. sync. control; many other outstanding features. Recommended for servicemen; laboratories; advanced schools and industry. Price: \$249.50.



Type 400



Type 132Z

General Purpose Oscilloscope. A Versatile 7" 'Scope with Many Features Found in Type 400 above, priced as low as oscilloscopes with smaller screens. Sensitivity: 0.10 v./in.; freq. response: exceeds 7 cps. to 70 kc., useful to 250 kc. Widely used by servicemen, schools and industry for AM-FM-TV testing. Price: \$149.50.

Type 500



TV Signal Generator.

An ALL ELECTRONIC Sweep Generator for TV and FM. Fundamental center frequencies: 2-25, 20-64, 60-120, and 140-230 mc. Two adjustable sweep widths: 0-600 kc./15 mc.; excellent sweep linearity; output 0.1 v. Edge-lighted dial; simplified controls; small size: 11½" x 8½" x 7". May be used with any 'scope and marker including those shown at left and below. Price: \$139.50.

TV High-Voltage Probes. New, Quality Probes that Permit Measuring High TV Anode Voltages by increasing the dc range of Polymeters to 30,000 or 10,000 volts. Special conversion cartridge permits using 30 kv probes with ANY 1,000 volt scale 20,000 ohm/volt meter. Select correct probe from list below:



Type	Range	Use with	Price
225	30 kv	Polymeter, Type 221 and 221Z	\$12.50
224	30 kv	Earlier Polymeters, Types 134 and 134Z	12.50
226	30 kv	Conversion cartridge for use with above Type 225 or 224 to convert ANY 20,000 ohm/volt meter with a 1000-volt scale to a kilovoltmeter	2.00
223	10 kv	Polymeter, Type 221 and 221Z	9.95
222	10 kv	Earlier Polymeters, Types 134 and 134Z	9.95

Tube Tester Type 220. Made By A Tube Manufacturer For Tube Users, these instruments test for ALL usual faults—not just one particular characteristic. New and exclusive ohmmeter-type shorts/leakage test indicates "GOOD" or "REPLACE" directly on the illuminated meter. Gas and special heater-cathode leakage tests made in single operations. Single composite dynamic test for emission, transconductance and relative tube life. Panel-mounted roller-chart; convenient switches; provisions for future tubes. Portable Type 220 has durable metal case and handle; removable cover. Size: 6" x 11¼" x 17". Price \$114.50.



Tube Tester Type 219. The counter Type 219 is electrically equivalent to the portable type. Attractively housed in a streamlined wood and metal cabinet. Adaptable to any surroundings. Occupies small counter space. Size: 5¾" x 13" x 18¾". Price: \$114.50.

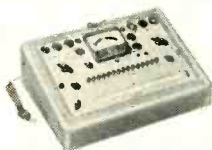

Modulation Meter. Directly indicates per cent of AM modulation. Compact; requires no direct connection to circuit. Used by amateurs, transmitter builders and others. Indicates carrier shift. Price: \$29.50.

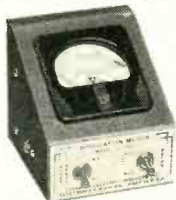

Type X-7018

Polymer-TV Vacuum-Tube Voltmeter.

A Sensitive DC, AC and RF Vacuum-Tube Voltmeter, Ohmmeter and DC Current Meter. Illuminated meter; microphone-type lead connectors. Ranges: rf to 300 volts (only 3 μmf shunt capacity); ac and dc to 1000 volts (10 or 30 kv dc using h.v. probes described at left); dc current from 50 microamperes to 10 amperes; and resistance from 0.5 to one billion ohms. Frequency range to 300 megacycles. High input impedance on all voltage ranges. Size identical to TV generator above. Price: \$99.50.

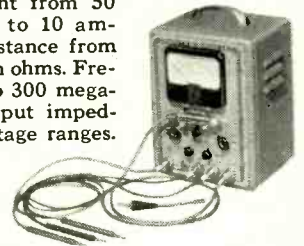

Type 221Z

FM-AM Signal Generator.

Useful as a TV Marker. A versatile AM-FM generator, doubly useful for peaking alignment of TV and as a TV marker. Calibrated to 0.05%. Fundamentals 80 kc to 120 mc; harmonics to 240 mc. Modulation: 0-100% AM; 0-30/150/700 kc FM. 1.0 volt max. output. Low leakage. Built-in crystal circuit. Size: 11¾" x 17 1/8" x 10 5/8". Price: \$139.50.

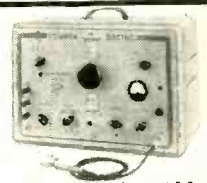

Type 216

Cathode Ray Tube Testing Adapter.

Use with any Sylvania Tube Tester to check 85% of your picture tube troubles, without removing tube from receiver. Checks electro-magnetic types for emission, shorts, leakage, and open filaments. Price: \$9.50. Type 228.



Type 228

Only brief data are presented in this highly condensed catalog. More detailed literature is available from your Sylvania Distributor or Sylvania Electric Products Inc., Emporium, Pa.

SYLVANIA ELECTRIC

1740 Broadway, New York 19, N. Y.

CRYSTAL DIODES DUO-DIODES VARISTORS



GERMANIUM DIODES AND DUO-DIODES

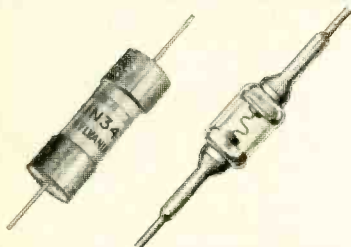

Sylvania Germanium Diodes are long-life, lightweight, heaterless components that have found hundreds of applications in clippers, limiters, discriminators and other circuits calling for low power rectification at frequencies up to several hundred megacycles. They have low shunt capacity and no contact potential. Convenient pigtail leads eliminate the need for mounting hardware.

Sylvania Duo-Diodes consist of two matched diodes mounted in a single unit.

Sylvania Varistors, types 1N40, 1N41 and 1N42, consist of 4 specially selected and matched germanium diodes whose resistances are balanced within $\pm 2.5\%$ in the forward direction at 1.5 volts. Sylvania Varistor Type 1N71 consists of 4 matched low impedance diodes, whose forward currents are within a range of 1 ma with +1 volt applied.

Ratings shown are for each diode. Types 1N40, 1N42 and 1N71 are plug-in type; 1N41 is lug type.



Sylvania Silicon Diodes 1N21B, 1N21C, 1N23B, 1N25, 1N26 and 1N53 are used chiefly as first detectors in radar and other microwave superheterodyne receivers.

Type 1N22 is designed for use in microwave test probes, power indicators and other instruments.

Types 1N31 and 1N32 are used as high level video detectors.

Type	Cont. Reverse Working Voltage	Reverse Voltage*	Fwd. Curr. at +1v (ma min.)	Av. Anode Current (ma max.)	Reverse Current (μ a max.)
1N34	60v max.	75v min.	5.0	50	50 @ -10v; 800 @ -50v
1N34A	60v max.	75v min.	5.0	50	30 @ -10v; 500 @ -50v
1N35**	50v max.	75v min.	7.5	22.5	10 @ -10v
1N38	100v max.	120v min.	3.0	50	6 @ -3v; 625 @ -100v
1N38A	100v max.	120v min.	4.0	50	5 @ -3v; 500 @ -100v
1N39	200v max.	225v min.	1.5	50	200 @ -100v; 800 @ -200v
1N54	35v max.	75v min.	5.0	50	10 @ -10v
1N54A	50v max.	75v min.	5.0	50	7 @ -10v; 100 @ -50v
1N55	150v max.	170v min.	3.0	50	300 @ -100v; 800 @ -150v
1N55A	150v max.	170v min.	4.0	50	500 @ -150v
1N56	40v max.	50v min.	15.0	60	300 @ -30v
1N56A	40v max.	50v min.	15.0	60	300 @ -30v
1N58	100v max.	120v min.	4.0	50	800 @ -100v
1N58A	100v max.	120v min.	4.0	50	600 @ -100v
1N60	25v max.	30v min.	†	50	†30 @ -1.5v

*For zero dynamic resistance.

**Duo-diode consisting of two units matched in the forward direction at +1v so that the current flowing through the higher resistance unit is within 10% of that in the lower resistance unit. Ratings shown for each diode.

†Units are tested in a circuit employing an input of 1.8 volts rms. at 40mc, 70% modulated at 400 cycles. Demodulated output across a 4700 ohm resistor shunted by μ f. capacitor is a minimum of 1.2 volts peak-to-peak.

GERMANIUM VARISTORS

Type	Cont. Reverse Working Voltage	Reverse Voltage*	Fwd. Curr. at +1.5v (ma min.)	Av. Anode Current (ma max.)	Recurrent Peak Anode Curr. (ma max.)	Reverse Current (μ a max.)
1N40	25v max.	75v min.	12.75	22.5	60	40 @ -10v
1N41	25v max.	75v min.	12.75	22.5	60	40 @ -10v
1N42	50v max.	120v min.	12.75	22.5	60	6 @ -3v 625 @ -100v 300 @ -30v
1N71	40v max.	50v min.	15 (@ +1.0v.)	60	200	300 @ -30v

*For zero dynamic resistance.

SILICON DIODES

Type	Design Freq. (mc)	Max. Conv. Loss (db)	Max Output Noise Ratio	Burnout Test	I. F. Imp. (ohms)
1N21B	3,000	6.5	2.0	Bs=2.0 erg	200-800
1N21C	3,000	5.5	1.5	Bs=2.0 erg	200-800
1N22	Operating Range 3000-10000 MC				
1N23B	10,000	6.5	2.7	Bs=0.3 erg	200-800
1N25	1,000	8.0	2.5	Bp=6.5 watts	150-600
1N26	25,000	8.5	2.5	Bs=0.1 erg	100-400
1N29	Obsolete—use 1N21B				
1N53	"Over 30,000"	8.5	2.5	Bs=0.15 erg	300-600
Type	Min. Fig. of merit	Video Imp. (ohms)	Burnout Test	Carrier Freq. (mc)	Video Freq.
1N27	Obsolete—use 1N32				
1N30	Obsolete—use 1N31				
1N31	55	6,000-23,000	Bp=0.02 watt	10,000	500 cps—5 mc
1N32	100	5,000-20,000	Bp=0.36 watt	3,000	500 cps—5 mc
1N76 (Rated in specified circuit)				10,000	500 cps—5 mc

Bs=total energy in simulated spike of pulse from TR box in radar service.

Bp=peak power pulse under pulsed conditions.

SYLVANIA ELECTRIC

1740 Broadway, New York 19, N. Y.

MICROWAVE COMPONENTS



MAGNETRONS



4J78

The Sylvania family of Magnetrons operates in the shf band at peak power levels ranging from 7 to 300 kw and at average power ranging from 14 to 300 watts. 2J42 and 2J42A are of the vane type; 3J31, rising sun; 4J50, 4J52 and 4J78, hole and slot. All except 3J31 are supplied with magnet. Write for bulletin EC-37.

Type	Frequency Range (mc)	Pulsed Power Out (kw)	Avg. Power Out (watts)
2J42	9345-9405	7-14	14
2J42A	9345-9405	18-35	18
3J31	23,744-24,224	30-54	15-27
4J50	9345-9405	300	225
4J52	9345-9405	65-120	65
4J78	9003-9168	300	225

ROCKET TUBES



2C36

Sylvania Rocket Tubes are planar-electrode disc-seal triodes for use as oscillators and amplifiers at frequencies up to 3300 mc. Design permits broad band operation. Tuning is simpler and covers a greater continuous range than that of many other types of uhf tubes

2C36 is a pulse-modulated oscillator for frequencies up to 1200 mc.

2C37 is designed for use as a c.w. oscillator up to 3300 mc. Plate disc is flat, grid disc folded.

5764 is a pulse-modulated oscillator for use up to 3300 mc.

5765 is for use as a c.w. oscillator without external feedback in the range from 900 to 3000 mc.

5767 is a c.w. oscillator for use up to 3300 mc. Both discs are folded.

5768 is intended for use as a c.w. amplifier-multiplier up to 3000 mc.

6018 is intended for use as a c.w. amplifier-multiplier up to 3000 mc.

For complete information, write for bulletin ES-4810.



4C35

HYDROGEN THYRATRONS

Sylvania Hydrogen Thyratrons are designed for pulsing service at high repetition frequencies, high peak currents and high voltages. An outstanding feature is very short de-

TR's and ATR's

Sylvania TR and ATR Tubes are used chiefly as automatic electronic transmit-receive switches in radar equipment. Major characteristics of some of the more commonly used types are shown in table. For full data on complete line call your nearest Sylvania sales office.



1B63A

Type	Frequency Range (mc)	Insertion Loss (db)	Max. Recovery Time (μ sec. at -3 db)
1B24	8490-9600	0.85-1.50	4
1B63	8565-9487 (1)	0.8	4
1B63A	8490-9578 (2) 8565-9487 (3)	0.7 max.	4

Type	Frequency Range (mc)	Transmitter Peak Power (kw min.)	Tuning Susceptance (mhos)	Arc Loss (db. max.)
1B35	9000-9600	5	$-.06$ to $+.06$	0.8

(1) 1.6 VSWR. (2) 1.9 VSWR. (3) 1.4 VSWR.

KLYSTRONS

Sylvania Types 6BL6 and 6BM6 are intended for use as c.w. oscillators. They are of the separate cavity type, with oscillation frequency depending chiefly on external tuning. 5836 and 5837 are suitable for either c.w. or pulsed operation. Write for catalog EC-41.



6BL6

Type	Mode	Frequency Range (mc)
6BL6	1 $\frac{1}{2}$	1600-4000
	2 $\frac{3}{4}$	2100-4500
	3 $\frac{3}{4}$	4000-5500
6BM6	1 $\frac{1}{2}$	550-2300
	2 $\frac{3}{4}$	1100-3000
5836	1 $\frac{1}{2}$	1600-4000
	2 $\frac{3}{4}$	2100-4500
	3 $\frac{3}{4}$	4000-5500
5837	1 $\frac{1}{2}$	550-2300
	2 $\frac{3}{4}$	1100-3000



5C22

SYLVANIA ELECTRIC

1740 Broadway, New York 19, N. Y.

INDUSTRIAL ELECTRONIC TUBES



FLASH TUBES



R4340

Sylvania Flash Tubes, used with suitable equipment, provide blue-white flashes of intense brilliance and extremely short duration. They find extensive use in flash photography, and may also be used in beacons, obstruction markers and signaling devices.

Type R4330 has a maximum rate of 6 flashes a minute, with a peak light output of 12,000,000 lumens and an integrated output of 3,500 lumen-sec. per flash.

Flashing rate of the R4340 is 4 per minute maximum, peak light output 12,000,000 lumens, integrated output 18,000 lumen-sec. per flash.

STROBOTRONS & TRIGGER TUBES

Sylvania Strobotrons provide a means of "freezing" the motion of rotating or reciprocating machinery. Type 1D21/SN4 produces neon-red flashes at rates up to 240 per second. SA-309 and R4350 produce bluish-white light pulses, and are ideal for application where true-color viewing is essential. Maximum flashing rate of the R4350 is 15 per second; of the SA-309, 100 per second.

Triggertube Type 0A5 provides a convenient means of triggering any of the above Strobotrons from very low current sources. Type 0A5 may also be used for other electronic relay and for regular Strobotron purposes.



1D21/SN4

GLOW MODULATOR TUBES

Light output of Sylvania Glow Modulator Tubes varies in an essentially linear manner with the current passing through the tubes. Tubes are of the crater type, providing high ionization density.



R1130B

	R1130B	R1131C
Operating Voltage, max.	150	135
Operating current, ma	5-35	3-25
Modulating Freq. Range, cps	15-15,000	15-15,000
Useful Light Range, Angstroms	3,500-6,500	3,500-6,500
Crater Diameter, inches	.056	.093

GERMANIUM DIODE APPLICATIONS LITERATURE

These two outstanding books comprise the most complete collection of germanium diode applications ever published. "40 Uses for Germanium Diodes" covers applications in receiver, transmitter instrument and control circuits. "Electronic Shortcuts for Hobbyists" describes applications in all types of devices of interest to the home hobbyist, "screw-driver mechanic" and electrical experimenter. Price of each book - 25¢ a copy.

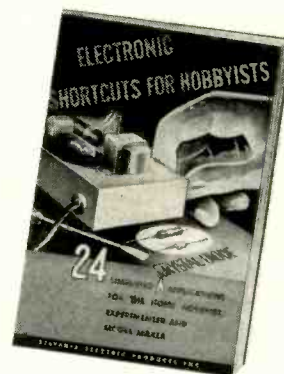
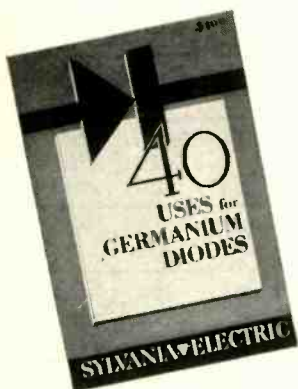

MISCELLANEOUS TUBES

SS501 Gas Discharge Tube

This tube is of the externally triggered, cold cathode type, for use as an electronic switch capable of handling high instantaneous currents in high voltage circuits.

SD-759A Ramberg Accelerometer

The Accelerometer is an electronic tube useful in measuring linear acceleration. Its operating range is from 1 to 50 g's. Operates at plate voltage of 10 volts per plate.

X-6090 Ionization Tube

The Sylvania X-6090 Ionization Tube has an ozone output of approximately 5 mg per hour under typical operating conditions. Operating voltage is approximately 3,500 volts ac.

SYLVANIA ELECTRIC

1740 Broadway, New York 19, N. Y.

electronics

CUMULATIVE

INDEX

covering
VOLUMES I—XII

April 1930
through
December 1939

McGRAW-HILL PUBLISHING CO., INC.
330 West 42nd Street
New York 18, New York

ELECTRONICS

CUMULATIVE INDEX,

1930-39

This index, which lists in alphabetical order all articles published in *Electronics* during the first ten years of publication, from April 1930 to December 1939, was compiled by members of the technical staff from the original published material. It is planned to publish a similar index covering the second decade, January 1940 to December 1949, in the June 1952 Buyers' Guide Issue.

The articles are listed in three ways: by title, by subject and by author. The title and subject listings are combined and printed in three columns per page. The author listings follow, printed in two columns per page.

TITLE LISTINGS: The exact title of each article as it originally appeared (omitting only the articles "a", "an" and "the") is listed in alphabetical order, with the last name or names of the author or authors. Exact title listings may be identified by the presence of the author's name.

SUBJECT LISTINGS: Each article is also listed alphabetically by the subject or subjects it represents. Categories of subjects are identified by boldface type. The terms used in the subject index reflect current usage.

AUTHOR LISTINGS: The author index contains an entry (name and initials) for every author of every article, together with the exact title of the article.

PAGE, MONTH AND YEAR: Every listing whether by title, subject or author, contains the page number, month of issue and year, in that order, as indicated at the top of each column.

FEATURE ARTICLES AND DEPARTMENT ITEMS: Feature articles, those printed as full pages in the front of the editorial section each month, carry no identification. Department items, shorter articles printed at the back of the editorial section and collected under such headings as "Tubes at Work" and "The Electron Art", are identified by the symbol D after the page number. The following department items, in view of their great number and lack of current interest, are not indexed: Book Reviews, New Products, current news items and Patents.

ABSOLUTE AMPERE

ANTENNA

Pg—Mo—Yr	Pg—Mo—Yr	Pg—Mo—Yr
A		
Absolute ampere52D July 39	Allocations (cont'd)	Amplifier (cont'd)
Absorption, r-f, in liquids.....93D Mar 34	uhf region.....7 July 36	output transformer.....30 Jan 36
A-C bolometer perfected by Professor Moon at MIT.....38D Nov 35	vhf, all services.....34 Apr 39	p-a, avc.....45D May 36
A-C millivolt measurements.....50D Dec 36	Allocations in the uhf spectrum, Staff.....34 Dec 37	peak-limiting audio, low-distortion.....38 June 39
A-C operated beat oscillator, Haefner & Hamlin.....20 May 36	Alnico—new magnetic material.....42D Jan 36	pentode, distortion.....142 Oct 31
A-C operated high gain amplifiers, Noble.....210 July 34	Altimeter, see also Navigation Aid	phase-inverter to push-pull stage.....40D Oct 35
Accurate frequency control with thermionic tubes.....284D Sept 34	Altimeter, absolute, acoustic.....40 Feb 34	photocell using a-c flicker.....58D Nov 37
Acorn tube, for uhf.....282 Sept 34	absolute, f-m.....19D Jan 39	phototube.....634D May 31
Acoustics, see also Reverberation	Amateur receivers of advanced design, Dudley.....20 Dec 36	power, vhf.....19D Jan 33
Acoustics, broadcast studio treatment.....14 Jan 32	Ammeter, h-f, phototube indicator.....44D Sept 38	zero-bias tube.....139 June 30
broadcast studio, WCAU.....358 Dec 32	meter shunt circuit.....36D Apr 38	push-pull A and linear B.....98D Mar 35
p-a for auditorium.....40 Feb 34	r-f, calibration by photocell.....40D Apr 37	graphic design.....73 Mar 33
sound absorption.....250D Aug 30	Amplification, see also Amplifier	push-push.....32D July 31
sound level chart.....43 Feb 32	Amplification at r-f for television.....80D Mar 30	push-push, design.....82 Mar 32
sound-picture theaters.....625 May 31	Amplification at 7 meters.....19D Jan 33	r-c coupled, broad-band, television.....265D Aug 32
Acoustic absolute altimeter.....49D Feb 34	Amplification by r-f pentodes.....52D Oct 36	data.....29 Feb 37
Acoustic and light characteristics of sound screens, Kreuzer.....420 Dec 30	Amplification factor chart, Jervis.....45 June 39	high-fidelity.....76D June 39
Acoustic features of WCAU's new studios, Staff.....358 Dec 32	Amplification of ten quadrillion times.....156D Oct 31	high-mu tube.....53D Apr 38
Acoustic instruments for routine testing.....44D Dec 38	Amplification of very low direct currents.....634D May 31	improvements.....51D Apr 37
Acoustical board, cornstalk.....52D Apr 38	Amplification of weak photoelectric currents.....163D Oct 31	gain and phase-shift, chart.....35 Sept 39
Acoustical engineers hold symposium on loudspeakers, Staff.....142 June 30	Amplifier, see also Amplification	reflex, i-f/a-f.....52D July 39
Acoustical labyrinth, Olney.....24 Apr 37	Amplifier, adjustments, broadcasting.....15 July 36	i-f/a-f.....153 June 33
Acoustical labyrinths for high-fidelity reproduction.....28D Jan 35	Errata.....56D Jan 37	remote pickup, broadcasting.....38D Jan 38
Acoustical reactance of loudspeaker.....122D Sept 31	a-c, photocell.....245 Aug 35	resonant, peaked-tuned.....81D Mar 33
Acoustically compensated volume control for radio and phonograph sets, Wolf & Connell.....50 Feb 33	a-c/d-c, high-gain.....195D July 33	r-f, broadcast receiver.....279 Sept 31
Action and output of the split-plate magnetron.....42D Aug 36	u-f, broadcast remote-pickup.....28 July 39	capacitance-coupled.....20 July 31
Adds chlorine for water purification.....156D Oct 31	push-pull, bridge-type.....134 May 33	class B calculation.....41 Nov 37
Adjudication of the oscillating-tube patents, DuMont.....108 May 30	push-pull, phase inverter.....330 Nov 32	power, class B & C.....33 Dec 39
Adjustable band-pass filter with flat top.....44D Mar 36	stable, using triodes.....220D July 34	suppressor-grid pentode.....10 Jan 32
Adjusting the class-B linear power amplifier in broadcasting station equipment, Hallman.....219 July 35	transformer and r-c coupling.....142D Apr 32	tuned, uniform gain.....414 Dec 30
Advanced disc recording, Le Bel.....34 Nov 38	transformer testing.....18 July 37	screen-grid tube.....346D Dec 33
Advanced receiver design.....44D July 37	using r-c coupling.....25 Aug 36	6L6, degenerative.....30 Sept 36
Advancements in a-c/d-c design, Ware.....14 Jan 35	audio, avc.....50 Feb 34	television, wide-band.....24 May 38
Advance notice of flood's control given by automatic radio.....221D July 35	class B & AB, transformer design.....14 Feb 36	transient analysis.....39 Nov 39
Advances in low pressure-art.....120D Sept 31	band-pass, visual tuning.....58D Feb 32	trf, transformer coupled.....21 Apr 30
Advances in sound recording—Industrial uses of tubes, Staff.....4 Jan 32	broad-band, degeneration.....56D Apr 39	uhf, inductive output tube.....30 Feb 35
AFC (Automatic Frequency Control)	r-c coupled.....38D Nov 36	vhf, resonant-line tank.....33 Oct 35
AFC, broadcast receiver.....18 Jan 35	resistor impedance.....38D Jan 39	v-t, equivalent parallel circuit.....105 Sept 31
circuit improvements.....20 Nov 36	broadcast remote, unattended.....21 Nov 38	Industrial, RJ-563.....162 May 32
discriminating.....7 Mar 36	class A push-pull calculation.....18 June 37	wide-band, high-gain.....16 Feb 39
AFC design considerations, White.....28 Sept 36	class-B, distortion measurement.....196 June 32	television.....16 Jan 38
Aids in manufacturing electronic apparatus, Staff.....90 Apr 33	linear adjustment.....219 July 35	for tv.....22 Aug 37
Air-cooled tube.....58D Aug 39	coupling, interstage-filter.....194D July 33	Addenda.....52D Nov 37
Air purification by electrical means.....50D Apr 38	Errata.....269D Sept 33	tube-choice.....38D Apr 39
Aircraft and police radio services expanded, Staff.....270 Sept 34	d-c, compensated.....94D Mar 34	Amplifier for galvanometer deflections.....46D June 37
Aircraft compass, cathode-ray.....12 Aug 36	degenerative, industrial use.....51D Apr 39	Amplifier for impulse counting.....69D Nov 38
Aircraft Radio, see also Communications	electromotor tube.....634D May 31	Amplifier measuring technique, Klernan.....18 July 37
Aircraft radio compass, Fink.....7 Oct 35	for galvanometer.....292D Sept 34	Amplifier method of measuring velocity of flow past aerofolles.....52D Feb 31
Aircraft radio, 1939 (survey), Staff.....10 Jan 39	for oscillograph.....40D Aug 37	Amplifier noise—a bibliography.....20D Jan 34
Aircraft radio, survey.....20 Feb 38	logarithmic recording.....24 Mar 37	Amplifier speakers in factory workrooms (illustr).....169 July 30
Aircraft static suppressor on United Air Lines ships.....42D Feb 39	low-voltage measurement.....195D June 35	Amplifier units find new uses in industry, Staff.....34 Feb 34
Airfield wind-vane (sock) controlled by photocells.....278D Oct 33	multiplier.....34D June 36	Amplifier without phase distortion, Staff.....26 June 37
All-glass tubes.....68D June 39	one-tube balanced.....318D Oct 36	Amplifiers and television receivers.....59D May 39
All-metal receiving tubes, Metcalf & Beggs.....148 May 35	photocell.....44D Jan 38	Amplifiers used to study currents produced by thoughts.....48D Feb 34
All-metal receiving tubes, Staff.....116 Apr 35	single tube.....82D Sept 38	Amplitude and frequency modulation.....242D Dec 31
All-metal vacuum tubes, Pike & Metcalf.....812 Oct 34	single tube, balanced.....159D May 34	Amplitude of loudspeaker cones.....32D July 31
All-wave radio receiver for aircraft, Kruse.....336 Oct 30	survey.....42D Mar 38	Amplitudes of sound from musical instruments.....24D Jan 33
All-wave signal generator for production tests, Shea.....244 Aug 34	three-stage.....198D July 33	Analogue between dry-disc phototube and chemical cell.....20D Jan 34
Allocations, see also Spectrum	tubes and circuits.....62D Nov 36	Analysis of efficient modulation, Dingley.....78 Mar 34
Allocations, broadcasting at 500-550 kc.....17 Oct 36	deflection (beam control).....40D June 37	Analysis of frequency multiplier.....70D Sept 39
frequency, chart.....26 Apr 30	degenerative feedback construction.....16 Apr 37	Analysis of high modulation transmission, Lampkin.....326 Oct 30
Madrid assignments.....274 Sept 34	Errata.....7 Oct 38	Analysis of uniform r-f amplifications, Uehling.....414 Dec 30
high-frequency broadcasting.....31 June 36	design, feedback.....12 Jan 37	Analysis of vacuum-tube production costs.....664 June 31
high-power broadcasting.....13 Nov 36	differential, two-tube.....46D Aug 37	Analyzer, color, plots curve.....17 Mar 36
Madrid conference.....276 Sept 36	distortion, photocell.....128D Apr 34	harmonic, single-frequency source.....374 Nov 30
spectrum chart.....44 May 36	dynamic microphone.....52 Feb 34	Analyzing industry and traffic noises.....388D Nov 30
Errata.....75 Nov 37	eliminating hum and microphonics.....18 Mar 39	Anemometer indicator, photocell.....222D Aug 33
	feedback.....30 July 36	Announcer killers.....55D Feb 34
	for unidirectional microphone.....242 Aug 35	Annual tube replacement cost for broadcast stations, Staff.....113 Apr 34
	frequency-doubling, aircraft.....124 Apr 32	Anode materials, transmitting tubes.....22 Dec 38
	gain and selectivity, loaded.....229D Aug 33	
	gain-frequency characteristic.....34 June 37	Antenna, antifading, Breslau.....350D Nov 32
	high gain.....54D Feb 34	array, directional, broadcast.....38D Jan 38
	a-c power operated.....210 July 34	broadcast, antifading.....199D July 33
	wide-band.....16 Feb 37	dipole.....36D Aug 36
	high-resistance, for phototube.....50D Aug 39	KDKA (illustr).....24 Feb 38
	i-f, automatic selectivity control.....32 Dec 36	rotatable.....30 Feb 38
	picture and sound.....30 June 38	current, increase with modulation.....59 Aug 31
	LC-coupled, tuned.....340 Oct 30	directional broadcast, computation.....37 July 37
	low-frequency, feedback, variable negative.....54D Apr 39	phasemeter, crt.....62D Apr 39
	r-c components.....76D June 39	
	magnetic.....28 Oct 39	
	microphone, two-tube.....18 Dec 35	
	modulated, high-efficiency.....8 July 38	
	output, direct-coupled, 110-v tube.....128 Apr 32	

ANTENNA

BASS COMPENSATION

Pg—Mo—Yr	Pg—Mo—Yr	Pg—Mo—Yr
Antenna (cont'd)	Attenuator (cont'd)	Automatic elevators need photocell protection15D Jan 34
directional broadcast	design chart247 Aug 34	Automatic facsimile telegraph put in service by Western Union51D Apr 39
array, WLW152 May 35	network design simplified150D Oct 31	Automatic line-level indicator, Odell36D Oct 37
broadcast362 Dec 32	simple network48D Sept 38	Automatic line-measuring equipment of the German broadcast system, Leonhardt347 Nov 34
dummy, using lamps362 July 36	Audience Research, see Broadcasting	Automatic maintenance of solid-liquid equilibrium523D Feb 31
height vs electrical degrees, chart30 July 38	Audimeter records listening habits of radio audience46D Apr 39	Automatic photoelectric titration126D Apr 34
low-cost wooden mast46D May 36	Audio, see also Broadcasting; Recording; Sound	Automatic public address amplifier volume level control, Boucke45D May 36
matching, pi-section networks29 Jan 36	Audio, amplifier, avc50 Feb 34	Automatic radio compass685D June 31
to coaxial line239 Aug 35	amplifiers, feedback12 Jan 37	Automatic radiogoniometer52D Aug 39
mobile, for auto radio41 Feb 35	broadcast input console38 June 38	Automatic recording of field strength, Jansky148 May 34
radiation chart35 July 39	pickup amplifiers25 Aug 38	Automatic remote amplifier, Brewer21 Nov 38
receiving, centralized, apartments37 Nov 39	Errata7 Oct 38	Automatic selectivity control, Mayer32 Dec 36
reducing, high-angle radiation58D Feb 34	transmitter characteristics378 Dec 34	Automatic SOS alarms, Staff20 Apr 37
resistance, broadcast45 Feb 34	distortion, dramatic effects252D Aug 35	Automatic starting resistance62D Feb 37
Riverhead (illustr)32 May 37	limiter, receiver26 Mar 38	Automatic synchronization of television images42D Apr 36
shielded loop, broadcast receiver20 Oct 38	factory p-a installation25 Dec 36	Automatic typesetting machine employs photoelectric translation device33D Aug 38
short receiving48D Jan 36	frequency meter, direct-reading224D July 35	Automatic voltage regulation, Howe164 May 32
shunt-excited, uhf44D May 39	frequency-response measurement, automatic46D Feb 39	Automatic volume control64D Feb 35
shunt-fed broadcast, tuning42D Dec 39	gain-control, electronic58D Feb 35	Automatic volume expander, Weeden184 June 35
survey, using balloon support36D July 38	high-fidelity circuits108 Apr 34	Auto-alarm, standby for ships20 Apr 37
television, design28 Apr 38	pickup9 Mar 38	Auto-Radio, see also type, e.g., Broadcasting; Communications; etc.
transmitting, cubical, GE51D Apr 39	intermodulation distortion20 Sept 38	Auto-radio an expanding market in 1933, Staff8 Jan 33
towers, broadcasting238 Aug 38	level indicator, sound recording56D Sept 37	Auto-radio forges ahead, Staff37 Feb 37
turnstile, vhf broadcast14 Apr 36	variable light82D Mar 34	Automobile manufacturing, tube controls production, v-t devices22 June 36
two-element directional22 Apr 36	measurement, recording506 Feb 31	Automobile radio 1935 model146 May 35
vertical radiation patterns29 Apr 36	microphone switching, broadcasting152 May 34	Automobile radio problems face solution in 1932, Staff12 Jan 32
Antenna coupling systems, Marsten82 May 30	mixer circuit designs32 Nov 36	Automobile tube of increased output (LA), Bareiss96 Mar 32
Antenna radiation chart, Giacchetto55 July 39	Errata56D Jan 37	AVC, amplified, tube circuits16 Jan 33
Antenna terminations, Dietsch14 Sept 35	output transformer, flux balance161D May 35	broadcast receiver, French63D Feb 35
Antennas for air navigation (homings), Fink34 Feb 36	p-a, stereophonic, World's Fair26 July 39	double-grid tube177D May 32
Antifading antenna of Breslau199D July 33	peak voltmeter, sound recording42D Aug 38	for p-a amplifier45D May 36
Antifading antennas377D Dec 32	pre-emphasis, broadcasting29 Nov 39	p-a system with volume expansion24 July 37
Antinoise circuits52D July 36	suggested, broadcasting94D Mar 35	receiver, Wunderlich tube13 Jan 33
Apparent demodulation of weak interfering stations296D Sept 32	public address, for politics12 Sept 36	r-f input gain38D Mar 39
Apparent reactivation of tubes after long rest95D Mar 35	reactors, high-Q22 May 36	with 6E5 tuning indicator28 Oct 36
Applause meter in amateur theatrical contest155D May 34	recording equipment, disk22 Mar 38	AVC applied to audio frequency amplifier tubes, Nelson50 Feb 34
Application of copper-oxide rectifiers59D Apr 39	reference level, v-u meter28 Feb 39	AVC doubler44D Jan 36
Application of piezoelectric crystals to receivers, Batcher57 Aug 31	reverberation control, broadcasting28 May 38	Aviators warned against high-frequency hazard157D Oct 31
Application of small currents27D Jan 34	sound-distortion preamplifier14 Sept 38	
Applications of concentric transmission lines, Andrew40D Mar 37	sound-effects mixer, high-impedance56D June 38	
Applications of copper-oxide rectifiers, Beranek15 July 39	testing, sound-picture equipment502 Feb 31	
Applications of electron tubes, Staff2 Jan 35	volume compression15 June 36	
Applications of electronic engine indicators—a new use for tubes, Bloch212 July 35	volume expander, automatic184 June 35	
Applications of graphite in tube manufacture160D May 35	phonograph14 Nov 35	
Applying feedback to broadcast transmitters, Young20 Aug 39	volume indicator and attenuator22 July 38	
Applying neutralization to a-f amplifiers, Klipsch252D Aug 34	Errata9 Sept 38	
Applying police radio, Harmon22 Oct 37	wave analyzer76D Nov 39	
Arc-Back Indicator, see also Mercury Vapor Tube	Audio-frequency compensation methods, Aceves224 Dec 31	
Arc-back indicator, mercury rectifier48D Apr 39	Audio-frequency (tone) compensator methods141D Apr 32	
v-t, multiphase257 Sept 33	Audio-frequency mixer hexode228D July 34	
Area measurement, leaf, photocell49D Feb 34	Audio-frequency oscillator for a-c20D Jan 34	
Areas of leaves registered by photocells49D Feb 34	Audio level judging21D Jan 32	
Array, see Antenna	Audio level meter13 Mar 38	
Art advances (survey) Fink20 June 39	Audio program alarm36D Oct 37	
Artificial eye for blind finds doors or windows in room, Free64D Aug 31	Audio-radio distribution and control circuit, Glover15 Oct 31	
ASA standards on acoustics56D Mar 37	Audio spectrum chart120 Apr 32	
Aspects of standard-signal generator design, Crawford46 Feb 32	Audio transformers sealed in aluminum cans, Lee46D Dec 37	
Assignments in the radio spectrum, Staff274 Sept 34	Audio volume expander7 Mar 36	
Associated Press opens wire-photo system (illustr)9 Jan 35	Audiometer, hearing-aid test38D Aug 39	
Astronomer comments on the photocell, Shapley434D Dec 30	Audition panel at KFWB, Staff221 Aug 33	
Astronomy, photometry of stars49D Feb 33	Auditory perspective, three-channel music118 May 33	
Atoms & Molecules, see Particles	Audograph, a recording machine of new design60D Oct 39	
Atomic energy, voltage need635D May 31	Augetron (electron multiplier)58D Oct 39	
Atomic theory, electronics, Einstein462 Jan 31	Aurora echoes, Stormer, demonstration649D May 31	
Attenuation, see also Attenuator	Automatic adjustment for modulation indicator, Carlson40D Aug 38	
Attenuation, computing reactance39 May 36	Automatic bias generation for a-c amplifiers, Gunsolley191D June 35	
h-f transmission lines26 Apr 38	Automatic control of airport lighting135D Apr 32	
Attenuator, see also Attenuation	Automatic curve follower40D Oct 36	
Attenuator, automatic, blind landing26D Jan 34	Automatic device for the study of reverberation315D Nov 33	
balanced, design chart33 Nov 35	Automatic Direction Finder, see Direction Finder	
	Automatic egg-candling machine uses photocell228D July 32	

B

Backstage sound effects for theatres217D July 34
Baffle, see also Loudspeaker
Baffle, design for loudspeaker20 Feb 36
Balancing shaded-pole motors, Sundt36 Oct 37
Balloon antenna explores new location for WBZ36D July 31
Band amplifiers32D July 31
Band-pass (filter) characteristics, Jaderholm33 July 36
Bandspread problem, Woodhead29 Jan 37
Bar and rod heating controlled by electric eye103D Apr 38
Barkhausen circuit for ultrashort-wave reception92D Mar 34
Barkhausen-Kurz oscillator research318D Oct 32
Barreling of alcohol speeded by photocell155D May 34
Barrier-layer rectifier properties80D Mar 33
Barrier-plane photocells315D Nov 33
Barrier-plane photocells162D May 34
Bass boost, design chart37 Oct 37
Bass compensation design chart, D'Orto & De Cola37 Oct 37

BATALUM

CANDID X-RAY

	Pg—Mo—Yr
Batalum getters	48D Sept 37
Battery, dry cell internal resistance	35 Nov 36
Battery-operated device for the recovery of lost radium	64D Mar 38
Battery radio design, Marsal	12 Jan 38
BBC licenses	54D Apr 37
Beacon-marker transmitter, Nafzger	29 May 36
Beam tetrode for ultrahigh frequency	65D Sept 39
Beam tube for ultrahigh frequencies	72D June 38
Beam-controlled amplifier	40D June 37
Beam-power output tube, Dreyer	18 Apr 36
Beam-power tube, critical distance	33 May 36
Errata	48D July 36
Beat frequencies and synchronization	26D Jan 84
Beat oscillators for modern radio receivers, Manke	88 Mar 35
Beat-frequency oscillator control, Lampkin	369 Dec 32
Behavior of dielectrics	49D Apr 30
Behavior of electrons in magnetic fields	146D June 30
Behavior of half-wave rectifiers, Stout	32 Sept 39
Behavior of selenium barrier film cells	327D Oct 34
Bell Labs test coaxial cable, Staff	18 Dec 37
Bell Telephone Laboratories, Staff	43 Sept 36
Bias voltage, a-f or r-f oscillator-rectifier	191D June 35
cathode resistor computation	62D Nov 37
Bibliography, articles on electronics	68D May 37
electronic engineering texts	37 Apr 37
electronics and allied subjects	58D Oct 38
noise and noise measurements	34 Feb 39
television, from 1934	47 Mar 39
ultrasonics	34 Jan 38
Bibliography of articles on superregeneration	30D Jan 35
Bibliography on electron tubes	44D Dec 38
Bibliography on oscillation	42D Jan 36
Bibliography on television	265D Aug 32
Bit & asked communications, Bennett	12 Apr 36
Big screen television	52D May 39
Binary logarithm tables	151D Oct 31
Bioelectronics, v-t millivoltmeter	25 Nov 39
Biophysics, see also Medical	
Biophysics, cardiostachometer, electronic	14 Aug 38
Blind aids (illustr)	107 Apr 34
Blind Landing, see also Navigation Aid	
Blind landing (illustr)	26 July 37
aircraft, CAA-MIT	10 Jan 39
receiver attenuator	25D Jan 34
Blood analysis, photoelectric	293D Sept 30
Body-impedance measurements aid in medical diagnosis	36D Apr 36
Bolometer, a-c, with amplifier	38D Nov 35
Brain study, discharge tube pulses	37D Oct 35
Braun tube for direct photographic recording	48D Apr 30
Breath relay for operating electric lights	339D Oct 30
Bridge, a-c, using electrometer tubes	
v-t, measures x-ray and uv	162D May 34
ultrasensitive, bioelectric	38D Sept 39
Bridge and new compensated vacuum-tube voltmeter	49D Feb 33
Bridge balance (visual) indicator	64D Nov 37
Bridge balance, visual, 6E5	55D Jan 38
Bridge circuit, photocell	27D Jan 34
stabilized amplifier	30 Dec 39
Bridge measurements with a visual null indicator	52D Nov 36
Bridge (r-f) for testing parts	394D Dec 34
Bridge-type flux meter	44D Aug 37
Bridge-type push-pull amplifiers, Tulaszkas	134 May 33
Brighter than the sun (mercury lamp)	52D July 36
British high-fidelity receiver goes America one better	362D Nov 34
British highway safety studied with electronic instruments	46D May 36
British radio show 1935	46D Oct 35
British television plan	48D Nov 35
British vision receivers—I, Brown	26 Dec 39

	Pg—Mo—Yr
Broadcast antenna, resistance measurement	45 Feb 34
Broadcast coverage, Guy	16 May 36
Broadcast equipment, cost vs performance	40D Sept 36
Broadcast maintenance costs, Staff	25 Nov 36
Broadcast on trains	696D June 31
Broadcast station power and 1931 radio set sales, Caldwell	412 Dec 30
Broadcast station statistics, Dudley	24 Jan 37
Broadcast studio, acoustic design, German (illustr)	121 Apr 35
Broadcast tower lighting, transmission system	38D July 36
Broadcast transmission progress at CBS, Chamberlain	138 May 34
Broadcast transmitter characteristics, survey of 36 stations, Clarke & Schuttig	378 Dec 34
Broadcast transmitter (construction) features, Taylor	20 Jan 36
Broadcast transmitter measurement, using a common wavemeter, Laport	88 Mar 32
Broadcasting, see also type, e.g., A-M; F-M; High Fidelity; Television; etc.	
Broadcasting, allocations, Madrid conference	276 Sept 32
amplifier, a-f, remote pickup	28 July 39
remote pickup	38D Jan 38
and television survey	2 Jan 32
antenna, array computation	16 Aug 37
directional	362 Dec 32
directional	38D Jan 38
rotatable	30 Feb 38
apex stations	36D July 36
arc-detector, photocell	316D Oct 34
at 500-550 kc.	17 Oct 36
audio, amplifiers, low-hum	210 July 34
input console	38 June 38
level alarm	36D Oct 37
level meter	13 Mar 38
level monitoring practice	19 Oct 35
mixing control	24 Sept 37
peak limiter, low-distortion	38 June 39
reference, v-u meter	28 Feb 39
volume limiter	20 Dec 37
class-B linear adjustment	219 July 35
clear-channel sharing	216 July 32
coaxial-cable, installation	30 July 39
installation	31 Aug 39
cochannel interference	100 Sept 31
common antenna for two frequencies	13 Oct 35
facsimile, recorder	26 Jan 38
FCC, legislation	102 Apr 34
standards of good engineering practice	11 Aug 39
fidelity standards, FCC	127D Apr 35
field-strength measurements	20 Aug 36
f-m, development	188 June 35
transmitter installations	36D Feb 39
wide-band demonstration	17 Nov 35
frequency monitor, mobile pickup	22 Jan 39
frequency synchronizing	175 June 35
future of uhf region	7 July 36
gain control, electronic	58D Feb 35
harmonic measurement	425 Dec 30
high-fidelity, standards	191D June 35
summary	206 July 34
vhf	19 Jan 36
W2XR	26 Nov 35
high-frequency allocations	31 June 34
high-power allocations	13 Nov 36
international, German	163D May 34
KNX studio	20 Apr 38
legislation, statistics	156 June 33
listener opinion	118D Apr 34
Metropolitan Opera	30 Dec 37
modulation, indicator, day-night power	40D Aug 38
meter	26 July 31
monitoring	70D Sept 36
NAB convention	7 Aug 36
plate-ammeter protection	38D Feb 38
program circuit, frequency characteristic	347 Nov 34
program failure alarm	24 July 39
receiver, auto-radio	146 May 35
components and developments	20 Sept 35
1936	16 June 38
components, survey	19 Feb 37
high-fidelity trf	50D May 36
recorder in listener survey	21 Nov 38
remote amplifier, automatic	25 Aug 38
remote-pickup, amplifiers	7 Oct 38
relay transmitter	19 Oct 39
transmitter, pack-type	29 Apr 39
reverberation control	28 May 38
Russian radio plan	548 Mar 31

	Pg—Mo—Yr
Broadcasting (cont'd)	
short-wave receiver, Ottawa	42D Sept 35
transmitter	23 Dec 37
Sommerfeld formula	23 Dec 36
studio, acoustic treatment, WCAU	358 Dec 32
NBC Hollywood	19 May 39
Radio City	324 Dec 33
synchronization	54D Feb 34
synchronized transmitters, time delays	124 May 33
time signal, automatic	246 Aug 35
transmitter, adjustments	15 July 36
Errata	56D Jan 37
and antenna, KYW	6 Jan 35
high-fidelity	144 May 34
high-power	136 June 30
inverse-feedback	20 Aug 39
measurements	88 Mar 32
remote pickup	40D Sept 35
siting	66 Mar 33
synchronizing	423 Dec 30
WOR	38 Feb 35
tube replacement cost	113 Apr 33
typical European stations	54D Feb 33
uhf experimental, W8XH	114 Apr 35
vhf, turnstile antenna	14 Apr 36
volume compression	15 June 36
volume indicator and attenuator	22 July 38, 9 Sept 38
water cooling for tubes	24 Oct 38
wired-radio, Europe	44 Feb 36
WJZ new tower	21 Jan 37
Broadcasting on 546 kc, Babits	32D Jan 37
Broadcasting on 7.85 meters at Amsterdam	378D Dec 32
Broadcasting over telephone wires	195D June 35
Broadcasting station costs	254 Aug 34
Broadcasting station costs, installation and maintenance	688 June 31
Bucking voltage for plate milliammeter	162D Oct 31
Building an engineering organization, Baker	62 May 30
Building bridges by radio, Tibbetts	7 Sept 35
Building neon-tube signs (illustr)	51 Aug 31
Burglar alarm employs space principle	254D Sept 33
Buying habits and replacements for sound equipment, Staff	686 June 31
Buying habits of radio set manufacturers, Staff	692 Apr 31
Buying radio materials by specification, Glover	16 July 31
Bypass condenser production test equipment, Stellwagon	504 Feb 31

C

Cabinet, broadcast receiver	
design	590 Apr 31
design, broadcast receiver	146 May 34
molded, plastic, design	16 June 39
receiver, broadcast, design	182 July 33
styling, broadcast receiver	62 Mar 33
broadcast receiver	88 Apr 34
Cable, telephone, characteristics	341 Nov 34
Errata	23D Jan 35
Cables for ship-guiding	146D June 30
Calculator, see also Computing	
Calculation of loudspeaker efficiency, Wolff	52 Feb 32
Calculation of triode constants, Fremlin	76D Nov 39
Calculation of vertical antenna radiation patterns, Laport	46 Feb 36
Calibrating radio frequency ammeters with photocells	40D Apr 37
Calibration of grid gain controls, Watson	24D July 31
Calibration of low audio frequencies, Melsner	137D May 33
Calibration of microphones, Oison & Goldman	106 Sept 31
Calibration of microphones	109D Apr 33
Camera, television, scanning disk	69 Aug 31
Can radio sets be sold to Europe? Laszlo	229 Dec 31
Can radio tubes be sold abroad? Laszlo	92 Mar 32
Canada installs short wave receiver for British programs	42D Sept 35
Candid camera x-ray	54D Feb 39

CAPACITANCE

COLOR

Pg—Mo—Yr	Pg—Mo—Yr	Pg—Mo—Yr
Capacitance, see also Capacitor; Condenser		
Capacitance alarm26 Feb 37	Cathode-ray oscillograph without glass parts299D Sept 30	Cheater circuit for synthetic testing of mercury-vapor power tubes, Zehner224 July 39
Capacitance change measurement27D July 34	Cathode-ray phasemeter, Bagno & Barnett24 Jan 38	Checking glass for goggles18D June 35
Capacitance change measurement18 Mar 38	Cathode-ray polar diagram indicator46D Oct 39	Chemical applications of photo-tubes74D Sept 35
Capacitance control, v-t, applications30 Oct 35	Cathode-ray recorder remembers by means of fluorescence delay36D Jan 36	Chemical materials used in television apparatus40D Sept 35
Capacitance measurement, h-f140D May 33	Cathode-ray scanner for televising film46D July 36	Chemical Process Control, see also Process Control
Capacitance of a diode68D June 38	Cathode-ray screen photography, Staff37 Apr 38	Chemical process control684D June 31
Capacitance operated relays, space alarm35D Apr 37	Cathode-ray time axis and blocking circuits347D Dec 33	Chemistry, electron-tube techniques166 July 30
Capacitance relay, for talking mirror36D Feb 37	Cathode-ray time base242D Dec 31	Chireix system of plate modulation29D Jan 37
Capacitive and inductive coupling395D Nov 30	Cathode-ray transient oscillograph58D Jan 37	Chlorine regulator, water supply, phototube103D Apr 39
Capacitor, see also Condenser		Choice of tubes for wide-band amplifiers, Pollack38D Apr 39
Capacitor, electrolytic, characteristics596 Apr 31	Cathode-Ray Tube (CRT), see also Oscilloscope; Tube	Cigars wrapped with phototube's aid157D May 35
electrolytic, etched foil30 May 37	Cathode-ray tube, measuring characteristics52D May 36	Circle diagram, tube circuits23 May 39, 49D Oct 39
filter, paper vs electrolytic160D May 35	phosphor characteristics31 Dec 38	Circle diagrams for tube circuits, Nims23 May 39, 49D Oct 39
gas-dielectric, high-pressure16 Apr 39	screen potential69D Oct 38	Circuit Court judges' opinions in the Langmuir high-vacuum patent case, Staff476 Jan 31
i-f tuning, manufacturing technique690 June 31	Cathode-ray tube applications, Stinchfield153 May 35	Circuit design related to tube performance, Hollands18 Mar 39
impregnated-paper, life54D June 38	Cathode-ray tube applications38D June 36	Circuit for determining heating time of vacuum tubes, Koehler298D Sept 32
inductance change, frequency199D July 33	Cathode-ray tube detector46D Mar 36	Circuit theory, frequency modulation58D Feb 38
life test, accelerated114D Sept 31	Cathode-ray tubes for oscillograph purposes, Taylor, Headrick & Orth332 Dec 33	Circuits for amplified automatic volume control, Staff16 Jan 39
mass-production28 Sept 39	Cathode-ray tubes in mass production56D July 39	Circuits for light sensitive cells114D Sept 31
150-ampere, broadcast transmitter130D Apr 35	Cathode-ray tubes in the making (illustr)32 Apr 39	Circuits for politics, Rahmel & Warriner12 Sept 36
padder, for tracking in receiver40 May 37	Cathode-ray tube used to test fuses, Sundt316D Oct 34	Class A push-pull calculations, Houghton18 June 37
superheterodyne receiver160 May 32	Cathode-ray waveform distortion at ultra-high frequencies, Bowie18 Feb 38	Class B and AB audio amplifiers, Koehler14 Feb 36
plate-shape, bfo369 Dec 32	Cathode-ray wave generator, for music38D Jan 37	Class B r-f amplifier chart, Staff41 Nov 37
pressure-type, construction60D Aug 39	CBS builds new home for KNX, Staff20 Apr 38	Cleaning air with high voltage (illustr)35 Nov 37
temperature-coefficient with heater15 May 39	CBS develops portable audio measuring set46D Feb 39	Clean-up of hydrogen by magnetron314D Nov 32
testing, limit, phototube16 Jan 32	Cell space ratio in wood by a photoelectric method290D Sept 34	Clock, driven from d-c26 Feb 37
production504 Feb 31	Cement bags registered by photocells49D Feb 34	Closed throat opened by short-wave heating, Free197D Nov 31
variable, design for tracking180 June 34	Cement fineness, by turbidimeter15 Jan 24	Coaxial Cable, see also Transmission Line
and resistor testing, production279 Sept 34	Central antenna system, Fruin37 Nov 39	Coaxial cable, NYC and Philadelphia189 June 35
calibrator, at r-f, substitution318 Oct 34	Centromatic unit, Staff16 Oct 35	NYC and Philadelphia, tv test18 Dec 37
Capacitor leakage tester44D May 36	Ceramic materials, mechanical and electrical properties33 Apr 39	Coaxial cable installation, Epperson30 July 39
Capacitor losses at 4 mc261D Aug 35	Ceramics as insulators, Staff7 Feb 37	Coaxial cable used on German television circuit54D May 36
Capacitor tester, neon-tube type22D Jan 35	Ceramics, h-f, characteristics48D Feb 33	Coaxial line installation—II, Epperson31 Aug 39
Capacity-operated a-c relay34D June 36	Cesium atoms in cesium, cesium oxide on metal316D Nov 33	Cobalt alloy filament232D Dec 31
Capacity-operated relay applied to furnace heat control46D Nov 37	Cesium-oxygen silver photocell49D Feb 33	Cobalt, magnetic properties, 3-cm waves (NRA) and the Engineer, Hull246 Sept 39
Capital and annual costs of 100 watt broadcast stations, Staff308 Oct 34	Chairman addresses shareholders by television194D June 34	Coll, see also Inductor
Cardiotachometer, electronic14 Aug 38	Change in maximum ratings of receiver tubes48D Dec 39	Coil design for short-wave receivers, a study of 15 mc inductances, Staff174 June 34
Carrier Current, see also Communications; Telemetering	Changes in sunspot numbers 1923 to 1932 give clue to radio vagaries, Staff69 Mar 33	Coil testing methods for use in radio plants, Messing248 Aug 35
Carrier current, control, electric utility98D Mar 32	Changeover unit (rectifier)75D Mar 39	Cold-cathode amplifier tube, Reich & Hoeselberth282 Oct 33
radio program distribution682 June 31	Characteristics of American electronic tubes (chart) Henney308 Oct 32	Cold-cathode amplifiers396D Nov 30
telegraph service268 Sept 34	Characteristics of British cathode-ray tubes36D July 37	Cold-cathode amplifying tubes131D Apr 35
Carrier current communication58D Feb 34	Characteristics of gas-filled photocells80D Mar 33	Cold-cathode 110-volt gaseous illuminant, Staff140 Oct 31
Carrier current intercom159D May 34	Characteristics of German radio receivers, Schrage360 Oct 34	Cold-cathode oscillator drives power tube in transmission test22D Jan 35
Carrier system, wired radio46D July 38	Characteristics of insulated wires used in radio set production, Zender18 Jan 34	Cold-cathode tube developed for telephone service36D Feb 37
Carrier Telephone & Telegraph, see also Carrier Current	Characteristics of magnetron oscillators60D Mar 39	Cold filamentless radio tube, Hough182 Nov 31
Carrier telephony, Scotland-Ireland52D Dec 37	Characteristics of 1934 tubes, Mimno151 May 34	Cold tubes in Germany—Dr. Seibt's patents, Staff183 Nov 31
Case for high power (broadcasting), Staff13 Nov 36	Characteristics of phosphors52D Mar 39	Colloidal graphite in electronics field, Szymanowitz87D Mar 34
Catechism on iron for radio tubes124D Apr 34	Characteristics of phosphors for cathode-ray tubes, Staff31 Dec 38	Color analyzer plots own curve, Staff17 Mar 36
Catenary volume control20D Jan 34	Characteristics of photovoltaic cells348D Oct 30	Color comparator, textile, photocell250D Aug 30
Cathautograph, DuMont7 Jan 33	Characteristics of small thyatrons120D Sept 31	Color definition by photoelectric measurements, Ellsworth & McMichael320 Oct 30
Cathode, barium coating, v-t390 Nov 30	Characteristics of the new low-drain tubes for battery receivers, Staff122 June 30	Color matching in automobile plant162D June 32
copper, saves power44D June 36	Characteristics of the Photronic cell168D May 32	Color matching in the paper industry, Deeter18 Sept 38
corrugated, gas-filled tube280 Oct 33	Characteristics of variable-mu tetrodes, Henney540 Mar 31	Color sensitiveness of photoelectric cells, Hess220 Aug 30
nickel and barium alloys244 Sept 33	Chart for simple attenuator design, Waltz247 Aug 34	
oxide-coated67D Feb 32	Chart surveying by electronic methods60D Feb 32	
radioactive and photoelectric17 Jan 32	Charts for solving wire problems, Waterman232D Dec 31	
self-protecting, vapor tube26 Dec 35	Charts for transformer design14 Oct 35	
thoriated tungsten50D Jan 39		
Cathode follower, television amplifier56D Apr 39		
Cathode ray for the unh. Libby15 Sept 36		
Cathode-ray aircraft compass, Ostrolenk12 Aug 36		
Cathode-ray amplifier (beam-grouping) tubes, Fink9 Apr 39		
Cathode-ray antenna phasemeter, Taylor62D Apr 39		
Cathode-ray deflection of r-f voltages194D June 34		
Cathode-ray frequency multiplier264D Aug 32		
Cathode-ray null indicator, McNulty36D Sept 38		
Cathode-ray oscillograph applications, Mayer14 Apr 38		
Cathode-ray oscillograph finds use in oil-burner equipment industry38D July 36		
Cathode-ray oscillograph research648D May 31		
Cathode-ray oscillograph timing axis, Brewer222 Dec 31		

COLORIMETER

DENSITY

Pg—Mo—Yr

Pg—Mo—Yr

Pg—Mo—Yr

Colorimeter, see also Spectrophotometer

Colorimeter, analyzer plots curve. 17 Mar 36
 low-voltage, photoelectric. 104D Apr 33
 photoelectric, for process control. 36D Jan 36
 instrument survey. 128 May 33
 phototube. 342D Nov 32
 two-tube comparator. 28 Mar 37
 Combination tones in nonlinear systems, Massa. 20 Sept 38
 Comment. 61D Feb 39
 Combined audio-frequency amplifier coupling. 142D Apr 32
 Combined photo and amplifier tubes, McIlvaine. 224D Aug 33
 Coming industrial markets, Henney. 288 Sept 30
 Commercial facsimile apparatus (illustr). 71 Mar 34

Communications, aircraft and police

installations. 270 Sept 34
 amateur receiver design. 20 Dec 36
 auto alarm for ships. 20 Apr 37
 bfo, c-w reception. 88 Mar 35
 equipment and components, survey. 16 June 38
 fire boat, NYC. 10 Apr 38
 flying the Pacific by radio. 6 Apr 36
 France-Corsica, 8-meter. 378D Dec 32
 mobile, marine radiophone. 11 Mar 39
 modulator, bridge-rectifier. 28 Mar 38
 police-radio, installations. 8 Jan 33
 receiver economics. 22 Jan 32
 statistics. 82D Mar 34
 systems. 74 Mar 34
 portable, Forest Service. 83D Mar 34
 Forest Service. 9 Feb 39
 radiotelephone, ship-shore. 9 Sept 37
 receiver, aircraft all-wave. 336 Oct 30
 remotely tuned. 14 Dec 38
 1,724-mc, English channel. 127D Apr 34
 system requirements for police. 22 Oct 37
 timing driver reaction. 119D Apr 34
 trans-Atlantic radiophone, tubes. 38 Apr 30
 ubf, for utility service. 40D Jan 36
 vhf, monitor, police radio. 38D Feb 38
 remote control. 17 Feb 36
 San Francisco Bay bridge. 7 Sept 35
 wire, stock market. 12 Apr 36

Communication—an electron-tube

art, Staff. 268 Sept 34

Communication on the quasi-optical

frequencies, Karpus. 666 June 31

Communications equipment in disaster service

44D Oct 39

Commutator roughness measurement

59D Sept 36

Compact remote amplifier,

Duncan. 28 July 39

Comparator, overcomes static, trans-

Atlantic phone. 317D Oct 34

Comparison of photocells.

171D June 33

Comparison of properties of electrons, positrons, etc.

44D Mar 36

Compensated amplifier chart, Liu & Trimmer.

35 Sept 39

Compensated anode milliammeter

as overload control. 162D Oct 31

Compensated d-c amplifier.

94D Mar 34

Compensating circuit for blocking-layer photoelectric cells.

48D Dec 37

Components, and materials, purchase

by specification. 16 July 31

electronie apparatus, aids to

production. 90 Apr 33

IRE symposium, cost vs

quality. 210 Aug 33

prices, electronic industry.

64 Mar 33

Q-values.

126D Apr 35

sales and purchase policies.

592 Apr 31

television receiver.

18 May 39

Components for 1938 radio sets,

Staff. 37 Sept 37

Computing antenna height, Jinks.

30 July 38

Computing reactance attenuation,

Bechberger. 39 May 36

Concentric folded horn design,

Sanial. 16 Jan 39

Concentric line terminations.

16 Dec 36

Concerning pervance.

60D June 38

Condenser, see also Capacitor

Condenser discharge chart, Hoag. 20 Sept 37

Condenser-lead resonance chart, Haskins. 35 Aug 39

Condenser tracking test set, Roemisch. 12 Mar 37

Consider these things in applying electronic door openers, Bendz. 14 Feb 38

Considerations on detector-output tube systems, Nelson. 94 Apr 33

Constant-amplitude oscillator. 54D Feb 33

Constant bandwidth filter. 164D Oct 31

Constant d-c voltages by means of discharge tubes. 127D Apr 34

Constant-frequency superheterodyne receiver, Dueno. 38D Aug 39

Consultant talks about electronics, McDill. 11 Sept 38

Contactless volume control, Polk. 40D Sept 39

Contact, see also Relay

Contact, neon-tube and amplifier. 77D Aug 31

Contacts, relay, how to protect. 29 Dec 38

industrial, photocoil. 52D Feb 39

Continuous weighing with light-sensitive telepoise, White. 60D Feb 32

Contribution to electric circuit theory. 58D Feb 38

Control, see also type, e.g., Motor; Industrial; Process; etc.

Control, circuit, without standby power. 11 Dec 37

circuits, v-t, light and space. 38D Sept 35

electronic vs magnetic relay. 93D Mar 34

industrial, photocell. 227 Aug 30

v-t, tube factory. 121 May 33

remote, vhf. 17 Feb 36

Control by nonlinear circuits. 19D Jan 33

Control of sound quality in picture production, Dreher. 10 Jan 33

Control of station frequencies in England. 140D Apr 32

Control of window lighting by tube circuits. 229D July 32

Control of wood-pulp cooking. 75D Mar 33

Controlling chemical processes by electron devices, Lee. 684D June 31

Controlling cut-off knives for accurate packaging. 556D Mar 31

Controlling of water supply. 103D Apr 33

Controlling receivers from the broadcast transmitter, Staff. 327 Dec 33

Controlling street lights and water heaters by carrier currents, Bartlett. 98D Mar 32

Convection currents in mercury arcs. 52D Mar 38

Conversion conductance in frequency-changer tubes. 166D May 35

Converter, see also Mixer

Converter, circuit, superheterodyne receiver. 76 Mar 33

circuits, superheterodyne. 28D Jan 35

receiver, screen-grid. 378D Dec 32

television, single-unit. 31 Feb 38

tubes, British. 228D July 35

Converting pentode characteristics. 323D Oct 34

Co-ordinate, polar-to-rectangular chart. 42 Nov 39

Co-ordinating the new tubes, Staff. 36 Mar 38

Copper-cuprous oxide cells. 92D Mar 34

Cornstalk acoustical board. 52D Apr 38

Correct and incorrect uses of tubes. 327D Oct 34

Correct presentation of receiving circuits. 127D Apr 34

Corrections. 206D Nov 31

Correlation between radio and passage of storms. 169D May 32

Cost of engineering radio sets. 95D Mar 32

Cost versus quality in radio set components, Staff. 210 Aug 33

Costs in radio-tube manufacture, Conway. 222 July 32

Counter, see also Scaler

Counter, scaler for high speed. 7 Jan 34

Counting crates on conveyors. 14D Jan 33

Counting traffic, Staff. 275 Sept 34

Counts 25,000 per hour. 60D Jan 38

Coupling, interstage, glow discharge tube. 258D Aug 34

C-R tube photography, Rogers & Robertson. 19 July 39

Critical distance (beam) tubes, Harries. 33 May 36

Errata. 48D July 36

Cross-beam reflectometer for surface comparisons. 30D June 37

Cross-section of electron beam and nature of gas. 316D Nov 33

Cross-talk frequencies. 130D Apr 35

CRT (cathode-ray tube) brightness vs plate current. 315D Nov 33

British, characteristics. 36D July 37

for decimeter waves. 198D July 33

medium-voltage type. 346D Dec 33

oscilloscope, high-brilliance. 158 May 32

CRT shows tube characteristics. 30 July 37

Crystal control for ultrashort-waves. 46D Nov 35

Crystal coupling for high-quality i-f circuits. 256D Aug 35

Crystal Detector, see Detector

Crystal microphone design for single-direction pickup, Williams & Arndt. 242 Aug 35

Crystal monitor for checking police radio, Kulberg. 38D Feb 38

Crystal mounting, elimination of parasitics. 32D July 31

Crystal oscillator, lead sulfide. 33D July 31

Crystal oscillator of Pierce. 92D Mar 34

Crystal oven, thermostat control. 253D Sept 33

Crystals, lithium fluoride, in atomic research. 38D Jan 36

Cubical television antenna for GE station at Albany. 51D Apr 39

Cuprous-oxide rectifier life tests. 18D Jan 33

Current articles on electronics and related subjects. 53D Oct 38

Current articles on electronics and related subjects. 58D Nov 38

Current impulses of rectangular waveform. 204D Nov 31

Currents in grid-controlled discharge tubes below the starting potential. 162D May 34

Curve follower, automatic. 40D Oct 36

Curve plotter and comparator, Isler. 361 Dec 32

Curve plotter, automatic for color analyzer. 17 Mar 36

Cyclotron, see also Particles

Cyclotron, design and technique. 44D Jan 39

oscillator, 12-mc. 7 Nov 35

D

Data curves on GE blocking layer photocells.

42D Mar 36

Daylight control of factory lighting saves electricity. 14D Jan 33

Daylight intensity controlled by photocells. 186D June 34

DB meter, linear. 54D Oct 39

D-C amplifier for industrial use. 51D Apr 39

D-C amplifier for logarithmic recording, Taylor. 24 Mar 37

D-C amplifier for measuring potentials in living organisms, Lane. 31D June 37

D-C amplifiers. 81D Mar 33

D-C inverter for radio receivers, Baker & Cornell. 152 Oct 31

D-C transformers. 57D Jan 38

D-C voltage stabilization, Kohler. 388D Dec 34

Decibel chart, network problems. 60 Aug 31

Decimeter waves. 28D Jan 32

Decimeter waves by ordinary reaction. 322D Oct 32

Decimeter waves, wavemeter. 45D May 36

wavemeter. 40D Aug 36

Decoying geese with loud-speakers. 156D May 35

Deep-sea fishing levels studied by photocells. 15D Jan 34

Defective vision classes get brighter lighting. 317D Oct 34

Definite frequency attacks furunculosis. 15D Jan 34

Definition of standard reference systems, Hillard. 192D Nov 31

Definitions of electrical terms. 54D Oct 37

Deflection control, amplifier tube. 45D May 36

Deflection control tubes, Hazeltine. 14 Mar 36

DeForest's invention of radio knife in 1907, DeForest. 85D Aug 31

Degeneration, see also Feedback

Degeneration in television amplifier. 56D Apr 39

Delivering electrons outside the tube, Dennington. 294 Sept 30

Demodulation, see also Modulation

Demodulation of weak signals. 297D Sept 32

Demodulation, weak signal, by strong. 171 May 32

Demonstration of Baird large-screen television. 48D Sept 39

Densitometer, for motion-picture film. 285D Sept 34

in highway safety study. 46D May 36

Density distribution of electron gas in equilibrium with a hot body, Waterman. 45 Apr 30

DENTISTRY

EFFECT

	Pg—Mo—Yr
Dentistry and the radio knife	186D June 35
Dependable selenium cell relay circuit	42D Apr 37
Depressed propagation for broadcasting	58D Feb 34
Depth sounding, geodetic surveys	60D Feb 32
locating fish	132 May 33
ship navigation	134D Apr 32
ultrasonic, phototube	90D Mar 35
Depth-sounding by radio, Staff	20 Oct 36
Design and manufacture of receiving tubes	52D Jan 37
Design and performance of a voltage regulator	48D Mar 39
Design and technique of the cyclotron	44D Jan 39
Design and use of acorn tubes for ultrahigh frequencies, Salzberg	282 Sept 34
Design data on thyratron characteristics	38D June 37
Design of a portable signal generator, Kruse	285 Sept 30
Design of apparatus for outgassing electrodes	53D Mar 37
Design of attenuation networks, Lanterman	508 Feb 31
Design of exponential horns of square cross section, Logan	33 Feb 39
Design of oscillator circuit for superheterodyne receivers	46D Jan 39
Design of output transformer, Hitchcock & Osbon	381 Nov 30
Design of tone-control circuits, Jarvis	230 Aug 30
Design problems of power pentodes for radio receivers, French	576 Apr 31
Design problems of sound-on-film for home movies, Koenig	621 May 31
Designing tubes with exponential characteristics	326D Oct 34
Details of British television systems announced	48D Jan 36
Detecting adulteration with filtered ultraviolet or black light	388D Nov 30
Detecting impurities in sand with the photocell	27D Jan 34
Detection, see also Detector	
Detection, linear, heterodyne signals	386 Nov 30
plate type, theory	30D Jan 32
theory	59D Feb 34
Detector, see also Detection	
Detector, binode circuit, amplifier	23D Jan 33
binode, circuits	228D July 34
cathode-ray tube	46D Mar 36
diode, distortion sources	63D Feb 35
high-level, plate, self-bias	14 July 31
impulse, for television	54D July 39
linear, distortion in	386 Dec 34
phototube, locates moving object	26 Oct 35
power, pentode tube	126 Apr 32
push-pull, declimeter waves	59D Feb 34
high fidelity	68D Feb 32
small-signal, graphical approach	641 May 31
stopping-plate type	128D Apr 34
10-cm, positive-grid	259D Sept 33
tetrode, overload extension	228 Dec 31
v-t, characteristics	99D Mar 35
weak-signal demodulation	171 May 32
weak-signal demodulation	296D Sept 32
weak-signal demodulation	297D Sept 32
Detects metal particles in food manufacture	355D Nov 34
Determination of natural physical constants	55D Oct 39
Determination of particle size by electron diffraction, Porter	44D Oct 36
Determining field distribution by electronic methods, McArthur	192 June 32
Development of B-battery devices for auto radio, Staff	80 Mar 32
Development of insulating materials, Kruse	72 May 30
Developments in aircraft radio area, Fink	20 Feb 38
Developments in automatic record changers, Irby	584 Apr 31
Developments in German receiver design, Schrage	46D Oct 35
Developments in 1938 receivers, Dudley	13 Aug 37
Developments in ultrahigh frequency generation, Loeber	376 Nov 30
Device for measuring the height of ionized layers	238D July 32

	Pg—Mo—Yr
Device for temperature regulation of mercury-vapor tubes, Stansbury & Brown	104D Apr 33
Devilometer permits aviator to set course at angle	471D Jan 31
Dial mechanisms, Staff	21 Nov 35
Dial, movie, broadcast receiver	53D Jan 39
Diathermy, dosimeter, short-wave treatment	52D Nov 39
electron tube devices	16 Nov 36
Comment	32D Jan 37
equipment and theory	338 Nov 32
frequency sensitivity	32D Jan 37
interference source discovered	19 Feb 36
kills weevils in wheat	75D Mar 33
opens caustic scar	197D Nov 31
therapeutic equipment	56 Feb 32
Diathermy interference study	50D Mar 37
Dielectric constant measurement	264D Aug 32
Dielectric constant, resonance method	25D Jan 34
Dielectrics, plastics	10 Mar 36
Different amplifier tube	45D May 36
Differential regeneration	205D June 32
Differential selenium obverse photocell	23D Jan 33
Diffraction, electron, industrial application	84 Mar 32
electron, in metallurgy	50D Feb 36
shows particle size	44D Oct 36
Diffraction of electrons, Phillips	24 Sept 35
Diffusion of hydrogen, through steel	46D Oct 37
Diode-triode peak voltmeter, Barber	322D Oct 34
Direct-coupled push-pull oscillograph driver stage	40D Aug 37
Direct-current amplifier for photocell applications, Gilbert	44D Jan 38
Direct-current amplifiers	292D Sept 34
Direct-current amplifiers:	
a review	42D Mar 38
Direct-current multiplier	34D June 36
Direct disc recording, Lebel	22 Mar 38
Direct-reading meters for tube measurements, Koechel	381 Dec 34
Direct-reading short-circuit test for vacuum tubes, Richardson	233D July 32
Direct-reading vacuum-tube millivoltmeter, Lyons & Heller	25 Nov 39
Direction Finder, see also Navigation Aid	
Direction finder, automatic, Sperry-RCA	10 Jan 39
flying the Pacific by radio	6 Apr 36
for small boats	8 Apr 37
panoramic receiver, crt	36D July 38
fishing dories	217D July 34
Directional Antenna, see also Antenna	
Directional antenna for new KYW at Philadelphia	359D Nov 34
Directional array field strengths, Rumble	16 Aug 37
Directional characteristics of loudspeakers for theatres, Maltz	186 July 30
Directional microphone with controlled characteristics, Ebel	40D Nov 38
Directional (two-element) antenna design, Laport	22 Apr 36
Directional (two-element) radiation patterns, Ebel	29 Apr 36
Directive antennae for broadcast stations, Wilmotte	362 Dec 32
Disc-cutting problems, LeBel	17 Dec 39
Disc television in Japan	50D Oct 35
Discharge tube circuit used in study of brain	37D Oct 35
Discharge tube for relay contacts	52D Feb 39
Discharge tubes in radio sets	42D Jan 36
Discovers neutron, bound positive and negative particles	103D Mar 32
Discriminator, for afc	28 Sept 36
in afc circuits	20 Nov 36
Distance range of radio waves (illustr)	163 May 32
Distant control with very short waves	396D Nov 30
Distortion, crt, cause and correction	16 Jan 35
harmonic, emitter effect	92D Mar 34
power pentode	118 June 30
tube circuit	78 May 30
in linear detector	386 Dec 34
loudspeaker, deflection measurement	474 Jan 31
pentode amplifier	142 Oct 31
screen-grid tube, theory	323D Oct 32
Distortion factor and summation tones in radio receivers, Graffunder, Kleen & Wehnert	48D Nov 35

Distortion in pentodes	228D July 35
Distortion in sound film recording and reproducing	49D Apr 30
Distortion limiter for radio receivers, Levy	26 Mar 38
Distortion of photocell amplifying circuits	128D Apr 34
Distortion of sawtooth waveforms, Von Ardenne	36 Nov 37
Distortion produced by space charges in cathode-ray tubes	258D Sept 33
Distortions in the output stage	71D Sept 39
Distributed capacitance chart, Massaut	31 Mar 38
Distribution of current in pentodes and hexodes	53D Feb 37
Distribution of space charge	49D Apr 34
Diversity reception, dual, radiotelegraph	48D Aug 39
Dollar cost of broadcasting stations, Staff	688 June 31
Dollar cost of tone quality, McCanne	97 Sept 31
Dollar value of tone fidelity, Staff	616 May 31
Door opener, photoelectric, in electronic installation	14 Feb 38
Door (photocell) for invalids at Warm Springs, Ga.	154D May 34
Dosimeter, x-ray, Mekaplon	62 Aug 31
Dosimetry in short-wave therapy, Mittelmann	52D Nov 39
Double-beam cathode-ray tube, von Ardenne	31 Oct 36
Double-grid tubes as fading compensators	177D May 32
Drafting, circuit layout	127D Apr 34
Dramatic use of controlled sound, Urquhart	252D Aug 35
Drive-in movie, Staff	209 Aug 33
Dry cell resistances, Gray	35 Nov 36
Dual-diversity reception simplified, Silver	66D Mar 39
Dual-frequency audio source for general laboratory use, Lampkin	417 Dec 30
Dummy load, r-f power	30 Feb 36
Dynamic loudspeaker design, Goeth	66 Aug 31
Dynamic loudspeaker design—II, Goeth	112 Sept 31
Dynamic microphone amplifier for sound news recording, Sanial	52 Feb 34
Dynamic speaker design—I, Barfield	188 June 32
Dynamic speaker design—II, Barfield	257 Aug 32
Dynamic tube measurements over wide ranges of values, Tuttle	344 Nov 32
Dynatron, grid tank circuit	482D Jan 31
Dynatron oscillator	68D Feb 31
Dynatron oscillator, inner grid	25D Jan 34
Dynatron vacuum-tube voltmeter, de Cola	623 May 31
e/m determination, precision	62D Mar 39

E

Eccles-Jordan, trigger circuit	14 Aug 39
Echo period and audience sound absorption in concert halls	48D Nov 35
Economic evolution with the introduction of sound pictures, Irby	30 Apr 30
Economical design for radio set transformers, Hultberg	286 Sept 34
Economical design for radio set transformers, Hultberg	310 Oct 34
Economics in broadcast equipment design, Andrew	40D Sept 36
Economics of police radio reception, Lampkin	22 Jan 32
Economics of theater maintenance, Waltz	225 July 32
Eddy-current oven roasts coffee	46D Sept 38
Edgerton stroboscope in microscopic photography	94D Mar 35
Efficiency of horn loudspeakers, Massa	30 Apr 37
Efficiency of oscillating tubes in the ultrashort range	292D Sept 34
Efficient crystal oscillator	52D Oct 39
Effect of grids on electric waves	55D Aug 39
Effect of metallic shields on tuning coils	259D Sept 33
Effect of microphone polarity on percentage modulation, Hathaway	28 Oct 39

EFFECT

ELECTRONS

Pg—Mo—Yr

Pg—Mo—Yr

Pg—Mo—Yr

- Effect of spark suppressors on auto performance 54D Feb 34
- Effect of ultrashort waves on living organisms 348D Oct 30
- Effect of x-rays on barrier-layer cells 141D May 33
- Effects of optical slits in light-valve sound recording, Livadary 54 Aug 31
- Effects of optical slits in variable area sound recording, Livadary 587 Apr 31
- Effects on reception of over-modulation, Kilgour 9 Jan 32
- Egg-candler, phototube 228D July 32
- Eight-meter communication, France-to-Corsica, 120 miles 378D Dec 32
- Einstein and the electron, Sheldon 462 Jan 31
- Elaborate horse-race timer uses five phototubes 34D Apr 37
- Elaborate temperature monitoring equipment installed in new alloy furnace 33D Aug 38
- Electone, an electronic piano, Taylor 26 Jan 39
- Electric ear analyzes motor noises 685D June 31
- Electric ear solves tire-design problem 119D Apr 34
- Electric eye in blood analysis 293D Sept 30
- Electric eye now enters industry (survey), Staff 132 Oct 31
- Electric eye sees through fog 557D Mar 31
- Electric eye separates chemicals 430D Dec 30
- Electric eye to detect counter-felts 135D Apr 32
- Electric eye watches bowling-alley foul line 371D Dec 32
- Electric-eying telegrams, Bennett 22 Mar 36
- Electric photographic timer 56D Jan 37
- Electric timing device, Carlson 28 Oct 38
- Electric wave filters for high frequencies, Frederick 84 Mar 34
- Electrical device guards radium workers 40D Feb 36
- Electrical impulses in ear-nerve work loudspeaker 299D Sept 30
- Electrical music 298D Sept 30
- Electrical properties of rubber at radio frequencies 286D Oct 33
- Electrical properties of soil at radio frequencies 440D Dec 30
- Electrical properties of the two-wire telephone relay 286D Oct 33
- Electrical protection for discharge tubes 52D Aug 39
- Electrical recorder put to new use 65D Aug 31
- Electricity in medicine 44D Aug 38
- Electrocardiograph, crt,**
tripotential 28 Jan 38
- Electrocardiograph (illustr) 377 Nov 30
- Electrochemistry, acid and alkali measurement 232D July 32
- Electrodeless neon tubes excited by radio frequency energy 34D Oct 38
- Electrodynamic metal-foil loudspeaker efficiency 228D July 34
- Electroencephalography, amplifier-recorder 11 Oct 39
- Electrolytic capacitor testing in production,** Deeley 215 July 35
- Electrolytic condensers 58D May 39
- Electrolytic condensers for radio use, Godsey 598 Apr 31
- Electromagnet (without coil) 56D Aug 37
- Electrometer tube, and radioactive material** 163D Oct 31
- applications 148 Oct 31
- Errata 206D Nov 31
- balance circuit 259D Sept 33
- Electron—and beyond,** Karapetoff 37 Apr 30
- Electron beams, at low gas pressure 198D July 33
- Electron control for high-speed motion pictures, Fink 250 Aug 34
- Electron-coupled a-f oscillator, Stahl 56D May 36
- Electron-coupled transmitter used in Malaya 259D Aug 34
- Electron devices in d-c power transmission, Stone 554 Mar 31
- Electron devices used in the spark plug industry 44D May 36
- Electron emission from oxide-coated filaments 141D May 33
- Electron emitting alloys of nickel and barium, Randolph, Duffenack, & Wolfe 244 Sept 33
- Electron in new roles (illustr) 99 Sept 31
- Electron influence upon interelectrode capacity 163D May 34
- Electron—its characteristics (illustr) 181 July 30
- Electron lenses 68D Nov 38
- Electron microscope hunts chemical affinities, Free 55D Feb 35
- Electron microscopes, Staff 30 Nov 38
- Electron multiplier, Staff 242 Aug 34
- Electron multiplier design 50D July 38
- Electron multiplier, microwave modulator 50D June 38
- Electron multipliers 60D Sept 36
- Electron operated thermostat 58D Nov 38
- Electron Optics, see also Optics**
- Electron optics 60D Apr 39
- Electron, origin of word 395D Nov 30
- Electron paths in electric fields 50D Oct 37
- Electron patterns (illustr) 28 June 37
- Electron speeds reach 167,000 miles per second (illustr) 5 July 31
- Electron telescope, Staff 10 Jan 36
- Electron theory 64D Feb 38
- Electron Tube, see also Tube**
- Electron tube—a universal tool in industry (listing), Caldwell 10 Apr 30
- Electron tube as a saver of life, De Forest 223 Aug 30
- Electron tube at work (illustr) 25 Apr 30
- Electron tube controls current through x-ray tube 52D July 38
- Electron tube motor control, Gulliksen 179 June 34
- Electron-tube telemetering for gas and water works, Watts 50 Feb 35
- Electron-tube telemetering system 249D Aug 30
- Electron-tube time-delay relay, Holloway 220 Aug 33
- Electron-tube voltage control for photometry, Kilpatrick & Bernard 352 Nov 34
- Electron tubes in diathermy, Dudley 16 Nov 36
- Comment 32D Jan 37
- Electron tubes in industrial service, Baker, Fitzgerald & Whitney 581 Apr 31
- Electron tubes in Radio City theaters, Staff 32 Feb 33
- Electron tubes in scientific measurements, Horton 18 Apr 30
- Electron tubes in the motion picture field 58D Mar 38
- Electron tubes in traffic-actuated control systems 94 Sept 31
- Electronic a-c galvanometer, Tulauskas 478 Jan 31
- Electronic aids for the blind (illustr) 107 Apr 34
- Electronic aids for the paralyzed (illustr) 209 July 34
- Electronic aids to voice culture 186D June 34
- Electronic amplifier tests bearings for vibration, Germond 292D Sept 30
- Electronic arc-length monitor 48D Apr 38
- Electronic cardiachometer, Horton 14 Aug 38
- Electronic church chimes, Dostal 18 Aug 39
- Electronic control circuits for d-c motors, Ryder 20 Dec 38
- Errata 11 Sept 39
- Electronic control for ship steering, Chance 41 June 39
- Electronic control of complex auditorium lighting, Holden 398 Nov 30
- Electronic device for making visible infrared images 291D Sept 34
- Electronic device for measuring magnetic fields, Rose 21 July 38
- Electronic device for temperature measurements 141D May 33
- Electronic devices in a testing laboratory, Sharp 284 Sept 32
- Electronic engineering, Alexanderson 25 June 36
- Electronic engineering in geophysics, McCullough 28 Aug 39
- Electronic engineers' library (listing) 37 Apr 37
- Electronic equipment in train control, Staff 218 Dec 31
- Electronic (equipment) miscellany (illustr) 18 Mar 38
- Electronic fader, Gunsolley 58D Feb 35
- Electronic flaw detector for nonmagnetic metals, Dana 58D Feb 34
- Electronic high-speed timing device, Roberts 90 Mar 32
- Electronic instrument for determining moisture 163D Oct 31
- Electronic interrupter, Hanly 35 Nov 35
- Electronic license situation, Staff 143 May 35
- Electronic method for testing watches 227D July 34
- Electronic methods in geophysical prospecting 216D July 34
- Electronic microammeter 70D Sept 39
- Electronic micrometer measures depth of grooves in bullets 38D Sept 37
- Electronic microscope, Knoll 243 Sept 33
- Electronic microscope—studies of electronic emission 49D Feb 33
- Electronic microscope with magnetic focusing 128D Apr 34
- Electronic motor (illustr) 251 Aug 30
- Electronic multiplier for high-speed counting, Lord & Livingston 7 Jan 34
- Electronic music from vibrating reeds, Silbar 226 July 34
- Electronic musical instruments (illustr) 435 Dec 30
- Electronic musical instruments of Europe and US, Staff 65 Mar 33
- Electronic oscillators for industrial process control, Olken 144 Oct 31
- Errata 206D Nov 31
- Electronic paint-thickness gage, Powers 54D May 37
- Electronic pH meter, Finlay 39 Nov 37
- Electronic phase-failure relay, Stansbury & Brown 46 Feb 33
- Electronic photometer 221D July 34
- Electronic piano produced commercially 48D Nov 37
- Electronic problem in flue gas control 42D May 37
- Electronic recording of high-speed projectiles 419 Dec 30
- Electronic relay trips cathode-ray sweep circuit in 0.2 microsecond 42D Feb 36
- Electronic robot greeter at new Franklin Institute 187D June 34
- Electronic sales aids, Ephriam 24 June 38
- Electronic self-portraits, Staff 22 Mar 37
- Electronic shooting galleries 34D Jan 37
- Electronic sleuth for lost radium in hospitals 90D Mar 35
- Electronic soundings for deep-sea fishing fleet 342D Nov 32
- Electronic soundings give ships location despite fog 134D Apr 32
- Electronic speed and acceleration recorder, Partridge 262 Aug 32
- Electronic structure of the elements, Hubbard 330 Oct 30
- Electronic switching 46D Aug 38
- Electronic timer announced for photographic purposes 33D Jan 37
- Electronic timer for very short intervals, Lord 309 Oct 32
- Electronic tubes in chemistry, Partridge 166 July 30
- Electronic typewriting speedometer, Ephriam 32D Dec 39
- Electronic ultramicrometers 177D May 32
- Electronic voltage control of d-c generators, Koechel 86D Mar 34
- Electronic voltage regulator for lamp testing, Brady & Bernhard 36D Sept 36
- Electronic voltage regulators in power plants 554D Nov 34
- Electronic voltage relay, Graff 80 Mar 34
- Electronic voltage stabilizers 56D Mar 39
- Electronic voltmeter for d-c arc welding, Richter 82 Mar 35
- Electronic voltmeter using feedback, Ballantine 33 Sept 38
- Electronic waves, light quanta, and Planck's law 249D Aug 30
- Electronic welding timers, Weiller 26 May 36
- Electronics at Chicago World's Fair,** Staff 148 June 33
- Electronics' camera (illustr) 304 Sept 30
- Electronics' chart of sound levels, Staff 43 Feb 32
- Electronics helps make beer (illustr) 13 Sept 38
- Electronics in diagnosis; measuring the heart's emf (illustr) 377 Nov 30
- Electronics in oil, Staff 15 Dec 35
- Electronics in pharmacy 67D Oct 38
- Electronics in resistor manufacturing, Podolsky 180 July 33
- Electronics in surgery, the radio knife, Underhill 316 Oct 30
- Electronics laboratory for technical students, Gray 86 Mar 35
- Electronics on Broadway (illustr) 21 Sept 37
- Electronics overseas (illustr) 199 July 30
- Electronics, the wedding of the sciences, Seeley 434D Dec 30
- Electrons in luminous discharge tubes 54D Feb 33
- Electrons, in magnetic fields 146D June 30
- Electrons in metals 126D Apr 34
- Electrons in new industrial miracles (illustr) 49 Feb 32
- Electrons in new roles (illustr) 39 Feb 33
- Electrons in the day's news (illustr) 365 Dec 32
- Electrons in the news (illustr) 305 Nov 33

ELECTRONS

FREQUENCY

Pg—Mo—Yr		Pg—Mo—Yr		Pg—Mo—Yr	
	Electrons—neutrons yield more secrets (illustr).....177 June 34		Experimental results with ultrashort waves.....482D Jan 31		Fighting artificial static.....46D Apr 36
	Electrons on rampage, Staff.....117 Apr 34		Experiments with a short-wave push-pull transformer.....32D July 31		Fighting artificial static in France.....74D Sept 36
	Electrostatic process, sandpaper manufacture.....187D June 34		Explanation of selective photoelectric effect.....299D Sept 30		Filament, see also Emitter
	Electrostatic recording (Electronography).....44D Apr 36		Explorer II takes tubes aloft, Staff.....31 Dec 35		Filament, coated, vacuum tube.....178 July 30
	Electrotechnical journal.....60D Nov 37		Exploring the microwaves (illustr).....35 May 39		cobalt alloy.....232D Dec 31
	Elements, periodic chart.....330 Oct 30		Exports of radio apparatus.....228D July 35		oxide-coated, characteristics.....44 Apr 30
	Elevator, door opener, photocell.....54 Feb 32		Extensively used patents relating to amplifying circuits (listing).....221 July 32		Filament heating with r-f currents.....242D Dec 31
	leveling control (illustr).....231 Dec 31		Exterminator, r-f, insect.....193D July 23		Filament supply, h-f, for ion source.....44D July 37
	protection, photocell.....15D Jan 34				Filamentless radio tubes.....242 Dec 31
	Eleven years of radio receiver manufacture, Staff.....72 Mar 34				Filaments in hydrogen—electronic collisions.....94D May 30
	Elimination of distortion in cathode-ray tubes, Du Mont.....16 Jan 35				
	Elimination of fading by reverse field detector.....327D Oct 34				Filter, see also type, e.g., Band-Pass, etc
	Emergency acoustic treatment.....40 Feb 34				Filter, adjustable band-pass with flat top.....44D Mar 36
	Emission from target bombarded with positive ions.....196D July 30				band-pass, characteristics.....33 July 36
	Emission, from wire filaments.....22 Mar 37				high-quality.....126D Apr 34
	Emission of positive ions from tungsten and molybdenum.....48D Apr 30				Litz wire.....238D July 32
	Emission of X-rays by cathode.....250D Aug 30				nonlinear distortion.....48D Feb 36
	Emission, primary and secondary.....163D May 34				square-top.....136D May 33
	Emission valve modulator for super-heterodynes, Wheeler.....76 Mar 33				common antenna transmission.....241D Dec 31
	Emitter, nickel and barium alloys.....244 Sept 33				crystal, i-f circuits.....256D Aug 35
	Emitters, effect on distortion.....92D Mar 34				receiver, i-f.....57 Aug 31
	Empire State (illustr).....18 Nov 37				electric-wave, h-f.....84 Mar 34
					low-pass, for rectifier.....28 June 38
					power supply, curves.....29 Dec 35
					notching, single-sideband.....14 Oct 39
					power-supply, r-c.....42D Aug 39
					r-c, time-delay.....26 Feb 38
					r-f, band-pass, two-element.....350D Nov 32
					time delay in.....22 Feb 37
					Errata.....29 Feb 38
					Filter-type interstage amplifier coupling. Stone.....194D July 33
					Errata.....259D Sept 33
					Filtering for double radiation, Andrew.....13 Oct 35
					Fine structure of vacuum-tube characteristics.....194D June 34
					Finish protection measurement.....44D Dec 36
					Fire alarm, shipboard, photocell.....306D Nov 33
					Fire department installs 5-meter radio.....187D June 35
					First industrial application of electronics?.....15D Jan 33
					First iron-core-coil receiver Stronberg-Carlson Model 68, Hodges.....158D May 34
					Fishing, deep-sea, by photocell.....15D Jan 34
					depth-sounding, ultrasonic.....342D Nov 32
					Fishing for eels, 1 kc current.....40D Sept 37
					Five-hour continuous-tape recorder.....72D Sept 39
					Flat-piston moving-coil loudspeakers.....300D Sept 30
					Flaw detector, nonmagnetic metals.....58D Feb 34
					Fluorescent screens for cathode-ray tubes.....44D June 36
					Flux balancer for output transformer. Meissner.....161D May 35
					Flux meter, bridge type.....44D Aug 37
					Flying field lights phototube-controlled.....156D May 35
					Flying the Pacific by radio, Staff.....6 Apr 36
					Football pickup and spotting equipment. Robinson.....46D Dec 39
					For engineer-photographers only, Fink.....22 June 37
					Foreign television activities.....36D July 37
					Forest radio service, Waltz.....9 Feb 39
					Form factor, a-f amplifier distortion.....196 June 32
					Formulas for the internal capacity of multilayer coils.....291D Sept 34
					40-cm waves for aviation, Fink.....12 Nov 39
					Four apex stations now operating.....36D July 36
					4-ounce amplifier for heartbeats.....23D Jan 35
					Four-part sound film used for chorus instruction.....91D Mar 35
					Four thousand police radio cars in 128 cities.....82D Mar 34
					Four-trace oscilloscopes.....51D Apr 38
					France fights man-made static.....164D May 35
					French opinions on an American all-wave receiver.....63D Feb 35
					French pushbutton radio receiver.....50D Dec 37
					Frequency, audio, chart.....677 June 31
					Frequency-changer tubes.....28D Jan 35
					Frequency characteristic of oscillatory circuits.....56D May 39
					Frequency characteristics in film recording and reproduction, Lewin.....40 Feb 32
					Frequency characteristics of optical slits, Llvadary.....512 Feb 31
					Frequency characteristics of piezoelectric oscillators, Anderson.....22 Aug 38

FREQUENCY COMPARISON

HIGH-MU TUBES

Pg—Mo—Yr

Pg—Mo—Yr

Pg—Mo—Yr

Frequency comparison with the cathode-ray oscillograph, Fisher. 310D Nov 33
Frequency control, quartz crystal. 64D Oct 38
 tuning fork, for clocks. 52D Mar 37
 tuning fork transmitter. 140D Apr 32
 two b-c stations. 53D Feb 34
Frequency conversion
 characteristics. 95D Mar 35
Frequency drift compensation,
 Levy. 15 May 39
Frequency measurement, vhf police
 radio. 38D Feb 38
Frequency meter, a-f, synchronous
 clock. 137D May 33
 audio, direct-reading. 224D July 35
 v-t voltmeter at i-f. 130D Apr 32
**Frequency Modulation, see also Broad-
 casting; Communications; etc.**
Frequency modulation. 8 Dec 38
Frequency modulation, broadcast, high-
 power. 25 May 36
 crt, modulator. 14 Oct 39
 noise suppression. 22 May 37
 television picture. 20 Dec 39
 vs a-m, field test. 70D June 39
 wide-band demonstration. 17 Nov 35
Frequency-modulation advances,
 Staff. 188 June 35
Frequency modulation and
 distortion. 395D Nov 30
Frequency modulation demonstrated,
 Fink. 14 Mar 39
Frequency-modulated transmitters,
 Fink. 20 Nov 39
Frequency monitor, broadcast, mobile-
 pickup. 22 Jan 39
Frequency monitoring unit for relay
 broadcasting stations,
 Curran. 22 Jan 39
Frequency multiplier, crt. 264D Aug 32
Frequency recorder used in radio
 listener survey. 50D May 36
Frequency reduction with grid-controlled
 discharge tubes. 162D May 34
Frequency spectrum chart. 26 Apr 30
Frequency stability of self-excited
 oscillators. 48D Apr 37
Frequency standard,
 1,000-cps, v-t. 92D May 30
 piezoelectric, NBS. 248D Aug 30
Full-voltage amplification with screen-
 grid tubes. 346D Dec 33
Furnace control, capacitance
 relay. 46D Nov 37
 phototube, open-hearth. 38D May 39
Further notes on iron-core coils for use
 at r-f or i-f, Polydoroff. 13 Jan 34
Further work on ultrashort wave tubes,
 12-15 cm waves. 259D Sept 33
Fuse, for sensitive meters. 22 Jan 37
Fuse tester, crt. 316D Oct 34
Future of television. 56D Feb 39

G

Gage, film thickness, mercury
 electrode. 60D Nov 39
Gaging, optical system, photo-
 tube. 75D June 39
Gain Control, see also Volume Control
Gain control, grid circuit, calibra-
 tion. 24D July 31
Gain-loss, transmission, db chart. 60 Aug 31
Galvanometer, a-c, v-t. 478 Jan 31
 logarithmic, phototube control. 44D Apr 39
 v-t, pH meter. 39 Nov 37
Gamma and range in television. 68D June 39
Ganging superheterodynes. 176D May 32
Gas Discharge Tube, see also Tube
Gas discharge tube for interstage
 coupling. 258D Aug 34
Gas-filled phototube inertia. 105D Apr 33
Gas-filled triodes. 66D May 37
Gas-tube transformers. 282 Sept 32
Gaseous discharge lamps. 52D Mar 38
Gaseous discharge tubes for radio
 receiver use, Dreyer. 40 Feb 32
Geiger counter, battery-operated. 64D Mar 35
 using Strobotron. 12 Feb 37, 18 Mar 37
General properties of photoelectric
 cathodes. 59D Feb 34
Generating modulated microwaves.
 Babits. 50D June 38

Generating sine waves with a gas
 discharge tube, Kock. 92 Mar 35

Generator, Signal, see Oscillator

Generator, high-frequency, indus-
 trial. 22 Oct 35
 high-voltage, developments. 44D Jan 39
 nuclear physics. 216 Aug 33
Generator of rectangular wave-
 form. 59D Jan 38
Geophysical prospecting, electronic
 methods. 216D July 34

Geophysics, see also Prospecting

Geophysics, electrical prospect-
 ing. 184 Nov 31
 electronic seismic recording. 28 Aug 39
German electrical engineers noise
 campaign. 166D May 35
German government aids televi-
 sion, Staff. 10 Jan 35
German set production (illustr). 11 Apr 36
German superhets. 42D June 37
German supermidjet receiver.
 Raven-Hart. 674 June 31
German television receivers
 (illustr). 81 Mar 35
German tube prices eight to ten
 times US. 99D Mar 35
Getter, Batalum type. 48D Sept 37
v-t evacuation. 510 Feb 31
Gigantic welded pipe tested with
 X-ray. 154D May 34
Gloucester gets first harbor
 beacon. 285D Sept 34
Glow discharge in hydrogen. 347D Oct 30
Glow discharge tube curves. 48D Aug 38
Glow lamps and their technical
 uses. 565D Mar 31
Glow lamp for measuring and
 testing. 482D Jan 31
Glow-lamp noiseless recording,
 Hansen. 177 Nov 31
Glow-lamp sound-on-film recording,
 Braman. 679 June 31
Glow tube checks over- and under-
 voltages. 290D Sept 32
GPO clock announces time over
 telephone. 36D Apr 36
Graphic aid for the design of
 degenerative amplifiers. 64D Nov 39
Graphic noise-level recorder. 25D July 31
Graphical determination of impe-
 dances in parallel. 54D Jan 38
Graphical harmonic analysis,
 Hutcheson. 16 Jan 36
Graphical solution of impedances
 in parallel. 60D Feb 38
Graphite, in tube manufacture. 160D May 35
Graphite anodes in transmitting
 tubes, Replogle. 338 Dec 33
Graphite film applications. 87D Mar 34
Greater simplification suggested in
 designing the radio cabinet,
 Francisco. 590 Apr 31
Grid and plate currents in a grid-
 controlled mercury-vapor
 tube. 110D Apr 33
Grid-bias scheme eliminates feed-
 back trouble. 42D Mar 36
 Addenda. 42D June 36
Grid-control mercury tubes. 2 Jan 34
Grid-controlled discharge tubes. 108D Apr 33
Grid-controlled glow and arc dis-
 charge tubes, Knowles &
 Sashoff. 183 July 30
Grid-current measurement,
 Sutherland. 148 Oct 31
 Errata. 206D Nov 31
Grid-controlled mercury vapor
 tubes. 54D Feb 33
Grid-controlled rectifier as regu-
 lator for a-c. 315D Nov 33
Grid-controlled rectifier cur-
 rent. 253D Sept 33
Grid dynatron. 482D Jan 31
Grid-glow micrometer, Carson. 191 June 32
Grid-glow tube measures commu-
 tator roughness, Harrison. 59D Sept 36
Grid-type multiplier phototube
 introduced in England. 38D Mar 38
Gridless vacuum tubes. 346D Oct 30
Ground noise in sound-on-film
 pictures, Tasker. 333 Oct 32
Ground noise in sound pictures,
 Tasker. 273 Sept 30
Ground system, radial, chart. 33 Jan 38
Ground tester, using neon tubes. 46D May 36
Grounding coupling coil and tuning
 in oscillator circuit. 50D Oct 35
Guiding electric beams in televi-
 sion reception. 128D Apr 34

H

Halation interference in fluorescent
 screens. 48D Nov 35
Half-million volt X-rays. 347D Oct 30
Half-wave gas rectifier circuits,
 Wallis. 12 Oct 38
Hand-drawn sound (illustr). 34 Nov 35
Hardware; see also Components
Hardware, fasteners, screws. 27 May 39
Harmonic analysis applied to the
 power pentode, Rhodes. 118 June 30
Harmonic analysis, graphical. 16 Jan 36
Harmonic distortion and characteris-
 tics of amplifying tubes. 92D Mar 34
Harmonic suppression, transmitter
 circuits. 167 June 38
 Errata. 199D July 33
Hastelloy, grid metal. 54D Sept 38
Hazards from induced emfs, Staff. 88 May 30
Heat treating, control by photo-
 tube. 12 Apr 37
Heater, see Emitter
Heating, dielectric, theory and
 application. 338 Nov 32
Heating, High-Frequency, see Induc-
tion Heating
Heavy-duty industrial amplifier
 tube, Upp. 162 May 32
Helen Keller attends television show
 atop McGraw-Hill Bldg
 (illustr). 27 June 39
Hellertion. 565D Mar 31
Hellertion. 77D Aug 31
Hermetic Seal, see also Weather-
proofing
Hermetic seal, Kovar and glass. 58D Sept 38
Heterodyne elimination, crystal
 filter, i-f. 57 Aug 31
Heterodyne, optimum, triode
 curve. 394D Nov 30
Hexode. 198D July 33
H-F filament supply for ion
 sources. 44D July 37
H-F transmission lines. 26 Apr 38
High definition (illustr). 32 Apr 38
High-fidelity broadcast transmitter
 performance, Laport. 144 May 34
High-fidelity—economics and tech-
 nique, Staff. 108 Apr 34
High-fidelity program circuits,
 Epperson. 341 Nov 34
 Errata. 23D Jan 25
High-fidelity receiver for local
 reception. 64D Feb 39
High-fidelity standards of the
 FCC. 127D Apr 35
High-fidelity technique, Staff. 26 Nov 35
High-frequency ammeter employs
 phototube indicator. 44D Sept 38
High frequency and superconduc-
 tivity. 204D Nov 31
High-frequency ceramic mate-
 rial. 48D Feb 33
High-frequency compensation for
 high-fidelity receivers. 94D Mar 35
High-frequency effect on organic
 tissues. 52D Aug 37
High-frequency heating in
 industry. 291D Sept 32
High-frequency magnetron genera-
 tors. 58D Dec 37
High-frequency oscillator for gen-
 eral laboratory use. 394D Nov 30
High-frequency pre-emphasis,
 Hathaway. 29 Nov 39
High-frequency switching. 104D Mar 32
High-frequency tubes. 56D May 39
High-frequency waves kill pests
 in beans. 193D July 33
High-gain a-c/d-c amplifier,
 Meissner. 195D July 33
High-gain amplifier. 54D Feb 34
High-gain amplifiers for electronic
 measurements. 319D Oct 32
High gain—simplified,
 Von Kunits. 18 Dec 35
High-gain, wide-band laboratory
 amplifier, Everst. 16 Feb 39
High-intensity sound waves. 40D Feb 37
High-level automatic or self-bias
 detection, Nelson. 14 July 31
High-level plate circuit rectifica-
 tion, Nelson. 550 Mar 31
High-mu tubes in resistance coupled
 amplifiers. 53D Apr 38

HIGH-POWER

INDUSTRY RECOVERY

	Pg—Mo—Yr
High-power frequency modulation, Staff	25 May 36
High-power modulation transformers	63D Feb 35
High-power public address system for Christmas celebration	44D Feb 36
High-powered transmitters system	109D Apr 33
High-Q audio reactors, Bechberger	22 May 36
High quality band-pass filters	126D Apr 34
High-quality radio reception, Walsh	20 July 39
High-resistance measurement, Lodbury	94D Mar 32
High-resistance measurement with vacuum tubes, Preisman	214 July 35
High-speed counting made possible by ratio control	38D Mar 38
High-speed direct-reading frequency meter	224D July 35
High-speed electronic resistor sorter	249D Aug 34
High-speed four-column facsimile recorder	61D May 39
High-speed radio production, Jerzyan	21 Dec 35
High-speed synchronous motor employed in British television, Jupe	38D Dec 38
High-speed thyatron automatic counting	232D July 32
High-tension d-c transmission, Staff	56 Feb 37
High-voltage rectifiers	56D Sept 35
High-voltage testing at low power	42D Oct 39
Higher-voltage vacuum tubes—faster electrons, Staff	216 Aug 33
Highly flexible v-t voltmeter, Boyle	32D Aug 36
Highly sensitive instrument for measuring small coefficients of damping	50D Oct 35
Highly sensitive vacuum photocells	67D Feb 32
Hiss silencer for communications receivers	56D Sept 39
History and application of piezo electricity	44D Aug 37
Hold cup under faucet; water flows	389D Nov 30
Home facsimile recording, Ostrolenk	26 Jan 38
Home recording on 16-mm film, Staff	176 June 34
Home talking movies, Irby	276 Sept 30
Horn, see also Loudspeaker	
Horn, design for loudspeaker	20 Feb 36
Hot-cathode x-ray tube design	24D Jan 33
How manufacturers can cash in on prosperity campaign, Whitehorn	218 Aug 33
How many ionized layers?	350D Nov 32
How the eye adjusts itself to darkness	270D Aug 32
HP6A: Radical departure in phonograph pickup design, Hunt & Pierce	9 Mar 38
Huge tube near completion	261D Aug 35
Humidity (and components), Snow	25 Oct 36
Hydrogen adsorption, magnesium	314D Nov 33
Hydrogenized iron of high magnetic permeability	347D Oct 30
Hydrography, radio-acoustic ranging	308 Nov 33
radio-hydrophone triangulation	124 June 30
Hydrophone, geodetic survey	308 Nov 33
Hygrometer, see also Humidity	
Hygrometer, phototube, humidifier control	61D Feb 32
Hysteresigraph using phototubes	46D Sept 37

	Pg—Mo—Yr
I-F transformers, cost vs quality, Henry & Stemm	97 Mar 32
Ignition noise, study	41 May 36
Ignition suppressor, effect on car	70 Mar 34
Ignitron—a new controlled rectifier, Knowles	164 June 33
Ignitron, firing circuit, saturable-reactor	12 Dec 39
Ignitrons for welding control in electric welding	63D Feb 37
Illumination, cold-cathode lamp	140 Oct 31
sodium-vapor lamp	189 July 33
control, airport	135D Apr 32
auditorium, Cleveland	368 Nov 30
by photocell	186D June 34
factory lighting	14D Jan 33
selenium-thyatron	632 May 31
stage-lighting, thyatron	237 Aug 30
Illuminometer helps sell paint	82D Mar 37
Image dissector, Larson & Gardner	24 Oct 39
Image frequency, superheterodyne receiver	364D Nov 34
superheterodyne receiver	618 May 31
Impedance calculation	34 July 37
slide rule	45 May 37
Addenda	34D July 37
Impedance chart for r-f lines, Teachman	35 Dec 36
Impedance chart, polar-rectangular	35 Feb 38
Impedance match, antenna to coaxial line	239 Aug 35
for multiple audio circuits	33 Mar 37
Smith chart	29 Jan 39
transmission lines	14 Sept 35
mismatch losses	26 Jan 36
network design chart	84 Mar 35
Impedance matching networks, Thlissen	552 Mar 31
Impedance-matching pi-section networks	29 Jan 36
Impedance measurement, of human body	36D Apr 36
oscillator-tuning method	194D July 37
Impedance measurements	56D Oct 37
Impedance mismatch losses	26 Jan 36
Impedance, parallel, graphical solution	54D Jan 38
parallel, graphical solution	31 May 38
solution	60D Feb 38
Impedance transformer, using tube	8 Dec 38
Importance of phase control in synchronizing, Horn	423 Dec 30
Improved B eliminator for automobile receivers, Garstang	254 Aug 32
Improved balance circuit for electrometer tubes	259D Sept 33
Improved beat-frequency oscillator	229D Aug 33
Improved blind landing methods	25D Jan 34
Improved bridge for a-c operation	162D May 34
Improved circuits for measuring negative resistance, Terman	340D Dec 33
Improved electrostatic loudspeaker	105D Mar 32
Improved fidelity of two-speaker radio receivers, Knowles	154 May 32
Improved form of Alnico magnet displays great pulling power	46D Apr 39
Improved meter shunt circuit, Gunsolley	36D Apr 38
Improved model of the neon-tube contactor	77D Aug 31
Improved 120-volt d-c audio amplifier, Stromeyer	194 June 32
Improved phototube register control	44D Sept 39
Improved preselector circuit for radio receivers, Uehling	279 Sept 30
Improved quartz-controlled oscillators	314D Nov 33
Improved resonance method for dielectric constant study	25D Jan 34
Improved single-tube balanced d-c amplifier	159D May 34
Improvement in foreign radio receivers	60D Feb 37
Improvements in afc circuits, Freeman	20 Nov 36
Improvements in cathode-ray tube, Zworykin	188 Nov 31
Improvements in cuprous oxide-copper elements	25D Jan 34
Improvements in Ferrocart coils	27D Jan 34
Improvements in frequency multipliers for aircraft radio, Watts	124 Apr 32
Improvements in frequency-stabilizers	32D July 31
Improvements in medium voltage cathode-ray tube	346D Dec 33

	Pg—Mo—Yr
Improvements in resistance-coupled amplifiers	51D Apr 37
Improving regulator performance, Bousquet	26 July 38
Improving the broadcast of recorded programs, Miller	178 June 34
Impulse detector in television	54D July 39
In hydrographic chart making, the tube—as a surveying tool, Parkhurst	124 June 30
Incandescent cathode rectifier with magnetic field	36D July 37
Incandescent lamps for dummy antennas	36D July 36
Increase in motion picture theatres	50D Aug 37
Increased accuracy of Naval Observatory time signals	38D Nov 35
Increased efficiency in tower antennas—a review, Laport	238 Aug 34
Increasing disc recording and playing time, Ephraim	38D Oct 35
Indicator, null, recording potentiometer	190D June 34
Indicators for arc-back in mercury vapor rectifiers, Logan	48D Apr 39
Indirectly heated direct-current tubes	162D Oct 31
Indoor sign operated by photocell	339D Oct 30
Induced emf hazards, Navy	88 May 30
Inductance, see also Inductor	
Inductance, multilayer design chart	33 Jan 39
mutual, coaxial single solenoids	31 July 37
screened-coil	229D July 34
single-layer-solenoid, calculation	598 Apr 31
variable, motor speed control	20 Dec 38
Errata	11 Sept 39
bridge, v-t null indicator	478 Jan 31
Inductance-capacitance products, table	31 June 38
Inductance change measurement	18 Mar 38
Inductance of bypass condensers	199D July 33
Inductance tuning	22 Dec 37
Induction heater, 10-mc, experiments	173 July 30
Induction heating, medical	15D Jan 34
surface hardening, steel	44D June 38
Induction pick-up regulates temperature directly from indicator pointer	34D Oct 38
Inductor, see also Inductance	
Inductor, audio reactors carrying d-c	18 Sept 36
calculating single-layer solenoid	27 Jan 37
cores, Ferrocart	348D Nov 32
design for 15 mc.	174 June 34
distributed capacitance formula	291D Sept 34
Ferrocart, potted	27D Jan 34
filter-choke design	310 Oct 34
high-Q for audio	22 May 36
iron-core, r-f and i-f	13 Jan 34
Litz-wire wound	342 Dec 33
r-f, characteristics	120 Apr 35
choke design	254 Aug 35
losses	327D Apr 34
shielding effect	259D Sept 33
shielding, low Q-loss	47D Feb 38
shorted-turn tester	341D Dec 33
single-layer solenoid chart	315 Oct 34
solenoid, distributed capacitance	31 Mar 38
universal coil, winding	22 Oct 36
Errata	52D Nov 36
variable, iron-dust core	8 July 31
Industrial control, design of electronic equipment	156 May 34
v-t, circuit survey	467 Jan 31
listing	20 Feb 39
thyatron	581 Apr 31
Industrial electronic-tube section, NEMA, Staff	350 Nov 34
Industrial high-frequency power, Noble	22 Oct 35
Industrial tube terminology	29 Sept 38
Industrial uses of electron tubes, Baker, Fitzgerald & Whitney	467 Jan 31
Industrial uses of electronic diffraction, Phillips	84 Mar 32
Industrial uses of photocell, Brelsky	74 May 30
Industrial uses of vacuum devices, Kintner	15 Apr 30
Industrial x-ray practice, Woods	7 Feb 36
Industrial x-rays for examining metals	45D Feb 33
Industry recovery act—and radio, Staff	178 July 33

INERTIA

	Pg—Mo—Yr
Inertia of gas-filled phototubes	483D Jan 31
Influence of load on gain and selectivity	229D Aug 33
Influence of magnetic field on plate resistance	32D Sept 38
Influence of magnetic fields on barrier-layer photocells	298D Sept 32
Influence of nodes in loudspeaker diaphragms	28D Jan 32
Influence of the surroundings on the frequency of quartz oscillators	34 July 31
Infrared and ultraviolet telephony	605D Apr 31
Infrared detector, by fluorescence	291D Sept 34
Infrared photoalarm protects 13,000 sq ft	43D May 37
Infrared photocell burglar alarm marketed in Europe	248D Aug 34
Infrared sensitive cells	606D Apr 31
Ingenuous circuits in new radio receivers, Staff	330 Nov 32
Initial drift in photocells, Wilson	15 Jan 39
Initial impulse indicator, Livingston & Lord	257 Sept 33
Inner-grid dynatron and the duodynamatron	25D Jan 34
Input conductance neutralization, Freeman	22 Oct 39
Input control circuit, Waltz	38D Mar 39
Input switching console, Epperson	38 June 38
Inspecting high-speed machines with the Stroboglow	338D Oct 30
Installation of photocell smoke indicator	385 Dec 34
Installing photocell control, McDill	276 Oct 33
Instruction, electronics laboratory, MIT	86 Mar 35
Instrumentation, see Measurement	
Insulation, fibrous glass yarn	33 Oct 39
plastics	10 Mar 36
rubber, r-f power factor	286D Oct 33
tester, automatic bridge	6 Jan 32
ionization measurement	62 Aug 31
Insulator, ceramic	7 Feb 37
ceramic, low thermal expansion	94D Mar 32
coil form, R-29	72 May 30
r-f, new materials	182D May 34
phase difference, materials	292D Sept 34
voltage limits	11 Oct 35
Insulators at r-f	58D Feb 34
Integrator, irregular area, photocell	98D Mar 32
Intelligible explanations (by photocell) instead of buzzes for phone users	216D July 34
Intercarrier noise suppression, Wunderlich	13 Jan 33
Intercom, loudspeaker warns prowlers	42D May 39
single-tube	58D June 39
Intercommunicator, see also Intercom	
Intercommunicator, systems	27 May 37
Interelectrode capacity at high frequencies	27D Jan 34
Interference, see also Ignition; Noise; etc.	
Interference, bibliography sources and measurements	32 Oct 38
broadcast, sources	108D Apr 33
measurement and prevention	42D Oct 36
from appliances	108D Apr 33
noise survey	66D Nov 36
r-f, measurements	261D Aug 35
sources and elimination	370 Dec 34
spark plug suppressor	158D May 34
Interference from motor cars	63D Mar 37
Interference from shared-frequency broadcasting, Alken	100 Sept 31
Interference prevention for street-cars	269D Aug 32
Interference reduction in Great Britain	165D May 35
Interference source discovered, Staff	19 Feb 36
Intermediate-frequency, choice for receiver	618 May 31
Intermediate-frequency tuning condenser requirements, Rhodes	690 June 31
Intermittent reception in broadcasting receivers	44D Feb 36
Intermodulation distortion, converter oscillator	52D Oct 36
nonlinear a-f systems	20 Sept 38
Comment	61D Feb 39
Internal combustion engine interference	395D Dec 34
Interoffice communication, Rosenbaum	26 May 37

	Pg—Mo—Yr
Interphone system using light wires	169D May 34
Interpreting oscillogram patterns	60D Nov 36
Interrupter, electronic, laboratory and industrial	35 Nov 35
Interspaced transformer windings, Leidy	233D Dec 31
Inverse method of solving tube problems	20D Jan 34
Inversion by means of grid-controlled rectifiers	109D Apr 33
Inverter, broadcast-receiver, thyatron	152 Oct 31
power, thyatron	581 Apr 31
75-watt, commutator	252D Sept 33
single-tube	140D May 33
thyatron	34D Jan 37
single-tube	96 Apr 33
v-t, discharge tube	346D Dec 33
Investigating insulation value of molecular films	60D Nov 39
Ionization chamber, radium locator	90D Mar 35
Ionization current, measurement	170D June 33
Ionization in the Kennelly-Heaviside layer	297D Sept 32
Ionization, measures vacuum in tubes	594 Apr 31
Ionosphere, layer heights	350D Nov 32
solar disturbance	25 Jan 36
solar effects on radio	188 June 34
sunspot effect	122 Apr 32
thunderstorm effects	26D Jan 34
Ionosphere characteristics (publications)	55D Jan 38
IRE and SMPA Autumn meeting	30 Nov 36
IRE annual convention	18 June 36
IRE convention, 1938, Staff	8 July 38
IRE convention, 1939, Staff	14 Oct 39
IRE, Emporium, presents seminar	27 July 36
IRE Fall meeting, Staff	11 Dec 35
IRE, Fall meeting paper survey	328 Dec 33
IRE members meet in Fall convention (abstracts), Staff	176 Nov 31
IRE Rochester Fall meeting	9 Dec 36
Errata	34D July 37
IRE, Rochester Fall meeting	11 Dec 37
IRE San Francisco (papers summaries), Staff	28 June 39
IRE sees projection television, Staff	7 June 37
IRE, silver anniversary	14 May 37
IRE, sixth annual convention, summary	675 June 31
IRE world radio convention (illustr)	33 June 38
Iron as magnetic material	168D May 32
Iron in the more costly tubes, Todd	229D July 34
Iron-core inductors, r-f and i-f	13 Jan 34
Iron-core intermediate-frequency transformers, Crossley	298 Nov 33
Irradiating seeds speeds up flowering of plants, Bartlett	260D Aug 32
Is a radio patent pool the way out? Staff	2 July 31
Isograft, mathematical aid	54D Feb 38
Isolatite characteristics	168D May 32
It counts, it alarms, it controls (illustr)	95 May 30

Japanese technical journal	60D Nov 37
Johnson-Rahbeck effect, Bickley	51D Jan 38

K

Kathetron—a control tube with external grid, Craig	70 Mar 32
Kathetron, control tube	26 Sept 37
KDKA's new antenna reaches for the clouds (illustr)	24 Feb 38

LIGHTS

	Pg—Mo—Yr
Kerr cell in high-frequency measurements	68D Feb 32
Kerr cell, in Scopphony television	30 Mar 36
Keyer, v-t bug	622D Feb 31
Keying monitor for c-w transmitters, Perozzo	44D Dec 37
KGLO's mobile unit travels 3,500 miles in five months	44D Feb 39
Killing insects by short-waves (illustr)	309 Oct 34
Killing weevils in wheat by short-wave	75D Mar 33
Klangfilter	238D July 32
Klystron, see also Tube	
Klystron, rhumbatron, oscillator, survey	9 Apr 39
Konel, oxide-coated, filament	44 Apr 30
KYW, Staff	6 Jan 35
Laboratory B-voltage supply	93D May 30
Laboratory oscillator for receiver testing, Franks	668 June 31
Laboratory television receiver, Fink	16 July 38
Laboratory television receiver—II, Fink	26 Aug 38
Laboratory television receiver—III, Fink	22 Sept 38
Laboratory television receiver—IV, Fink	16 Oct 38
Laboratory television receiver—V, Fink	26 Nov 38
Laboratory television receiver—VI, Fink	16 Dec 38
Lagoon of Nations sound system, Walsh	26 July 39
Laminated plastics for radio, McDonough	8 Oct 38
Lamps, incandescent, gas content	46D Nov 37
Latest developments in wide-film pictures, Sponable	65 May 30
Latest in high intensity x-rays and fever machines, Staff	56 Feb 32
Laundry conveyor operated by photocell	162D June 33
Law of stifling sound	250D Aug 30
Legal aspects of television	36D July 37
Lenard tube, glass-window, and phenomena	294 Sept 30
Library of Congress to have 28 pe doors	248D Aug 34
Licenses under the amplifier patents, Staff	152 May 32
Life of impregnated paper condensers, Katzman	64D June 38
Life test for condensers, Houck	114D Sept 31
Light-beam train control in Germany	338D Oct 30
Light excitation by r-f energy	34D Oct 38
Light filters for television	61D Apr 39
Light Indicator, see also Phototube	
Light indicator, neon tube oscillator	29D July 37
Light intensity of a quartz mercury-vapor lamp	27D Jan 34
Light measurement, pe cells for	42D Apr 36
Light meter, phototube	36D June 36
Light relay, phototube	632 May 31
Light-sensitive cell	54D Sept 37
Light-sensitive cell circuits, Staff	36 Dec 36
Light-sensitive cells (illustr)	233 Aug 30
Light-sensitive cells in the service of man	269D Aug 32
Light-sensitive glow-discharge tube	122D Sept 31
Light-sensitive relays now on the market, Staff	194 Nov 31
Light, ultraviolet, sound pictures	7 Mar 36
Light variation indicator	36D June 36
Lighthouses and beacons photocell operated	186D June 34
Lighting control, electronic, Metropolitan Opera	384 Dec 34
theater, electronic	323 Oct 34
Lightning protection, coaxial line	31 Aug 39
Lights go on when train enters tunnel	186D June 34

LIMIT BRIDGE

MECHANICAL

	Pg—Mo—Yr
Limit bridge	151D Oct 31
Limitations of the Fourier integral	52D Aug 39
Limited impulse & delay relays, Noble	28 Aug 36
Limiters, see F-M; Noise	
Linear db meter	54D Oct 39
Linear detection of heterodyne signals, Terman	386 Nov 30
Linear detector distortion, Jarvis	386 Dec 34
Linear modulation by 55-tube, Bagno & Egert	16 Jan 34
Linear rectification, DeWalt	252D Aug 34
Linear rectification, Lambert	21D Jan 34
Linear time axis for broadcast frequencies	268D Aug 32
Linotype, remote control, phototube	33D Aug 38
Lissajous figure, frequency measurement	310D Nov 33
List of photocell applications, Staff	270 Oct 33
Listing of cathode ray tubes	48D Dec 37
Litz wire, i-f and r-f transformer	303 Nov 33
Locating fish by submarine echoes	132 May 33
Locating watermarks in paper	123D Apr 35
Logarithmic phototube circuit	62D Feb 38
Logarithmic voltmeter	87D Mar 34
London annual exhibition of scientific equipment, Jupe	56D Mar 38
London exhibit of scientific apparatus, Jupe	52D Mar 39
London radio exhibition, Jupe	66D Nov 38
Long versus short broadcast waves	19D Jan 33
Looking ahead as 1933 opens, Staff	2 Jan 33
Lorenz blind landing system (illustr)	26 July 37
Los Angeles collects data on phototube control of street lighting	36D Mar 37
Losses, tube-input circuits	222 July 35
Lost fishing dories located by radio	217D July 34
Loudspeaker, baffle spatial ex-	68D Mar 39
balsa-wood piston	300D Sept 30
concentric folded-horn	16 Jan 39
cone-amplitude study	32D July 31
cone, natural frequencies	27D Jan 34
diaphragm, nodal vibration	28D Jan 32
directional, theater	186 July 30
dual, broadcast receiver	154 May 32
dynamic, design	166 Aug 31
design	158 June 32
design computation	257 Aug 32
design using stroboscope	30D Sept 31
efficiency calculation	52 Feb 32
electrodynamic, metal-foil	228D July 34
performance	64D Mar 37
electrostatic, aluminum cone	105D Mar 32
feedback, inverse	8 Dec 38
half-frequency resonance	291D Sept 34
high-fidelity system	24 Mar 36
horn, efficiency	30 Apr 37
exponential, square cross-section	33 Feb 39
labyrinth, resonance elimination	24 Apr 37
measuring performance	42D May 36
piezoelectric, Rochelle-salt	186 May 32
police control	48D Feb 34
selection, special service	22 Nov 38
theory and performance	121D Sept 31
three-coil system	55D Feb 30
various types, symposium	142 June 30
Loudspeaker cost vs quality, Knowles	240 Sept 33
Loudspeaker deflection measurements, Glover & Hunter	474 Jan 31
Loudspeaker design, Massa	20 Feb 36
Loudspeaker for giving orders at sea	385D Dec 34
Loudspeaker measurements, Massa	18 July 36
Loudspeaker research	604D Apr 31
Loudspeaker response measurements	122D Sept 31
Loudspeaker system routs farm prowlers, Slawson	42D May 39
Low-cost wooden mast, Andrew & McGregor	46D May 36
Low distortion 400-cycle oscillator	131D Apr 35
Low-distortion limiting amplifier, Cook	38 June 39
Low-frequency carrier controls water-heater load	46D Mar 37
Low-level (electrostatic) wattmeter, Albert & Beckendorf	28 Mar 36
Low-noise recording, Staff	28 Apr 36
Low-noise vacuum tubes	169D May 32

	Pg—Mo—Yr
Low-range electrostatic voltmeter, Koechel	252D Sept 33
Low thermal expansion ceramic	94D Mar 32
Low-voltage photoelectric colorimeter	104D Apr 33
Luminescent material	52D Mar 39
Luminescent screen potential	69D Oct 38
Luxemburg effect	27D Jan 35
Luxemburg effect, mutual modulation between transmitters	44D Apr 36
Luxemburg effect noted in US in 1919	98D Mar 35

M

Machine designer looks at electronic industrial control, Carson	156 May 34
Machine throws out bad beans, Havens	197D Nov 31
Magnet, Alnico, steel-jacket	47D Apr 39
permanent, alloys for	30 May 36
design for instruments	636 May 31
Magnetic coil for focusing electrons	206D Nov 31
Magnetic control of mercury-vapor rectifier tubes, Reich	48D Feb 33
Magnetic control of thyratrons, McArthur	12 Jan 35
Magnetic detectors	62D Feb 37
Magnetic disturbances and long-distance reception, Kennelly	42 Apr 30
Magnetic field measurements, tube	21 July 38
Magnetic leakage of radio transformers	140D Apr 32
Magnetic material, Alnico	42D Jan 36
Magnetic recorder, Malloy	30 Jan 38
Magnetic recording	54D Dec 37
Magnetic recording, Begun	30 Sept 38
Magnetic recording for broadcast casting	57D Jan 38
Magnetic Relay, see Relay	
Magnetic Switch, see Relay	
Magnetic Tape, see Magnetic Wire; Recorder	
Magnetizer, thyatron control	66D Nov 37
Magnetometer, a-c, v-t type	635D May 31
Magnetostriction oscillator	104D Apr 33
Magnetostriction oscillators at radio frequencies	34D July 31
Magnetron, see also Oscillator; Radar; Tube	
Magnetron, characteristics, emission function	59D Sept 38
high-frequency generator	55D Dec 37
high-frequency generators	81D Nov 39
oscillator	42D Jan 36
split-anode	278 Sept 32
slot-angle function	60D Mar 39
split-plate, action and output	42D Aug 36
Magnets and magnetic materials, Stager	11 Feb 37
Maintenance, broadcast, cost survey	25 Nov 35
Making a-c and d-c scales correspond on a universal voltmeter, Mathieson	55D Feb 34
Making metal tubes, Staff	31 Sept 35
Manufacture of caesium silver-oxide photocells, Nickless	255 Aug 32
Manufacture of photoelectric cells	108D Apr 33
Manufacturing costs, tube	222 July 32
Manufacturing spray shield tubes, Lewis	193D Nov 31
Manufacturing, v-t, shrinkage control	332 Nov 32
March of electronics, Staff	7 Mar 36
March toward high fidelity in sound (illustr)	185 June 34
Marconi's recent ultrashort-wave experiments	104D Mar 32
Market, industrial, v-t devices	288 Sept 30
Mass Spectrograph, see also Spectrograph	
Mass spectrograph for isotope research	124D Apr 34
Masses of the proton and electron	196D July 30
Massless pickup, Weeden	36 May 36
Matching colors by photocell comparison	250D Aug 30
Matching colors of samples at three points, Wilson, Hein & Hitchcock	342D Nov 32

	Pg—Mo—Yr
Matching r-f lines	64D Mar 39
Matching short-wave feeder lines	81D Mar 33
Materials, see also type, e.g., Ceramic; Metal; Plastics; etc	
Materials, for vacuum tubes	104 Apr 34
Mathematical treatment of the grid bias resistor, Richter	62D Nov 37
Mathematics, mechanical aids	54D Feb 39
Matted track recording, noise reduction in film	23 Oct 38
Maximum amplification in capacity-coupled circuits, Roberts	20 July 31
Mean level determination, Logan	27 Aug 36
Measured input losses of vacuum tubes, Franks	222 July 35
Measuring a micromicroampere, Thompson	290 Sept 30
Measuring acidity and alkalinity by photocell	232D July 32
Measuring damping coefficient of oscillating circuits	18D Jan 33
Measuring fineness of cement	15D Jan 34
Measuring four-pole networks, Clarke	31 July 38
Measuring harmonic distortion in tube circuits, Schmit & Stinchfield	78 May 30
Measuring ionization currents and high resistances, Saxl	62 Aug 31
Measuring loudspeaker performance	42D May 36
Measuring luster of textiles	187D June 34
Measuring man-made static	108D Apr 33
Measuring mechanical impedance	249D Aug 30
Measuring movie-film density	285D Sept 34
Measuring one billion ohms, Saxl	171D June 39
Measuring potential, a-c, approximate	564D Mar 31
Measuring pressure and weight	103D Apr 32
Measuring radio interference	261D Aug 36
Measuring resistance of broadcast antennas, Helt	45 Feb 34
Measuring technique at very high frequencies	191D June 34
Measuring textile gelatines with a phonograph pickup, Saxl	40D Jan 37
Measuring the characteristics of cathode-ray tubes	52D May 36
Measuring the intensity of 700-kv x-rays	170D June 35
Measuring the moisture content of wheat, electrically	110D Apr 33
Measuring vs judging loudness of noise, Free	21D Jan 33
Measuring weak magnetic a-c fields of known frequency	635D May 31
Measurement, see type, e.g., Instrumentation; Pressure; Resistance; Voltmeter; etc	
Measurement, coefficient of damping	560D Oct 35
crt applications	153 May 35
equipment and components, survey	16 June 38
harmonic analysis, pentode	113 June 30
magnetic field, tube	21 July 33
production testing, receiver	590 Feb 33
r-f, instrument techniques	8 July 38
r-f power	30 Feb 30
twist, propeller shaft	431D Dec 30
v-t applications	18 Apr 30
Measurement of class-B amplifier distortion, Farrar	196 June 33
Measurement of condenser losses at 4,000 kc	261D Aug 36
Measurement of fidelity in television systems, Murray	137 Oct 31
Measurement of gas pressure, Rentschler	292D Sept 32
Measurement of h-f lines	26 Apr 33
Measurement of minute changes of capacitance and inductance, Leonard	18 Mar 38
Measurement of resistance at radio frequencies	697D June 31
Measurement of small currents	441D Dec 30
Measurement of small displacements	27D July 34
Measurement of vacuum in radio tubes, Sarbey	594 Apr 31
Measurement of yarn thickness and evenness	370D Dec 33
Measurement on path lengths	350D Nov 32
Measurements of a-c arcs	58D Oct 39
Measurements of rapidly varying pressures by cathode-ray tube	315D Nov 35
Measurements of small voltages	52D Aug 35
Mechanical aids to mathematics	54D Feb 38
Mechanical features of the season's radio sets, Staff	344 Nov 34

MECHANISM

NARROW

Pg—Mo—Yr

Pg—Mo—Yr

Pg—Mo—Yr

- Mechanism of the electrodeless discharge347D Oct 30
 Mechanized Army Band.....389D Nov 30
 Medical, body heating, frequency selectivity.....15D Jan 34
 Medicine, electrotherapy, summary44D Aug 38
 Mekapion, x-ray dosimeter.....62 Aug 31
 Membrane material; condenser microphone sensitivity.....127D Apr 34
 Memnoscope, records ignition failures30D June 37
 Menace to broadcasting, Staff.....216 July 32
 Merchandising, broadcast receivers, Europe229 Dec 31
 electronic display devices.....24 June 38
 receiver, broadcast, with tubes662 June 31
 RMA depression plan.....218 Aug 33
 sound equipment buying habits686 June 31
 sound-picture, foreign11 July 31
 transmitter-apparatus sales204 July 34
 tube distribution, abuses.....494 Feb 31
 tubes on consignment.....184 June 32
 Mercury-arc rectifiers for radio transmitters300D Sept 30
 Mercury arcs, convection currents52D Mar 38
 Mercury rectifier runs B&O electric train36D Sept 38
 Mercury-vapor detection34D Dec 38
 Mercury-vapor detector uses color comparison44D Feb 36
 Mercury-vapor light intensity.....27D Jan 34
 Metal-clad grid-controlled mercury rectifiers for radio stations, Durand4 Jan 34
Metal Detector, see also Magnetic Detector
 Metal detector, cigar manufacture17 Apr 38
 tuned bridge17 Apr 38
 Metal, photoelectric and thermionic effects44 Apr 30
 Metal rectifiers for intermediate r-f229D Aug 33
 Metal tube base diagrams and characteristics36 Sept 35
 Metal tube used to measure diffusion of hydrogen46D Oct 37
 Metals, for sealing in glass.....54D Mar 37
 Metals in radio, Chase.....13 Oct 37
 Meteorology, effect on components25 Oct 36
 radiosonde, balloon transmitter21 July 31
Meter, see also Measurement
 Meter for indicating 100-percent modulation, Lampkin26 July 31
 Meter fusing22 Jan 37
 Meter protection, plate ammeter.....38D Feb 38
 Meter, v-u, audio, new reference level28 Feb 39
 Meters for use over wide-frequency range56D Oct 39
 Method of measuring vacuum-tube coefficients, Polk38D July 39
 Method of periodical sound reproduction, Korn38D May 38
 Method of synchronization in television606D Apr 31
 Methods used in electrical prospecting, Heller184 Nov 31
 Metropolitan Opera installs electron-tube lighting control384D Dec 34
 Metropolitan Opera on the air, Staff30 Dec 37
Mica, see also Material
 Mica, permittivity and power factor33D July 31
 Microammeter, sensitive v-t.....58D Feb 37
 v-t, feedback70D Sept 39
 Micrometer, electronic, measures rifling88D Sept 37
 electronic, variable-capacitance177D May 32
 grid-glow contactor191 June 32
Microphone, capacitor, sensitivity127D Apr 34
 directional, controllable.....40D Nov 38
 frequency response calibration106 Sept 31
 piezoelectric, Rochelle-salt.....166 May 32
 polarity effect, modulation percentage28 Oct 39
 preamplifier, dynamic52 Feb 34
 velocity18 Dec 35
 static velocity21 Sept 36
 unidirectional, crystal242 Aug 35
 crystal62D Feb 39
 velocity, ribbon-type836 Nov 32
 Microphone switching systems for broadcast stations, Barnett.....152 May 34
 Microphones in the cemetery...154D May 34
 Microphotometer, recording ...48D Aug 37
 Micro-radio waves81D Mar 33
 Micro-ray wireless650D May 31
Microscope, electron243 Sept 33
 observing emission22 Mar 37
 resolving power60D June 38
 Microvoltmeter, Wynn-Williams, physiology31D June 37
 Microwave, emergency broadcast equipment, European (illustr).....35 May 33
 Microwaves25 Jan 33
 Microwaves to detect aircraft (illustr)18 Sept 35
 Addenda.....42D Sept 35
 Microwave transmitter.....42D Sept 35
 Middle C, Young.....75D Nov 37
 Midget remote amplifier at KCMO, Sigmon38D Jan 38
 Midland television installs 441-line television equipment56D Oct 38
 Miller effect, v-t, applications.....30 Oct 35
 Millimeter waves, generation.....50D Dec 37
 Million-cycle coaxial cable for television?, Staff189 June 35
 Million-volt x-ray tube employs resonance transformer and gas insulation48D Feb 39
 Millonths of an inch measured with an electronic relay160D May 35
 Miniature battery tubes, Bucklin.....27 Nov 39
 Mixed layer photocells.....163D May 34
Mixer, see also Converter
 Mixer circuit correction.....56D Jan 37
 Mixer circuit designs, Smeltzer32 Nov 36
 Errata.....56D Jan 37
 Mixing hexode at audio frequencies228D July 34
 Mixing hexodes for beat-frequency oscillator229D July 34
 Mixing-tube ambiguity50D July 36
 Mobile printer for police and aircraft218 July 34
 Modern audiometer, Penther.....38D Aug 39
 Modern beat oscillator, Caldwell & Harrison50D Nov 39
 Modern fasteners in the radio industry, Walsh27 May 39
 Modern methods of modulation.....40D June 36
 Modern photoelectric cells.....76D Aug 31
 Modern radio plant practice.....9 Dec 39
 Modern treatment of broadcasting acoustics, Wolf14 Jan 32
 Modern vacuum practice in electronics, Morse33 Nov 39
 Modulated deflection of cathode-ray beam109D Apr 33
Modulation, see also type, e.g., A-M; F-M; etc
 Modulation, Chireix, plate system29D Jan 32
 constant current, modified.....78 Mar 34
 copper-oxide rectifier15 July 39
 effects on receiver, overmodulation9 Jan 32
 Heising, for 100-percent.....326 Oct 30
 high-fidelity broadcasting.....144 May 34
 indicator, automatic with day-night power40D Aug 38
 linear, for signal generator.....16 Jan 34
 measurement, rectifier.....247 Sept 33
 meter, broadcast transmitter.....26 July 31
 v-t type18 Jan 37
 methods40D June 36
 microphone polarity effect.....28 Oct 39
 resulting antenna current.....59 Aug 31
 simplified circuit440D Dec 30
 single-sideband8 July 38
 volume limiter20 Dec 37
 Modulation depth measuring instrument62D June 38
 Modulation measurement, Seright23 Aug 36
 Modulation measurement by cathode-ray tube23D Jan 35
 Modulation monitoring70D Sept 36
 Modulator bridge, Hellmann28 Mar 38
 Modulator, bridge-rectifier28 Mar 38
 design simplified184 July 33
 equivalent circuits60D Apr 39
 series, television transmitter.....263 Aug 32
 Moisture detector, v-t.....163D Oct 31
Molecules, see Particles
 Monitor for c-w keying.....44D Dec 37
 Monitor, r-f communications.....32D Dec 39
 Monitoring a welder with mathematics38D Jan 36
 More on combination tones.....61D Feb 39
 More on pressure capacitors.....60D Aug 39
 Motion picture, drive-in theater.....209 Aug 33
 Motion picture (cont'd)
 high-speed, production studies...7 Dec 35
 screen, acoustics420 Dec 30
 16-mm, sound-record48 Aug 31
 sound-on-film, 16-mm621 May 31
 sound, technique186 Nov 31
 wide-film proposal65 May 30
 very-high-speed, stroboscopic.....250 Aug 34
 Motion picture engineers survey latest advances in sound-pictures, Staff131 June 30
Motor, a-c, tube control.....31 Apr 36
 balancing shaded-pole, crt.....36 Oct 37
 control, astronomical telescope284D Sept 34
 d-c, electron tube.....179 June 34
 d-c, thyatron circuit20 Dec 38
 Errata.....11 Sept 39
 thyatron, takeup reel...293D Feb 38
 thyatron, wire reeling.....20 June 37
 for Scopophony television.....38D Dec 38
 rotor balancer, with pickup.....38D Mar 38
 speed control, tachometer and v-t244 Aug 35
 speed tester, cro.....11 Oct 39
 thyatron-commutated, 400 hp.....54D Feb 35
 tube-controlled14 Jan 36
 Movable anode tubes, McArthur.....16 Mar 37
 Movement for noise abatement, Staff108 Apr 35
 Movie dial in Ward radio, Chase53D Jan 39
 Mr. Diehl's standard microvolter (correction)323D Oct 32
 Mr. Dietsch on harmonic suppression (correction)199D July 33
 Multiband r-f choke coil design, Miller254 Aug 35
 Multilayer coil inductance chart, Maynard33 Jan 39
 Multiple-circuit pads, Wheeler.....33 Mar 37
 Multiple-grid tubes146D June 30
 Multiple-grid tube wavemeters for short waves606D Apr 31
 Multiple modulation286D Oct 33
 Multiplier, direct current.....34D June 36
 frequency, amplifier124 Apr 32
 phototube, secondary emission10 Nov 35
 v-t voltmeter42D May 38
 electron60D Sept 36
 Multiplying the range of a vacuum-tube voltmeter, Chinski42D May 38
 Multipurpose midget tubes.....48D June 39
 Multirange vacuum-tube voltmeter, Tulaszkas170 July 30
 Multistage photocell current amplifier applied to furnace temperature control, Richter245 Aug 35
 Multiunit phonograph for schools42D Feb 37
Multivibrator, circuit, capacitance coupling290D Sept 34
 trigger circuits14 Aug 39
 Muscular current, amplifier.....48D Feb 34
 Music, analysis by electronics.....239 Aug 30
 electronic (illustr)39 Feb 34
 Eremeef (illustr)365 Dec 32
 Hammond Novachord16 Nov 39
 instrument survey86 Mar 32
 instrument survey65 Mar 33
 instruments, European18 July 31
 pickup, church chimes.....18 Aug 39
 pitch control287 Sept 32
 Errata.....325D Oct 32
 oscillator565D Mar 31
 partials, circuits for producing298D Sept 30
 piano, electronic pickup design.....30 May 39
 pitch control, phototube.....376D Dec 32
 Music of the electron, Goldsmith270 Sept 30
 Musical instrument, electronic, oscillator56D Nov 37
 Musical instrument tuner, crt...17 July 37
 Muting, interchannel, broadcast receiver218 July 32
 Mutual inductance calculations, Pollack31 July 37
 Mutual modulation between transmitters44D Apr 36

N

NATURAL

OIL-BURNER

Pg—Mo—Yr	Pg—Mo—Yr	Pg—Mo—Yr
Natural frequencies of loudspeaker cones27D Jan 34	New high-frequency allocations, Staff31 June 36	Night radio effects194D July 33
Nature of metal surfaces revealed by electron diffraction50D Feb 36	New ignitron firing circuit, Klemperer12 Dec 39	Nine audio channels on single circuit in Scotch-Irish telephone circuit52D Dec 37
Nature of music, Redfield239 Aug 30	New impedance measuring device, Barber194D July 33	1935—In review (technical advances), Staff7 Jan 36
Navigation aid, aircraft, blind landing158 June 33	New IRE standards46D Dec 38	1939 London radio show52D Oct 39
aircraft compass, crt12 Aug 36	New insulating materials for radio frequencies162D May 34	1937 radio receivers, Staff22 July 36
altimeter, blind landing, fan marker10 Jan 39	New Italian television scanner46D Mar 46	1936—NEMA Radio and Electronic Section—1937, Staff16 Jan 37
beacon-marker transmitter29 May 36	New Jersey railroad installs p-a system on sightseeing train54D Nov 37	Noise, analyzer, transportation vehicles90D Mar 35
beacon, visual indicator248D Aug 34	New jobs for electrons (illustr)227 July 32	audio, abatement108 Apr 35
blind-landing, CAA-MIT12 Nov 39	New loudspeaker system55D Feb 33	analysis388D Nov 30
cable for ship guidance146D June 30	New low-noise vacuum tube18D Jan 33	broadcast listener survey11 Oct 36
compass, automatic radio685D June 30	New metal for grids, Kennedy54D Sept 38	gate, gas-tube, avc40 Feb 33
direction-finding, aerodrome196D July 30	New method for distance finding260D Aug 32	ignition, RMA-SAE survey41 May 36
night-error60D Mar 38	New method for measuring capacities at high frequencies140D May 33	intensities, table48D Feb 34
flying the Pacific by radio6 Apr 36	New method of measuring small alternating potentials564D Mar 31	limiter, a-f, using neon lamp52D July 36
fog horn-radio beacon260D Aug 32	New music of electronic oscillations, Staff86 Mar 32	for receiver7 Mar 36
harbor radio beacon285D Sept 34	New music of electrons (illustr)39 Feb 34	measurement, overvoltage timer8 Dec 36
radio and fog horn83D Mar 34	New optical crystals to aid atomic research38D Jan 36	portable equipment26 Apr 36
radio compass, fixed loop, homing7 Oct 35	New output tetrode65D Feb 35	meter, commercial listing110 Apr 35
receiver, offset course471D Jan 31	New permanent magnet alloys, Fink30 May 36	reception interference in France74D Sept 36
sextant, infrared detector201D June 32	New photoelectric cell348D Oct 30	Noise Reducer, see Noise Limiter
simulated for blind flying216D July 34	New plastic materials for cabinets, Chase26 Nov 37	Noise, reduction, broadcast receiver antenna20 Oct 38
survey20 Feb 38	New police superheterodyne uses superregenerative second detector42D May 36	r-f, sources46D Apr 36
Navigation, using broadcast stations34 Feb 36	New radio direction finding equipment at aerodromes reduces night error60D Mar 38	shot, in diode52D Jan 39
NBC, engineering department41 Nov 36	New radio-frequency coils with magnetic cores348D Nov 32	suppression, auto-radio273 Oct 33
NBC, Hollywood, Rackey & Shuetz10 May 39	New radio prosperity (survey), Staff296 Nov 33	suppressor, interrupter devices166D May 35
NBC's new studios in Radio City, Staff324 Dec 33	New radio receiver construction (illustr)145 May 35	rotating machinery164D May 35
Needle-scratch frequencies73D Aug 31	New radio receivers show improved technical design (survey), Staff218 July 32	Noise and noise measurement (bibliography), Silverman34 Feb 39
Negative-resistance oscillators54D Aug 39	New radio uses for cathode-ray tubes249D Aug 34	Noise (audible) measurement methods, Staff110 Apr 35
NEMA electronic section 193716 Jan 37	New selenium tube, Metcalf & King234 Dec 31	Noise in frequency modulation, Roder22 May 37
Neon indicator test reveals grounds46D May 36	New short-wave superheterodyne circuit67D Feb 32	Noise in vacuum tubes26 Aug 37
Neon sign changer on dirigible354D Nov 34	New 6E5 circuit, Levy28 Oct 36	Noiseless sound-on-film recording, Lewin102 Sept 31
Neon tube condenser tester, Browning22D Jan 35	New solar radio disturbance, Dellinger25 Jan 36	Noiseless recording with double triangle slit, and double-cathode photocell, Dimmick & Belar142 May 34
Neon tube, photoelectric effects52D Sept 39	New standards on electronics58D Oct 38	Noise recorder for comparing street-car sounds, Phillips99D Mar 32
Network, attenuation, a-f pads508 Feb 31	New system of television196D July 30	Noise-reducing circuit, Nicholson14 Oct 36
attenuation, matching multiple circuits33 Mar 37	New television film projector, Bamford25 July 38	Noise reduction (photomultipliers)54D May 39
equalizing and reactance chart30 Oct 39	New television synchronizing system605D Apr 31	Noise rejection circuits, Russell38D May 39
four-pole, impedance measurement31 July 38	New television system650D May 31	Noise survey puts street-car baritone above Niagara Falls soprano14D Jan 34
impedance matching552D Mar 31	New thermionic motor speed regulator, Norris244 Aug 35	Nomogram for coil calculations, Nachod27 Jan 37
r-f impedance-matching, pi-section29 Jan 36	New things ahead in radio sets and tubes, Staff277 Sept 34	Nonlinear distortion by band-pass filters48D Feb 36
sound-recording simplified44D Jan 39	New transmission system avoids coupling equipment for broadcast tower lighting38D July 36	Note on the performance of electrodynamic loudspeakers64D Mar 37
Network design chart84 Mar 35	New transmitter and receiver for ultrashort waves322D Oct 32	Note on video amplifier design (correction)52D Nov 37
Network resistances for balanced attenuators, Blakey33 Nov 35	New tubes—a rush of new ideas, Staff574 Apr 31	Notes on audio-frequency measurements, Hilliard506 Feb 31
Network-selecting chart, Selgin30 Oct 39	New tubes, detectors, rectifiers, amplifiers, Staff118 Apr 32	Notes on dual-band receiver design, Messing300 Nov 33
Neutralization, see also Feedback	New tubes, new tube materials, Staff93 Apr 33	Notes on manufacture of mercury-vapor rectifier tubes, Weiler99 Apr 31
Neutralization, input conductance22 Oct 39	New tuning indicator divides control range between two elements42D July 33	Notes on the 59-type power output tube, Jarvis310 Oct 32
Neutralizing, frequency-multiplier amplifier124 Apr 32	New type bridge-balance indicator122D Sept 31	Notes on the Paris international radio exposition, Kock40D Aug 36
New amplifiers—detectors and rectifiers, Staff35 Feb 33	New type of tube voltmeter142D Apr 32	Novacord, Merrill16 Nov 39
New antennas for KDKA and WJZ36D Aug 36	New type of vacuum seal58D Sept 38	Novel acoustics of Konigsberg studios (illustr)121 Apr 35
New applications for high-power public address systems40D Nov 33	New unidirectional microphone, Baumzweiger62D Feb 39	Novel characteristics of tube-commutated 400-hp motor54D Feb 35
New aviation beacon system248D Aug 34	New use of the suppressor-grid r-f pentode, Ritter10 Jan 32	NRA code for radio manufacturers238 Sept 33
New bioelectric application, electroencephalography, Rahm11 Oct 39	New v-i and reference level, Affel, Chinn & Morris28 Feb 39	NRA code, radio industry208 Aug 33
New British frequency changer228D July 35	New voltage quadrupler, Garstang50 Feb 32	Nuclear physics chart, Lack33 Aug 37
New British television system94D Mar 34	New welder tube, Knowles, Lowry & Gessford27 Nov 36	Nuclear physics, cosmic radiation17 Apr 34
New cathode ray for declimeter waves198D July 33	New WOR, Staff38 Feb 35	Null indicator, bridge, crt36D Sept 38
New cathode-ray oscillograph tube, Metcalf158 May 32	New York City's fire boat communication system, Borsody10 Apr 38	for bridge measurements52 Nov 36
New coaxial transmission line at WTAM, Duttera30 Mar 39	New York to use microwave beam34D Aug 36	v-t, inductance bridge478 Jan 31
New cold-cathode gas-triode, Bahls & Thomas14 May 38	News notes from England93D Mar 34	Wheatstone bridge, v-t122D Sept 31
New color-separator, Richter28 Mar 37	News pictures by wire, Dudley12 Nov 37	Number of elements and effect of picture259D Aug 34
New developments in television receivers46D Feb 36	Nickel, tube elements, manufacture4 Jan 33	Nunan yarn tester12 Feb 39
New electric organ based on alternator principle166D May 35	Night-club lighting to match millady's dress122D Apr 35	Ohmmeter, electronic, free-grid214 July 35
New electron tubes—facts and rumors, Staff216 Dec 31		Oil analysis, dielectric constant15 Dec 35
New electronic (music) instrument376D Dec 32		Oil-burner flame, through tube, controls fuel470D Jan 31
New electronic tool—the discharging condenser105D Apr 33		
New fact in electricity48D Apr 37		
New flat tube300D Sept 30		
New forms of r-f lines59D Sept 36		
New forms of short-wave tubes, Mouromtseff, Kilgore & Noble278 Sept 32		
New 41-mc W8XH, Kingsley19 Jan 36		
New fundamental frequency standard248D Aug 30		
New German vacuum tubes 1933-3426D Jan 34		

OIL-BURNER

PHASE

Pg—Mo—Yr

Pg—Mo—Yr

Pg—Mo—Yr

Oil-burner shutoff, flame-failure, photocell 222D Aug 33
Old and new circuits for the binode detector 228D July 34
On some recent (cold cathode) tube developments 67D Sept 39
On the operation of externally controlled tubes 442D Dec 30
On the (television receiver) production line (illustr.) 36 June 39
On the theory of filter amplifiers 441D Dec 30
150-ampere condensers for broadcast station 130D Apr 35
190-kc surge converts copper strap into tubing 359D Nov 34
110-megacycles transmission spans 100-mile stretch 95D Mar 35
One-tube balanced circuit for d-c amplifier 318D Oct 32
Opacimeter, photocell, chemical analysis 61D Apr 39
Operating characteristics of power tubes 52D Aug 38
Operating conditions affecting inter-electrode capacitance 71D June 38
Opposed phototronic cells responsive, independent of general illumination 44D Feb 33
Optical feedback circuit 238D July 32

Optics, see also Electron Optics
Optics, electron microscope 30 Nov 38
electron telescope 10 Jan 36
eye, accommodation to darkness 270D Aug 32
Organ, electronic, photocell 248D Aug 30
photocell and film 15D Apr 34
rotating disk, WCAU 233D Apr 35
tone-wheel alternator 156D May 35
Organic tissues at short waves 52D Aug 37
Orientation mechanism, Rubenstein 225D Aug 33
Origin of word electron 395D Nov 30
Orthicon, Fink 11 July 39
Oscillating crystals 24D Jan 33
Oscillating sulphide crystals 33D July 31

Oscillation, see also Oscillator
Oscillation, parasitic, in transmitters 26 Oct 38
Oscillations produced by gaseous diodes, Craig 639 May 31

Oscillator, see also Oscillation
Oscillator, a-f, beat-frequency, single-tube 356 Nov 34
Errata 23D Jan 35
a-f, bfo 50D Nov 39
dynatron, two-frequency 417 Dec 30
electron-coupled 56D May 36
precision heterodyne 227D July 34
all-wave signal generator, production tests 244 Aug 34
audio, beat, a-c operated 20 May 36
for a-c 20D Jan 34
Barkhausen-Kurz 9 Aug 36
uhf 376 Nov 30
Barkhausen, tube 4 July 31
bfo, capacitor plate shape 369 Dec 32
c-w reception 38 Mar 35
hexode mixer 229D July 34
low L-C ratio 229D Aug 33
wire gage 70 May 30
circuit, mixed coupling 290D Sept 34
circuits, frequency characteristic 56D May 39
coaxial line, uhf 46D Aug 38
comparison, for capacitor tracking 12 Mar 37
crystal, bridge stabilized 8 July 38
cyclotron, 12-mc 7 Nov 35
decimeter wave 28D Jan 32
dielectric-constant determination 25D Jan 34
efficiency of tubes at short waves 292D Sept 34
feedback optical 238D July 32
50 to 100 centimeter 36D Dec 37
400-cps, low-distortion 131D Apr 35
Gill-Morell 9 Aug 36
uhf 376 Nov 30
high-frequency, triode 60D Dec 37
in a-c design 28 Sept 36
industrial process control 144 Oct 31
Errata 208D Nov 31
Kolster hat type, uhf 26 Dec 38
low a-f, sine-wave 65D Oct 38
magnetostriction, r-f 34D July 31
magnetron, negative-resistance, 206 July 35
split-anode 34 Apr 30
split-anode 60D Mar 39
microwave, and modulator 50D June 38
phonograph-radio receiver 54 Oct 38

Oscillator (cont'd.)
piezoelectric, circuit characteristic 22 Aug 38
pulling, synchronization 26D Jan 34
quartz-control, two-tube 314D Nov 33
quartz-crystal, resonant frequency 34D July 31
quartz, influence of surroundings 34 July 31
sound waves 34D July 31
thermostat control 27D Jan 34
relaxation, stabilized, sweep-circuit 20 Apr 39
trigger circuit 285 Sept 30
resistance stabilized 190 July 33
screen-grid 26D Jan 34
self-excited, stability 48D Apr 37
signal-generator, broadcast receiver testing 668 June 31
receiver production 225 Sept 30
sine-wave, gas-discharge tube 92 Mar 35
sinusoidal, and relaxation 300D Sept 30
without tuned circuits 258D Aug 34
60 to 100 mc, construction 29D July 37
stabilized, thyatron 204D Nov 31
stable, using screen-grid tube 290D Sept 34
superheterodyne receiver 46D Jan 39
theory, Pierce-type 92D Mar 34
thyatron 18D Jan 33
transitron 54D Aug 39
tuning effects, coupling coil 50D Oct 35
tuning fork, and crt 12 July 37
20-100 mc signal generator 17 Aug 36
20 to 60 mc 12 Oct 36
uhf, measurements 60D Dec 39
new tubes 278 Sept 32
ultrasonic, piezoelectric 52D Oct 39
vacuum-tube, types 194D June 34
variable-frequency, 3-10 m 92D Mar 34
Oscillator circuits 50D Feb 37
vht, push-pull 32D July 31
resonant-line tank 33 Oct 35
wide-range, a-f, bfo 56D Feb 39
Oscillator circuit measures humidity 74D Mar 33
Oscillator detector 83D Mar 34
Oscillators for ultrahigh-frequency 52D Aug 39
Oscillator locates faults in high-tension transmission line 40D Nov 35
Oscillator used for coil testing 62D Nov 39
Oscillogram, interpreting patterns 60D Nov 36
welder currents 16 Dec 37

Oscillograph, see also Oscilloscope
Oscillograph, crt photography 37 Apr 38
polar coordinate 46D Dec 36
string, film-recording 70 Aug 31
Oscillograph amplifier covers from 0.2 to 3 X 10⁶ cycles 38D Nov 36

Oscilloscope, see also Oscillograph
Oscilloscope, c-r, for use at uhf 15 Sept 36
c-r, long-persistence 36D Jan 36
power supply 110 Apr 34
crt, applications 14 Apr 38
characteristics 332 Dec 33
stabilized sweep 93D May 30
synchronous deflection 564D Mar 31
tripotential 28 Jan 37
four-trace 51D Apr 38
linear sweep 198 June 32
multiple-display, synchronous switch 170D June 33
photographing transients 125D Apr 34
photography, crt 19 July 39
timing-axis circuits 22D Dec 31
trigger for transients 58D Jan 37
Oscilloscope as wow detector, Travis 40D Feb 39
Oscilloscope used for checking speed of small motors 47D Oct 39
Our February cover (correction) 57D Apr 39
Outgassing electrodes, by r-f heating 58D Mar 37
Output amplifiers for 110-volt d-c receivers, Nelson 128 Apr 32
Output meter for testing radio receivers, Franks 190 July 30
Output transformer design—II, Hitchcock & Osbon 427 Dec 30
Output transformer (frequency) response, Terman & Ingbertsen 30 Jan 36
Output tube problems 363D Nov 34
Output tubes 52D July 39
Overvoltage lamps in photography 127D Apr 35
Overload limit extension of the tetrode detector, Franham 228 Dec 31
Oxide-coated filament research 66D Feb 32
Ozone measurement, phototube 121D Sept 31

P

Packaging control, photoelectric 302 Nov 33
Packing, container design, radio components 558 Mar 31

Pad, see also Attenuator; Network
Padding condenser, McNamee 160 May 32
Padding condenser, Sklar 49D May 37
Palermo equation, inductor distributed capacitance 31 Mar 38
Panoramic reception shows promise in radio navigation 36D July 38
Paper color matching, phototube comparator 18 Sept 38
Paper mills use stroboscope 49D Feb 34
Paper vs electrolytic filter condensers 160D May 35
Paragraphs on television synchronization, Duncan 51D Feb 38
Parallel impedance chart, Fink 31 May 38
Parasitic circuits, Ekstrand 26 Oct 38
Paris television waiting for peace (illustr.) 16 Dec 39

Particles, electron diffraction, measurements 24 Sept 35
electron theory 64D Feb 38
electron waves and quanta 249D Aug 37
electrons, positrons 44D Mar 36
mass, proton and electron 196D July 30
neutron discovery 103D Mar 32
Parts, receiver manufacture 12 Feb 36
Passage of r-f currents through discharge tubes 176D May 32

Patent, amplifier circuits, listing 221 July 32
amplifier license 152 May 32
duties of attorney 72D Feb 39
electronic inventions 306 Oct 32
Langmuir high-vacuum case 476 Jan 31
licensing, electron tubes and circuits 143 May 35
proposed legislation 116 Apr 32
reforming US system 9 May 38
Patent cases in the courts, Van Allen 189 July 30
Patent pool and the radio inventor, Staff 46 Aug 31
Patent problems in the field of electronics, Toulmin 306 Oct 32
Patent review on receiver circuits and tubes, Rogan 672 June 31
Patents on industrial uses of light-sensitive cells, Logan 27D July 31
Patents practice essentials, Goldsborough 33 Sept 36
Patents relating to electronic devices in industry, Staff 92 Aug 31
PE cells for light measurement, Poole & Atkins 42D Apr 36
Peak voltmeter useful for sound recording 42D Aug 38
Pentode, r-f, single-ended 26 Sept 38
Pentode tubes used as triodes, Nelson 226 Dec 31
Pentode vs triode 650D May 31
Pentodes as r-f amplifiers 52D Oct 36
Pentodes for high-frequency operation 60D Nov 36
Perforated steel sheets pass sound waves 222D Aug 33
Perforator, stamps, phototube control 27 Sept 35
Periodicals of the world (Bibliography) 50 Sept 35
Permanent magnets for electronic instruments, Hoppe 636 May 31
Permatron and its application in industry, Overbeck 25 Apr 39
Permeability of iron at ultra-radio frequencies 48D Feb 33
Permeability tuned pushbutton system, Tucker 12 May 38
Permeability tuning introduced in i-f transformers 260D Aug 35
Permittivity and power factor of mica 33D July 31

Personnel, engineer rating 126 June 30
engineers, in large organization 62 May 30
Perveance, electron tube parameter 60D June 38
in amplifier calculations 41 Nov 37
Petoscope, Fitzgerald 26 Oct 35
pH meter, v-t galvanometer 39 Nov 37
Phantom (tube) tester, Knowles & Haller 18D Jan 33
Pharmacy, optical electronic techniques 248 Sept 33
Phase defect measurements at frequencies above 1,000 kc 228D Aug 33
Phase differences of insulating materials used in radio 292D Sept 34

PHASE

PHOTOTUBES

Pg—Mo—Yr	Pg—Mo—Yr	Pg—Mo—Yr
Phase distortion, amplifier with-out26 June 37	Photoelectron faster than bullet...155D May 34	Photoelectric tube controls game in large German preserve38D Jan 37
Phase-failure relay, v-t, a-c power46 Feb 33	Photoelectron maintains slack187D June 35	Photoelectric tubes as limit switches in sheet mill, Bowers.....64D Aug 31
Phase-frequency modulation, Fink.17 Nov 35	Photoelectron measures dust in chemicals46D Jan 37	Photoelectric u-v photometers.105D Apr 37
Phase inversion circuits.....58D Oct 37	Photoelectron record speeds up dial telephone calls292D Sept 30	Photo-emf cell characteristics, Holmes33 Apr 37
Phase-inverter, amplifier, to push-pull stage40D Oct 35	Photoelectron response to sudden illumination376D Dec 32	Photographic timer, electronic.33D Aug 38
Phasemeter, c-r, medical research.24 Jan 38	Photoelectron safeguards oil-burning power plant222D Aug 33	Photography of transients with cathode-ray oscillograph125D Apr 34
Phcrt, antenna adjustment.....62D Apr 39	Photoelectron sets type from teletype copy54D Feb 35	Photography, oscilloscope, crt.....19 July 39
Philco shows 441-line television, Staff9 Mar 37	Photoelectron smoke and fire-alarm.306D Nov 33	stroboscopic220 July 32
Phillips binode tube23D Jan 33	Photoelectron sorts letters for British post office34D Apr 37	motion study11 Feb 39, 57D Apr 39
Phillips-Miller recording system56D Sept 38	Photoelectron static discharger at WLW316D Oct 34	time-lapse, control24 Sept 39
Phonograph, see also Pickup; Playback; Recorder	Photoelectron steers ship122D Apr 35	Photometer, stabilized-bridge30 Dec 39
Phonograph, electronic, uses121 Apr 32	Photoelectron temperature regulator, Weinland224D July 35	vacuum-tube voltmeter190D June 34
lightweight pickup36 May 36	Photoelectron thermometer334D Dec 33	Photometering raw silk, Finlay12 July 36
Phonograph pickup tracking error vs distortion and record wear, Olney19 Nov 37	Photoelectron traffic signals on bridge path278D Oct 33	Photometry of stars by means of a photocell and low grid-current tube49D Feb 33
Phosphor, characteristics52D Mar 39	Photoelectron transparency tester.28D July 37	Photometry, photocell applications243 Aug 30
crt screens31 Dec 38	Photoelectron used for spectroscopy measurements58D Feb 35	phototube amplifier284 Sept 32
zinc silicate59D Aug 39	Photoelectron watches turbidity of Denver water supply.....306D Nov 33	Photos by telephone (illustr).....6 Mar 36
Photometer, electronic221D July 34	Photocells correct for cable stretch49D Feb 34	Phototube, see also Photocell; Electric Eye
Photoalarm calls police on telephone40D Nov 35	Photocells enter textile field.....14D Jan 34	Phototube, circuit, logarithmic.62D Feb 38
Photoalarm, infrared for large area43D May 37	Photocells for special applications, Rentschler29 Apr 30	color analyzer curve plotter...17 Mar 36
Photocell, see also Phototube	Photocells for the ultraviolet.109D Apr 33	color matching, paper.....18 Sept 38
Photocell, amplifier, d-c44D Jan 38	Photocells from rectifier discs, Wilson312 Oct 32	control, candy wrapper.....18 Aug 37
applications, listing270 Oct 33	Photocells in industry2 Jan 34	for street lighting.....36D Mar 37
barrier-layer, magnetic field.298D Sept 32	Photocells in Weather Bureau observations, Lyford316D Oct 34	controls (illustr)95 May 30
barrier-plane162D May 34	Photochemical combination used as switch control, Jupe.....36D Apr 38	counter60D Jan 38
response315D Nov 33	Photoelectric alarm26 Feb 37	curve plotter361 Dec 32
barrier, sensitivity vs frequency199D July 33	Photoelectric cathodes, properties59D Feb 34	for smoke indication.....42D May 37
barrier type, double42D Apr 37	Photoelectric cell circuit.....236D July 32	galvanometer amplifier46D June 37
blocking layer54D Sept 37	Photoelectric cell manufacture.92D Mar 34	grid and screen-grid.....650D May 31
curves42D Mar 36	Photoelectric cell—properties and characteristics28 Apr 30	hysteresisgraph48D Sept 37
caesium silver-oxide manufacture255 Aug 32	Photoelectric cell thermoregulators, Brickwedde & Scott.....45 Apr 30	light variation indicator.....36D June 36
characteristics76D Aug 31	Photoelectric cell used for chemical analysis61D Apr 39	multiplier, grid-type38D Mar 39
circuits114D Sept 31	Photoelectric cell used in traffic control339D Oct 30	noise reduction54D May 38
color sensitivity220 Aug 30	Photoelectric cell with semiconductor dielectric396D Nov 30	radiovisor cell, Rayfoto.....269D Aug 32
comparative listing171D June 33	Photoelectric cells and colorimetry243D Dec 31	relay, timer, for photography.....22 June 37
compensating circuit48D Dec 37	Photoelectric cells in precision inspection work, Tietz & Paulson6 Jan 32	seismology study40D Feb 36
control, installation276 Oct 33	Photoelectric color-measuring device used for process control36D Jan 36	selenium, characteristics234 Dec 31
copper-oxide vs selenium, drift.15 Jan 39	Photoelectric color-measuring instruments, Neustadt128 May 33	simple light meter.....36D June 36
cuprous oxide-copper25D Jan 34	Photoelectric control in the printing arts, Staff334 Nov 32	telegram conveyor22 Mar 36
differential circuit, in daylight.44D Feb 33	Photoelectric control on packaging machines, Smith302 Nov 33	35 μ a-per-lumen86D Mar 34
for light measurement.....42D Apr 36	Photoelectric control widens in industry (survey), Staff.....269 Oct 33	ultra-violet recorder12 June 36
gas-filled, characteristics80D Mar 33	Photoelectric counters for visible and ultraviolet light.....81D Mar 33	v-t used as372 Dec 32
Geiger-counter principle164D Oct 31	Photoelectric density comparator for analyzing spectrograms358D Nov 34	Phototube aids high-speed printing42D Sept 37
headlight testing30D Aug 37	Photoelectric effect from barium oxide coated platinum filament78D Aug 31	Phototube amplifiers634D May 31
in highway safety study.....46D May 36	Photoelectric effect, selective...299D Sept 30	Phototube and amplifier for measuring ozone121D Sept 31
industrial, properties66D Feb 32	Photoelectric effects on neon tubes, Baker52D Sept 39	Phototube circuit design for sound pictures, Wyeth22 July 31
mixed layer163D May 34	Photoelectric measurements of illumination162D Oct 31	Phototube color analyzer used in chemical research40D Mar 38
output, series and parallel.....118 Apr 35	Photoelectric method of measuring yarn leanness206D Nov 31	Phototube controls logarithmic response in galvanometer, Jupe.....44D Apr 39
Photronic, characteristics168D May 32	Photoelectric mine-door control.36D Aug 36	Phototube controls punch press, Powers21 July 37
red-sensitive67D Feb 32	Photoelectric photometer54D Aug 37	Phototube detects skew in cotton cloth30D June 37
selenium-iron barrier type.....126D Apr 34	Photoelectric photometer for sorting glow lamps163D Oct 31	Phototube detects stamped mail48D June 37
sensitized potassium206D Nov 31	Photoelectric photometer tests air purity45D Jan 33	Phototube drawer opener used to safeguard dental patients.....40D Mar 38
sensitizing in manufacture.....518 Feb 31	Photoelectric properties of extremely thin films of alkali metals, Ives & Briggs.....45 Apr 30	Phototube for gaging.....75D June 39
types and applications.....74 May 30	Photoelectric protection of art object155D May 34	Phototube in automatic weaving, Korn378 Nov 30
voltage control, d-c generator.86D Mar 34	Photoelectric pyrometer52D Feb 37	Phototube indicates softness of water34D Oct 38
Photocell adding machine works in billions684D June 31	Photoelectric pyrometer and spot welding140D May 33	Phototube inspects oil holes.....54D Sept 39
Photocell amplifier circuit19D Jan 33	Photoelectric recorder of high sensitivity140D Apr 32	Phototube limit relay applied to weighing problems40D Oct 37
Photocell anemometer reads wind velocity directly222D Aug 33	Photoelectric spectrum chart.....120 Apr 32	Phototube motor control.....31 Apr 36
Photocell as applied to industrial problems, Breisky227 Aug 30	Photoelectric traffic counter.....275 Sept 34	Phototube race timer, five tube34D Apr 37
Photocell camera guards laboratory134D Apr 32		Phototube scans steel for pin-hole flaws42D Dec 38
Photocells control Detroit bridge traffic, Cooper114 June 30		Phototube spectrophotometer54D Feb 38
Photocell control of street lights.156D Oct 31		Phototube temperature control, Powers12 Apr 37
Photocell control of temperature for filament-coating ovens, Koechel170 May 32		Phototube time teller42D Sept 36
Photocell-controlled elevator doors, Ellis54 Feb 32		Phototube timers for all New York race tracks38D Nov 35
Photocell controls car painting.284D Sept 34		Phototube timers on Indianapolis speedway36D Aug 36
Photocell controls truck-garage doors132D May 33		Phototube to facilitate handling of visitors at Texas centennial exposition52D May 36
Photocell detector to be used with new 200-in. telescope mirror40D Jan 36		Phototube traffic recorders.....38D Nov 36
Photocell detects sand impurities27D Jan 34		Phototube voltage supervisor, Koechel418 Dec 30
Photocell effects large savings in demand charges223D Aug 33		Phototube yarn tester.....12 Feb 39
Photocell guard against suicides and sleepwalking356D Nov 34		Phototubes applied as traffic safety aid, Sherman40D Nov 38
Photocell in spectacular roles (illustr)256 Aug 30		Phototubes control cocoa refining plant53D July 37
Photocell (installations) experience in the factory, Edelman.....15 Mar 38		Phototubes control furnace temperatures192D Nov 21
Photocell integrator for irregular areas98D Mar 32		

PHOTOTUBES

PROPAGATION

Pg—Mo—Yr

Pg—Mo—Yr

Pg—Mo—Yr

Phototubes control swing bridge,
Jupa36D Mar 37
Phototubes examine edges of razor
blades34D Jan 37
Phototubes for testing power
tubes253D Aug 35
Phototubes operate soaking-pit
covers306D Nov 33
Phototubes perforate US stamps,
Church27 Sept 35
Phototubes save coating metals,
Ball48D Nov 38
Phototubes used for catching
speeders59D Feb 35
Phototubes used in determining color
temperature62D Feb 37
Phototubes used in sorting and
tabulating machine50D Nov 37
Photovoltaic cells in compound circuits,
Wilson118 Apr 35
Physiology, artificial fever,
10-mc waves68 May 30
c-r phasemeter24 Jan 38
recorder for eye movements.....34D Aug 38
Piano, Electronic, see also Organ
Piano, electronic, string pickup...26 Jan 39
electronic, using vibrating
reeds226 July 34
tuner, stroboscope44D Sept 37
Pickup, constant tracking
angle31 Feb 37
lightweight magnetic36 May 36
phonograph, high-fidelity9 Mar 38
Pickup angle again, Grozier...73D May 38
**Picture, see also Facsimile; Motion
Picture; Sound Picture; Television**
Picture, transmission, crt.
narrow-band54D Apr 39
Pictures by wire, Staff.....13 Sept 39
Piezoelectric crystal as frequency
standard300D Sept 30
Piezoelectric loudspeakers and
microphones, Williams166 May 32
Piezoelectric measuring devices, Kluge,
Lincke, Webster, Brown &
Harris115 Sept 31
Piezoelectric methods of measuring
mechanical forces, Saxl...292D Sept 32
Piezoelectric oscillator circuits...22 Aug 38
Piezoelectric properties of Rochelle
salt55D Feb 33
Piezoelectrical arrangement for
receiver205D June 32
Piezoelectricity, history44D Aug 37
Pipe detector makes use of high
permeability alloy40D Mar 36
Pipe-line finder, electronic.....15 Dec 35
Pitch control for electronic
musical instrument,
Bunting287 Sept 32
Errata322D Oct 32
Pity the parts suppliers!, Ely.....12 Feb 36
Place of nickel in radio tube
manufacture, Marino4 Jan 33
Plan to eliminate radio interference,
Goldsmith370 Dec 34
Plastic cabinet design, Chase16 June 39
Plastic cabinets, molded26 Nov 37
Plastic material, properties36 Mar 36
Plastics, Chase10 Mar 36
Plastics, laminated, for radio
receivers8 Oct 38
Plate circuit theorem, Richter...19 Mar 36
Plate current characteristics and bright-
ness of cathode-ray tubes.315D Nov 33
Plate detection of radio
signals30D Jan 32
Plate resistance, effect of magnetic
field32D Sept 38
Play-back recording methods for
broadcasting, Schrage179 June 35
Polar coordinate oscillograph...46D Dec 36
Polaroid glass used to check glass
tube production40D Apr 36
Police plan radio telegraph
net36D Mar 37
Police Radio, see Communications
Polyphase self-excited systems...163D Oct 31
Porcelain pipe at WHAM,
Long24 Oct 38
Portable-high voltage supply...57D Aug 39
Portable phototube amplifier with high
input resistance50D Aug 37
Portable radios aid forest-fire
fighters83D Mar 34
Portable reverberation meter,
Sabine30 Mar 37
Portable sound measurements,
Anderson26 Apr 36
Positive-grid amplifying detector for
10-cm waves259D Sept 33
Potential distribution, v-t study,
plotter192 June 32

Potentials below one microvolt measured
by means of d-c
amplifiers195D June 35
Potentiometer, recording,
Speedomax21D Jan 34
v-t, a-f250D Aug 30
Power amplifier with positive grid-bias,
Thompson139 June 30
Power control by means of phototubes,
Baker, Fitzgerald &
Whitney632 May 31
Power control thru grid-regulated
heavy-current tubes,
Pike85 May 30
Power demand indicator,
photocell223D Aug 33
Power detection characteristics of
pentode tubes,
Brown & Knipp.....126 Apr 32
Power factor measurements with vacuum
tubes649D May 31
Power for television receivers,
Engstrom & Holmes...22 Apr 39
Power level indicators56D Sept 37
Power pentode, its characteristics and
applications, French12 Apr 30
Power-saving tubes with copper
cathodes44D June 36
Power Supply, see also Voltage Regulation
Power supply, dynamotor, auto
radio80 Mar 32
high voltage, portable57D Aug 39
vibrator, auto-radio80 Mar 32
auto-radio254 Aug 32
dry-cell214 July 34
vibrators25 Feb 36
voltage quadrupler50 Feb 32
Power supply and linear time axis for
cathode-ray oscillographs,
Meier & Richards110 Apr 34
Power supply filter curves,
Waltz29 Dec 35
Power supply system for electric
clocks52D Mar 37
Power transformers for automobile radio
vibrators, MacNabb149 May 34
**Power transmission, d-c, electronic
devices**554 Mar 31
d-c, using electron tubes...56 Feb 35
using v-t324 Oct 30
Power tube characteristics,
Chaffee30 July 37
Power tube characteristics,
Chaffee34 June 38
Power tubes52D May 38
Practical design for an electronic
piano, Merrill30 May 39
Practical elimination of night-time
fading378D Dec 32
Practical feedback amplifiers,
Day & Russell...16 Apr 37
Errata7 Oct 38
Practical measurements of ultraviolet
intensity470D Jan 31
Practical metal detector,
Broekhuysen17 Apr 38
Practical method of toe recording,
Lewin464 Jan 31
Practical remote amplifiers,
Carlson25 Aug 38
Errata7 Oct 38
Practical time signal system for
broadcasting, Mayer246 Aug 35
Practical vacuum-tube
potentiometer18D Jan 33
Practical volume compression,
Hallman15 June 36
Practical volume expansion,
Sinnott14 Nov 35
Practical wired radio system...46D July 38
Preamplifier, see also Amplifier
Preamplifier, dynamic microphone.52 Feb 34
Precipitation, of dust, by high
voltage (illustr)35 Nov 37
Precise light measurement—a new
photocell application,
Fink190D June 34
Precision condenser calibration at radio
frequencies, Hall & George.318 Oct 34
Precision determination of e/m...62D Mar 39
Precision frequency control...64D Oct 38
Precision receiver precision made
(illustr)22 Jan 38
Pre-emphasis, a-f, broadcasting...29 Nov 39
for high-fidelity receivers...94D Mar 35
Preparation of potassium photocells by
electrolysis120D Sept 31
Present costs of broadcast
stations254 Aug 34
Present-day status of broadcast
synchronizing, Staff175 June 35
Present ultrashort-wave developments
for broadcasting650D May 31

Press stop operated by photocell.75D Mar 33
Pressure capacitors, Staff.....16 Apr 39
Pressure-change measurement, quartz
and cro315D Nov 33
Pressure gage, piezoelectric...292D Sept 32
Prevention of repeat points...364D Nov 34
Prices of components tend to stabilize,
Staff64 Mar 33
Prices of radio stocks, Yates...52 Aug 31
Pricing radios by formula,
Staff120 Apr 35
Primary and secondary electrons in
three-electrode tubes...163D May 34
Printing, photoelectric drying
control42D Sept 37
Printing plates made by photocell
method339D Oct 30
Printing telegraph system...65D Oct 38
Problem of auto-radio antennas,
Staff41 Feb 35
Problem of measuring the gas content of
gas-filled incandescent
lamps46D Nov 37
Problem of pentode output fidelity,
Tulaszkas142 Oct 31
Problems of cathode-ray television,
Maloff10 Jan 34
Problems of push-push amplification,
Kilgour82 Mar 32
Problems that face the radio engineer,
Graham174 Nov 31
Process Control, see also Control
Process control, capacitance
variation144 Oct 31
Errata206D Nov 31
Processes in vacuum-tube manufacture,
exhaust—carbonizing—ageing,
Wagner213 July 34
Producing artificial fevers,
Carpenter & Page68 May 30
Producing very high frequencies by
means of the magnetron,
White34 Apr 30
Production, electronic apparatus,
methods90 Apr 33
testing, electrolytic capacitors.216 July 35
signal generator244 Aug 34
Production of millimeter
waves50D Dec 37
Production of radio-frequency
impulses46D Feb 37
Production testing of present day radio
receivers, Thomas498 Feb 31
**Program Distribution, see also type,
e.g., Carrier Current; Wired Radio;
etc**
Program distribution, carrier, Lincoln
Hotel682 June 31
Program-failure alarm for broadcast
stations, Chinn & Moe...24 July 39
Program of new German tubes...44D Dec 35
Progress in insulating materials for
r-f53D Feb 34
Progress in photocells650D May 31
Progress in sound analysis and
measurement25D July 31
Progress in sound-picture recording,
Dreher542 Mar 31
Progress in sound pictures,
Dreher7 June 36
Progress in the elimination of artificial
static291D Sept 34
Progress measuring and preventing
artificial static42D Oct 36
Progress of the radio art (IRE),
Staff202 June 35
Projection kinescopes57D July 39
Projector, television, film...25 July 38
Proof-read recording, Staff.....39 Dec 35
Propagation, see also Ionosphere
Propagation, British television...54D Apr 37
broadcast coverage16 May 36
broadcasting, favorable
frequency19D Jan 33
changes, sunspot effect...69 Mar 23
day-night frequency characteristics
(illustr)163 May 32
echoes and goniometry during
solar eclipse248 Aug 32
ether concept13 June 38
field-intensity measurement...59D Feb 39
field-strength, measurements...20 Aug 38
recorder, automatic148 May 34
field survey, police service...36D July 36
ground system effect.....33 Jan 38
in polar regions...42 Apr 30
magnetic disturbance effects...378D Dec 32
night-time, antenna array...110-mc, Blue Hill to Hartford.95D Mar 35
path-length measurement...350D Nov 32
radio waves change speed...64D Sept 36

PROPAGATION

RECEIVER

Pg—Mo—Yr

Pg—Mo—Yr

Pg—Mo—Yr

Propagation (cont'd)
 reflection and refraction,
 10-30 m waves.....349D Nov 32
 r-f, characteristics.....90 Sept 31
 signal increase during
 eclipse.....113D June 30
 signal variation, meteorology.....169D May 32
 solar effects on ionosphere.....188 June 34
 Sommerfeld formula.....25 Sept 36
 study, facsimile pulses.....264D Aug 32
 sunspot effect.....122 Apr 32
 thunderstorm effects.....26D Jan 34
 ultrashort wave.....206 July 35
 vhf, rebroadcast for cities.....650D May 31
 Proper sites for broadcast stations,
 Horn.....66 Mar 33
 Properties and calibration of
 photocells.....48D Apr 30
 Properties of ceramic materials
 (table) Thurnauer.....33 Apr 39
 Properties of industrial
 photocells.....66D Feb 32
 Properties of plastic materials,
 Chase.....36 Mar 36
 Proposed Patent Office reforms,
 McBride.....116 Apr 32

Prospecting, see also Geophysics
 Prospecting, equipotential method.....184 Nov 31
 Prospects of high-fidelity transmission,
 Staff.....206 July 34
 Protecting a million-dollar
 painting.....155D May 34
 Protecting the high-voltage ammeter,
 Groves.....38D Feb 38
 Protecting the transmitter from
 shutdown.....58D May 38

Public address, high-power
 systems.....40D Nov 38
 multipurpose, in factory.....25 Dec 36
 Public address at Century of Progress,
 Staff.....274 Oct 33
 Public address avc, Paro.....24 July 37
 Public-address distribution system.....155 Oct 31
 Public address on the SS Normandie
 (illustr).....24 Oct 35
 Public address system aids bridge
 operator.....40D Mar 36
 Public relations in industry.....35 Oct 38
 Pulse generator, for ionosphere
 study.....46D Feb 37
 Punch press, phototube operator
 protection.....21 July 37
 Pushbutton station selection,
 French.....16 Sept 37
 Push-pull A and linear B
 circuits.....98D Mar 35
 Push-pull amplifier graphics,
 Kilgour.....73 Mar 33
 Push-pull detector for decimeter
 waves.....59D Feb 34
 Push-pull grid-controlled
 inverter.....346D Dec 33
 Push-pull stabilized voltmeter.....46D Dec 38
 Putting public address to work,
 Benner.....25 Dec 36
 Pyrometer, using phototube.....52D Feb 37

Q

Q, component-parts values.....126D Apr 35
 Quality detectors.....68D Feb 32
 Quality in disc reproduction,
 LeBel.....25 Oct 37
 Quality vs cutoff frequency in
 music reproduction.....389D Dec 34
 Quantum theory of photoelectric
 and thermionic effects in
 metals, Houston.....44 Apr 30
 Quartz clocks reveal change in
 earth's rotation speed.....44D Apr 36
 Quartz plates, standard fre-
 quency.....52D Dec 37
 Quartz-rod electronic precision
 clock.....104D Apr 33
 Quencher frequency, superregenera-
 tive circuit.....42 Feb 34
 Questions and answers.....48D July 37
 Questions and answers, Wein.....29 Sept 37
 Questions and answers.....76D Nov 37
 Questions and answers.....77 Feb 38
 Quick heater tubes in Germany.....227D July 34

R

Radar, see also Navigation Aid
 Radar, aircraft detection
 (illustr).....18 Sept 35
 Addenda.....42D Sept 35
 Radial ground system chart,
 Brown.....33 Jan 38

Radiation, see also Propagation
 Radiation, antenna, chart.....35 July 39
 Radiation by antennas without and within
 reflectors.....137D May 33
 Radiation-cooled power tubes for radio
 transmitters, Mendenhall.....316 Oct 32
 Radiation-counting circuits,
 Porter.....28 July 36
 Radiation, short-wave,
 Milky Way.....206 July 35

**Radio, see type, e.g., Communications;
 Broadcasting; Navigation Aid; etc**
 Radio abroad (statistics).....44D Aug 36
 Radio-acoustic ranging,
 Belcher.....308 Nov 33
 Radio adds new 1934 services
 (illustr).....141 May 34
 Radio and aviation.....33D July 31
 Radio and sound annual.....48D July 36
 Radio art advances told at IRE in annual
 convention, Staff.....206 July 35
 Radio broadcast problems gather,
 Staff.....156 June 33
 Radio, broadcasting, television in 1932,
 Staff.....2 Jan 32
 Radio buoying of aerodromes.....196D July 30
 Radio cabinet design, Gerth.....182 July 33
 Radio campaign on—RMA accepts NEMA
 code, Staff.....238 Sept 33
 Radio City, construction plans.....218 Aug 30
 Radio City, controls, lights, sound,
 air-conditioning.....32 Feb 33

**Radio Compass, see also Direction
 Finder**
 Radio compasses for small boats,
 Staff.....8 Apr 37
 Radio-controlled lighthouse functions
 entirely without keeper.....50D May 36
 Radio during solar eclipses
 Kennelly.....248 Aug 32
 Radio engineers look ahead,
 Staff.....9 Dec 36
 Errata.....34D Feb 37
 Radio exports reach peak level,
 Smith.....54D Oct 36
 Radio field-intensity
 measurements.....59D Feb 39
 Radio-fog-horn gives mariner's
 distance.....83D Mar 34
 Radio-frequency losses in
 liquids.....93D Mar 34
 Radio-frequency megohm
 resistances.....128D Apr 34
 Radio guidance of ships and
 planes.....248D Aug 30
 Radio in aviation.....55D May 39
 Radio in the sky (illustr).....29 Dec 37
 Radio industry—a (Fortune)
 survey.....69D June 38
 Radio knife for marking leather, cutting
 glass, Mooradian.....61D Feb 32
 Radio legislation before Congress,
 Staff.....102 Apr 34
 Raw materials, costs—in tube
 manufacture, Staff.....366 Nov 30
 Radio Mauretania (illustr).....18 Oct 39
 Radio meteorographs, Pear.....32D Sept 37
 Radio on board the Normandie
 (illustr).....218 July 35
 Radio overproduction again in 1930?
 Staff.....128 June 30
 Radio program distribution over lighting
 circuits, MacCoun.....682 June 31
 Radio program preselector,
 DeTar.....16 Nov 38
 Radio propagation in polar
 regions.....127D Apr 34
 Radio rangefinder traces birth and path
 of storms.....20D Jan 32
 Radio receiver and tube sales increase,
 Staff.....72 Mar 35
 Radio receivers at the Leipzig
 Fair.....164D May 35
 Radio reception and sunspots,
 Stetson.....122 Apr 32
 Radio research (British) in
 1934.....44D Dec 35
 Radio resistor measurement,
 Schwartz.....37 May 37

Radio-seismograph.....196D July 30
 Radio signals increased during
 eclipse.....113D June 30
 Radio slide rule.....54D July 39
 Radio spectrum chart.....120 Apr 32
 Radio statistics and markets.....66 Mar 34
 Radio statistics—production and use,
 Staff.....60 Mar 33
 Radio system for landing aircraft during
 fog, Diamond.....158 June 33
 Radio transmission survey of
 Ohio.....44D July 36
 Radio tube noise, Hamilton.....26 Aug 37
 Radio tubes used as photocells,
 Koechel.....372 Dec 32
 Radio waves change speed.....64D Sept 36

Radioactivity by bombardment,
 Livingood.....7 Nov 35
 Radioactivity, counting circuits.....28 July 36
 Geiger counter, battery-
 operated.....64D Mar 38
 personnel protection.....40D Feb 36

Radiography, see also X-rays
 Radiography, soft x-rays.....8 Dec 37
 Radiometer as field strength
 meter.....259D Sept 33
 Radiophones connect up big San Francisco
 construction job.....278D Oct 33
 Radiophone service for small ships,
 Dudley.....11 Mar 39

Radiosonde, balloon transmitter,
 meteorological.....21 July 31
 equipment (illustr).....28 Dec 37
 Olland type, NBS.....36D Feb 39
 survey of techniques.....32D Sept 37

Railroad, see also Train
 Railroad, ignitron rectifier.....51D Apr 39
 train control, v-f.....218 Dec 31
 Range of wired television.....128D Oct 34
 Rapid-record oscillograph, Curtis &
 Cole.....70 Aug 31
 Ratings increased for RCA transmitting
 tubes.....64D Nov 39

Raw materials in vacuum-tube
 manufacture, Wagner.....104 Apr 34
 Rays from gas discharge tube retard
 mold growth.....40D July 36

R-C components for low-frequency
 amplifiers.....75D June 39
 RCA describes television system,
 Fink.....8 Jan 37
 RCA research and development.....41 Aug 37
 Reactance amplifiers, Staff.....28 Oct 37
 Reactance attenuation,
 computing.....39 May 36
 Reactance-series-resistance to parallel-
 resistance chart.....31 Aug 38
 Reactance values of capacitances and
 inductances for the middle radio
 frequencies, Laport.....219 July 34
 Reaction variation method of measuring
 resistance.....299D Sept 30

Reactor, see also Inductor; Coil; etc
 Reactors in d-c service,
 Lee.....18 Sept 36
 Re screens for television tubes.....54D Dec 37

**Receiver, see also type, e.g., Broad-
 casting; Communications; Con-
 verter; F-M; Television; Tuner;
 etc**
 Receiver, aircraft, all-wave.....336 Oct 30
 amateur, advanced design.....20 Dec 36
 audio amplifier, avc.....50 Feb 34
 audio-distortion limiter.....26 Mar 38
 auto-radio, sales.....37 Feb 37
 survey.....48 Feb 32
 automatic frequency control.....18 Jan 35
 Barkhausen circuit, vhf.....92D Mar 34
 battery, low-drain tube.....122 June 30
 battery-operated, design.....12 Jan 38
 British.....60D Nov 37
 broadcast, a-c/d-c design.....14 Jan 35
 a-f compensation.....224 Dec 31
 antenna coupling.....82 May 30
 auto-radio.....8 Jan 33
 auto-radio development.....12 Jan 32
 cueling, pack-type.....29 Apr 39
 design forecast.....277 Sept 39
 design problems.....174 Nov 31
 design trends.....151 June 33
 dual-speaker.....154 May 32
 engineering trends.....176 July 30
 German survey.....306 Oct 34
 high-fidelity.....20 July 39
 intermittent reception.....44D Feb 36
 layout design.....16 Oct 35
 manufacturing methods.....9 Dec 39
 material purchase.....16 July 31
 mechanical features.....344 Nov 34

RECEIVER

RESISTANCE-COUPLING

	Pg—Mo—Yr
Receiver (cont'd)	
broadcast, midget	674 June 31
1938 models	13 Aug 37
1937	22 July 36
parts	12 Feb 35
production line	21 Dec 35
production testing	498 Feb 31
production testing equipment	545 Mar 31
pushbutton tuning	16 Sept 37
sound-picture statistics	78 Mar 32
summary new features	9 Aug 38
trends for 1932	136 Oct 31
two-band design	300 Nov 33
components, 1938 models	37 Sept 37
delayed avc, French	194D June 35
design, for power pentodes	576 Apr 31
die castings, metal (illustr)	17 May 38
diversity, dual system	66D Mar 39
dual-diversity, r-c switch	48D Aug 39
eliminating hum and micro-phonics	18 Mar 39
frequency drift, thermal	24 Nov 37
high-fidelity circuits	108 Apr 34
trf, broadcast	64D Feb 39
i-f adjustment in production	33 Feb 37
measurement of selectivity	62D Mar 37
metal fabrications	13 Oct 37
permeability tuned, broadcast	8 July 31
production, output meter	190 July 30
pushbutton tuning, French	50D Dec 37
pushbutton tuning, French, 1930	534 Mar 31
sales, market statistics	56D Sept 39
superheterodyne, short-wave	67D Feb 32
trf, constant-frequency oscillator	38D Aug 39
superregenerative	42 Feb 34
adjustment and complete circuit	16 Dec 38
British	26 Dec 39
circuit and production	22 Mar 39
circuit diagram	13 June 39
complete circuit	22 Apr 39
design	28 Apr 38
developments	46D Feb 36
domestic, custom	16 Sept 39
input circuit	8 Dec 38
picture and power circuits	16 July 38
picture circuits	18 Aug 38
preselector	58D Dec 39
production (illustr)	36 June 39
scanning and crt circuits	26 Aug 38
scanning circuits	18 Oct 37
sync and scanning test	22 Sept 38
synchronization	18 Nov 38
vhf, converter and audio	16 Oct 38
wide-band i-f and detector	26 Nov 38
tuning, bandspreading	29 Jan 37
two-tube, proposed	94 Apr 33
variable-selectivity	47D Feb 38
broadcast	180 June 35
vht, circuits, Europe	23 Jan 32
positive grid	482D Jan 31
Receiver circuit	142D Apr 32
Receiver for frequency modulation, Day	32 June 39
Receiver selectivity vs transmitter slit	66 Mar 33
Receiver tube measurements at 60 mc	46D Mar 36
Receiving aerials	260D Aug 35
Receiving tubes with high internal resistance	94D Mar 34
Recent achievements of the radio-meteorograph	36D Feb 39
Recent advances in f-m transmitter installations	36D Feb 39
Recent advances in the radio art, Staff	328 Dec 33
Recent British radio development	60D Nov 37
Recent British tube developments	48D Dec 36
Recent developments in German cathode-ray tubes, Sheffield	60D Nov 37
Recent developments in high-power broadcast transmitters, Kispauigh	136 June 30
Recent developments set pace for progress in 1934, Staff	2 Jan 34
Recent die castings for radio receivers (illustr)	17 May 38
Recent European developments in electronic musical instruments, Raven-Hart	18 July 31
Recent improvements in records	78D Aug 31
Recent progress in development of high voltages	44D Jan 39
Recent publications on the electron art	68D May 37
Recent tube applications to automobile making, Powers	12 Apr 39
Reception with short antennas	48D Jan 36
Recognizing faults in television reception	241D Dec 31
Record changer, automatic, phonoradio	584 Apr 31

	Pg—Mo—Yr
Record-saving pickup, Glover	31 Feb 37
Recorded music, in theater	28 Apr 37
Recorder, see also type, e.g., Magnetic; Pen; Seismic; Tape; Wire; etc	
Recorder, celluloid-base film	56D Sept 38
electronic (illustr)	157 May 32
logarithmic amplifier	48D Dec 37
magnetic wire	30 Jan 38
plastic tape, 5-hour, continuous	72D Sept 39
Recorder for sulphur acids in fume gases	140D Apr 37
Recorder of tube characteristics	204D Nov 31
Recording, acetate disk, office use	60D Oct 39
broadcast transcriptions	6 Oct 36
cutter, piezoelectric	39 Dec 35
direct-playback, equipment	22 Mar 38
disk-cutting techniques	17 Dec 39
disk, direct-playback, high-fidelity	34 Nov 38
sound-picture, noise	273 Sept 30
extending range, broadcasting	26 Nov 35
film, double slit and cell	142 May 34
frequency characteristics	40 Feb 32
glow-lamp	177 Nov 31
noise reduction, matted track	23 Oct 38
noise sources	333 Oct 30
optical slit characteristics	512 Feb 31
variable area, squeeze track	542 Mar 31
logarithmic, using d-c amplifier	24 Mar 37
variable- μ tetrode	472 Jan 31
low-noise, process	28 Apr 36
technique	146 Oct 31
monitor, instantaneous	39 Dec 35
motion pictures, reverberation	15 Jan 38
needle-noise improvement	78D Aug 31
reproducing system, quality	25 Oct 37
sound-film, reduced background noise	102 Sept 31
short exposure	464 Jan 31
sound, magnetic tape and wire	30 Sept 38
sound motion picture techniques	371 Nov 30
sound-on-film, glow-lamp	679 June 31
sound-on-16-mm film	176 June 34
sound, optical slit effect	54 Aug 31
photographic	240 Aug 30
sound-picture, fidelity techniques	10 Jan 33
sound, survey	4 Jan 32
volume indicator, linear scale	58D Jan 38
Recording microphotometer	48D Aug 37
Recording of long programs or books, Saxl	85 Mar 32
Recording on magnetic tape	54D Feb 33
Recording photocell distribution photometer	241D Dec 31
Recording resistance-welder secondary currents, Lord	16 Dec 37
Recording sermons for small churches	83D Mar 34
Rectification, see also Rectifier	
Rectification, linear, vacuum and gas tubes	252D Aug 34
Rectifier, copper-oxide, applications	59D Apr 39
copper-oxide, applications	15 July 39
as photocells	312 Oct 32
gas, half-wave circuits	12 Oct 38
gas-tube, in magnetic field	36D July 37
grid-control, metal	4 Jan 34
half-wave, loaded, analysis	32 Sept 39
high-voltage, design	56D Sept 37
ignitron, railway and chemical	51D Apr 39
linear, for weak signals	21D Jan 34
mercury-pool, gas-tube, ignitron	164 June 33
mercury-vapor, manufacturing technique	99 Apr 33
100 kv	40D Dec 38
plate, high signal	550 Mar 31
selenium	58D Dec 37
self-regulated, battery-charging	66D Oct 38
steel-clad	18 Feb 36
three-phase circuits	28 Dec 36
thyatron, laboratory type	219 Aug 33
voltage-control, thyatron	43 Feb 33
Rectifier circuit problem	39 Apr 38
Rectifier filter design, Scott	28 June 38
Rectifier for modulation measurements, Potter	247 Sept 33
Rectifier tubes supply Boston direct-current system	335D Dec 33
Rectifying peak voltmeter	94D Mar 34
Re-diffusion broadcasting in Europe, Staff	44 Feb 35
Reducing man-made static, Browning	366 Dec 32
Reduction of machine noise	50D Dec 36
Reeling control, photocell, for rubber sheet	285D Sept 34

References on radio interference, Roehmann	32 Oct 38
Reflectometer, spherical, uses photocell	46D Oct 37
surface comparator	30D June 37
Reflex circuit considerations, Stinchfield & Schade	153 June 33
Reflexed amplifiers	52D July 39
Regeneration, see also Feedback	
Regeneration, differential, receiver	205D June 32
Regenerative null indicator, Noble	190D June 34
Register control, cuts wrappers	556D Mar 31
cutting textile labels	14D Jan 34
photoelectric, for candy wrapper	18 Aug 37
phototube	44D Sept 39
printing bags	49D Feb 34
stroboscope, color printing	14D Jan 33
Registering broadcast listeners' opinions	118D Apr 34
Regulating d-c generators	66D Sept 39
Regulation by means of variable negative feedback	54D Apr 39
Regulation, rectifier output	39 Apr 38
Regulator maintains voltage for motion picture printers, Reid & Morris	39D Dec 37
Re-ignition of an arc	38D June 37
Relations between modulation and antenna current, Lanterman	59 Aug 31
Relations in the receiving tube family, Staff	343 Nov 34
Relaxation circuit measures radiant energy, Stager	29D July 37
Relay, capacitance, furnace control	46D Nov 37
capacitance operated	34D June 36
limited impulse & delay	28 Aug 36
photoelectric, survey	194 Nov 31
time-delay, cathode protection	124 Apr 35
thermionic	38D Apr 36
thyatron	581 Apr 31
v-t	342 Oct 30
v-t, coil-machine	220 Aug 33
two-stage photoelectric	36D June 36
using voltage-doubler	124D Apr 34
rectifier	124D Apr 34
Relay contacts—their ailments, Clement	29 Dec 38
Addenda	52D Feb 39
Relaying on ultrashort waves to improve city reception	564D Mar 31
Relays for electronic devices, Staff	36 Feb 33
Relays for tube circuits, Dudley	18 May 38
Relays in tube output circuits, George	19 Aug 37
Reliability of selenium barrier-plane cells	227D July 34
Remarks on diode detection	63D Feb 35
Remote Control, see also Telemetering	
Remote control, broadcast receiver, subaudible tone	327 Dec 33
for unattended lighthouse	50D May 36
of phonograph	46D Jan 37
Remote control via 5 meters, Staff	17 Feb 36
Remote receiver tuning at KDYL, Baldwin	19 Aug 36
Remote tuning of communication receivers, Storm	14 Dec 38
Reported at Cleveland, Staff	11 May 36
Reports on frequency modulation	70D June 39
Reproducer, sound, periodic signals	38D May 38
Requirements of television, Felix	235 Aug 30
Research, radio automobiles, Kettering	329 Oct 30
Resistance, see also Resistor	
Resistance bridge, v-t, wide-range	36D Dec 37
Resistance-Capacitance, see also Capacitance-Resistance; R-C	
Resistance-capacitance circuits, time delay	22 Feb 37
Errata	29 Feb 38
time delay, rectifier	26 Feb 38
Resistance-coupled amplifier for television, Brown	265D Aug 32
Resistance-coupled high-fidelity amplifier	76D June 39
Resistance-coupled amplifier data, Staff	29 Feb 37
Resistance-coupling design charts, Koehler	25 Aug 36

RESISTANCE

SHOT NOISE

Pg—Mo—Yr	Pg—Mo—Yr	Pg—Mo—Yr
Resistance coupling for push-pull amplification, Richter40D Oct 35	Resistance equivalent chart31 Aug 38	Resistance measurement, electrometer tube94D Mar 32
electrometer tube171D June 33	v-t, megohm78D Aug 31	v-t ohmmeter214 July 35
Resistance, metals, relation to heat20D Jan 34	negative, measurement circuits340D Dec 33	r-f, copper wire38 Feb 36
measurement697D June 31	Resistance of tuning coils at radio frequencies258D Aug 34	Resistance-stabilized oscillators, Terman190 July 33
Resistances, dry cell35 Nov 36	Resistor, see also Resistance	Resistor, and capacitor testing, production279 Sept 34
manufacturing, electronic technique180 July 33	measurement, carbon composition37 May 37	pad, movable clip type36D Dec 38
sorter, automatic, bridge circuit249D Aug 34	tester, automatic, photocell6 Jan 32	variable semiconductor62D Feb 37
Resistors and condensers in mass production, Chase28 Sept 39	Resistors at video frequencies, Barber38D Jan 39	Resistors, r-f, high resistance128D Apr 34
Resolving power of electron microscopes60D June 38	Resonance curve, receiver testing346D Dec 33	Resonant circuit selectivity index228D Aug 33
Resonant frequencies of quartz oscillators34D July 31	Resonoscope, Holmes17 July 37	Results of the Breslau antenna350D Nov 32
Reverberation, see also Echo	Reverberation, studio acoustics, broadcasting14 Jan 32	studio design315D Nov 33
Reverberation control in broadcasting, Chinn28 May 38	Reverberation control in motion picture recording, Hilliard15 Jan 38	Reverberation meter, portable30 Mar 37
Reviewing the video art, Staff9 Jan 38	Revise transmitter sales practices, Staff204 July 34	Revised uhf (vhf) allocations (table)34 Apr 39
R-F amplifier for frequency monitor, Smith32D Dec 39	R-F coils with and without magnetic core80D Mar 33	R-F impedance-matching (pi-section) networks, Glover29 Jan 36
R-F insulator voltage limits, Lee11 Oct 35	R-F power amplifier (design) chart, Schulz33 Dec 39	R-F power measurements, Lampkin30 Feb 36
R-F resistance of copper wire, Miller & Goodwin38 Feb 36	R-F transition losses, Wheeler26 Jan 36	Rhumbatron, see also Rumbatron
Rhumbatron, klystron, oscillator, survey9 Apr 39	Ribbon microphone and its applications, Weinberger336 Nov 32	Ribbon microphone developed492 Feb 31
Ripple, see Filter; Rectifier	River marking lights photocell controlled103D Apr 33	RMA code for antenna and ground leads126D Apr 35
RMA code under NRA238 Aug 34	RMA completes television standards, Murray28 July 38	RMA engineering division78 Mar 35
RMA-SAE study (ignition) noise, Staff41 May 36	RMS vacuum-tube voltmeter62D Mar 38	Robot humidifier actuated by moisture on window pane, Havens61D Feb 32
Rochester Fall Meeting (papers summary) Staff20 Dec 39	Rochester, 1938, Staff8 Dec 38	Rochester, 1937, Staff11 Dec 37
Rogue's gallery of talking films45D Feb 33	Role of barium in vacuum tubes, Becker390 Nov 30	Role of vacuum-tubes in a tube factory, Koehel121 May 33
Roll inspector, phototube, auto industry12 Apr 39	Rotatable antenna at FCJ, Fruin30 Feb 38	Rotating commutator remembers Ignitron30D June 37
Rotating disc used in the Ignitron welding timer48D Mar 37	Rotations of frictionless meter counted44D Feb 33	Routing mail by photocells (illustr)139 Oct 31
Rubber conveyors are synchronized by tubes, Havens21D Jan 32	Rubber extrusion control118D Apr 34	Rules and standards for broadcast stations, Guy11 Aug 39
Rumbatrons63D Feb 37	Ryall-Sullivan high precision heterodyne oscillator227D July 34	Selective amplifier for detecting sidebands605D Apr 31
Selective fading253D Sept 33	Selectivity, automatic control32 Dec 36	receiver, crystal i-f206D June 32
variable, superheterodyne receiver180 June 35	Selectivity and audio-frequency range237D July 32	Selectivity of radio receivers62D Mar 37
Selenium barrier plane cells194D June 34	Selenium cell relay circuit42D Apr 37	Selenium cells, barrier-plane, service227D July 34
Selenium dry rectifier606D Apr 31	Selenium-iron barrier plane cells126D Apr 34	Selenium-iron cell characteristics33 Apr 37
Selenium photocell of low inertia565D Mar 31	Selenium rectifier58D Dec 37	Self-checking vacuum-tube voltmeter, Paine60D June 39
Self-generating photocell used in auto headlight testers30D Aug 37	Self-government and new code, RMA aims, Staff236 Aug 34	Self-opening doors, Raymond36 Feb 36
Self-protecting cathode, Lowry26 Dec 35	Self-regulated rectifiers66D Oct 38	Self-stopping d-c thyratron circuit, Reich240 Dec 31
Selling tubes on consignment, Staff184 June 32	Semagraph, remote linotype control33D Aug 38	Sensitive current-measuring instrument58D Feb 37
Sensitive light intensity indicator36D June 36	Sensitivity of barrier-cells as a function of the frequency199D July 33	Sensitized potassium photocells206D Nov 31
Sensitizing the photocell, Fleischer518 Feb 31	Sensitizing the wavemeter for intermediate frequencies, Richardson130D Apr 32	Sequence control, phototube, auto industry12 Apr 39
Series modulation for television transmitters, Brown263 Aug 32	Servo system, automatic curve follower40D Oct 36	7-meter broadcasting—one year's experience at WBEN—W8XH, Staff114 Apr 35
75-watt commutator type inverter, Reich252D Sept 33	Sferics, crt storm locator133D May 33	thunderstorm d-f20D Jan 32
Shall sets be sold complete with tubes? Staff662 June 31	Shall we widen the broadcasting band? Staff276 Sept 32	Shape of magnetron characteristic59D Sept 38
Sheet-catcher with photocell control279D Oct 33	Shield grid thyratrons, Livingston & Maser114 Apr 34	Shield tube spray, manufacture193D Nov 31
Shielded antenna down-lead696D June 31	Shielded loop for noise reduction in broadcast reception, Goldman20 Oct 38	Shielding problems treated by transmission line theory44D May 36
Ship steering, automatic, electronic servo41 June 39	Ship-to-shore communication, Riddle9 Sept 37	Ships steered by Electron Elmer284D Sept 34
Shoal water depths by echo sounding90D Mar 35	Short and ultrashort waves292D Sept 34	Short-wave broadcasting stations of the world, Staff180 Nov 31
Short-wave communications at auto races38D July 36	Short-wave single-sideband telephony77D Aug 31	Short-wave telephony with single-sideband pilot wave121D Sept 31
Short-wave therapeutics, Hallberg32D Jan 37	Short-wave therapy, English translations of German books52D Oct 36	Short waves make worms spin more silk557D Mar 31
Shorted-turn indicator, Seright136D May 36	Shot effect, Thompson34D Feb 37	Shot effect, in tubes, 150 kc to 15 mc58D Mar 37
Shot noise in diodes52D Jan 39		

S

Safeguards and alarms, v-t, listing20 Feb 39	Salaries paid radio set engineers, Staff8 Jan 35	Sandpaper, static oriented electrostatically187D June 34
Saturable Reactor, see also Reactor; etc	Saturable reactor, a-c voltage regulator14 July 37	Saturable reactor amplifier28 Oct 37
Saturation in heater-type tubes395D Dec 34	Savings with photoelectric color-control in bakery220D July 35	Sawtooth waveform distortion36 Nov 37
Scaler, high-speed counting7 Jan 34	ratio differential control38D Mar 38	thyatron, high-speed counter232D July 32
using tube with positive grid290D Sept 34	Scales weigh automatically with help of the electric eye135D Apr 32	Scanner, see also Television
Scanner, crt, for televising film46D July 36	Scanning in television receivers, Somers18 Oct 37	Scanning methods, television survey30 Nov 35
Scattering of electrons by gas molecules197D July 30	Schlieren method, photographing sound40D Feb 37	Science helps the blind142D Apr 32
Science makes jobs, Staff77 Mar 34	Scophony television, Staff30 Mar 36	Screen-grid frequency changer378D Dec 32
Screen-grid tube as a detector tube286D Oct 33	Screen-grid tube circuits having high frequency stability290D Sept 34	Screen-grid tubes as transmitters26D Jan 34
Screened coil inductance229D July 34	Screens for television tubes, Maloff & Epstein31 Nov 37	Errata54 Dec 37
Seal, see type, e.g., Glass; Ceramic; Hermetic; etc	Secondary electrons in screen-grid tubes258D Sept 33	Secondary emission, double-grid tetrode25D Jan 34
Secondary emission electron multipliers, Staff10 Nov 35	Secondary emission in amplifying tubes50D Apr 38	Secondary vibrations in cone loud-speakers291D Sept 34
See for yourself, West32D Dec 37	Seeing-talking—Berlin-Leipzig48D July 36	Seismic prospecting method uses electronic recorders40D Jan 36
Selecting loudspeakers for special operating conditions, Hallman22 Nov 38	Selecting the right radio cabinet design, Vassos146 May 34	Selective amplifier for detecting sidebands605D Apr 31

SHOULD

SPEED CONTROL

	Pg—Mo—Yr		Pg—Mo—Yr		Pg—Mo—Yr
Should broadcasting occur in the 500-550 kc band?, Alken.....	17 Oct 36	60-mc mopa, Franks.....	33 Oct 35	Sound frequency characteristics, Staff.....	677 June 31
Show window control, thyratron reactor.....	229D July 32	60-megacycle teletypewriter, Martin.....	10 Mar 37	Sound illusion preamplifier, Sheaffer.....	14 Sept 33
Shrinkage control in radio tube manufacture, Schreiner.....	332 Nov 32	60 to 100 megacycle oscillator, Binneweg.....	29D July 37	Sound level recording, determining mean.....	27 Aug 36
Shunt-excited antenna used by uhf station, Miller.....	44D May 39	Slide-rule impedance calculations, Staff.....	45 May 37	Sound, measurement equipment.....	26 Apr 36
Sideband, single, radiophone.....	77D Aug 31	Slot machine starts phonograph by radio.....	46D Jan 37	Sound motion-picture photography, Livadary.....	240 Aug 30
Single, radiophone, pilot wave.....	121D Sept 31	Slow acting vacuum-tube relay, Pollack.....	342 Oct 30	Sound motion pictures, economic aspects.....	30 Apr 30
Sideband standard, television, 4-mc modulation.....	26 Mar 39	Sludge-level in sewage plant made automatic (photocell).....	248D Aug 34	Sound-on-disc, Fink.....	6 Oct 36
Sidebands occurring in frequency modulation.....	341D Dec 33	Small churches to get recorded sermons.....	83D Mar 34	Sound ornaments.....	55D Feb 33
Sight and sound (illustr).....	25 Nov 38	Small-signal detection, Chaffee.....	641 Mar 31	Sound, p-a, for stage spectacle.....	40 Feb 34
Signal Generator, see also Oscillator		Smith chart, impedance matching.....	29 Jan 39	Sound Picture, see also Motion Picture	
Signal generator, design.....	46 Feb 32	Smoke-density recorder for power plants.....	684D June 31	Sound-picture, advances, survey.....	131 June 30
standard microvolter.....	230 July 32	Smoke-density recorder, phototube circuit.....	632 May 31	broadcast receiver, statistics.....	78 Mar 32
Errata.....	323D Oct 32	Smoke indicator, photocell, British.....	385D Dec 34	business organization, Europe.....	282 Sept 30
Signal-seeking circuits to aid correct tuning, White.....	18 Jan 35	Smoke precipitation with electronic rectifiers.....	254D Sept 33	film and record, survey.....	4 Jan 32
Signal-synchronized sweep circuit—for cathode-ray oscillography, Staff.....	158 May 35	Smoke-prevention methods, phototube starts blower.....	389D Nov 30	home, disk-recording.....	276 Sept 30
Signs of television progress abroad (illustr).....	593 Apr 31	Smoke recorder and truck-height indicator in Holland Tunnel.....	371D Dec 32	maintenance costs.....	225 July 32
Silent tuning.....	326D Oct 34	SMPE, Autumn meetings, IRE.....	30 Nov 36	phototube circuit design.....	22 July 31
Silver anniversary, Institute of Radio Engineers, Dudley.....	14 May 37	SMPE, Spring meeting, Staff.....	33 June 36	recording methods.....	163D Oct 31
Simple a-c voltage regulator, Lampkin.....	30D Aug 37	SMPE to convene in Hollywood (abstracts) Staff.....	628 May 31	techniques.....	7 June 36
Simple-constructed attenuation network, King.....	48D Sept 38	Soaking pit control, phototube.....	306D Nov 33	Sound-picture engineers discuss economics, progress and new problems of industry, Staff.....	384 Nov 30
Simple d-c amplifier.....	82D Sept 38	Society of Motion Picture Engineers discuss current problems, Staff.....	186 Nov 31	Sound-picture industry abroad, Erby.....	193 July 30
Simple differential amplifier.....	46D Aug 37	Sodium gas lamps used on San Francisco bridge.....	38D Nov 35	Sound-picture recording technique.....	542 Mar 31
Simple improvements in R-C power-supply filters, Scott.....	42D Aug 39	Sodium-vapor illuminants, Staff.....	189 July 33	Sound-picture statistics for 1930.....	538 Mar 31
Simple phonograph, oscillator, Klehne.....	54 Oct 38	Sodium-vapor lighting in Holland, Staff.....	253 Aug 32	Sound pressure, musical instruments.....	24D Jan 33
Simple resonant a-f amplifier.....	81D Mar 33	Soft x-ray radiography, Sherwood.....	8 Dec 37	Sound recording (illustr).....	280 Sept 32
Simple sine-wave oscillators.....	65D Oct 38	Soil properties at radio frequencies.....	229D Aug 33	Sound recording, cellophane ribbon, broadcasting.....	179 June 35
Simple ultrashort-wave wavemeters, Moore.....	311D Nov 33	Solar eclipse and radio waves.....	110D Apr 33	film, variable-area, slit effect.....	587 Apr 31
Simplified attenuation network design, Hallman.....	150D Oct 31	Solar radio disturbance.....	25 Jan 36	mechanical engraving film.....	52 Feb 35
Simplified calculations on multiwinding transformers, Browning.....	46D May 39	Solution of the superheterodyne tracking problem, Landon.....	250 Aug 32	Sound-reproducing, system standards.....	46D May 35
Simplified dual-diversity radiotelegraph reception, Bartlett.....	48D Aug 39	Solving a rectifier problem, Lee.....	39 Apr 38	Sound systems aid in serving beer.....	83D Mar 34
Simplified electronic units control theatre lighting, Dawson.....	323D Oct 34	Solving network problems by graphs, Waterman.....	60 Aug 31	Sound tricks in picture production, Dreher.....	371 Nov 30
Simplified harmonic analyzer, Barber.....	374 Nov 30	Some aspects of police radio communication, Thomas.....	74 Mar 34	Sound-wave recording techniques.....	40D Feb 37
Simplified inductance calculation, Russell & Abraham.....	598 Apr 31	Some comments on the use of getters, O'Neill.....	510 Feb 31	Sound-wave stroboscope, McNamee.....	24 Nov 36
Simplified inductance-coil calculations, Rumble.....	315 Oct 34	Some considerations on detectors.....	99D Mar 35	Sound waves from quartz oscillators.....	34D July 31
Simplified method of measuring broadcast harmonics, Miller.....	425 Dec 30	Some math errors corrected.....	52D Nov 36	Sounding, depth, by radio.....	20 Oct 36
Simplified method of modulator design, Laport.....	184 July 33	Some measurements of optimum heterodyne.....	394D Nov 30	Soundings from a plane by acoustic echo.....	49D Feb 34
Simplified method of treating network works.....	44D Jan 39	Some novel electronic recorders (illustr).....	157 May 32	Sounds that cause chemical changes, cooking.....	255D Sept 33
Simplified modulation circuit.....	440D Dec 30	Some novelties in sound recording (illustr).....	280 Sept 32	Soviet radio at the North Pole (illustr).....	22 Sept 37
Simplified resistor pad.....	36D Dec 38	Some overlooked opportunities for electrical phonographs, Staff.....	121 Apr 32	Soviet Russia's five year plan for radio, Codel.....	548 Mar 31
Simplifies adjusting clocks.....	514D Feb 31	Some phenomena in oxide coated filaments, Lowry.....	44 Apr 30	Space charge effects, electron tube.....	66D June 33
Simplifying b-c operators' job, Ing.....	24 Sept 37	Some possibilities in electronic exhibits.....	119D Apr 34	Space detector locates concealed weapons.....	157D May 35
Simplifying dynamic tube curves, Hitchcock.....	220D July 34	Some prospects for the electron tube in power transmission, Caldwell.....	324 Oct 30	Spark plug tester.....	44D May 36
Simultaneous traces with cathode-ray oscillograph, Brown.....	170D June 33	Some unsolved problems of sound-picture technique, Goldsmith.....	23 Apr 30	Spark suppressor's effects—fnis.....	158D May 34
Single-battery tube-voltmeter.....	296D Sept 32	Sommerfeld's formula, Fitch.....	23 Sept 36	Spatial expander (loudspeaker baffle).....	69D Mar 39
Single-ended r-f pentodes, Kelley & Miller.....	26 Sept 38	Sonar, see Depth Sounding		Special-events transmitter, Lengham.....	19 Oct 39
Single sideband short-wave communication.....	34D July 31	Sonobuoy, depth-sounding.....	20 Oct 36	Special form of photocell.....	184D Oct 31
Single-tube beat-frequency oscillator, Podolsky & McBride.....	356 Nov 34	Sorry (corrections to 22 July 38).....	9 Sept 38	Special instruments for radio receiver production testing, Glover.....	600 Feb 31
Single-tube floating needle volume indicator, Likel.....	38D Aug 38	Sorry (corrections to 17 Apr 37 & 25 Aug 38).....	7 Oct 38	Special tubes for automobile radio sets, Wise.....	516 Feb 31
Single-tube intercommunicator.....	53D June 39	Sorting gage, v-t, auto industry.....	12 Apr 39	Specific losses of r-f coils.....	127D Apr 34
Single-tube inverter.....	140D May 33	Sound, see also Audio; Public Address		Spectral absorption used for mercury-vapor detection.....	34D Dec 38
Single-tube thyratron inverter, Livingston & Lord.....	96 Apr 33	Sound effects, legitimate theatre.....	217D July 34	Spectrogram analyzer, density comparator.....	358D Nov 34
Single-unit video converter, Mezger.....	31 Feb 38	Sound effects machine with high impedance mixing, Weiner.....	56D June 38	Spectrometer for audio frequency.....	76D Nov 39
Sintering beds controlled by photocells.....	156D Oct 31	Sound equipment sales abroad, North & Golden.....	11 July 31	Spectrophotometer, chemical	
Sinusoidal and relaxation oscillations.....	300D Sept 30	Sound-film, four-part choral instruction.....	91D Mar 35	research.....	40D Mar 38
Sinusoidal oscillations without tuned circuits.....	258D Aug 34	home motion pictures.....	621 May 31	photoelectric.....	284 Sept 32
Sirifer iron-dust coils for r-f.....	194D June 35	Sound-film reproduction without mechanical slit, Staff.....	380 Nov 30	photosensitive solutions.....	54D Feb 38
6E5 detector bridge circuit.....	55D Jan 38	Speed Control, see also Motor Control		Spectrophotometer for rapid tests of color.....	60D Nov 36
6L6 amplifier, Oxman.....	30 Sept 36	Speed control, turntable, automatic.....	38D Oct 35	Spectroscopy, photocell comparator.....	58D Feb 35
6L6s in a degenerative amplifier, Kiernan.....	50D Nov 36	Spectrum, see also Allocations; Frequency		Spectrum chart.....	120 Apr 32
Six-place LC product table, Hesse.....	31 June 38	Spectrum chart.....	44 May 36	Spectrum chart.....	44 May 36
Sixth annual convention of IRE, Staff.....	675 June 31	Errata.....	75 Nov 37	Spectrum; radio, ether, audible, photoelectric (illustr).....	26 Apr 30

SPEED

	Pg—Mo—Yr
Speed of vacuum pumps.....	62D Feb 37
Speed recorder, photoelectric, foot-race.....	262 Aug 32
projectiles, photoelectric.....	419 Dec 30
Speed regulation grid-controlled rectifiers.....	109D Apr 33
Speed timer, motor vehicles.....	59D Feb 35
Speedomax—electron tube recording potentiometer.....	21D Jan 34
Spherical reflectometer for light transmission and reflection measurements.....	46D Oct 37
Spherical tank uhf oscillator, Hollmann.....	26 Dec 38
Spielmann photoelectric piano.....	248D Aug 30
Spinning atoms and spinning electrons.....	52D Sept 37
Spot welder control, pyrometer.....	140D May 33
Square-top filters.....	136D Feb 33
Square-wave generator.....	59D Jan 38
Squeeze or matted track, Hilliard.....	23 Oct 38
Squelch, audio, communications receiver.....	56D Sept 39
St. Clair lightship radio-controlled.....	187D June 35
Stability of oscillations in three electrode tube.....	258D Aug 34
Stabilization of oscillators.....	54D Feb 33
Stabilized bridge circuit, Kalmus.....	30 Dec 39
Stabilized oscilloscope using cathode ray.....	93D May 30
Stabilized sweep-circuit oscillator, Kock.....	20 Apr 39
Standard frequency quartz plates.....	52D Dec 37
Standard microvoltmeter using 2nd harmonic principle, Diehl.....	230 July 32
Errata.....	323D Oct 32
Standards on television.....	10 July 37
Standards on electronics.....	58D Oct 38
Starting mercury vapor tubes.....	58D Feb 39
Static, see also Interference; Noise	
Static, man-made, reduction.....	366 Dec 32
Static suppressor, aircraft, trailing wire.....	42D Feb 39
Static velocity microphone.....	21 Sept 36
Statistics, broadcast, maintenance and salary.....	25 Nov 35
broadcast, production and use.....	60 Mar 33
receiver prices.....	120 Apr 35
receiver production.....	128 June 30
receiver sales.....	229 Dec 31
receivers.....	220 Dec 31
station.....	24 Jan 37
station costs.....	688 June 31
stations.....	254 Aug 34
stations, 100-watt.....	308 Oct 34
employment, radio industry.....	678 June 31
p-a and sound motion pictures.....	686 June 31
police radio costs.....	372 Dec 34
radio-apparatus exports.....	228D July 35
radio stock prices.....	52 Aug 31
receiver and tube sales.....	72 Mar 35
receivers and tubes.....	66 Mar 34
receiver manufacture.....	578 Apr 31
broadcast.....	72 Mar 34
England.....	93D Mar 34
salaries of radio engineers.....	8 Jan 35
sound-picture, 1930.....	538 Mar 31
foreign.....	193 July 30
foreign sales.....	11 July 31
tube, manufacturing costs.....	366 Nov 30
production costs.....	664 June 31
Statistics of radio and sound-pictures, Staff.....	78 Mar 32
Statistics of radio sales during 1930, Staff.....	534 Mar 31
Statistics of the sound-picture field, Irby.....	130 June 30
Status of cold-cathode tubes abroad, Saxl.....	17 Jan 32
Steel bars cut to length by photocell.....	196D Nov 31
Steel-clad (rectifier) tube for schools, Durand.....	18 Feb 36
Stereophonic music, three-channel transmission.....	118 May 33
Stereoscopic television.....	56D Aug 39
Sterilamp, gas discharge tube.....	40D July 36
Sterilizing wheat by ultrashort waves.....	53D Apr 37
Stethophone amplifier, Singer.....	66D June 39
Stethoscope, electronic amplifier.....	23D Jan 35
Sticky material protected by photocell.....	285D Sept 34
Stimulating the engineer, Baker.....	126 June 30
Stopping-plate detector.....	128D Apr 34
Storage Tube, see Tube	
Stormer echoes made clear.....	649D May 31
Stratosphere flight, electronic apparatus.....	31 Dec 35

TELEPHONY

	Pg—Mo—Yr
Stripping cotton and silk from wire ends, Chase.....	66D June 39
Stroboglow, grid-glow stroboscope.....	338D Oct 30
Stroboscope, for paper mill rolls.....	49D Feb 34
for piano tuning.....	44D Sept 37
for sound waves.....	24 Nov 36
motion study, photographic analysis.....	11 Feb 39
Comment.....	57D Apr 39
Strobotron tube.....	12 Feb 37
Strobotron, starting.....	18 Mar 37
Stroboscope aids dynamic speaker design, Rogers.....	30D Aug 37
Stroboscope for motion pictures, high speed.....	250 Aug 34
Stroboscope for observation of loud-speaker diaphragms.....	348D Oct 30
Stroboscope inspects high-speed printing.....	14D Jan 33
Stroboscopic camera, clam membrane.....	94D Mar 35
Stroboscopic photography, Edgerton & Gerneshausen.....	220 July 32
Stroboscopic testing of meters.....	15D Jan 33
Strobotron, Gerneshausen & Edgerton.....	12 Feb 37
Strobotron spot welder control.....	66D May 37
Strobotron (starting characteristics) II, White, Nottingham, Edgerton & Gerneshausen.....	13 Mar 37
Studies in radio transmission.....	264D Aug 32
Studies on oxide-coated filaments.....	67D Feb 32
Studio, broadcast, KNX.....	20 Apr 38
Studio practice in noiseless recording, Lewin.....	146 Oct 31
Study of chemical phenomena in coated filaments, Wagner.....	178 July 30
Study of high-frequency heating, DeWalt.....	338 Nov 32
Study of Litz wire coils—II, Staff.....	342 Dec 33
Study of Litz wire coils for i-f and r-f transformers, Staff.....	303 Nov 33
Study of r-f choke coils, Lee.....	120 Apr 34
Study of space charge effects in electron tubes.....	66D June 38
Study of superregeneration, Staff.....	42 Feb 34
Study of thoriated tungsten.....	50D Jan 39
Successive reflections versus directly bent ray.....	349D Nov 32
Suggestions concerning FCC high fidelity standards.....	191D June 35
Sum and difference distortion in pentagrid converter oscillator.....	52D Oct 36
Summary of provisions of NRA radio industry code, Staff.....	208 Aug 33
Sun behind clouds, infrared rays work new sextant.....	201D June 32
Sun's effects on radio, Richey.....	188 June 34
Superconductivity, test, r-f.....	204D Nov 31
Superheterodyne, see also Receiver	
Superheterodyne tuning condenser design— for use in multirange receivers, Schwartzmann & Burnell.....	180 June 34
Supermidjet radio transmitter for tracking meteorological balloons in inclement weather, Code.....	21 July 31
Superregeneration, bibliography.....	30D Jan 35
circuit.....	42 Feb 34
police receiver.....	42D May 36
Superregeneration as a means of fading-proof reception, Roosenstein.....	26D Jan 34
Superregeneration of an ultrashort-wave receiver, Ataka.....	46D Sept 35
Superregeneration using the pentagrid converter, Williams.....	126D Apr 35
Supersonic, see also Ultrasonic	
Supersonic horn used on German highways.....	49D Oct 37
Supersonic sterilization of milk.....	61D Feb 32
Supersonics (illustr).....	25 Feb 37
Supersonics—a survey, Mayberry.....	7 July 37
Supplementary radio tubes in Germany.....	328D Oct 34
Supply & cost of 16-mm film for the home, Irby.....	48 Aug 31
Suppression of auto-radio noise, Browning & Haskins.....	273 Oct 33
Suppression of transmitter harmonics, Dietsch.....	167 June 33
Errata.....	199D July 33
Suppression resistors and their effects on automobile operation, Staff.....	70 Mar 34
Suppressors, spark, effect on engine.....	54D Feb 34
Supreme Court holds Langmuir patent invalid, Staff.....	673 June 31
Surface hardening—a new job for transmitting tubes, Babat & Losinsky.....	44D June 38

	Pg—Mo—Yr
Surface tester, for textiles.....	40D Jan 37
phototube, coating metal.....	48D Nov 38
Surge impedance and impedance of transmission lines.....	81D Mar 33
Surge meter for welding measurement.....	42D May 37
Surgery, radio knife, endothermy.....	316 Oct 30
Survey, electronic applications.....	2 Jan 33
Survey of auto radio at national show, Staff.....	48 Feb 32
Survey of 1932 radio set trends, Staff.....	136 Oct 31
Survey of present television developments.....	52D May 39
Sweep circuit, control	
television.....	128D Apr 34
cro.....	222 Dec 31
linear, thyratron, cro.....	198 June 32
oscilloscope.....	110 Apr 34
relaxation oscillator, stabilized.....	20 Apr 39
synchronized by signal.....	158 May 35
tripped by electronic relay.....	42D Feb 36
Sweep, cro, glow-tube.....	242D Dec 31
Swing music from cathode rays.....	38D Jan 37
Swings of employment in the radio industry, Staff.....	678 June 31
Switch control, photochemical combination.....	36D Apr 38
Switching, electronic.....	46D Aug 38
electronic relay for c-r sweep.....	42D Feb 36
h-f, L-C system.....	104D Mar 32
Symmetrical oscillators and multi-vibrator.....	290D Sept 34
Symposium on metals.....	54D Mar 37
Sync impulse generator for television deflection circuits, Zaharis.....	48D June 39
Synchronization, automatic, for	
television.....	42D Apr 36
television receiver.....	19 Jan 39
Synchronizing for television.....	93D Mar 34
Synchronizing signals, television without.....	33 Mar 38
Synchronizing, television receiver.....	18 Nov 38
Synchronous-deflection relay for cathode-ray oscillographs.....	564D Mar 31
Syndec, communications detector.....	14 Dec 38
Synthetic speech, Staff.....	19 Feb 39
T	
Tabulation of rectifier tubes.....	35 Oct 36
Talking along a beam of light.....	93D May 30
Talking lighthouses to give positions to ships.....	471D Jan 31
Talking mirror uses capacity relay and phototube-film re-production.....	36D Feb 37
Tape recorder (cellophane).....	75D Mar 39
Teaching pilots blind flying in radio beam.....	216D July 34
Technical advances, Cleveland IRE meeting.....	11 May 36
Technical advances, 1935.....	7 Jan 36
Technical data on new tubes, Staff.....	252 Aug 32
Technical trends seen at RMA trade show, Staff.....	6 July 31
Technique of microphone calibration.....	205D June 32
Technique of the ultrashort waves.....	697D June 31
Telemeter using tubes and standard parts.....	319D Oct 32
Telemetering, see also Remote Control	
Telemetering, a-f, electronic system, water and gas.....	50 Feb 35
carrier control of power load.....	46D Mar 37
compass bearings.....	28D July 37
flood control gage.....	221D July 35
v-t, for power system.....	249D Aug 30
Telemetering system using vacuum-tube detectors.....	322D Oct 34
Telephone lines for radio programs.....	205D Nov 31
Telephone-radio set-up used for lectures at dispatchers institute.....	40D Mar 36
Telephoning to Ireland on five meters.....	132D Apr 35
Telephony, call announcer, trunk calls.....	292D Sept 36
trunk calls.....	424 Dec 30

THYRATRON

TUBE (LOW-NOISE)

Pg—Mo—Yr

Thyratron voltage regulator,
Weinland132 Apr 32

Tickler tape records eye movements,
Slawson34D Aug 38

Time and speed measurements.....52D Mar 38

Time announcer, British
telephone36D Apr 36

Time constant259D Aug 34

Time constant of circuits.....326D Oct 34

Time constant, R-C circuit,
nomogram20 Sept 37

Time-delay circuits, Feistead.....30D Mar 36

Time-delay circuits, v-t, design.....336 Dec 33

Time-delay effects in synchronous
broadcasting, Alken124 May 33

Time delay in resistance-capacity cir-
cuits, Kellogg & Phelps.....22 Feb 37,
Errata29 Feb 38

Time delay in resistance-capacity cir-
cuits, Kellogg & Phelps.....26 Feb 38

Time signals, increased accuracy.....38D Nov 35

Time switch starts station
WLW154D May 34

Time telescope, Dudley.....24 Sept 39

Time to restyle radio sets is now!
Staff88 Apr 33

**Timer, see type e.g., Photographic;
Welding; etc**

Timer, clock, pendulum
adjuster514D Feb 31

electronic welding26 May 36

phototube for auto races.....36D Aug 36

phototube-relay, for
photography22 June 37

synchronous, using phototube.....28 Oct 38

thyatron, short interval.....309 Oct 32

v-t, high speed90 Mar 32

Times reaction interval of driver in
emergency119D Apr 34

Timing circuit, v-t, plate
operated293D Sept 32

Tire noise analysis.....119D Apr 34

Titration, automatic, photo-
electric126D Apr 34

Tobis and Klangfilm sound-picture
methods163D Oct 31

To clear up the confusion about two
kinds of pentodes, Henney.....40 Apr 30

Tone control, automatic.....218 July 32

circuit response230 Aug 30

Tone fidelity switch, Manke.....34 May 37

Tone quality, broadcast receiver.....97 Sept 31

Tone quality of small radio sets,
Olney85D Aug 31

Tonlars58D Jan 37

Toothpaste tubes checked by
photocells354D Nov 34

Torque amplifier, thyatron.....8 Feb 38

Tower, see Antenna

Tracing electron paths in electric fields,
Sallinger50D Oct 37

Tracking, see also Padding

Tracking, receiver, padding
condenser160 May 32

receiver, superheterodyne250 Aug 32

Tracking problem in
superheterodynes132D Apr 35

Trade show sees new sets, circuits, tubes,
Staff186 June 32

Traffic control, photocell, Detroit.....114 June 30

bridge
v-t, survey94 Sept 31

Traffic controlled by light beams,
Hitchcock515D Feb 31

Traffic light control, phototube.....40D Nov 38

Traffic volume analyzed by
photocells354D Nov 34

Transatlantic phone uses compander to
overcome static317D Oct 34

**Transducer, see type, e.g., Relay;
Tube; Crystal; etc**

Transformation chart, polar-
rectangular35 Feb 38

**Transformer, see also type, e.g., R-F; I-F;
etc**

Transformer, a-f amplifier,
testing18 July 37

a-f, interspaced windings.....233D Dec 31

interstage design310 Oct 34

output design381 Nov 30

output, flux balance.....161D May 35

output, testing427 Dec 30

two-secondary46D May 39

core, Ferrocart358D Nov 34

d-c, thyatron.....57D Jan 38

design, class B and AB audio
amplifiers14 Feb 36

frequency response, output.....30 Jan 36

i-f, alignment33 Feb 37

and r-f, Litz-wound.....303 Nov 33

cost vs quality97 Mar 32

iron-core298 Nov 33

Pg—Mo—Yr

Transformer (cont'd)
modulation, equivalent
network63D Feb 35

power, design for receivers.....286 Sept 34

r-f, powdered iron.....194D June 35

60-cps, design charts.....14 Oct 35

tuned, selectivity curves.....15 Feb 37

vibrator power supply.....149 May 34

Transformer amplifier for barrier
photocell applications.....58D Nov 37

Transformers for gaseous tubes,
Trimble282 Sept 32

Transient amplifier analysis,
Walker39 Nov 39

Transient conditions and time-
factors24D Jan 33

Transients in musical sounds.....141D Apr 32

**Transmission Line, see also type, e.g.,
Broadcasting; Coaxial; etc**

Transmission line, adjustments.....15 July 36

Errata56D Jan 37

coaxial, aluminum, gas-filled.....66D Feb 39

coaxial-cable for BBC.....54D Apr 37

for television54D May 36

coaxial, fittings and
specifications30 Mar 39

concentric, antenna feed.....40D Mar 37

concentric-line termination.....16 Dec 36

h-f, measurement26 Apr 38

impedance chart35 Dec 36

power, fault locator.....40D Nov 35

r-f, matching64D Mar 39

uhf waveguide59D Sept 36

Transmission-line calculator,
Smith29 Jan 39

Transmission-line theory, shielding
problems44D May 36

Transmission lines for meter-
waves110D Apr 33

Transmission measuring system.....48D Dec 37

Transmission system, tower
lighting38D July 36

Transmission, telephone, level
standard192D Nov 31

Transmit auditory perspective in music,
Staff118 May 33

**Transmitter, see also type, e.g., Aircraft;
Broadcasting; Coaxial; etc**

Transmitter, adjustments,
correction56D Jan 37

beacon, for aircraft warning.....29 May 36

broadcast, high-power136 June 30

construction, broadcast.....20 Jan 36

c-w, keying monitor.....44D Dec 37

f-m, vhf, W2XMN and
W2XCR14 Mar 39

frequency-modulation, survey.....20 Nov 39

inverse-feedback,
improvement20 Aug 39

measurements, using wave-
meter88 Mar 32

modulation meter, v-t type.....18 Jan 37

protective disabling58D May 38

short-wave broadcast23 Dec 37

television, equipment survey.....26 Mar 39

vhf, broadcast pickup,
pack-type29 Apr 39

Transmitter adjustments,
Sperling15 July 36

Errata56D Jan 37

Transmitter parasitic
oscillations26 Oct 38

Transmitting tube chart,
Dudley27 Nov 38

Transmitting tubes23D Jan 33

Transoceanic telephone service
short-wave equipment92D May 30

Transparency meter tests with photox
cell28D July 37

Transportation noise intensities.....48D Feb 34

Transportation noise studied by new
analyzer90D Mar 35

Trautonium, musical instrument,
electronic18 July 31

Trends in radio design and
manufacturing, Staff151 June 33

Trigger circuit for oscilloscope.....58D Jan 37

Trigger circuits, Relch.....14 Aug 39

Trilinear coordinates80D Nov 37

Triode, connection for pentode.....440D Dec 30

Triode generator and amplifier.....226 Dec 31

Triode r-f amplification.....220D July 34

Triodes operated at high
frequencies60D Dec 37

Triograph, Hollmann28 Jan 38

Trough-type colorimeter uses self-
generating cell42D Oct 39

Truck-height indicator, Holland
Tunnel371D Dec 32

**Tube, see also type, e.g., Beam Power;
Magnetron; Thyatron; etc**

Tube, acorn, design and use.....282 Sept 34

Pg—Mo—Yr

Tube (cont'd)
acorn, development model.....214 Aug 33

a-f amplifier, triple-twin.....194 June 32

a-f-glass, battery miniature.....27 Nov 39

all-metal, receiving116 Apr 35

receiving type148 May 35

amplification factor, chart.....45 June 39

amplifier, detector, rectifier,
characteristics35 Feb 33

heavy-duty, RJ-563162 May 32

applications, listing2 Jan 35

Augatron, electron multiplier.....58D Oct 39

automobile-radio types516 Feb 31

beam, deflection control.....14 Mar 36

6L6 amplifier30 Sept 36

beam-power output18 Apr 36

beam-type, for uhf.....72D June 34

broadcasting, replacement cost.....113 Apr 34

applications38D June 34

design188 Nov 31

double-beam31 Oct 36

fluorescent screens44D June 36

in Germany60D Nov 37

listing48D Dec 37

centimeter waves259D Sept 33

characteristics, by crt.....14 Apr 38

chart, 1932308 Oct 32

chart33 Mar 38

crt plotting34 June 38

fine structure194D June 34

new types252 Aug 32

recorder, crt.....204D Nov 31

circle diagrams for circuits.....23 May 39

Errata49D Oct 39

coated-filament phenomena.....178 July 20

coefficient measurements38D July 39

cold-cathode, amplifier396D Nov 30

amplifier131D Apr 35

circuits67D Sept 39

filamentless182 Nov 31

for telephones36D Feb 37

foreign development17 Jan 32

gas-filled Strobotron12 Feb 37

Strobotron, starting18 Mar 37

converter, conductance.....166D May 35

for superheterodyne28D Jan 35

correct and incorrect use.....327D Oct 84

c-r, distortion elimination.....16 Jan 35

phosphorescent screens31 Nov 37

Errata54 Dec 37

critical distance (beam).....33 May 36

Errata48D July 36

deflection control45D May 36

design, for exponential
characteristic326D Oct 34

detector-output, proposed94 Apr 33

devices, industrial use.....15 Apr 30

diode capacitance68D June 38

diode voltmeter with movable
anode50D Mar 37

discharge, below start
potential162D May 34

starting voltage176D May 32

dissector, motion pictures.....8 Dec 38

dynamic characteristic,
curves220D July 34

electrometer, 10⁻¹⁷ ampere.....290 Sept 30

electron-beam-bunching,
survey9 Apr 39

electron multiplier8 July 38

design50D July 38

secondary emission10 Nov 35

elements, nickel, manufacture.....4 Jan 33

equivalent triode networks.....51D Dec 36

evacuation measurement594 Apr 31

external-grid, German346D Oct 30

factors influencing useful life.....39D Dec 36

family tree diagram (illustr).....35 Oct 38

gas-discharge, external control
grid70 Mar 33

gas-triode66D May 37

cold-cathode14 May 38

German, 1933-3426D Jan 34

glow-discharge amplifier.....282 Oct 33

grid-glow, and arc discharge.....183 July 30

measures commutator
roughness59D Sept 36

grid, new metal.....54D Sept 36

high-current welder27 Nov 36

high internal resistance.....94D Mar 34

image amplifier pickup,
television8 Dec 38

image dissector, television
camera24 Oct 39

in diathermy equipment.....16 Nov 36

Comment32D Jan 37

inductive output, power
amplifier30 Feb 39

industrial control25 June 36

industrial use survey.....5 Jan 32

input losses222 July 35

interelectrode capacitance71D June 38

h-f27D Jan 34

low-drain, battery receiver.....122 June 30

low-noise, i-f amplifier.....18D Jan 33

requirements169D May 32

TUBE

UNUSUAL

Pg—Mo—Yr	Pg—Mo—Yr	Pg—Mo—Yr
Tube (cont'd)	Tube control of high-speed elevators (illustr) 231 Dec 31	\$250,000,000 Temple of Electronics, Staff 218 Aug 30
magnetic-control thyatron, Permatron 25 Apr 39	Tube control of rubber extruder, 113D Apr 34	Two practical capacity-operated relays 35D Apr 37
magnetron, vhf oscillator 34 Apr 30	Tube control of temperature in crystal ovens 253D Sept 33	Two-stage a-c operated photo relay 36D June 36
manufacture, evacuation and getting 213 July 34	Tube-controlled candy wrapper, Hall 18 Aug 37	Two-way horn system, Hilliard 24 Mar 36
manufacturing, plant layout 630 May 31	Tube-controlled motor, King 14 Jan 36	Two-way television (illustr) 100 May 30
practice 52D Jan 37	Tube distribution evils—the remedy, Staff 494 Feb 31	Types of vacuum-tube oscillation 194D June 34
tolerances vs performance 44 Feb 32	Tube equipment in industry (listing), Staff 20 Feb 39	Typesetter, automatic, wire-line 54D Feb 35
measurement, dynamic 344 Nov 32	Tube exports 48D Apr 37	Typical European radio stations 54D Feb 33
measurements, direct-reading meter 381 Dec 34	Tube life: 75,000 hours (WE 102F) 26 Nov 39	Typical new French receiving set 194D June 35
mercury-vapor, protected cathode 26 Dec 35	Tube milliammeter for alternating current 195D June 35	Typographical errors (correction) 322D Oct 32
starting circuit 58D Feb 39	Tube noise 26 Aug 37	
metal, basing and characteristics chart 36 Sept 35	Tube noise (fluctuation noise) between 150 kc and 15 mc 50D Mar 37	
characteristic chart 31 Oct 35	Tube problems at ultrahigh frequency 50D Dec 38	
industrial and power 312 Oct 34	Tube recorder used in testing enameled wire 36D Jan 37	
Osram-Marconi 151 Jun 33	Tube repeats aircraft compass bearings 28D July 37	
v-t, manufacturing process 31 Sept 35	Tube static characteristics by crt 30 July 37	
mixer, and oscillator 393D Dec 34	Tube suits settled, Staff 149 Oct 31	
i-f design 50D July 36	Tube tester par excellence 220D July 34	
movable anode 16 Mar 37	Tubes aid earthquake study 40D Feb 36	
multiplier, cold-cathode, secondary-emission 242 Aug 34	Tubes as voltage recorders 54D Sept 38	
multisection, GT-type 48D June 39	Tubes enter the automobile plant, Powers for generating 18-cm waves, Staff 4 July 31	
new type characteristics 93 Apr 33	Tubes for short-wave transatlantic phone service, Mendenhall 38 Apr 30	
new types 1931 574 Apr 31	Tubes for ultrashort waves 270D Aug 32	
orthicon, television camera 11 July 39	Tubes help make automobiles, Powers 22 June 36	
output, triode-pentode choice 363D Nov 34	Tubes in rubber making 192D July 33	
pentagrid converter, single-ended 8 Dec 38	Tubes, Inc. (manufacture and sales), Staff 13 Nov 38	
pentode, characteristics and use 12 Apr 30	Tubes maintain tension as wire is reeled 293D Sept 30	
comparison of types 40 Apr 30	Tubes measure protecting finishes in automobile manufacture 44D Dec 36	
for high-frequencies 60D Nov 36	Tubes permit automatic weighing in batches 98D Mar 32	
photoamplifier 224D Aug 33	Tubes to fit the wavelength, Thompson 214 Aug 33	
photoelectric effect in 372 Dec 32	Tubes with cold cathodes, Staff 6 Jan 33	
photoglow, vacuum amplifier 17 Jan 32	Tuned condenser-coupled amplifiers, Cohen 340 Oct 30	
plate circuit theorem 19 Mar 36	Tuned radio-frequency amplifiers, Cohen 21 Apr 30	
power, economical operation 52D May 38		
power-output, auto-radio, LA type 96 Mar 32	Tuner, see also type, e.g., Broadcast; F-M; Television; etc	
type 59 310 Oct 32	Tuner, high-fidelity, trf 19 Feb 37	
power pentode, receiver use 576 Apr 31	variable inductance 22 Dec 37	
power, radiation-cooled 316 Oct 32	Tungsten treader 72D Mar 39	
problems, inverse method 20D Jan 34	Tuning, avc, off-tune muting 326D Oct 34	
quality-control tests 32 Feb 36	broadcast receiver, automatic 16 Nov 38	
raw materials used in 104 Apr 34	indicator, discharge tube 42D Jan 36	
receiver, and transmitter 216 Dec 31	gas-tube, avc 40 Feb 33	
performance in circuit 48D Dec 36	saturable reactor 330 Nov 32	
characteristic chart 343 Mar 39	tube, crt 42D July 38	
recent British 48D Dec 36	using 6E5 tube 28 Oct 36	
rectifier, steel-clad 18 Feb 36	permeability, broadcast receiver 158D May 34	
tabulation 35 Oct 36	permeability, pushbutton receiver 12 May 38	
r-f suppressor-grid pentode 10 Jan 32	remote, communications receivers 14 Dec 38	
sales, foreign market 92 Mar 32	receiver at KDYL 19 Aug 36	
single-ended, grid lead at base 26 Sept 38	Tuning by permeability variation, Langley 8 July 31	
supplemental, German 328D Oct 34	Tuning coils wound on magnetic cores 49D Feb 33	
survey of new types 118 Apr 32	Turbidimeter, suspension, for cement 15D Jan 34	
television-pickup, iconoscope 188 July 33	water-supply, photocell 306D Nov 33	
terminology, Industrial 29 Sept 38	Turnstile antenna, Brown 14 Apr 36	
tester, gas tube, end-of-life meter 26 Sept 36		
high-power, mercury-vapor 248 Sept 33	Turntable, see also Phonograph	
high-power, thyatron 224 July 32	Turntable, wow detector, oscilloscope 40D Feb 39	
short-circuit indicator 235D July 32	Turntable wobble indicator, Wichart 13 Feb 38	
universal 198 Nov 31		
tetrode, British 65D Feb 35	TV, see Television	
thyatron, magnetic control 12 Jan 35	Twenty million volts required release atomic energy 635D May 31	
shield grid 114 Apr 34	20-100 mc signal generator, Franks 17 Aug 36	
transmitting, characteristic chart 37 Nov 38	20 to 60 mc oscillator, Binneweg 12 Oct 36	
emission life 22 Dec 38	25-kw television transmitter at Eiffel tower goes into operation 46D July 38	
graphite-anode 338 Dec 33	24,000 watt filter 241D Dec 31	
triode constants, calculation 76D Nov 39	Two electronic musical instruments from Germany 56D Nov 37	
types and characteristics, German 44D Dec 35	Two-element band-pass r-f filters 350D Nov 32	
uhf, new types 278 Sept 32		
use of iron for elements 124D Apr 34		
variable-mu tetrode characteristics 540 Mar 31		
velocity-modulated, survey 9 Apr 39		
voltage regulator, cold cathode 36D Feb 37		
wide-band amplifier 38D Apr 39		
Wunderlich detector 118 Apr 32		
x-ray, industrial 20 Jan 38		
zero-bias, power amplifier 139 June 30		
Tube aids photographic analysis, Dudley 11 Feb 39		
Comment 57D Apr 39		
Tube amplifier equivalent parallel circuit, Robinson 105 Sept 31		
Tube bug telegraph key 522D Feb 81		
Tube capacity put to work, Hollywood & Wilder 30 Oct 35		
Tube characteristic chart 151 May 34		
Tube characteristics chart 80D Nov 37		
Tube characteristics with constant current curves 52D Sept 37		
Tube charger used with new battery for hearing aids 44D Feb 37		
Tube classification chart 158D May 34		
Tube control of a-c motors, Ryder 31 Apr 36		

U

UHF, see also VHF	
UHF radio car transmits safety lessons 42D July 36	
UHF region, allocations 7 July 36	
UHF spectrum allocations 34 Dec 37	
UHF waveforms, on crt 18 Feb 38	
Ultimate nature of electrical resistance 20D Jan 34	
Ultrahigh-frequency antenna terminations—using concentric lines, Tinus 239 Aug 35	
Ultrahigh-frequency diode with movable anode 50D Mar 37	
Ultrahigh-frequency oscillator 60D Dec 39	
Ultrahigh-frequency oscillators 46D Aug 38	
Ultrahigh-frequency power amplifier of novel design, Haef 30 Feb 39	
Ultrasensitive bridge, Jennings 38D Sept 39	
Ultrashort-wave broadcasting 242D Dec 31	
Ultrashort-wave in Hawaii telephone service 27D Jan 32	
Ultrashort-wave link between Lympe and Saint Inglevert—17.5 cm, 1.724 mc 127D Apr 34	
Ultrashort-wave receivers, Raven-Hart 23 Jan 32	
Ultrashort-wave, transmitter and receiver 322D Oct 32	
Ultrashort waves—and new markets, Staff 266 Oct 33	
Ultrashort waves for broadcasting 696D June 31	
Ultrashort waves in medicine 164D Oct 31	
Ultrasonic, see also Supersonic	
Ultrasonic, oscillator, piezoelectric 52D Oct 39	
Ultrasonics, chemical change, cooking 255D Sept 33	
Ultrasonic applications (illustr) 25 Feb 37	
Ultrasonics, survey of techniques 7 July 37	
Ultrasonic vibrations effect chemical changes 20D Jan 32	
Ultrasonics and supersonics, Schecter 34 Jan 38	
Ultra-speed in motion pictures, Staff 7 Dec 35	
Ultraviolet and infrared identify paintings 515D Feb 31	
Ultraviolet intensity measurement 470D Jan 31	
Ultraviolet light, detecting adulterant 388D Nov 30	
Ultraviolet (phototube) recording meter, Wolf 12 June 36	
Ultraviolet rays used in food preservation 492 Feb 31	
Unbalanced absorption in acoustic treatment for sound-picture theatres, Schlenker 625 May 31	
Undesired responses in superheterodynes, Langley 618 May 31	
Unique animated chart controlled by photocells 430D Dec 30	
Unit tube manufacturing layout, Kauer & Brindle 630 May 31	
Universal amplification charts, Terman 34 June 37	
Universal network chart, Staff 84 Mar 35	
Universal performance curves for tuned transformers, Maynard 15 Feb 37	
Universal tube test equipment, Brewster & Mayers 198 Nov 31	
Unusual barrier cells appear in Germany 42D Apr 37	
Unusual mercury rectifier operates at 100 kilovolts 40D Dec 38	

UP

WELDING

	Pg—Mo—Yr
Up in the air (illustr).....	32 May 37
URSI-IRE meeting.....	38D July 37
US Navy's cathode-ray storm indicator.....	133D May 33
US Steel reports savings from phototube furnace control.....	38D Feb 39
Use of Ignitrons in railway operation.....	51D Apr 39
Use of the photoelectric cell in photometry, Sharp.....	243 Aug 30
Use singing wire to measure twist of shaft.....	431D Dec 30
Using tubes for tuning pianos.....	44D Sept 37
Utility service crews using ultrahigh-frequency radio.....	40D Jan 36
V	
Vacuum technique, measurements.....	120D Sept 31
tube manufacture.....	33 Nov 39
Vacuum Tube, see also Tube	
Vacuum-tube applications and relay circuits in transoceanic photoradio, Ranger.....	224 Aug 30
Vacuum-tube bridge for measuring X-ray and ultraviolet.....	163D May 34
Vacuum-tube control for electric balances, Eastman.....	115D Sept 31
Vacuum-tube delay circuits, Muehter.....	336 Dec 33
Vacuum-tube device for testing welds.....	306D Nov 33
Vacuum tube in stage and mobile illumination, Breeding.....	237 Aug 30
Vacuum-tube microvolt meter, Woehlich.....	193D Nov 31
Vacuum-tube modulation meter, Honnell.....	18 Jan 37
Vacuum-tube oscillator used for continuously recording wire diameter, Loeber.....	70 May 30
Vacuum-tube performance vs manufacturing tolerances, Charton.....	44 Feb 32
Vacuum-tube relays of the grid-glow type (illustr).....	182 July 30
Vacuum-tube voltage regulator for power alternators.....	395D Nov 30
Vacuum-tube voltmeter capable of standing heavy overloads.....	48D June 37
Vacuum-tube voltmeter of high sensitivity, Reich, Marvin & Stoll.....	109 Sept 31
Vacuum-tube voltmeter with logarithmic calibration.....	23D Jan 33
Vacuum-tube voltmeters for a-c operation.....	634D May 31
Vacuum tubes and calculating machines.....	224D Aug 33
Vacuum tubes in the day's news (illustr).....	352 Oct 30
Vacuum tubes resistance bridge.....	36D Dec 37
Vacuum tubes with positive grid in place of thyratrons for electronic counting.....	290D Sept 34
Values of Q for various component parts.....	126D Apr 35
Valve-operated coreless induction furnace.....	396D Nov 30
Van de Graaff generator.....	2 Jan 34
Vapor pressure in oxide-coated tubes.....	109D Apr 33
Variable condenser and wavemeter for high frequencies.....	697D June 31
Variable-light variation indicator.....	36D June 36
Variable-mu tetrodes in logarithmic recording, Ballantine.....	472 Jan 31
Variable oscillator (3-10 m) without choke coils.....	92D Mar 34
Variable-selectivity superhet.....	47D Feb 38
Variable-selectivity superheterodyne, Staff.....	180 June 35
Variable speed motor with vacuum tubes.....	192D July 33
Variation of tube capacities with frequency.....	164D Oct 31
Vector conversion chart, Gruenberg, Shoiket, Sussman & Jensen.....	42 Nov 39
Vector transformation chart, Giacoletto.....	35 Feb 38
Velocity of sound in paper.....	105D Apr 33
Versatile level meter, Schumann.....	13 Mar 38
Very short radio waves, Page.....	173 July 30
VHF spectrum, survey of uses.....	266 Oct 33
VHF technique, component characteristics.....	697D June 31

	Pg—Mo—Yr
VHF-uhf, communication techniques.....	666 June 31
Vibration analyzer, electronic for bearing.....	292D Sept 30
Vibration pick-up used to balance motor rotors.....	38D Mar 38
Vibrator power supply from dry cells, Roberts.....	214 July 34
Vibrator power-supply transformer.....	149 May 34
Vibrators, Staff.....	25 Feb 36
Video, see also Picture; Television	
Video amplifier design, Freeman & Schantz.....	22 Aug 37
Addenda.....	52D Nov 37
Viscometer, v-t, test.....	180 July 33
Visual indicator for orchestral levels.....	82D Mar 34
Visual tuning of band-pass amplifiers, DeCola.....	58D Feb 32
Vocal warning when too high or too low.....	186D June 35
Voder, see also Telephony	
Voder, synthetic speech.....	19 Feb 39
Voice number calls from dial phones, Findley.....	424 Dec 30
Voltage control, d-c generator, photocell.....	86D Mar 34
Voltage doubler tube in novel use—new light relay.....	124D Apr 34
Voltage generator for short waves.....	162D Oct 31
Voltage indicator, predetermined.....	80 Mar 34
Voltage limit control, telephone coin box.....	290D Sept 32
Voltage-measurement, small, electronic.....	52D Aug 38
a-c millivolts.....	50D Dec 36
Voltage recorder, gas tube.....	54D Sept 38
Voltage Regulator, see also Power Supply	
Voltage-regulator, a-c, saturable reactor.....	14 July 37
a-c, using 874.....	30D Aug 37
v-t.....	315D Nov 33
electronic, for lamp.....	36D Sept 35
for photometer.....	352 Nov 34
improving.....	26 July 38
in power plant.....	354D Nov 34
glow tubes.....	127D Apr 34
Kathatron tube.....	26 Sept 37
monitor, phototube.....	418 Dec 30
photo printing.....	39D Dec 37
power alternator, electronic.....	395D Nov 30
three-winding, Ward-Leonard.....	164 May 32
thyatron, for alternator.....	132 Apr 32
v-t, fundamental circuits.....	56D Mar 39
low-current.....	19D Jan 33
neon reference.....	48D Mar 39
Voltage regulator applied to an amplifier, Waltz.....	34D Dec 38
Voltage regulators using magnetic saturation, Way.....	14 July 37
Voltage stabilizer.....	44D June 37
for time standard.....	383D Dec 34
Voltage supply, rectified a-c, laboratory.....	93D May 30
Voltmeter, see also Meter	
Voltmeter, a-c electronic with feedback.....	33 Sept 38
electronic, first application.....	15D Jan 33
for welding.....	82 Mar 35
electrostatic, low-voltage.....	252D Sept 33
peak, diode-triode.....	322D Oct 34
rectifying.....	94D Mar 34
sound recording.....	42D Aug 38
push-pull stabilized.....	46D Dec 38
r-f power.....	30 Feb 36
scales a-c and d-c, similar.....	55D Feb 34
v-t, a-c operation.....	634D May 31
bridge circuit.....	80 Mar 34
bridge measurements.....	38D July 39
double-grid circuit.....	142D Apr 32
dynatron.....	623 May 31
high-sensitivity.....	109 Sept 31
logarithmic.....	87D Mar 34
millivoltmeter.....	25 Nov 39
multiplier.....	42D May 38
multirange.....	170 July 30
resonant circuit measurement.....	48D June 37
rms.....	62D Mar 38
self-checking.....	60D June 39
single-battery.....	296D Sept 32
thermocouple input.....	190D June 35
with probe.....	32D Aug 36
Volt-ohm-microammeter, d-c, feedback.....	16 Sept 38
Volume compressor, for broadcasting.....	15 June 36

	Pg—Mo—Yr
Volume Control, see also AVC; Gain Control	
Volume control, acoustic compensation.....	330 Nov 32
acoustically compensated.....	50 Feb 33
inspection, crt.....	180 July 33
v-t, inductive.....	40D Sept 39
Volume control characteristics.....	20D Jan 34
Volume expander, audio	
amplifier.....	7 Mar 36
automatic, broadcasting.....	184 June 35
phonograph.....	14 Nov 35
Volume expansion.....	40D Aug 36
Volume indicator—attenuator, Carter.....	22 July 38
Errata.....	9 Sept 33
Volume indicator, single-tube, audio monitor.....	38D Aug 38
Volume indicator with linear db scale.....	58D Jan 38
Volume limiter, Sheaffer.....	20 Dec 37
Volume of auto-radio increases with speed of car.....	50D Nov 37
VU-DB (correction).....	9 July 39
VU-DB relationships (graph).....	36 May 39
Hales.....	9 July 39
Addenda.....	9 July 39
VU Meter, see also DB Meter; VI Meter	
W	
Watch regulator, comparator.....	227D July 34
Watch ticks analyzed to locate errors.....	220D July 35
Water-cooled lighting for television.....	48D Oct 39
Water cooler, automatic valve.....	389D Nov 30
Water cooling system, for power tubes.....	24 Oct 38
Water softener control, phototube.....	34D Oct 38
Wattmeter, low-level, electrostatic.....	28 Mar 36
Waveform, on crt, at uhf.....	18 Feb 38
Waveguide, see also Microwaves; UHF; etc	
Waveguide, uhf transmission line.....	59D Sept 36
Wavelength measurements with ultra-short waves.....	350D Nov 32
Wavemeter, absorption, ultrashort wave.....	311D Nov 33
Wavemeter, high-frequency, special capacitor.....	697D June 31
short-wave, v-t.....	606D Apr 31
Wavemeter for decimeter waves.....	45D May 36
Wavemeter for decimeter waves.....	40D Aug 36
Wave trap.....	38D July 31
Ways to improve the US patent system, Staff.....	9 May 38
WBBM and KFAB to be synchronized.....	54D Feb 34
WCAU's photocell organ, Staff.....	157 May 34
WCAU's Photona organ.....	123D Apr 35
Weak-signal demodulation by a strong carrier, Appleton.....	171 May 32
Weatherproofing, see also Hermetic Seal; etc	
Weatherproofing audio transformers.....	46D Dec 37
Web control of printing press.....	102D Apr 33
Wehnel cylinder in relation to electron direction.....	141D May 33
Weighing, batch, photocell control	
continuous, phototube.....	98D Mar 32
limit control, phototube.....	60D Feb 32
Welder, control, spot welding.....	40D Oct 37
high-current tube.....	66D May 37
ignitron control.....	27 Nov 36
recording secondary currents.....	63D Feb 37
tester, v-t.....	16 Dec 37
306D Nov 33	
Welding, arc-voltage monitor	
control, automatic monitor.....	48D Apr 38
capacitor discharge.....	38D Jan 36
Strobotron, starting.....	105D Apr 35
thyatron, tube manufacture.....	18 Mar 37
using Strobotron.....	12 Feb 37
electronic timers.....	26 May 36
electronic voltmeter.....	82 Mar 35
Kathatron control tube.....	26 Sept 37
surge current meter.....	26 Sept 37
timer, using rotating disk.....	42D May 37
48D Mar 37	
Welding and voltage control using Kathetrons, Craig.....	26 Sept 37

WETLESS

ZWORYKIN

Pg—Mo—Yr	Pg—Mo—Yr	Pg—Mo—Yr
Wetless (capacitors)260D Aug 35	Widening range of television broadcast54D Apr 37	X
What a patent lawyer should do for you, Toulmin72D Feb 39	Winding the universal coil, Simon22 Oct 36	X-ray, see also Radiography
What about 1937?, Staff7J Jan 37	Errata52 Nov 36	X-ray, control, by oil pump speed52D July 38
What are the costs for police radio systems?—the facts and figures, Flink372 Dec 34	Wire, characteristics, r-f hookup257D Aug 35	diagnosis, scanning technique253D Aug 34
What's new in radio? Staff16 June 38	gage, resistance chart232D Dec 31	equipment and techniques56 Feb 32
What's new in radio for 1936?, Staff20 Sept 35	insulated, in receiver, characteristics18 Jan 34	filament-control, instantaneous exposure54D Feb 39
What's new in radio sets? Staff9 Aug 38	tester, for enamel insulation, 36D Jan 37	industrial practice7 Feb 36
What's time to a hog? Stubble-field34D Feb 37	Wired radio26D Jan 34	tube, hot cathode24D Jan 33
Wheat storage and ultrashort waves53D Apr 37	Wired radio system used by Dow Jones service38D July 36	tuned-transformer, gas-insulated48D Feb 39
When meters blow, Fohr22 Jan 37	WJZ's new tower proves in, Staff21 Jan 37	X-ray for boils249D Aug 30
When will radio sets be styled for sales appeal?, Teague62 Mar 33	WLW installs blind spot antenna array—aimed at Toronto area, Staff152 May 35	X-ray inspection, flume welds, 154D May 34
Where television stands today, Staff671 June 31	Work of engineering division of RMA, Baker & Graham78 Mar 35	X-ray photography of indirectly heated tubes55D Feb 33
Why electronic-made sand-paper cuts better187D June 34	World broadcasting system Berlin163D May 34	X-ray tubes for industry, Isenburger20 Jan 38
Why is the radio industry in the red?, Staff578 Apr 31	World radio convention papers, 61D Feb 39	X-ray used to study internal defects of fruits and vegetables36D Feb 37
Wichita, Kansas, police loud-speaker48D Feb 34	World's largest tube (illustr)191 Nov 31	X-rays and metal radio tubes, Woods190D June 35
Wide-band television amplifiers, Everest16 Jan 38	Wow indicator, turntable13 Feb 38	X-rays in testing tubes (illustr)323 Oct 30
Wide-band television amplifiers—II, Everest24 May 38	WPA interference project66D Nov 36	X-rays produce new species193D July 30
Wide-band tuner, Weeden19 Feb 37	WSOC's pack-type transmitter, Carter29 Apr 39	
Wide-range oscillators56D Feb 39	WTAM gets aluminum gas-filled coaxial transmission line, 66D Feb 39	Z
Wide-range Wheatstone bridge, Avins38D July 39	WTAR directional array, Brown, 38D Jan 38	Zero level, Weeden19 Oct 35
	WTMJ prepares four-stage pickup for golf broadcast40D Sept 35	Zinc silicate phosphors59D Aug 39
	W2XE short-wave transmitter, Taylor23 Dec 37	Zworykin's Iconoscope, Staff188 July 33

AUTHOR INDEX

ABRAHAM

BERNHARDT

A	B
Abraham, G. B., & Russell, Simplified inductance calculation598 Apr 31	Baker, W. R. G., & Cornell, D-C inverter for radio receivers152 Oct 31
Aceves, J. G., Audio-frequency compensation methods224 Dec 31	Baker, W. R. G., Fitzgerald & Whitney, Electron tubes in industrial service581 Apr 31
Affel, H. A., Chinn & Morris, New v-i and reference level, 28 Feb 39Industrial uses of electron tubes467 Jan 31
Aiken, C. B., Interference from shared-frequency broadcasting100 Sept 31Power control by means of phototubes632 May 31
.....Should broadcasting occur in the 500-550 kc band?17 Oct 36	Baker, W. R. G., & Graham, Work of engineering division of RMA78 Mar 35
.....Time-delay effects in synchronous broadcasting124 May 33	Baldwin, J. M., Remote receiver tuning at KDYL19 Aug 36
Albert, A. L., & Beckendorf, Low-level wattmeter28 Mar 36	Ball, A., Phototubes save coating metals48 Nov 38
Alexanderson, E. F. W., Electronic engineering25 June 36	Ballantine, S., Electronic voltmeter using feedback33 Sept 38
.....Thyratrons and their uses8 Feb 38Variable-mu tetrodes in logarithmic recording472 Jan 31
Anderson, C. A., Portable sound measurements26 Apr 36	Bamford, H. S., New television projector25 July 38
Anderson, J. E., Frequency characteristics of piezoelectric oscillators22 Aug 38	Barber, A. W., Diode-triode peak voltmeter322D Oct 34
.....Theory of electron oscillators29 Aug 36New impedance measuring device194D July 33
Andrew, V. J., Applications of concentric transmission lines40D Mar 37Resistors at video frequencies38D Jan 39
.....Economics in broadcast equipment design40D Sept 36	Bareliss, M., Automobile tube of increased output (LA)96 Mar 32
.....Filtering for double radiation13 Oct 37	Barfield, A. R., Dynamic speaker design—Part I188 June 32
Andrew, V. J., & McGregor, Low-cost wooden mast46D May 36Dynamic speaker design—Part II257 Aug 32
Appleton, E. V., Weak-signal demodulation by a strong carrier171 May 32	Barnett, A., & Bagno, Cathode-ray phasometer24 Jan 38
Arndt, J. P., & Williams, Crystal microphone design for single-direction pickup242 Aug 35	Barnett, L. W., Microphone switching systems for broadcast stations152 May 34
Ataka, H., Superregeneration of an ultrashort-wave receiver46D Sept 35	Bartlett, F. A., Simplified dual-diversity radiotelegraph reception48D Aug 39
Atkins, W. R. G., & Poole, PE cells for light measurement42D Apr 36	Bartlett, G., Controlling street lights and water heaters by carrier currents98D Mar 32
Avins, J., Wide-range Wheatstone bridge38D July 39Irradiating seeds speeds up flowering of plants260D Aug 32
	Batcher, R. R., Application of piezoelectric crystals to receivers57 Aug 31
	Baumzweiger, B., New unidirectional microphone62D Feb 39
	Beatty, R. T., Two-element band-pass r-f filters350D Nov 32
	Bechberger, P. F., Computing reactance attenuation39 May 36
High-Q audio reactors22 May 36
	Beckendorf, H. P., & Albert, Low-level wattmeter28 Mar 36
	Becker, J. A., Role of barium in vacuum tubes390 Nov 30
	Beggs, J. E., & Metcalf, All-metal receiving tubes—manufacturing technique30 Sept 38
	Begun, S. J., Magnetic recording148 May 35
	Belar, H., & Dimmick, Noiseless recording with double-triangle slit, and double-cathode photocell142 May 34
	Belcher, D., Radio-acoustic ranging308 Nov 33
	Benzer, W. I., Consider these things in applying electronic door openers14 Feb 38
	Benner, H. J., Putting public address to work26 Dec 36
	Bennett, P. C., Bid and asked communications12 Apr 36
Electric-eyeing telegrams22 Mar 36
	Beranek, L. L., Applications of copper-oxide rectifiers15 July 39
	Bernhardt, C. P., & Brady, Electronic voltage regulator for lamp testing36 Sept 36

Pg—Mo—Yr

Pg—Mo—Yr

Bernhardt, C. P., & Kilpatrick, Electron-tube voltage control for photometry352 Nov 34

Bickley, E. H., Johnson-Rahbeck effect.....51D Jan 38

Binneweg, A., Jr., 50 to 100 mc oscillator design.....36D Dec 37

...60 to 100 mc megacycle oscillator.....29D July 37

...20 to 60 mc oscillator.....12 Oct 36

Blakey, R. E., Network resistances for balanced attenuators33 Nov 35

Bloch, I., Applications of electronic engine indicators—a new use for tubes.....212 July 35

Borsody, F., New York City's fire boat communication system10 Apr 38

Boucké, H., Automatic public address amplifier volume level control45D May 36

Bousquet, A. G., Improving regulator performance.....26 July 38

Bowers, A. F., Photoelectric tubes as limit switches in sheet mill64D Aug 31

Bowie, R. M., Cathode-ray waveform distortion at ultra-high frequencies18 Feb 38

Boyle, H. G., Highly flexible v-t voltmeter.....32D Aug 36

Brady, R. R., & Bernhardt, Electronic voltage regulator for lamp testing36D Sept 36

Braman, V. T., Glow-lamp sound-on-film recording.....679 June 31

Breeding, H. A., Vacuum tube in stage and mobile illumination237 Aug 30

Breisky, J. V., Industrial uses of photocell.....74 May 30

...Photocell as applied to industrial problems.....227 Aug 31

Brewer, F. T., Cathode-ray oscillograph timing axis.....222 Dec 31

Brewer, G. H., Automatic remote amplifier.....21 Nov 38

Brewster, O. H., & Mayers, Universal tube test equipment.198 Nov 31

Brickwedde, F. G., & Scott, Photoelectric cell thermoregulators45 Apr 30

Briggs, H. B., & Ives, Photoelectric properties of extremely thin films of alkali metals.....45 Apr 30

Briggs, T. H., Factors influencing the useful life of vacuum tubes39D Dec 36

Brindle, R., & Kauer, Unit tube manufacturing layout.....630 May 31

Broekhuysen, W. C., Practical metal detector.....17 Apr 38

Brown, C. B., Resistance-coupled amplifier for television265D Aug 32

...Series modulation for television transmitter.....263 Aug 32

...Simultaneous traces with cathode-ray oscillograph.170D June 33

Brown, G. C., & Stansbury, Device for temperature regulation of mercury-vapor tubes104D Apr 33

...Electronic phase-failure relay46 Feb 33

Brown, G. H., Radial ground system chart.....33 Jan 38

...Turnstile antenna14 Apr 38

...WTAR directional array38D Jan 38

Brown, H. A., & Knipp, Power detection characteristics of pentode tubes126 Apr 32

Brown, S. L., Kluge, Linckh, Webster & Harris, Piezo electric measuring devices.....115D Sept 31

Brown, W. J., British vision receivers—I.....26 Dec 39

Browning, G. H., Neon tube condenser tester.....22D Jan 35

...Reducing man-made static366 Dec 32

...Simplified calculations on multiwinding transformers46D May 39

Browning, G. H., & Haskins, Suppression of auto-radio noise273 Oct 33

Brumbaugh, J. M., & Vance, Feedback d-c meter.....16 Sept 38

Bucklin, K. G., Miniature battery tubes.....27 Nov 39

Bunting, T. R., Pitch control for an electronic musical instrument287 Sept 32

...Errata322D Oct 32

Burnell, L. G., & Schwartzmann, Superheterodyne tuning condenser design—for use in multirange receivers180 June 34

C

Caldwell, C. W., & Harrison, Modern beat oscillator.....50D Nov 39

Caldwell, O. H., Broadcast station power and 1931 radio set sales412 Dec 30

...Electron tube—a universal tool in industry (listing)...10 Apr 30

...Some prospects for the electron tube in power transmission324 Oct 30

Carlson, R. W., Automatic adjustment for modulation indicator40D Aug 38

...Electric timing device28 Oct 38

...Practical remote amplifiers.....25 Aug 38

...Errata7 Oct 38

Carpenter, C. M., & Page, Producing artificial fevers.....68 May 30

Carson, R. W., Grid-glow micrometer.....191 June 32

...Machine designer looks at electronic industrial control156 May 34

Carter, S. G., Volume indicator—attenuator.....22 July 38

...Errata9 Sept 38

Carter, S. T., WSOC's pack-type transmitter.....29 Apr 39

Cassidy, D., Engineering applied to packaging.....558 Mar 31

Chaffee, E. L., Power tube characteristics.....30 July 37

...Power tube characteristics.....34 June 38

...Small-signal detection641 May 31

Chamberlain, A. B., Broadcast transmission progress at CBS138 May 34

Chance, B., Electronic control for ship steering.....41 June 39

Charton, W., Vacuum-tube performance vs manufacturing tolerances44 Feb 32

Chase, H., Metals in radio.....13 Oct 37

...Modern radio plant practice9 Dec 39

...Movie dial in Ward radio.....53D Jan 39

Chase, H., (cont'd)

...New plastic materials for cabinets.....26 Nov 37

...Plastic cabinet design16 June 39

...Plastics10 Mar 36

...Properties of plastic materials.....36 Mar 36

...Resistors and condensers in mass production.....28 Sept 39

...Stripping cotton and silk from wire ends.....66D June 39

Chinn, H. A., Reverberation control in broadcasting.....28 May 38

Chinn, H. A., Affel and Morris, New v-l reference level.....28 Feb 39

Chinn, H. A., & Moe, Program-failure alarm for broadcast stations24 July 39

Chinski, G. D., Multiplying the range of vacuum-tube voltmeter42D May 38

Church, L., Phototubes perforate US stamps27 Sept 35

Clarke, A. S., & Schuttig, Broadcast transmitter characteristics, survey of 36 stations.....378 Dec 34

Clarke, J. L., Measuring four-pole networks.....31 July 38

Clement, A. W., Relay contacts—their ailments.....29 Dec 38

...Addenda.....52D Feb 39

Code, J. A., Jr., Supermidget radio transmitter for tracking meteorological balloons in inclement weather.21 July 31

Codel, M., Soviet Russia's five-year plan for radio.....548 Mar 31

Cohen, I., Tuned condenser-coupled amplifiers.....340 Oct 30

...Tuned radio-frequency amplifiers21 Apr 30

Cole, I. E., & Curtis, Rapid-record oscillograph.....70 Aug 31

Conway, T. E., Costs in radio-tube manufacture.....222 July 32

Cook, E. G., Low distortion limiting amplifier.....38 June 39

Cooper, B., Photocells control Detroit bridge traffic.....114 June 30

Cornell, J. I., & Baker, D-C inverter for radio receivers.152 Oct 31

Cornell, J. I., & Wolff, Acoustically compensated volume control for radio and phonograph sets.....50 Feb 33

Craig, P. H., Kathetron—a control tube with external grid70 Mar 33

...Oscillations produced by gaseous diodes.....639 May 31

...Welding and voltage control using kathetrons.....28 Sept 37

Crawford, J. D., Aspects of standard-signal generator design46 Feb 32

Crossley, A., Iron-core intermediate-frequency transformers298 Nov 33

Curran, G. W., Frequency monitoring unit for relay broadcasting stations22 Jan 39

Curtis, A. M., & Cole, Rapid-record oscillograph.....70 Aug 31

D

Dart, H. F., Tests to insure tube quality.....32 Feb 36

Davis, R. F., Television scanning—a survey.....30 Nov 35

Dawson, J. W., Simplified electronic units control theatre lighting323D Oct 34

Day, J. R., Receiver for frequency modulation.....32 June 39

Day, J. R., & Russell, Practical feedback amplifiers.....16 Apr 37

...Errata7 Oct 33

De Cola, R., Dynatron vacuum-tube voltmeter.....623 May 31

...Visual tuning of band-pass amplifiers.....58D Feb 32

De Cola, R., & D'Orio, Bass compensation design chart.....38 Oct 37

Deeley, P. M., Electrolytic capacitor testing in production216 July 35

Deeter, E. L., Color matching in the paper industry.....18 Sept 38

DeForest, L., DeForest's invention of radio knife in 1907.....85D Aug 31

...Electron tube as a saver of life.....223 Aug 30

Dellinger, J. H., New solar radio disturbance.....25 Jan 36

Dennington, A. R., Delivering electrons outside the tube.294 Sept 30

DeTar, D. R., Radio program preselector.....16 Nov 38

DeWalt, K. C., Linear rectification.....262D Aug 34

...Study of high-frequency heating.....338 Nov 32

Diamond, H., Radio system for landing aircraft during fog158 June 33

Diehl, W. F., Standard microvolter using 2nd harmonic principle230 July 32

...Errata323D Oct 32

Dietsch, C. G., Antenna terminations.....14 Sept 35

...Suppression of transmitter harmonics.....167 June 33

...Errata199D July 33

...Terminating concentric lines16 Dec 36

Dimmick, G. L., Eternal Road.....28 Apr 37

Dimmick, G. L., & Belar, Noiseless recording with double-triangle slit, and double-cathode photocell.....142 May 34

Dingley, E. N., Jr., Analysis of efficient modulation.....78 Mar 34

D'Orio, P. A., & De Cola, Bass compensation design chart.....38 Oct 37

Dostal, F., Electronic church chimes.....18 Aug 39

Dreher, C., Control of sound quality in picture production.10 Jan 33

...Progress in sound-picture recording542 Mar 31

...Progress in sound pictures.....7 June 36

...Sound tricks in picture production.....371 Apr 36

Dreyer, J. F., Jr., Beam power output tube.....40 Feb 33

...Gaseous discharge tubes for radio receiver use.....20 Dec 36

Dudley, E., Amateur receivers of advanced design.....22 Jan 37

...Broadcast station statistics.....13 Aug 37

...Developments in 1938 receivers16 Nov 36

...Electron tubes in diathermy12 Nov 37

...News pictures by wire11 Mar 39

...Radiophone service for small ships.....18 May 38

...Relays for tube circuits.....14 May 37

...Silver anniversary Institute of Radio Engineers.....24 Sept 39

...Time telescope37 Nov 38

...Transmitting tube chart11 Feb 39

...Tube aids photographic analysis.....57D Apr 39

...Comment.....38D Aug 39

Dueno, B., Constant-frequency superheterodyne receiver.244 Sept 33

Duffendack, O. S., Randolph & Wolfe, Electron-emitting alloys of nickel and barium.....244 Sept 33

DuMont, A. B., Adjudication of the oscillating-tube patent.....108 May 30

...Cathatograph7 Jan 33

...Elimination of distortion in cathode-ray tubes.....16 Jan 35

DUNCAN

GUY

Pg—Mo—Yr

Pg—Mo—Yr

Duncan, J. R., Paragraphs on television synchronization. .51D Feb 38
 Duncan, R. S., Compact remote amplifier.28 July 30
 Durand, S. R., Metal-clad grid-controlled mercury rectifiers for radio stations.4 Jan 34
 Steel-clad tube for schools.18 Feb 36
 Dutera, W. S., New coaxial transmission line at WTAM. .30 Mar 39

Fisher, C. B., Frequency comparison with the cathode-ray oscillograph.310 D Nov 33
 Fitch, W. A., Sommerfeld's formula.23 Sept 36
 Fitzgerald, A. S., Petoscope.26 Oct 35
 Fitzgerald, A. S., Baker & Whitney, Electron tubes in industrial service.581 Apr 31
 Industrial uses of electron tubes.467 Jan 31
 Power control by means of phototubes.632 May 31
 Fleischer, R., Sensitizing the photocell.518 Feb 31
 Fohr, L. J., Jr., When meters blow.22 Jan 37
 Francisco, P., Greater simplification suggested in designing the radio cabinet.590 Apr 31
 Franks, C. J., Laboratory oscillator for receiver testing. .668 June 31
 Measured input losses of vacuum tubes.222 July 35
 Output meter for testing radio receivers.190 July 30
 60-mc mopa.33 Oct 35
 20-100 mc signal generator.17 Aug 36
 Frederick, C. L., Electric wave filters for high frequencies. .84 Mar 34
 Free, E. E., Artificial eye for blind finds doors or windows in room.64D Aug 31
 Closed throat opened by short-wave heating.197D Nov 31
 Electron microscope hunts chemical affinities.55D Feb 35
 Measuring vs judging loudness of noise.21D Jan 32
 Freeman, R. L., Improvements in AFC circuits.20 Nov 36
 Conductance neutralization.22 Oct 39
 Freeman, R. L., & Schantz, Video amplifier design.52D Nov 37

E

Eastman, F. S., Vacuum-tube control for electric balances.115D Sept 31
 Ebel, A. J., Directional microphone with controlled characteristics.40D Nov 38
 Directional radiation patterns.29 Apr 36
 Eby, H. H., Pity the parts suppliers!12 Feb 36
 Edelman, A., Photocell (installations) experience in the factory.15 Mar 38
 Edgerton, H. E., & Gerneshausen, Stroboscopic photography.220 July 32
 Strobotron.12 Feb 37
 Eger, S. S., & Bagno, Linear modulation by a 55 tube.16 Jan 34
 Strobotron—II.18 Oct 37
 Ekstrand, P. A., Parasitic circuits.26 Oct 38
 Ellis, C. E., Photocell-controlled elevator doors.54 Feb 32
 Ellsworth, H., & McMichael, Color definition by photoelectric measurement.320 Oct 30
 Engstrom, E. W., & Holmes, Power for television receivers. .22 Apr 39
 Television deflection circuits.19 Jan 39
 Television i-f amplifiers.20 June 38
 Television receivers.28 Apr 38
 Television synchronization.18 Nov 38
 Television v-f (picture) circuits.18 Aug 38
 Ephraim, B., Electronic sales aids.24 May 38
 Electronic typewriter speedometer.32D Dec 39
 Increasing disc recording and playing time.35D Oct 35
 Epperson, J. B., Coaxial cable installation.31 Aug 39
 Coaxial line installation—II.31 Aug 39
 High-fidelity program circuits.341 Nov 34
 Errata.23D Jan 35
 Input switching console.38 June 38
 Epstein, D. W., & Maloff, Screens for television tubes.31 Nov 37
 Errata.54 Dec 37
 Everest, F. A., High-gain, wide-band laboratory amplifier. .16 Feb 39
 Wide-band television amplifiers.16 Jan 38
 Wide-band television amplifiers—II.24 May 38

G

Gardner, B. C., & Larson, Image dissector.24 Oct 39
 Garman, G. W., Thyatron d-c motor control.20 June 38
 Garstang, W. W., Improved B eliminator for automobile receivers.254 Aug 32
 New voltage quadrupler.50 Feb 32
 George, E. E., Relays in tube output circuits.19 Aug 37
 George, W. D., & Hall, Precision condenser calibration at radio frequencies.318 Oct 34
 Gerneshausen, K. J., & Edgerton, Stroboscopic photography.220 July 32
 Strobotron.12 Feb 37
 Gerneshausen, K. J., White, Nottingham & Edgerton, Strobotron—II.18 Mar 37
 Germond, H. H., Electronic amplifier tests bearings for vibration.292D Sept 30
 Gerth, R. K., Radio cabinet design.182 July 33
 Gessford, R. K., Knowles & Lowry, New welder tube.27 Nov 36
 Giaccolletto, L. J., Antenna radiation chart.35 July 39
 Vector transformation chart.35 Feb 38
 Gibbs, G. S., Facsimile transmission from plane to ground.117 June 30
 Gilbert, R. W., Direct current amplifier for photocell applications.44D Jan 38
 Glover, R. P., Audio-radio distribution and control circuit. .155 Oct 31
 Buying radio materials by specification.16 July 31
 Record-saving pickup.31 Feb 37
 R-F impedance-matching networks.29 Jan 36
 Special instruments for radio receiver production testing.500 Feb 31
 Glover, R. P., & Hunter, Loudspeaker deflection measurements.474 Jan 31
 Godsey, F. W., Jr., Electrolytic condensers for radio use. .596 Apr 31
 Goeth, J. E., Dynamic loudspeaker design.66 Aug 31
 Dynamic loudspeaker design—II.112 Sept 31
 Golden, N. D., & North, Sound equipment sales abroad. . .11 July 31
 Goldman, S., Shielded loop for noise reduction in broadcast reception.20 Oct 38
 Goldinan, S., & Olson, Calibration of microphones.106 Sept 31
 Goldsborough, T. R., Patents practice essentials.33 Sept 36
 Goldsmith, A. N., Music of the electron.270 Sept 30
 Plan to eliminate radio interference.370 Dec 34
 Some unsolved problems of sound-picture technique. . .23 Apr 30
 Goodhue, W. M., Equivalent circuit for tetrodes and pentodes.341D Dec 33
 Goodwin, W. N., Jr., & Miller, R-F resistance of copper wire.38 Feb 36
 Graff, J. W., Electronic voltage relay.80 Mar 34
 Grafunder, W., Kleen & Wehnert, Distortion factor and summation tones in radio receivers.48D Nov 35
 Graham, V. M., Problems that face the radio engineer. . .174 Nov 31
 Graham, V. M., & Baker, Work of engineering division of RMA.78 Mar 35
 Gray, A. R., Dry cell resistances.35 Nov 36
 Gray, T. S., Electronics laboratory for technical students. .86 Mar 35
 Groves, W. E., Protecting the high-voltage ammeter. . . .38D Feb 38
 Grozier, R., Pickup angle again.73D May 38
 Gruenberg, E. L., Sholket, Sussman & Jensen, Vector conversion chart.42 Nov 39
 Gulliksen, F. H., Electron tube motor control.179 June 34
 Gunsolley, V. V., Automatic bias generation for a-c amplifiers.191D June 35
 Electronic fader.58D Feb 35
 Improved meter shunt circuit.36D Apr 38
 Guy, R. F., Broadcast coverage.16 May 36
 Rules and standards for broadcast stations.11 Aug 39

F

Farnham, P. O., Overload limit extension of the tetrode detector.228 Dec 31
 Farrar, C. L., Measurement of class-B amplifier distortion.196 June 32
 Felix, E. H., Requirements of television.235 Aug 30
 Felstead, C., Time-delay circuits.38D Mar 36
 Fill, J. V., Ferrocart and its applications.358D Nov 34
 Findley, P. B., Voice number calls from dia phones. . . .424 Dec 30
 Fink, D. G., Aircraft radio compass.27 Oct 35
 Antennas for air navigation.34 Feb 36
 Art advances (survey).20 June 39
 Cathode-ray amplifier (beam-grouping) tubes.9 Apr 39
 Developments in aircraft radio area.20 Feb 38
 Electron control for high-speed motion pictures. . .250 Aug 34
 For engineer-photographers only.22 June 37
 40-cm waves for aviation.12 Nov 39
 Frequency-modulated transmitters.20 Nov 39
 Frequency modulation demonstrated.14 Mar 39
 Laboratory television receiver.16 July 38
 Laboratory television receiver—II.26 Aug 38
 Laboratory television receiver—III.22 Sept 38
 Laboratory television receiver—IV.16 Oct 38
 Laboratory television receiver—V.26 Nov 38
 Laboratory television receiver—VI.16 Dec 38
 New permanent magnet alloys.30 May 36
 Orthicon.11 July 39
 Parallel impedance chart.31 Mar 38
 Phase-frequency modulation.17 Nov 35
 Precise light measurement—a new photocell application.190D June 34
 RCA describes television system.8 Jan 37
 Sound-on-disc.6 Oct 36
 Television components.18 May 39
 Television formulae (definitions).33 Mar 39
 Television in the field (survey).13 June 39
 Television receiver for the home.16 Sept 39
 Television receivers in production.22 Mar 39
 Television terminology.14 June 37
 Television transmitters.26 Mar 39
 Television without sync signals.33 Mar 38
 What are the costs for police radio systems?—the facts and figures.372 Dec 34
 Finlay, R., Electronic pH meter.39 Nov 37
 Photometering raw silk.12 July 36

HAEFF

Pg—Mo—Yr

Pg—Mo—Yr

H

Haefl, A. V. , Ultrahigh-frequency power amplifier of novel design	30 Feb 39
Haefner, S. J. , & Hamlin , A-C operated beat oscillator	20 May 36
Hales, F. B. , VU-DB relationships (Graph)	36 May 39
Addenda	9 July 39
Hall, E. L. , & George , Precision condenser calibration at radio frequencies	318 Oct 34
Hall, F. A. , Tube controlled candy wrapper	32D Jan 37
Hallberg, S. H. , Short-wave therapeutics	32D Jan 37
Haller, C. E. , & Knowles , Phantom (tube) tester	248 Sept 33
Hallman, L. B. , Adjusting the class-B linear power amplifier—in broadcast station equipment	219 July 35
Practical volume compression	15 June 36
Selecting loud speakers for special operating conditions	22 Nov 38
Simplified attenuation network design	150D Oct 31
Ham, F. H. , 3700 Sleuths	11 Oct 36
Hamilton, H. G. , Radio tube noise	26 Aug 37
Hamlin, B. W. , & Haefner , A-C operated beat oscillator	20 May 36
Handrek, H. , New insulating materials for radio frequencies	162D May 34
Hanly, J. H. , Electronic interrupter	35 Nov 35
Hansen, E. H. , Glow-lamp noiseless recording	177 Nov 31
Harmon, R. N. , Applying police radio	22 Oct 37
Harriss, J. H. O. , Critical distance tubes	33 May 36
Harris, S. , Kluge , Linckh , Brown & Webster , Piezoelectric measuring devices	48D July 36
Harrison, A. M. , Grid-glow tube measures commutator roughness	115D Sept 31
Harrison, C. W. , & Caldwell , Modern beat oscillator	59D Sept 36
Hartman, H. W. , Thyatron-controlled voltage rectifiers	50D Nov 39
Haskins, R. L. , Condenser-lead resonance chart	43 Feb 33
Haskins, R. , & Browning , Suppression of auto-radio noise	35 Aug 39
Hathaway, J. L. , Effect of microphone polarity on percentage modulation	273 Oct 33
High-frequency pre-emphasis	28 Oct 39
Havens, B. S. , Machine throws out bad beans	23 Nov 39
Robot humidifier actuated by moisture on window pane	197D Nov 31
Rubber conveyors are synchronized by tubes	61D Feb 32
Hazeltine, A. , Deflection control tubes	21D Dec 36
Headrick, L. B. , Taylor & Orth , Cathode-ray tubes for oscillograph purposes	14 Mar 32
Hein, C. C. , Wilson & Hitchcock , Matching colors of samples at three points	332 Dec 33
Heller, J. I. , Methods used in electrical prospecting	342D Nov 32
Heller, R. E. , & Lyons , Direct-reading vacuum-tube millivoltmeter	184 Nov 31
Hellmann, R. K. , Modulator bridge	25 Nov 39
Helt, S. , Measuring resistance of broadcast antennas	29 Mar 38
Henney, K. , Characteristics of American electronic tubes (chart)	45 Feb 34
Characteristics of variable-mu tetrodes	308 Oct 32
Coming industrial markets	540 Mar 31
Engineering trends in receiving sets at Atlantic City	288 Sept 30
Temperature control by electron tubes	176 July 30
To clear up the confusion about two kinds of pentodes	183 June 34
Henry, C. C. , & Stemmler , I-F transformers, cost vs quality	40 Apr 30
Hess, W. F. , Color sensitiveness of photoelectric cells	97 Mar 32
Hesse, H. R. , Six-place LC product table	220 Aug 30
Hesselberth, W. M. , & Reich , Cold-cathode amplifier tube	31 June 38
Hilliard, J. K. , Definition of standard reference systems	282 Oct 33
Notes on audio-frequency measurements	192D Nov 31
Reverberation control in motion picture recording	506 Feb 31
Squeeze or matted track	15 Jan 38
Theater sound reproducing system standards	23 Oct 38
Two-way horn system	46D May 38
Hitchcock, R. C. , Simplifying dynamic tube curves	24 Mar 36
Traffic controlled by light beams	220D July 34
Hitchcock, R. C. , & Osbon , Design of output transformer	515D Feb 31
Output transformer design—II	381 Nov 30
Hitchcock, R. C. , Wilson & Hein , Matching colors of samples at three points	427 Dec 30
Hoag, J. B. , Condenser discharge chart	342D Nov 32
Hodges, A. R. , First iron-core-coll receiver Stromberg-Carlson Model 68	29 Sept 37
Holden, D. H. , Electronic control of complex auditorium lighting	158D May 34
Hollands, L. , Circuit design related to tube performance	368 Nov 30
Equipment for testing radio receivers in production	18 Mar 39
Hollmann, H. E. , Spherical tank ulf oscillator	545 Mar 31
Triograph	26 Dec 38
Holloway, G. C. , Electron-tube time-delay relay	28 Jan 38
Hollywood, J. M. , & Wilder , Tube capacity put to work	220 Aug 33
Holmes, L. B. , Resonoscope	30 Oct 36
Holmes, R. M. , Photo-emf cell characteristics	17 July 37
Holmes, R. S. , & Engstrom , Television deflection circuits	33 Apr 37
Television i-f amplifiers	19 Jan 39
Power for television receivers	20 June 38
Television receivers	22 Apr 39
Television synchronization	28 Apr 38
Television v-f (picture) circuits	18 Nov 38
Vacuum-tube modulation meter	18 Aug 38
Honnell, F. M. , Vacuum-tube modulation meter	18 Jan 37
Hoppe, W. H. , Permanent magnets for electronic instruments	636 May 31

Horn, C. W. , Importance of phase control in synchronizing	423 Dec 30
Proper sites for broadcast stations	66 Mar 33
Horton, J. W. , Electron tubes in scientific measurements	18 Apr 30
Electronic cardiachometer	14 Aug 38
Hough, C. W. , Life test for condensers	114D Sept 31
Houghton, E. W. , Cold filamentless radio tube	182 Nov 31
Houston, W. V. , Class-A push-pull calculations	18 June 37
Quantum theory of photoelectric and thermionic effects in metals	44 Apr 30
Howe, K. , Automatic voltage regulation	164 May 32
Hubbard, H. D. , The electronic structure of the elements	330 Oct 30
Hull, L. M. , Code (NRA) and the Engineer	246 Sept 33
Hultberg, C. A. , Economical design for radio set transformers	286 Sept 34
Economical design for radio set transformers	310 Oct 34
Hunt, F. V. , & Pierce , HP6A: Radical departure in phonograph pickup design	9 Mar 38
Hunter, T. A. , & Glover , Loudspeaker deflection measurements	474 Jan 31
Hutcheson, J. A. , Graphical harmonic analysis	16 Jan 36
Hutchins, G. F. , Testing of sound-picture channels	502 Feb 31

I

Ing, G. , Simplifying b-c operators' job	24 Sept 37
Ingbretsen, R. E. , & Terman , Output transformer (frequency) response	30 Jan 36
Irby, F. S. , Developments in automatic record changers	584 Apr 31
Economic evolution with the introduction of sound pictures	30 Apr 30
Home talking movies	276 Sept 30
Sound-picture industry abroad	193 July 30
Statistics of the sound-picture field	130 June 30
Supply and cost of 16-mm film for the home	48 Aug 31
Iseburger, H. R. , X-ray tubes for industry	20 Jan 38
Isler, S. , Curve plotter and comparator	361 Dec 32
Ives, H. E. , & Briggs , Photoelectric properties of extremely thin films of alkali metals	45 Apr 30

J

Jaderholm, H. W. , Band-pass (filter) characteristics	33 July 36
Jansky, C. M., Jr. , Automatic recording of field strength	148 May 34
Jarvis, K. W. , Design of tone-control circuits	230 Aug 30
Linear detector distortion	386 Dec 34
Notes on the 59-type power output tubes	310 Oct 32
Jennings, J. E. , Ultrasensitive bridge conversion chart	38D Sept 39
Jensen, I. , Gruenberg , Sussman , & Shoiket , Vector	42 Nov 39
Jervis, E. R. , Amplification factor chart	45 June 39
Jeryan, P. H. , High-speed radio production	21 Dec 35
Jinks, C. C. , Computing antenna height	30 July 38
Jupe, J. H. , High-speed synchronous motor employed in British television	38D Dec 38
London annual exhibition of scientific equipment	56D Mar 38
London exhibit of scientific apparatus	52D Mar 39
London radio exhibition	68D Nov 38
Photochemical combination used as switch control	36D Apr 38
Phototube controls logarithmic response in galvanometer	44D Apr 39
Phototubes control swing bridge	36D Mar 37

K

Kalmus, H. P. , Stabilized bridge circuit	30 Dec 39
Karapetoff, V. , Electron—and beyond	37 Apr 30
Karplus, E. , Communication on the quasi-optical frequencies	666 June 31
Life of impregnated paper condensers	54D June 38
Unit tube manufacturing layout	630 May 31
Kelley, R. L. , & Miller , Single-ended r-f pentodes	26 Sept 38
Kellogg, E. W. , & Phelps , Time delay in resistance-capacity circuits	22 Feb 37
Errata	29 Feb 38
Time delay in resistance-capacity circuits	26 Feb 38
Kennedy, R. K. , New metal for grids	54D Sept 38
Kennelly, A. E. , Magnetic disturbances and long-distance reception	42 Apr 30
Radio during solar eclipses	248 Aug 32
Kettering, C. F. , Research, radio automobiles	329 Oct 30
Kiehn, H. C. , Simple phonograph oscillator	54 Oct 38
Kiernan, E. F. , Amplifier measuring technique	18 July 37
6L6s in a degenerative amplifier	50D Nov 36
Kilgore, C. R. , Mouromtseff & Noble , New forms of short-wave tubes	278 Sept 32
Kilgour, C. E. , Effects on reception of overmodulation	9 Jan 32
Problems of push-push amplification	82 Mar 32
Push-pull amplifier graphics	73 Mar 34
Kilpatrick, F. E. , & Bernhardt , Electron-tube voltage control for photometry	352 Nov 34
Kime, R. M. , Thyatron laboratory rectifier	219 Aug 33
King, A. J. , & Metcalf , New selenium tube	234 Dec 31

Pg—Mo—Yr

Pg—Mo—Yr

King, F., Simple-constructed attenuation network.....48D Sept 38
 King, P. B., Jr., Tube controlled motor.....14 Jan 38
 Kingsley, R. J., New 41-mc W8XH.....19 Jan 38
 Kintner, S. M., Industrial uses of vacuum devices.....15 Apr 30
 Kispbaugh, A. W., Recent developments in high-power broadcast transmitters.....136 June 30
 Kleen, W., Graffunder & Wehnert, Distortion factor and summation tones in radio receivers.....48D Nov 35
 Klemperer, H., New ignitron firing circuit.....12 Dec 39
 Kilpsch, P. W., Applying neutralization to a-f amplifiers.....252D Aug 34
 Kluge, J., Linckh, Webster, Brown & Harris, Piezoelectric measuring devices.....115D Sept 31
 Knipp, C. T., & Brown, Power detection characteristics of pentode tubes.....126 Apr 32
 Knoll, M., Electronic microscope.....243 Sept 33
 Knowles, D. D., Ignitron—a new controlled rectifier.....164 June 33
 Knowles, D. D., & Haller, Phantom (tube) tester.....248 Sept 33
 Knowles, D. D., Lowry & Gessford, New welder tube.....27 Nov 36
 Knowles, D. D., & Sashoff, Grid-controlled glow and arc discharge tubes.....183 July 30
 Knowles, H. S., Improved fidelity of two-speaker radio receivers.....154 May 32
 ..Loudspeaker cost vs quality.....240 Sept 33
 Kock, W. E., Generating sine waves with a gas discharge tube.....92 Mar 35
 ..Notes on the Paris international radio exposition.....40D Aug 36
 ..Stabilized sweep-circuit oscillator.....20 Apr 39
 Koechel, W. F., Circuit for determining heating time of vacuum tubes.....293D Sept 32
 ..Electronic voltage control of d-c generators.....381 Dec 34
 ..Low-range electrostatic voltmeter.....252D Sept 33
 ..Photocell control of temperature for filament-coating ovens.....170 May 32
 ..Phototube voltage supervisor.....418 Dec 30
 ..Radio tubes used as photocells.....372 Dec 32
 ..Role of vacuum-tubes in tube factory.....121 Mar 33
 Koehler, G., Class B & AB audio amplifiers.....14 Feb 36
 ..Resistance-coupling design charts.....25 Aug 36
 Koenig, A. J., Design problems of sound-on-film for home movies.....621 May 31
 Kohler, H. W., D-c voltage stabilization.....388D Dec 34
 Korn, A., Phototube in automatic weaving.....378 Nov 30
 Korn, T., Method of periodical sound reproduction.....38D May 38
 Kreuzer, B., Acoustic and light characteristics of sound screens.....420 Dec 30
 Kruse, R. S., All-wave radio receiver for aircraft.....336 Oct 30
 ..Design of a portable signal generator.....285 Sept 30
 ..Development of insulating materials.....72 May 30
 Kulberg, L. E., Crystal monitor for checking police radio.....38D Feb 38

L

Lack, C. M., Nuclear physics chart.....33 Aug 37
 Lambert, R., Linear rectification.....21D Jan 34
 Lampkin, G. F., Analysis of high modulation transmission.....326 Oct 30
 ..Beat-frequency oscillator control.....369 Dec 32
 ..Dual-frequency audio source for general laboratory use.....417 Dec 30
 ..Economics of police radio reception.....22 Jan 32
 ..Meter for indicating 100-percent modulation.....26 July 31
 ..R-F power measurements.....30 Feb 36
 ..Simple a-c voltage regulator.....30 Aug 37
 Landon, V. D., & Svesen, Solution of the superheterodyne tracking problem.....250 Aug 32
 Lane, C. T., D-C amplifier for measuring potentials in living organisms.....31D June 37
 Langham, D. F., Special-events transmitter.....19 Oct 39
 Langley, R. H., Tuning by permeability variation.....8 July 31
 ..Undesired responses in superheterodynes.....618 May 31
 Lanterman, W. F., Design of attenuation networks.....508 Feb 31
 ..Relations between modulation and antenna current.....59 Aug 31
 Laport, E. A., Broadcast transmitter measurement using a common wavemeter.....88 Mar 32
 ..Calculation of vertical antenna radiation patterns.....46 Feb 35
 ..Directional antenna design.....22 Apr 36
 ..High-fidelity broadcast transmitter performance.....144 May 34
 ..Increased efficiency from tower antennas—a review.....238 Aug 34
 ..Reactance values of capacitance and inductances for the middle radio frequencies.....219 July 34
 ..Simplified method of modulator design.....184 July 33
 Larson, C. C., & Gardner, Image dissector.....24 Oct 89
 Laszlo, S. E., Can radio sets be sold to Europe?.....229 Dec 81
 ..Can radio tubes be sold abroad?.....92 Mar 32
 LeBel, C. J., Advanced disc recording.....34 Nov 38
 ..Direct disc recording.....22 Mar 38
 ..Disc-cutting problems.....17 Dec 39
 ..Quality in disc reproduction.....25 Oct 37
 Lee, J. A., Controlling chemical process by electron devices.....684D June 31
 Lee, R., Radio transformers sealed in aluminum cans.....46D Dec 37
 ..Fibrous glass insulation in radio apparatus.....83 Oct 39
 ..Reactors in a-c service.....18 Sept 36
 ..R-F insulator voltage limits.....31 Oct 35
 ..Solving a rectifier problem.....29 Apr 33
 ..Study of r-f choke coils.....120 Apr 34
 Leidy, W. J., Interspaced transformer windings.....233D Dec 81
 Leonard, S. C., Measurement of minute changes of capacitance and inductance.....18 Mar 38
 Leonhardt, R. W. P., Automatic line-measuring equipment of the German broadcast system.....247 Nov 34

Levy, M. L., Distortion limiter for radio receivers.....26 Mar 38
 ..Frequency drift compensation.....15 May 39
 ..New 6E5 circuit.....28 Oct 36
 Lewin, G., Frequency characteristics in film recording and reproduction.....40 Feb 32
 ..Noiseless sound-on-film recording.....102 Sept 31
 ..Practical method of toe recording.....464 Jan 31
 ..Studio practice in noiseless recording.....146 Oct 31
 Lewis, H. M., Standards in television.....10 July 37
 Lewis, H. M., & Loughren, Television in Great Britain.....32 Oct 37
 Lewis, R. O., Manufacturing spray shield tubes.....193D Nov 31
 Libby, L. L., Cathode rays for the uhf.....15 Sept 36
 Liddbury, F. A., High-resistance measurement.....94D Mar 32
 Likel, H. C., Single-tube floating needle volume indicator.....38D Aug 38
 Linckh, H. E., Kluge, Webster, Brown & Harris, Piezoelectric measuring devices.....115D Sept 31
 Liu, Y. J., & Trimmer, Compensated amplifier chart.....35 Sept 39
 Livadary, J. P., Effects of optical slits in light-valve sound recording.....54 Aug 31
 ..Effects of optical slits in variable area sound recording.....587 Apr 31
 ..Frequency characteristics of optical slits.....112 Feb 31
 ..Sound motion-picture photography.....240 Aug 30
 Livingston, J. J., Radioactivity by bombardment.....7 Nov 35
 Livingston, O. W., & Lord, Electronic multiplier for high speed counting.....7 Jan 34
 ..End-of-life meter.....26 Sept 36
 ..Initial impulse indicator.....267 Sept 33
 ..Single-tube thyatron inverter.....96 Apr 33
 ..Thyatron control of welding in tube manufacture.....186 July 33
 Livingston, O. W., & Maser, Shield grid thyatrons.....114 Apr 34
 Loeber, C. W., Developments in ultrahigh frequency generation.....376 Nov 30
 ..Vacuum-tube oscillator used for continuously recording wire diameter.....70 May 30
 Logan, E. W., Indicators for arc-back in mercury-vapor rectifiers.....48D Apr 39
 Logan, G. H., Design for exponential horns of square cross section.....33 Feb 39
 ..Mean level determination.....27 Aug 36
 Logan, L., Patents on industrial uses of light-sensitive cells.....27D July 31
 Long, J. T., Jr., Porcelain pipe at WHAM.....24 Oct 38
 Lord, H. W., Electronic timer for very short intervals.....309 Oct 32
 ..Recording resistance-welder secondary currents.....16 Dec 37
 Lord, H. W., & Livingston, Electronic multiplier for high speed counting.....7 Jan 34
 ..End-of-life meter.....26 Sept 36
 ..Initial impulse indicator.....267 Sept 33
 ..Single-tube thyatron inverter.....96 Apr 33
 ..Thyatron control of welding in tube manufacture.....186 July 33
 Losinsky, M., & Babat, Surface hardening—a new job for transmitting tubes.....44D June 38
 Loughren, A. V., & Lewis, Television in Great Britain.....32 Oct 37
 Lowry, E. F., Self-protecting cathode.....26 Dec 35
 ..Some phenomena in oxide coated filaments.....44 Apr 30
 ..Thermionic cathodes for gas-filled tubes.....280 Oct 33
 Lowry, E. F., Knowles & Gessford, New welder tube.....27 Nov 36
 Lyford, E. B., Photocells in Weather Bureau observations.....316D Oct 34
 Lyons, W., & Heller, Direct-reading vacuum-tube millivoltmeter.....25 Nov 39

M

McArthur, E. D., Determining field distribution by electronic methods.....192 June 32
 ..Magnetic control of thyatrons.....12 Jan 35
 ..Movable anode tubes.....16 Mar 37
 McBride, E., & Podolsky, Single-tube beat-frequency oscillator.....356 Nov. 34
 ..Errata.....23D Jan 35
 McBride, R. S., Proposed Patent Office reforms.....116 Apr 32
 McCanne, W. R., Dollar cost of tone quality.....97 Sept 81
 MacCoun, T. D., Radio program distribution over lighting circuits.....682 June 31
 McCullough, F. S., Electronic engineering in geophysics.....28 Aug 39
 McDill, R. D., Consultant talks about electronics.....11 Sept 38
 ..Installing photocell control.....276 Oct 33
 McDonough, T. J., Laminated plastics for radio.....8 Oct 38
 McGregor, A. M., & Andrew, Low-cost wooden mast.....46D May 36
 McIlvaine, H. A., Combined photo and amplifier tubes.....224D Aug 33
 McMichael, P., & Ellsworth, Color definition by photoelectric measurements.....320 Oct 30
 McNabb, V. C., Power transformers for automobile radio vibrators.....149 May 34
 McNamee, B. F., Padding condenser.....160 May 32
 ..Sound-wave stroboscope.....24 Nov 36
 McNulty, E. B., Cathode-ray null indicator.....36D Sept 38
 Malloy, T. J., Magnetic recorder.....30 Jan 38
 Maloff, I. G., Problems of cathode-ray television.....10 Jan 34
 Maloff, I. G., & Epstein, Screens for television tubes.....31 Nov 37
 ..Errata.....54 Dec 37
 Malter, L., Directional characteristics of loudspeakers for theaters.....186 July 30
 Manke, A. G., Beat oscillators for modern radio receivers.....88 Mar 35
 ..Tone fidelity switch.....34 May 37
 Marino, A. J., Place of nickel in radio tube manufacture.....4 Jan 33
 Marsal, P., Battery radio design.....12 Jan 38
 Marsden, C. P., Jr., Thermionic emission in transmitting tubes.....22 Dec 38

MARSTEN

RAVEN-HART

Pg—Mo—Yr

Pg—Mo—Yr

Marsten, J., Antenna coupling systems.....82 May 30
 Martin, R., 60-megacycle teletypewriter.....10 Mar 37
 Marvin, G. S., Reich & Stoll, Vacuum-tube voltmeter of high sensitivity.....109 Sept 31
 Maser, H. T., & Livingston, Shield grid thyratrons.....114 Apr 34
 Maslin, A. J., Three-phase rectifier circuits.....28 Dec 36
 Massa, F., Combination tones in nonlinear systems.....20 Sept 38
 Comment.....61D Feb 39
 Efficiency of horn loudspeakers.....30 Apr 37
 Loudspeaker design.....20 Feb 36
 Loudspeaker measurements.....18 July 36
 Massaut, P. H., Distributed capacitance chart.....31 Mar 38
 Mathieson, C. F., Making a-c and d-c scales correspond on a universal voltmeter.....55D Feb 34
 Matthews, A. C., Fidelity compensation by regeneration.....18D Jan 33
 Mayberry, W., Supersonics—a survey.....7 July 37
 Mayer, H. F., Automatic selectivity control.....32 Dec 36
 Cathode-ray oscillograph applications.....14 Apr 38
 Mayer, H. J., Practical time signal system for broadcasting.....246 Aug 35
 Mayers, K. F., & Brewster, Universal tube test equipment.....198 Nov 31
 Maynard, J. E., Multilayer coil inductance chart.....33 Jan 39
 Universal performance curves for tuned transformers.....15 Feb 37
 Meier, W. L., & Richards, Power supply and linear time axis for cathode-ray oscillographs.....110 Apr 34
 Meissner, E. R., Calibration of low audio frequencies.....137D May 33
 Flux balancer for output transformer.....161D May 35
 High-gain a-c/d-c amplifier.....195D July 33
 Mendenhall, H. E., Radiation-cooled power tubes for radio transmitters.....316 Oct 32
 Tubes for short-wave transatlantic phone service.....38 Apr 30
 Merrill, F. D., Jr., Novachord.....16 Nov 39
 Practical design for an electronic piano.....30 May 39
 Messing, E., Coil testing methods for use in radio plants.....248 Aug 35
 Notes on dual-band receiver design.....300 Nov 33
 Metcalf, G. F., New cathode-ray oscillograph tube.....158 May 32
 Metcalf, G. F., & Beags, All-metal receiving tubes—manufacturing techniques.....148 May 35
 Metcalf, G. F., & King, New selenium tube.....234 Dec 31
 Metcalf, G. F., & Pike, All-metal vacuum tubes.....312 Oct 34
 Mezger, G. R., Single-unit video converter.....31 Feb 38
 Miles, L. D., & Morack, Thermionic delay relays for cathode protection.....124 Apr 35
 Miller, D. M., Shunt-excited antenna used by uhf station.....44D May 39
 Miller, E. C., Simplified method of measuring broadcast harmonics.....425 Dec 30
 Miller, G. H., Improving the broadcast of recorded programs.....178 June 34
 Miller, H. F., Jr., Multiband r-f choke coil design.....264 Aug 35
 Miller, J. F., & Kelley, Single-ended r-f pentodes.....28 Sept 36
 Miller, J. H., & Goodwin, R-F resistance of copper wire.....38 Feb 36
 Miller, J. M., Thermal drift in superheterodyne receivers.....24 Nov 37
 Mimno, H. R., Characteristics of 1934 tubes.....151 May 34
 Mittlemann, E. J., Dosimetry in short-wave therapy.....62D Nov 39
 Moe, R. B., and Chinn, program-failure alarm for broadcast stations.....24 July 39
 Mooradian, A. P., Radio knife for marking leather, cutting glass.....61D Feb 32
 Moore, W. H., Simple ultrashort-wave wavemeters.....311D Nov 33
 Morack, M. M., & Miles, Thermionic delay relays for cathode protection.....124 Apr 35
 Morris, E. W., & Reid, Regulator maintains voltage for motion picture printers.....39D Dec 37
 Morris, R. M., Affel & Chinn, New v-i and reference level.....28 Feb 39
 Morse, R. S., Modern vacuum practice in electronics.....33 Nov 39
 Mourontseff, I. E., Kilgore & Noble, New forms of short-wave tubes.....278 Sept 32
 Mucher, G., Thermionic time-delay relay.....35D Apr 36
 Muehter, M. W., Vacuum-tube delay circuits.....336 Dec 33
 Murray, A. F., Measurement of fidelity in television systems.....137 Oct 31
 RMA completes television standards.....28 July 38
 Murray, C., Thermocouple used in low-voltage tube voltmeter.....190D June 35

N

Nachod, Q. P., Nomogram for coil calculations.....27 Jan 37
 Nafzger, L. H., Beacon marker transmitter.....29 May 36
 Nathan, R., I-F transformer alignment.....33 Feb 37
 Nelson, J. R., AVC applied to amplifier tubes.....50 Feb 34
 Considerations on detector-output tube systems.....94D Apr 33
 High-level automatic or self-bias detection.....14 July 31
 High-level plate circuit rectification.....55D Mar 31
 Output amplifiers for 110-volt d-c receivers.....128 Apr 32
 Pentode tubes used as triodes.....226 Dec 31
 Neustadt, H., Jr., Photoelectric color measuring instruments.....128 May 33
 Thyatron linear time axis for cathode-ray oscillograph.....198 June 32
 Nicholson, M. G., Noise-reducing circuit.....14 Oct 36
 Nickless, W. H., Manufacture of caesium silver-oxide photocells.....255 Aug 32
 Nims, A. A., Circle diagrams for tube circuits.....23 May 39
 Errata.....49D Oct 39
 Noble, D. E., A-C operated high gain amplifiers.....120 July 34
 Limited impulse & delay relays.....28 Aug 36
 Regenerative null indicator.....190D June 34
 Noble, H. V., Industrial high-frequency power.....22 Oct 35
 Noble, H. V., Mourontseff & Kilgore, New forms of short-wave tubes.....278 Sept 32
 Norris, C. B., New thermionic speed regulator.....244 Aug 35

North, C. J., & Golden, Sound equipment sales abroad.....11 July 31
 Nottingham, W. B., White, Edgerton & Germeshausen, Stroboscope—II.....18 Mar 37
 Nunan, T. J., Nunan yarn tester.....12 Feb 39

O

Odell, E. G., Automatic line-level indicator.....36D Oct 37
 Olken, H., Electronic oscillators for industrial process control.....144 Oct 31
 Errata.....206D Nov 31
 Olney, B. J., Acoustical labyrinth.....24 Apr 37
 Phonograph pickup tracking error vs distortion and record wear.....19 Nov 37
 Tone quality of small radio sets.....85D Aug 31
 Olson, H. F., & Goldman, Calibration of microphones.....106 Sept 31
 O'Neill, G. D., Some comments on the use of getters.....510 Feb 31
 Orth, R. T., Taylor & Hearick, Cathode-ray tubes for oscillograph purposes.....332 Dec 33
 Osborn, W. O., & Hitchcock, Design of output transformer.....381 Nov 30
 Output transformer design—II.....427 Dec 30
 Ostrolenk, S., Cathode-ray aircraft compass.....12 Aug 36
 Home facsimile recording.....26 Jan 38
 Overbeck, W. P., Permatron and its application in industry.....25 Apr 39
 Oxman, L., 6L6 amplifier.....30 Sept 36

P

Page, A. B., Very short radio waves.....173 July 30
 Page, A. B., & Carpenter, Producing artificial fevers.....68 May 30
 Paine, R. C., Self-checking vacuum tube voltmeter.....60D June 39
 Parkhurst, D. L., In hydrographic chart making, the tube—as a surveying tool.....124 June 30
 Paro, H., Public address ave.....24 July 37
 Partridge, H. M., Electronic speed and acceleration recorder.....262 Aug 32
 Electronic tubes in chemistry.....166 July 30
 Paulson, C., & Tietz, Photoelectric cells in precision inspection work.....6 Jan 32
 Pear, C. B., Jr., Radio meteorographs.....32D Sept 37
 Pencher, C. J., Modern audiometer.....38D Aug 39
 Perozzo, H., Keying monitor for c-w transmitters.....44D Dec 37
 Phelps, W. D., & Kellogg, Time delay in resistance-capacity circuits.....22 Feb 37
 Errata.....29 Feb 38
 Phelps, W. D., & Kellogg, Time delay in resistance-capacity circuits.....26 Feb 35
 Phillips, C. J., Diffraction of electrons.....24 Sept 35
 Industrial uses of electronic diffraction.....84 Mar 32
 Phillips, G., Noise recorder for comparing street-car sounds.....99D Mar 32
 Pierce, J. A., & Hunt, HP6A: Radical departure in phonograph pickup design.....9 Mar 38
 Pike, O. W., Power control thru grid-regulated heavy-current tubes.....85 May 30
 Pike, O. W., & Metcalf, All-metal vacuum tubes.....122 Oct 34
 Podolsky, L., Electronics in resistor manufacturing.....180 July 33
 Podolsky, L., & McBride, Single-tube beat-frequency oscillator.....356 Nov 34
 Errata.....28D Jan 35
 Polk, H. S., Contactless volume control.....38D July 39
 Pollack, D., Choice of tubes for wide-band amplifiers.....38D Apr 39
 Mutual inductance calculations.....31 July 37
 Slow acting vacuum-tube relay.....342 Oct 20
 Polydoroff, W. J., Further notes on iron-core coils at r-f or i-f.....13 Jan 34
 Poole, H. H., & Atkins, PE cells for light measurement.....42D Apr 36
 Porter, B. H., Determination of particle size by electron diffraction.....44D Oct 36
 Porter, B. H., Radiation counting circuits.....23 July 26
 Potter, J. L., Rectifier for modulation measurements.....247 Sept 33
 Powers, R. A., Electronic paint-thickness gage.....54D May 37
 Phototube controls punch press.....21 July 37
 Phototube temperature control.....12 Apr 37
 Recent tube applications to automobile making.....12 Apr 39
 Tubes enter the automobile plant.....10 Sept 35
 Tubes help make automobiles.....22 June 36
 Preisman, A., High-resistance measurement with vacuum tubes.....214 July 35

R

Rackey, C. A., & Shuetz, NBC, Hollywood.....10 May 39
 Rahm, W. E., Jr., New bioelectronic application, electroencephalography.....11 Oct 39
 Rahmel, H. A., & Warriner, Circuits for politics.....12 Sept 36
 Randolph, D. W., Duffendack & Wolfe, Electron emitting alloys of nickel and barium.....244 Sept 35
 Ranger, R. H., Vacuum-tube applications and relay circuits in transoceanic photo-radio.....224 Aug 30
 Raven-Hart, R., German supermetat receiver.....674 June 31
 Recent European developments in electronic musical instruments.....18 July 31
 Ultrashort-wave receivers.....23 Jan 32

Pg—Mo—Yr

Pg—Mo—Yr

Raymond, H. H., Self-opening doors.....	36 Feb 36	Schumann, F., Versatile level meter.....	13 Mar 38
Redfield, J., Nature of music.....	239 Aug 30	Schutig, L. A., & Clarke, Broadcast transmitter charac- teristics, survey of 36 stations.....	378 Dec 34
Reich, H. J., Magnetic control of mercury vapor rectifier tubes.....	48D Feb 33	Schwartz, E. B., Radio resistor measurement.....	37 May 37
...Self-stopping d-c thyatron circuit.....	240 Dec 31	Schwartzmann, H., & Burnell, Superheterodyne tuning condenser design—for use in multirange re- ceivers.....	180 June 34
...75-watt commutator type inverter.....	252D Sept 33	Scott, H. H., Simple improvements in R-C power-supply filters.....	42D Aug 39
...Trigger circuits.....	14 Aug 39	Scott, R. B., Rectifier filter design.....	28 June 38
Reich, H. J., & Hesselberth, Cold-cathode amplifier tube.....	282 Oct 33	Scott, R. B., & Brickwedde, Photoelectric cell thermo- regulators.....	45 Apr 30
Reich, H. J., Marvin & Stoll, Vacuum-tube voltmeter of high sensitivity.....	109 Sept 31	Seeley, W. J., Electronics—the wedding of the sciences.....	434D Dec 30
Reid, T. A., & Morris, Regulator maintains voltage for motion picture printers.....	39D Dec 37	Seigin, P. J., Network-selecting chart.....	30 Oct 39
Rentschler, H. C., Measurement of gas pressure.....	292D Sept 32	Seright, C. G., Modulation measurement.....	23 Aug 36
...Photocells for special applications.....	29 Apr 30	...Short-turn indicator.....	136D May 33
Replogle, D. E., Graphite anodes in transmitting tubes.....	338 Dec 33	...Testing capacitors and resistors—for radio set pro- duction.....	279 Sept 34
Rhodes, H. E., Harmonic analysis applied to the power pentode.....	118 June 30	Shapley, H., Astronomer comments on the photocell.....	434D Dec 30
...Intermediate-frequency tuning condenser require- ments.....	690 June 31	Sharp, C. H., Electronic devices in a testing laboratory.....	284 Sept 32
Richards, P. A., & Meier, Power supply and linear time axis for cathode-ray oscillographs.....	110 Apr 34	...Use of the photoelectric cell in photometry.....	243 Aug 30
Richardson, A. G., Direct-reading short-circuit test for vacuum tubes.....	233D July 32	Shea, R. F., All-wave signal for production tests.....	244 Aug 34
...Sensitizing the wavemeter for intermediate fre- quencies.....	130D Apr 32	Sheaffer, C. F., Sound illusion preamplifier.....	14 Sept 38
Richey, J. L., Sun's effects on radio.....	188 June 34	...Volume limiter.....	20 Dec 37
Richter, W., Electronic voltmeter for d-c arc welding.....	82 Mar 35	Sheffield, B., Recent developments in German cathode- ray tubes.....	60D Nov 37
...Mathematical treatment of the grid bias resistor.....	62D Nov 37	...Television image (analysis).....	56D Feb 39
...Multistage photocell current amplifier applied to fur- nace temperature control.....	245 Aug 35	Sheldon, H. H., Einstein and the electron.....	462 Jan 31
...New color-separator.....	28 Mar 37	Sherman, R. M., Phototubes applied as traffic safety aid.....	40D Nov 38
...Plate circuit theorem.....	19 Mar 36	Sherwood, H. F., Soft x-ray radiography.....	8 Dec 37
...Resistance coupling for push-pull amplification.....	40D Oct 35	Shoiket, H., Gruenberg, Sussman & Jensen, Vector con- version chart.....	42 Nov 39
Riddle, R. H., Ship-to-shore communication.....	9 Sept 37	Short, D. W., Television direct-pickup camera.....	69 Aug 31
Ritter, E. W., New use of the suppressor-grid r-f pentode.....	10 Jan 32	Shuertz, R. F., & Rackey, NBC, Hollywood.....	10 May 39
Roberts, W. M., Electronic high-speed timing device.....	90 Mar 32	Sigmon, L. C., Midget remote amplifier used at KCMO.....	38D Jan 38
Roberts, W. van B., Maximum amplification in capacity- coupled circuits.....	20 July 31	Silbar, R. G., Electronic music from vibrating reeds.....	226 July 34
...Vibrator power supply from dry cells.....	214 July 34	Silver, McM., Dual diversity reception simplified.....	66D Mar 39
Robertson, B. L., & Rogers, C-R tube photography.....	19 July 39	Silverman, D., Noise and noise measurement (bibliography).....	34 Feb 39
Robinson, G. D., Tube amplifier equivalent parallel circuit.....	105 Sept 31	Simon, A. W., Winding the universal coil.....	22 Oct 36
Robinson, K. H., Football pickup and spotting equip- ment.....	46D Dec 39	...Errata.....	52D Nov 36
Roder, H., Noise in frequency modulation.....	22 May 37	Singer, C., Stethophone amplifier.....	66D June 39
Roehmann, L. F., References on radio interference.....	32 Oct 38	Sinnett, C. M., Practical volume expansion.....	14 Nov 35
Roemisch, J. L., Condenser tracking test set.....	12 Mar 37	Sklar, L. B., Padding condenser.....	40 May 37
Rogan, J. J., Patent review on receiver circuits and tubes.....	672 June 81	Slawson, H. H., Loudspeaker system routs farm plowlers.....	42D May 39
Rogers, T. A., & Robertson, C-R tube photography.....	19 July 39	...Ticker tape records eye movements.....	34D Aug 38
Rogers, W. O., Stroboscope aids dynamic speaker design.....	30D Aug 37	Smeltzer, R. F., Mixer circuit designs.....	32 Nov 36
Rose, A., Electronic device for measuring magnetic fields.....	21 July 38	...Errata.....	66D Jan 37
Rosenbaum, J., Interoffice communication.....	26 May 37	Smith, A. J. G., Radio exports reach peak level.....	54D Oct 39
Rubenstein, A. L., Orientation mechanism.....	225D Aug 33	Smith, C. M., Jr., R-F amplifier for frequency monitor.....	32D Dec 39
Rumble, A. R., Directional array field strengths.....	16 Aug 37	Smith, E. L., Photoelectric control on packaging machines.....	302 Nov 33
...Simplified inductance-coil calculations.....	315 Oct 34	Smith, H. M., Field strength measurements.....	20 Aug 36
Russell, J. B., & Day, Practical feedback amplifiers.....	16 Apr 37	Smith, P. H., Transmission line calculator.....	29 Jan 39
...Errata.....	7 Oct 38	Snow, H. A., Humidity (and components).....	25 Oct 36
Russell, L. H., & Abraham, Simplified inductance calcu- lation.....	598 Apr 31	Somers, P. J., Scanning in television receivers.....	18 Oct 37
Russell, W., Noise rejection circuits.....	38D May 39	...Television terms (glossary).....	34 Aug 37
Ryder, J. D., Electronic control circuits for d-c motors.....	20 Dec 38	Sperling, J. G., Transmitter adjustments.....	15 July 36
...Errata.....	11 Sept 39	...Errata.....	56D Jan 37
...Tube control of a-c motors.....	31 Apr 36	Sponable, E. I., Latest developments in wide-film pic- tures.....	65 May 30
S			
Sabine, H. J., Portable reverberation meter.....	30 Mar 37	Stager, A., Magnets and magnetic materials.....	11 Feb 37
Sallinger, H., Tracing electron paths in electric fields.....	50D Oct 36	...Relaxation circuit measures radiant energy.....	29D July 37
Sallberg, B., Design and use of acorn tubes for ultrahigh frequencies.....	282 Sept 34	Stahl, T. H., Sr., Electron-coupled a-f oscillator.....	56D May 36
Sanial, A. J., Concentric folded horn design.....	16 Jan 39	Stansbury, C., & Brown, Device for temperature regula- tion of mercury-vapor tubes.....	104D Apr 33
...Dynamic microphone amplifier for sound news recording.....	52 Feb 34	...Electronic phase-failure relay.....	46 Feb 33
Sarbey, M. D., Measurement of vacuum in radio tubes.....	594 Apr 31	Stellwagon, F. W., Bypass condenser production test equipment.....	504 Feb 31
Sashoff, S. P., & Knowles, Grid-controlled glow and arc discharge tubes.....	183 July 30	Stemm, R. E., & Henry, I-F transformers, cost vs quality.....	97 Mar 32
Saxl, I. J., Measuring ionization currents and high resistances.....	62 Aug 31	Stetson, H. T., Radic reception and sunspots.....	122 Apr 32
...Measuring one billion ohms.....	171D June 33	Stinchfield, J. M., Cathode-ray tube applications.....	153 May 35
...Measuring textile gelatines with a phonograph pick-up.....	40D Jan 37	Stinchfield, J. M., & Schade, Reflex circuit considera- tions.....	153 June 33
...Piezoelectric methods of measuring mechanical forces.....	292D Sept 32	Stinchfield, J. M., & Schmit, Measuring harmonic distur- tion in tube circuits.....	78 May 30
...Recording of long programs or books.....	85 Mar 32	Stoll, K. A., Reich & Marvin, Vacuum-tube voltmeter of high sensitivity.....	109 Sept 31
...Status of cold-cathode tubes abroad.....	17 Jan 32	Stone, C. W., Electron devices in d-c power transmission.....	544 Mar 31
Schade, O. H., & Stinchfield, Reflex circuit considerations.....	153 June 33	Stone, W. G., Filter-type amplifier coupling.....	194D July 33
Schantz, J. D., & Freeman, Video amplifier design.....	22 Aug 37	...Errata.....	259D Sept 33
...Addenda.....	52D Nov 37	Storm, H. O., Remote tuning of communication receivers.....	14 Dec 38
Schecter, H., Ultrasonics and superphonics.....	34 Jan 38	Stout, M. B., Behavior of half-wave rectifiers.....	32 Sept 39
Schlenker, V. A., Unbalanced absorption in acoustic treat- ment for sound-picture theaters.....	625 May 31	Stromeyer, C. F., Improved 120-volt d-c audio amplifier.....	194 June 32
Schmit, D. F., & Stinchfield, Measuring harmonic distur- tion in tube circuits.....	78 May 30	Stubblefield, B., What's time to a hog.....	34D Feb 37
Schnoll, N., Etched foil for electrolytics.....	30 May 37	Sundt, E. V., Balancing shaded-pole motors.....	36 Oct 37
Schrage, W. E., Characteristics of German radio receivers.....	306 Oct 34	...Cathode-ray tube used to test fuses.....	316D Oct 34
...Developments in German receiver design.....	46D Oct 35	Sussman, H., Gruenberg, Shoiket & Jensen, Vector con- version chart.....	42 Nov 39
...Play-back recording methods for broadcasting.....	179 June 35	Sutherland, L., Grid-current measurement.....	148 Oct 31
Schreiner, L. L., Shrinkage control in radio-tube manu- facture.....	332 Nov 32	...Errata.....	206D Nov 31
Schulz, E. H., R-F power-amplifier chart.....	33 Dec 39	Sveen, E. A., & Landon, Solution of the superheterodyne tracking problem.....	250 Aug 32
		Szymanowitz, R., Colloidal graphite in electronics field.....	87D Mar 34
T			
Tasker, H. G., Ground noise in sound-on-film pictures (II).....	333 Oct 30		
...Ground noise in sound pictures.....	273 Sept 30		
Taylor, C. W., Headrick & Orth, Cathode-ray tubes for oscillograph purposes.....	332 Dec 33		

TAYLOR

ZWORYKIN

Pg—Mo—Yr

Pg—Mo—Yr

Taylor, G. S., Electone, an electronic piano.....26 Jan 39
 Taylor, J. P., Broadcast transmitter features.....20 Jan 36
Cathode-ray antenna phasemeter.....62D Apr 39
D-C amplifier for logarithmic recording.....24 Mar 37
W2XE short-wave transmitter.....23 Dec 37
 Teachman, A. E., Equivalent resistance chart.....31 Aug 38
Impedance chart for r-f lines.....35 Dec 36
 Teague, W. D., When will radios be styled for sales appeal?.....62 Mar 33
 Terman, F. E., Feedback amplifier design.....12 Jan 37
Improved circuits for measuring negative resistance.....340D Dec 33
Linear detection of heterodyne signals.....386 Nov 30
Resistance-stabilized oscillators.....190 July 33
Universal amplification charts.....34 June 37
 Terman, F. E., & Ingebretsen, Output transformer (frequency) response.....30 Jan 36
 Thiessen, A. E., Impedance matching networks.....552 Mar 31
 Thomas, C. H., & Bahls, New cold-cathode gas-triode.....14 May 38
 Thomas, G. G., Production testing of present day radio receivers.....498 Feb 31
 Thomas, H. E., Some aspects of police radio communication.....74 Mar 34
 Thompson, B. J., Measuring a micromicroampere.....290 Sept 30
Shot effect (correction).....34D Feb 37
Tubes to fit the wavelength.....214 Aug 33
 Thompson, L., Power amplifier with positive grid-bias.....139 June 30
 Thurnauer, H., Properties of ceramic materials (table).....33 Apr 39
 Tibbets, D. R., Building bridges by radio.....7 Sept 35
 Tietz, W. J., & Paulson, Photoelectric cells in precision inspection work.....6 Jan 32
 Tinus, W. C., Ultrahigh frequency antenna terminations—using concentric lines.....239 Aug 35
 Todd, H. C., Iron in the more costly tubes.....229D July 34
 Toulmin, H. A., Jr., Patent problems in the field of electronics.....306 Oct 32
What a patent lawyer should do for you.....72D Feb 39
 Travis, E., Oscilloscope as wow detector.....40D Feb 39
 Trimble, R. F., Transformers for gaseous discharge tubes.....282 Sept 32
 Trimmer, J. D., & Liu, Compensated amplifier chart.....35 Sept 39
 Tucker, J. P., Permeability tuned pushbutton system.....12 May 38
 Tulauskas, L., Bridge-type push-pull amplifiers.....134 May 33
Electronic a-c galvanometer.....478 Jan 31
Multirange vacuum-tube voltmeter.....170 July 30
Problem of pentode output fidelity.....142 Oct 31
 Tuttle, W. N., Dynamic tube measurements over wide ranges of value.....344 Nov 32

U

Uehling, E. A., Analysis of r-f amplification.....414 Dec 30
Improved preselector circuit for radio receivers.....379 Sept 30
 Underhill, C. R., Electronics in surgery, the radio knife.....316 Oct 30
 Upp, C. B., Heavy-duty industrial amplifier tube.....162 May 32
 Urquhart, N., Dramatic use of controlled sound.....252D Aug 35

V

Van Allen, J. W., Patent cases in the courts.....189 July 30
 Vance, A. W., & Brumbaugh, Feedback d-c meter.....16 Sept 38
 Vassos, J., Selecting the right radio cabinet design.....146 May 34
 Von Ardenne, M., Distortion of sawtooth waveforms.....36 Nov 37
Double-beam cathode-ray tube.....31 Oct 36
 Von Kunits, P., High gain—simplified.....18 Dec 35

W

Wagner, E. R., Processes in vacuum tube manufacture, exhaust—carbonizing—ageing.....213 July 34
Raw materials in vacuum tube manufacture.....104 Apr 34
Study of chemical phenomena in coated filaments.....178 July 30
 Walker, E. A., Transient amplifier analysis.....39 Nov 39
 Wallis, C. M., Half-wave gas rectifier circuits.....32 Oct 38
 Walsh, C., High-quality radio reception.....20 July 39
Lagoon of Nations sound system.....26 July 39
Modern fasteners in the radio industry.....27 May 39
 Waltz, W. W., Chart for simple attenuator design.....247 Aug 34
Economics of theater maintenance.....225 July 32
Forest radio service.....9 Feb 39
Input control circuit.....38D Mar 39
Power supply filter curves.....29 Dec 35
Voltage regulator applied to an amplifier.....34D Dec 38
 Ware, P., Advancements in a-c/d-c design.....14 Jan 35
 Warriner, C. H., & Rahmel, Circuits for politics.....12 Sept 36
 Waterman, A. T., Density distribution of electron gas in equilibrium with a hot body.....45 Apr 30

Waterman, W., Charts for solving wire problems.....232D Dec 31
Solving network problems by graphs.....60 Aug 31
 Watson, W. O., Calibration of grid gain controls.....24D July 31
 Watts, E. G., Electron-tube telemetering for gas and water works.....50 Feb 35
Improvements in frequency multipliers for aircraft radio.....124 Apr 32
 Way, K. J., Voltage regulators using magnetic saturation.....14 July 37
 Webster, R. A., Kluge, Linckh, Brown & Harris, Piezo-electric measuring devices.....15D Sept 31
 Weedon, W. N., Automatic volume expander.....184 June 35
Massless pickup.....36 May 36
Wide-band tuner.....19 Feb 37
Zero level.....19 Oct 35
 Wehnert, W., Kleen & Graffunder, Distortion factor and summation tones in radio receivers.....48D Nov 35
 Weiller, P. G., Electronic welding timers.....26 May 36
Notes on manufacture of mercury-vapor rectifier tubes.....99 Apr 33
 Wein, S., Questions and answers.....29 Sept 37
 Weinberger, J., Ribbon microphone and its applications.....336 Nov 32
 Weiner, M. J., Sound effects with high impedance mixing.....56D June 38
 Weinland, C. E., Photocell temperature regulator.....224D July 35
Thyratron voltage regulator.....132 Apr 32
 West, S., Ses for yourself.....32D Dec 37
 Wheeler, F., Multiple-circuit pads.....33 Mar 37
 Wheeler, H. A., Emission valve modulator for super-heterodynes.....76 Mar 33
R-F transition losses.....26 Jan 36
 White, A. B., Nottingham, Edgerton & Germeshusen, Strobotron-II.....18 Mar 37
 White, E. J., Continuous weighing with light-sensitive telepoise.....60D Feb 32
 White, S. Y., AFC design considerations.....28 Sept 36
Signal-seeking circuits to aid correct tuning.....18 Jan 35
 White, W. C., Producing very high frequencies by means of the magnetron.....34 Apr 30
 Whitehorne, E., How manufacturers can cash in on prosperity campaign.....218 Aug 33
 Whitney, C. F., Baker & Fitzgerald, Industrial uses of electron tubes.....467 Jan 31
Electron tubes in industrial service.....581 Apr 31
Power control by means of phototubes.....632 May 31
 Wichart, W. F., Turntable wobble indicator.....13 Feb 38
 Wilder, J. M., & Hollywood, Tube capacity put to work.....30 Oct 35
 Wilder, M. P., Television in Europe.....13 Sept 37
 Williams, A. L., Piezoelectric loudspeakers and microphones.....166 May 32
 Williams, A. L., & Arndt, Crystal microphone design for single-direction pickup.....242 Aug 35
 Williams, R. O., Superregeneration using the pentagrid converter.....126D Apr 35
 Wilmotte, R. M., Directive antennae for broadcast stations.....362 Dec 32
 Wilson, E. D., Initial drift in photocells.....15 Jan 39
Photocells from rectifier discs.....312 Oct 32
Photovoltaic cells in compound circuits.....118 Apr 35
 Wilson, E. D., Hein & Hitchcock, Matching colors of samples at three points.....342D Nov 32
 Wise, R. M., Special tubes for automobile radio sets.....616 Feb 31
 Woehlich, E., Vacuum-tube microvolt meter.....193D Nov 31
 Wolf, L. J., Ultraviolet recording meter.....12 June 36
 Wolf, S. K., Modern treatment of broadcasting acoustics.....14 Jan 32
 Wolfe, R. A., Duffendack & Randolph, Electron emitting alloys of nickel and barium.....244 Sept 33
 Wolff, I., Calculation of loudspeaker efficiency.....52 Feb 32
 Wolff, I., & Cornell, Acoustically compensated volume control for radio and phonograph sets.....50 Jan 33
 Woodhead, R. C., Band-spread problem.....29 Jan 37
 Woods, R. C., Industrial x-ray practice.....7 Feb 36
X-rays and metal radio tubes.....190D June 35
 Wunderlich, N. E., Intercarrier noise suppression.....13 Jan 33
 Wyeth, C. A., Phototube circuit design for sound pictures.....22 July 31

Y

Yates, R. F., Prices of radio stocks.....52 Aug 31
 Young, L. G., Applying feedback to broadcast transmitters.....20 Aug 39
 Young, R. W., Middle C.....75D Nov 37

Z

Zaharis, G., Sync impulse generator for television deflection circuits.....48D June 39
 Zehner, J. L., Cheater circuits for synthetic testing of mercury-vapor power tubes.....224 July 32
 Zender, R. G., Characteristics of insulated wires used in radio set production.....18 Jan 34
Tests on r-f circuit hook-up wire.....257D Aug 35
 Zworykin, V. K., Improvements in cathode-ray tube design.....188 Nov 31

Additional copies of this Index may be purchased at \$1.00 each from:

ELECTRONICS

McGraw-Hill Publishing Co., Inc.
330 West 42nd Street
New York 18, N. Y.

Copyright, 1951, by McGraw-Hill Publishing Co., Inc.



DIRECTORY SECTION OF THE 1951-1952 electronics BUYERS' GUIDE

In the preparation of **ELECTRONICS BUYERS' GUIDE**, every effort was made to insure the completeness and accuracy of the Directory listings according to the information provided by the manufacturers.

The listings were compiled from information provided by more than 2,500 companies manufacturing electronic or allied products and include all products that will be available in the coming year, insofar as the companies themselves can determine. The completeness and accuracy of the listings are entirely due to the helpful cooperation of these manufacturers.

Products are arranged and indexed in a simple, easy-to-find, telephone-book style. Names of Manufacturers who are advertisers in the **BUYERS' GUIDE** are bold-faced in the listings and page numbers of their advertisements are shown. This makes it possible to obtain complete information on products quickly and easily by referring to the advertising pages.

Several new product headings have been added. Due to lack of sufficient information, only manufacturers who were known are included under these new headings. Listings include an index of registered trade names and an alphabetical listing of all companies engaged in the manufacture of electronic components, complete equipment or allied products.

THIS SYMBOL . . .



. . . before a manufacturer's name in the listings indicates that the product is . . . In Production • Available Within a Reasonable Time • Unrestricted for General Industrial Use

NOTE: This punch-out tab is for your convenience in locating the Directory Section of this issue. Simply push out and fold under. It will then serve as a tab mark to indicate where the listings start.

PUSH OUT
AND FOLD

Alphabetical Listings Of All COMPONENTS—COMPLETE UNITS—ALLIED PRODUCTS Used in Electronic Equipment for All Purposes

The complete electronic and allied product lines of more than twenty-five hundred manufacturers are arranged and indexed in a simple, easy-to-use, telephone book style in the following listings.

Products are listed alphabetically by generic names followed by descriptive or type names where necessary, as **ADAPTERS—Battery**.

For example: To find the manufacturers of mass spectrometer tubes you would turn to the generic product heading **TUBES** and listed alphabetically under that you would find **TUBES—Mass Spectrometer**.

The only exceptions are **INSULATING COMPOUNDS; INSULATION MATERIALS; INSULATION PARTS; METALS; PLASTIC MATERIALS; and TUBE PARTS**. Products falling in these classifications are arranged alphabetically under

those six headings.

Cross references are provided wherever necessary to cover names, other than the standard ones, that are sometimes used.

Manufacturers under each product heading are also arranged alphabetically. Those companies who are advertisers in this issue are bold-faced and the page numbers of their advertisements given to permit quick and easy reference for the necessary technical data.

In compiling the listings for this year's **ELECTRONICS BUYERS' GUIDE** extreme care has been taken to ascertain those products which are in production, or available within a reasonable time and, unrestricted for general industrial use. They are identified in the listings by the following symbol . . .



This symbol before a manufacturer's name in the listings indicates that the product is—**In Production** ● **Available Within a Reasonable Time** ● **Unrestricted for General Industrial Use**

ACCELEROMETERS

- Bendix Aviation Corp., Pacific Division, 11600 Sherman Way, N. Hollywood, Calif.
- CALIDYNE CO., The, 751 Main St., Winchester, Mass. ADV. PG. 239.
- Consolidated Engineering Corp., 300 N. Sierra Madre Villa, Pasadena 8, Calif.
- Doelcam Corp., 56 Elmwood St., Newton 58, Mass.
- ECLIPSE-PIONEER DIV. BENDIX AVIATION CORP., Teterboro, N. J. ADV. PG. 198, 199.
- Engineering Research Associates, Inc., 1902 W. Minnehaha Ave., St. Paul, Minn.
- Flader, Inc., Frederic, 1330 Laskey Rd., Toledo 12, Ohio.
- Glenco Corp., Metuchen, N. J.
- Gulton Mfg. Corp., Metuchen, N. J.
- INDUSTRIAL ELECTRONICS, INC., 8080 Wheeler St., Detroit 10, Mich. ADV. PG. 234, 235.
- Instrument Laboratories, 315 W. Walton Place, Chicago 10, Ill.
- KAY ELECTRIC CO., 14 Maple Ave., Pine Brook, N. J. ADV. PG. 340.
- Massa Laboratories, 3868 Carnegie St., Cleveland, Ohio.
- Miller Corp., Wm., 325 N. Halstead St., Pasadena 8, Calif.
- RAHM INSTRUMENTS, INC., 12 W. Broadway, New York 7, N. Y. ADV. PG. 354.
- Schaevitz Engineering, Crescent Blvd., at Drexel Ave., Pennsauken Township, Camden 11, N. J.
- Southwestern Industrial Electronics Co., 2831 Post Oak Rd., P. O. Box 13058, Houston 19, Texas.
- Statham Laboratories, Inc., 12401 W. Olympic Blvd., Los Angeles 64, Calif.
- Trans-Sonics, Inc., Bedford Airport, Bedford, Mass.

ADAPTERS—Battery

- AEROLITE ELECTRONIC HARDWARE CORP., 507 26th St., Union City, N. J. ADV. PG. 355.
- EBY INC., Hugh H., 4700 Stenton Ave., Philadelphia 44, Pa. ADV. PG. 214.
- FRANKLIN AIRLOOP CORP., 43-20 34th St., Long Island City, N. Y. ADV. PG. 45.
- FRANKLIN MFG. CORP., A W., 43-20 34th St., Long Island City 1, N. Y. ADV. PG. 44.
- General Cement Mfg. Co., 919 Taylor Ave., Rockford, Ill.
- J F D MFG CO., 6101-23 Sixteenth Ave., Brooklyn, N. Y. ADV. PG. 407.
- Monarch Radio & Television Corp., 2430 Atlantic Ave., Brooklyn 33, N. Y.

ADAPTERS—Foreign

- Eagle Electric Mfg. Co., Inc., 23-10 Bridge Plaza S., Long Island City, N. Y.
- General Cement Mfg. Co., 919 Taylor Ave., Rockford, Ill.
- J F D MFG CO., 6101-23 Sixteenth Ave., Brooklyn, N. Y. ADV. PG. 407.
- KULKA ELECTRIC MFG. CO., INC., 30 South St., Mount Vernon, N. Y. ADV. PG. 317.
- Morse Co., Frank W., 1300 Soldiers Field Rd., Boston 35, Mass.
- NEO-SIL CORP., 26 Cornelison Ave., Jersey City 4, N. J. ADV. PG. 253.
- Smith, Inc., Herman H., 436 18th St., Brooklyn 15, N. Y.

ADAPTERS—Panoramic

- PANORAMIC RADIO PRODUCTS, INC., 10 South Second Ave., Mt. Vernon, N. Y. ADV. PG. 383.
- POLARAD ELECTRONICS CORP., 100 Metropolitan Ave., Brooklyn 11, N. Y. ADV. PG. 184, 185.
- VECTRON, INC., 235 High St., Waltham, Mass. ADV. PG. 214.

ADAPTERS—Phase

- Arlington Electric Products, Inc., 500 W. 52nd St., New York 19, N. Y.
- Varo Mfg. Co., Inc., Box 638, Garland, Texas.

ADAPTERS—Test

- Arlington Electric Products, Inc., 500 W. 52nd St., New York 19, N. Y.
- Gadgets, Inc., 3629 N. Dixie Drive, Dayton 5, Ohio.
- KINGS MICROWAVE CO., INC., 50 Marbledale Rd., Tuckahoe 7, N. Y. ADV. PG. 178, 179.
- Monarch Radio & Television Corp., 2430 Atlantic Ave., Brooklyn 33, N. Y.
- Selector Industries, Inc., 401 E. 138th St., New York 54, N. Y.
- United Technical Laboratories, Box 425-W, Morristown, N. J.

ADAPTERS—Tube

- OTOMIC INSTRUMENT CO., 84 Massachusetts Ave., Cambridge 39, Mass. ADV. PG. 410.

- J F D MFG CO., 6101-23 Sixteenth Ave., Brooklyn, N. Y. ADV. PG. 407.
- MacLeod & Hanopol, Inc., 10 Joiner St., Charlestown 29, Mass.
- Star Expansion Products Co., 147-149 Cedar St., New York 6, N. Y.
- Supreme, Inc., Greenwood, Miss.

ADHESIVES

- American Cynamid Co., 38 Rockefeller Plaza, New York 20, N. Y.
- American Products Mfg. Corp., Oleander & Dublin Sts., New Orleans 18, La.
- Armstrong Cork Co., Lancaster, Pa.
- Bakelite Co., A Div. of Union Carbide & Carbon Corp., 30 E. 42nd St., New York 17, N. Y.
- Borden Co., Chemical Div., 350 Madison Ave., New York 17, N. Y.
- Catalin Corp. of America, 1 Park Ave., New York 16, N. Y.
- CIBA CO., INC., 627 Greenwich St., New York 14, N. Y. ADV. PG. 276.
- Dolph Co., John C., Monmouth Junction, N. J.
- Du Pont de Nemours & Co., Inc., E. I., Wilmington, Del.
- FLOCK PROCESS CO., INC., 28 Fahey St., Springdale, Conn. ADV. PG. 196.
- General Cement Mfg. Co., 919 Taylor Ave., Rockford, Ill.
- Houghton Laboratories, Inc., 322 Bush St., Olean, N. Y.
- Maas & Waldstein Co., 438 Riverside Ave., Newark 4, N. J.
- Marblette Corp., 37-21 30th St., Long Island City, N. Y.
- Marbon Corp., Gary, Ind.
- Minnesota Mining & Mfg Co., 900 Fauquier Ave., St. Paul 6, Minn.
- Paisley Products, Inc., 1770 Canalport Ave., Chicago 16, Ill.
- Philadelphia Quartz Co., Public Ledger Bldg., Philadelphia 6, Pa.
- Plaskon Division, Libbey-Owens-Ford Glass Co., 2112-24 Sylvan Ave., Toledo 6, Ohio.
- Reichhold Chemicals, Inc., 601-707 Woodward Heights Blvd., Detroit 20, Mich.
- Sauereison Cements Co., Sauereison Bldg., Pittsburgh 15, Pa.
- Schott Co., Walter L., 3225 Exposition Pl., Los Angeles 18, Calif.
- Union Bay State Chemical Co., Cambridge, Mass.

V indicates . . . IN PRODUCTION • AVAILABILITY • UNRESTRICTED FOR GENERAL USE

- Ⓞ U. S. Rubber Co., 1230 Avenue of the Americas, New York 20, N. Y.
- Ⓞ United Technical Laboratories, Box 425-W, Morristown, N. J.
- Ⓞ ZOPHAR MILLS, INC., 112-130 26th St., Brooklyn 32, N. Y. ADV. PG. 397.

ADHESIVES—Waterproof & Corrosion Proof Compounds

- Ⓞ AMERICAN PHENOLIC CORP., 1830 S. 54th Ave., Chicago 50, Ill. ADV. PG. 61.
- Ⓞ Armstrong Cork Co., Lancaster, Pa.
- Ⓞ Borden Co., Chemical Div., 350 Madison Ave., New York 17, N. Y.
- Ⓞ du Pont de Nemours & Co., Inc., E. I., Wilmington, Del.
- Ⓞ Durez Plastics & Chemicals Inc., 1921 Walck Road, North Tonawanda, N. Y.
- Ⓞ Electro Chemical Engineering Co., 750 Broad St., Emmaus, Pa.
- Ⓞ FLOCK PROCESS CO., INC., 28 Fahey St., Springdale, Conn. ADV. PG. 196.
- Ⓞ General Cement Mfg. Co., 919 Taylor Ave., Rockford, Ill.
- Ⓞ Goodyear Tire & Rubber Co., Inc., Chemical Div., 1144 E. Market St., Akron 16, Ohio.
- Ⓞ INSL-X CO., INC., Water St., Ossining, N. Y. ADV. PG. 386.
- Ⓞ Insulatine Co., 1 Broadway, New York, N. Y.
- Ⓞ Koppers Co., Inc., Chemical Div., Koppers Bldg., Pittsburgh 19, Pa.
- Ⓞ Linick Chemical Co., 29 E. Madison St., Chicago 2, Ill.
- Ⓞ Marblette Corp., 37-21 30th St., Long Island City, N. Y.
- Ⓞ Minnesota Mining & Mfg. Co., 900 Fauquier Ave., St. Paul 6, Minn.
- Ⓞ Moyer, C. P., 908 Chicago Ave., Chicago, Ill.
- Ⓞ Paisley Products, Inc., 1770 Canalport Ave., Chicago 16, Ill.
- Ⓞ Sauereisen Cements Co., Sauereisen Bldg., Pittsburgh 15, Pa.
- Ⓞ Schott Co., Walter L., 3225 Exposition Pl., Los Angeles 18, Calif.
- Ⓞ Short Wave Plastic Forming Co., 2921 W. Alameda St., Burbank, Calif.
- Ⓞ Standard Telephones & Cables Ltd., Connaught House, Aldwych, London, W.C.2., England.
- Ⓞ Union Bay State Chemical Co., Cambridge, Mass.
- Ⓞ U. S. Rubber Co., 1230 Avenue of the Americas, New York 20, N. Y.
- Ⓞ Woodwelding, Inc., 3000 W. Olive Ave., Burbank, Calif.
- Ⓞ ZOPHAR MILLS, INC., 112-130 26th St., Brooklyn 32, N. Y. ADV. PG. 397.

ALARMS, Burglar

- Ⓞ Airlecton Inc., P. O. Box 151, Caldwell, N. J.
- Ⓞ BROWNING LABORATORIES, INC., 750 Main St., Winchester, Mass. ADV. PG. 257.
- Ⓞ De-Tec-Tronic Laboratories, Inc., 1711 Terra Cotta Pl., Chicago 14, Ill.
- Ⓞ Edwards Co., Inc., 86 Boston Post Rd., Norwalk, Conn.
- Ⓞ Electronic Control Corp., 1573 E. Forest St., Detroit, Mich.
- Ⓞ EL-TRONICS, INC., 2649 N. Howard St., Philadelphia 33, Pa. ADV. PG. 299.
- Ⓞ Industrial Electronics Co., Hanover, Mass.
- Ⓞ Photobell Company, 116 Nassau St., New York 7, N. Y.
- Ⓞ Photoswitch, Inc., 77 Broadway, Cambridge 42, Mass.
- Ⓞ Ripley Co., Inc., Middletown, Conn.
- Ⓞ Worner Electronic Devices, Rankin, Ill.

ALPHA RAY SOURCES

See Isotopes

ALUMINUM OXIDE

See Insulation Materials

AMMETERS

See also Microammeters
Micro-Microammeters
Milliammeters

- Ⓞ Assembly Products, Inc., Chagrin Falls 6, Ohio.
- Ⓞ Associated Research Inc., 3758 W. Belmont, Chicago 18, Ill.
- Ⓞ Beede Electrical Instrument Co., Inc., Penacook, N. H.
- Ⓞ Bristol Co., The, Waterbury 20, Conn.
- Ⓞ Burlington Instrument Co., Burlington, Iowa.
- Ⓞ Cole Instrument Co. 1320 S. Grand Ave., Los Angeles 15, Calif.
- Ⓞ Columbia Electric Mfg. Co., 4519 Hamilton Ave., N. E., Cleveland 14, Ohio.
- Ⓞ DEJUR-AMSCO CORP., Northern Blvd., at 45th St., Long Island City 1, N. Y. ADV. PG. 377.
- Ⓞ Electric Design & Mfg. Corp., Burlington, Iowa.
- Ⓞ Electro-Mechanical Instrument Co., 812 Chestnut St., Perkasie, Pa.

- Ⓞ Esterline-Angus Co., Inc., P. O. Box 596, Indianapolis 6, Ind.
- Ⓞ Fluke Engineering Co., John, Box 755, Springdale, Conn.
- Ⓞ GENERAL ELECTRIC CO., Schenectady 5, N. Y. ADV. PG. 1-22.
- Ⓞ HICKOK ELECTRICAL INSTRUMENT CO., 10514 Dupont Ave., Cleveland 8, Ohio. ADV. PG. 333.
- Ⓞ Industrial Devices, Inc., 22 State Rd., Edgewater, N. J.
- Ⓞ INTERNATIONAL INSTRUMENTS INC., 331 East St., New Haven 11, Conn. ADV. PG. 322.
- Ⓞ MARION ELECTRICAL INSTRUMENT CO., Manchester, N. H. ADV. PG. 200.
- Ⓞ Meters, Inc., 915 Westfield Blvd., Indianapolis 20, Ind.
- Ⓞ Oak Ridge Products Mfg. Div. of Video Television, Inc., 37-01 Vernon Blvd., Long Island City 1, N. Y.
- Ⓞ Pyramid Instrument Corp., 49 Howard St., New York, N. Y.
- Ⓞ Rawson Electrical Instrument Co., 111 Potter St., Cambridge 42, Mass.
- Ⓞ Reliance Instrument Co., 3027 W. Van Buren St., Chicago 12, Ill.
- Ⓞ Sensitive Research Instrument Corp., 9 Elm Ave., Mt. Vernon, N. Y.
- Ⓞ SHURITE METERS, 35-B Hamilton St., New Haven 8, Conn. ADV. PG. 390.
- Ⓞ Simpson Electric Co., Div. of American Gage & Machine Co., 5218 W. Kinzie St., Chicago 44, Ill.
- Ⓞ Sterling Mfg Co., 9205 Detroit Ave., Cleveland 2, Ohio.
- Ⓞ Triumph Mfg. Co., 913 W. Van Buren St., Chicago 7, Ill.
- Ⓞ U. S. Gauge Div., American Machine & Metals, Inc., Sellersville, Pa.
- Ⓞ Welch Scientific Co., W. M., 1515 Sedgwick St., Chicago 10, Ill.
- Ⓞ WESTINGHOUSE ELECTRIC CORP., 511 Wood St., P. O. Box 868, Pittsburgh 30, Pa. ADV. PG. 107-113.
- Ⓞ WESTON ELECTRICAL INSTRUMENT CORP., 595 Frelinghuysen Ave., Newark 5, N. J. ADV. PG. 243.

AMMETERS—r-f

- Ⓞ Assembly Products, Inc., Chagrin Falls 6, Ohio.
- Ⓞ Burlington Instrument Co., Burlington, Iowa.
- Ⓞ Cole Instrument Co., 1320 S. Grand Ave., Los Angeles 15, Calif.
- Ⓞ GENERAL ELECTRIC CO., Schenectady, 5, N. Y. ADV. PG. 1-22.
- Ⓞ HICKOK ELECTRICAL INSTRUMENT CO., 10514 Dupont Ave., Cleveland 8, Ohio. ADV. PG. 333.
- Ⓞ Meters, Inc., 915 Westfield Blvd., Indianapolis 20, Ind.
- Ⓞ Sensitive Research Instrument Corp., 9 Elm Ave., Mt. Vernon, N. Y.
- Ⓞ Simpson Electric Co., Div. of American Gage & Machine Co., 5218 W. Kinzie St., Chicago 44, Ill.
- Ⓞ WESTINGHOUSE ELECTRIC CORP., 511 Wood St., P. O. Box 868, Pittsburgh 30, Pa. ADV. PG. 107-113.
- Ⓞ WESTON ELECTRICAL INSTRUMENT CORP., 595 Frelinghuysen Ave., Newark 5, N. J. ADV. PG. 243.

AMPLIFIERS—Audio Frequency

- Ⓞ AIR ASSOCIATES, INC., Teterboro, N. J. ADV. PG. 211.
- Ⓞ ALLIED RADIO CORP., 833 W. Jackson Blvd., Chicago 7, Ill. ADV. PG. 238.
- Ⓞ Aitec Lansing Corp., 9356 Santa Monica Blvd., Beverly Hills, Calif.
- Ⓞ AMERICAN ELECTRONEERING CORP., 5025-29 W. Jefferson Blvd., Los Angeles 16, Calif. ADV. PG. 136.
- Ⓞ Amplifier Corp. of America, 398 Broadway, New York 13, N. Y.
- Ⓞ Ansley Mfg. Co., Arthur, Doylestown, Pa.
- Ⓞ Antenna Research Lab., Inc., 797 Thomas Lane, Columbus 14, Ohio.
- Ⓞ Approved Electronic Instrument Corp., 142 Liberty St., New York 6, N. Y.
- Ⓞ Arlington Electric Products, Inc., 500 W. 52nd St., New York 19, N. Y.
- Ⓞ Audio Instrument Co., 133 W. 14th St., New York 11, N. Y.
- Ⓞ BARKER & WILLIAMSON, 235 Fairfield Ave., Upper Darby, Pa. ADV. PG. 292.
- Ⓞ Bell Sound Systems, Inc., 555 Marion Rd., Columbus 7, Ohio.
- Ⓞ Berkeley Custom Electronics, 2571 Shattuck Ave., Berkeley, Calif.
- Ⓞ Berndt-Bach Inc., 7373 Beverly Blvd., Los Angeles 36, Calif.
- Ⓞ Bogen Co., Inc., David, 663 Broadway, New York 12, N. Y.
- Ⓞ Breico Electronics Corp., 55 Vandam St., New York 13, N. Y.
- Ⓞ Brook Electronic, Inc., Box 491, Elizabeth, N. J.
- Ⓞ BROWNING LABORATORIES, INC., 750 Main St., Winchester, Mass. ADV. PG. 257.
- Ⓞ Bunnell & Co., J. H., 81 Prospect St., Brooklyn, N. Y.
- Ⓞ CINEMA ENGINEERING CO., 1510 W. Verdugo Ave., Burbank, Calif. ADV. PG. 204.

- Ⓞ Collins Audio Products Co., P. O. Box 368, Westfield, N. J.
- Ⓞ Collins Radio Co., Cedar Rapids, Iowa.
- Ⓞ Cook Laboratories, 139 Gordon Blvd., Floral Park, N. Y.
- Ⓞ Coronet Radio & Television Corp., 500 W. 52nd St., New York 19, N. Y.
- Ⓞ Cossor (Canada) Ltd., 301-303 Windsor St., Halifax, N. S., Canada.
- Ⓞ Coulter Electronics, 3123 W. Fulton St., Chicago 12, Ill.
- Ⓞ Custom Craft Mfg. Co., 256 E. 98th St., Brooklyn, N. Y.
- Ⓞ Eckstein Radio & Television Co., 3400 E. 42nd St., Minneapolis 6, Minn.
- Ⓞ EDIN CO., INC., 207 Main St., Worcester, Mass. ADV. PG. 285.
- Ⓞ Edwards Co., Inc., 86 Boston Post Rd., Norwalk, Conn.
- Ⓞ Electro Engineering & Mfg. Co., 627 W. Alexandrine Ave., Detroit 1, Mich.
- Ⓞ ELECTRO PRODUCTS LABS., 4501 N. Ravenswood Ave., Chicago 40, Ill. ADV. PG. 199.
- Ⓞ Electronic Development Lab., 43-07 23rd Ave., Long Island City 5, N. Y.
- Ⓞ ELECTRONIC INSTRUMENT CO., INC., 276 Newport St., Brooklyn 12, N. Y. ADV. PG. 129.
- Ⓞ Elm Laboratories, 18 South Broadway, Dobbs Ferry, N. Y.
- Ⓞ EL-TRONICS, INC., 2649 N. Howard St., Philadelphia 33, Pa. ADV. PG. 299.
- Ⓞ Espey Mfg. Co., Inc., 528 E. 72nd St., New York 19, N. Y.
- Ⓞ Fairchild Recording Equipment Corp., 154th St. & 7th Ave., Whitestone, N. Y.
- Ⓞ Feller Engineering Co., 8026 Monticello Ave., Skokie, Ill.
- Ⓞ Ferrar Radio & Television Corp., 55 W. 26th St., New York 10, N. Y.
- Ⓞ Fidelity Amplifier Co., 703 Willow St., Chicago 14, Ill.
- Ⓞ Fisher Radio Corp., 41 East 47th St., New York, N. Y.
- Ⓞ FREED TRANSFORMER CO., INC., 1736 Weirfield St., Brooklyn 27, N. Y. ADV. PG. 149.
- Ⓞ Furst Electronics, 10 S. Jefferson St., Chicago, Ill.
- Ⓞ Galbraith & Son C. C., 450 Sixth Ave., New York 11, N. Y.
- Ⓞ Gale-Dorothea Mechanisms, 37-61 85th St., Jackson Heights, N. Y.
- Ⓞ Gates Radio Co., Quincy, Ill.
- Ⓞ Gaveco Labs., Inc., 2 East End Ave., New York 21, N. Y.
- Ⓞ GENERAL RADIO CO., 275 Massachusetts Ave., Cambridge 39, Mass. ADV. PG. 48, 49.
- Ⓞ Gertsch Products, Inc., 11846 Mississippi Ave., Los Angeles 25, Calif.
- Ⓞ Hart Associates, 8430 Grand River, Detroit 4, Mich.
- Ⓞ Hartley Co., Ltd., H. A., 152 Hammersmith Rd., London W. 6, England.
- Ⓞ HEATH CO., Benton Harbor, Mich. ADV. PG. 264.
- Ⓞ HEWLETT-PACKARD CO., 395 Page Mill Rd., Palo Alto, Calif. ADV. PG. 33-36.
- Ⓞ HIGHLAND ENGINEERING CO., Main St. & Urban Ave., Westbury, N. Y. ADV. PG. 360.
- Ⓞ Hose McCann Telephone Co., Inc., 25th St. & 3rd Ave., Brooklyn 32, N. Y.
- Ⓞ Kalbfell Labs. Inc., 1076 Morena Blvd., San Diego 10, Calif.
- Ⓞ KEITHLEY INSTRUMENTS, 1507 Warrensville Center Rd., Cleveland 21, Ohio. ADV. PG. 337.
- Ⓞ LANGEVIN MANUFACTURING CORP., 37 W. 65th St., New York 23, N. Y. ADV. PG. 348.
- Ⓞ Lear, Inc., 110 Ionia Ave., N. W., Grand Rapids 2, Mich.
- Ⓞ Loral Electronics Corp., 794 E. 140th St., New York 54, N. Y.
- Ⓞ MCINTOSH ENGINEERING LABORATORY, INC., 320 Water St., Binghamton, N. Y. ADV. PG. 148.
- Ⓞ McMurdo Silver Co., Inc., 417 Lafayette St., New York, N. Y.
- Ⓞ M. P. Concert Installations, Fairfield 10, Conn.
- Ⓞ Magna Electronics Co., 3707-11 W. Jefferson Blvd., Los Angeles 16, Calif.
- Ⓞ Malco Co., Inc., 21 N. 3rd St., Minneapolis, Minn.
- Ⓞ Maurer Inc., J. A., 37-01 31st St., Long Island City, N. Y.
- Ⓞ MEASUREMENTS CORP., Boonton, N. J. ADV. PG. 99.
- Ⓞ Mellaphone Corp., Rochester 2, N. Y.
- Ⓞ Midwestern Geophysical Laboratory, 3400 S. Harvard, Tulsa, Okla.
- Ⓞ MILES REPRODUCER CO., INC., 812 Broadway, New York 3, N. Y. ADV. PG. 322.
- Ⓞ Minnesota Electronics Corp., 47 W. Water St., St. Paul 1, Minn.
- Ⓞ Monarch Radio & Television Corp., 2430 Atlantic Ave., Brooklyn 33, N. Y.
- Ⓞ Multiple Television Mfg. Co., 987 Hegeman Ave., Brooklyn 8, N. Y.
- Ⓞ National Intercommunicating Systems, 1130 N. Michigan Ave., Chicago 22, Ill.
- Ⓞ Network Mfg. Corp., Bayonne, N. J.
- Ⓞ Newcomb Audio Products Co., 6824 Lexington Ave., Hollywood 38, Calif.
- Ⓞ New London Instrument Co., Box 189, New London, Conn.
- Ⓞ Northeastern Engineering, Inc., Manchester, N. H.
- Ⓞ NORTHERN RADIO CO., INC., 143-145 W. 22nd St., New York 11, N. Y. ADV. PG. 262, 263.
- Ⓞ Operadio Mfg. Co., 135th & Indiana Sts., St. Charles, Ill.

Ⓢ indicates . . . IN PRODUCTION • AVAILABILITY • UNRESTRICTED FOR GENERAL USE

Ⓢ ORTHON CORP., 196 Albion Ave., Paterson 2, N. J. ADV. PG. 156.
 Ⓢ Peerless Instrument Co., 90-15 Corona Ave., Elmhurst, N. Y.
 Ⓢ PICKERING & CO., 309 Woods Ave., Oceanside, L. I., N. Y. ADV. PG. 284.
 Ⓢ Precision Electronics, Inc., 643 Milwaukee Ave., Chicago 22, Ill.
 Ⓢ Press Wireless Mfg. Co., Inc., Cantiague Rd., Hicksville, N. Y.
 Ⓢ PRESTO RECORDING CORP., Paramus, N. J. ADV. PG. 52, 53.
 Ⓢ RADIO CORP. OF AMERICA, RCA Victor Div., General Offices, Camden, N. J. ADV. PG. 177, Inside Back & Back Covers.
 Ⓢ Radio Craftsman, Inc., 1341 S. Michigan Ave., Chicago 5, Ill.
 Ⓢ Rauland-Borg Corp., 3523 W. Addison St., Chicago 18, Ill.
 Ⓢ Remler Co., Ltd., 2101 Bryant St., San Francisco 10, Calif.
 Ⓢ Sargent-Raymont Co., 212 Ninth St., Oakland 7, Cal.
 Ⓢ Schuttig & Co., Inc., 9th & Kearney Sts., NE, Washington 17, D. C.
 Ⓢ Scott, Inc., Herman Hosmer, 385 Putnam Ave., Cambridge 39, Mass.
 Ⓢ Shevers, Inc., Harold, 123 W. 64th St., New York 23, N. Y.
 Ⓢ Simpson Mfg. Co., Inc., Mark, 32-28 49th St., Long Island City 3, N. Y.
 Ⓢ Sonic Industries Inc., 221 W. 17th St., New York 11, N. Y.
 Ⓢ Southwestern Industrial Electronics Co., 2831 Post Oak Rd., P.O. Box 13058, Houston 19, Texas.
 Ⓢ Special Products Co., Silver Spring, Md.
 Ⓢ Stancil-Hoffman Corp., 1016 N. Highland Ave., Hollywood 38, Calif.
 Ⓢ Standard Electronics Corp., 25 W. 43rd St., New York 18, N. Y.
 Ⓢ Standard Electronics Research Corp., 2 East End Ave., New York 21, N. Y.
 Ⓢ Standard Telephones & Cables Ltd., Connaught House, Aldwych, London, W. C. 2, England.
 Ⓢ Talk-A-Phone Co., 1512 S. Pulaski Rd., Chicago 23, Ill.
 Ⓢ Tech Laboratories, Inc., Bergen & Edsall Blvds., Palisades Park, N. J.
 Ⓢ Technical Materiel Corp., P.O. Box 142, 121 Spencer Place, Mamaroneck, N. Y.
 Ⓢ Technology Instrument Corp., 531 Main St., Acton, Mass.
 Telephonics Corp., Park Ave., Huntington, N. Y.
 Ⓢ Thordarson-Meissner Mfg. Div., 500 W. Huron St., Chicago 10, Ill.
 Ⓢ TRAD TELEVISION CORP., 1001 First Ave., Asbury Park, N. J. ADV. PG. 355.
 Transmitter Equipment Mfg. Co., Inc., 345 Hudson St., New York 14, N. Y.
 Ⓢ UNITED TRANSFORMER CO., 150 Varick St., New York 13, N. Y. ADV. PG. Inside Front Cover.
 Universal Audio Equipment, Inc., 6035 Northwest Highway, Chicago 31, Ill.
 Video Corp. of America, 229 W. 28th St., New York 1, N. Y.
 Ⓢ Waveforms, Inc., 333 Sixth Ave., New York 14, N. Y.
 Ⓢ Webster Electric Co., 1900 Clark St., Racine, Wis.
 Ⓢ Western Electro-Acoustic Labs., 204 S. Beverly Drive, Beverly Hills, Calif.
 Ⓢ Western Sound & Electric Labs., Inc., 805 S. 5th St., Milwaukee 4, Wis.

AMPLIFIERS—Audio Input Systems

Ⓢ Altec Lansing Corp., 9356 Santa Monica Blvd., Beverly Hills, Calif.
 Ⓢ AMERICAN ELECTRONEERING CORP., 5025-29 W. Jefferson Blvd., Los Angeles 16, Calif. ADV. PG. 136.
 Ⓢ Arlington Electric Products, Inc., 500 W. 52nd St., New York 19, N. Y.
 Ⓢ BARKER & WILLIAMSON, 235 Fairchild Ave., Upper Darby, Pa. ADV. PG. 292.
 Ⓢ Berkeley Custom Electronics, 2571 Shattuck Ave., Berkeley, Calif.
 Ⓢ Berndt-Bach, Inc., 7373 Beverly Blvd., Los Angeles 36, Calif.
 Ⓢ Bogen Co., Inc., David, 663 Broadway, New York 12, N. Y.
 Bunnell & Co., J. H., 81 Prospect St., Brooklyn, N. Y.
 Ⓢ CINEMA ENGINEERING CO., 1510 W. Verdugo Ave., Burbank, Calif. ADV. PG. 204.
 Ⓢ Collins Audio Products Co., P.O. Box 368, Westfield, N. J.
 Ⓢ Collins Radio Co., Cedar Rapids, Iowa.
 Ⓢ Communications Co., Inc., 300 Greco Ave., Coral Gables 34, Fla.
 Ⓢ Cossor (Canada), Ltd., 301-303 Windsor St., Halifax, N. S., Canada.
 Ⓢ Edwards Co., Inc., 86 Boston Post Rd., Norwalk, Conn.
 Ⓢ Electronic Development Lab., 43-07 23rd Ave., Long Island City 5, N. Y.
 Ⓢ Fairchild Recording Equipment Corp., 154th St. & 7th Ave., Whitestone, N. Y.
 Ⓢ FREED TRANSFORMER CO., INC., 1736 Weirfield St., Brooklyn 27, N. Y. ADV. PG. 149.
 Ⓢ Gates Radio Co., Quincy, Ill.
 Ⓢ Godfrey Mfg. Co., 171 S. 2nd St., Milwaukee 4, Wis.
 Ⓢ Hartley Co., Ltd., H. A., 152 Hammersmith Rd., London W. 6, England.

Hose-McCann Telephone Co., Inc., 25th St. & 3rd Ave., Brooklyn 32, N. Y.
 Ⓢ Kalbfell Labs., Inc., 1076 Morena Blvd., San Diego 10, Calif.
 Ⓢ LANGEVIN MANUFACTURING CORP., 37 W. 65th St., New York 23, N. Y. ADV. PG. 348.
 Ⓢ Lear, Inc., 110 Ionia Ave., NW, Grand Rapids 2, Mich.
 Ⓢ McINTOSH ENGINEERING LABORATORY, INC., 320 Water St., Binghamton, N. Y. ADV. PG. 148.
 Ⓢ McMurdo Silver Co., Inc., 417 Lafayette St., New York, N. Y.
 M. P. Concert Installations, Fairfield 10, Conn.
 Ⓢ Midwestern Geophysical Laboratory, 3400 S. Harvard, Tulsa, Okla.
 Ⓢ MILES REPRODUCER CO., INC., 812 Broadway, New York 3, N. Y. ADV. PG. 322.
 Ⓢ Minnesota Electronics Corp., 47 W. Water St., St. Paul 1, Minn.
 Ⓢ Monarch Radio & Television Corp., 2430 Atlantic Ave., Brooklyn 33, N. Y.
 Ⓢ Multiple Television Mfg. Co., 987 Hegeman Ave., Brooklyn 8, N. Y.
 Ⓢ Newcomb Audio Products Co., 6824 Lexington Ave., Hollywood 38, Calif.
 Ⓢ Pentron Corp., 221 E. Cullerton St., Chicago 16, Ill.
 Ⓢ Pfanstiehl Chemical Co., Metallurgical Div., 104 Lake View Ave., Waukegan, Ill.
 Ⓢ PICKERING & CO., 309 Woods Ave., Oceanside, L. I., N. Y. ADV. PG. 284.
 Ⓢ Precision Electronics, Inc., 643 Milwaukee Ave., Chicago 22, Ill.
 Ⓢ Press Wireless Mfg. Co., Inc., Cantiague Rd., Hicksville, N. Y.
 Ⓢ RADIO CORP OF AMERICA, RCA Victor Div., General Offices, Camden, N. J. ADV. PG. 177, Inside Back & Back Covers.
 Ⓢ Rauland-Borg Corp., 3523 W. Addison St., Chicago 18, Ill.
 Ⓢ Remler Co., Ltd., 2101 Bryant St., San Francisco 10, Calif.
 Ⓢ Shevers, Inc., Harold, 123 W. 64th St., New York 23, N. Y.
 Ⓢ Simpson Mfg. Co., Inc., Mark, 32-28 49th St., Long Island City 3, N. Y.
 Ⓢ Stancil-Hoffman Corp., 1016 N. Highland Ave., Hollywood 38, Calif.
 Ⓢ Standard Electronics Corp., 25 W. 43rd St., New York 18, N. Y.
 Ⓢ Standard Telephones & Cables Ltd., Connaught House, Aldwych, London, W. C. 2, England.
 Ⓢ Thordarson-Meissner Mfg. Div., 500 W. Huron St., Chicago 10, Ill.
 Ⓢ TRAD TELEVISION CORP., 1001 First Ave., Asbury Park, N. J. ADV. PG. 355.
 Transmitter Equipment Mfg. Co., Inc., 345 Hudson St., New York 14, N. Y.
 Universal Audio Equipment, Inc., 6035 Northwest Highway, Chicago 31, Ill.
 Ⓢ Waveforms, Inc., 333 Sixth Ave., New York 14, N. Y.
 Ⓢ Western Sound & Electric Labs., Inc., 805 S. 5th St., Milwaukee 4, Wis.

AMPLIFIERS—Audio Subminiature

Ⓢ AMERICAN ELECTRONEERING CORP., 5025-29 W. Jefferson Blvd., Los Angeles 16, Calif. ADV. PG. 136.
 Ⓢ Atlantic Electronics, 4 Manhasset Ave., Manhasset, N. Y.
 Ⓢ Audio Instrument Co., 133 W. 14th St., New York 11, N. Y.
 Ⓢ Aurex Corp., Chicago 10, Ill.
 Ⓢ Avion Instrument Corp., Paramus, N. J.
 Ⓢ Bendix Aviation Corp., Pacific Div., 11600 Sherman Way, North Hollywood, Calif.
 Ⓢ Berndt-Bach, Inc., 7373 Beverly Blvd., Los Angeles 36, Calif.
 Ⓢ Brociner Electronics Laboratory, 1546 Second Ave., New York 28, N. Y.
 Ⓢ Custom Craft Mfg. Co., 256 E. 98th St., Brooklyn, N. Y.
 Elm Laboratories, 18 South Broadway, Dobbs Ferry, N. Y.
 Ⓢ Lincophone Co., Inc., 226 Lansing St., Utica, N. Y.
 Ⓢ Loge Sound Engineers, J. M., 2171 W. Washington Blvd., Los Angeles 7, Calif.
 M. P. Concert Installations, Fairfield 10, Conn.
 Ⓢ Magna Electronics Co., 3707-11 W. Jefferson Blvd., Los Angeles 16, Calif.
 Ⓢ Maico Co., Inc., 21 N. 3rd St., Minneapolis, Minn.
 Ⓢ Melpar, Inc., 552 Swann Ave., Alexandria, Va.
 Ⓢ Midwestern Geophysical Laboratory, 3400 S. Harvard, Tulsa, Okla.
 Ⓢ MILES REPRODUCER CO., INC., 812 Broadway, New York 3, N. Y. ADV. PG. 322.
 Ⓢ Molded Insulation Co., 335 E. Price St., Philadelphia 44, Pa.
 Ⓢ Multiple Television Mfg. Co., 987 Hegeman Ave., Brooklyn 8, N. Y.
 Ⓢ ORTHON CORP., 196 Albion Ave., Paterson 2, N. J. ADV. PG. 156.
 Ⓢ Plastics & Electronics Co., Inc., P.O. Box 38, Station J, Buffalo 8, N. Y.
 Ⓢ Remler Co., Ltd., 2101 Bryant St., San Francisco, Calif.
 Ⓢ Stancil-Hoffman Corp., 1016 N. Highland Ave., Hollywood 38, Calif.
 Ⓢ Thordarson-Meissner Mfg. Div., 500 W. Huron St., Chicago 10, Ill.

Transmitter Equipment Mfg. Co., Inc., 345 Hudson St., New York 14, N. Y.
 Ⓢ Walkirt Co., 5808 Marilyn Ave., Culver City, Calif.

AMPLIFIERS—d-c

Ⓢ ADVANCE ELECTRONICS CO., 451 Highland Ave., Passaic, N. J. ADV. PG. 224.
 Ⓢ AIRMEC LABORATORIES LTD., 366 Madison Ave., New York 17, N. Y. ADV. PG. 336.
 Ⓢ AIRPAX PRODUCTS CO., Middle River, Baltimore 20, Md. ADV. PG. 289.
 Ⓢ AMERICAN ELECTRONEERING CORP., 5025-29 W. Jefferson Blvd., Los Angeles 16, Calif. ADV. PG. 136.
 Ⓢ Audio Instrument Co., 133 W. 14th St., New York 11, N. Y.
 Ⓢ Avion Instrument Corp., Paramus, N. J.
 Ⓢ BARKER & WILLIAMSON, 235 Fairchild Ave., Upper Darby, Pa. ADV. PG. 292.
 Ⓢ BRUSH DEVELOPMENT CO., 3405 Perkins Ave., Cleveland 14, Ohio. ADV. PG. 228, 229.
 Ⓢ Caltron Co., 1406 S. Hobart Blvd., Los Angeles 6, Calif.
 Ⓢ Collins Radio Co., Cedar Rapids, Iowa.
 Ⓢ Computer Corp. of America, 149 Church St., New York, N. Y.
 Ⓢ Cossor (Canada), Ltd., 301-303 Windsor St., Halifax, N. S., Canada.
 Ⓢ Davies Laboratories, Inc., 4705 Queensbury Rd., Riverdale, Md.
 Ⓢ DuMont Laboratories, Inc., Allen B., Instrument Div., 1000 Main Ave., Clifton, N. J.
 Ⓢ EDIN CO., INC., 207 Main St., Worcester, Mass. ADV. PG. 285.
 Ⓢ Edwards Co., Inc., 86 Boston Post Rd., Norwalk, Conn.
 Ⓢ Electro-Mechanical Research, Inc., Ridgefield, Conn.
 Ⓢ Electronic Associates, Inc., Long Branch, N. J.
 Ⓢ ELECTRONIC TUBE CORP., 1200 E. Mermaid Ave., Philadelphia 18, Pa. ADV. PG. 335.
 Ⓢ EL-TRONICS, INC., 2649 N. Howard St., Philadelphia 33, Pa. ADV. PG. 299.
 Ⓢ Furst Electronics, 10 S. Jefferson St., Chicago 6, Ill.
 Ⓢ Gaveco Labs, Inc., 2 East End Ave., New York 21, N. Y.
 Ⓢ GENERAL ELECTRIC CO., Electronics Dept., Electronics Park, Syracuse, N. Y. ADV. PG. 1-22.
 Ⓢ GENERAL RADIO CO., 275 Massachusetts Ave., Cambridge 39, Mass. ADV. PG. 48, 49.
 Ⓢ Glenco Corp., Metuchen, N. J.
 Ⓢ Gulton Mfg. Corp., Metuchen, N. J.
 Ⓢ Hanover Developments, 401 E. 74th St., New York 21, N. Y.
 Ⓢ Hart Associates, 8430 Grand River, Detroit 4, Mich.
 Ⓢ Hathaway Instrument Co., 1315 S. Clarkson St., Denver 10, Colo.
 Ⓢ HEILAND RESEARCH CORP., 130 E. 5th Ave., Denver 9, Colo. ADV. PG. 401.
 Ⓢ HEINTZ & KAUFMAN EQUIPMENT DIV. OF THE ROBERT DOLLAR CO., 50 Drumm St., San Francisco 11, Calif. ADV. PG. 301.
 Ⓢ INDUSTRIAL CONTROL CO., Straight Path & Arlington Ave., Wyandanch, N. Y. ADV. PG. 130.
 Ⓢ Instrument Laboratories, 315 W. Walton Place, Chicago 10, Ill.
 Ⓢ Lear, Inc., 110 Ionia Ave., NW, Grand Rapids 2, Mich.
 Ⓢ Leeds & Northrup Co., 4970 Stenton Ave., Philadelphia 44, Pa.
 Ⓢ LISTON-FOLB INSTRUMENT CO., INC., 20 Beckley Ave., Stamford, Conn. ADV. PG. 276.
 Ⓢ Magna Electronics Co., 3707-11 W. Jefferson Blvd., Los Angeles 16, Calif.
 Ⓢ Manning, Maxwell & Moore, Inc., Stratford, Conn.
 Ⓢ MEASUREMENTS CORP., Boonton, N. J. ADV. PG. 99.
 Ⓢ Melpar, Inc., 552 Swann Ave., Alexandria, Va.
 Ⓢ Midwestern Geophysical Laboratory, 3400 S. Harvard, Tulsa, Okla.
 Ⓢ MILES REPRODUCER CO., INC., 812 Broadway, New York 3, N. Y. ADV. PG. 322.
 Ⓢ Miller Corp., Wm., 325 N. Halstead St., Pasadena 8, Calif.
 Ⓢ Oak Ridge Products Mfg. Div. of Video Television, Inc., 37-01 Vernon Blvd., Long Island City 1, N. Y.
 Ⓢ Offner Electronics, Inc., 5320 N. Kedzie Ave., Chicago 25, Ill.
 Ⓢ Perkin-Elmer Corp., Main Ave., Norwalk, Conn.
 Ⓢ Philbrick Researches, Inc., George A., 230 Congress St., Boston 10, Mass.
 Ⓢ Photron Instrument Co., 6516 Detroit Ave., Cleveland 2, Ohio.
 Process & Instruments, 60 Greenpoint Ave., Brooklyn 22, N. Y.
 Ⓢ RAHM INSTRUMENTS INC., 12 W. Broadway, New York 7, N. Y. ADV. PG. 354.
 Ⓢ SANBORN CO., 39 Osborn St., Cambridge 39, Mass. ADV. PG. 391.
 Ⓢ Shevers, Inc., Harold, 123 W. 64th St., New York 23, N. Y.
 Ⓢ Southwestern Industrial Electronics Co., 2831 Post Oak Rd., P. O. Box 13058, Houston 19, Texas.
 Ⓢ Standard Electronics Research Corp., 2 East End Ave., New York 21, N. Y.
 Ⓢ Stoddart Aircraft Radio Co., 6644 Santa Monica Blvd., Hollywood 38, Calif.
 Ⓢ Tektronix, Inc., 712 S. E. Hawthorne Blvd., Portland 14, Ore.
 Ⓢ Thordarson-Meissner Mfg. Div., 500 W. Huron St., Chicago 10, Ill.

V indicates . . . IN PRODUCTION • AVAILABILITY • UNRESTRICTED FOR GENERAL USE

V Vacuum-Electronic Engineering Co., 756 Third Ave., Brooklyn 32, N. Y.

AMPLIFIERS—Decade

- V**AMERICAN ELECTROENGINEERING CO., 5025-29 W. Jefferson Blvd., Los Angeles 16, Calif. ADV. PG. 136.
- V**BALLANTINE LABORATORIES, INC., Boonton, N. J. ADV. PG. 125.
- V**BARKER & WILLIAMSON, 235 Fairfield Ave., Upper Darby, Pa. ADV. PG. 292.
- V**Clarkstan Corp., 11921 S. W. Pico Blvd., Los Angeles 64, Calif.
- V**Davies Laboratories, Inc., 4705 Queensbury Rd., Riverdale, Md.
- V**Electro-Mechanical Research, Inc., Ridgefield, Conn.
- V**FREED TRANSFORMER CO., INC., 1736 Weirfield St., Brooklyn 27, N. Y. ADV. PG. 149.
- V**First Electronics, 10 S. Jefferson St., Chicago 6, Ill.
- V**HEWLETT-PACKARD CO., 395 Page Mill Rd., Palo Alto, Calif. ADV. PG. 33-36.
- V**INDUSTRIAL CONTROL CO., Straight Path & Arlington Ave., Wyandanch, N. Y. ADV. PG. 130.
- V**Kalbfell Labs. Inc., 1076 Morena Blvd., San Diego 10, Calif.
- V**KEITHLEY INSTRUMENTS, 1507 Warrensville Center Rd., Cleveland 21, Ohio. ADV. PG. 337.
- Loral Electronics Corp., 794 E. 140th St., New York 54, N. Y.
- M. P. Concert Installations, Fairfield 10, Conn.
- V**Midwestern Geophysical Laboratory, 3400 S. Harvard, Tulsa, Okla.
- V**Standard Electronics Research Corp., 2 East End Ave., New York 21, N. Y.
- V**Technology Instrument Corp., 531 Main St., Acton, Mass.
- V**Thordarson-Meissner Mfg. Divs., 500 W. Huron St., Chicago 10, Ill.

AMPLIFIERS—Differential

- V**AMERICAN ELECTROENGINEERING CORP., 5025-29 W. Jefferson Blvd., Los Angeles 16, Calif. ADV. PG. 136.
- V**ATOMIC INSTRUMENT CO., 84 Massachusetts Ave., Cambridge 39, Mass. ADV. PG. 410.
- V**Boehme, Inc., H. O., 915 Broadway, New York 10, N. Y.
- V**EDIN CO., INC., 207 Main St., Worcester, Mass. ADV. PG. 285.
- V**Hart Associates, 8430 Grand River, Detroit 4, Mich.
- V**Midwestern Geophysical Laboratory, 3400 S. Harvard, Tulsa, Okla.
- V**Multiple Television Mfg. Co., 987 Hegeman Ave., Brooklyn 8, N. Y.
- V**Owen Laboratories, 412 Woodward Blvd., Pasadena 10, Calif.
- Transmitter Equipment Mfg. Co., Inc., 345 Hudson St., New York 14, N. Y.
- V**Walkirt Co., 5808 Marlyn Ave., Culver City, Calif.

AMPLIFIERS—f-m & a-m Antenna

- V**BELLING & LEE LTD., 366 Madison Ave., New York 17, N. Y. ADV. PG. 336.
- V**Bendix Aviation Corp., Pacific Division, 11600 Sherman Way, North Hollywood, Calif.
- V**Brach Mfg. Corp., 200 Central Ave., Newark 4, N. J.
- V**Electro Engineering & Mfg. Co., 627 W. Alexandrine, Detroit 1, Mich.
- V**Electronic Indicator Corp., 259 Green St., Brooklyn 22, N. Y.
- V**Industrial Television, Inc., 359 Lexington Ave., Clifton, N. J.
- V**McMurdo Silver Co., Inc., 417 Lafayette St., New York, N. Y.
- V**Melpar, Inc., 552 Swann Ave., Alexandria, Va.
- Monroe Coil Co., 2839 Narragansett Ave., Chicago 34, Ill.
- V**RADIO CORP. OF AMERICA, RCA Victor Div., General Offices, Camden, N. J. ADV. PG. 177, Inside Back & Back Covers.
- V**TECHNICAL APPLIANCE CORP., Sherburne, N. Y. ADV. PG. 378.

AMPLIFIERS—Facsimile

- V**AIRMEC LABORATORIES LTD., 366 Madison Ave., New York 17, N. Y. ADV. PG. 336.
- V**ALDEN PRODUCTS CO., 117 No. Main St., Brockton 64, Mass. ADV. PG. 327.
- Bunnell & Co., J. H., 81 Prospect St., Brooklyn, N. Y.
- V**Hogan Laboratories, Inc., 155 Perry St., New York 14, N. Y.
- V**McElroy Mfg. Corp., Littleton, Mass.
- V**Multiple Television Mfg. Co., 987 Hegeman Ave., Brooklyn 8, N. Y.
- V**Press Wireless Mfg. Co., Inc., Cantigue Rd., Hicksville, N. Y.

AMPLIFIERS—Keying

- V**Boehme Inc., H. O., 915 Broadway, New York 10, N. Y.

- Bunnell & Co., J. H., 81 Prospect St., Brooklyn, N. Y.
- Erco Radio Labs., Inc., E. Stewart Ave., Garden City, N. Y.
- V**Gates Radio Co., Quincy, Ill.
- V**HEINTZ & KAUFMAN EQUIPMENT DIV. OF THE ROBERT DOLLAR CO., 50 Drumm St., San Francisco 11, Calif. ADV. PG. 301.
- V**McElroy Mfg. Corp., Littleton, Mass.
- V**Monarch Radio & Television Corp., 2430 Atlantic Ave., Brooklyn 33, N. Y.
- V**Multiple Television Mfg. Co., 987 Hegeman Ave., Brooklyn 8, N. Y.
- V**Press Wireless Mfg. Co., Inc., Cantigue Rd., Hicksville, N. Y.
- V**Remler Co., Ltd., 2101 Bryant St., San Francisco 10, Calif.
- V**Schuttig & Co., Inc., 9th & Kearney Sts., NE, Washington 17, D. C.
- V**Technical Materiel Corp., P. O. Box 142, 121 Spencer Place, Mamaroneck, N. Y.
- V**Telechrome, Inc., 88 Merrick Rd., Amityville, N. Y.
- V**TRAD TELEVISION CORP., 1001 First Ave., Asbury Park, N. J. ADV. PG. 355.

AMPLIFIERS—Logarithmic

- V**Antenna Research Lab., Inc., 797 Thomas Lane, Columbus 14, Ohio.
- V**Audio Instrument Co., 133 W. 14th St., New York 11, N. Y.
- V**Hart Associates, 8430 Grand River, Detroit 4, Mich.
- V**Kalbfell Labs., Inc., 1076 Morena Blvd., San Diego 10, Calif.
- V**Multiple Television Mfg. Co., 987 Hegeman Ave., Brooklyn 8, N. Y.

AMPLIFIERS—Magnetic

- V**ACME ELECTRONICS, INC., 300 N. Lake Ave., Pasadena 4, Calif. ADV. PG. 182.
- V**AIRPAX PRODUCTS CO., Middle River, Baltimore 20, Md. ADV. PG. 289.
- V**Atlantic Electronics, 4 Manhasset Ave., Manhasset, N. Y.
- V**BOGUE ELECTRIC MFG. CO., 52 Iowa Ave., Paterson 3, N. J. ADV. PG. 155.
- V**DIETZ DESIGN & MFG. CO., Grandview 6, Mo. ADV. PG. 323.
- Electrolic Transformer Co., Westerly Rd., Ossining, N. Y.
- V**FERRANTI ELECTRIC, INC., 30 Rockefeller Plaza, New York 20, N. Y. ADV. PG. 159.
- V**FREED TRANSFORMER CO., INC., 1736 Weirfield St., Brooklyn 27, N. Y. ADV. PG. 149.
- V**Gaveco Labs., Inc., 2 East End Ave., New York 21, N. Y.
- V**GENERAL ELECTRIC CO., Schenectady 5, N. Y. ADV. PG. 1-22.
- V**Hycor Co., Inc., 11423 Vanowen St., North Hollywood, Calif.
- V**Inet, Inc., 8655 S. Main St., Los Angeles 3, Calif.
- V**Macdonald Co., Inc., W.S., 33 University Rd., Cambridge 38, Mass.
- V**Magnatran Incorporated, Kearney, N. J.
- V**MAGNETIC APPLIFIERS, INC., 1154 44th Drive, Long Island City 1, N. Y. ADV. PG. 346.
- V**Magnetics Inc., 135 Bloomfield Ave., Bloomfield, N. J.
- V**MAGNETICS, INC., Box 761, Butler, Pa. ADV. PG. 381.
- V**Maurer Inc., J. A., 37-01 31st St., Long Island City, N. Y.
- V**Miller Corp., Wm., 325 N. Halstead St., Pasadena 8, Calif.
- V**Multiple Television Mfg. Co., 987 Hegeman Ave., Brooklyn 8, N. Y.
- V**Pentron Corp., 221 E. Cullerton St., Chicago 16, Ill.
- V**SERVO CORP. OF AMERICA, 20-20 Jericho Turnpike, New Hyde Park, N. Y. ADV. PG. 150, 151.
- V**SPERRY GYROSCOPE DIV. OF THE SPERRY CORP., Great Neck, N. Y. ADV. PG. 103, 104.
- V**Thordarson-Meissner Mfg. Divs., 500 W. Huron St., Chicago 10, Ill.
- V**Trans-Sonics, Inc., Bedford Airport, Bedford, Mass.
- V**UNITED TRANSFORMER CO., 150 Varick St., New York 13, N. Y. ADV. PG. Inside Front Cover.
- V**Vickers Electric Div., Vickers, Inc., 1815 Locust St., St. Louis 3, Mo.
- V**WESTINGHOUSE ELECTRIC CORP., 511 Wood St., P. O. Box 868, Pittsburgh 30, Pa. ADV. PG. 107-113.

AMPLIFIERS—Medical Instrument

- V**ATOMIC INSTRUMENT CO., 84 Massachusetts Ave., Cambridge 39, Mass. ADV. PG. 410.
- V**BRUSH DEVELOPMENT CO., 3405 Perkins Ave., Cleveland 14, Ohio. ADV. PG. 228, 229.
- V**Century Geophysical Corp., 1333 N. Utica, Tulsa 3, Okla.
- V**Cossor (Canada) Ltd., 301-303 Windsor St., Halifax, N. S., Canada.
- V**Coulter Electronics, 3123 W. Fulton St., Chicago 12, Ill.
- Dallons Labs., 5066 Santa Monica Blvd., Los Angeles, Calif.

- V**EDIN CO., INC., 207 Main St., Worcester, Mass. ADV. PG. 285.
- V**Electro-Mechanical Research, Inc., Ridgefield, Conn.
- V**Electro-Medical Lab., Inc., South Woodstock, Vt.
- V**Electrofax Corp., 30 Burtis Ave., New Canaan, Conn.
- V**Electronic Surgical Equipment Co., Inc., N. E. Cor. 23 & Arch Sts., Philadelphia 3, Pa.
- V**Farrand Optical Co., Inc., Bronx Blvd. at 238th St., New York 66, N. Y.
- V**Glenco Corp., Metuchen, N. J.
- V**Grass Instrument Co., 101 Old Colony Ave., Quincy, Mass.
- V**Gulton Mfg. Corp., Metuchen, N. J.
- V**Hanover Developments, 401 E. 74th St., New York 21, N. Y.
- V**Hart Associates, 8430 Grand River, Detroit 4, Mich.
- V**Hathaway Instrument Co., 1315 S. Clarkson St., Denver 10, Colo.
- V**Maico Co., Inc., 21 N. 3rd St., Minneapolis, Minn.
- V**MARCONI INSTRUMENTS, LTD., 23 Beaver St., New York 4, N. Y. ADV. PG. 270.
- V**Minnesota Electronics Corp., 47 W. Water St., St. Paul 1, Minn.
- V**Multiple Television Mfg. Co., 987 Hegeman Ave., Brooklyn 8, N. Y.
- V**Oak Ridge Products Mfg. Div. of Video Television, Inc., 37-01 Vernon Blvd., Long Island City 1, N. Y.
- V**Offner Electronics, Inc., 5320 N. Kedzie Ave., Chicago 25, Ill.
- V**Photon Research Products, 1062 N. Allen Ave., Pasadena 7, Calif.
- V**Photon Instrument Co., 6516 Detroit Ave., Cleveland 2, Ohio.
- Process & Instruments, 60 Greenpoint Ave., Brooklyn 22, N. Y.
- V**Radiation Counter Laboratories, Inc., 1844 W. 21st St., Chicago 8, Ill.
- V**RAHM INSTRUMENTS, INC., 12 West Broadway, New York 7, N. Y. ADV. PG. 354.
- V**SANBORN CO., 39 Osborn St., Cambridge 39, Mass. ADV. PG. 391.
- V**Southwestern Industrial Electronics Co., 2831 Post Oak Rd., P. O. Box 13058, Houston 19, Texas.
- V**Technitrol Engineering Co., 3211 Woodland Ave., Philadelphia 4, Pa.
- V**Tektronix, Inc., 712 S. E. Hawthorne Blvd., Portland 14, Ore.

AMPLIFIERS—Microwave

- V**AMERICAN ELECTROENGINEERING CO., 5025-29 W. Jefferson Blvd., Los Angeles 16, Calif. ADV. PG. 136.
- V**BOGUE ELECTRIC MFG. CO., 52 Iowa Ave., Paterson 3, N. J. ADV. PG. 155.
- Bunnell & Co., J. H., 81 Prospect St., Brooklyn, N. Y.
- V**FEDERAL TELEPHONE & RADIO CORP., 88 Kingsland Rd., Clifton, N. J. ADV. PG. 161-163.
- V**KINGS MICROWAVE CO., INC., 50 Marbledale Rd., Tuckahoe 7, N. Y. ADV. PG. 178, 179.
- V**Lear, Inc., 110 Iona Ave., NW, Grand Rapids 2, Mich.
- Loral Electronics Corp., 794 E. 140th St., New York 54, N. Y.
- V**MARCONI INSTRUMENTS, LTD., 23 Beaver St., New York 4, N. Y. ADV. PG. 270.
- V**Microwave Equipment Co., Inc., North Caldwell, N. J.
- V**Motorola, Inc., 4545 Augusta Blvd., Chicago 51, Ill.
- V**Multiple Television Mfg. Co., 987 Hegeman Ave., Brooklyn 8, N. Y.
- V**Network Mfg. Corp., Bayonne, N. J.
- V**POLARAD ELECTRONICS CORP., 100 Metropolitan Ave., Brooklyn 11, N. Y. ADV. PG. 184, 185.
- V**Press Wireless Mfg. Co., Inc., Cantigue Rd., Hicksville, N. Y.
- V**RADIO CORP. OF AMERICA, RCA Victor Div., General Offices, Camden, N. J. ADV. PG. 177, Inside Back and Back Cover.
- V**Radio Engineering Labs., Inc., 36-40 37th St., Long Island City 1, N. Y.
- V**RAYTHEON MFG. CO., Power Tube Div., Waltham 54, Mass. ADV. PG. 80, 81.
- V**SPERRY GYROSCOPE CO. DIV. OF THE SPERRY CORP., Great Neck, N. Y. ADV. PG. 103, 104.
- Transmitter Equipment Mfg. Co., Inc., 345 Hudson St., New York 14, N. Y.
- V**Varian Associates, 99 Washington St., San Carlos, Calif.

AMPLIFIERS—Microwave Radar

- V**AMERICAN ELECTROENGINEERING CO., 5025-29 W. Jefferson Blvd., Los Angeles 16, Calif. ADV. PG. 136.
- V**BROWNING LABORATORIES, INC., 750 Main St., Winchester, Mass. ADV. PG. 257.
- Bunnell & Co., J. H., 81 Prospect St., Brooklyn, N. Y.
- V**KINGS MICROWAVE CO., INC., 50 Marbledale Rd., Tuckahoe 7, N. Y. ADV. PG. 178, 179.
- Loral Electronics Corp., 794 E. 140th St., New York 54, N. Y.
- V**MARCONI INSTRUMENTS, LTD., 23 Beaver St., New York 4, N. Y. ADV. PG. 270.
- V**Microwave Equipment Co., Inc., North Caldwell, N. J.
- V**Motorola, Inc., 4545 Augusta Blvd., Chicago 51, Ill.
- V**Multiple Television Mfg. Co., 987 Hegeman Ave., Brooklyn 8, N. Y.
- V**Network Mfg. Corp., Bayonne, N. J.
- V**POLARAD ELECTRONICS CORP., 100 Metropolitan Ave., Brooklyn 11, N. Y. ADV. PG. 184, 185.

V indicates . . . IN PRODUCTION • AVAILABILITY • UNRESTRICTED FOR GENERAL USE

- Ⓞ Press Wireless Mfg. Co., Inc., Cantiague Rd., Hicksville, N. Y.
- Ⓞ SPERRY GYROSCOPE CO. DIV. OF THE SPERRY CORP., Great Neck, N. Y. ADV. PG. 103, 104.
- Transmitter Equipment Mfg. Co., Inc., 345 Hudson St., New York 14, N. Y.
- Ⓞ Varian Associates, 99 Washington St., San Carlos, Calif.

AMPLIFIERS—Musical Instrument

- Ⓞ Bogen Co., Inc., David, 663 Broadway, New York 12, N. Y.
- Ⓞ Custom Craft Mfg. Co., 256 E. 98th St., Brooklyn, N. Y.
- Ⓞ Electronic Development Lab., 43-07 23rd Ave., Long Island City 5, N. Y.
- Ⓞ Fidelity Amplifier Co., 703 Willow St., Chicago 14, Ill.
- Ⓞ Minnesota Electronics Corp., 47 W. Water St., St. Paul 1, Minn.
- Ⓞ Magna Electronics Co., 3707-11 W. Jefferson Blvd., Los Angeles 16, Calif.
- Ⓞ Monarch Radio & Television Corp., 2430 Atlantic Ave., Brooklyn 33, N. Y.
- Ⓞ Multiple Television Mfg. Co., 987 Hegeman Ave., Brooklyn 8, N. Y.
- Ⓞ Newcomb Audio Products Co., 6824 Lexington Ave., Hollywood 38, Calif.
- Ⓞ Pentron Corp., 221 E. Cullerton St., Chicago 16, Ill.
- Ⓞ Scott, Inc., Herman Hosmer, 385 Putnam Ave., Cambridge 39, Mass.
- Ⓞ Scott Radio Labs., Inc., 4451 N. Ravenswood Ave., Chicago 40, Ill.
- Ⓞ Simpson Mfg. Co., Inc., Mark, 32-28 49th St., Long Island City 3, N. Y.
- Ⓞ Valco Mfg. Co., 4700 W. Walton St., Chicago 51, Ill.
- Ⓞ Western Sound & Electric Labs., Inc., 805 S. 5th St., Milwaukee 4, Wis.

AMPLIFIERS, Null

- Ⓞ AIRMEC LABORATORIES LTD., 366 Madison Ave., New York 17, N. Y. ADV. PG. 336.
- Ⓞ Brown Electro-Measurement Corp., 4637 SE Hawthorne Blvd., Portland 15, Ore.
- Ⓞ Electronic Development Lab., 43-07 23rd Ave., Long Island City 5, N. Y.
- Ⓞ FREED TRANSFORMER CO., INC., 1736 Weirfield St., Brooklyn 27, N. Y. ADV. PG. 149.
- Ⓞ Gaveco Labs., Inc., 2 East End Ave., New York 21, N. Y.
- Ⓞ GENERAL RADIO CO., 275 Massachusetts Ave., Cambridge 39, Mass. ADV. PG. 48, 49.
- Ⓞ Hart Associates, 8430 Grand River, Detroit 4, Mich.
- Ⓞ HEWLETT-PACKARD CO., 395 Page Mill Rd., Palo Alto, Calif. ADV. PG. 33-36.
- Ⓞ KROHN-HITE INSTRUMENT CO., 580 Massachusetts Ave., Cambridge 39, Mass. ADV. PG. 43.
- Ⓞ Leeds & Northrup Co., 4970 Stenton Ave., Philadelphia 44, Pa.
- Ⓞ Macdonald Co., Inc., W. S. 33 University Rd., Cambridge 38, Mass.
- Ⓞ Monarch Radio & Television Corp., 2430 Atlantic Ave., Brooklyn 33, N. Y.
- Ⓞ Multiple Television Mfg. Co., 987 Hegeman Ave., Brooklyn 8, N. Y.
- Ⓞ Network Mfg. Corp., Bayonne, N. J.

AMPLIFIERS—Peak Limiting

- Ⓞ Altec Lansing Corp., 9356 Santa Monica Blvd., Beverly Hills, Calif.
- Ⓞ AMERICAN ELECTRONIC ENGINEERING CORP., 5025-29 W. Jefferson Blvd., Los Angeles 16, Calif. ADV. PG. 136.
- Ⓞ Arlington Electric Products, Inc., 500 W. 52nd St., New York 19, N. Y.
- Ⓞ ATOMIC INSTRUMENT CO., 84 Massachusetts Ave., Cambridge 39, Mass. ADV. PG. 410.
- Ⓞ BARKER & WILLIAMSON, 235 Fairfield Ave., Upper Darby, Pa. ADV. PG. 292.
- Ⓞ Bunnell & Co., J. H., 81 Prospect St., Brooklyn, N. Y.
- Ⓞ Communications Co., Inc., 300 Greco Ave., Coral Gables 34, Fla.
- Ⓞ Gates Radio Co., Quincy, Ill.
- Ⓞ Gaveco Labs., Inc., 2 East End Ave., New York 21, N. Y.
- Ⓞ Hoffman Engineering Corp., Anoka, Minn.
- Ⓞ MEASUREMENTS CORP., Boonton, N. J. ADV. PG. 99.
- Ⓞ Multiple Television Mfg. Co., 987 Hegeman Ave., Brooklyn 8, N. Y.
- Ⓞ PRESTO RECORDING CORP., Paramus, N. J. ADV. PG. 52, 53.
- Ⓞ Schuttig & Co., Inc., 9th & Kearney Sts., N. E., Washington 17, D. C.
- Ⓞ Stancil-Hoffman Corp., 1016 N. Highland Ave., Hollywood 38, Calif.
- Ⓞ Standard Electronics Research Corp., 2 East End Ave., New York 21, N. Y.
- Ⓞ Thordarson-Meissner Mfg. Divs., 500 W. Huron St., Chicago 10, Ill.
- Ⓞ Transmitter Equipment Mfg. Co., Inc., 345 Hudson St., New York 14, N. Y.

AMPLIFIERS—Photocell

- Ⓞ Airtron Inc., P. O. Box 151, Caldwell, N. J.

- Ⓞ AIRMEC LABORATORIES LTD., 366 Madison Ave., New York 17, N. Y. ADV. PG. 336.
- Ⓞ Altec Lansing Corp., 9356 Santa Monica Blvd., Beverly Hills, Calif.
- Ⓞ Bogen Co., Inc., David, 663 Broadway, New York 12, N. Y.
- Ⓞ BOGUE ELECTRIC MFG. CO., 52 Iowa Ave., Paterson 3, N. J. ADV. PG. 155.
- Ⓞ De-Tec-Tronic Laboratories, Inc., 1711 Terra Cotta Pl., Chicago 14, Ill.
- Ⓞ Electro-Mechanical Research, Inc., Ridgefield, Conn.
- Ⓞ Electronic Control Corp., 1573 E. Forest St., Detroit, Mich.
- Ⓞ Farrand Optical Co., Inc., Bronx Blvd. at 238th St., New York 70, N. Y.
- Ⓞ Fidelity Amplifier Co., 703 Willow St., Chicago 14, Ill.
- Ⓞ Gaveco Labs., Inc., 2 East End Ave., New York 21, N. Y.
- Ⓞ GENERAL ELECTRIC CO., Schenectady 5, N. Y. ADV. PG. 1-22.
- Ⓞ Hart Associates, 8430 Grand River, Detroit 4, Mich.
- Ⓞ Hoffman Engineering Corp., Anoka, Minn.
- Ⓞ Hogan Laboratories, Inc., 155 Perry St., New York 14, N. Y.
- Ⓞ Industrial Electronics Co., Inc., Hanover, Mass.
- Ⓞ Leeds & Northrup Co., 4970 Stenton Ave., Philadelphia 44, Pa.
- Ⓞ McLeroy Mfg. Corp., Littleton, Mass.
- Ⓞ Magna Electronics Co., 3707-11 W. Jefferson Blvd., Los Angeles 16, Calif.
- Ⓞ Mellaphone Corp., Rochester 2, N. Y.
- Ⓞ Midwestern Geophysical Laboratory, 3400 S. Harvard, Tulsa, Okla.
- Ⓞ MILES REPRODUCER CO INC., 812 Broadway, New York 3, N. Y. ADV. PG. 322.
- Ⓞ Monarch Radio & Television Corp., 2430 Atlantic Ave., Brooklyn 33, N. Y.
- Ⓞ Multiple Television Mfg. Co., 987 Hegeman Ave., Brooklyn 8, N. Y.
- Ⓞ Photobell Company, 116 Nassau St., New York 7, N. Y.
- Ⓞ Photron Instrument Co., 6516 Detroit Ave., Cleveland 2, Ohio.
- Ⓞ Precision Electronics, Inc., 643 Milwaukee Ave., Chicago 22, Ill.
- Ⓞ SERVO CORP. OF AMERICA, 20-20 Jericho Turnpike, New Hyde Park, N. Y. ADV. PG. 150, 151.
- Ⓞ SOS Cinema Supply Corp., 602 W. 52nd St., New York 19, N. Y.
- Ⓞ Standard Electronics Research Corp., 2 East End Ave., New York 21, N. Y.
- Ⓞ Tech Laboratories, Inc., Bergen & Edsall Blvd., Pallsades Park, N. J.
- Ⓞ Telechrome, Inc., 88 Merrick Rd., Amityville, N. Y.
- Ⓞ Thordarson-Meissner Mfg. Divs., 500 W. Huron St., Chicago 10, Ill.
- Ⓞ Waveforms, Inc., 333 Sixth Ave., New York 14, N. Y.
- Ⓞ Welch Scientific Co., W. M., 1515 Sedgewick St., Chicago 10, Ill.
- Ⓞ WESTINGHOUSE ELECTRIC CORP., 511 Wood St., P. O. Box 868, Pittsburgh 30, Pa. ADV. PG. 107-113.
- Ⓞ Worner Electronic Devices, Rankin, Illinois.

AMPLIFIERS—Power

- Ⓞ ALLIED RADIO CORP., 833 W. Jackson Blvd., Chicago 7, Ill. ADV. PG. 238.
- Ⓞ Altec Lansing Corp., 9356 Santa Monica Blvd., Beverly Hills, Calif.
- Ⓞ AMERICAN ELECTRONIC ENGINEERING CORP., 5025-29 W. Jefferson Blvd., Los Angeles 16, Calif. ADV. PG. 136.
- Ⓞ Ampex Electric Corp., 1155 Howard Ave., San Carlos, Calif.
- Ⓞ Amplifier Corp. of America, 398 Broadway, New York 13, N. Y.
- Ⓞ Applied Science Corp. of Princeton, The, P. O. Box 44, Princeton, N. J.
- Ⓞ BARKER WILLIAMSON, 235 Fairfield Ave., Upper Darby, Pa. ADV. PG. 292.
- Ⓞ Bell Sound Systems, Inc., 555 Marion Rd., Columbus 7, Ohio.
- Ⓞ Bogen Co., Inc., David, 663 Broadway, New York 12, N. Y.
- Ⓞ BOGUE ELECTRIC MFG. CO., 52 Iowa Ave., Paterson 3, N. J. ADV. PG. 155.
- Ⓞ British Industries Corp., 164 Duane St., New York 13, N. Y.
- Ⓞ Bunnell & Co., J. H., 81 Prospect St., Brooklyn, N. Y.
- Ⓞ Calbest Engineering & Electronics Co., 828 N. Highland Ave., Hollywood 38, Calif.
- Ⓞ Collins Audio Products Co., P. O. Box 368, Westfield, N. J.
- Ⓞ Cossor (Canada) Ltd., 301-303 Windsor St., Halifax, N. S., Canada.
- Ⓞ Electronic Development Lab., 43-07 23rd Ave., Long Island City 5, N. Y.
- Ⓞ Fairchild Recording Equipment Corp., 154th St. & 7th Ave., Whitestone, N. Y.
- Ⓞ Fidelity Amplifier Co., 703 Willow St., Chicago 14, Ill.
- Ⓞ FREED TRANSFORMER CO., INC., 1736 Weirfield St., Brooklyn 27, N. Y. ADV. PG. 149.
- Ⓞ Gale-Dorothea Mechanisms, 37-61 85th St., Jackson Heights, N. Y.
- Ⓞ GENERAL RADIO CO., 275 Massachusetts Ave., Cambridge 39, Mass. ADV. PG. 48, 49.
- Ⓞ Hose-McCann Telephone Co., Inc., 25th St. & 3rd Ave., Brooklyn 32, N. Y.

- Ⓞ Industrial Electronics Co., Hanover, Mass.
- Ⓞ Lear, Inc., 110 Ionia Ave., N. W., Grand Rapids 2, Mich.
- Ⓞ Magna Electronics Co., 3707-11 W. Jefferson Blvd., Los Angeles 16, Calif.
- Ⓞ McINTOSH ENGINEERING LABORATORY, INC., 320 Water St., Binghamton, N. Y. ADV. PG. 148.
- Ⓞ McMurdo Silver Co., Inc., 417 Lafayette St., New York, N. Y.
- Ⓞ Midwestern Geophysical Laboratory, 3400 S. Harvard, Tulsa, Okla.
- Ⓞ Millen Mfg. Co., James, 150 Exchange St., Malden, Mass.
- Ⓞ Minnesota Electronics Corp., 47 W. Water St., St. Paul 1, Minn.
- Ⓞ Monarch Radio & Television Corp., 2430 Atlantic Ave., Brooklyn 33, N. Y.
- Ⓞ M. P. Concert Installations, Fairfield 10, Conn.
- Ⓞ Multiple Television Mfg. Co., 987 Hegeman Ave., Brooklyn 8, N. Y.
- Ⓞ Network Mfg. Corp., Bayonne, N. J.
- Ⓞ Northeastern Engineering, Inc., Manchester, N. H.
- Ⓞ Precision Electronics, Inc., 643 Milwaukee Ave., Chicago 22, Ill.
- Ⓞ Press Wireless Mfg. Co., Inc., Cantiague Rd., Hicksville, N. Y.
- Ⓞ RADIO CORP. OF AMERICA, RCA Victor Div., General Offices, Camden, N. J. ADV. PG. 177, Inside Back and Back Covers.
- Ⓞ Radio Engineering Labs., Inc., 36-40 37th St., Long Island City 1, N. Y.
- Ⓞ Rauland-Borg Corp., 3523 W. Addison St., Chicago 18, Ill.
- Ⓞ Remler Co., Ltd., 2101 Bryant St., San Francisco, Calif.
- Ⓞ Scott, Inc., Herman Hosmer, 385 Putnam Ave., Cambridge 39, Mass.
- Ⓞ Scott Radio Labs, Inc., 4451 N. Ravenswood Ave., Chicago 40, Ill.
- Ⓞ SHERRON ELECTRONICS CO., 1201 Flushing Ave., Brooklyn 6, N. Y. ADV. PG. 145.
- Ⓞ Simpson Mfg. Co., Inc., Mark, 32-28 49th St., Long Island City 3, N. Y.
- Ⓞ Southwestern Industrial Electronics Co., 2831 Post Oak Rd., P. O. Box 13058, Houston 19, Texas.
- Ⓞ Thordarson-Meissner Mfg. Divs., 500 W. Huron St., Chicago 10, Ill.
- Ⓞ TRAD TELEVISION CORP., 1001 First Ave., Asbury Park, N. J. ADV. PG. 355.
- Ⓞ Transmitter Equipment Mfg. Co., Inc., 345 Hudson St., New York 14, N. Y.
- Ⓞ Walkirt Co., 5808 Marilyn Ave., Culver City, Calif.
- Ⓞ Waveforms, Inc., 333 Sixth Ave., New York 14, N. Y.
- Ⓞ Webster Electric Co., 1900 Clark St., Racine, Wis.

AMPLIFIERS—Printed Circuit

- Ⓞ CENTRAL DIV. OF GLOBE-UNION, INC., 900 E. Keefe Ave., Milwaukee 1, Wis. ADV. PG. 85-88.
- Ⓞ Sprague Electric Co., North Adams, Mass.

AMPLIFIERS—Recording

- Ⓞ ALLIED RADIO CORP., 833 W. Jackson Blvd., Chicago 7, Ill. ADV. PG. 238.
- Ⓞ Amplifier Corp. of America, 398 Broadway, New York 13, N. Y.
- Ⓞ Arlington Electric Products, Inc., 500 W. 52nd St., New York 19, N. Y.
- Ⓞ Bell Sound Systems, Inc., 555 Marion Rd., Columbus 7, Ohio.
- Ⓞ Berndt-Bach, Inc., 7373 Beverly Blvd., Los Angeles 36, Calif.
- Ⓞ Caltron Co., 1406 S. Hobart Blvd., Los Angeles 6, Calif.
- Ⓞ CINEMA ENGINEERING CO., 1510 W. Verdugo Ave., Burbank, Calif. ADV. PG. 204.
- Ⓞ Collins Audio Products Co., P. O. Box 368, Westfield, N. J.
- Ⓞ EDIN CO., INC., 207 Main St., Worcester, Mass. ADV. PG. 285.
- Ⓞ Electronic Development Lab., 43-07 23rd Ave., Long Island City 5, N. Y.
- Ⓞ Fairchild Recording Equipment Co., 154th St. & Seventh Ave., Whitestone, N. Y.
- Ⓞ Feiler Engineering Co., 8026 Monticello Ave., Skokie, Ill.
- Ⓞ Furst Electronics, 10 S. Jefferson St., Chicago 6, Ill.
- Ⓞ Gates Radio Co., Quincy, Ill.
- Ⓞ Hathaway Instrument Co., 1315 S. Clarkson St., Denver 10, Colo.
- Ⓞ LANGEVIN MFG. CORP., 37 W. 65th St., New York 23, N. Y. ADV. PG. 348.
- Ⓞ MAGNECORP, INC., 360 N. Michigan Ave., Chicago 1, Ill. ADV. PG. 40.
- Ⓞ McINTOSH ENGINEERING LABORATORY, INC., 320 Water St., Binghamton, N. Y. ADV. PG. 148.
- Ⓞ M. P. Concert Installations, Fairfield 10, Conn.
- Ⓞ MARCONI INSTRUMENTS, LTD., 23 Beaver St., New York 4, N. Y. ADV. PG. 270.
- Ⓞ Maurer Inc., J. A., 37-01 31st St., Long Island City, N. Y.
- Ⓞ Midwestern Geophysical Laboratory, 3400 S. Harvard, Tulsa, Okla.
- Ⓞ MILES REPRODUCER CO., INC., 812 Broadway, New York 3, N. Y. ADV. PG. 322.

V indicates . . . **IN PRODUCTION • AVAILABILITY • UNRESTRICTED FOR GENERAL USE**

- ◻ Molded Insulation Co., 335 E. Price St., Philadelphia 44, Pa.
- ◻ Monarch Radio & Television Corp., 2430 Atlantic Ave., Brooklyn 33, N. Y.
- ◻ Multiple Television Mfg. Co., 987 Hegeman Ave., Brooklyn 8, N. Y.
- ◻ Newcomb Audio Products Co., 6824 Lexington Ave., Hollywood 38, Calif.
- ◻ Pentron Corp., 221 E. Cullerton St., Chicago 16, Ill.
- ◻ Photron Instrument Co., 6516 Detroit Ave., Cleveland 2, Ohio.
- ◻ Precision Electronics, Inc., 643 Milwaukee Ave., Chicago 22, Ill.
- ◻ Press Wireless Mfg. Co., Inc., Cantigue Rd., Hicksville, N. Y.
- ◻ PRESTO RECORDING CORP., Paramus, N. J. ADV. PG. 52, 53.
- ◻ RADIO CORP. OF AMERICA, RCA Victor Div., General Offices, Camden, N. J. ADV. PG. 177, Inside Back & Back Covers.
- ◻ Rek-O-Kut Co., 38-01 Queens Blvd., Long Island City, N. Y.
- ◻ SOS Cinema Supply Corp., 602 W. 52nd St., New York 19, N. Y.
- ◻ Southwestern Industrial Electronics Co., 2831 Post Oak Rd., P. O. Box 13058, Houston 19, Texas.
- ◻ Stancil-Hoffman Corp., 1016 N. Highland Ave., Hollywood 38, Calif.
- ◻ Thordanson-Melssner Mfg. Divs., 500 W. Huron St., Chicago 10, Ill.
- ◻ TRAD TELEVISION CORP., 1001 First Ave., Asbury Park, N. J. ADV. PG. 355.
- ◻ Western Sound & Electric Labs., Inc., 805 S. 5th St., Milwaukee 4, Wis.

AMPLIFIERS—r-f

- ◻ AIR ASSOCIATES, INC., Teterboro, N. J. ADV. PG. 211.
- ◻ AMERICAN ELECTROENGINEERING CORP., 5025-29 W. Jefferson Blvd., Los Angeles 16, Calif. ADV. PG. 136.
- ◻ BARKER & WILLIAMSON, 235 Fairfield Ave., Upper Darby, Pa. ADV. PG. 292.
- ◻ Bunnell & Co., J. H., 81 Prospect St., Brooklyn, N. Y.
- ◻ DuMont Laboratories, Inc., Allen B., Electronic Parts Div., 35 Market St., East Paterson, N. J.
- ◻ Electronic Engineering Corp., 469 Elm St., Arlington, N. J.
- ◻ FEDERAL TELEPHONE AND RADIO CORP., 88 Kingsland Rd., Clifton, N. J. ADV. PG. 161-163.
- ◻ Gaveco Labs., Inc., 2 East End Ave., New York 21, N. Y.
- ◻ HEINTZ & KAUFMAN EQUIPMENT DIV. OF THE ROBERT DOLLAR CO., 50 Drumm St., San Francisco 11, Calif. ADV. PG. 301.
- ◻ HEWLETT-PACKARD CO., 395 Page Mill Rd., Palo Alto, Calif. ADV. PG. 33-36.
- ◻ Hose-McCann Telephone Co., Inc., 25th St. & 3rd Ave., Brooklyn 32, N. Y.
- ◻ Kaar Engineering Co., 2995 Middlefield Rd., P. O. Box 1320, Palo Alto, Calif.
- ◻ KAY ELECTRIC CO., 14 Maple Ave., Pine Brook, N. J. ADV. PG. 340.
- ◻ Lear, Inc., 110 Ionia Ave., N.W., Grand Rapids 2, Mich.
- ◻ Lymnar Engineers, Inc., 1721 Delancey St., Philadelphia 3, Pa.
- ◻ McMurdo Silver Co., Inc., 473 Lafayette St., New York, N. Y.
- ◻ MEASUREMENTS CORP., Boonton, N. J. ADV. PG. 99.
- ◻ Melpar, Inc., 552 Swann Ave., Alexandria, Va.
- ◻ MILES REPRODUCER CO., INC., 812 Broadway, New York 12, N. Y. ADV. PG. 322.
- ◻ Millen Mfg. Co., James, 150 Exchange St., Malden, Mass.
- ◻ Monarch Radio & Television Corp., 2430 Atlantic Ave., Brooklyn 33, N. Y.
- ◻ Multiple Television Mfg. Co., 987 Hegeman Ave., Brooklyn 8, N. Y.
- ◻ Northeastern Engineering, Inc., Manchester, N. H.
- ◻ Press Wireless Mfg. Co., Inc., Cantigue Rd., Hicksville, N. Y.
- ◻ Radio Engineering Labs., Inc., 36-40 37th St., Long Island City 1, N. Y.
- ◻ Scott Radio Labs., Inc., 4451 N. Ravenswood Ave., Chicago 40, Ill.
- ◻ Sierra Electronic Corp., San Carlos, Calif.
- ◻ Sonic Industries Inc., 221 W. 17th St., New York 11, N. Y.
- ◻ TECHNICAL APPLIANCE CORP., Sherburne, N. Y. ADV. PG. 378.
- ◻ Tel-Instrument Co., Inc., 50 Patterson Ave., East Rutherford, N. J.
- ◻ Transmitter Equipment Mfg. Co., Inc., 345 Hudson St., New York 14, N. Y.
- ◻ Waltron Co., 19500 W. Eight Mile Rd., Detroit 19, Mich.

AMPLIFIERS—Servo

- ◻ AIR ASSOCIATES, INC., Teterboro, N. J. ADV. PG. 211.
- ◻ AIRPAX PRODUCTS CO., Middle River, Baltimore 20, Md. ADV. PG. 289.
- ◻ AMERICAN ELECTROENGINEERING CORP., 5025-29 W. Jefferson Blvd., Los Angeles 16, Calif. ADV. PG. 136.

- ◻ Arlington Electric Products Inc., 500 W. 52nd St., New York 19, N. Y.
- ◻ Arma Corp., 254 36th St., Brooklyn 32, N. Y.
- ◻ Askania Regulator Co., 240 E. Ontario St., Chicago 11, Ill.
- ◻ Atlantic Electronics, 4 Manhasset Ave., Manhasset, N. Y.
- ◻ Avion Instrument Corp., Paramus, N. J.
- ◻ BARKER & WILLIAMSON, 235 Fairfield Ave., Upper Darby, Pa. ADV. PG. 292.
- ◻ BELOCK INSTRUMENT CORP., 111th St. & 14th Ave., College Point, N. Y. ADV. PG. 371.
- ◻ Bunnell & Co., J. H., 81 Prospect St., Brooklyn, N. Y.
- ◻ Control Engineering Corp., 863 Washington St., Canton, Mass.
- ◻ Doelcam Corp., 56 Elmwood St., Newton 58, Mass.
- ◻ ECLIPSE-PIONEER DIV. BENDIX AVIATION CORP., Teterboro, N. J. ADV. PG. 198, 199.
- ◻ EDIN CO., INC., 207 Main St., Worcester, Mass. ADV. PG. 285.
- ◻ Edo Corp., College Point, N. Y.
- ◻ Electronic Associates, Inc., Long Branch, N. J.
- ◻ Flader, Inc., Frederic, 1330 Laskey Rd., Toledo 12, Ohio.
- ◻ Gaveco Labs, Inc., 2 East End Ave., New York 21, N. Y.
- ◻ GENERAL ELECTRIC CO., Schenectady 5, N. Y. ADV. PG. 1 to 22.
- ◻ GENERAL PRECISION LAB., INC., Pleasantville, N. Y. ADV. PG. 58, 59.
- ◻ INDUSTRIAL CONTROL CO., Straight, Path & Arlington Ave., Wyandanch, N. Y. ADV. PG. 130.
- ◻ Ketay Mfg. Corp., 555 Broadway, New York, N. Y.
- ◻ Lear, Inc., 110 Ionia Ave., N. W., Grand Rapids 2, Mich.
- ◻ Loral Electronics Corp., 794 E. 140th St., New York 54, N. Y.
- ◻ MAGNETIC AMPLIFIERS, INC., 1154 44th Drive, Long Island City, N. Y. ADV. PG. 346.
- ◻ Magnetics Inc., 135 Bloomfield Ave., Bloomfield, N. J.
- ◻ McINTOSH ENGINEERING LABORATORY, INC., 320 Water St., Binghamton, N. Y. ADV. PG. 148.
- ◻ MINNEAPOLIS-HONEYWELL REGULATOR CO., Industrial Div., Wayne & Roberts Aves., Philadelphia 44, Pa. ADV. PG. 208, 209.
- ◻ Multiple Television Mfg. Co., 987 Hegeman Ave., Brooklyn 8, N. Y.
- ◻ Northeastern Engineering, Inc., Manchester, N. H.
- ◻ Peerless Instrument Co., 90-15 Corona Ave., Elmhurst, N. Y.
- ◻ PENNSYLVANIA TESTING LABORATORY, Doylestown, Pa. ADV. PG. 350.
- ◻ PICKERING & CO., 309 Woods Ave., Oceanside, N. Y. ADV. PG. 284.
- ◻ Press Wireless Mfg. Co., Inc., Cantigue Rd., Hicksville, N. Y.
- ◻ REEVES INSTRUMENT CORP., 215 E. 91st St., New York, N. Y. ADV. PG. 315.
- ◻ Schaevitz Engineering, Crescent Blvd. at Drexel Ave., Pennsauken Township, Camden 11, N. J.
- ◻ SERVO CORP. OF AMERICA, 20-20 Jericho Turnpike, New Hyde Park, N. Y. ADV. PG. 150, 151.
- ◻ SERVOMECHANISMS, INC., Whaleneck Rd. & Stewart Ave., Westbury, L. I., N. Y. ADV. PG. 188.
- ◻ SERVO-TEK PRODUCTS CO., 4 Godwin Ave., Paterson, N. J. ADV. PG. 356.
- ◻ SPERRY GYROSCOPE CO., Div. of The Sperry Corp., Great Neck, N. Y. ADV. PG. 103, 104.
- ◻ Standard Electronics Research Corp., 2 East End Ave., New York 21, N. Y.
- ◻ TRANSICOIL CORP., 107 Grand St., New York, N. Y. ADV. PG. 116.
- ◻ Transmitter Equipment Mfg. Co., Inc., 345 Hudson St., New York 14, N. Y.
- ◻ VECTRON, INC., 235 High St., Waltham, Mass. ADV. PG. 214.

AMPLIFIERS—Strain Gage

- ◻ Avion Instrument Corp., Paramus, N. J.
- ◻ Baldwin-Lima-Hamilton Corp., Paschall P.O. Station, Philadelphia 42, Pa.
- ◻ BARKER & WILLIAMSON, 235 Fairfield Ave., Upper Darby, Pa. ADV. PG. 292.
- ◻ Bendix Aviation Corp., Pacific Division, 11600 Sherman Way, North Hollywood, Calif.
- ◻ BRUSH DEVELOPMENT CO., 3405 Perkins Ave., Cleveland 14, Ohio. ADV. PG. 228, 229.
- ◻ Century Geophysical Corp., 1333 N. Utica, Tulsa 3, Okla.
- ◻ Control Engineering Corp., 863 Washington St., Canton, Mass.
- ◻ EDIN CO., INC., 207 Main St., Worcester, Mass. ADV. PG. 285.
- ◻ ELECTRO PRODUCTS LABS., 4501 N. Ravenswood Ave., Chicago 40, Ill. ADV. PG. 199.
- ◻ Electronic Development Lab., 43-07 23rd Ave., Long Island City 5, N. Y.
- ◻ ELECTRONIC ENGINEERING ASSOCIATES, LTD., 1048 Brittan Ave., San Carlos, Calif. ADV. PG. 393.
- ◻ ELECTRONIC TUBE CORP., 1200 E. Mermaid Ave., Philadelphia 18, Pa. ADV. PG. 335.
- ◻ EIIIS Associates, Box 77, Pelham 65, N. Y.
- ◻ Engineering Lab., Inc., 602 E. 4th St., Tulsa 3, Okla.
- ◻ First Electronics, 10 S. Jefferson St., Chicago 6, Ill.
- ◻ Gaveco Labs., Inc., 2 East End Ave., New York 21, N. Y.
- ◻ GENERAL ELECTRIC CO., Schenectady 5, N. Y. ADV. PG. 1 to 22.

- ◻ Hanover Developments, 401 E. 74th St., New York 21, N. Y.
- ◻ Hart Associates, 8430 Grand River, Detroit 4, Mich.
- ◻ Hathaway Instrument Co., 1315 S. Clarkson St., Denver 10, Colo.
- ◻ HEILAND RESEARCH CORP., 150 E. 5th Ave., Denver 9, Colo. ADV. PG. 401.
- ◻ INDUSTRIAL ELECTRONICS, INC., 8080 Wheeler St., Detroit 10, Mich. ADV. PG. 234, 235.
- ◻ Magnetics, Inc., 135 Bloomfield Ave., Bloomfield, N. J.
- ◻ Manning, Maxwell & Moore, Inc., Stratford, Conn.
- ◻ Melpar, Inc., 552 Swann Ave., Alexandria, Va.
- ◻ Midwestern Geophysical Laboratory, 3400 S. Harvard, Tulsa, Okla.
- ◻ Miller Corp., Wm., 325 N. Halstead St., Pasadena 8, Calif.
- ◻ MINNEAPOLIS-HONEYWELL REGULATOR CO., INDUSTRIAL DIV., Wayne & Roberts Aves., Philadelphia 44, Pa. ADV. PG. 208, 209.
- ◻ Multiple Television Mfg. Co., 987 Hegeman Ave., Brooklyn 8, N. Y.
- ◻ Oak Ridge Products Mfg. Div. of Video Television, Inc., 37-01 Vernon Blvd., Long Island City 1, N. Y.
- ◻ Offner Electronics, Inc., 5320 N. Kedzie Ave., Chicago 25, Ill.
- ◻ Photron Instrument Co., 6516 Detroit Ave., Cleveland 2, Ohio.
- ◻ GRAHM INSTRUMENTS, INC., 12 West Broadway, New York 7, N. Y. ADV. PG. 354.
- ◻ SANBORN CO., 39 Osborn St., Cambridge 39, Mass. ADV. PG. 391.
- ◻ Southwestern Industrial Electronics Co., 2831 Post Oak Rd., P.O. Box 13058, Houston 19, Texas.
- ◻ VECTRON, INC., 235 High St., Waltham, Mass. ADV. PG. 214.
- ◻ Wilson & Co., G. C., 2 N. Passaic Ave., Chatham, N. J.

AMPLIFIERS—Television

- ◻ BELLING & LEE LTD., 366 Madison Ave., New York 17, N. Y. ADV. PG. 336.
- ◻ Bogen Co., Inc., David, 663 Broadway, New York 12, N. Y.
- ◻ Brach Mfg. Corp., 200 Central Ave., Newark, N. J.
- ◻ DuMont Laboratories, Inc., Allen B., Electronic Parts Div., 35 Market St., East Paterson, N. J.
- ◻ ELECTRO-VOICE, INC., Buchanan, Mich. ADV. PG. 345.
- ◻ GENERAL PRECISION LAB., INC., Pleasantville, N. Y. ADV. PG. 58, 59.
- ◻ Industrial Television, Inc., 359 Lexington Ave., Clifton, N. J.
- ◻ Jamaica Electronic Products Co., 95-26 Sutphin Blvd., Jamaica 4, N. Y.
- ◻ Lymnar Engineers, Inc., 1721 Delancey St., Philadelphia 3, Pa.
- ◻ M. P. Concert Installations, Fairfield 10, Conn.
- ◻ MEASUREMENTS CORP., Boonton, N. J. ADV. PG. 99.
- ◻ Minnesota Electronics Corp., 47 W. Water St., St. Paul 1, Minn.
- ◻ Monarch Radio & Television Corp., 2430 Atlantic Ave., Brooklyn 33, N. Y.
- ◻ Monroe Coil Co., 2839 N. Narragansett Ave., Chicago 34, Ill.
- ◻ Multiple Television Mfg. Co., 987 Hegeman Ave., Brooklyn 8, N. Y.
- ◻ POLARAD ELECTRONICS CORP., 100 Metropolitan Ave., Brooklyn 11, N. Y. ADV. PG. 184, 185.
- ◻ RADIO CORP. OF AMERICA, RCA Victor Div., General Offices, Camden, N. J. ADV. PG. 177, Inside Back & Back Covers.
- ◻ Radio Merchandise Sales, Inc., 1165 Southern Blvd., New York 59, N. Y.
- ◻ Sonic Industries Inc., 221 W. 17th St., New York 11, N. Y.
- ◻ SPENCER-KENNEDY LABS, INC., 186 Massachusetts Ave., Cambridge 39, Mass. ADV. PG. 166.
- ◻ TECHNICAL APPLIANCE CORP., Sherburne, N. Y. ADV. PG. 378.
- ◻ Telechrome, Inc., 88 Merrick Rd., Amityville, N. Y.
- ◻ Television Equipment Corp., 238 William St., New York 7, N. Y.
- ◻ Tel-Instrument Co., Inc., 50 Patterson Ave., East Rutherford, N. J.
- ◻ TRAD TELEVISION CORP., 1001 First Ave., Asbury Park, N. J. ADV. PG. 355.
- ◻ Video Corp. of America, 229 W. 28th St., New York 1, N. Y.

AMPLIFIERS—Ultrasonic

- ◻ AIRMEC LABORATORIES LTD., 366 Madison Ave., New York 17, N. Y. ADV. PG. 336.
- ◻ BARKER & WILLIAMSON, 235 Fairfield Ave., Upper Darby, Pa. ADV. PG. 292.
- ◻ Bludworth Marine Div., National-Simplex-Bludworth, Inc., 92 Gold St., New York 38, N. Y.
- ◻ BRUSH DEVELOPMENT CO., 3405 Perkins Ave., Cleveland 14, Ohio. ADV. PG. 228, 229.
- ◻ Cossor (Canada), Ltd., 301-303 Windsor St., Halifax, N. S., Canada.
- ◻ Edo Corp., College Point, N. Y.
- ◻ Gaveco Labs., Inc., 2 East End Ave., New York 21, N. Y.
- ◻ GENERAL ELECTRIC CO., Schenectady 5, N. Y. ADV. PG. 1 to 22.
- ◻ Glenco Corp., Metuchen, N. J.

Ⓥ indicates . . . IN PRODUCTION • AVAILABILITY • UNRESTRICTED FOR GENERAL USE

- Ⓥ Gulston Mfg. Corp., Metuchen, N. J.
- Ⓥ KEITHLEY INSTRUMENTS, 1507 Warrensville Center Rd., Cleveland 21, Ohio. ADV. PG. 337.
- Ⓥ MCINTOSH ENGINEERING LABORATORY, INC., 320 Water St., Binghamton, N. Y. ADV. PG. 148.
- Ⓥ Massa Laboratories, 3868 Carnegie St., Cleveland, Ohio.
- Ⓥ Midwestern Geophysical Laboratory, 3400 S. Harvard, Tulsa, Okla.
- Ⓥ Minnesota Electronics Corp., 47 W. Water St., St. Paul 1, Minn.
- Ⓥ Multiple Television Mfg. Co., 987 Hegeman Ave., Brooklyn 8, N. Y.
- Ⓥ Nuclear Research Corp., 2707 Federal St., Philadelphia 46, Pa.
- Ⓥ Rich-Roth Labs., East Hartford, Conn.
- Ⓥ Southwestern Industrial Electronics Co., 2831 Post Oak Rd., P.O. Box 13058, Houston 19, Texas.

AMPLIFIERS—Vibration Pickup

- Ⓥ Aircraft Electronics Associates, Inc., 94 Silas Deane Highway, Rocky Hill, Conn.
- Ⓥ Avion Instrument Corp., Paramus, N. J.
- Ⓥ Bendix Aviation Corp., Pacific Division, 11600 Sherman Way, North Hollywood, Calif.
- Ⓥ BRUSH DEVELOPMENT CO., 3405 Perkins Ave., Cleveland 14, Ohio. ADV. PG. 228, 229.
- Ⓥ Century Geophysical Corp., 1333 N. Utica, Tulsa 3, Oklahoma.
- Ⓥ Control Engineering Corp., 863 Washington St., Canton, Mass.
- Ⓥ Dice Co., J. W., Englewood, N. J.
- Ⓥ EDIN CO., INC., 207 Main St., Worcester, Mass. ADV. PG. 285.
- Ⓥ ELECTRO PRODUCTS LABS., 4501 N. Ravenswood Ave., Chicago 40, Ill. ADV. PG. 199.
- Ⓥ ELECTRONIC ENGINEERING ASSOCIATES, LTD., 1048 Brittan Ave., San Carlos, Calif. ADV. PG. 393.
- Ⓥ Furst Electronics, 10 S. Jefferson St., Chicago 6, Ill.
- Ⓥ GENERAL RADIO CO., 275 Massachusetts Ave., Cambridge 39, Mass. ADV. PG. 48, 49.
- Ⓥ Glenco Corp., Metuchen, N. J.
- Ⓥ Gulston Mfg. Corp., Metuchen, N. J.
- Ⓥ Hart Associates, 8430 Grand River, Detroit 4, Mich.
- Ⓥ Hathaway Instrument Co., 1315 S. Clarkson St., Denver 10, Colo.
- Ⓥ HEILAND RESEARCH CORP., 130 E. 5th Ave., Denver 9, Colo. ADV. PG. 401.
- Ⓥ INDUSTRIAL ELECTRONICS, INC., 8080 Wheeler St., Detroit 10, Mich. ADV. PG. 234, 235.
- Ⓥ Lear, Inc., 110 Ionla Ave., NW., Grand Rapids 2, Mich.
- Ⓥ MCINTOSH ENGINEERING LABORATORY, INC., 320 Water St., Binghamton, N. Y. ADV. PG. 148.
- Ⓥ Midwestern Geophysical Laboratory, 3400 S. Harvard, Tulsa, Okla.
- Ⓥ Miller Corp., William, 325 N. Halstead St., Pasadena 8, Calif.
- Ⓥ Multiple Television Mfg. Co., 987 Hegeman Ave., Brooklyn 8, N. Y.
- Ⓥ Photon Instrument Co., 6516 Detroit Ave., Cleveland 2, Ohio.
- Ⓥ PICKERING & CO., 309 Woods Ave., Oceanside, N. Y. ADV. PG. 284.
- Ⓥ RAHM INSTRUMENTS, INC., 12 W. Broadway, New York 7, N. Y. ADV. PG. 354.
- Ⓥ Scott, Inc., Hermon Hosmer, 385 Putnam Ave., Cambridge 39, Mass.
- Ⓥ Southwestern Industrial Electronics Co., 2831 Post Oak Rd., P.O. Box 13058, Houston 19, Texas.
- Ⓥ SPERRY GYROSCOPE CO., Div. of The Sperry Corp., Great Neck, N. Y. ADV. PG. 103, 104.
- Ⓥ WESTINGHOUSE ELECTRIC CORP., 511 Wood St., P.O. Box 868, Pittsburgh 30, Pa. ADV. PG. 107-113.

AMPLIFIERS—Wideband

- Ⓥ AIRMEC LABORATORIES, LTD., 366 Madison Ave., New York 17, N. Y. ADV. PG. 336.
- Ⓥ ATOMIC INSTRUMENT CO., 84 Massachusetts Ave., Cambridge 39, Mass. ADV. PG. 410.
- Ⓥ BARKER & WILLIAMSON, 235 Fairfield Ave., Upper Darby, Pa. ADV. PG. 292.
- Ⓥ British Industries Corp., 164 Duane St., New York 13, N. Y.
- Ⓥ Bunnell & Co., J. H., 81 Prospect St., Brooklyn, N. Y.
- Ⓥ Century Geophysical Corp., 1333 N. Utica, Tulsa 3, Okla.
- Ⓥ Coulter Electronics, 3123 W. Fulton St., Chicago 12, Ill.
- Ⓥ DuMont Laboratories, Inc., Allen B., Instrument Div., 1000 Main Ave., Clifton, N. J.
- Ⓥ Electro-Mechanical Research, Inc., Ridgefield, Conn.
- Ⓥ EL-TRONICS, INC., 2649 N. Howard St., Philadelphia 33, Pa. ADV. PG. 299.
- Ⓥ Fairchild Recording Equipment Co., 154th St. & Seventh Ave., Whitestone, N. Y.
- Ⓥ Furst Electronics, 10 S. Jefferson St., Chicago 6, Ill.
- Ⓥ Gaveco Labs., Inc., 2 East End Ave., New York 21, N. Y.
- Ⓥ GENERAL RADIO CO., 275 Massachusetts Ave., Cambridge 39, Mass. ADV. PG. 48, 49.
- Ⓥ Hanover Developments, 401 E. 74th St., New York 21, N. Y.
- Ⓥ HEWLETT-PACKARD CO., 395 Page Mill Rd., Palo Alto, Calif. ADV. PG. 33-36.
- Ⓥ Jamaica Electronic Products Co., 95-26 Sutphin Blvd., Jamaica 4, N. Y.

- Ⓥ Kalbfell Labs., Inc., 1076 Morena Blvd., San Diego 10, Calif.
- Ⓥ KINGS MICROWAVE CO., INC., 50 Marbledale Rd., Tuckahoe 7, N. Y. ADV. PG. 178, 179.
- Ⓥ Lynnmar Engineers, Inc., 1721 Delancey St., Philadelphia 3, Pa.
- Ⓥ MARCONI INSTRUMENTS, LTD., 23 Beaver St., New York 4, N. Y. ADV. PG. 270.
- Ⓥ MCINTOSH ENGINEERING LABORATORY, INC., 320 Water St., Binghamton, N. Y. ADV. PG. 148.
- Ⓥ McMurdo Silver Co., Inc., 473 Lafayette St., New York, N. Y.
- Ⓥ MEASUREMENTS CORP., Boonton, N. J. ADV. PG. 99.
- Ⓥ Midwestern Geophysical Laboratory, 3400 S. Harvard, Tulsa, Okla.
- Ⓥ Monarch Radio & Television Corp., 2430 Atlantic Ave., Brooklyn 33, N. Y.
- Ⓥ Multiple Television Mfg. Co., 987 Hegeman Ave., Brooklyn 8, N. Y.
- Ⓥ Newcomb Audio Products Co., 6824 Lexington Ave., Hollywood 38, Calif.
- Ⓥ Nuclear Research Corp., 2707 Federal St., Philadelphia 46, Pa.
- Ⓥ Peerless Instrument Co., 90-15 Corona Ave., Elmhurst, N. Y.
- Ⓥ Phillips Petroleum Co., Market Development Div., Bartlesville, Okla.
- Ⓥ PICKERING & CO., 309 Woods Ave., Oceanside, N. Y. ADV. PG. 284.
- Ⓥ POLARAD ELECTRONICS CORP., 100 Metropolitan Ave., Brooklyn 11, N. Y. ADV. PG. 184, 185.
- Ⓥ Press Wireless Mfg. Co., Inc., Cantiague Rd., Hicksville, N. Y.
- Ⓥ Radiation Counter Laboratories, Inc., 1844 W. 21st St., Chicago 8, Ill.
- Ⓥ SPENCER-KENNEDY LABS, INC., 186 Massachusetts Ave., Cambridge 39, Mass. ADV. PG. 166.
- Ⓥ Standard Electronics Research Corp., 2 East End Ave., New York 21, N. Y.
- Ⓥ Technology Instrument Corp., 531 Main St., Acton, Mass.
- Ⓥ Tektronix, Inc., 712 S. E. Hawthorne Blvd., Portland 14, Ore.
- Ⓥ Telechrome, Inc., 88 Merrick Rd., Amityville, N. Y.
- Ⓥ Tel-Instrument Co., Inc., 50 Patterson Ave., East Rutherford, N. J.
- Ⓥ Tracerlab, Inc., 130 High St., Boston 10, Mass.
- Ⓥ U. S. Electronic Co., 262 Canner St., New Haven 11, Conn.
- Ⓥ VECTRON, INC., 235 High St., Waltham, Mass. ADV. PG. 214.

ANALOGS

See Machines, Electronic Computing.

ANALYZERS—Audio Amplifier

- Ⓥ AIRMEC LABORATORIES LTD., 366 Madison Ave., New York 17, N. Y. ADV. PG. 336.
- Ⓥ Altec Lansing Corp., 9356 Santa Monica Blvd., Beverly Hills, Calif.
- Ⓥ BARKER & WILLIAMSON, 235 Fairfield Ave., Upper Darby, Pa. ADV. PG. 292.
- Ⓥ Calbest Engineering & Electronics Co., 828 N. Highland Ave., Hollywood 38, Calif.
- Ⓥ Clough Brengle Co., 6014 N. Broadway, Chicago, Ill.
- Ⓥ EL-TRONICS, INC., 2649 N. Howard St., Philadelphia 33, Pa. ADV. PG. 299.
- Ⓥ Feller Engineering Co., 8026 Monticello Ave., Skokie, Ill.
- Ⓥ HICKOK ELECTRICAL INSTRUMENT CO., 10514 Dupont Ave., Cleveland 8, Ohio. ADV. PG. 333.
- Ⓥ KAY ELECTRIC CO., 14 Maple Ave., Pine Brook, N. J. ADV. PG. 340.
- Ⓥ KROHN-HITE INSTRUMENT CO., 580 Massachusetts Ave., Cambridge 39, Mass. ADV. PG. 43.
- Ⓥ McMurdo Silver Co., Inc., 473 Lafayette St., New York, N. Y.
- Ⓥ MARCONI INSTRUMENTS, LTD., 23 Beaver St., New York 4, N. Y. ADV. PG. 270.
- Ⓥ MEASUREMENTS CORP., Boonton, N. J. ADV. PG. 99.
- Ⓥ PANORAMIC RADIO PRODUCTS, INC., 10 S. Second Ave., Mt. Vernon, N. Y. ADV. PG. 383.
- Ⓥ PICKERING & CO., 309 Woods Ave., Oceanside, N. Y. ADV. PG. 284.
- Ⓥ Precision Electronics Inc., 643 Milwaukee Ave., Chicago 22, Ill.
- Ⓥ WESTON ELECTRICAL INSTRUMENT CORP., 595 Frelinghuysen Ave., Newark 5, N. J. ADV. PG. 243.

ANALYZERS—Capacitor

- Ⓥ AEROVOX CORP., 740 Belleville Ave., New Bedford, Mass. ADV. PG. 352.
- Ⓥ Clough Brengle Co., 6014 N. Broadway, Chicago, Ill.
- Ⓥ CORNELL-DUBILIER ELECTRIC CORP., South Plainfield, N. J. ADV. PG. 146.
- Ⓥ ELECTRONIC INSTRUMENT CO., INC., 276 Newport St., Brooklyn 12, N. Y. ADV. PG. 129.
- Ⓥ GENERAL ELECTRIC CO., Electronics Dept., Electronics Park, Syracuse, N. Y. ADV. PG. 1-22.
- Ⓥ HICKOK ELECTRICAL INSTRUMENT CO., 10514 Dupont Ave., Cleveland 8, Ohio. ADV. PG. 333.
- Ⓥ Jackson Electrical Instrument Co., 16 S. Patterson Blvd., Dayton 1, Ohio.

- Ⓥ Leeds & Northrup Co., 4970 Stenton Ave., Philadelphia 44, Pa.
- Ⓥ McMurdo Silver Co., Inc., 473 Lafayette St., New York, N. Y.
- Ⓥ MEASUREMENTS CORP., Boonton, N. J. ADV. PG. 99.
- Ⓥ Network Mfg. Corp., Bayonne, N. J.
- Ⓥ SHALLCROSS MFG. CO., 10 Jackson Ave., Collingdale, Pa. ADV. PG. 261.
- Ⓥ Simpson Electric Co., Div. American Gage & Machine Co., 5218 W. Kinzie St., Chicago 44, Ill.
- Ⓥ WESTON ELECTRICAL INSTRUMENT CORP., 595 Frelinghuysen Ave., Newark 5, N. J. ADV. PG. 243.

ANALYZERS—Circuit

- Ⓥ ADVANCE ELECTRONICS CO., 451 Highland Ave., Passaic, N. J. ADV. PG. 224.
- Ⓥ Feller Engineering Co., 8026 Monticello Ave., Skokie, Ill.
- Ⓥ HICKOK ELECTRICAL INSTRUMENT CO., 10514 Dupont Ave., Cleveland 8, Ohio. ADV. PG. 333.
- Ⓥ Instrument Laboratories, 315 W. Walton Place, Chicago 10, Ill.
- Ⓥ Jackson Electrical Instrument Co., 16 S. Patterson Blvd., Dayton 1, Ohio.
- Ⓥ KAY ELECTRIC CO., 14 Maple Ave., Pine Brook, N. J. ADV. PG. 340.
- Ⓥ King Electric Equipment Co., 9123 Inman Ave., Cleveland 5, Ohio.
- Ⓥ McMurdo Silver Co., Inc., 473 Lafayette St., New York, N. Y.
- Ⓥ Precision Apparatus Co., Inc., 92-27 Horace Harding Blvd., Elmhurst, N. Y.
- Ⓥ RADIO CORP. OF AMERICA, Tube Dept., Harrison, N. J. ADV. PG. 177, Inside Back & Back Covers.
- Ⓥ Simpson Electric Co., Div. American Gage & Machine Co., 5218 W. Kinzie St., Chicago 44, Ill.
- Ⓥ Supreme, Inc., Greenwood, Miss.
- Ⓥ Waveforms, Inc., 333 Sixth Ave., New York 14, N. Y.
- Ⓥ WESTINGHOUSE ELECTRIC CORP., 511 Wood St., P. O. Box 868, Pittsburgh 30, Pa. ADV. PG. 107-113.
- Ⓥ WESTON ELECTRICAL INSTRUMENT CORP., 595 Frelinghuysen Ave., Newark 5, N. J. ADV. PG. 243.

ANALYZERS—Coincidence

- Ⓥ ATOMIC INSTRUMENT CO., 84 Massachusetts Ave., Cambridge 39, Mass. ADV. PG. 410.

ANALYZERS—Frequency

- Ⓥ BARKER & WILLIAMSON, 235 Fairfield Ave., Upper Darby, Pa. ADV. PG. 292.
- Ⓥ EDIN CO., INC., 207 Main St., Worcester, Mass. ADV. PG. 285.
- Ⓥ GENERAL ELECTRIC CO., Electronics Dept., Electronics Park, Syracuse, N. Y. ADV. PG. 1-22.
- Ⓥ GENERAL RADIO CO., 275 Massachusetts Ave., Cambridge 39, Mass. ADV. PG. 48, 49.
- Ⓥ KAY ELECTRIC CO., 14 Maple Ave., Pine Brook, N. J. ADV. PG. 340.
- Ⓥ KROHN-HITE INSTRUMENT CO., 580 Massachusetts Ave., Cambridge 39, Mass. ADV. PG. 43.
- Ⓥ MARCONI INSTRUMENTS, LTD., 23 Beaver St., New York 4, N. Y. ADV. PG. 270.
- Ⓥ PANORAMIC RADIO PRODUCTS, INC., 10 South Second Ave., Mt. Vernon, N. Y. ADV. PG. 383.
- Ⓥ POTTER INSTRUMENT CO., INC., 115 Cutter Mill Rd., Great Neck, N. Y. ADV. PG. 318.
- Ⓥ RAHM INSTRUMENT, INC., 12 W. Broadway, New York 7, N. Y. ADV. PG. 354.
- Ⓥ WESTON ELECTRICAL INSTRUMENT CORP., 595 Frelinghuysen Ave., Newark 5, N. J. ADV. PG. 243.

ANALYZERS—Gas

- Ⓥ Applied Physics Corp., 362 W. Colorado St., Pasadena 1, Calif.
- Ⓥ Bailey Meter Co., 1044 Ivanhoe Rd., Cleveland 10, Ohio.
- Ⓥ Baird Associates, Inc., 33 University Rd., Cambridge 38, Mass.
- Ⓥ Baker & Co., Inc., 113 Astor St., Newark 5, N. J.
- Ⓥ Consolidated Engineering Corp., 300 N. Sierra Madre Villa, Pasadena 8, Calif.
- Ⓥ Gow-Mac Instrument Co., 22 Lawrence St., Newark 5, N. J.
- Ⓥ Hart Associates, 8430 Grand River, Detroit 4, Mich.
- Ⓥ King Electric Equipment Co., 9123 Inman Ave., Cleveland 5, Ohio.
- Ⓥ Leeds & Northrup Co., 4970 Stenton Ave., Philadelphia 44, Pa.
- Ⓥ National Research Corp., 70 Memorial Drive, Cambridge 42, Mass.
- Ⓥ Process & Instruments, 60 Greenpoint Ave., Brooklyn 22, N. Y.
- Ⓥ Radiation Counter Laboratories, Inc., 1844 W. 21st St., Chicago 8, Ill.
- Ⓥ Rubicon Co., 3761 Ridge Ave., Philadelphia 29, Pa.
- Ⓥ Schauer Mfg. Corp., 2119 Reading Rd., Cincinnati 2, Ohio.

V indicates . . . IN PRODUCTION • AVAILABILITY • UNRESTRICTED FOR GENERAL USE

- ⊙ Statham Laboratories, Inc., 12401 W. Olympic Blvd., Los Angeles 64, Calif.
 ⊙ VICTORY ENGINEERING CORP., 744 Broad St., Newark, N. J. ADV. PG. 203.
 ⊙ WESTINGHOUSE ELECTRIC CORP., 511 Wood St., P.O. Box 868, Pittsburgh 30, Pa. ADV. PG. 107-113.

ANALYZERS—Harmonic

- ⊙ BARKER & WILLIAMSON, 235 Fairfield Ave., Upper Darby, Pa. ADV. PG. 292.
 ⊙ Bunnell & Co., J. H., 81 Prospect St., Brooklyn, N. Y.
 ⊙ Davies Laboratories, Inc., 4705 Queensbury Rd., Riverdale, Md.
 ⊙ GENERAL RADIO CO., 275 Massachusetts Ave., Cambridge 39, Mass. ADV. PG. 48, 49.
 ⊙ HEWLETT-PACKARD CO., 395 Page Mill Rd., Palo Alto, Calif. ADV. PG. 33-36.
 ⊙ KAY ELECTRIC CO., 14 Maple Ave., Pine Brook, N. J. ADV. PG. 340.
 ⊙ MARCONI INSTRUMENTS, LTD., 23 Beaver St., New York 4, N. Y. ADV. PG. 270.
 ⊙ Muirhead & Co., Ltd., Beckenham-Kent-England.
 ⊙ PANORAMIC RADIO PRODUCTS, INC., 10 South Second Ave., Mt. Vernon, N. Y. ADV. PG. 383.
 ⊙ Sierra Electronic Corp., San Carlos, Calif.

ANALYZERS—Intermodulation

- ⊙ Altec Lansing Corp., 9356 Santa Monica Blvd., Beverly Hills, Calif.
 ⊙ Audio Instrument Co., 133 W. 14th St., New York 11, N. Y.
 ⊙ GENERAL RADIO CO., 275 Massachusetts Ave., Cambridge 39, Mass. ADV. PG. 48, 49.
 ⊙ KAY ELECTRIC CO., 14 Maple Ave., Pine Brook, N. J. ADV. PG. 340.
 ⊙ MARCONI INSTRUMENTS, LTD., 23 Beaver St., New York 4, N. Y. ADV. PG. 270.
 ⊙ MEASUREMENTS CORP., Boonton, N. J. ADV. PG. 99.
 ⊙ PANORAMIC RADIO PRODUCTS, INC., 10 South Second Ave., Mt. Vernon, N. Y. ADV. PG. 383.
 ⊙ PICKERING & CO., 309 Woods Ave., Oceanside, N. Y. ADV. PG. 284.

ANALYZERS—Magnetic

- ⊙ Magnetic Analysis Corp., 42-44 12th St., Long Island City, N. Y.

ANALYZERS—Microwave Radar

- ⊙ KAY ELECTRIC CO., 14 Maple Ave., Pine Brook, N. J. ADV. PG. 340.
 ⊙ MARCONI INSTRUMENTS, LTD., 23 Beaver St., New York 4, N. Y. ADV. PG. 270.
 ⊙ Microwave Equipment Co., Inc., North Caldwell, N. J.
 ⊙ PANORAMIC RADIO PRODUCTS, INC., 10 South Second Ave., Mt. Vernon, N. Y. ADV. PG. 383.
 ⊙ POLARAD ELECTRONICS CORP., 100 Metropolitan Ave., Brooklyn 11, N. Y. ADV. PG. 184, 185.
 ⊙ POLYTECHNIC RESEARCH & DEVELOPMENT CO., INC., 202 Tillary St., Brooklyn 1, N. Y. ADV. PG. 172, 173.
 ⊙ SPERRY GYROSCOPE CO., Div. of The Sperry Corp., Great Neck, N. Y. ADV. PG. 103, 104.
 ⊙ VECTRON, INC., 235 High St., Waltham, Mass. ADV. PG. 214.
 ⊙ WESTON ELECTRICAL INSTRUMENT CORP., 595 Frelinghuysen Ave., Newark 5, N. J. ADV. PG. 243.

ANALYZERS—Noise

- ⊙ BARKER & WILLIAMSON, 235 Fairfield Ave., Upper Darby, Pa. ADV. PG. 292.
 ⊙ GENERAL ELECTRIC CO., Schenectady 5, N. Y. ADV. PG. 1-22.
 ⊙ GENERAL ELECTRIC CO., Electronics Dept., Electronics Park, Syracuse, N. Y. ADV. PG. 1-22.
 ⊙ GENERAL RADIO CO., 275 Massachusetts Ave., Cambridge 39, Mass. ADV. PG. 48, 49.
 ⊙ Hart Associates, 8430 Grand River, Detroit 4, Mich.
 ⊙ KAY ELECTRIC CO., 14 Maple Ave., Pine Brook, N. J. ADV. PG. 340.
 ⊙ MEASUREMENTS CORP., Boonton, N. J. ADV. PG. 99.
 ⊙ Midwestern Geophysical Laboratory, 3400 S. Harvard, Tulsa, Okla.
 ⊙ PANORAMIC RADIO PRODUCTS, INC., 10 South Second Ave., Mt. Vernon, N. Y. ADV. PG. 383.
 ⊙ POLARAD ELECTRONICS CORP., 100 Metropolitan Ave., Brooklyn 11, N. Y. ADV. PG. 184, 185.
 ⊙ Scott, Inc., Hermon Hosmer, 385 Putnam Ave., Cambridge 39, Mass.
 ⊙ Standard Telephones & Cables Ltd., Connaught House, Aldwych, London, W.C. 2, England.

ANALYZERS—Servo

- ⊙ Davies Laboratories, Inc., 4705 Queensbury Rd., Riverdale, Md.
 ⊙ INDUSTRIAL CONTROL CO., Straight Path & Arlington Ave., Wyandanch, N. Y. ADV. PG. 130.
 ⊙ KROHN-HITE INSTRUMENT CO., 580 Massachusetts Ave., Cambridge 39, Mass. ADV. PG. 43.

- ⊙ PENNSYLVANIA TESTING LABORATORY, Doylestown, Pa. ADV. PG. 350.
 ⊙ Philbrick Researches, Inc., George A., 230 Congress St., Boston 10, Mass.
 ⊙ SERVO CORP. OF AMERICA, 20-20 Jericho Turnpike, New Hyde Park, N. Y. ADV. PG. 150, 151.

ANALYZERS—Spectrum

- ⊙ Baird Associates, 33 University Rd., Cambridge 35, Mass.
 ⊙ Bausch Lomb Optical Co., 635 St. Paul St., Rochester 2, N. Y.
 ⊙ Farrand Optical Co., Inc., 238th St. & Bronx Blvd., New York 70, N. Y.
 ⊙ GENERAL ELECTRIC CO., Schenectady 5, N. Y. ADV. PG. 1-22.
 ⊙ Jarrel-Ash Co., 165 Newberry St., Boston 16, Mass.
 ⊙ KAY ELECTRIC CO., 14 Maple Ave., Pine Brook, N. J. ADV. PG. 340.
 ⊙ KINGS MICROWAVE CO., INC., 50 Marbledale Rd., Tuckahoe 7, N. Y. ADV. PG. 178, 179.
 ⊙ Leru Laboratories, Inc., 360 Blecker St., New York 14, N. Y.
 ⊙ MARCONI INSTRUMENTS, LTD., 23 Beaver St., New York 4, N. Y. ADV. PG. 270.
 ⊙ PANORAMIC RADIO PRODUCTS, INC., 10 South Second Ave., Mt. Vernon, N. Y. ADV. PG. 383.
 ⊙ POLARAD ELECTRONICS CORP., 100 Metropolitan Ave., Brooklyn 11, N. Y. ADV. PG. 184, 185.
 ⊙ POLYTECHNIC RESEARCH & DEVELOPMENT CO., INC., 202 Tillary St., Brooklyn 1, N. Y. ADV. PG. 172, 173.
 ⊙ SPERRY GYROSCOPE CO., Div. of The Sperry Corp., Great Neck, N. Y. ADV. PG. 103, 104.
 ⊙ SYLVANIA ELECTRIC PRODUCTS, INC., 1740 Broadway, New York 19, N. Y. ADV. PG. 432-436.
 ⊙ VECTRON, INC., 235 High St., Waltham, Mass. ADV. PG. 214.
 ⊙ WESTINGHOUSE ELECTRIC CORP., 511 Wood St., P.O. Box 868, Pittsburgh 30, Pa. ADV. PG. 107-113.
 ⊙ Wheeler Laboratories, Inc., Great Neck, N. Y.

ANALYZERS—Surface Analyzers & Comparators

- ⊙ Bausch & Lomb Optical Co., 635 St. Paul St., Rochester 2, N. Y.
 ⊙ BRUSH DEVELOPMENT CO., 3405 Perkins Ave., Cleveland 14, Ohio. ADV. PG. 228, 229.
 ⊙ EDIN CO., INC., 207 Main St., Worcester, Mass. ADV. PG. 285.
 ⊙ ELECTRO PRODUCTS LABS., 4501 N. Ravenswood Ave., Chicago 40, Ill. ADV. PG. 199.
 ⊙ GENERAL ELECTRIC CO., Schenectady 5, N. Y. ADV. PG. 1-22.
 ⊙ INDUSTRIAL ELECTRONICS, INC., 8080 Wheeler St., Detroit 10, Mich. ADV. PG. 234, 235.
 ⊙ Menlo Research Laboratory, Menlo Park, Calif.
 ⊙ Photon Instrument Co., 6516 Detroit Ave., Cleveland 2, Ohio.
 ⊙ Scherr Co., Inc., George, 200 Lafayette St., New York 12, N. Y.

ANALYZERS—Ultrasonic

- ⊙ BRUSH DEVELOPMENT CO., 3405 Perkins Ave., Cleveland 14, Ohio. ADV. PG. 228, 229.
 ⊙ PANORAMIC RADIO PRODUCTS, INC., 10 South Second Ave., Mt. Vernon, N. Y. ADV. PG. 383.
 ⊙ WESTON ELECTRICAL INSTRUMENT CORP., 595 Frelinghuysen Ave., Newark 5, N. J. ADV. PG. 243.

ANALYZERS—Vibrator

- ⊙ Aircraft Electronics Associates, Inc., 94 Silas Deane Highway, Rocky Hill, Conn.
 ⊙ CALIDYNE CO., THE, 751 Main St., Winchester, Mass. ADV. PG. 239.
 ⊙ Consolidated Engineering Corp., 300 N. Sierra Madre Villa, Pasadena 8, Calif.
 ⊙ Davies Laboratories, Inc., 4705 Queensbury Rd., Riverdale, Md.
 ⊙ ELECTRO PRODUCTS LABS., 4501 N. Ravenswood Ave., Chicago 40, Ill. ADV. PG. 199.
 ⊙ GENERAL ELECTRIC CO., Schenectady 5, N. Y. ADV. PG. 1-22.
 ⊙ GENERAL RADIO CO., 275 Massachusetts Ave., Cambridge 39, Mass. ADV. PG. 48, 49.
 ⊙ Hart Associates, 8430 Grand River, Detroit 4, Mich.
 ⊙ KAY ELECTRIC CO., 14 Maple Ave., Pine Brook, N. J. ADV. PG. 340.
 ⊙ MMB MFG. CO., 1060 State St., New Haven 11, Conn. ADV. PG. 365.
 ⊙ Midwestern Geophysical Laboratory, 3400 S. Harvard, Tulsa, Okla.
 ⊙ PANORAMIC RADIO PRODUCTS, INC., 10 South Second Ave., Mt. Vernon, N. Y. ADV. PG. 383.
 ⊙ Schauer Mfg. Corp., 2119 Reading Rd., Cincinnati 2, Ohio.
 ⊙ Scott, Inc., Hermon Hosmer, 385 Putnam Ave., Cambridge 39, Mass.
 ⊙ WESTINGHOUSE ELECTRIC CORP., 511 Wood St., P.O. Box 868, Pittsburgh 30, Pa. ADV. PG. 107-113.

ANALYZERS—Video

- ⊙ HICKOK ELECTRICAL INSTRUMENT CO., 10514 Dupont Ave., Cleveland 8, Ohio. ADV. PG. 333.
 ⊙ Jackson Electrical Instrument Co., 16 S. Patterson Blvd., Dayton 1, Ohio.
 ⊙ KAY ELECTRIC CO., 14 Maple Ave., Pine Brook, N. J. ADV. PG. 340.
 ⊙ McMurdo Silver Co., Inc., 473 Lafayette St., New York, N. Y.
 ⊙ Monarch Radio & Television Corp., 2430 Atlantic Ave., Brooklyn 33, N. Y.
 ⊙ POLARAD ELECTRONICS CORP., 100 Metropolitan Ave., Brooklyn 11, N. Y. ADV. PG. 184, 185.
 ⊙ Superior Instruments Co., 227 Fulton St., New York, N. Y.
 ⊙ Telechrome, Inc., 88 Merrick Rd., Amityville, N. Y.

ANALYZERS—Wave

- ⊙ ATOMIC INSTRUMENT CO., 84 Massachusetts Ave., Cambridge 39, Mass. ADV. PG. 40.
 ⊙ BARKER & WILLIAMSON, 235 Fairfield Ave., Upper Darby, Pa. ADV. PG. 292.
 ⊙ Davies Laboratories, Inc., 4705 Queensbury Rd., Riverdale, Md.
 ⊙ Electrodyne Company, 32 Oliver St., Boston, Mass.
 ⊙ GENERAL ELECTRIC CO., Schenectady 5, N. Y. ADV. PG. 1-22.
 ⊙ GENERAL RADIO CORP., 275 Massachusetts Ave., Cambridge 39, Mass. ADV. PG. 48, 49.
 ⊙ HEWLETT-PACKARD CO., 395 Page Mill Rd., Palo Alto, Calif. ADV. PG. 33-36.
 ⊙ Muirhead & Co., Ltd., Beckenham-Kent-England.
 ⊙ PANORAMIC RADIO PRODUCTS, INC., 10 South Second Ave., Mt. Vernon, N. Y. ADV. PG. 383.
 ⊙ Short Wave Plastic Forming Co., 2921 W. Alameda St., Burbank, Calif.
 ⊙ Woodwelding, Inc., 3000 W. Olive Ave., Burbank, Calif.

ANTENNA DRAG UNITS

- ⊙ Bassett, Inc., Rex, 307-11 N.W. First Ave., Fort Lauderdale, Fla.
 ⊙ Lear, Inc., 110 Ionia Ave., NW, Grand Rapids 2, Mich.

ANTENNA FAIRLEADS

- ⊙ Bassett, Inc., Rex, 307-11 N.W. First Ave., Fort Lauderdale, Fla.
 ⊙ GENERAL CERAMICS & STEATITE CORP., Keasbey, N. J. ADV. PG. 126, 127.
 ⊙ Industrial Television, Inc., 359 Lexington Ave., Clifton, N. J.
 ⊙ Molded Insulation Co., 335 E. Price St., Philadelphia 44, Pa.
 ⊙ Telephonics Corp., Park Ave., Huntington, N. Y.

ANTENNA FEED SYSTEMS

- ⊙ AIR ASSOCIATES, INC., Teterboro, N. J. ADV. PG. 211.
 ⊙ Andrew Corp., 363 E. 75th St., Chicago 19, Ill.
 ⊙ BELLING & LEE LTD., 366 Madison Ave., New York 17, N. Y. ADV. PG. 336.
 ⊙ Brach Mfg. Corp., 200 Central Ave., Newark 4, N. J.
 ⊙ Bunnell & Co., J. H., 81 Prospect St., Brooklyn, N. Y.
 ⊙ Diamond Mfg. Co., Wakefield, Mass.
 ⊙ KINGS MICROWAVE CO., INC., 50 Marbledale Rd., Tuckahoe 7, N. Y. ADV. PG. 178, 179.
 ⊙ Lynmar Engineers, Inc., 1721 Delancey St., Philadelphia 3, Pa.
 ⊙ McMurdo Silver Co., Inc., 473 Lafayette St., New York, N. Y.
 ⊙ Network Mfg. Corp., Bayonne, N. J.
 ⊙ Press Wireless Mfg. Co., Inc., Cantlague Rd., Hicksville, N. Y.
 ⊙ PRODUCT DEVELOPMENT CO., INC., Arlington, N. J. ADV. PG. 362.
 ⊙ RADIO CORP. OF AMERICA, RCA Victor Div., General Offices, Camden, N. J. ADV. PG. 177, INSIDE BACK & BACK COVERS.
 ⊙ SPERRY GYROSCOPE CO., Div. of The Sperry Corp., Great Neck, N. Y. ADV. PG. 103, 104.
 ⊙ TECHNICAL APPLIANCE CORP., Sherburne, N. Y. ADV. PG. 378.
 ⊙ Ward Products Corp., Div. of The Gabriel Co., 1523 E. 45th St., Cleveland 9, Ill.
 ⊙ Wind Turbine Co., Tower & Antenna Div., E. Market St. & Penna. R. R., West Chester, Pa.

ANTENNA PEDESTALS—Gear Driven Radar

- ⊙ Bunnell & Co., J. H., 81 Prospect St., Brooklyn, N. Y.
 ⊙ Cossor (Canada) Ltd., 301-303 Windsor St., Halifax, N. S., Canada.
 ⊙ Foote Brothers Gear & Machine Corp., 4545 S. Western Blvd., Chicago 9, Ill.
 ⊙ I-T-E Circuit Breaker Co., 19th & Hamilton Sts., Philadelphia 30, Pa.
 ⊙ Peerless Instrument Co., 90-15 Corona Ave., Elmhurst, N. Y.

V indicates . . . IN PRODUCTION • AVAILABILITY • UNRESTRICTED FOR GENERAL USE

- ⊙ Press Wireless Mfg. Co., Inc., Cantlague Rd., Hickville, N. Y.
- ⊙ Radiomarine Corp. of America, 75 Varick St., New York 13, N. Y.
- ⊙ Robinette Co., W. C., 802 Fair Oaks Ave., South Pasadena, Calif.
- ⊙ Rostan Corp., 202 E. 44th St., New York 17, N. Y.
- ⊙ SPERRY GYROSCOPE CO., Div. of The Sperry Corp., Great Neck, N. Y. ADV. PG. 103, 104.
- ⊙ VECTRON, INC., 235 High St., Waltham, Mass. ADV. PG. 214.
- ⊙ WESTINGHOUSE ELECTRIC CORP., 511 Wood St., P. O. Box 868, Pittsburgh 30, Pa. ADV. PG. 107-113.

ANTENNA REFLECTORS—Radar Parabolic

- ⊙ BART LABS CO., INC., 227 Main St., Belleville 9, N. J. ADV. PG. 148.
- ⊙ Bunnell & Co., J. H., 81 Prospect St., Brooklyn, N. Y.
- ⊙ Cossor (Canada) Ltd., 301-303 Windsor St., Halifax, N. S., Canada.
- ⊙ Gray Mfg. Co., The, 16 Arbor St., Hartford, Conn.
- ⊙ I-T-E Circuit Breaker Co., 19th & Hamilton Sts., Philadelphia 30, Pa.
- ⊙ KELLER PRODUCTS CO., 41 Union St., Manchester, N. H. ADV. PG. 397.
- ⊙ Kennedy & Co., D. S., Cohasset, Mass.
- ⊙ Microwave Equipment Co., Inc., North Caldwell, N. J.
- ⊙ Motorola, Inc., 4545 Augusta Blvd., Chicago 51, Ill.
- ⊙ Network Mfg. Corp., Bayonne, N. J.
- ⊙ PRODUCT DEVELOPMENT CO., INC., Arlington, N. J. ADV. PG. 362.
- ⊙ Racy Electric Co., 52 E. 19th St., New York 3, N. Y.
- ⊙ Radiomarine Corp. of America, 75 Varick St., New York 13, N. Y.
- ⊙ REF Mfg. Corp., Jericho Turnpike, Mineola, N. Y.
- ⊙ Selector Industries, Inc., 401 E. 138th St., New York 54, N. Y.
- ⊙ Teiner Engineering Corp., 115 Madison St., Malden 48, Mass.
- ⊙ WESTINGHOUSE ELECTRIC CORP., 511 Wood St., P. O. Box 868, Pittsburgh 30, Pa. ADV. PG. 107-113.
- ⊙ Weymouth Instrument Co., 1440 Commercial St., East Weymouth 89, Mass.
- ⊙ WORKSHOP ASSOCIATES, INC., 66 Needham Street, Newton Highlands 61, Mass. ADV. PG. 233.

ANTENNA ROTATORS

- ⊙ Alliance Manufacturing Co., Lake Park Blvd., Alliance, Ohio.
- ⊙ AMERICAN PHENOLIC CORP., 1830 S. 54th Ave., Chicago 50, Ill. ADV. PG. 61.
- ⊙ CORNELL-DUBILIER ELECTRIC CORP., South Plainfield, N. J. ADV. PG. 146.
- ⊙ Cossor (Canada) Ltd., 301-303 Windsor St., Halifax, N. S., Canada.
- ⊙ Crown Controls Co., Inc., New Bremen, Ohio.
- ⊙ JOHNSON CO., E. F., Waseca, Minn. ADV. PG. 118, 121.
- ⊙ Premax Products Div., Chisholm-Ryder Co., Inc., Niagara Falls 2, N. Y.
- ⊙ Radiart Corp., The, 3571 W. 62nd St., Cleveland, Ohio.
- ⊙ RADIO CORP. OF AMERICA, RCA Victor Div., General Offices, Camden, N. J. ADV. PG. 177, Inside Back & Back Covers.

ANTENNA TOWERS & SUPPORTS

- ⊙ BELLING & LEE LTD., 366 Madison Ave., New York 17, N. Y. ADV. PG. 336.
- ⊙ Blaw-Knox Div. of Blaw-Knox Co., Farmers Bank Bldg., Pittsburgh 22, Pa.
- ⊙ Bud Radio, Inc., 2118 E. 55th St., Cleveland 3, Ohio.
- ⊙ Dresser Equipment Co., Ideco Div., 875 Michigan Ave., Columbus 8, Ohio.
- ⊙ Easy-Up Tower Co., 427 Romayne Ave., Racine, Wis.
- ⊙ Eltron, Inc., 407 N. Jackson St., Jackson, Mich.
- ⊙ General Cement Mfg. Co., 919 Taylor Ave., Rockford, Ill.
- ⊙ Gonset Co., 72 E. Tujunga Ave., Burbank, Calif.
- ⊙ LA POINTE-PLASCOMOLD CORP., Windsor Locks, Conn. ADV. PG. 297.
- ⊙ Lehigh Structural Steel Co., 17 Battery Pl., New York 4, N. Y.
- ⊙ Lingo & Son, Inc., John E., 28th St. & Buren, Camden, N. J.
- ⊙ PRODUCT DEVELOPMENT CO., INC., Arlington, N. J. ADV. PG. 362.
- ⊙ RADIO CORP. OF AMERICA, RCA Victor Div., General Offices, Camden, N. J. ADV. PG. 177, Inside Back & Back Covers.
- ⊙ Radio Merchandise Sales, Inc., 1165 Southern Blvd., New York 59, N. Y.
- ⊙ Rostan Corp., 202 E. 44th St., New York 17, N. Y.
- ⊙ South River Metal Products Co., South River, N. J.
- ⊙ STAINLESS, INC., Third St., North Wales, Pa. ADV. PG. 387.
- ⊙ Torrington Co., Inc., C. W., 236 Pearl St., Somerville 45, Mass.
- ⊙ TRUSCON STEEL CO., Youngstown, Ohio. ADV. PG. 329.
- ⊙ Wincharger Corp., E. 7th & Division Sts., Sioux City, Iowa.
- ⊙ Wind Turbine Co., Tower & Antenna Div., E. Market St. & Penna. R. R., West Chester, Pa.

ANTENNA TUNING UNITS

- ⊙ Aeronautical Communications Equipment, Inc., 3090 Douglas Rd., Miami 33, Fla.
- ⊙ AMERICAN ELECTRONIC CORP., 5025-29 W. Jefferson Blvd., Los Angeles 16, Calif. ADV. PG. 136.
- ⊙ Andrew Corp., 363 E. 75th St., Chicago 19, Ill.
- ⊙ BARKER & WILLIAMSON, 235 Fairfield Ave., Upper Darby, Pa. ADV. PG. 292.
- ⊙ Bassett, Inc., Rex, 307-11 N.W. First Ave., Fort Lauderdale, Fla.
- ⊙ Bunnell & Co., J. H., 81 Prospect St., Brooklyn, N. Y.
- ⊙ Diamond Mfg. Co., Wakefield, Mass.
- ⊙ Gadgets, Inc., 3629 N. Dixie Drive, Dayton 4, Ohio.
- ⊙ Gates Radio Co., Quincy, Ill.
- ⊙ JOHNSON CO., E. F., Waseca, Minn. ADV. PG. 118, 121.
- ⊙ KINGS MICROWAVE CO., INC., 50 Marbledale Rd., Tuckahoe 7, N. Y. ADV. PG. 178, 179.
- ⊙ McMurdo Silver Co., Inc., 473 Lafayette St., New York, N. Y.
- ⊙ Network Mfg. Corp., Bayonne, N. J.
- ⊙ Press Wireless Mfg. Co., Inc., Cantlague Rd., Hickville, N. Y.
- ⊙ PRODUCT DEVELOPMENT CO., INC., Arlington, N. J. ADV. PG. 362.
- ⊙ RADIO CORP. OF AMERICA, RCA Victor Div., General Offices, Camden, N. J. ADV. PG. 177, Inside Back & Back Covers.
- ⊙ Short Wave Plastic Forming Co., 2921 W. Alameda St., Burbank, Calif.
- ⊙ Standard Electronics Corp., 25 W. 43rd St., New York 18, N. Y.
- ⊙ Technical Materiel Corp., P. O. Box 142, 121 Spencer Place, Mamaroneck, N. Y.
- ⊙ Torrington Co., Inc., C. W., 236 Pearl St., Somerville 45, Mass.
- ⊙ Ward Products Corp., Div. of The Gabriel Co., 1523 E. 45th St., Cleveland 3, Ohio.
- ⊙ WESTINGHOUSE ELECTRIC CORP., 511 Wood St., P. O. Box 868, Pittsburgh 30, Pa. ADV. PG. 107-113.
- ⊙ Woodwelding, Inc., 3000 W. Olive Ave., Burbank, Calif.

ANTENNAS—Airborne Radar Spinner

- ⊙ Avion Instrument Corp., Paramus, N. J.
- ⊙ Hingham Ordnance Co., Hingham Industrial Centre, Hingham, Mass.
- ⊙ Microwave Equipment Co., Inc., North Caldwell, N. J.
- ⊙ SPERRY GYROSCOPE CO., Div. of The Sperry Corp., Great Neck, N. Y. ADV. PG. 103, 104.
- ⊙ Torrington Co., Inc., C. W., 236 Pearl St., Somerville 45, Mass.
- ⊙ WESTINGHOUSE ELECTRIC CORP., 511 Wood St., P. O. Box 868, Pittsburgh 30, Pa. ADV. PG. 107-113.
- ⊙ WORKSHOP ASSOCIATES, INC., 66 Needham St., Newton Highlands 61, Mass. ADV. PG. 233.

ANTENNAS—Aircraft Type

- ⊙ Aeronautical Electronics, Inc., Raleigh-Durham Airport, P.O. Box 6043, Raleigh, N. C.
- ⊙ AIR ASSOCIATES, INC., Teterboro, N. J. ADV. PG. 211.
- ⊙ AIRCRAFT RADIO CORP., Boonton, N. J. ADV. PG. 400, 401.
- ⊙ AMERICAN ELECTRONIC CORP., 5025-29 W. Jefferson Blvd., Los Angeles 16, Calif. ADV. PG. 136.
- ⊙ AMERICAN PHENOLIC CORP., 1830 S. 54th Ave., Chicago 50, Ill. ADV. PG. 61.
- ⊙ Antenna Research Lab., Inc., 797 Thomas Lane, Columbus 14, Ohio.
- ⊙ Avion Instrument Corp., Paramus, N. J.
- ⊙ Bassett, Inc., Rex, 307-11 N. W. First Ave., Fort Lauderdale, Fla.
- ⊙ BELLING & LEE LTD., 366 Madison Ave., New York 17, N. Y. ADV. PG. 336.
- ⊙ Bendix Radio Division, Bendix Aviation Corp., Baltimore 4, Md.
- ⊙ BIRD ELECTRONIC CORP., 1800 E. 38th St., Cleveland 14, Ohio. ADV. PG. 331.
- ⊙ Camburn, Inc., 32-40 57th St., Woodside, N. Y.
- ⊙ Collins Radio Co., Cedar Rapids, Iowa.
- ⊙ Edwards Co., Inc., 86 Boston Post Rd., Norwalk, Conn.
- ⊙ Electro Precision Products Inc., 119-01 22nd Ave., College Point, N. Y.
- ⊙ Flader, Inc., Frederic, 1330 Laskey Rd., Toledo 12, Ohio.
- ⊙ Gadgets, Inc., 3629 N. Dixie Drive, Dayton 4, Ohio.
- ⊙ Hingham Ordnance Co., Hingham Ordnance Centre, Hingham, Mass.
- ⊙ Jarvis Electronics Corp., 6058 W. Fullerton Ave., Chicago 39, Ill.
- ⊙ KINGS MICROWAVE CO., INC., 50 Marbledale Rd., Tuckahoe 7, N. Y. ADV. PG. 178, 179.
- ⊙ Lear, Inc., 110 Ionia Ave., NW., Grand Rapids 2, Mich.
- ⊙ MARCONI INSTRUMENTS, LTD., 23 Beaver St., New York 4, N. Y. ADV. PG. 270.
- ⊙ MITCHELL INDUSTRIES, INC., Camp Wolters, Mineral Wells, Texas. ADV. PG. 298.
- ⊙ Northeastern Engineering, Inc., Manchester, N. H.
- ⊙ Premax Products Div., Chisholm-Ryder Co., Inc., Niagara Falls 2, N. Y.
- ⊙ Schott Co., Walter L., 3225 Exposition Pl., Los Angeles 18, Calif.

- ⊙ Selector Industries, Inc., 401 E. 138th St., New York 54, N. Y.
- ⊙ SPERRY GYROSCOPE CO., Div. of The Sperry Corp., Great Neck, N. Y. ADV. PG. 103, 104.
- ⊙ TECHNICAL APPLIANCE CORP., Sherburne, N. Y. ADV. PG. 378.
- ⊙ Torrington Co., Inc., C. W., 236 Pearl St., Somerville 45, Mass.
- ⊙ Ucinite Division, United-Carr Fastener Corp., 459 Watertown St., Newtonville, Mass.
- ⊙ Ward Products Corp., Div. of The Gabriel Co., 1523 E. 45th St., Cleveland 3, Ohio.
- ⊙ WORKSHOP ASSOCIATES, INC., 66 Needham St., Newton Highlands 61, Mass. ADV. PG. 233.
- ⊙ Z & W Machine Products, Inc., 5151 St. Clair Ave., Cleveland 3, Ohio.

ANTENNAS—All Wave Receiving

- ⊙ AMERICAN PHENOLIC CORP., 1830 S. 54th Ave., Chicago 50, Ill. ADV. PG. 61.
- ⊙ Amy, Aceves & King, Inc., 11 W. 42nd St., New York 18, N. Y.
- ⊙ BART LABS CO., INC., 227 Main St., Belleville 9, N. J. ADV. PG. 148.
- ⊙ Belden Mfg. Co., 4647 W. Van Buren St., Chicago 44, Ill.
- ⊙ BELLING & LEE LTD., 366 Madison Ave., New York 17, N. Y. ADV. PG. 336.
- ⊙ Brach Mfg. Corp., 200 Central Ave., Newark 4, N. J.
- ⊙ Clear Beam Television Antenna Co., 618 N. LaBrea Ave., Los Angeles 36, Calif.
- ⊙ Consolidated Wire & Associated Companies, 1635 S. Clinton St., Chicago 16, Ill.
- ⊙ Electronic Indicator Corp., 259 Green St., Brooklyn 22, N. Y.
- ⊙ Philson Mfg. Co., Inc., 60-66 Sackett St., Brooklyn 31, N. Y.
- ⊙ Radio Merchandise Sales, Inc., 1165 Southern Blvd., New York 59, N. Y.
- ⊙ Scott Radio Labs., Inc., 4451 N. Ravenswood Ave., Chicago 40, Ill.
- ⊙ Serdex, Inc., 91 Cambridge St., Boston, Mass.
- ⊙ TECHNICAL APPLIANCE CORP., Sherburne, N. Y. ADV. PG. 378.
- ⊙ Torrington Co., Inc., C. W., 236 Pearl St., Somerville 45, Mass.
- ⊙ Tricraft Products Co., 1535 N. Ashland Ave., Chicago 22, Ill.
- ⊙ U. H. F. Resonator Co., 224 Seventh St., Racine, Wis.
- ⊙ Ward Products Corp., Div. of The Gabriel Co., 1523 E. 45th St., Cleveland 3, Ohio.
- ⊙ Wind Turbine Co., Tower & Antenna Div., E. Market St. & Penna. R. R., West Chester, Pa.

ANTENNAS—Auto

- ⊙ Bassett, Inc., Rex, 307-11 N. W. First Ave., Fort Lauderdale, Fla.
- ⊙ BELLING & LEE LTD., 366 Madison Ave., New York 17, N. Y. ADV. PG. 336.
- ⊙ Brach Mfg. Corp., 200 Central Ave., Newark 4, N. J.
- ⊙ Buggie & Co., H. H., 726 Stanton St., Toledo, Ohio.
- ⊙ Camburn, Inc., 32-40 57th St., Woodside, N. Y.
- ⊙ Communication Products Co., Inc., Marlboro, N. J.
- ⊙ CORNELL-DUBILIER ELECTRIC CORP., South Plainfield, N. J. ADV. PG. 146.
- ⊙ Dielectric Products Co., Inc., 125 Virginia Ave., Jersey City 5, N. J.
- ⊙ Edwards Co., Inc., 86 Boston Post Rd., Norwalk, Conn.
- ⊙ Electro Craft, Inc., 52 Davenport St., Stamford, Conn.
- ⊙ General Cement Mfg. Co., 919 Taylor Ave., Rockford, Ill.
- ⊙ Insuline Corp. of America, 36-02 35th Ave., Long Island City, N. Y.
- ⊙ La Magna Mfg. Co., Inc., East Rutherford, N. J.
- ⊙ National Electronic Mfg. Corp., 4202 Vernon Blvd., Long Island City, N. Y.
- ⊙ Philco Corp., Tioga & C Sts., Philadelphia 34, Pa.
- ⊙ Philson Mfg. Co., Inc., 60-66 Sackett St., Brooklyn 31, N. Y.
- ⊙ Premax Products Div., Chisholm-Ryder Co., Inc., Niagara Falls 2, N. Y.
- ⊙ Radelco Mfg. Co., 7580 Garfield Blvd., Cleveland 25, Ohio.
- ⊙ Radiart Corp., The, 3571 W. 62nd St., Cleveland 2, Ohio.
- ⊙ Special Products Co., Silver Spring, Md.
- ⊙ Ward Products Corp., Div. of The Gabriel Co., 1523 E. 45th St., Cleveland 3, Ohio.

ANTENNAS—Broadcast Station Radiators

- ⊙ Gates Radio Co., Quincy, Ill.
- ⊙ Lehigh Structural Steel Co., 17 Battery Pl., N. Y. 4, N. Y.
- ⊙ Lingo & Son, Inc., John E., 28th St., & Buren, Camden, N. J.
- ⊙ MARCONI INSTRUMENTS, LTD., 23 Beaver St., New York 4, N. Y. ADV. PG. 270.
- ⊙ Northeastern Engineering, Inc., Manchester, N. H.
- ⊙ PRODUCT DEVELOPMENT CO., INC., Arlington, N. J. ADV. PG. 362.
- ⊙ RADIO CORP. OF AMERICA, RCA Victor Div., General Offices, Camden, N. J. ADV. PG. 177, Inside Back & Back Covers.

Ⓢ indicates . . . IN PRODUCTION • AVAILABILITY • UNRESTRICTED FOR GENERAL USE

- Ⓢ STAINLESS, INC., Third St., North Wales, Pa. ADV. PG. 387.
- Ⓢ Torngren Co., Inc., C. W., 236 Pearl St., Somerville 45, Mass.
- Ⓢ TRUSCON STEEL CO., Youngstown, Ohio. ADV. PG. 329.
- Ⓢ Wincharger Corp., E. 7th & Division Sts., Slou City, Iowa.
- Ⓢ Wind Turbine Co., Tower & Antenna Div., E. Market St. & Penna. R. R., West Chester, Pa.
- Ⓢ WORKSHOP ASSOCIATES, INC., 66 Needham St., Newton Highlands 61, Mass. ADV. PG. 233.

ANTENNAS—Directional Antenna Coupling & Phasing Units

- Ⓢ AIR ASSOCIATES, INC., Teterboro, N. J. ADV. PG. 211.
- Ⓢ AMERICAN ELECTRONEERING CORP., 5025-29 W. Jefferson Blvd., Los Angeles 16, Calif. ADV. PG. 136.
- Ⓢ Andrew Corp., 363 E. 75th St., Chicago 19, Ill.
- Ⓢ BARKER & WILLIAMSON, 235 Fairfield Ave., Upper Darby, Pa. ADV. PG. 292.
- Ⓢ Camburn, Inc., 32-40 57th St., Woodside, N. Y.
- Ⓢ Clear Beam Television Antenna Co., 618 N. LaBrea Ave., Los Angeles 36, Calif.
- Ⓢ Continental Electronics Mfg. Co., 4212-20 S. Buckner Blvd., Dallas 10, Texas.
- Ⓢ Diamond Mfg. Co., Wakefield, Mass.
- Ⓢ Electro Precision Products, Inc., 119-01 22nd Ave., College Point, N. Y.
- Ⓢ FEDERAL TELEPHONE AND RADIO CORP., 88 Kingsland Rd., Clifton, N. J. ADV. PG. 161-163.
- Ⓢ Gates Radio Co., Quincy, Ill.
- Ⓢ JOHNSON CO., E. F., Waseca, Minn. ADV. PG. 118, 121.
- Ⓢ KINGS MICROWAVE CO., INC., 50 Marbledale Rd., Tuckahoe 7, N. Y. ADV. PG. 178, 179.
- Ⓢ Lear, Inc., 110 Ionia Ave., NW., Grand Rapids 2, Mich.
- Ⓢ Microlab, 301 S. Ridgewood Rd., South Orange, N. J.
- Ⓢ Network Mfg. Corp., Bayonne, N. J.
- Ⓢ Northeastern Engineering, Inc., Manchester, N. H.
- Ⓢ Peek, Inc., Walter E., 132 E. 44th St., Indianapolis, Ind.
- Ⓢ RADIO CORP. OF AMERICA, RCA Victor Div., General Offices, Camden, N. J. ADV. PG. 177, Inside Back & Back Covers.
- Ⓢ Selectar Industries, Inc., 401 E. 138th St., New York 54, N. Y.
- Ⓢ SPERRY GYROSCOPE CO., Div. of The Sperry Corp., Great Neck, N. Y. ADV. PG. 103, 104.
- Ⓢ Torngren Co., Inc., C. W., 236 Pearl St., Somerville 45, Mass.
- Ⓢ Ward Products Corp., Div. of The Gabriel Co., 1523 E. 45th St., Cleveland 3, Ohio.
- Ⓢ WESTINGHOUSE ELECTRIC CORP., 511 Wood St., P. O. Box 868, Pittsburgh 30, Pa. ADV. PG. 107-113.
- Ⓢ Wind Turbine Co., Tower & Antenna Div., E. Market St. & Penna. R. R., West Chester, Pa.
- Ⓢ WORKSHOP ASSOCIATES, INC., 66 Needham Street, Newton Highlands 61, Mass. ADV. PG. 233.

ANTENNAS—Dummy Loads

- Ⓢ Aeronautical Communications Equipment, Inc., 3090 Douglas Rd., Miami 33, Fla.
- Ⓢ AIRTRON, INC., 101 E. Elizabeth Ave., Linden, N. J. ADV. PG. 317.
- Ⓢ Antenna Research Lab., Inc., 797 Thomas Lane, Columbus 14, Ohio.
- Ⓢ BIRD ELECTRONIC CORP., 1800 E. 38th St., Cleveland 14, Ohio. ADV. PG. 331.
- Ⓢ Communications Co., Inc., 300 Greco Ave., Coral Gables 34, Fla.
- Ⓢ Electro Precision Products, Inc., 119-01 22nd Ave., College Point, N. Y.
- Ⓢ FEDERAL TELEPHONE & RADIO CORP., 88 Kingsland Rd., Clifton, N. J. ADV. PG. 161-163.
- Ⓢ General R-F Fittings Co., 702 Beacon St., Boston 15, Mass.
- Ⓢ INTERNATIONAL RESISTANCE CO., 401 N. Broad St., Philadelphia 8, Pa. ADV. PG. 134, 135.
- Ⓢ JONES ELECTRONICS CO., M. C., Bristol, Conn. ADV. PG. 384.
- Ⓢ KINGS MICROWAVE CO., INC., 50 Marbledale Rd., Tuckahoe 7, N. Y. ADV. PG. 178, 179.
- Ⓢ McMurdo Silver Co., Inc., 473 Lafayette St., New York, N. Y.
- Ⓢ Microlab, 301 S. Ridgewood Rd., South Orange, N. J.
- Ⓢ Monarch Radio & Television Corp., 2430 Atlantic Ave., Brooklyn 33, N. Y.
- Ⓢ Network Mfg. Corp., Bayonne, N. J.
- Ⓢ Northeastern Engineering, Inc., Manchester, N. H.
- Ⓢ OHMITE MFG. CO., 4835 W. Flournoy St., Chicago 44, Ill. ADV. PG. 41.
- Ⓢ RADIO CORP. OF AMERICA, RCA Victor Div., General Offices, Camden, N. J. ADV. PG. 177, Inside Back & Back Covers.
- Ⓢ Selectar Industries, Inc., 401 E. 138th St., New York 54, N. Y.
- Ⓢ SPERRY GYROSCOPE CO., Div. of The Sperry Corp., Great Neck, N. Y. ADV. PG. 103, 104.
- Ⓢ States Co., 19 New Park Ave., Hartford 6, Conn.
- Ⓢ TELEFON PRODUCTS DIVISION, U. S. GASKET CO., P. O. Box 93, Camden, N. J. ADV. PG. 176.
- Ⓢ Torngren Co., Inc., C. W., 236 Pearl St., Somerville 45, Mass.
- Ⓢ Winslow Co., Inc., 9 Liberty St., Newark 5, N. J.

ANTENNAS—f-m Receiver

- Ⓢ AMERICAN PHENOLIC CORP., 1830 S. 54th Ave., Chicago 50, Ill. ADV. PG. 61.
- Ⓢ Belden Mfg. Co., 4647 W. Van Buren St., Chicago 44, Ill.
- Ⓢ Camburn, Inc., 32-40 57th St., Woodside, N. Y.
- Ⓢ CORNELL-DUBILIER ELECTRIC CORP., South Plainfield, N. J. ADV. PG. 146.
- Ⓢ Dielectric Products Co., Inc., 125 Virginia Ave., Jersey City 5, N. J.
- Ⓢ Edwards Co., Inc., 86 Boston Post Rd., Norwalk, Conn.
- Ⓢ Electro Craft Inc., 52 Davenport St., Stamford, Conn.
- Ⓢ Electronic Indicator Corp., 259 Green St., Brooklyn 22, N. Y.
- Ⓢ Hy-Lite Antennae Inc., 242 E. 137th St., New York 51, N. Y.
- Ⓢ Insuline Corp. of America, 36-02 35th Ave., Long Island City, N. Y.
- Ⓢ J F D MFG. CO., 6101-23 Sixteenth Ave., Brooklyn, N. Y. ADV. PG. 407.
- Ⓢ LAPOINTE-PLASCOMOLD CORP., Windsor Locks, Conn. ADV. PG. 297.
- Ⓢ Motorola, Inc., 4545 Augusta Blvd., Chicago 51, Ill.
- Ⓢ National Electronic Mfg. Corp., 4202 Vernon Blvd., Long Island City, N. Y.
- Ⓢ Oak Ridge Products Mfg. Div. of Video Television, Inc., 37-01 Vernon Blvd., Long Island City 1, N. Y.
- Ⓢ Peek, Inc., Walter E., 132 E. 44th St., Indianapolis, Ind.
- Ⓢ Philco Corp., Tioga & C Sts., Philadelphia 34, Pa.
- Ⓢ Philson Mfg. Co., Inc., 60-66 Sackett St., Brooklyn 31, N. Y.
- Ⓢ Premax Products Div., Chisholm-Ryder Co., Inc., Niagara Falls 2, N. Y.
- Ⓢ Radefco Mfg. Co., 7580 Garfield Blvd., Cleveland 25, Ohio.
- Ⓢ Radiart Corp., The, 3571 W. 62nd St., Cleveland, Ohio.
- Ⓢ RADIO CORP. OF AMERICA, Tube Dept., Harrison, N. J. ADV. PG. 177, Inside Back & Back Covers.
- Ⓢ Radio Merchandise Sales, Inc., 1165 Southern Blvd., New York 59, N. Y.
- Ⓢ Schuttig & Co., Inc., 9th & Kearney Sts., NE, Washington 17, D. C.
- Ⓢ TECHNICAL APPLIANCE CORP., Sherburne, N. Y. ADV. PG. 378.
- Ⓢ Telrex, Inc., Rutherford & Neptune Highway, Asbury Park, N. J.
- Ⓢ Torngren Co., Inc., C. W., 236 Pearl St., Somerville 45, Mass.
- Ⓢ TRAD TELEVISION CORP., 1001 First Ave., Asbury Park, N. J. ADV. PG. 355.
- Ⓢ Tricraft Products Co., 1535 N. Ashland Ave., Chicago 22, Ill.
- Ⓢ U.H.F. Resonator Co., 224 Seventh St., Racine, Wis.
- Ⓢ Ward Products Corp., Div. of The Gabriel Co., 1523 E. 45th St., Cleveland 3, Ohio.
- Ⓢ Warren Mfg. Co., Inc., 250 East St., New Haven, Conn.
- Ⓢ West Coast Electronics Co., 1601 S. Burlington St., Los Angeles 6, Calif.
- Ⓢ Wind Turbine Co., Tower & Antenna Div., E. Market St. & Penna. R. R., West Chester, Pa.
- Ⓢ WORKSHOP ASSOCIATES, INC., 66 Needham St., Newton Highlands 61, Mass. ADV. PG. 233.

ANTENNAS—f-m Transmitter

- Ⓢ Collins Radio Co., Cedar Rapids, Iowa.
- Ⓢ Edwards Co., Inc., 86 Boston Post Rd., Norwalk, Conn.
- Ⓢ Electro Craft Inc., 52 Davenport St., Stamford, Conn.
- Ⓢ Electronic Indicator Corp., 259 Green St., Brooklyn 22, N. Y.
- Ⓢ FEDERAL TELEPHONE & RADIO CORP., 88 Kingsland Rd., Clifton, N. J. ADV. PG. 161-163.
- Ⓢ Gates Radio Co., Quincy, Ill.
- Ⓢ Lingo & Son Inc., John E., 28th St. & Buren Ave., Camden, N. J.
- Ⓢ Motorola, Inc., 4545 Augusta Blvd., Chicago 51, Ill.
- Ⓢ Northeastern Engineering, Inc., Manchester, N. H.
- Ⓢ RADIO CORP. OF AMERICA, RCA Victor Div., General Offices, Camden, N. J. ADV. PG. 177, Inside Back & Back Covers.
- Ⓢ Schuttig & Co., Inc., 9th & Kearney Sts., NE, Washington 17, D. C.
- Ⓢ Torngren Co., Inc., C. W., 236 Pearl St., Somerville 45, Mass.
- Ⓢ Warren Mfg. Co., Inc., 250 East St., New Haven, Conn.
- Ⓢ West Coast Electronics Co., 1601 S. Burlington St., Los Angeles 6, Calif.
- Ⓢ WORKSHOP ASSOCIATES, INC., 66 Needham St., Newton Highlands 61, Mass. ADV. PG. 233.

ANTENNAS—Fixed Station Antenna Systems

- Ⓢ AIR ASSOCIATES, INC., Teterboro, N. J. ADV. PG. 211.
- Ⓢ Andrew Corp., 363 E. 75th St., Chicago 19, Ill.
- Ⓢ Bassett, Inc., Rex, 307-11 N.W. First Ave., Fort Lauderdale, Fla.
- Ⓢ Bendix Aviation Corp., Pacific Division, 11600 Sherman Way, North Hollywood, Calif.
- Ⓢ Capehart-Farnsworth Corp., Fort Wayne, Indiana.
- Ⓢ Communications Co., Inc., 300 Greco Ave., Coral Gables 34, Fla.
- Ⓢ Corsor (Canada), Ltd., 301-303 Windsor St., Halifax, N. S., Canada.

- Ⓢ Dielectric Products Co., Inc., 125 Virginia Ave., Jersey City 5, N. J.
- Ⓢ Erco Radio Labs., Inc., E. Stewart Ave., Garden City, N. Y.
- Ⓢ Gonset Co., 72 E. Tujunga Ave., Burbank, Calif.
- Ⓢ MARCONI INSTRUMENTS, LTD., 23 Beaver St., New York 4, N. Y. ADV. PG. 270.
- Ⓢ Measurement Engineering, Ltd., Arnprior, Ontario, Canada.
- Ⓢ Motorola, Inc., 4545 Augusta Blvd., Chicago 51, Ill.
- Ⓢ Northeastern Engineering, Inc., Manchester, N. H.
- Ⓢ Press Wireless Mfg. Co., Inc., Cantigue Rd., Hicks-ville, N. Y.
- Ⓢ PRODUCT DEVELOPMENT CO., INC., Arlington, N. J. ADV. PG. 362.
- Ⓢ RADIO CORP. OF AMERICA, RCA Victor Div., General Offices, Camden, N. J. ADV. PG. 177, Inside Back & Back Covers.
- Ⓢ Serdex, Inc., 91 Cambridge St., Boston, Mass.
- Ⓢ Torngren Co., Inc., C. W., 236 Pearl St., Somerville 45, Mass.
- Ⓢ U. H. F. Resonator Co., 224 Seventh St., Racine, Wis.
- Ⓢ Ward Products Corp., Div. of The Gabriel Co., 1523 E. 45th St., Cleveland 3, Ohio.
- Ⓢ West Coast Electronics Co., 1601 S. Burlington St., Los Angeles 6, Calif.
- Ⓢ Wind Turbine Co., Tower & Antenna Div., E. Market St. & Penna. R. R., West Chester, Pa.
- Ⓢ WORKSHOP ASSOCIATES, INC., 66 Needham Street, Newton Highlands 61, Mass. ADV. PG. 233.

ANTENNAS—Ground Plane

- Ⓢ AMERICAN ELECTRONEERING CORP., 5025-29 W. Jefferson Blvd., Los Angeles 16, Calif. ADV. PG. 136.
- Ⓢ AMERICAN PHENOLIC CORP., 1830 S. 54th Ave., Chicago 50, Ill. ADV. PG. 61.
- Ⓢ Andrew Corp., 363 E. 75th St., Chicago 19, Ill.
- Ⓢ Bassett, Inc., Rex, 307-11 N.W. First Ave., Fort Lauderdale, Fla.
- Ⓢ Bendix Radio Division, Bendix Aviation Corp., Baltimore 4, Md.
- Ⓢ Edwards Co., Inc., 86 Boston Post Rd., Norwalk, Conn.
- Ⓢ FEDERAL TELEPHONE & RADIO CORP., 88 Kingsland Rd., Clifton, N. J. ADV. PG. 161-163.
- Ⓢ KINGS MICROWAVE CO., INC., 50 Marbledale Rd., Tuckahoe 7, N. Y. ADV. PG. 178, 179.
- Ⓢ Lingo & Son, Inc., John E., 28th St. & Buren Ave., Camden, N. J.
- Ⓢ Measurement Engineering, Ltd., Arnprior, Ontario, Canada.
- Ⓢ Motorola, Inc., 4545 Augusta Blvd., Chicago 51, Ill.
- Ⓢ Network Mfg. Corp., Bayonne, N. J.
- Ⓢ RADIO CORP. OF AMERICA, RCA Victor Div., General Offices, Camden, N. J. ADV. PG. 177, Inside Back & Back Covers.
- Ⓢ Selectar Industries, Inc., 401 E. 138th St., New York 54, N. Y.
- Ⓢ Torngren Co., Inc., C. W., 236 Pearl St., Somerville 45, Mass.
- Ⓢ Ward Products Corp., Div. of The Gabriel Co., 1523 E. 45th St., Cleveland 3, Ohio.
- Ⓢ Wind Turbine Co., Tower & Antenna Div., E. Market St. & Penna. R. R., West Chester, Pa.
- Ⓢ WORKSHOP ASSOCIATES, INC., 66 Needham St., Newton Highlands 61, Mass. ADV. PG. 233.

ANTENNAS—Indoor

- Ⓢ AMERICAN PHENOLIC CORP., 1830 S. 54th Ave., Chicago 50, Ill. ADV. PG. 61.
- Ⓢ BELLING & LEE LTD., 366 Madison Ave., New York 17, N. Y. ADV. PG. 336.
- Ⓢ Camburn, Inc., 32-40 57th St., Woodside, N. Y.
- Ⓢ CORNELL-DUBILIER ELECTRIC CORP., South Plainfield, N. J. ADV. PG. 146.
- Ⓢ Gadgets, Inc., 3629 N. Dixie Drive, Dayton 4, Ohio.
- Ⓢ General Cement Mfg. Co., 919 Taylor Ave., Rockford, Ill.
- Ⓢ Insuline Corp. of America, 36-02 35th Ave., Long Island City, N. Y.
- Ⓢ J F D MFG. CO., 6101-23 Sixteenth Ave., Brooklyn, N. Y. ADV. PG. 407.
- Ⓢ La Magna Mfg. Co., East Rutherford, N. J.
- Ⓢ National Electronic Mfg. Corp., 4202 Vernon Blvd., Long Island City, N. Y.
- Ⓢ Oak Ridge Products Mfg. Div. of Video Television, Inc., 37-01 Vernon Blvd., Long Island City 1, N. Y.
- Ⓢ Philco Corp., Tioga & C Sts., Philadelphia 34, Pa.
- Ⓢ Philmore Mfg. Co., Inc., 113 University Place, New York 3, N. Y.
- Ⓢ Philson Mfg. Co., Inc., 60-66 Sackett St., Brooklyn 31, N. Y.
- Ⓢ Polytren Corp., 133 Martine Ave., White Plains, N. Y.
- Ⓢ Radiart Corp., 3571 W. 61st St., Cleveland, Ohio.
- Ⓢ TECHNICAL APPLIANCE CORP., Sherburne, N. Y. ADV. PG. 378.
- Ⓢ Telrex, Inc., Rutherford & Neptune Highway, Asbury Park, N. J.
- Ⓢ TRAD TELEVISION CORP., 1001 First Ave., Asbury Park, N. J. ADV. PG. 355.
- Ⓢ Tricraft Products Co., 1535 N. Ashland Ave., Chicago 22, Ill.
- Ⓢ Ward Products Corp. Div. of The Gabriel Co., 1523 E. 45th St., Cleveland 3, Ohio.
- Ⓢ Warren Mfg. Co., Inc., 250 East St., New Haven, Conn.

Ⓢ Indicates . . . IN PRODUCTION • AVAILABILITY • UNRESTRICTED FOR GENERAL USE

ANTENNAS—Loop

- Ⓢ AMERICAN PHENOLIC CORP., 1830 S. 54th Ave., Chicago 50, Ill. ADV. PG. 61.
- Ⓢ Bassett, Inc., Rex, 307-11 N. W. First Ave., Fort Lauderdale, Fla.
- Ⓢ Bendix Radio Division, Bendix Aviation Corp., Baltimore 4, Md.
- Ⓢ Blutworth Marine Div., National-Simplex-Blutworth, Inc., 92 Gold St., New York 38, N. Y.
- Ⓢ Elm Laboratories, 18 South Broadway, Dobbs Ferry, N. Y.
- Ⓢ FRANKLIN AIRLOOP CORP., 43-20 34th St., Long Island City, N. Y. ADV. PG. 45.
- Ⓢ FRANKLIN MFG. CORP., A. W., 43-20 34th St., Long Island City, N. Y. ADV. PG. 44.
- Ⓢ Grayburne Corp., 20 South Broadway, Yonkers, N. Y.
- Ⓢ Guthman Inc., Edwin I., 15 S. Throop St., Chicago, Ill.
- Ⓢ J F D MFG. CO., 6101-23 Sixteenth Ave., Brooklyn, N. Y. ADV. PG. 407.
- Ⓢ Lear, Inc., 110 Ionia Ave., NW., Grand Rapids 2, Mich.
- Ⓢ MITCHELL INDUSTRIES, INC., Camp Wolters, Mineral Wells, Texas. ADV. PG. 298.
- Ⓢ Munston Mfg. & Service, Inc., Beech St., Islip, N. Y.
- Ⓢ Philco Corp., Tioga & C Sts., Philadelphia 34, Pa.
- Ⓢ Philmore Mfg. Co., Inc., 113 University Place, New York 3, N. Y.
- Ⓢ Polytron Corp., 133 Martine Ave., White Plains, N. Y.
- Ⓢ PRODUCT DEVELOPMENT CO., INC., Arlington, N. J. ADV. PG. 362.
- Ⓢ Radiomarine Corp. of America, 75 Varick St., New York 13, N. Y.
- Ⓢ Stanwyck Winding Co., 137 Walsh Ave., Newburgh, N. Y.
- Ⓢ Super Electric Products Corp., 46 Oliver St., Newark, N. J.
- Ⓢ Teleradio Engineering Corp., 99 Wall St., New York 5, N. Y.
- Ⓢ TRAD TELEVISION CORP., 1001 First Ave., Asbury Park, N. J. ADV. PG. 355.
- Ⓢ Ward Products Corp., Div. of The Gabriel Co., 1523 W. 45th St., Cleveland 3, Ohio.

ANTENNAS—Marine

- Ⓢ Bassett, Inc., Rex, 307-11 N. W. First Ave., Fort Lauderdale, Fla.
- Ⓢ Blutworth Marine Div., National-Simplex-Blutworth, Inc., 92 Gold St., New York 38, N. Y.
- Ⓢ Communications Co., Inc., 300 Greco Ave., Coral Gables 34, Fla.
- Ⓢ Hose-McCann Telephone Co., Inc., 25th St. & 3rd Ave., Brooklyn 32, N. Y.
- Ⓢ Intervox Corp., 2701 California Ave., Seattle, Wash.
- Ⓢ Jefferson Inc., Ray, 40 E. Merrick Rd., Freeport, N. Y.
- Ⓢ MARCONI INSTRUMENTS, LTD., 23 Beaver St., New York 4, N. Y. ADV. PG. 270.
- Ⓢ Measurement Engineering, Ltd., Arnprlor, Ontario, Canada.
- Ⓢ Munston Mfg. & Service, Inc., Beech St., Islip, N. Y.
- Ⓢ Northeastern Engineering, Inc., Manchester, N. H.
- Ⓢ Premax Products Div., Chisholm-Ryder Co., Inc., Niagara Falls 2, N. Y.
- Ⓢ PRODUCT DEVELOPMENT CO., INC., Arlington, N. J. ADV. PG. 362.
- Ⓢ Radiomarine Corp. of America, 75 Varick St., New York 13, N. Y.
- Ⓢ Ward Products Corp., Div. of The Gabriel Co., 1523 W. 45th St., Cleveland 3, Ohio.

ANTENNAS—Microwave

- Ⓢ AMERICAN ELECTRONIC CORP., 5025-29 W. Jefferson Blvd., Los Angeles 16, Calif. ADV. PG. 136.
- Ⓢ Andrew Corp., 363 E. 75th St., Chicago 19, Ill.
- Ⓢ Antenna Research Lab., Inc., 797 Thomas Lane, Columbus 14, Ohio.
- Ⓢ BART LABS. CO., INC., 227 Main St., Belleville 9, N. J. ADV. PG. 148.
- Ⓢ Bunnell & Co., J. H., 81 Prospect St., Brooklyn, N. Y.
- Ⓢ Cossor (Canada) Ltd., 301-303 Windsor St., Halifax, N. S., Canada.
- Ⓢ Edo Corp., College Point, N. Y.
- Ⓢ Edwards Co., Inc., 86 Boston Post Rd., Norwalk, Conn.
- Ⓢ Elecdec Co., Portsmouth, N. H.
- Ⓢ Electro Precision Products, Inc., 119-01 22nd Ave., College Point, N. Y.
- Ⓢ FEDERAL TELEPHONE AND RADIO CORP., 88 Kingsland Rd., Clifton, N. J. ADV. PG. 161-163.
- Ⓢ Hingham Ordnance Co., Hingham Industrial Centre, Hingham, Mass.
- Ⓢ Kennedy & Co., D. S., Cohasset, Mass.
- Ⓢ KINGS MICROWAVE CO., INC., 50 Marbledale Rd., Tuckahoe 7, N. Y. ADV. PG. 178, 179.
- Ⓢ Lear, Inc., 110 Ionia Ave., NW., Grand Rapids 2, Mich.
- Ⓢ Microlab, 301 S. Ridgewood Rd., South Orange, N. J.
- Ⓢ Microwave Equipment Co., Inc., North Caldwell, N. J.
- Ⓢ Motorola, Inc., 4545 Augusta Blvd., Chicago 51, Ill.
- Ⓢ Network Mfg. Corp., Bayonne, N. J.
- Ⓢ Press Wireless Mfg. Co., Inc., Cantigue Rd., Hicksville, N. Y.
- Ⓢ PRODUCT DEVELOPMENT CO., INC., Arlington, N. J. ADV. PG. 362.

- Ⓢ RADIO CORP. OF AMERICA, RCA Victor Div., General Offices, Camden, N. J. ADV. PG. 177, Inside Back & Back Covers.
- Ⓢ Radio Engineering Labs., Inc., 36-40 37th St., Long Island City 1, N. Y.
- Ⓢ Selector Industries Inc., 401 E. 138th St., New York 54, N. Y.
- Ⓢ SPERRY GYROSCOPE CO., Div. of The Sperry Corp., Great Neck, N. Y. ADV. PG. 103, 104.
- Ⓢ Standard Metals Corp., 262 Broad St., North Attleboro, Mass.
- Ⓢ Torngren Co., Inc., C. W., 236 Pearl St., Somerville 45, Mass.
- Ⓢ Weymouth Instrument Co., 1440 Commercial St., East Weymouth 89, Mass.
- Ⓢ Wheeler Laboratories, Inc., Great Neck, N. Y.
- Ⓢ WORKSHOP ASSOCIATES, INC., 66 Needham St., Newton Highlands 61, Mass. ADV. PG. 233.

ANTENNAS—Radar Receiving & Transmitting

- Ⓢ Antenna Research Lab., Inc., 797 Thomas Lane, Columbus 14, Ohio.
- Ⓢ Avion Instrument Corp., Paramus, N. J.
- Ⓢ Cossor (Canada) Ltd., 301-303 Windsor St., Halifax, N. S., Canada.
- Ⓢ ECLIPSE-PIONEER DIV. BENDIX AVIATION CORP., Teterboro, N. J. ADV. PG. 198, 199.
- Ⓢ Edo Corp., College Point, N. Y.
- Ⓢ Edwards Co., Inc., 86 Boston Post Rd., Norwalk, Conn.
- Ⓢ Electro Precision Products, Inc., 119-01 22nd Ave., College Point, N. Y.
- Ⓢ Hingham Ordnance Co., Hingham Industrial Centre, Hingham, Mass.
- Ⓢ I-T-E Circuit Breaker Co., 19th & Hamilton Sts., Philadelphia 30, Pa.
- Ⓢ Kennedy & Co., D. S., Cohasset, Mass.
- Ⓢ KINGS MICROWAVE CO., INC., 50 Marbledale Rd., Tuckahoe 7, N. Y. ADV. PG. 178, 179.
- Ⓢ La Magna Mfg. Co., Inc., East Rutherford, N. J.
- Ⓢ Microwave Equipment Co., Inc., North Caldwell, N. J.
- Ⓢ Press Wireless Mfg. Co., Inc., Cantigue Rd., Hicksville, N. Y.
- Ⓢ PRODUCT DEVELOPMENT CO., INC., Arlington, N. J. ADV. PG. 362.
- Ⓢ Radiomarine Corp. of America, 75 Varick St., New York 13, N. Y.
- Ⓢ Schott Co., Walter L., 3225 Exposition Pl., Los Angeles 18, Calif.
- Ⓢ Selector Industries, Inc., 401 E. 138th St., New York 54, N. Y.
- Ⓢ SPERRY GYROSCOPE CO., Div. of The Sperry Corp., Great Neck, N. Y. ADV. PG. 103, 104.
- Ⓢ WORKSHOP ASSOCIATES, INC., 66 Needham St., Newton Highlands 61, Mass. ADV. PG. 233.

ANTENNAS—Railroad

- Ⓢ Andrew Corp., 363 E. 75th St., Chicago 19, Ill.
- Ⓢ Bendix Radio Division, Bendix Aviation Corp., Baltimore 4, Md.
- Ⓢ Capehart-Farnsworth Corp., Fort Wayne, Indiana.
- Ⓢ Communications Co., Inc., 300 Greco Ave., Coral Gables 34, Fla.
- Ⓢ Dielectric Products Co., Inc., 125 Virginia Ave., Jersey City 5, N. J.
- Ⓢ FEDERAL TELEPHONE & RADIO CORP., 88 Kingsland Rd., Clifton, N. J. ADV. PG. 161-163.
- Ⓢ Gonsert Co., 72 E. Tujunga Ave., Burbank, Calif.
- Ⓢ Ward Products Corp., Div. of The Gabriel Co., 1523 W. 45th St., Cleveland 3, Ohio.
- Ⓢ WORKSHOP ASSOCIATES, INC., 66 Needham Street, Newton Highlands 61, Mass. ADV. PG. 233.

ANTENNAS—Rotary Beam

- Ⓢ Avion Instrument Corp., Paramus, N. J.
- Ⓢ JOHNSON CO., E. F., Waseca, Minn. ADV. PG. 118, 121.
- Ⓢ Premax Products Div., Chisholm-Ryder Co., Inc., Niagara Falls 2, N. Y.
- Ⓢ TRAD TELEVISION CORP., 1001 First Ave., Asbury Park, N. J. ADV. PG. 355.
- Ⓢ Wind Turbine Co., Tower & Antenna Div., E. Market St. & Penna., R.R., West Chester, Pa.
- Ⓢ WORKSHOP ASSOCIATES, INC., 66 Needham Street, Newton Highlands 61, Mass. ADV. PG. 233.

ANTENNAS—Telescopic

- Ⓢ Brach Mfg. Corp., 200 Central Ave., Newark 4, N. J.
- Ⓢ Camburn, Inc., 32-40 57th St., Woodside, N. Y.
- Ⓢ Doolittle Radio, Inc., 7421 S. Loomis Blvd., Chicago 36, Ill.
- Ⓢ General Cement Mfg. Co., 919 Taylor Ave., Rockford, Ill.
- Ⓢ Insuline Corp. of America, 36-02 35th Ave., Long Island City, N. Y.
- Ⓢ La Magna Mfg. Co., Inc., East Rutherford, N. J.
- Ⓢ National Electronic Mfg. Corp., 4202 Vernon Blvd., Long Island City, N. Y.
- Ⓢ Peerless Instrument Co., 90-15 Corona Ave., Elmhurst, N. Y.

- Ⓢ Philson Mfg. Co., Inc., 60-66 Sackett St., Brooklyn 31, N. Y.
- Ⓢ Premax Products Div., Chisholm-Ryder Co., Inc., Niagara Falls 2, N. Y.
- Ⓢ Radiart Corp., The, 3571 W. 62nd St., Cleveland 2, Ohio.
- Ⓢ Ward Products Corp., Div. of The Gabriel Co., 1523 E. 45th St., Cleveland 3, Ohio.

ANTENNAS—Television

- Ⓢ AMERICAN PHENOLIC CORP., 1830 S. 54th Ave., Chicago 50, Ill. ADV. PG. 61.
- Ⓢ BELLING & LEE LTD., 366 Madison Ave., New York 17, N. Y. ADV. PG. 336.
- Ⓢ Brach Mfg. Corp., 200 Central Ave., Newark 4, N. J.
- Ⓢ Camburn, Inc., 32-40 57th St., Woodside, N. Y.
- Ⓢ Channel Master Co., Ellenville, N. Y.
- Ⓢ COMMUNICATION MEASUREMENTS LAB., INC., 120 Greenwich St., New York 6, N. Y. ADV. PG. 290.
- Ⓢ CORNELL-DUBILIER ELECTRIC CORP., South Plainfield, N. J. ADV. PG. 146.
- Ⓢ Dielectric Products Co., Inc., 125 Virginia Ave., Jersey City 5, N. J.
- Ⓢ FEDERAL TELECOMMUNICATION LABS, INC., 500 Washington Ave., Nutley, N. J. ADV. PG. 164.
- Ⓢ Gadgets, Inc., 3629 N. Dixie Drive, Dayton 4, Ohio.
- Ⓢ General Cement Mfg. Co., 919 Taylor Ave., Rockford, Ill.
- Ⓢ Gonsert Co., 72 E. Tujunga Ave., Burbank, Calif.
- Ⓢ Hy-Lite Antennae, Inc., 242 E. 137th St., New York 51, N. Y.
- Ⓢ Insuline Corp. of America, 36-02 35th Ave., Long Island City, N. Y.
- Ⓢ J F D MFG. CO., 6101-23 Sixteenth Ave., Brooklyn, N. Y. ADV. PG. 407.
- Ⓢ KELLER PRODUCTS CO., 41 Union St., Manchester, N. H. ADV. PG. 397.
- Ⓢ La Magna Mfg. Co., Inc., East Rutherford, N. J.
- Ⓢ LA POINTE-PLASCOMOLD CORP., Windsor Locks, Conn. ADV. PG. 297.
- Ⓢ Lingo & Son, Inc., John E., 28th St. & Buren, Camden, N. J.
- Ⓢ Louis Bros., 3543 E. 16th St., Los Angeles 23, Calif.
- Ⓢ Lyman Electronic Corp., 12 Cass St., Springfield, Mass.
- Ⓢ Lynmar Engineers, Inc., 1721 Delancey St., Philadelphia 3, Pa.
- Ⓢ MARCONI INSTRUMENTS, LTD., 23 Beaver St., New York 4, N. Y. ADV. PG. 270.
- Ⓢ Mattison Television & Radio Corp., 893 Broadway, New York 3, N. Y.
- Ⓢ MODELECTRIC PRODUCTS CORP., 1500 Bangs Ave., Asbury Park, N. J. ADV. PG. 204.
- Ⓢ National Electronic Mfg. Corp., 4202 Vernon Blvd., Long Island City, N. Y.
- Ⓢ Network Mfg. Corp., Bayonne, N. J.
- Ⓢ Oak Ridge Products Mfg. Div. of Video Television, Inc., 37-01 Vernon Blvd., Long Island City 1, N. Y.
- Ⓢ Peek, Inc., Walter E., 132 E. 44th St., Indianapolis, Ind.
- Ⓢ Philco Corp., Tioga & C Sts., Philadelphia 34, Pa.
- Ⓢ Philson Mfg. Co., Inc., 60-66 Sackett St., Brooklyn 31, N. Y.
- Ⓢ Phoenix Electronics Inc., Lawrence, Mass.
- Ⓢ Polytron Corp., 133 Martine Ave., White Plains, N. Y.
- Ⓢ Premax Products Div., Chisholm-Ryder Co., Inc., Niagara Falls 2, N. Y.
- Ⓢ PRODUCT DEVELOPMENT CO., INC., Arlington, N. J. ADV. PG. 362.
- Ⓢ Raceco Mfg. Co., 7580 Garfield Blvd., Cleveland 25, Ohio.
- Ⓢ Radiart Corp., The, 3571 W. 62nd St., Cleveland 2, Ohio.
- Ⓢ RADIO CORP. OF AMERICA, RCA Victor Div., General Offices, Camden, N. J. ADV. PG. 177, Inside Back & Back Covers.
- Ⓢ RADIO CORP. OF AMERICA, Tube Dept., Harrison, N. J. ADV. PG. 177, Inside Back & Back Covers.
- Ⓢ Radio Merchandise Sales, Inc., 1165 Southern Blvd., New York 59, N. Y.
- Ⓢ Schott Co., Walter L., 3225 Exposition Pl., Los Angeles 18, Calif.
- Ⓢ Selector Industries, Inc., 401 E. 138th St., New York 54, N. Y.
- Ⓢ TECHNICAL APPLIANCE CORP., Sherburne, N. Y. ADV. PG. 278.
- Ⓢ Telrex, Inc., Rutherford & Neptune Highway, Asbury Park, N. J.
- Ⓢ Tempo T-V Products Co., 2450 Ramona Blvd., Los Angeles 33, Calif.
- Ⓢ TRAD TELEVISION CORP., 1001 First Ave., Asbury Park, N. J. ADV. PG. 355.
- Ⓢ Transmira Products Corp., 1650 Broadway, New York 19, N. Y.
- Ⓢ Transvision, Inc., 460 North Ave., New Rochelle, N. Y.
- Ⓢ Tricraft Products Co., 1535 N. Ashland Ave., Chicago 22, Ill.
- Ⓢ U. H. F. Resonator Co., 224 Seventh St., Racine, Wis.
- Ⓢ Ward Products Corp., Div. of The Gabriel Co., 1523 E. 45th St., Cleveland 3, Ohio.
- Ⓢ Warren Mfg. Co., Inc., 250 East St., New Haven, Conn.
- Ⓢ WORKSHOP ASSOCIATES, INC., 66 Needham Street, Newton Highlands 61, Mass. ADV. PG. 233.

Ⓢ indicates . . . IN PRODUCTION • AVAILABILITY • UNRESTRICTED FOR GENERAL USE

ANTENNAS—Television Built-in

- ⓈAEROLITE ELECTRONIC HARDWARE CORP., 507 26th St., Union City, N. J. ADV. PG. 355.
- ⓈBestcraft Products, 626 Broadway, New York, N. Y.
- ⓈBRAND & CO., INC., WM., North & Valley Sts., Wilimantic, Conn. ADV. PG. 248, 249.
- Guthman, Inc., Edwin I., 15 S. Throop St., Chicago, Ill.
- Lansky Die Cutting Co., 192½ Greene St., New York 12, N. Y.
- ⓈMattison Television & Radio Corp., 893 Broadway, New York 3, N. Y.
- ⓈNational Tel-Tronics Corp., 35 St. Casmirs Ave., Yonkers, N. Y.
- ⓈPhilco Corp., Tioga & C Sts., Philadelphia 34, Pa.
- ⓈHilmore Mfg. Co., Inc., 113 University Place, New York 3, N. Y.
- ⓈPolytron Corp., 113 Martine Ave., White Plains, N. Y.
- ⓈRaypar, Inc., 7800 W. Addison St., Chicago, Ill.
- ⓈTelrex, Inc., Rutherford & Neptune Highway, Asbury Park, N. J.
- ⓈTelevision Laboratories, Inc., 5045 W. Lake St., Chicago 44, Ill.
- ⓈTRAD TELEVISION CORP., 1001 First Ave., Asbury Park, N. J. ADV. PG. 355.
- ⓈU. S. ELECTRONICS CO., 276 Warren St., Lyndhurst, N. J. ADV. PG. 76.

ANTENNAS—Television Multiple Set

- ⓈAmy, Aceves & King, Inc., 11 W. 42nd St., New York 18, N. Y.
- ⓈBrach Mfg. Corp., 200 Central Ave., Newark 4, N. J.
- ⓈChannel Master Co., Ellenville, N. Y.
- ⓈIndustrial Television, Inc., 359 Lexington Ave., Clifton, N. J.
- ⓈLynnmar Engineers, Inc., 1721 Delancey St., Philadelphia 3, Pa.
- ⓈPhilco Corp., Tioga & C Sts., Philadelphia 34, Pa.
- ⓈPhilson Mfg. Co., Inc., 60-66 Sackett St., Brooklyn 31, N. Y.
- ⓈPolytron Corp., 133 Martine Ave., White Plains N. Y.
- ⓈRADIO CORP. OF AMERICA, RCA Victor Div., General Offices, Camden, N. J. ADV. PG. 177, Inside Back & Back Covers.
- ⓈTECHNICAL APPLIANCE CORP., Sherburne, N. Y. ADV. PG. 378.
- ⓈTelrex, Inc., Rutherford & Neptune Highway, Asbury Park, N. J.
- ⓈTRAD TELEVISION CORP., 1001 First Ave., Asbury Park, N. J. ADV. PG. 355.
- ⓈTransvision, Inc., 460 North Ave., New Rochelle, N. Y.
- ⓈWORKSHOP ASSOCIATES, INC., 66 Needham St., Newton Highlands 61, Mass. ADV. PG. 233.

ANTENNAS—uhf & vhf

- ⓈAIR ASSOCIATES, INC., Teterboro, N. J. ADV. PG. 211.
- ⓈAMERICAN ELECTROENGINEERING CORP., 5025-29 W. Jefferson Blvd., Los Angeles 16, Calif. ADV. PG. 136.
- ⓈAndrew Corp., 363 E. 75th St., Chicago 19, Ill.
- ⓈAntenna Research Lab., Inc., 797 Thomas Lane, Columbus 14, Ohio.
- ⓈAvion Instrument Corp., Paramus, N. J.
- ⓈBendix Radio Division, Bendix Aviation Corp., Baltimore 4, Md.
- ⓈBIRD ELECTRONIC CORP., 1800 E. 38th St., Cleveland 14, Ohio. ADV. PG. 331.
- ⓈBrach Mfg. Corp., 200 Central Ave., Newark 4, N. J.
- ⓈBuggie & Co., H. H., 726 Stanton St., Toledo, Ohio.
- ⓈCollins Radio Co., Cedar Rapids, Iowa.
- ⓈCommunications Co., Inc., 300 Greco Ave., Coral Gables 34, Fla.
- ⓈEdwards Co., Inc., 86 Boston Post Rd., Norwalk, Conn.
- ⓈElectro Precision Products, Inc., 119-01 22nd Ave., College Point, N. Y.
- ⓈFEDERAL TELEPHONE & RADIO CORP., 88 Kingsland Rd., Clifton, N. J. ADV. PG. 161-163.
- Gonsset Co., 72 E. Tujunga Ave., Burbank, Calif.
- ⓈKennedy & Co., D. S., Cohasset, Mass.
- ⓈKINGS ELECTRONICS, 40 Marbledale Rd., Tuckahoe, N. Y. ADV. PG. 180, 181.
- ⓈKINGS MICROWAVE CO., INC., 50 Marbledale Rd., Tuckahoe 7, N. Y. ADV. PG. 178, 179.
- La Magna Mfg. Co., Inc., East Rutherford, N. J.
- ⓈLear, Inc., 110 Ionia Ave., N. W., Grand Rapids 2, Mich.
- ⓈLingo & Son, Inc., John E., 28th & Buren, Camden, N. J.
- ⓈMeasurement Engineering, Ltd., Arnprior, Ontario, Canada.
- ⓈMITCHELL INDUSTRIES, INC., Camp Wolters, Mineral Wells, Texas. ADV. PG. 298.
- ⓈMotorola, Inc., 4545 Augusta Blvd., Chicago 51, Ill.
- ⓈNetwork Mfg. Corp., Bayonne, N. J.
- ⓈNortheastern Engineering, Inc., Manchester, N. H.
- ⓈOak Ridge Products Mfg. Div. of Video Television, Inc., 37-01 Vernon Blvd., Long Island City 1, N. Y.
- ⓈPremax Products Div., Chisholm-Ryder Co., Inc., Niagara Falls 2, N. Y.
- ⓈPRODUCT DEVELOPMENT CO., INC., Arlington, N. J. ADV. PG. 362.
- ⓈRADIO CORP. OF AMERICA, RCA Victor Div., General Offices, Camden, N. J. ADV. PG. 177, Inside Back & Back Covers.

- ⓈRadio Engineering Labs., Inc., 36-40 37th St., Long Island City 1, N. Y.
- ⓈRadio Merchandise Sales, Inc., 1165 Southern Blvd., New York 59, N. Y.
- ⓈSchott Co., Walter L., 3225 Exposition Pl., Los Angeles 18, Calif.
- Selectar Industries, Inc., 401 E. 138th St., New York 54, N. Y.
- ⓈSPERRY GYROSCOPE CO., Div. of the Sperry Corp., Great Neck, N. Y. ADV. PG. 103, 104.
- ⓈSuper Electric Products Corp., 46 Oliver St., Newark, N. J.
- ⓈTECHNICAL APPLIANCE CORP., Sherburne, N. Y. ADV. PG. 378.
- ⓈTelrex, Inc., Rutherford & Neptune Highway, Asbury Park, N. J.
- ⓈU. H. F. Resonator Co., 224 Seventh St., Racine, Wis.
- ⓈWard Products Corp., Div. of The Gabriel Co., 1523 E. 45th St., Cleveland 3, Ohio.
- ⓈWest Coast Electronics Co., 1601 S. Burlington St., Los Angeles 6, Calif.
- ⓈWind Turbine Co., Tower & Antenna Div., E. Market St. & Penna R. R., West Chester, Pa.
- ⓈWORKSHOP ASSOCIATES, INC., 66 Needham St., Newton Highlands 61, Mass. ADV. PG. 233.

ATTENUATORS

- ⓈBELLING & LEE LTD., 366 Madison Ave., New York 17, N. Y. ADV. PG. 336.
- ⓈCarter Parts Co., 213 Institute Place, Chicago 10, Ill.
- ⓈCINEMA ENGINEERING CO., 1510 W. Verdugo Ave., Burbank, Calif. ADV. PG. 204.
- ⓈClarke Instrument Div. National Electrical Machine Shops, Inc., 919 Jesup-Blair Dr., Silver Springs, Md.
- ⓈCLAROSTAT MFG. CO., INC., Dover, N. H. ADV. PG. 100, 101.
- ⓈCORNING GLASS WORKS, Corning, N. Y. ADV. PG. 373.
- ⓈDAVEN CO., 191 Central Ave., Newark 4, N. J. ADV. PG. 157.
- ⓈDiamond Mfg. Co., Wakefield, Mass.
- ⓈGENERAL RADIO CO., 275 Massachusetts Ave., Cambridge 39, Mass. ADV. PG. 48, 49.
- ⓈHEWLETT-PACKARD CO., 395 Page Mill Rd., Palo Alto, Calif. ADV. PG. 33-36.
- ⓈHycor Co., Inc., 11423 Vanowen St., North Hollywood, Calif.
- ⓈKaibfelf Labs., Inc., 1076 Morena Blvd., San Diego 10, Calif.
- ⓈKAY ELECTRIC CO., 14 Maple Ave., Pine Brook, N. J. ADV. PG. 340.
- ⓈKELLOGG SWITCHBOARD & SUPPLY CO., 6650 S. Cicero Ave., Chicago 38, Ill. ADV. PG. 294.
- ⓈKINGS ELECTRONICS, 40 Marbledale Rd., Tuckahoe, N. Y. ADV. PG. 180, 181.
- ⓈKINGS MICROWAVE CO., INC., 50 Marbledale Rd., Tuckahoe 7, N. Y. ADV. PG. 178, 179.
- ⓈLeeds & Northrup Co., 4970 Stenton Ave., Philadelphia 44, Pa.
- ⓈMallory & Co., Inc., P. R., 3029 E. Washington St., Indianapolis 6, Ind.
- ⓈMEASUREMENTS CORP., Boonton, N. J. ADV. PG. 99.
- ⓈMicrolab, 301 S. Ridgewood Rd., South Orange, N. J.
- ⓈMuirhead & Co., Ltd., Beckenham-Kent-England.
- ⓈOHMITE MFG. CO., 4835 W. Flournoy St., Chicago 44, Ill. ADV. PG. 41.
- ⓈPAINTON & CO., LTD., 366 Madison Ave., New York 17, N. Y. ADV. PG. 336.
- ⓈPOLYTECHNIC RESEARCH & DEVELOPMENT CO., INC., 202 Tillary St., Brooklyn 1, N. Y. ADV. PG. 172, 173.
- ⓈSHALLCROSS MFG. CO., 10 Jackson Ave., Collingsdale, Pa. ADV. PG. 261.
- ⓈSPENCER-KENNEDY LABS., INC., 186 Massachusetts Ave., Cambridge 39, Mass. ADV. PG. 166.
- ⓈSPERRY GYROSCOPE CO., Div. of The Sperry Corp., Great Neck, N. Y. ADV. PG. 103, 104.
- ⓈStandard Telephones & Cables Ltd., Connaught House, Aldwych, London, W. C. 2, England.
- ⓈTech. Laboratories, Inc., Bergen & Edsall Blvd., Palisades Park, N. J.
- ⓈVECTRON, INC., 235 High St., Waltham, Mass. ADV. PG. 214.
- ⓈWheeler Laboratories, Inc., Great Neck, N. Y.

ATTENUATORS—Microwave Coaxial Fixed

- Bunnell & Co., J. H., 81 Prospect St., Brooklyn, N. Y.
- ⓈClarke Instrument Div., National Electrical Machine Shops, Inc., 919 Jesup-Blair Dr., Silver Spring, Md.
- ⓈCORNING GLASS WORKS, Corning, N. Y. ADV. PG. 373.
- ⓈDiamond Mfg. Co., Wakefield, Mass.
- ⓈElectro Precision Products, Inc., 119-01 22nd Ave., College Point, N. Y.
- ⓈEmpire Devices, Inc., 38-25 Bell Blvd., Bayside, N. Y.
- ⓈGeneral R-F Fittings Co., 702 Beacon St., Boston 15, Mass.
- ⓈKAY ELECTRIC CO., 14 Maple Ave., Pine Brook, N. J. ADV. PG. 340.
- ⓈKINGS MICROWAVE CO., INC., 50 Marbledale Rd., Tuckahoe 7, N. Y. ADV. PG. 178, 179.
- ⓈMARCONI INSTRUMENTS, LTD., 23 Beaver St., New York 4, N. Y. ADV. PG. 270.
- ⓈMicrolab, 301 S. Ridgewood Rd., South Orange, N. J.
- ⓈMicrowave Equipment Co., Inc., North Caldwell, N. J.

- ⓈNetwork Mfg. Corp., Bayonne, N. J.
- ⓈPOLARAD ELECTRONICS CORP., 100 Metropolitan Ave., Brooklyn 11, N. Y. ADV. PG. 184, 185.
- ⓈPOLYTECHNIC RESEARCH & DEVELOPMENT CO., INC., 202 Tillary St., Brooklyn 1, N. Y. ADV. PG. 172, 173.
- ⓈSchutter Co., Carl W., 80 E. Montauk Pkwy., Lindenhurst, N. Y.
- Selectar Industries, Inc., 401 E. 138th St., New York 54, N. Y.
- ⓈSPERRY GYROSCOPE Div. of The Sperry Corp., Great Neck, N. Y. ADV. PG. 103, 104.
- ⓈStoddart Aircraft Radio Co., 6644 Santa Monica Blvd., Hollywood 38, Calif.
- ⓈWeinschel Engineering Co., 123 William St., New York 7, N. Y.
- Wheeler Laboratories, Inc., Great Neck, N. Y.

ATTENUATORS—Microwave Step

- Bunnell & Co., J. H. 81 Prospect St., Brooklyn, N. Y.
- ⓈDAVEN CO., 191 Central Ave., Newark 4, N. J. ADV. PG. 157.
- ⓈElectro Precision Products, Inc., 119-01 22nd Ave., College Point, N. Y.
- ⓈEmpire Devices, Inc. 38-25 Bell Blvd., Bayside, N. Y.
- ⓈGeneral R-F Fittings Co., 702 Beacon St., Boston, 15, Mass.
- ⓈKAY ELECTRIC CO., 14 Maple Ave., Pine Brook, N. J. ADV. PG. 340.
- ⓈKINGS MICROWAVE CO., INC., 50 Marbledale Rd., Tuckahoe 7, N. Y. ADV. PG. 178, 179.
- ⓈMARCONI INSTRUMENTS, LTD., 23 Beaver St., New York 4, N. Y. ADV. PG. 270.
- ⓈMicrolab, 301 S. Ridgewood Rd., South Orange, N. J.
- ⓈMicrowave Equipment Co., Inc., North Caldwell, N. J.
- ⓈPOLARAD ELECTRONICS CORP., 100 Metropolitan Ave., Brooklyn, 11, N. Y. ADV. PG. 184, 185.
- ⓈSchutter Co., Carl W., 80 E. Montauk Pkwy., Lindenhurst, N. Y.
- Selectar Industries, Inc., 401 E. 138th St., New York 54, N. Y.
- ⓈStoddart Aircraft Radio Co., 6644 Santa Monica Blvd., Hollywood 38, Calif.
- ⓈTech Laboratories, Inc., Bergen & Edsall Blvds., Palisades Park, N. J.
- ⓈWeinschel Engineering Co., 123 William St., New York 7, N. Y.
- ⓈWheeler Laboratories, Inc., Great Neck, N. Y.

AUDIOMETERS

- ⓈAurex Corp., Chicago 10, Ill.
- ⓈMaico Co., Inc., 21 North Third St., Minneapolis 1, Minn.
- ⓈMARCONI INSTRUMENTS LTD., 23 Beaver St., New York 4, N. Y. ADV. PG. 270.
- ⓈTech Laboratories, Inc., Bergen & Edsall Blvds., Palisades Park, N. J.

BAFFLES—Speaker

- ⓈAltec Lansing Corp., 9356 Santa Monica Blvd., Beverly Hills, Calif.
- ⓈAtlas Sound Corp., 1443 39th St., Brooklyn 18, N. Y.
- ⓈBell Sound Systems, Inc., 555 Marion Rd., Columbus 7, Ohio.
- ⓈBud Radio, Inc., 2118 E. 55th St., Cleveland 3, Ohio.
- ⓈButler Mfg. Co., Inc., B. B., 3432 N. Avondale Ave., Chicago 18, Ill.
- ⓈCollins Audio Products Co., P. O. Box 368, Westfield, N. J.
- ⓈCortland Industries, Inc., 4545 Cortland St., Chicago 39, Ill.
- ⓈCossor (Canada), Ltd., 301-303 Windsor St., Halifax, N. S., Canada.
- ⓈELECTRO-VOICE, INC., Buchanan, Mich. ADV. PG. 345.
- ⓈFLOCK PROCESS CO., INC., 28 Fahey St., Springdale, Conn. ADV. PG. 196.
- ⓈGasket Engineering Co., 2440 Charlotte St., Kansas City 8, Mo.
- ⓈHartley Co., Ltd., H. A., 152 Hammersmith Rd., London W. 6, England.
- ⓈHawley Products Co., St. Charles, Ill.
- ⓈHoll Audio Industries, 9215 Venice Blvd., Los Angeles 34, Calif.
- ⓈIllinois Wood Products Corp., 1656 N. Besly Court, Chicago 22, Ill.
- ⓈInsuline Corp. of America, 36-02 35th Ave., Long Island City, N. Y.
- ⓈKlipsch & Associates, Hope, Ark.
- Lansky Die Cutting Co., 192½ Greene St., New York 12, N. Y.
- ⓈMagna Electronics Co., 3707-11 W. Jefferson Blvd., Los Angeles 16, Calif.
- ⓈMattison Television & Radio Corp., 893 Broadway, New York 3, N. Y.
- ⓈNewcomb Audio Products Co., 6824 Lexington Ave., Hollywood 38, Calif.
- ⓈOperadio Mfg. Co., 135th & Indiana St., St. Charles, Ill.
- ⓈPentron Corp., 221 E. Cullerton St., Chicago 16, Ill.

V indicates . . . IN PRODUCTION • AVAILABILITY • UNRESTRICTED FOR GENERAL USE

- ⊙PERMOFLUX CORP., 4900 W. Grand Ave., Chicago 39, Ill. ADV. PG. 321.
- ⊙RACON Electric Co., 52 E. 19th St., New York 3, N. Y.
- ⊙RADIO CORP. OF AMERICA, RCA Victor Div., General offices, Camden, N. J. ADV. PG. 177, Inside Back & Back Covers.
- ⊙Rauland-Borg Corp., 3523 W. Addison St., Chicago 18, Ill.
- ⊙UNIVERSITY LOUDSPEAKERS, INC., 80 S. Kensico Ave., White Plains, N. Y. ADV. PG. 38.
- ⊙Vibracolor Corporation, 425 Bush St., San Francisco 8, Calif.
- ⊙Waveforms, Inc., 333 Sixth Ave., New York 14, N. Y.

BARRETTERS

- ⊙MEASUREMENTS CORP., Boonton, N. J. ADV. PG. 99.
- ⊙POLYTECHNIC RESEARCH & DEVELOPMENT CO., INC., 202 Tillary St., Brooklyn 1, N. Y. ADV. PG. 172, 173.
- ⊙SPERRY GYROSCOPE CO., Div. of The Sperry Corp., Great Neck, N. Y. ADV. PG. 103, 104.

BASES—Relay

- ⊙ALDEN PRODUCTS CO., 117 No. Main St., Brockton 64, Mass. ADV. PG. 327.
- ⊙American Scientific Co., P. O. Box 11, High Bridge Station, New York 52, N. Y.
- ⊙Automatic Electric Sales Corp., 1033 W. Van Buren St., Chicago 7, Ill.
- ⊙HERMETIC SEAL PRODUCTS CO., 29-37 South 6th St., Newark 7, N. J. ADV. PG. 175.
- ⊙Kuhn & Jacob Molding & Tool Co., 1200 Southard St., Trenton, N. J.
- ⊙PIX MFG. CO., 24 Bedford St., Newark, N. J. ADV. PG. 136.
- ⊙Walter Co., Inc., S., 1400 Atlantic Ave., Brooklyn 16, N. Y.

BATTERIES—Dry

- Acme Battery Co., 59 Pearl St., Brooklyn 1, N. Y.
- ⊙Bond Electric Corp., Div. of Olin Industries, Inc., New Haven 4, Conn.
- ⊙Bright Star Battery Co., 200 Crooks Ave., Clifton, N. J.
- ⊙BURGESS BATTERY CO., Battery Div., Freeport, Ill. ADV. PG. 295.
- ⊙KELLOGG SWITCHBOARD & SUPPLY CO., 6650 S. Cicero Ave., Chicago 38, Ill. ADV. PG. 294.
- ⊙Mallory & Co., Inc., P. R., 3029 E. Washington St., Indianapolis 6, Ind.
- ⊙Manufacturers Battery Co., Sub. of Ray-O-Vac Co., Madison, Wis.
- ⊙Marathon Battery Co., Wasau, Wis.
- ⊙NATIONAL CARBON CO., DIVISION of Union Carbide & Carbon Corp., 30 E. 42nd St., New York 17, N. Y. ADV. PG. 42.
- ⊙Olin Industries, Inc., Electrical Div., New Haven 4, Conn.
- ⊙Phico Corp., Tioga & C Sts., Philadelphia 34, Pa.
- ⊙RADIO CORP. OF AMERICA, Tube Dept., Harrison, N. J. ADV. PG. 177, Inside Back & Back Covers.
- ⊙Ray-O-Vac Co., Madison, Wisconsin.
- ⊙SPECIALTY BATTERY CO., Madison 4, Wisconsin. ADV. PG. 364.
- ⊙Sprague Electric Co., North Adams, Mass.
- ⊙Winchester Repeating Arms Co., Div. of Olin Industries, Inc., New Haven, Conn.
- ⊙Willard Storage Battery Co., 246 E. 131st St., Cleveland 1, Ohio.

BATTERIES—Standard Cell

- Acme Battery Co., 59 Pearl St., Brooklyn 1, N. Y.
- ⊙Bond Electric Corp., Div. of Olin Industries, Inc., New Haven, Conn.
- ⊙Winchester Repeating Arms Co., Div. of Olin Industries, Inc., New Haven, Conn.

BATTERIES—Storage

- ⊙Bowers Battery & Spark Plug Co., Reading, Pa.
- ⊙Electric Storage Battery Co., Allegheny Ave. & 19th St., Philadelphia 32, Pa.
- ⊙General Lead Batteries Co., 196 W. Railway Ave., Paterson, N. J.
- ⊙Gould-National Batteries, Inc., 35 Neoga St., Depew, N. Y.
- ⊙KELLOGG SWITCHBOARD & SUPPLY CO., 6650 S. Cicero Ave., Chicago 38, Ill. ADV. PG. 294.
- ⊙Nickel Cadmium Battery Corp., Easthampton, Mass.
- ⊙Vitamite Co., The, 227 W. 64th St., New York 23, N. Y.
- ⊙Willard Storage Battery Co., 246 E. 131st St., Cleveland 1, Ohio.
- ⊙Yardney Electric Corp., 105 Chambers St., New York 7, N. Y.

BATTERIES—Storage Nonspill

- ⊙Bowers Battery & Spark Plug Co., Reading, Pa.
- ⊙Electric Storage Battery Co., Allegheny Ave. & 19th St., Philadelphia 32, Pa.
- ⊙Electronic Batteries Inc., Bush Terminal Bldg., No. 4, 28-34 Thirty Fifth St., Brooklyn 32, N. Y.
- ⊙Gould-National Batteries, Inc., 35 Neoga St., Depew, N. Y.
- ⊙Nickel Cadmium Battery Corp., Easthampton, Mass.
- ⊙Sonotone Corp., P. O. Box 200 Saw Mill River Rd., Elmsford, N. Y.
- ⊙Vitamite Co., The, 227 W. 64th St., New York 23, N. Y.
- ⊙Willard Storage Battery Co., 246 E. 131st St., Cleveland 1, Ohio.
- ⊙Yardney Electric Corp., 105 Chambers St., New York 7, N. Y.

BATTERY CHARGERS

- ⊙ACME ELECTRIC CORP., 31 Water St., Cuba, N. Y. ADV. PG. 90.
- ⊙AIRPAX PRODUCTS CO., Middle River, Baltimore 20, Md. ADV. PG. 289.
- ⊙AMERICAN TELEVISION & RADIO CO., 300 E. 4th St., St. Paul 1, Minn. ADV. PG. 266.
- ⊙Amglo Corp., 4234 Lincoln Ave., Chicago 18, Ill.
- ⊙Baldor Electric Co., 4353 Duncan Avenue, St. Louis, Mo.
- ⊙BOGUE ELECTRIC MFG. CO., 52 Iowa Ave., Paterson 3, N. J. ADV. PG. 155.
- ⊙Bowers Battery & Spark Plug Co., Reading, Pa.
- ⊙Dresser Electric Co., 942 E. Larned St., Detroit 7, Mich.
- ⊙Edwards Co., Inc., 86 Boston Post Rd., Norwalk, Conn.
- ⊙Electric Storage Battery Co., Allegheny Ave. & 19th St., Philadelphia 32, Pa.
- Electricoil Transformer Co., Westerly Rd., Ossining, N. Y.
- ⊙ELECTRONIC INSTRUMENT CO., INC., 276 Newport St., Brooklyn 12, N. Y. ADV. PG. 129.
- Electronic Products Div., Epco Products, Inc., 2430 Atlantic Ave., Brooklyn 33, N. Y.
- ⊙Fansteel Metallurgical Corp., 2200 Sheridan Rd., North Chicago, Ill.
- ⊙FEDERAL TELEPHONE AND RADIO CORP., 88 Kingsland Rd., Clifton, N. J. ADV. PG. 161-163.
- ⊙FERRANTI ELECTRIC, INC., 30 Rockefeller Plaza, New York 20, N. Y. ADV. PG. 159.
- ⊙GENERAL ELECTRIC CO., Schenectady 5, N. Y. ADV. PG. 1 to 22.
- ⊙General Transformer Co., 18240 Harwood Ave., Homewood, Ill.
- ⊙Georator Corp., 1820 N. Nash St., Arlington, Va.
- ⊙Gould-National Batteries, Inc., 35 Neoga St., Depew, N. Y.
- ⊙Hobby & Brown Mfg. Corp., 55 Front St., Rockville Center, N. Y.
- ⊙Inet, Inc., 8655 S. Main St., Los Angeles 3, Calif.
- ⊙Kato Engineering Co., 1415 First Ave., Mankato, Minn.
- ⊙KELLOGG SWITCHBOARD & SUPPLY CO., 6650 S. Cicero Ave., Chicago 38, Ill. ADV. PG. 294.
- ⊙KEPCO LABS., INC., 149-14 41st Ave., Flushing, N. Y. ADV. PG. 54.
- ⊙King Electric Equipment Co., 9123 Inman Ave., Cleveland 5, Ohio.
- ⊙McColpin-Christie Corp., 3410 W. 67th St., Los Angeles 43, Calif.
- ⊙Mallory & Co., Inc., P. R., 3029 E. Washington St., Indianapolis 6, Ind.
- ⊙Mellaphone Corp., Rochester 2, N. Y.
- ⊙MOELECTRIC PRODUCTS CORP., 1500 Bangs Ave., Asbury Park, N. J. ADV. PG. 204.
- ⊙Motorola, Inc., 4545 Augusta Blvd., Chicago 51, Ill.
- ⊙OPAD-GREEN CO., 71-5 Warren St., New York 7, N. Y. ADV. PG. 314.
- ⊙Peschel Electronics, Inc., 13 Garden St., New Rochelle, N. Y.
- ⊙Power Equipment Co., 55 Antoinette St., Detroit 2, Mich.
- ⊙Radiart Corp., 3571 W. 62nd St., Cleveland, Ohio.
- ⊙RAYTHEON MFG. CO., Equipment Sales Div., Waltham 54, Mass. ADV. PG. 80, 81.
- ⊙Schauer Mfg. Corp., 2119 Reading Rd. Cincinnati 2, Ohio.
- ⊙Sonotone Corp., P. O. Box 200, Saw Mill River Rd., Elmsford, N. Y.
- ⊙The Electric & Machine Works, 15 S. Jefferson St., Chicago, Ill.
- ⊙TRAD TELEVISION CORP., 1001 First Ave., Asbury Park, N. J. ADV. PG. 355.
- ⊙Triumph Mfg. Co., 913 W. Van Buren St., Chicago 7, Ill.
- ⊙Vitamite Co., The, 227 W. 64th St., New York 23, N. Y.
- ⊙WESTINGHOUSE ELECTRIC CORP., 511 Wood St., P. O. Box 868, Pittsburgh 30, Pa. ADV. PG. 107-113.
- ⊙Willard Storage Battery Co., 246 E. 131st St., Cleveland 1, Ohio.

BATTERY CHARGERS—Gas Engine Driven

- ⊙BOGUE ELECTRIC MFG. CO., 52 Iowa Ave., Paterson 3, N. J. ADV. PG. 155.

- ⊙Homelite Corp., Port Chester, N. Y.
- ⊙Kato Engineering Co., 1415 First Ave., Mankato, Minn.
- ⊙Onan & Sons, Inc., D. W., 3264 University Ave. SE, Minneapolis 14, Minn.

BEARINGS—Jewel

- ⊙BIRD CO., RICHARD H., 1 Spruce Street., Waltham, Mass. ADV. PG. 60.
- ⊙Eastern Specialty Co., Philadelphia 40, Pa.
- ⊙Gatti Inc., Aurele M., 524 E. Washington St., Trenton, N. J.
- ⊙GENERAL ELECTRIC CO., Schenectady 5, N. Y. ADV. PG. 1 to 22.
- ⊙Steel Co., Herman D., Lafayette Bldg., Philadelphia 6, Pa.
- ⊙Swiss Jewel Co., Lafayette Bldg., Philadelphia 6, Pa.
- ⊙Vallorbs Jewel Co., Lancaster, Pa.

BEARINGS—Miniature

- ⊙Amplex Division, Chrysler Corp., Detroit 31, Mich.
- ⊙Fafnir Bearing Co., New Britain, Conn.
- ⊙GENERAL ELECTRIC CO., Schenectady 5, N. Y. ADV. PG. 1 to 22.
- ⊙Landis & Gyr, Inc., 104 Fifth Ave., New York 11, N. Y.
- ⊙MINIATURE PRECISION BEARINGS, INC., Keene, N. H. ADV. PG. 83.
- ⊙NEW HAMPSHIRE BALL BEARINGS, 5 Main St., Petersborough, N. H. ADV. PG. 305.
- ⊙Precision Devices, Inc., 147-149 Cedar St., New York 6, N. Y.
- ⊙TEFLON PRODUCTS DIVISION, U. S. GASKET CO., P. O. Box 93, Camden, N. J. ADV. PG. 176.

BELLOWS

- ⊙BREEZE CORPS., INC., 41 S. Sixth St., Newark 7, N. J. ADV. PG. 193.
- ⊙Chicago Metal Hose Corp., 1315 S. Third Ave., Maywood, Ill.
- ⊙Fulton Siphon Div., Robertshaw-Fulton Controls Co., Knoxville 4, Tenn.
- ⊙TEFLON PRODUCTS DIVISION, U. S. GASKET CO., P. O. Box 93, Camden, N. J. ADV. PG. 176.
- ⊙TITFLEX INC., 500 Frelinghuysen Ave., Newark 5, N. J. ADV. PG. 68.

BELTS—Dial Drive

- ⊙General Cement Mfg. Co., 919 Taylor Ave., Rockford, Ill.
- ⊙J F D MFG. CO., 6101-23 Sixteenth Ave., Brooklyn, N. Y. ADV. PG. 407.
- ⊙Phico Corp., Tioga & C Sts., Philadelphia 34, Pa.
- ⊙Schott Co., Walter L., 3225 Exposition Pl., Los Angeles 18, Calif.
- ⊙Ton-Tex Corp., 247 Pearl St., N. W., Grand Rapids 2, Mich.
- ⊙WHITE DENTAL MFG. CO., S. S., Industrial Div., 10 E. 40th St., New York, N. Y. ADV. PG. 291.

BENCH TEST SET-UPS

- Bunnell & Co., J. H., 81 Prospect St., Brooklyn, N. Y.
- ⊙Northeastern Engineering Co., Manchester, N. H.
- ⊙PENNSYLVANIA TESTING LABORATORY, Doylestown, Pa. ADV. PG. 350.
- ⊙Precision Devices, Inc., 147-149 Cedar St., New York 6, N. Y.
- ⊙REEVES INSTRUMENT CORP., 215 E. 91st St., New York, N. Y. ADV. PG. 315

BLOCKS—Fuse Blocks & Holders

- ⊙AEROLITE ELECTRONIC HARDWARE CORP., 507 26th St., Union City, N. J. ADV. PG. 355.
- ⊙ALDEN PRODUCTS CO., 117 N. Main St., Brockton 64, Mass. ADV. PG. 327.
- ⊙Bel Fuse, Inc., 311 Mountain Road, Union City, N. J.
- ⊙BELLING & LEE LTD., 366 Madison Ave., New York 17, N. Y. ADV. PG. 336.
- ⊙BUSSMANN MFG. CO., St. Louis 7, Mo. ADV. PG. 210.
- ⊙CINCH MFG. CORP., 1026 S. Homan Ave., Chicago 24, Ill. ADV. PG. 186, 187.
- ⊙CITATION PRODUCTS CO., 233 E. 146th St., New York 51, N. Y. ADV. PG. 388.
- ⊙EBV, INC., HUGH H., 4700 Stenton Ave., Philadelphia 44, Pa. ADV. PG. 214.
- ⊙GENERAL ACCESSORIES CO., LTD., 366 Madison Ave., New York 17, N. Y. ADV. PG. 336.
- ⊙General Cement Mfg. Co., 919 Taylor Ave., Rockford, Ill.
- Insulation Mfg. Co., 11 New York Ave., Brooklyn, N. Y.
- ⊙Insuline Corp. of America, 36-02 35th Ave., Long Island City, N. Y.
- ⊙JONES DIV., HOWARD B., Cinch Mfg. Corp. 1026 S. Homan Ave., Chicago 24, Ill. ADV. PG. 186, 187

V indicates . . . **IN PRODUCTION • AVAILABILITY • UNRESTRICTED FOR GENERAL USE**

- ⓪Keystone Electronics Corp., 423 Broome St., New York 12, N. Y.
- ⓪Koltan Electric Mfg. Co., 123 N. J. Railroad Ave., Newark 5, N. J.
- ⓪LITTELFUSE, INC., 4757 Ravenswood Ave., Chicago 40, Ill. ADV. PG. 285
- ⓪Loral Electronics Corp., 794 E. 140th St., New York 54, N. Y.
- ⓪NEO-SIL CORP., 26 Cornelison Ave., Jersey City 4, N. J. ADV. PG. 253.
- ⓪Penn-Union Electric Corp., 315 State St. Erie, Pa.
- ⓪Wade Electric Products Co., 211 Jacob St., Sturgis, Mich.

BLOWERS—Small

- ⓪AIR-MARINE MOTORS, INC., 2183 Jackson Ave., Seaford, N. Y. ADV. PG. 376.
- ⓪Dynamic Air Engineering Inc., 1619 So. Alameda St., Los Angeles 11, Calif.
- ⓪Eastern Air Devices, Inc., 585 Dean St., Brooklyn 17, N. Y.
- ⓪EISLER ENGINEERING CO., INC., 740 S. 13th St., Newark 3, N. J. ADV. PG. 378.
- ⓪Fasco Industries, Inc., Rochester 2, N. Y.
- ⓪Gale Dorothea Mechanisms, 37-61 85th St., Jackson Heights, N. Y.
- ⓪GENERAL ELECTRIC CO., Schenectady 5, N. Y. ADV. PG. 1 to 22.
- ⓪HEINZE ELECTRIC CO., 685 Lawrence St., Lowell, Mass. ADV. PG. 314.
- ⓪Illg Electric Ventilating Co., 2850 N. Crawford Ave., Chicago 43, Ill.
- ⓪Leiman Brothers, 114 Christie St., Newark 5, N. J.
- ⓪Master Appliance Mfg. Co., Fourth & Ontario Sts., Ontario, Wis.
- ⓪Mission Electric Mfg. Co., 132 W. Colorado Blvd., Pasadena, Calif.
- ⓪Redmond Co., Inc., Owosso, Mich.
- ⓪Ripley Co. Inc., Middletown, Conn.
- ⓪ROTRON MFG. CO., INC., 7-9 Schoonmaker Lane, Woodstock, N. Y. ADV. PG. 410.
- ⓪Universal Electric Co., 300 E. Main St., Owosso, Mich.
- ⓪Welch Scientific Co., W. M., 1515 Sedgwick St., Chicago 10, Ill.
- ⓪WESTINGHOUSE ELECTRIC CORP., 511 Wood St., P. O. 868, Pittsburgh 30, Pa. ADV. PG. 107-113.

BOARDS—Capacitor or Resistor

- ⓪ALDEN PRODUCTS CO., 117 N. Main St., Brockton 64, Mass. ADV. PG. 327.
- ⓪BELLING & LEE LTD., 366 Madison Ave., New York 17, N. Y. ADV. PG. 336.
- ⓪CINCH MFG. CORP., 1026 S. Homan Ave., Chicago 24, Ill. ADV. PG. 186, 187.
- ⓪FRANKLIN AIRLOOP CORP., 43-20 34th St., Long Island City, N. Y. ADV. PG. 45.
- ⓪FRANKLIN MFG. CORP., A. W., 43-20 34th St., Long Island City, N. Y. ADV. PG. 44.
- ⓪Industrial Electronics Co., Hanover, Mass.
- ⓪Insuline Corp. of America, 36-02 35th Ave., Long Island City, N. Y.
- ⓪Loral Electronics Corp., 794 E. 140th St., New York 54, N. Y.
- ⓪Plastics & Electronics Co., Inc., P. O. Box 38, Station J, Buffalo 8, N. Y.

BOBBINS—Coil Winding

- ⓪AMERICAN LAVA CORP., Chatanooga 5, Tenn. ADV. PG. 143.
- ⓪AMERICAN MOLDED PRODUCTS CO., 1644 N. Honore St., Chicago 22, Ill. ADV. PG. 382.
- ⓪CLEVELAND CONTAINER CO., THE, 6201 Barberton Ave., Cleveland 2, Ohio. ADV. PG. 89.
- ⓪Electran Mfg. Co., 1901 N. Clybourn, Chicago, Ill.
- ⓪ELECTRONIC TRANSFORMER CO., INC., 215 W. 25th St., New York, N. Y. ADV. PG. 278.
- ⓪EMELOID CO., INC., THE, 1239 Central Ave., Hillside N. J. ADV. PG. 102.
- ⓪Gries Reproducer Corp., 100 Willow Ave., New York 54, N. Y.
- ⓪Insulation Mfg. Co., 11 New York Ave., Brooklyn, N. Y.
- ⓪Kirchberger & Co., Inc., M., 1425 Thirty-Seventh St., Brooklyn 18, N. Y.
- ⓪Kuhn & Jacob Molding & Tool Co., 1200 Southland St., Trenton, N. J.
- ⓪Mayfair Molded Products Corp., 4440 N. Elston Ave., Chicago 30, Ill.
- ⓪PRECISION PAPER TUBE CO., 2033 W. Charleston St., Chicago 47, Ill. ADV. PG. 156.
- ⓪Rolan Electrical Co., 8020 S. Park, Chicago, Ill.
- ⓪Spaulding Fibre Co., Inc., 310 Wheeler St., Tonawanda, N. Y.
- ⓪THOR CERAMICS INC., 225 Belleville Ave., Bloomfield, N. J. ADV. PG. 378.
- ⓪U. S. ELECTRONICS CORP., 276 Warren St., Lyndhurst, N. J. ADV. PG. 76.

BOLOMETERS

- ⓪BaIRD Associates, Inc., 33 University Rd., Cambridge 38, Mass.

- ⓪Farrand Optical Co., Inc., Bronx Blvd. at 238th St., New York 70, N. Y.
- ⓪Fredericks Co., Geo. E. Bethayres, Pa.
- ⓪General R-F Fittings Co., 702 Beacon St., Boston 15, Mass.
- ⓪GENERAL RADIO CO., 275 Massachusetts Ave., Cambridge 39, Mass. ADV. PG. 48, 49.
- ⓪KINGS MICROWAVE CO., INC., 50 Marbledale Rd., Tuckahoe 7, N. Y. ADV. PG. 178, 179.
- ⓪M. P. Concert Installations, Fairfield 10, Conn.
- ⓪MARCONI INSTRUMENTS, LTD., 23 Beaver St., New York 4, N. Y. ADV. PG. 270.
- ⓪MEASUREMENTS CORP., Boonton, N. J. ADV. PG. 99.
- ⓪POLYTECHNIC RESEARCH & DEVELOPMENT CO., INC., 202 Tillary St., Brooklyn 1, N. Y. ADV. PG. 172, 173.
- ⓪SERVO CORP. OF AMERICA, 20-20 Jericho Turnpike, New Hyde Park, N. Y. ADV. PG. 150, 151.
- ⓪SPERRY GYROSCOPE CO., INC., Div. of the Sperry Corp., Great Neck, N. Y. ADV. PG. 103, 104.
- ⓪Thwing-Albert Instrument Co., 5351 Pulaski Ave., Philadelphia 44, Pa.

BOLTS

- ⓪Allmetal Screw Products Co., Inc., 33 Greene St., New York 13, N. Y.
- ⓪American Laubscher Corp., 333 W. 52nd St., New York 19, N. Y.
- ⓪Autoscrew Co., 216-222 W. 18th St., New York, N. Y.
- ⓪Birnbach Radio Co., Inc., 145 Hudson St., New York, N. Y.
- ⓪Chase Brass & Copper Co., Inc., 236 Grand St., Waterbury 20, Conn.
- ⓪CITATION PRODUCTS CO., 233 E. 146th St., New York 51, N. Y. ADV. PG. 388.
- ⓪FEDERAL SCREW PRODUCTS, INC., 224 W. Huron St., Chicago 10, Ill. ADV. PG. 76.
- ⓪General Cement Mfg. Co., 919 Taylor Ave., Rockford, Ill.
- ⓪Greene Mfg. Corp., G. G., Warren, Pa.
- ⓪Harper Co., H. M., 8200 Lehigh Ave., Morton Grove, Ill.
- ⓪Hubbell, Inc., Harvey, Bridgeport 2, Conn.
- ⓪J F D MFG. CO., 6101-23 Sixteenth Ave., Brooklyn, N. Y. ADV. PG. 407.
- ⓪Lamson & Sessions Co., 1971 W. 85th St., Cleveland, Ohio.
- ⓪Locke Incorporated, P. O. Box 57, Baltimore 3, Md.
- ⓪National Screw & Mfg. Co., The, Cleveland 4, Ohio.
- ⓪Pheoil Mfg. Co., 5700 Roosevelt Bld., Chicago 50, Ill.
- ⓪Republic Steel Corp., Republic Bldg., Cleveland 1, Ohio.
- ⓪Schttt Co., Walter L., 3225 Exposition Pl., Los Angeles 18, Calif.
- ⓪Star Expansion Bolt Co., 147-149 Cedar St., New York 6, N. Y.
- ⓪Stronghold Screw Products, Inc., 216-222 West Hubbard St., Chicago 10, Ill.
- ⓪United Screw & Bolt Corp., 2513 W. Cullerton St., Chicago 8, Ill.

BOLTS—Expansion

- ⓪Ackerman-Johnson Co., 625 W. Jackson Blvd., Chicago 6, Ill.
- ⓪Arro Expansion Bolt Co., Boone Ave., Marion, Ohio.
- ⓪Birnbach Radio Co., Inc., 145 Hudson St., New York, N. Y.
- ⓪Chase Brass & Copper Co., Inc., 236 Grand St., Waterbury 20, Conn.
- ⓪Chicago Expansion Bolt Co., 1338 W. Concord Pl., Chicago 22, Ill.
- ⓪General Cement Mfg. Co., 919 Taylor Ave., Rockford, Ill.
- ⓪Greene Mfg. Corp., G. G., Warren, Pa.
- ⓪J F D MFG. CO., 6101-23 Sixteenth Ave., Brooklyn, N. Y. ADV. PG. 407.
- ⓪Locke Incorporated, P. O. Box 57, Baltimore 3, Md.
- ⓪National Lead Co., 111 Broadway, New York 6, N. Y.
- ⓪Smith, Inc., Herman H., 436 18th St., Brooklyn 15, N. Y.
- ⓪Star Expansion Bolt Co., 147-149 Cedar St., New York 6, N. Y.
- ⓪United Screw & Bolt Corp., 2513 W. Cullerton St., Chicago 8, Ill.

BOLTS—Eye

- ⓪Allmetal Screw Products Co., Inc., 33 Greene St., New York 13, N. Y.
- ⓪Birnbach Radio Co., Inc., 145 Hudson St., New York, N. Y.
- ⓪General Cement Mfg. Co., 919 Taylor Ave., Rockford, Ill.
- ⓪Harper Co., H. M., 8200 Lehigh Ave., Morton Grove, Ill.
- ⓪Insuline Corp. of America, 36-02 35th Ave., Long Island City, N. Y.
- ⓪J F D MFG. CO., 6101-23 Sixteenth Ave., Brooklyn, N. Y. ADV. PG. 407.
- ⓪Judd Co., H. L., 87 Chambers St., New York 7, N. Y.
- ⓪Lamson & Sessions Co., 1971 W. 85th St., Cleveland, Ohio.
- ⓪Laughlin Co., Thomas, 199 Fore, Portland, Me.
- ⓪Locke Incorporated, P. O. Box 57, Baltimore 3, Md.

- ⓪National Electronic Mfg. Corp., 4202 Vernon Blvd., Long Island City, N. Y.
- ⓪National Screw & Mfg. Co., The, Cleveland 4, Ohio.
- ⓪Schott Co., Walter L., 3225 Exposition Pl., Los Angeles 18, Calif.
- ⓪Smith, Inc., Herman H., 436-18th St., Brooklyn 15, N. Y.
- ⓪Stronghold Screw Products, Inc., 216-222 West Hubbard St., Chicago 10, Ill.

BOLTS—Toggle

- ⓪Ackerman-Johnson Co., 625 W. Jackson Blvd., Chicago 6, Ill.
- ⓪Arro Expansion Bolt Co., Boone Ave., Marion, Ohio.
- ⓪Birnbach Radio Co., Inc., 145 Hudson St., New York, N. Y.
- ⓪Chicago Expansion Bolt Co., 1338 W. Concord Pl., Chicago 22, Ill.
- ⓪Communication Products Co., Inc., Marlboro, N. J.
- ⓪General Cement Mfg. Co., 919 Taylor Ave., Rockford, Ill.
- ⓪Greene Mfg. Corp., G. G., Warren, Pa.
- ⓪J F D MFG. CO., 6101-23 Sixteenth Ave., Brooklyn, N. Y. ADV. PG. 407.
- ⓪Smith, Inc., Herman H., 436 18th St., Brooklyn 15, N. Y.
- ⓪Star Expansion Bolt Co., 147-149 Cedar St., New York 6, N. Y.

BOOKS

See **Technical Books—Publishers**

BOOMS—Microphone

- ⓪Art Specialty Co., 3245 W. Lake St., Chicago, Ill.
- ⓪Berndt-Bach, Inc., 7373 Beverly Blvd., Los Angeles 36, Calif.
- ⓪Disen Co., Otto K., 1534 Cahuenga, Hollywood 28, Calif.
- ⓪RADIO CORP. OF AMERICA, RCA Victor Div., General Offices, Camden, N. J. ADV. PG. 177, Inside Back & Back Covers.
- ⓪SOS Cinema Supply Corp., 602 W. 52nd St., New York 19, N. Y.

BOOSTERS—Television

- ⓪Alliance Manufacturing Co., Lake Park Blvd., Alliance, Ohio.
- ⓪Approved Electronic Instrument Corp., 146 Liberty St., New York 6, N. Y.
- ⓪Astatic Corp., The, Conneaut, Ohio.
- ⓪Bud Radio, Inc., 2118 E. 55th St., Cleveland 3, Ohio.
- ⓪Decimeter, Inc., 1430 Market St., Denver 2, Colo.
- ⓪ELECTRO-VOICE, INC., Buchanan, Mich. ADV. PG. 345.
- ⓪Electronic Indicator Corp., 259 Green St., Brooklyn 22, N. Y.
- ⓪I.D.E.A., 55 North New Jersey, Indianapolis, Ind.
- ⓪Industrial Television, Inc., 359 Lexington Ave., Clifton, N. J.
- ⓪LA POINTE-PLASCOMOLD CORP., Windsor Locks, Conn. ADV. PG. 297.
- ⓪McMurdo Silver Co., Inc., 473 Lafayette St., New York, N. Y.
- ⓪Monarch Radio & Television Corp., 2430 Atlantic Ave., Brooklyn 33, N. Y.
- ⓪Philco Corp., Tlaga & C Sts., Philadelphia 34, Pa.
- ⓪Phoenix Electronics Inc., Lawrence, Mass.
- ⓪Radio Merchandise Sales, Inc., 1165 Southern Blvd., New York 59, N. Y.
- ⓪Simpson Mfg. Co., Inc., Mark, 32-28 49th St., Long Island City 3, N. Y.
- ⓪Sonic Industries Inc., 221 W. 17th St., New York 11, N. Y.
- ⓪SPENCER-KENNEDY LABS, INC., 186 Massachusetts Ave., Cambridge 39, Mass. ADV. PG. 166.
- ⓪STANDARD COIL PRODUCTS CO., 2329 N. Pulaski Rd., Chicago 39, Ill. ADV. PG. 97.
- ⓪Tech-Master Products Co., 443-445 Broadway, New York 13, N. Y.
- ⓪Television Equipment Corp., 238 William St., New York, N. Y.
- ⓪Transvision Inc., 460 North Ave., New Rochelle, N. Y.
- ⓪TURNER CO., THE, 909 17th St., N. E., Cedar Rapids, Iowa. ADV. PG. 73.

BOXES—Metal

- ⓪BALON PRECISION MFG. CORP., 540 Casanova St., Bronx 59, N. Y. ADV. PG. 348.
- ⓪ART-LLOYD METAL PRODUCTS CORP., 2973 Cropsey Ave., Brooklyn 14, N. Y. ADV. PG. 364.
- ⓪Bud Radio, Inc., 2118 E. 55th St., Cleveland 3, Ohio.
- ⓪CHURCHILL CORP., 7 North Ave., Wakefield, Mass. ADV. PG. 408.
- ⓪Colgate Mfg. Corp., Lindenhurst, N. Y.
- ⓪Columbia Metal Box Co., 260 E. 143rd St., New York, N. Y.
- ⓪Cossor (Canada), Ltd., 301-303 Windsor St., Halifax, N. S., Canada.
- ⓪CRAFT MFG. CO., 3949 W. Schubert St., Chicago, Ill. ADV. PG. 128.
- ⓪Dahlstrom Metallic Door Co., Jamestown, N. Y.

Ⓥ indicates . . . IN PRODUCTION • AVAILABILITY • UNRESTRICTED FOR GENERAL USE

- Ⓥ Doolittle Radio, Inc., 7421 S. Loomis Blvd., Chicago 36, Ill.
- Ⓥ Edo Corp., College Point, N. Y.
- Ⓥ Edwards Co., Inc., 86 Boston Post Rd., Norwalk, Conn.
- Ⓥ Electronic Indicator Corp., 259 Green St., Brooklyn 22, N. Y.
- Ⓥ FALSTROM CO., 44 Falstrom Court, Passaic, N. J. ADV. PG. 196.
- Ⓥ Greene Mfg. Corp., G. G., Warren, Pa.
- Ⓥ Hoffman Engineering Corp., Anoka, Minn.
- Ⓥ Insuline Corp. of America, 36-02 35th Ave., Long Island City, N. Y.
- Ⓥ J F D MFG. CO., 6101-23 Sixteenth Ave., Brooklyn, N. Y. ADV. PG. 407.
- Ⓥ KARP METAL PRODUCTS CO., INC., 215 63rd St., Brooklyn 20, N. Y. ADV. PG. 105.
- Ⓥ Kolton Electric Mfg. Co., 123 New Jersey Railroad Ave., Newark 5, N. J.
- Ⓥ Market Forge Co., 25 Garvey St., Everett 49, Mass.
- Ⓥ Minute Man Products, Inc., 430 E. 102nd St. New York, N. Y.
- Ⓥ MUCKLE MFG. CO. Owatonna 55, Minn. ADV. PG. 370.
- Ⓥ MULTI METAL CO., 1350 Garrison Ave., New York 59, N. Y. ADV. PG. 221.
- Ⓥ Northeastern Engineering, Inc., Manchester, N. H.
- Ⓥ OLYMPIC METAL PRODUCTS CO., INC., Phillipsburg, N. J. ADV. PG. 358.
- Ⓥ Par-Metal Products Corp., 32-62 49th St., Long Island City, N. Y.
- Ⓥ Press Wireless Mfg. Co., Inc., Cantiague Rd., Hicksville, N. Y.
- Ⓥ REF Mfg. Corp., Jericho Turnpike, Mineola, N. Y.
- Ⓥ Stevens-Walden, Inc., 475 Shrewsbury St., Worcester 4, Mass.
- Ⓥ Thomas & Betts Co., Inc., 40 Butler St., Elizabeth 1, N. J.
- Ⓥ Walter Co., Inc., S., 1400 Atlantic Ave., Brooklyn 16, N. Y.

BOXES—Waterproof

- Ⓥ ABALON PRECISION MFG. CORP., 540 Casanova St., Bronx 59, N. Y. ADV. PG. 348.
- Ⓥ ART-LLOYD METAL PRODUCTS CORP., 2973 Croyse Ave., Brooklyn 14, N. Y. ADV. PG. 364.
- Ⓥ Dahlstrom Metallic Door Co., Jamestown, N. Y.
- Ⓥ Edwards Co., Inc., 86 Boston Post Rd., Norwalk, Conn.
- Ⓥ Galbraith & Son Electric Corp., C. C., 450 Sixth Ave., New York 11, N. Y.
- Ⓥ Hoffman Engineering Corp., Anoka, Minn.
- Ⓥ Hose-McCann Telephone Co., Inc., 25th St. & 3rd Ave., Brooklyn 32, N. Y.
- Ⓥ KARP METAL PRODUCTS CO., INC., 215 63rd St., Brooklyn 20, N. Y. ADV. PG. 105.
- Ⓥ Kolton Electric Mfg. Co., 123 New Jersey Railroad Ave., Newark 5, N. J.
- Ⓥ MULTI METAL CO., 1350 Garrison Ave., New York 59, N. Y. ADV. PG. 221.
- Ⓥ Northeastern Engineering, Inc., Manchester, N. H.
- Ⓥ Press Wireless Mfg. Co., Inc., Cantiague Rd., Hicksville, N. Y.
- Ⓥ REF Mfg. Corp., Jericho Turnpike, Mineola, N. Y.
- Ⓥ Shoe Form Co., Inc., Auburn, N. Y.
- Ⓥ Skvodyne Inc., River Rd., Port Jervis, N. Y.
- Ⓥ TEFLON PRODUCTS DIVISION, U. S. GASKET CO., P. O. Box 93, Camden, N. J. ADV. PG. 176.
- Ⓥ Thomas & Betts Co., Inc., 40 Butler St., Elizabeth 1, N. J.
- Ⓥ Walter Co., Inc., S., 1400 Atlantic Ave., Brooklyn 16, N. Y.

BRACKETS—f-m & Television Antenna

- Ⓥ AMERICAN PHENOLIC CORP., 1830 S. 54th Ave., Chicago 50, Ill. ADV. PG. 61.
- Ⓥ Birnbach Radio Co., Inc., 145 Hudson St., New York, N. Y.
- Ⓥ Brach Mfg. Corp., 200 Central Ave., Newark 4, N. J.
- Ⓥ Donnelly Electric & Mfg. Co., 3050 Washington St., Boston, Mass.
- Ⓥ Electronic Indicator Corp., 259 Green St., Brooklyn 22, N. Y.
- Ⓥ Industrial Precision Products Co., 315-325 N. Hoyle Ave., Chicago 12, Ill.
- Ⓥ Insuline Corp. of America, 36-02 35th Ave., Long Island City, N. Y.
- Ⓥ J F D MFG. CO., 6101-23 Sixteenth Ave., Brooklyn, N. Y. ADV. PG. 407.
- Ⓥ LAPOINTE-PLASCOMOLD CORP., Windsor Locks, Conn. ADV. PG. 297.
- Ⓥ Minute Man Products, Inc., 430 E. 102nd St., New York, N. Y.
- Ⓥ Oak Ridge Products Mfg. Div. of Video Television, Inc., 37-01 Vernon Blvd., Long Island City 1, N. Y.
- Ⓥ Philco Corp., Tioga & C Sts., Philadelphia 34, Pa.
- Ⓥ Philson Mfg. Co., Inc., 60-66 Sackett St., Brooklyn 31, N. Y.
- Ⓥ Phoenix Electronics Inc., Lawrence, Mass.
- Ⓥ Premax Products Div., Chisholm-Ryder Co., Inc., Niagara Falls 2, N. Y.
- Ⓥ Radiart Corp., The, 3571 W. 62nd St., Cleveland, Ohio.
- Ⓥ RADIO CORP. OF AMERICA, Tube Dept., Harrison, N. J. ADV. PG. 177, Inside Back & Back Covers.

- Ⓥ Radio Merchandise Sales, Inc., 1165 Southern Blvd., New York 59, N. Y.
- Ⓥ South River Metal Products Co., South River, N. J.
- Ⓥ TECHNICAL APPLIANCE CORP., Sherburne, N. Y. ADV. PG. 378.
- Ⓥ Warren Mfg. Co., Inc., 250 East St., New Haven, Conn.
- Ⓥ Wind Turbine Co., Tower & Antenna Div., E. Market St. & Penna R. R., West Chester, Pa.

BREAKERS—Circuit

- Ⓥ GENERAL ELECTRIC CO., Schenectady 5, N. Y. ADV. PG. 1 to 22.
- Ⓥ HEINEMANN ELECTRIC CO., 97 Plum St., Trenton 2, N. J. ADV. PG. 274.
- Ⓥ Kolton Electric Mfg. Co., 123 New Jersey Railroad Ave., Newark 5, N. J.
- Ⓥ Philco Corp., Tioga & C Sts., Philadelphia 34, Pa.
- Ⓥ RHODEN MANUFACTURING COMPANY, 4739 Montrose Ave., Chicago 41, Ill. ADV. PG. 406.
- Ⓥ RUSSELL & STOLL CO., INC., 125 Barclay St., New York 7, N. Y. ADV. PG. 337.
- Ⓥ Spencer Thermostat Div. Metals & Control Corp., 34 Forest St., Attleboro, Mass.
- Ⓥ Trumbull Electric Mfg. Co., Plainville, Conn.
- Ⓥ WESTINGHOUSE ELECTRIC CORP., 511 Wood St., P. O. Box 868, Pittsburgh 30, Pa. ADV. PG. 107-113.

BRIDGES—Capacitance

- Ⓥ AEROVOX CORP., 740 Belleville Ave., New Bedford, Mass. ADV. PG. 352.
- Ⓥ Brown Electro-Measurement Corp., 4637 SE Hawthorne Blvd., Portland 15, Oregon.
- Ⓥ Clippard Instrument Laboratory, Inc., 1125 Bank St., Cincinnati 14, Ohio.
- Ⓥ Clough Brenle Co., 6014 N. Broadway, Chicago, Ill.
- Ⓥ COMMUNICATION MEASUREMENTS LAB., INC., 120 Greenwich St., New York 6, N. Y. ADV. PG. 290.
- Ⓥ Conant Labs., 6500 O St., Lincoln 5, Neb.
- Ⓥ CORNELL-DUBILIER ELECTRIC CORP., South Plainfield, N. J. ADV. PG. 146.
- Ⓥ ELECTRONIC INSTRUMENT CO., INC., 276 Newport St., Brooklyn 12, N. Y. ADV. PG. 129.
- Ⓥ FREED TRANSFORMER CO., INC., 1736 Weirfield St., Brooklyn 27, N. Y. ADV. PG. 149.
- Ⓥ GENERAL ELECTRIC CO., Schenectady 5, N. Y. ADV. PG. 1 to 22.
- Ⓥ GENERAL ELECTRIC CO., Electronics Dept., Electronics Park, Syracuse, N. Y. ADV. PG. 1 to 22.
- Ⓥ GENERAL RADIO CO., 275 Massachusetts Ave., Cambridge 39, Mass. ADV. PG. 48, 49.
- Ⓥ Industrial Instruments Inc., 17 Pollack Ave., Jersey City 5, N. J.
- Ⓥ Leeds & Northrup Co., 4970 Stenton Ave., Philadelphia 44, Pa.
- Ⓥ MacLeod & Hanopol, Inc., 10 Joiner St., Charlestown 29, Mass.
- Ⓥ MARCONI INSTRUMENTS, LTD., 23 Beaver St., New York 4, N. Y. ADV. PG. 270.
- Ⓥ MEASUREMENTS CORP., Boonton, N. J. ADV. PG. 99.
- Ⓥ Metropolitan Electronics & Instruments Co., 106 Fifth Ave., New York 11, N. Y.
- Ⓥ Muirhead & Co., Ltd., Beckenham-Kent-England.
- Ⓥ Network Mfg. Corp., Bayonne, N. J.
- Ⓥ PENNSYLVANIA TESTING LABORATORY, Doylestown, Pa. ADV. PG. 350.
- Ⓥ Southwestern Industrial Electronics Co., 2831 Post Oak Rd., P. O. Box 13058, Houston 19, Texas.
- Ⓥ SYLVANIA ELECTRIC PRODUCTS INC., 1740 Broadway, New York 19, N. Y. ADV. PG. 432-436.
- Ⓥ Tech Laboratories, Inc., Bergen & Edsall Bldvs., Palisades Park, N. J.
- Ⓥ Wheeler Laboratories, Inc., Great Neck, N. Y.
- Ⓥ Winslow Co., Inc., 9 Liberty St., Newark 5, N. J.

BRIDGES—Electrical

- Ⓥ AIRMEC LABORATORIES LTD., 366 Madison Ave., New York 17, N. Y. ADV. PG. 336.
- Ⓥ Clippard Instrument Laboratory, Inc., 1125 Bank St., Cincinnati 14, Ohio.
- Ⓥ COMMUNICATION MEASUREMENTS LAB., INC., 120 Greenwich St., New York 6, N. Y. ADV. PG. 290.
- Ⓥ DAVEN CO., 191 Central Ave., Newark 4, N. J. ADV. PG. 157.
- Ⓥ FREED TRANSFORMER CO., INC., 1736 Weirfield St., Brooklyn 27, N. Y. ADV. PG. 149.
- Ⓥ GENERAL ELECTRIC CO., Schenectady 5, N. Y. ADV. PG. 1 to 22.
- Ⓥ GENERAL RADIO CO., 275 Massachusetts Ave., Cambridge 39, Mass. ADV. PG. 48, 49.
- Ⓥ INDUSTRIAL ELECTRONICS, INC., 8080 Wheeler St., Detroit 10, Mich. ADV. PG. 234, 235.
- Ⓥ Instrument Laboratories, 315 W. Walton Place, Chicago 10, Ill.
- Ⓥ Leeds & Northrup Co., 4970 Stenton Ave., Philadelphia 44, Pa.
- Ⓥ MARCONI INSTRUMENTS LTD., 23 Beaver St., New York 4, N. Y. ADV. PG. 270.
- Ⓥ MEASUREMENTS CORP., Boonton, N. J. ADV. PG. 99.
- Ⓥ Metropolitan Electronics & Instruments Co., 106 Fifth Ave., New York 11, N. Y.
- Ⓥ Muirhead & Co., Ltd., Beckenham-Kent-England.

- Ⓥ PENNSYLVANIA TESTING LABORATORY, Doylestown, Pa. ADV. PG. 350.
- Ⓥ Rubicon Co., 3761 Ridge Ave., Philadelphia 29, Pa.
- Ⓥ SHALLCROSS MFG. CO., 10 Jackson Ave., Collingdale, Pa. ADV. PG. 261.
- Ⓥ SPERRY GYROSCOPE CO., Div. of The Sperry Corp., Great Neck, N. Y. ADV. PG. 103, 104.
- Ⓥ Standard Telephones & Cables Ltd., Connaught House, Aldwych, London, W.C. 2, England.
- Ⓥ Tech Laboratories, Inc., Bergen & Edsall Bldvs., Palisades Park, N. J.
- Ⓥ WESTINGHOUSE ELECTRIC CORP., 511 Wood St., P. O. Box 868, Pittsburgh 30, Pa. ADV. PG. 107-113.
- Ⓥ Winslow Co., Inc., 9 Liberty St., Newark 5, N. J.

BRIDGES—Impedance

- Ⓥ AIRMEC LABORATORIES LTD., 366 Madison Ave., New York 17, N. Y. ADV. PG. 336.
- Ⓥ Brown Electro-Measurement Corp., 4637 SE Hawthorne Blvd., Portland 15, Ore.
- Ⓥ BRUSH DEVELOPMENT CO., 3405 Perkins Ave., Cleveland 14, Ohio. ADV. PG. 228, 229.
- Ⓥ COMMUNICATION MEASUREMENTS LAB., INC., 120 Greenwich St., New York 6, N. Y. ADV. PG. 290.
- Ⓥ Conant Labs., 6500 O St., Lincoln 5, Neb.
- Ⓥ GENERAL RADIO CO., 275 Massachusetts Ave., Cambridge 39, Mass. ADV. PG. 48, 49.
- Ⓥ HEATH CO., Benton Harbor, Mich. ADV. PG. 264.
- Ⓥ HICKOK ELECTRICAL INSTRUMENT CO., 10514 Dupont Ave., Cleveland 8, Ohio. ADV. PG. 333.
- Ⓥ Leeds & Northrup Co., 4970 Stenton Ave., Philadelphia 44, Pa.
- Ⓥ M. P. Concert Installations, Fairfield 10, Conn.
- Ⓥ MARCONI INSTRUMENTS, LTD., 23 Beaver St., New York 4, N. Y. ADV. PG. 270.
- Ⓥ Metropolitan Electronics & Instruments Co., 106 Fifth Ave., New York 11, N. Y.
- Ⓥ Midwestern Geophysical Laboratory, 3400 S. Harvard, Tulsa, Okla.
- Ⓥ Network Mfg. Corp., Bayonne, N. J.
- Ⓥ Radex Corp., 2076 N. Elston Ave., Chicago 14, Ill.
- Ⓥ Southwestern Industrial Electronics Co., 2831 Post Oak Rd., P. O. Box 13058, Houston 19, Texas.
- Ⓥ Special Instruments Laboratories, Inc., 1003 Highland Ave., Knoxville, Tenn.
- Ⓥ Tech Laboratories, Inc., Bergen & Edsall Bldvs., Palisades Park, N. J.
- Ⓥ Technology Instrument Corp., 531 Main St., Acton, Mass.
- Ⓥ Winslow Co., Inc., 9 Liberty St., Newark 5, N. J.

BRIDGES—Inductance

- Ⓥ AIRMEC LABORATORIES LTD., 366 Madison Ave., New York 17, N. Y. ADV. PG. 336.
- Ⓥ Conant Labs., 6500 O St., Lincoln 5, Neb.
- Ⓥ FREED TRANSFORMER CO., INC., 1736 Weirfield St., Brooklyn 27, N. Y. ADV. PG. 149.
- Ⓥ GENERAL RADIO CO., 275 Massachusetts Ave., Cambridge 39, Mass. ADV. PG. 48, 49.
- Ⓥ Leeds & Northrup Co., 4970 Stenton Ave., Philadelphia 44, Pa.
- Ⓥ MARCONI INSTRUMENTS, LTD., 23 Beaver St., New York 4, N. Y. ADV. PG. 270.
- Ⓥ MEASUREMENTS CORP., Boonton, N. J. ADV. PG. 99.
- Ⓥ Metropolitan Electronics & Instruments Co., 106 Fifth Ave., New York 11, N. Y.
- Ⓥ Midwestern Geophysical Laboratory, 3400 S. Harvard, Tulsa, Okla.
- Ⓥ Network Mfg. Corp., Bayonne, N. J.
- Ⓥ PENNSYLVANIA TESTING LABORATORY, Doylestown, Pa. ADV. PG. 350.
- Ⓥ Southwestern Industrial Electronics Co., 2831 Post Oak Rd., P. O. Box 13058, Houston 19, Texas.
- Ⓥ Tech Laboratories, Inc., Bergen & Edsall Bldvs., Palisades Park, N. J.
- Ⓥ Wheeler Laboratories, Inc., Great Neck, N. Y.
- Ⓥ Winslow Co., Inc., 9 Liberty St., Newark 5, N. J.

BRIDGES—Temperature

- Ⓥ INDUSTRIAL ELECTRONICS, INC., 8080 Wheeler St., Detroit 10, Mich. ADV. PG. 234, 235.
- Ⓥ Leeds & Northrup Co., 4970 Stenton Ave., Philadelphia 44, Pa.
- Ⓥ Loudon Instruments, Inc., 5644 Lake Park Ave., Chicago 37, Ill.
- Ⓥ Midwestern Geophysical Laboratory, 3400 S. Harvard, Tulsa, Okla.
- Ⓥ Tech Laboratories, Inc., Bergen & Edsall Bldvs., Palisades Park, N. J.
- Ⓥ Trans-Sonics, Inc., Bedford Airport, Bedford, Mass.

BRIDGES—Thermistor

- Ⓥ GENERAL RADIO CO., 275 Massachusetts Ave., Cambridge 39, Mass. ADV. PG. 48, 49.
- Ⓥ MARCONI INSTRUMENTS, LTD., 23 Beaver St., New York 4, N. Y. ADV. PG. 270.
- Ⓥ POLYTECHNIC RESEARCH & DEVELOPMENT CO., INC., 202 Tillary St., Brooklyn 1, N. Y. ADV. PG. 172, 173.

V indicates . . . IN PRODUCTION • AVAILABILITY • UNRESTRICTED FOR GENERAL USE

- SERVO CORP. OF AMERICA, 20-20 Jericho Turnpike, New Hyde Park, N. Y. ADV. PG. 150, 151.
- SPERRY GYROSCOPE DIV. OF THE SPERRY CORP., Great Neck, N. Y. ADV. PG. 103, 104.
- Tech Laboratories, Inc., Bergen & Edsall Blvds., Palisades Park, N. J.

BRIDGES—vhf

- AIRMEC LABORATORIES LTD., 366 Madison Ave., New York 17, N. Y. ADV. PG. 336.
- GENERAL RADIO CO., 275 Massachusetts Ave., Cambridge 39, Mass. ADV. PG. 48, 49.
- HEWLETT-PACKARD CO., 395 Page Mill Rd., Palo Alto, Calif. ADV. PG. 33-36.
- MARCONI INSTRUMENTS, LTD., 23 Beaver St., New York 4, N. Y. ADV. PG. 270.

BROADCAST INPUT CONTROL EQUIPMENT

- Arlington Electric Products, Inc., 500 W. 52nd St., New York 19, N. Y.
- CINEMA ENGINEERING CO., 1510 W. Verdugo Ave., Burbank, Calif. ADV. PG. 204.
- GATES RADIO CO., Quincy, Ill.
- DAVEN CO., 191 Central Ave., Newark 4, N. J. ADV. PG. 157.
- FEDERAL TELEPHONE & RADIO CORP., 88 Kingsland Rd., Clifton, N. J. ADV. PG. 161-163.
- MARCONI INSTRUMENTS, LTD., 23 Beaver St., New York 4, N. Y. ADV. PG. 270.
- PAINTON & CO., INC., LTD., 366 Madison Ave., New York 17, N. Y. ADV. PG. 336.
- RADIO CORP. OF AMERICA, RCA Victor Div., General Offices, Camden, N. J. ADV. PG. 177, Inside Back & Back Covers
- Standard Electronics Corp., 25 W 43rd St., New York 18, N. Y.
- Standard Telephones & Cables Ltd., Connaught House, Aldych, London, W. C. 2, England.
- Waveforms, Inc., 333 Sixth Ave., New York 14, N. Y.

BRUSHES—Carbon & Graphite

- Electro-Nite Carbon Co., 1133 E. Columbia Ave., Philadelphia 25, Pa.
- General Cement Mfg. Co., 919 Taylor Ave., Rockford, Ill.
- GENERAL ELECTRIC CO., Schenectady 5, N. Y. ADV. PG. 1 to 22.
- GRAPHITE METALLIZING CORP., 1041 Nepperhan Ave., Yonkers 3, N. Y. ADV. PG. 192.
- Helwig Co., 2544 N. 30th St., Milwaukee 10, Wis.
- KEYSTONE CARBON CO., INC., Saint Marys, Pa. ADV. PG. 308.
- NATIONAL CARBON CO., Division of Union Carbide & Carbon Corp., 30 E. 42nd St., New York 17, N. Y. ADV. PG. 42.
- Ohio Carbon Co., 12508 Berea Rd., Cleveland 11, Ohio.
- Pure Carbon Co., St. Marys, Pa.
- St. Marys Carbon Co., State Road, St. Marys, Pa.
- STACKPOLE CARBON CO., St. Marys, Pa. ADV. PG. 170, 171.
- WESTINGHOUSE ELECTRIC CORP., 511 Wood St., P. O. Box 868, Pittsburgh 30, Pa. ADV. PG. 107-113.

BRUSHES—Metal-Graphite

- GRAPHITE METALLIZING CORP., 1041 Nepperhan Ave., Yonkers 3, N. Y. ADV. PG. 192.
- Helwig Co., 2544 N. 30th St., Milwaukee, Wis.
- KEYSTONE CARBON CO., INC., Saint Marys, Pa. ADV. PG. 308.
- NATIONAL CARBON CO., Division of Union Carbide & Carbon Corp., 30 E. 42nd St., New York 17, N. Y. ADV. PG. 42.
- Pure Carbon Co., St. Marys, Pa.
- St. Marys Carbon Co., State Road, St. Marys, Pa.
- STACKPOLE CARBON CO., St. Marys, Pa. ADV. PG. 170, 171.

BUS BAR SYSTEMS

- Kolon Electric Mfg. Co., 123 New Jersey Railroad Ave., Newark 5, N. J.
- Northeastern Engineering, Inc., Manchester, N. H.
- WESTINGHOUSE ELECTRIC CORP., 511 Wood St., P. O. Box 868, Pittsburgh 30, Pa. ADV. PG. 107-113.

BUS BARS—Solderless

- Chase Brass & Copper Co., Inc., 236 Grand St., Waterbury 20, Conn.
- Revere Copper & Brass, Inc., 230 Park Ave., New York 17, N. Y.
- WESTINGHOUSE ELECTRIC CORP., 511 Wood St., P. O. Box 868, Pittsburgh 30, Pa. ADV. PG. 107-113.

BUSHINGS—Hermetically Sealed

- BELLING & LEE LTD., 366 Madison Ave., New York 17, N. Y. ADV. PG. 336.

- CORNING GLASS WORKS, Corning, N. Y. ADV. PG. 373.
- ELECTRICAL INDUSTRIES, INC., 44 Summer Ave., Newark 4, N. J. ADV. PG. 94.
- ELECTRO-SEAL CORP., 946 Lee St., DesPlaines, Ill. ADV. PG. 222.
- Electronic Apparatus Co., Elkhart, Ind.
- ELECTRONIC MECHANICS, INC., 70 Clifton Blvd., Clifton, N. J. ADV. PG. 309.
- Elm Laboratories, 18 South Broadway, Dobbs Ferry, N. Y.
- GENERAL ACCESSORIES CO., LTD., 366 Madison Ave., New York 17, N. Y. ADV. PG. 336.
- GENERAL CERAMICS & STEATITE CORP., Keasbey, N. J. ADV. PG. 126, 127.
- GENERAL ELECTRIC CO., Schenectady 5, N. Y. ADV. PG. 1 to 22.
- HELDOR MFG. CO., Div. of Helder Bushing & Terminal Inc., 225 Belleville Ave., Bloomfield, N. J. ADV. PG. 242.
- HERMETIC SEAL PRODUCTS CO., 29-37 So. 6th St., Newark 7, N. J. ADV. PG. 175.
- NEO-SIL CORP., 26 Cornellison Ave., Jersey City 4, N. J. ADV. PG. 253.
- STUPAKOFF CERAMIC & MFG. CO., Latrobe, Pa. ADV. PG. 167.
- Triad Transformer Mfg. Co., 2254 Sepulveda Blvd., Los Angeles 64, Calif.
- WESTINGHOUSE ELECTRIC CORP., 511 Wood St., P. O. Box 868, Pittsburgh 30, Pa. ADV. PG. 107-113.
- Wheaton Co., T. J., Industrial Div., 220 G St., Millville, N. J.

BUSHINGS—Nonmetallic

- AMERICAN LAVA CORP., Chattanooga 5, Tenn. ADV. PG. 143.
- ATLANTIC INDIA RUBBER WORKS, INC., 571 W. Polk St., Chicago 7, Ill. ADV. PG. 323.
- Auburn Mfg. Co., Pease Ave. & Stack St., Middletown, Conn.
- Baer Co., N. S., 9 Montgomery St., Hillside, N. J.
- BELLING & LEE LTD., 366 Madison Ave., New York 17, N. Y. ADV. PG. 336.
- BIWAX CORP., 3445 Howard St., Skokie, Ill. ADV. PG. 380.
- Brandywine Fibre Co., 15th & Poplar Sts., Wilmington, Del.
- CITATION PRODUCTS CO., 233 E. 146th St., New York 51, N. Y. ADV. PG. 388.
- Eagle Electric Mfg. Co., Inc., 23-10 Bridge Plaza, S., Long Island City, N. Y.
- GENERAL ACCESSORIES CO., LTD., 366 Madison Ave., New York 17, N. Y. ADV. PG. 336.
- GENERAL CERAMICS & STEATITE CORP., Keasbey, N. J. ADV. PG. 126, 127.
- GENERAL ELECTRIC CO., Schenectady 5, N. Y. ADV. PG. 1 to 22.
- Gits Molding Corp., 4600 W. Huron St., Chicago 44, Ill.
- GRAPHITE METALLIZING CORP., 1041 Nepperhan Ave., Yonkers 3, N. Y. ADV. PG. 192.
- HELDOR MFG. CO., Div. of Helder Bushing & Terminal Inc., 225 Belleville Ave., Bloomfield, N. J. ADV. PG. 242.
- HEYMAN MFG. CO., 300 Michigan Ave., Kenilworth, N. J. ADV. PG. 381.
- Isolantite Mfg. Corp., Stirling, N. J.
- Kirchberger & Co., Inc., 1425 37th St., Brooklyn 18, N. Y.
- Laconia Corp., 37 S. 6th St., Newark 7, N. J.
- LOUTHAN MFG. CO., East Liverpool, Ohio. ADV. PG. 284.
- Mayfair Molded Products Corp., 4440 N. Elston Ave., Chicago 30, Ill.
- Mica Insulator Co., Schenectady 1, N. Y.
- MYCALEX CORP. OF AMERICA, 60 Clifton Blvd., Clifton, N. J. ADV. PG. 258, 259.
- NATIONAL CARBON CO., Division of Union Carbide & Carbon Corp., 30 E. 42nd St., New York 17, N. Y. ADV. PG. 42.
- NATIONAL CO., INC., 61 Sherman St., Malden 48, Mass. ADV. PG. 280, 281.
- Pure Carbon Co., St. Marys, Pa.
- RICHARDSON CO., THE, 2767 Lake St., Melrose Park, Ill. ADV. PG. 310.
- Spaulding Fibre Co., Inc., 310 Wheeler St., Tonawanda, N. Y.
- STUPAKOFF CERAMIC & MFG. CO., Latrobe, Pa. ADV. PG. 167.
- TEFLON PRODUCTS DIVISION, U. S. GASKET CO., P. O. Box 93, Camden, N. J. ADV. PG. 176.
- Thomas & Betts Co., Inc., 40 Butler St., Elizabeth 1, N. J.
- WESTINGHOUSE ELECTRIC CORP., 511 Wood St., P. O. Box 868, Pittsburgh 30, Pa. ADV. PG. 107-113.
- Wilmington Fibre Specialty Co., P. O. Drawer 1028, Wilmington 99, Del.

CABINETS—Metal**CABINETS—Metal**

- ABALON PRECISION MFG. CORP., 540 Casanova St., Bronx 59, N. Y. ADV. PG. 348.

- ALDEN PRODUCTS CO., 117 N. Main St., Brockton 64, Mass. ADV. PG. 327.
 - Altec Lansing Corp., 9356 Santa Monica Blvd., Beverly Hills, Calif.
 - ART-LLOYD METAL PRODUCTS CORP., 2973 Cropsey Ave., Brooklyn 14, N. Y. ADV. PG. 364.
 - Bassett, Inc., Rex, 307-11 N. W. First Ave., Fort Lauderdale, Fla.
 - Bud Radio Inc., 2118 E. 55th St., Cleveland 3, Ohio.
 - Central Stamping & Mfg. Co., Polo, Ill.
 - Colgate Mfg. Corp., Lindenhurst, N. Y.
 - Columbia Metal Box Co., 260 E. 143rd St., New York, N. Y.
 - Corry-Jamestown Mfg. Co., Corry, Pa.
 - Croname, Inc., 3701 Ravenswood Ave., Chicago, Ill.
 - Cutler Metal Products Co., 1025 Line St., Camden, N. J.
 - Dahlstrom Metallic Door Co., Jamestown, N. Y.
 - Donnelly Electric & Mfg. Co., 3050 Washington St., Boston, Mass.
 - Doolittle Radio, Inc., 7421 S. Loomis Blvd., Chicago 41, Ill.
 - EDIN CO., INC., 207 Main St., Worcester, Mass. ADV. PG. 285.
 - Edo Corp., College Point, N. Y.
 - FALSTRÖM CO., 44 Falstrom Court, Passaic, N. J. ADV. PG. 196.
 - Gadgets, Inc., 3629 N. Dixie Drive, Dayton 4, Ohio.
 - Gates Radio Co., Quincy, Ill.
 - Gray Mfg. Co., The, 16 Arbor St., Hartford, Conn.
 - Greene Mfg. Corp., G. G., Warren, Pa.
 - Hingham Ordnance Co., Hingham Industrial Centre, Hingham, Mass.
 - Insuline Corp. of America, 36-02 35th Ave., Long Island City, N. Y.
 - Intervox Corp., 2701 California Ave., Seattle 6, Wash.
 - JOHNSON CO., E. F., Waseca, Minn. ADV. PG. 118, 121.
 - KARP METAL PRODUCTS CO., INC., 215 63rd St., Brooklyn 20, N. Y. ADV. PG. 105.
 - Kolon Electric Mfg. Co., 123 New Jersey Railroad Ave., Newark 5, N. J.
 - Lindsay Structure, Inc., 5000 W. Dempster St., Skokie, Ill.
 - Lorentzen Inc., Levolor, 391 W. Broadway, New York, N. Y.
 - Market Forge Co., 29 Garvey St., Everett 49, Mass.
 - Measurement Engineering, Ltd., Arnprior, Ontario, Canada.
 - Minute Man Products, Inc., 430 E. 102nd St., New York, N. Y.
 - MUCKLE MFG. CO., Owatonna 55, Minn. ADV. PG. 370.
 - MULTI METAL CO., 1350 Garrison Ave., New York 59, N. Y. ADV. PG. 221.
 - Newcomb Audio Products Co., 6824 Lexington Ave., Hollywood 38, Calif.
 - Northeastern Engineering, Inc., Manchester, N. H.
 - Par-Metal Products Corp., 32-62 49th St., Long Island City 3, N. Y.
 - Press Wireless Mfg. Co., Inc., Cantiague Rd., Hicksville, N. Y.
 - RADIO CORP. OF AMERICA, RCA Victor Div., General Offices, Camden, N. J. ADV. PG. 177, Inside Back & Back Covers
 - Radio Engineering Labs., Inc., 36-40 37th St., Long Island City 1, N. Y.
 - REF Mfg. Corp., Jericho Turnpike, Mineola, N. Y.
 - SHERRON ELECTRONICS CO., 1201 Flushing Ave., Brooklyn 6, N. Y. ADV. PG. 145.
 - Stamford Metal Specialty Co., Inc., 429 W. Broadway, New York 12, N. Y.
 - Steven-Walden, Inc., 475 Shrewbury St., Worcester 4, Mass.
 - Topping Mfg. Co., 75 Pueblo St., San Francisco 4, Calif.
 - Walter Co., Inc., S., 1400 Atlantic Ave., Brooklyn 16, N. Y.
- CABINETS—Plastic**
- Calbest Engineering & Electronics Co., 828 N. Highland Ave., Hollywood 38, Calif.
 - Catalin Corp. of America, 1 Park Ave., New York 16, N. Y.
 - Consolidated Molded Products Corp., Scranton 2, Pa.
 - EMELOID CO., INC., THE, 1239 Central Ave., Hillside 5, N. J. ADV. PG. 102.
 - ERIE RESISTOR CORP., 644 W. 12th St., Erie Pa. ADV. PG. 91.
 - Felsenthal & Sons, Inc., G., 4100 W. Grand Ave., Chicago 51, Ill.
 - General Industries Co., Taylor & Olive Sts., Elyria, Ohio.
 - Kuhn & Jacob Molding & Tool Co., 1200 Southard St., Trenton, N. J.
 - Mack Molding Co., Wayne, N. J.
 - Molded Insulation Co., 335 E. Price St., Philadelphia, Pa.
 - Philco Corp., Tloga & C Sts., Philadelphia 34, Pa.
 - Plastimold Corp., Attleboro, Mass.
 - Remler Co., Ltd., 2101 Bryant St., San Francisco 10, Calif.
 - RICHARDSON CO., THE., 2767 Lake St., Melrose Park, Ill. ADV. PG. 310.
 - Syracuse Ornamental Co., Inc., 581 S. Clinton St., Syracuse, N. Y.
 - TEFLON PRODUCTS DIVISION, U. S. GASKET CO., P. O. Box 93, Camden, N. J. ADV. PG. 176.

V indicates . . . IN PRODUCTION • AVAILABILITY • UNRESTRICTED FOR GENERAL USE

CABINETS—Wood

- Ⓞ Admiral Corp., 3800 Cortland St., Chicago, Ill.
- Ⓞ Altec Lansing Corp., 9356 Santa Monica Blvd., Beverly Hills, Calif.
- Ⓞ Bogen Co., Inc., David, 663 Broadway, New York 12, N. Y.
- Ⓞ ELECTRO-VOICE, INC., Buchanan, Mich. ADV. PG. 345.
- Ⓞ Ewald Cabinet Co., 2559 W. 21st St., Chicago 8, Ill.
- Ⓞ Holl Audio Industries, 9215 Venice Blvd., Los Angeles 34, Calif.
- Ⓞ Illinois Wood Products Corp., 1656 No. Besly Court, Chicago 22, Ill.
- Ⓞ Ingraham Co., E., Bristol, Conn.
- Ⓞ Jackson Industries, Inc., 58 E. Cullerton St., Chicago 16, Ill.
- Ⓞ Magna Electronics Co., 3707-11 W. Jefferson Blvd., Los Angeles 16, Calif.
- Ⓞ Mattison Television & Radio Corp., 893 Broadway, New York 3, N. Y.
- Ⓞ Philmore Mfg. Co., Inc., 113 University Place, New York 3, N. Y.
- Ⓞ Pilot Radio Corp., 37-06 36th St., Long Island City 1, N. Y.
- Ⓞ SESSIONS CLOCK CO., TIMER DIV., Forestville, Conn. ADV. PG. 123.
- Ⓞ Short Wave Plastic Forming Co., 2921 Alameda St., Burbank, Calif.
- Ⓞ Steger Furniture Mfg. Co., Steger, Ill.
- Ⓞ Tech-Master Products Co., 443-445 Broadway, New York 13, N. Y.
- Ⓞ Topping Mfg. Co., 75 Pueblo St., San Francisco 4, Calif.
- Ⓞ TRAD TELEVISION CORP., 1001 First Ave., Asbury Park, N. J. ADV. PG. 355.
- Ⓞ Transvision Inc., 460 North Ave., New Rochelle, N. Y.
- Ⓞ Vibracolor Corporation, 425 Bush St., San Francisco 8, Calif.
- Wells-Gardner & Co., 2701 N. Kildare Ave., Chicago, Ill.
- Ⓞ Woodwelding, Inc., 3000 W. Olive Ave., Burbank, Calif.
- Ⓞ Wurlitzer Co., Rudolph, N. Tonawanda, N. Y.

CABLE ASSEMBLIES

- Ⓞ AEROLITE ELECTRONIC HARDWARE CO., 507 26th St., Union City, N. J. ADV. PG. 355.
- Ⓞ ALDEN PRODUCTS CO., 117 N. Main St., Brockton 64, Mass. ADV. PG. 327.
- Ⓞ AMERICAN ELECTROENGINEERING CORP., 5025-29 W. Jefferson Blvd., Los Angeles 16, Calif. ADV. PG. 136.
- Ⓞ AMERICAN PHENOLIC CORP., 1830 S. 54th Ave., Chicago 50, Ill. ADV. PG. 61.
- Ⓞ Arlington Electric Products, Inc., 500 W. 52nd St., New York 19, N. Y.
- Ⓞ BARKER & WILLIAMSON, 235 Fairfield Ave., Upper Darby, Pa. ADV. PG. 292.
- Ⓞ Buggie & Co., H. H., 726 Stanton St., Toledo, Ohio.
- Ⓞ Cable Electric Products Co., Providence, R. I.
- Ⓞ CITATION PRODUCTS CO., 233 E. 146th St., New York 51, N. Y. ADV. PG. 388.
- Ⓞ COILCRAFT, INC., 3716 N. Cicero Ave., Chicago 41, Ill. ADV. PG. 360.
- Ⓞ Connecticut Telephone & Electric Corp., 70 Britannia St., Meriden, Conn.
- Ⓞ Cossor (Canada) Ltd., 301-303 Windsor St., Halifax, N. S., Canada.
- Ⓞ DAVEN CO., 191 Central Ave., Newark 4, N. J. ADV. PG. 157.
- Ⓞ Dielectric Materials Co., 5315-17 N. Ravenswood Ave., Chicago 40, Ill.
- Ⓞ Eastern Specialty Co., Philadelphia 40, Pa.
- Ⓞ Edwards Co., Inc., 86 Boston Post Rd., Norwalk, Conn.
- Ⓞ Electro-Wire Service, 5 Beekman St., New York 7, N. Y.
- Electronic Brazing Co., 140 Glenridge Ave., Montclair, N. J.
- Englewood Electrical Supply Co., 5801 S. Halsted St., Chicago, Ill.
- Ⓞ Essex Wire Corp., 1601 Wall St., Fort Wayne 6, Ind.
- Ⓞ Etraco Mfg. Co., Inc., Woods Church Rd., Flemington, N. J.
- Ⓞ FEDERAL TELEPHONE & RADIO CORP., 88 Kingsland Rd., Clifton, N. J. ADV. PG. 161-163.
- Ⓞ FRANKLIN AIRLOOP CORP., 43-20 34th St., Long Island City 1, N. Y. ADV. PG. 44.
- Ⓞ FRANKLIN MFG. CORP., A. W., 43-20 34th St., Long Island City, N. Y. ADV. PG. 45.
- Ⓞ General Insulated Wire Works, Inc., 69 Gordon Ave., Providence 5, R. I.
- Ⓞ General R-F Fittings Co., 702 Beacon St., Boston 15, Mass.
- Ⓞ HEPPNER MFG. CO., P. O. Box 612, Round Lake, Ill. ADV. PG. 413.
- Ⓞ Industrial Electronics Co., Hanover, Mass.
- Ⓞ Insuline Corp. of America, 36-02 35th Ave., Long Island City, N. Y.
- Ⓞ KELLOGG SWITCHBOARD & SUPPLY CO., 6650 S. Cicero Ave., Chicago 38, Ill. ADV. PG. 294.
- Ⓞ Keystone Electronics Corp., 423 Broome St., New York 12, N. Y.
- Ⓞ KINGS ELECTRONICS, 40 Marbledale Rd., Tuckahoe, N. Y. ADV. PG. 180, 181.
- Loral Electronics Corp., 794 E. 140th St., New York 54, N. Y.

- Ⓞ MacLeod & Hanopold, Inc., 10 Joiner St., Charlestown 29, Mass.
- Ⓞ Magna Electronics Co., 3707-11 W. Jefferson Blvd., Los Angeles 16, Calif.
- Ⓞ Measurement Engineering, Ltd., Arnprior, Ontario, Canada.
- Ⓞ MODELECTRIC PRODUCTS CORP., 1500 Bangs Ave., Asbury Park, N. J. ADV. PG. 204.
- Ⓞ Molded Insulation Co., 335 E. Price St., Philadelphia, Pa.
- Ⓞ National Tel-Tronics Corp., 35 St. Casmirs Ave., Yonkers, N. Y.
- Ⓞ NEO-SIL CORP., 26 Cornelison Ave., Jersey City 4, N. J. ADV. PG. 253.
- Ⓞ Network Mfg. Corp., Bayonne, N. J.
- Ⓞ ORTHON CORP., 196 Albion Ave., Paterson 2, N. J. ADV. PG. 156.
- Ⓞ Pacific Electricord Co., 3217 Exposition Place, Los Angeles 18, Calif.
- Ⓞ PENNSYLVANIA TESTING LABORATORY, Doylestown, Pa. ADV. PG. 350.
- Ⓞ Peschel Electronics, Inc., 13 Garden St., New Rochelle, N. Y.
- Ⓞ Philco Corp., Tioga & C Sts., Philadelphia 34, Pa.
- Ⓞ Plastic Wire & Cable Corp., Jewett City, Conn.
- Ⓞ Press Wireless Mfg. Co., Inc., Cantiague Rd., Hicksville, N. Y.
- Ⓞ PRODUCT DEVELOPMENT CO., INC., Arlington, N. J. ADV. PG. 362.
- Ⓞ Radiation Counter Laboratories, Inc., 1844 W. 21st St., Chicago 8, Ill.
- Ⓞ Raypar, Inc., 7800 W. Addison St., Chicago, Ill.
- Ⓞ Rhode Island Insulated Wire Co., Inc., 50 Burnham Ave., Cranston, R. I.
- Ⓞ Schott Co., Walter L., 3225 Exposition Pl., Los Angeles 18, Calif.
- Ⓞ Sherman Industrial Electronics Co., Inc., 505 Washington Ave., Belleville, N. J.
- Ⓞ Shevers, Inc., Harold, 123 W. 64th St., New York 23, N. Y.
- Star Measurements Co., 442 E. 166th St., New York 56, N. Y.
- Ⓞ TECHNICAL APPLIANCE CORP., Sherburne, N. Y. ADV. PG. 378.
- Ⓞ TENSOLITE INSULATED WIRE CO., 198 Main St., Tarrytown, N. Y. ADV. PG. 316.
- Ⓞ TRAD TELEVISION CORP., 1001 First Ave., Asbury Park, N. J. ADV. PG. 355.
- Ⓞ UNITED MFG. & SERVICE CO., 405 S. Sixth St., Milwaukee 4, Wis. ADV. PG. 324.
- Ⓞ WALTHAM HOROLOGICAL CORP., Waltham, Mass. ADV. PG. 407.
- Ⓞ Whitaker Cable Corp., Kansas City 16, Mo.
- Ⓞ Winslow Co., Inc., 9 Liberty St., Newark 5, N. J.

CABLE HOOKS

- Ⓞ KELLOGG SWITCHBOARD & SUPPLY CO., 6650 S. Cicero Ave., Chicago 38, Ill. ADV. PG. 294.
- Ⓞ Laughlin Co., Thomas, 199 Fore, Portland, Me.
- Ⓞ Locke Incorporated, P. O. Box 57, Baltimore 3, Md.
- Ⓞ Star Expansion Bolt Co., 147-149 Cedar St., New York 6, N. Y.

CABLE—Coaxial Flexible

- Ⓞ Alpha Wire Corp., 430 Broadway, New York, N. Y.
- Ⓞ AMERICAN PHENOLIC CORP., 1830 S. 54th Ave., Chicago 50, Ill. ADV. PG. 61.
- Ⓞ Anaconda Wire & Cable Co., 25 Broadway, New York 4, N. Y.
- Ⓞ Belden Mfg. Co., 4647 W. Van Buren St., Chicago 44, Ill.
- Ⓞ Boston Insulated Wire & Cable Co., 63 Bay St., Boston 25, Mass.
- Ⓞ BRAND & CO., INC., WM., North & Valley Sts., Willimantic, Conn. ADV. PG. 248, 249.
- Ⓞ Chase Brass & Copper Co., Inc., 236 Grand St., Waterbury 20, Conn.
- Ⓞ CHESTER CABLE CORP., Hill St., Chester, N. Y. ADV. PG. 207.
- Ⓞ Clear Beam Television Antenna Co., 618 N. La Brea Ave., Los Angeles 36, Calif.
- Ⓞ COLUMBIA WIRE & SUPPLY CO., 2850 Irving Park Rd., Chicago 18, Ill. ADV. PG. 396.
- Ⓞ Communication Products Co., Inc., Marlboro, N. J.
- Ⓞ Consolidated Wire & Associated Companies, 1635 S. Clinton St., Chicago 16, Ill.
- Ⓞ Cossor (Canada) Ltd., 301-303 Windsor St., Halifax, N. S., Canada.
- Ⓞ Dielectric Materials Co., 5315-17 N. Ravenswood Ave., Chicago 40, Ill.
- Ⓞ FEDERAL TELEPHONE AND RADIO CORP., 88 Kingsland Rd., Clifton, N. J. ADV. PG. 161-163.
- Ⓞ General Insulated Wire Works, Inc., 69 Gordon Ave., Providence 5, R. I.
- Ⓞ GENERAL RADIO CO., 275 Massachusetts Ave., Cambridge 39, Mass. ADV. PG. 48, 49.
- Ⓞ Hazard Insulated Wire Works Div., The Okonite Co., Wilkes-Barre, Pa.
- Ⓞ J F D MFG. CO., 6101-23 Sixteenth Ave., Brooklyn, N. Y. ADV. PG. 407.
- Ⓞ Okonite Co., Canal St., Passaic, N. J.
- Ⓞ Pacific Electricord Co., 3217 Exposition Place, Los Angeles 18, Calif.
- Ⓞ PHALLO PLASTICS CORP., 25 Foster St., Worcester 8, Mass. ADV. PG. 282.

- Ⓞ Phelps Dodge Copper Products Corp., 40 Wall Street, New York 5, N. Y.
- Ⓞ Philco Corp., Tioga & C Sts., Philadelphia 34, Pa.
- Ⓞ Plastic Wire & Cable Corp., Jewett City, Conn.
- Ⓞ PLASTOID CORP., 10 Mill Rd., Hamburg, N. J. ADV. PG. 117.
- Ⓞ PRODUCT DEVELOPMENT CO., INC., Arlington, N. J. ADV. PG. 362.
- Ⓞ RADIO CORP. OF AMERICA, RCA Victor Div., General Offices, Camden, N. J. ADV. PG. 177, Inside Back and Back Covers.
- Ⓞ Rockbestos Products Corp., 285 Nicoll St., New Haven 4, Conn.
- Ⓞ Simplex Wire & Cable Co., 79 Sidney St., Cambridge 39, Mass.
- Ⓞ Standard Telephones & Cables Ltd., Connaught House, Aldwych, London, W. C. 2, England.
- Ⓞ STERLING CABLE CO., 350 Fifth Ave., New York 1, N. Y. ADV. PG. 412.
- Ⓞ Surprenant Mfg. Co., 199 Washington St., Boston, 10, Mass.
- Ⓞ TENSOLITE INSULATED WIRE CO., 198 Main St., Tarrytown, N. Y. ADV. PG. 316.
- Ⓞ Transradio Ltd., 138-A Cromwell Rd., London SW 7, England.
- Ⓞ Uniform Tubes, Shurs Lane & Larulston St., Roxborough, Philadelphia 28, Pa.
- Ⓞ Ward Products Corp., Div. of The Gabriel Co., 1523 W. 45th St., Cleveland 3, Ohio.
- Ⓞ Weymouth Instrument Co., 1440 Commercial St., East Weymouth 89, Mass.
- Ⓞ Whitney Blake Co., Box K, New Haven 14, Conn.

CABLE—Coaxial Rigid

- Ⓞ Alpha Wire Corp., 430 Broadway, New York, N. Y.
- Ⓞ American Steel & Wire Co., Rockefeller Bldg., Cleveland 13, Ohio.
- Ⓞ Anaconda Wire & Cable Co., 25 Broadway, New York 4, N. Y.
- Ⓞ ANSONIA ELECTRICAL CO., 63 Main St., Ansonia, Conn. ADV. PG. 124.
- Ⓞ Chase Brass & Copper Co., Inc., 236 Grand St., Waterbury 20, Conn.
- Ⓞ Communication Products Co., Inc., Marlboro, N. J.
- Ⓞ Gates Radio Co., Quincy, Ill.
- Ⓞ General Cable Corp., 420 Lexington Ave., New York 17, N. Y.
- Ⓞ JOHNSON CO., E. F., Waseca, Minn. ADV. PG. 118, 121.
- Ⓞ KINGS MICROWAVE CO., INC., 50 Marbledale Rd., Tuckahoe 7, N. Y. ADV. PG. 178, 179.
- Ⓞ PRODUCT DEVELOPMENT CO., INC., Arlington, N. J. ADV. PG. 362.
- Ⓞ RADIO CORP. OF AMERICA, RCA Victor Div., General Offices, Camden, N. J. ADV. PG. 177, Inside Back & Back Covers.
- Selectar Industries, Inc., 401 E. 138th St., New York 54, N. Y.
- Ⓞ SPERRY GYROSCOPE CO., Div. of The Sperry Corp., Great Neck, N. Y. ADV. PG. 103, 104.
- Ⓞ Standard Telephones & Cables Ltd., Connaught House, Aldwych, London, W. C. 2, England.
- Ⓞ STERLING CABLE CO., 350 Fifth Ave., New York 1, N. Y. ADV. PG. 412.
- Ⓞ Uniform Tubes, Shurs Lane & Larulston St., Roxborough, Philadelphia 28, Pa.

CABLE—Insulated

- Ⓞ Advance Insulated Wire & Cable Co., 115 Spring St., Morristown, N. J.
- Ⓞ Alpha Wire Corp., 430 Broadway, New York, N. Y.
- Ⓞ AMERICAN PHENOLIC CORP., 1830 S. 54th Ave., Chicago 50, Ill. ADV. PG. 61.
- Ⓞ American Steel & Wire Co., Rockefeller Bldg., Cleveland 13, Ohio.
- Ⓞ Anaconda Wire & Cable Co., 25 Broadway, New York 4, N. Y.
- Ⓞ ANSONIA ELECTRICAL CO., 63 Main St., Ansonia, Conn. ADV. PG. 124.
- Ⓞ Belden Mfg. Co., 4647 W. Van Buren St., Chicago 44, Ill.
- Birnbach Radio Co., Inc., 145 Hudson St., New York, N. Y.
- Ⓞ BISHOP MFG. CO., 254 W. 31st St., New York 1, N. Y. ADV. PG. 224.
- Ⓞ Boston Insulated Wire & Cable Co., 63 Bay St., Boston 25, Mass.
- Ⓞ BRAND & CO., INC., WM., North & Valley Sts., Willimantic, Conn. ADV. PG. 248, 249.
- Ⓞ Carol Cable Co., 190 Middle St., Pawtucket, R. I.
- Ⓞ Chase Brass & Copper Co., Inc., 236 Grand St., Waterbury 20, Conn.
- Ⓞ CHESTER CABLE CORP., Hill St., Chester, N. Y. ADV. PG. 207.
- Ⓞ COLUMBIA WIRE & SUPPLY CO., 2850 Irving Park Rd., Chicago 18, Ill. ADV. PG. 396.
- Ⓞ Consolidated Wire & Associated Companies, 1635 S. Clinton St., Chicago 16, Ill.
- Ⓞ CORNISH WIRE CO., 50 Church St., New York 7, N. Y. ADV. PG. 71.
- Ⓞ Cossor (Canada) Ltd., 301-303 Windsor St., Halifax, N. S., Canada.
- Ⓞ Diamond Wire & Cable Co., Sycamore, Ill.
- Ⓞ Dielectric Materials Co., 5315-17 N. Ravenswood Ave., Chicago 40, Ill.

V indicates . . . IN PRODUCTION • AVAILABILITY • UNRESTRICTED FOR GENERAL USE

- Essex Wire Corp., 1601 Wall St., Fort Wayne 6, Ind.
- FEDERAL TELEPHONE AND RADIO CORP., 88 Kingsland Rd., Clifton, N. J. ADV. PG. 161-163.
- General Cable Corp., 420 Lexington Ave., New York 17, N. Y.
- General Insulated Wire Works, Inc., 69 Gordon Ave., Providence 5, R. I.
- Goldmark Wire Co., James, The, 75 Murray St., New York 7, N. Y.
- Hazard Insulated Wire Works, Div., The Okonite Co., Wilkes-Barre, Pa.
- KELLOGG SWITCHBOARD & SUPPLY CO., 6650 S. Cicero Ave., Chicago 38, Ill. ADV. PG. 294.
- LENZ ELECTRIC MFG. CO., 1751 North Western Ave., Chicago 47, Ill. ADV. PG. 236.
- Okonite Co., Canal St., Passaic, N. J.
- PHALO PLASTICS CORP., 25 Foster St., Worcester 8, Mass. ADV. PG. 282.
- Phelps Dodge Copper Products Corp., 40 Wall St., New York 5, N. Y.
- Plastic Wire & Cable Corp., Jewett City, Conn.
- PLASTOID CORP., 10 Mill Rd., Hamburg, N. J. ADV. PG. 117.
- PRODUCT DEVELOPMENT CO., INC., Arlington, N. J. ADV. PG. 362.
- Rhode Island Insulated Wire Co., Inc., 50 Burnham Ave., Cranston, R. I.
- Rockbestos Products Corp., 285 Nicol St., New Haven 4, Conn.
- Roebling's Sons Co., John A., 640 Broad St., Trenton 2, N. J.
- ROME CABLE CORP., 330 Ridge St., Rome, N. Y. ADV. PG. 215.
- Runzel Cord & Wire Co., 4723-31 W. Montrose Ave., Chicago 41, Ill.
- Simplex Wire & Cable Co., 79 Sidney St., Cambridge 39, Mass.
- Standard Telephones & Cables Ltd., Connaught House, Aldwych, London, W. C. 2, England.
- STERLING CABLE CO., 350 Fifth Ave., New York 1, N. Y. ADV. PG. 412.
- Surprenant Mfg. Co., 199 Washington St., Boston 10, Mass.
- TENSOLITE INSULATED WIRE CO., 198 Main St., Tarrytown, N. Y. ADV. PG. 316.
- U. S. Rubber Co., 1230 Avenue of the Americas, New York 20, N. Y.
- Western Insulated Wire Co., 2421 E. 30th St., Los Angeles, Calif.
- Whitaker Cable Corp., Kansas City 16, Mo.
- Whitney Blake Co., Box K, New Haven 14, Conn.

CABLE—Microphone

- Alpha Wire Corp., 430 Broadway, New York, N. Y.
- AMERICAN PHENOLIC CORP., 1830 S. 54th Ave., Chicago 50, Ill. ADV. PG. 61.
- American Steel & Wire Co., Rockefeller Bldg., Cleveland 13, Ohio.
- Belden Mfg. Co., 4647 W. Van Buren St., Chicago 44, Ill.
- Birnbach Radio Co., Inc., 145 Hudson St., New York, N. Y.
- BRAND & CO., INC., WM., North & Valley Sts., Willimantic, Conn. ADV. PG. 248, 249.
- Carol Cable Co., 190 Middle St., Pawtucket, R. I.
- CHESTER CABLE CORP., Hill St., Chester, N. Y. ADV. PG. 207.
- Collins Radio Co., Cedar Rapids, Iowa.
- COLUMBIA WIRE & SUPPLY CO., 2850 Irving Park Rd., Chicago 18, Ill. ADV. PG. 396.
- Consolidated Wire & Associated Companies, 1635 S. Clinton St., Chicago 16, Ill.
- CORNISH WIRE CO., 50 Church St., New York 7, N. Y. ADV. PG. 71.
- Cossor (Canada) Ltd., 301-303 Windsor St., Halifax, N. S., Canada.
- Dielectric Materials Co., 5315-17 N. Ravenswood Ave., Chicago 40, Ill.
- Essex Wire Corp., 1601 Wall St., Fort Wayne 6, Ind.
- FEDERAL TELEPHONE & RADIO CORP., 88 Kingsland Rd., Clifton, N. J. ADV. PG. 161-163.
- General Cable Corp., 420 Lexington Ave., New York 17, N. Y.
- General Insulated Wire Works, Inc., 69 Gordon Ave., Providence 5, R. I.
- Goldmark Wire Co., James, The, 75 Murray St., New York 7, N. Y.
- Hazard Insulated Wire Works Div., The Okonite Co., Wilkes-Barre, Pa.
- J F D MFG. CO., 6101-23 Sixteenth Ave., Brooklyn, N. Y. ADV. PG. 407.
- LENZ ELECTRIC MFG. CO., 1751 North Western Ave., Chicago 47, Ill. ADV. PG. 236.
- National Tel-Tronics Corp., 35 St. Casmlrs Ave., Yonkers, N. Y.
- Okonite Co., Canal St., Passaic, N. J.
- PHALO PLASTICS CORP., 25 Foster St., Worcester 8, Mass. ADV. PG. 282.
- Phelps Dodge Copper Products Corp., 40 Wall Street, New York 5, N. Y.
- Plastic Wire & Cable Corp., Jewett City, Conn.
- PLASTOID CORP., 10 Mill Rd., Hamburg, N. J. ADV. PG. 117.
- PRODUCT DEVELOPMENT CO., INC., Arlington, N. J. ADV. PG. 362.
- RADIO CORP. OF AMERICA, RCA Victor Div., General Offices, Camden, N. J. ADV. PG. 177, Inside Back & Back Covers.
- ROME CABLE CORP., 330 Ridge St., Rome, N. Y. ADV. PG. 215.
- Runzel Cord & Wire Co., 4723-31 W. Montrose Ave., Chicago 41, Ill.
- Simplex Wire & Cable Co., 79 Sidney St., Cambridge 39, Mass.
- Standard Telephones & Cables Ltd., Connaught House, Aldwych, London, W. C. 2, England.
- STERLING CABLE CO., 350 Fifth Ave., New York 1, N. Y. ADV. PG. 412.
- Surprenant Mfg. Co., 199 Washington St., Boston 10, Mass.
- TENSOLITE INSULATED WIRE CO., 198 Main St., Tarrytown, N. Y. ADV. PG. 316.
- Uniform Tubes, Shurs Lane & Laruiston St., Roxborough, Philadelphia 28, Pa.
- Western Insulated Wire Co., 2431 E. 30th St., Los Angeles, Calif.
- Whitaker Cable Corp., Kansas City 16, Mo.
- Whitney Blake Co., Box K, New Haven 14, Conn.

- ROME CABLE CORP., 330 Ridge St., Rome, N. Y. ADV. PG. 215.
- Schott Co., Walter L., 3225 Exposition Pl., Los Angeles 18, Calif.
- Simplex Wire & Cable Co., 79 Sidney St., Cambridge 39, Mass.
- STERLING CABLE CO., 350 Fifth Ave., New York 1, N. Y. ADV. PG. 412.
- Surprenant Mfg. Co., 199 Washington St., Boston 10, Mass.
- TENSOLITE INSULATED WIRE CO., 198 Main St., Tarrytown, N. Y. ADV. PG. 316.
- U. S. Rubber Co., 1230 Avenue of the Americas, New York 20, N. Y.
- Western Insulated Wire Co., 2421 E. 30th St., Los Angeles, Calif.
- Whitney Blake Co., Box K, New Haven 14, Conn.

CABLE—Shielded

- Alpha Wire Corp., 430 Broadway, New York, N. Y.
- American Electric Cable Co., 181 Appleton St., Holyoke, Mass.
- AMERICAN PHENOLIC CORP., 1830 S. 54th Ave., Chicago 50, Ill. ADV. PG. 61.
- American Steel & Wire Co., Rockefeller Bldg., Cleveland 13, Ohio.
- Anaconda Wire & Cable Co., 25 Broadway, New York 4, N. Y.
- ANSONIA ELECTRICAL CO., 63 Main St., Ansonia, Conn. ADV. PG. 124.
- Belden Mfg. Co., 4647 W. Van Buren St., Chicago 44, Ill.
- Birnbach Radio Co., Inc., 145 Hudson St., New York, N. Y.
- Boston Insulated Wire & Cable Co., 63 Bay St., Boston 25, Mass.
- BRAND & CO., INC., WM., North & Valley Sts., Willimantic, Conn. ADV. PG. 248, 249.
- Carol Cable Co., 190 Middle St., Pawtucket, R. I.
- Chase Brass & Copper Co., Inc., 236 Grand St., Waterbury 20, Conn.
- CHESTER CABLE CORP., Hill St., Chester, N. Y. ADV. PG. 207.
- COLUMBIA WIRE & SUPPLY CO., 2850 Irving Park Rd., Chicago 18, Ill. ADV. PG. 396.
- Consolidated Wire & Associated Companies, 1635 S. Clinton St., Chicago 16, Ill.
- CORNISH WIRE CO., 50 Church St., New York 7, N. Y. ADV. PG. 71.
- Cossor (Canada) Ltd., 301-303 Windsor St., Halifax, N. S., Canada.
- Dielectric Materials Co., 5315-17 N. Ravenswood Ave., Chicago 40, Ill.
- Essex Wire Corp., 1601 Wall St., Fort Wayne 6, Ind.
- FEDERAL TELEPHONE & RADIO CORP., 88 Kingsland Rd., Clifton, N. J. ADV. PG. 161-163.
- General Cable Corp., 420 Lexington Ave., New York 17, N. Y.
- General Insulated Wire Works, Inc., 69 Gordon Ave., Providence 5, R. I.
- GENERAL RADIO CO., 275 Massachusetts Ave., Cambridge 39, Mass. ADV. PG. 48, 49.
- Goldmark Wire Co., James, The, 75 Murray St., New York 7, N. Y.
- Hallett Mfg. Co., 1601 Florence Ave., Inglewood, Calif.
- Hazard Insulated Wire Works Div., The Okonite Co., Wilkes-Barre, Pa.
- J F D MFG. CO., 6101-23 Sixteenth Ave., Brooklyn, N. Y. ADV. PG. 407.
- LENZ ELECTRIC MFG. CO., 1751 North Western Ave., Chicago 47, Ill. ADV. PG. 236.
- National Tel-Tronics Corp., 35 St. Casmlrs Ave., Yonkers, N. Y.
- Okonite Co., Canal St., Passaic, N. J.
- PHALO PLASTICS CORP., 25 Foster St., Worcester 8, Mass. ADV. PG. 282.
- Phelps Dodge Copper Products Corp., 40 Wall Street, New York 5, N. Y.
- Plastic Wire & Cable Corp., Jewett City, Conn.
- PLASTOID CORP., 10 Mill Rd., Hamburg, N. J. ADV. PG. 117.
- PRODUCT DEVELOPMENT CO., INC., Arlington, N. J. ADV. PG. 362.
- RADIO CORP. OF AMERICA, RCA Victor Div., General Offices, Camden, N. J. ADV. PG. 177, Inside Back & Back Covers.
- ROME CABLE CORP., 330 Ridge St., Rome, N. Y. ADV. PG. 215.
- Runzel Cord & Wire Co., 4723-31 W. Montrose Ave., Chicago 41, Ill.
- Simplex Wire & Cable Co., 79 Sidney St., Cambridge 39, Mass.
- Standard Telephones & Cables Ltd., Connaught House, Aldwych, London, W. C. 2, England.
- STERLING CABLE CO., 350 Fifth Ave., New York 1, N. Y. ADV. PG. 412.
- Surprenant Mfg. Co., 199 Washington St., Boston 10, Mass.
- TENSOLITE INSULATED WIRE CO., 198 Main St., Tarrytown, N. Y. ADV. PG. 316.
- Uniform Tubes, Shurs Lane & Laruiston St., Roxborough, Philadelphia 28, Pa.
- Western Insulated Wire Co., 2431 E. 30th St., Los Angeles, Calif.
- Whitaker Cable Corp., Kansas City 16, Mo.
- Whitney Blake Co., Box K, New Haven 14, Conn.

CABLE—Transmission Line

- Advance Insulated Wire & Cable Co., 115 Spring St., Morristown, N. J.
- ALDEN PRODUCTS CO., 117 N. Main St., Brockton 64, Mass. ADV. PG. 327.
- Alpha Wire Corp., 430 Broadway, New York, N. Y.
- AMERICAN PHENOLIC CORP., 1830 S. 54th Ave., Chicago 50, Ill. ADV. PG. 61.
- American Steel & Wire Co., Rockefeller Bldg., Cleveland 13, Ohio.
- Anaconda Wire & Cable Co., 25 Broadway, New York 4, N. Y.
- Belden Mfg. Co., 4647 W. Van Buren St., Chicago 44, Ill.
- Birnbach Radio Co., Inc., 145 Hudson St., New York, N. Y.
- Boston Insulated Wire & Cable Co., 63 Bay St., Boston 25, Mass.
- BRAND & CO., INC., WM., North & Valley Sts., Willimantic, Conn. ADV. PG. 248, 249.
- CHESTER CABLE CORP., Hill St., Chester, N. Y. ADV. PG. 207.
- COLUMBIA WIRE & SUPPLY CO., 2850 Irving Park Rd., Chicago 18, Ill. ADV. PG. 396.
- Communication Products Co., Inc., Marlboro, N. J.
- Consolidated Wire & Associated Companies, 1635 S. Clinton St., Chicago 16, Ill.
- Copperwell Steel Co., Glassport, Pa.
- Cossor (Canada) Ltd., 301-303 Windsor St., Halifax, N. S., Canada.
- Essex Wire Corp., 1601 Wall St., Fort Wayne 6, Ind.
- FEDERAL TELEPHONE & RADIO CORP., 88 Kingsland Rd., Clifton, N. J. ADV. PG. 161-163.
- Gates Radio Co., Quincy, Ill.
- General Cable Corp., 420 Lexington Ave., New York 17, N. Y.
- General Insulated Wire Works, Inc., 69 Gordon Ave., Providence 5, R. I.
- Hazard Insulated Wire Works Div., The Okonite Co., Wilkes-Barre, Pa.
- Insuline Corp. of America, 36-02 35th Ave., Long Island City, N. Y.
- Jersey Specialty Co., Little Falls, N. J.
- J F D MFG. CO., 6101-23 Sixteenth Ave., Brooklyn, N. Y. ADV. PG. 407.
- JOHNSON CO., E. F., Waseca, Minn. ADV. PG. 118, 121.
- LENZ ELECTRIC MFG. CO., 1751 North Western Ave., Chicago 47, Ill. ADV. PG. 236.
- Okonite Co., Canal St., Passaic, N. J.
- PHALO PLASTICS CORP., 25 Foster St., Worcester 8, Mass. ADV. PG. 282.
- Phelps Dodge Copper Products Corp., 40 Wall Street, New York 5, N. Y.
- Phico Corp., Toga & C Sts., Philadelphia 34, Pa.
- PLASTOID CORP., 10 Mill Rd., Hamburg, N. J. ADV. PG. 117.
- PRODUCT DEVELOPMENT CO., INC., Arlington, N. J. ADV. PG. 362.
- RADIO CORP. OF AMERICA, RCA Victor Div., General Offices, Camden, N. J. ADV. PG. 177, Inside Back & Back Covers.
- Roebling's Sons, John A., 640 Broad St., Trenton 2, N. J.
- ROME CABLE CORP., 330 Ridge St., Rome, N. Y. ADV. PG. 215.
- Selectar Industries, Inc., 401 E. 138th St., New York 54, N. Y.
- Standard Telephones & Cables Ltd., Connaught House, Aldwych, London, W. C. 2, England.
- STERLING CABLE CO., 350 Fifth Ave., New York 1, N. Y. ADV. PG. 412.
- Surprenant Mfg. Co., 199 Washington St., Boston 8, Mass.
- Transradio Ltd., 138A Cromwell Rd., London S. W. 7, England.
- U. S. Rubber Co., 1230 Avenue of the Americas, New York 20, N. Y.

CABLE—uhf

- AMERICAN PHENOLIC CORP., 1830 S. 54th Ave., Chicago 50, Ill. ADV. PG. 61.
- Belden Mfg. Co., 4647 W. Van Buren St., Chicago 44, Ill.
- Birnbach Radio Co., Inc., 145 Hudson St., New York, N. Y.
- Boston Insulated Wire & Cable Co., 63 Bay St., Boston 25, Mass.
- CHESTER CABLE CORP., Hill St., Chester, N. Y. ADV. PG. 207.
- COLUMBIA WIRE & SUPPLY CO., 2850 Irving Park Rd., Chicago 18, Ill. ADV. PG. 396.
- Cossor (Canada) Ltd., 301-303 Windsor St., Halifax, N. S., Canada.
- Dielectric Materials Co., 5315-17 N. Ravenswood Ave., Chicago 40, Ill.
- FEDERAL TELEPHONE AND RADIO CORP., 88 Kingsland Rd., Clifton, N. J. ADV. PG. 161-163.
- General Cable Corp., 420 Lexington Ave., New York 17, N. Y.
- General Insulated Wire Works, Inc., 69 Gordon Ave., Providence 5, R. I.
- GENERAL RADIO CO., 275 Massachusetts Ave., Cambridge 39, Mass. ADV. PG. 48, 49.
- Hazard Insulated Wire Works Div., The Okonite Co., Wilkes-Barre, Pa.

V indicates . . . IN PRODUCTION • AVAILABILITY • UNRESTRICTED FOR GENERAL USE

- Ⓞ Okonite Co., Canal St., Passaic, N. J.
- Ⓞ PHALO PLASTICS CORP., 25 Foster St., Worcester 8, Mass. ADV. PG. 282.
- Ⓞ PRODUCT DEVELOPMENT CO., INC., Arlington, N. J. ADV. PG. 362.
- Ⓞ Simplex Wire & Cable Co., 79 Sidney St., Cambridge 39, Mass.
- Ⓞ Standard Telephones & Cables Ltd., Connaught House, Aldwych, London, W. C. 2, England.
- Ⓞ STERLING CABLE CO., 350 Fifth Ave., New York 1, N. Y. ADV. PG. 412.
- Ⓞ Surprenant Mfg. Corp., 199 Washington St., Boston 8, Mass.
- Ⓞ Transradio, Ltd., 138A Cromwell Rd., London S. W. 7, England.

CALIBRATORS—Sweep

- Ⓞ Berkshire Laboratories, 580 Lexington Rd., Concord, Mass.
- Ⓞ Bunnell & Co., J. H., 81 Prospect St., Brooklyn, N. Y. Ionic Electronic Equipment Co., 1705 N. Kenmore, Los Angeles 27, Calif.
- Ⓞ Jackson Electrical Instrument Co., 16 S. Patterson Blvd., Dayton 1, Ohio.
- Ⓞ KAY ELECTRIC CO., 14 Maple Ave., Pine Brook, N. J. ADV. PG. 340.
- Ⓞ MARCONI INSTRUMENTS, LTD., 23 Beaver St., New York 4, N. Y. ADV. PG. 270.
- Ⓞ McMurdo Silver Co., Inc., 473 Lafayette St., New York, N. Y.
- Ⓞ Monarch Radio & Television Corp., 2430 Atlantic Ave., Brooklyn 33, N. Y.
- Ⓞ Network Mfg. Corp., Bayonne, N. J.
- Ⓞ Owen Laboratories, 412 Woodward Blvd., Pasadena 10, Calif.
- Ⓞ POLARAD ELECTRONICS CORP., 100 Metropolitan Ave., Brooklyn 11, N. Y. ADV. PG. 184, 185.
- Ⓞ RADIO CORP. OF AMERICA, Tube Dept., Harrison, N. J. ADV. PG. 177, Inside Back & Back Covers.
- Ⓞ Ripley Co., Inc., Middletown, Conn.
- Ⓞ SHERRON ELECTRONICS CO., 1201 Flushing Ave., Brooklyn 6, N. Y. ADV. PG. 145.
- Ⓞ Tel-Instrument Co., Inc., 50 Patterson Ave., East Rutherford, N. J.
- Ⓞ TRAD TELEVISION CORP., 1001 First Ave., Asbury Park, N. J. ADV. PG. 355.

CALIBRATORS—uht

- Ⓞ AMERICAN ELECTRONEERING CORP., 5025-29 W. Jefferson Blvd., Los Angeles 16, Calif. ADV. PG. 136.
- Ⓞ Ferris Instrument Co., 110 Cornelia St., Boonton, N. J.
- Ⓞ KAY ELECTRIC CO., 14 Maple Ave., Pine Brook, N. J. ADV. PG. 340.
- Ⓞ LAVOIE LABORATORIES, Morganville, N. J. ADV. PG. 206.
- Ⓞ MARCONI INSTRUMENTS, LTD., 23 Beaver St., New York 4, N. Y. ADV. PG. 270.
- Ⓞ Measurement Engineering, Ltd., Arnprior, Ontario, Canada.
- Ⓞ MEASUREMENTS CORP., Boonton, N. J. ADV. PG. 99.
- Ⓞ POLYTECHNIC RESEARCH & DEVELOPMENT CO., INC., 202 Tillary St., Brooklyn 1, N. Y. ADV. PG. 172, 173.
- Ⓞ Radioactive Products, Inc., 443 W. Congress St., Detroit 26, Mich.
- Ⓞ VECTRON, INC., 235 High St., Waltham, Mass. ADV. PG. 214.

CAMERAS—Radar Recording

- Ⓞ FAIRCHILD CAMERA & INSTRUMENT CORP., 88-06 Van Wyck Blvd., Jamaica 1, N. Y. ADV. PG. 244, 245.
- Ⓞ Flight Research Engineering Corp., P.O. Box 1-F, Richmond, Va.
- Ⓞ Maurer, Inc., J. A., 37-01 31st St., Long Island City, N. Y.
- Ⓞ Peerless Instrument Co., 90-15 Corona Ave., Elmhurst, N. Y.
- Ⓞ Photographic Products, Inc., 6916 Romaine St., Hollywood 38, Calif.

CAMERAS—Television

- Ⓞ Berndt-Bach, Inc., 7373 Beverly Blvd., Los Angeles 36, Calif.
- Ⓞ Diamond Power Specialty Corp., Lancaster, Ohio.
- Ⓞ Douglas Radio Labs., 176 Norfolk Ave., Boston 19, Mass.
- Ⓞ Du Mont Laboratories, Inc., Allen B., Television Transmitter Div., 1000 Main Ave., Clifton, N. J.
- Ⓞ Eastman Kodak Co., Industrial Photographic Div., 343 State St., Rochester 4, N. Y.
- Ⓞ Jamaica Electronic Products Co., 95-26 Sutphin Blvd., Jamaica 4, N. Y.
- Ⓞ MARCONI INSTRUMENTS, LTD., 23 Beaver St., New York 4, N. Y. ADV. PG. 270.
- Ⓞ POLARAD ELECTRONICS CORP., 100 Metropolitan Ave., Brooklyn 11, N. Y. ADV. PG. 184, 185.
- Ⓞ RADIO CORP. OF AMERICA, RCA Victor Div., General Offices, Camden N. J. ADV. PG. 177, Inside Back & Back Covers.

CAMERAS—X-Ray

- Ⓞ FAIRCHILD CAMERA & INSTRUMENT CORP., 88-06 Van Wyck Blvd., Jamaica 1, N. Y. ADV. PG. 244, 245.
- Ⓞ Jarrel-Ash Co., 165 Newberry St., Boston 16, Mass.
- Ⓞ Kelley-Koett Instrument Co., 962 York St., Cincinnati 14, Ohio.
- Ⓞ North American Philips Co., Inc., 100 E. 42nd St., New York 17, N. Y.
- Ⓞ Picker X-Ray Corp., 300 Fourth Ave., New York 10, N. Y.
- Ⓞ WESTINGHOUSE ELECTRIC CORP., 511 Wood St., P.O. Box 868, Pittsburgh 30, Pa. ADV. PG. 107-113.

CANS

- Ⓞ ABALON PRECISION MFG. CORP., 540 Casanova St., Bronx 59, N. Y. ADV. PG. 348.
- Ⓞ ALDEN PRODUCTS CO., 117 N. Main St., Brockton 64, Mass. ADV. PG. 327.
- Ⓞ AMERICAN MOLDED PRODUCTS CO., 1644 N. Honore St., Chicago 22, Ill. ADV. PG. 382.
- Ⓞ ART WIRE & STAMPING CO., 227 High St., Newark 2, N. J. ADV. PG. 38.
- Ⓞ CITATION PRODUCTS CO., 233 E. 146th St., New York 51, N. Y. ADV. PG. 388.
- Ⓞ Colgate Mfg. Corp., Lindenhurst, N. Y.
- Ⓞ Continental Can Co., Inc., 100 E. 42nd St., New York 17, N. Y.
- Ⓞ CRAFT MFG. CO., 3949 W. Schubert St., Chicago, Ill. ADV. PG. 128.
- Ⓞ Donnelly Electric & Mfg. Co., 3050 Washington St., Boston 19, Mass.
- Ⓞ ELECTRO-SEAL CORP., 946 Lee St., Des Plaines, Ill. ADV. PG. 222.
- Ⓞ FALSTROM CO., 44 Falstrom Court, Passaic, N. J. ADV. PG. 196.
- Ⓞ Guthman Inc., Edwin I., 155 Throop St., Chicago, Ill.
- Ⓞ HELDOR MFG. CO., Div. of Helder Bushing & Terminal Inc., 225 Belleville Ave., Bloomfield, N. J. ADV. PG. 242.
- Ⓞ LOJACK PRECISION CORP., 32-60 62nd St., Woodside, N. Y. ADV. PG. 415.
- Ⓞ OLYMPIC METAL PRODUCTS CO., INC., Phillipsburg, N. J. ADV. PG. 358.
- Ⓞ Paul & Beekman Inc., 1801 Cortland St., Philadelphia 40, Pa.
- Ⓞ PIX MFG. CO., INC., 24 Bedford St., Newark, N. J. ADV. PG. 136.
- Ⓞ VECTOR ELECTRONIC CO., 1101 Riverside Drive, Los Angeles 21, Calif. ADV. PG. 283.
- Ⓞ Worcester Pressed Aluminum Corp., 13-15 Hope Ave., Worcester 3, Mass.

CANS—Hermetically Sealed

- Ⓞ Coil Winders, Inc., 61 Bergen St., Brooklyn 2, N. Y.
- Ⓞ Continental Can Co., Inc., 100 E. 42nd St., New York 17, N. Y.
- Ⓞ CRAFT MFG. CO., 3949 W. Schubert St., Chicago, Ill. ADV. PG. 128.
- Ⓞ DAVEN CO., 191 Central Ave., Newark 4, N. J. ADV. PG. 157.
- Ⓞ Electronic Apparatus Co., Elkhart, Ind.
- Ⓞ ELECTRO-SEAL CORP., 946 Lee St., Des Plaines, Ill. ADV. PG. 222.
- Ⓞ HELDOR MFG. CO., Div. of Helder Bushing & Terminal Inc., 225 Belleville Ave., Bloomfield, N. J. ADV. PG. 242.
- Ⓞ HERMETIC SEAL PRODUCTS CO., 29-37 S. 6th St., Newark 7, N. J. ADV. PG. 175.
- Ⓞ OLYMPIC METAL PRODUCTS CO., INC., Phillipsburg, N. J. ADV. PG. 358.
- Ⓞ SPELLMAN TELEVISION CO., INC., 3029 Webster Ave., New York 67, N. Y. ADV. PG. 277.
- Ⓞ U. S. ELECTRONICS CORP., 276 Warren St., Lyndhurst, N. J. ADV. PG. 76.

NOTE:

- Throughout all capacitor listings
- (h) indicates hermetically sealed types
- (p) indicates pressure types
- (v) indicates vacuum types

CAPACITORS

Capacitors, Fixed

1. Ceramic
2. Electrolytic
3. Energy Storage
4. Gas Filled
5. High Voltage
6. Metallized Paper
7. Mica
8. Paper
9. Plastic Dielectric
10. Power Factor
11. Precision Air
12. Pulse Forming Network
13. Silvered Mica
14. Tantalum

Capacitors, Variable

15. Trimmer-Air
16. Trimmer-Ceramic
17. Trimmer-Mica
18. Tuning-Receiver
19. Tuning-Transmitter

- Ⓞ AEROVOX CORP., 740 Belleville Ave., New Bedford, Mass. 1-2-3-5-6-7-8-9-10-12-13. ADV. PG. 252. (h)
- Ⓞ AIRCRAFT MARINE PRODUCTS, INC., 2100 Paxton St., Harrisburg 10, Pa. 5-7-8-9-12. ADV. PG. 367.
- Ⓞ American Condenser Co., 4410 Ravenswood Ave., Chicago 40, Ill. 2-8.
- Ⓞ American Radionics Co., 33 Flatbush Ave., Brooklyn, N. Y. 8.
- Ⓞ Ampere Electronic Corp., 25 Washington St., Brooklyn 1, N. Y. 5.
- Ⓞ Arco Electronics Inc., 103 Lafayette St., New York 13, N. Y. 1-7-8.
- Ⓞ Asheville-Schoonmaker Mica Co., 900 Jefferson Ave., Newport News, Va. 1.
- Ⓞ ASTRON CORP., 255 Grant Ave., East Newark, N. J. 2-6-8-9. ADV. PG. 137.
- Ⓞ Automatic Electric Sales Corp., 1033 W. Van Buren St., Chicago 7, Ill. 6.
- Ⓞ Automatic Mfg. Corp., 65 Gouverneur St., Newark, N. J. 1.
- Ⓞ BARKER & WILLIAMSON, 235 Fairfield Ave., Upper Darby, Pa. 4-19. ADV. PG. 292.
- Ⓞ Brown Electro-Measurement Corp., 4637 SE Hawthorne Blvd., Portland 13, Ore. 7.
- Ⓞ Bud Radio, Inc., 2118 E. 55th St., Cleveland 3, Ohio. 15-19.
- Ⓞ Cardwell Mfg. Co., Allan D., 97 Whiting St., Plainville, Conn. 11-19.
- Ⓞ CENTRALAB DIV. of Globe-Union, Inc., 900 E. Keefe Ave., Milwaukee 1, Wis. 1-5-16. ADV. PG. 85-88.
- Ⓞ CHICAGO CONDENSER CORP., 3255 W. Armitage Ave., Chicago 47, Ill. 8. ADV. PG. 60.
- Ⓞ Condenser Products Co., 7517 N. Clark St., Chicago 26, Ill. 3-5-9-10-12.
- Ⓞ CORNELL-DUBILIER ELECTRIC CORP., South Plainfield, N. J. 1-2-3-5-6-7-8-9-10-12-13-14. ADV. PG. 146.
- Ⓞ CORNING GLASS WORKS, Corning, N. Y. 4-16. ADV. PG. 373.
- Ⓞ Cosmic Radio Corp., 853 Whittier St., New York 59, N. Y. 2-8.
- Ⓞ Deuschmann Corp., Tobe, 921 Providence Highway, Norwood, Mass. 2-3-5-6-8-9-10-12. (h)
- Ⓞ DUMONT ELECTRIC CO., 308 Dyckman St., New York, N. Y. 2-3-5-6-8-9-10. ADV. PG. 375.
- (h) (p) (v)
- Ⓞ Eitel-McCullough, Inc., San Bruno, Calif. 3-5-11-14-19.
- Ⓞ ELECTRICAL REACTANCE CORP., Seneca Ave., Olean, N. Y. 1-5-16. ADV. PG. 56, 57.
- Ⓞ Electro Motive Mfg. Co., South Park & John St., Willimantic, Conn. 1-7-8-13-16-17.
- Ⓞ ERIE RESISTOR CORP., 644 W. 12th St., Erie, Pa. 1-5-7-9-13-16. ADV. PG. 91.
- Ⓞ Fansteel Metallurgical Corp., 2200 Sheridan Rd., North Chicago, Ill. 14.
- Ⓞ FAST & CO., JOHN E., 3101 N. Pulaski Rd., Chicago 41, Ill. 5-6-8-9-10. ADV. PG. 368.
- Ⓞ Filtron Co., Inc., 131-05 Fowler Ave., Flushing, N. Y. 8.
- (h) (v)
- Ⓞ GENERAL CERAMICS & STEATITE CORP., Kearsbey, N. J. 1. ADV. PG. 126, 127.
- Ⓞ GENERAL ELECTRIC CO., Schenectady 5, N. Y. 2-3-5-8-9-10-12-14. ADV. PG. 1 to 22.
- Ⓞ General Instrument Corp., 829 Newark Ave., Elizabeth 3, N. J. 15-18-19.
- Ⓞ GENERAL RADIO CO., 275 Massachusetts Ave., Cambridge 39, Mass. 7-11. ADV. PG. 48, 49.
- Ⓞ Glenco Corp., Metuchen, N. J. 1-16. (h)
- Ⓞ Good-All Electric Mfg. Co., 112 W. First St., Ogallala, Neb. 6-8.
- Ⓞ Gulton Mfg. Corp., Metuchen, N. J. 1-16. (h)
- Ⓞ Guthman Inc., Edwin I., 15 Throop St., Chicago, Ill. 16-17.
- Ⓞ Hammarlund Mfg. Co., 460 W. 34th St., New York 1, N. Y. 15-18-19.
- Ⓞ HANSELL, INC., U., Westerly, R. I. 1. ADV. PG. 376.
- Ⓞ Herlec Corp., 422 N. 5th St., Milwaukee, Wis. 1-2-3-5-7-8-9-10-12-13-16. (h)
- Ⓞ ILLINOIS CONDENSER CO., 1616 N. Throop St., Chicago 22, Ill. 2-3-5-8-10. ADV. PG. 47. (h)
- Ⓞ Industrial Condenser Corp., 3243 N. California Ave., Chicago 18, Ill. 2-5-8-9-10. (h)
- Ⓞ Insuline Corp. of America, 36-02 35th Ave., Long Island City, N. Y. 17.
- Ⓞ JEFFERS ELECTRONICS CO., Du Bois, Pa. 1-5. ADV. PG. 406.
- Ⓞ JENNINGS RADIO MFG. CO., 1098 E. William St., San Jose 12, Calif. 5-12-15-16-19. ADV. PG. 194, 195. (v)
- Ⓞ JOHNSON CO., E. F., Waseca, Minn. 4-5-15-19. ADV. PG. 118, 121. (p)
- Ⓞ KINGS ELECTRONICS, 40 Marbledale Rd., Tucka-hoe, N. Y. 18. ADV. PG. 180, 181.
- Ⓞ Lapp Insulator Co., Radio Specialties Div., 31 Gilbert St., LeRoy, N. Y. 4-19. (p) (v)
- Ⓞ LaRose & Associates, Inc., W. T., 646 Second Ave., Troy, N. Y. 7-9.
- Ⓞ Leeds & Northrup Co., 4970 Stenton Ave., Philadelphia 44, Pa. 7-11-13. (h)
- Ⓞ M. P. Concert Installations, Fairfield 10, Conn. 1.
- Ⓞ Magnavox Co., Components Div., Fort Wayne 4, Ind. 4.
- Ⓞ Maida Development Co., 12 E. Howard St., Phoebus, Va. 1-5-16.

(V) indicates . . . **IN PRODUCTION • AVAILABILITY • UNRESTRICTED FOR GENERAL USE**

- Mallory & Co., Inc., P. R., 3029 E. Washington St., Indianapolis 6, Ind. 1-2-6-7-8-14-16.
- MEASUREMENTS CORP., Boonton, N. J. 1-7-11-18. ADV. PG. 99.
- MICAMOLD RADIO CORP., 1087 Flushing Ave., Brooklyn 6, N. Y. 2-3-5-7-8-9-13. ADV. PG. 275.
- Millen Mfg. Co., James, 150 Exchange St., Malden, Mass. 15-17-18-19.
- Molded Insulation Co., 335 E. Price St., Philadelphia 44, Pa. 18.
- Mucon Corp., 9 St. Francis St., Newark 5, N. J. 1. (h) (p) (v)
- Muirhead & Co., Ltd., Beckenham-Kent-England. 11.
- Muter Co., 1255 S. Michigan Ave., Chicago, Ill. 1-16.
- NATIONAL CAPACITOR CO., 1828 Westminster St., Providence 8, R. I. 5-6-8-9. ADV. PG. 323. (h)
- NATIONAL CO., INC., 61 Sherman St., Malden 48, Mass. 15-18-19. ADV. PG. 280, 281.
- Oak Mfg. Co., 1260 N. Clybourn Ave., Chicago 10, Ill. 18.
- Philco Corp., Tioga & C Sts., Philadelphia 34, Pa. 1-2-7-8-13-15-16-18.
- PLANET MFG. CORP., 225 Belleville Ave., Bloomfield, N. J. 2. ADV. PG. 336.
- Polytech Devices, Inc., 1180 E. Grand St., Elizabeth, N. J. 1-5.
- Potter Co., 1850 Sheridan Rd., North Chicago, Ill. 3-5-8-10-12.
- Pyramid Electric Co., 1445 Hudson Blvd., North Bergen, N. J. 2-3-5-6-8-10. (h)
- Radio Condenser Co., Camden, N. J. 18-19.
- RADIO MATERIALS CORP., 1708 Belmont Ave., Chicago 13, Ill. 1-16. ADV. PG. 223.
- Sangamo Electric Co., Springfield, Ill. 2-5-7-8-13. Sickles Co., F. W., 165 Front St., Chicopee, Mass. 15.
- Special Products Co., Silver Spring, Md. 16.
- Sprague Electric Co., North Adams, Mass. 1-2-3-5-7-8-9-10-12-13-16. (h)
- STACKPOLE CARBON CO., St. Mary's Pa. 9. ADV. PG. 170, 171.
- Standard Telephones & Cables Ltd., Connaught House, Aldwych, London, W.C. 2, England. 3-7-8-10-13.
- STUPAKOFF CERAMIC & MFG. CO., Latrobe, Pa. 16. ADV. PG. 167.
- Telegraph Condenser Co., Ltd., Wales Farm Rd., Acton, London W 3, England. 1-2-3-5-7-8-9-10-12-13-16. (h) (v)
- Teleradio Engineering Corp., 99 Wall St., New York 5, N. Y. 15-16-17. (v)
- THOR CERAMICS INC., 225 Belleville Ave., Bloomfield, N. J. 1-16. ADV. PG. 378.
- UNITED CONDENSER CORP., 337 E. 139th St., New York 54, N. Y. 3-5-8-9. ADV. PG. 404.
- Variable Condenser Corp., 65 Hope St., Brooklyn, N. Y. 18.
- Vitramon, Inc., Stepney, Conn. 1.
- WESTINGHOUSE ELECTRIC CORP., 511 Wood St., P. O. Box 868, Pittsburgh 30, Pa. 3-5-8-10-12. ADV. PG. 107-113.
- Winslow Co., Inc., 9 Liberty St., Newark 5, N. J. 7.
- Wisconsin Porcelain Co., Sun Prairie, Wis. 1-16.

CARDIOTACHOMETERS

- EDIN CO., INC., 207 Main St., Worcester, Mass. ADV. PG. 285.

CASES, PORTABLE

(for Radios, Phonographs, Amplifiers, etc.)

- ABALON PRECISION MFG. CORP., 540 Casanova St., Bronx 59, N. Y. ADV. PG. 348.
- AIRMEC LABORATORIES LTD., 366 Madison Ave., New York 17, N. Y. ADV. PG. 336.
- Berlant Associates, 4917 W. Jefferson Blvd., Los Angeles 16, Calif.
- Bogen Co., Inc., David, 663 Broadway, New York 12, N. Y.
- Central Stamping & Mfg. Co., Polo, Ill.
- Donnelly Electric & Mfg. Co., 3050 Washington St., Boston 19, Mass.
- Eastern Case Co., 55 S. 11th St., Brooklyn 11, N. Y.
- Fairchild Recording Equipment Co., 154th St. & Seventh Ave., Whitestone, N. Y.
- Garrard Sales Corp., 164 Duane St., New York 13, N. Y.
- Hawley Products Co., St. Charles, Ill.
- Ingraham Co., E., Bristol, Conn.
- LOJACK PRECISION CORP., 32-60 62nd St., Woodside, N. Y. ADV. PG. 415.
- Magna Electronics Co., 3707-11 W. Jefferson Blvd., Los Angeles 16, Calif.
- Midwestern Geophysical Laboratory, 3400 S. Harvard, Tulsa, Okla.
- Molded Insulation Co., 335 E. Price St., Philadelphia 44, Pa.
- Newcomb Audio Products Co., 6824 Lexington Ave., Hollywood 38, Calif.
- Spaulding Fibre Co., Inc., 310 Wheeler St., Tonawanda, N. Y.
- Stamford Metal Specialty Co., Inc., 429 W. Broadway, New York 12, N. Y.
- TRAD TELEVISION CORP., 1001 First Ave., Asbury Park, N. J. ADV. PG. 355.

- Triad Portable Case Corp., 310-14 W. Lincoln Ave., Mount Vernon, N. Y.

CELLS—Photoelectric

- BRADLEY LABS., INC., 82 Meadows St., New Haven 10, Conn. ADV. PG. 349.
- CONTINENTAL ELECTRIC CO., Geneva, Ill. ADV. PG. 182.
- GENERAL ELECTRIC CO., Schenectady 5, N. Y. ADV. PG. 1 to 22.
- International Rectifier Corp., 6809 S. Victoria Ave., Los Angeles 43, Calif.
- Philco Corp., Tioga & C Sts., Philadelphia 34, Pa.
- Photobell Company, 116 Nassau St., New York 7, N. Y.
- RADIO CORP. OF AMERICA, Tube Dept., Harrison N. J. ADV. PG. 177, Inside Back and Back Covers.
- Ripley Co., Inc., Middletown, Conn.
- WESTINGHOUSE ELECTRIC CORP., 511 Wood St., P. O. Box 868, Pittsburgh 30, Pa. ADV. PG. 107-113.
- WESTON ELECTRICAL INSTRUMENT CORP., 595 Frelinghuysen Ave., Newark 5, N. J. ADV. PG. 243.
- Worner Electronic Devices, Rankin, Ill.

CEMENTS—Radio

- Ambroid Co., 305 Franklin St., Boston 10, Mass.
- AMERICAN PHENOLIC CORP., 1830 S. 54th Ave., Chicago 50, Ill. ADV. PG. 61.
- American Products Mfg. Co., Oleander & Dublin Sts., New Orleans 18, La.
- Barrett Varnish Co., 1532 S. 50th Court, Chicago 50, Ill.
- Borden Co., The, Chemical Div., 350 Madison Ave., New York 17, N. Y.
- Electro Chemical Engineering Co., 750 Broad St., Emmaus, Pa.
- General Cement Mfg. Co., 919 Taylor Ave., Rockford, Ill.
- INSL-X CO., INC., Water St., Ossining, N. Y. ADV. PG. 386.
- J F D MFG. CO., 6101-23 Sixteenth Ave., Brooklyn, N. Y. ADV. PG. 407.
- MICRO-CIRCUITS CO., New Buffalo, Mich. ADV. PG. 50.
- Moyer, C. P., 908 Chicago Ave., Chicago, Ill.
- Sauereisen Cements Co., Sauereisen Building, Pittsburgh 15, Pa.
- Schott Co., Walter L., 3225 Exposition Pl., Los Angeles 18, Calif.
- ZOPHAR MILLS, INC., 112-130 26th St., Brooklyn 32, N. Y. ADV. PG. 397.

CERAMICS

See Insulation Materials

CHAMBERS—Test

- American Instrument Co., 8030 Georgia Ave., Silver Spring, Md.
- BELLING & LEE LTD., 366 Madison Ave., New York 17, N. Y. ADV. PG. 336.
- BOWSER TECHNICAL REFRIGERATION DIV., BOWSER, INC., Terryville, Conn. ADV. PG. 132, 133.
- Northeastern Engineering, Inc., Manchester, N. H.
- Northern-Zaleski, Ltd., Pratt Oval, Glen Cove, N. Y.
- Statham Laboratories, Inc., 12401 W. Olympic Blvd., Los Angeles 64, Calif.
- TENNEY ENGINEERING INC., 26 Avenue B, Newark 5, N. J. ADV. PG. 98.

CHANGERS—Automatic Record

- Capehart-Farnsworth Corp., Fort Wayne, Indiana.
- Crescent Industries, Inc., 4140 Belmont Ave., Chicago 41, Ill.
- Gale Dorothea Mechanisms, 37-61 85th St., Jackson Heights, N. Y.
- Garrard Sales Corp., 164 Duane St., New York 13, N. Y.
- General Instrument Corp., 829 Newark Ave., Elizabeth 3, N. J.
- Milwaukee Stamping Co., 800 S. 72nd St., Milwaukee, Wis.
- Philco Corp., Tioga & C Sts., Philadelphia 34, Pa.
- V-M Corp., Benton Harbor, Mich.
- Webster-Chicago Corp., 5622 Bloomingdale Ave., Chicago 39, Ill.
- Wurlitzer Co., Rudolph, N. Tonawanda, N. Y.

CHARGERS—Battery

See Battery Chargers

CHASSIS SLIDES

See Slides, Chassis

CHASSIS—Metal

- ABALON PRECISION MFG. CORP., 540 Casanova St., Bronx 59, N. Y. ADV. PG. 348.
- ALDEN PRODUCTS CO., 117 N. Main St., Brockton 64, Mass. ADV. PG. 327.

- ART-LLOYD METAL PRODUCTS CORP., 2973 Cropsey Ave., Brooklyn 14, N. Y. ADV. PG. 364.
- Bud Radio, Inc., 2118 E. 55th St., Cleveland 3, Ohio.
- CHURCHILL CORP., 7 North Ave., Wakefield, Mass. ADV. PG. 408.
- Colgate Mfg. Corp., Lindenhurst, N. Y.
- Cossor (Canada), Ltd., 301-303 Windsor St., Halifax, N. S., Canada.
- CRAFT MFG. CO., 3949 W. Schubert St., Chicago, Ill. ADV. PG. 128.
- Dahlstrom Metallic Door Co., Jamestown, N. Y.
- Delco Radio Div., General Motors Corp., Kokomo, Ind.
- Donnelly Electric & Mfg. Co., 3050 Washington St., Boston 19, Mass.
- Edo Corp., College Point, N. Y.
- Electro Craft Inc., 52 Davenport St., Stamford, Conn.
- FALSTROM CO., 44 Falstrom Court, Passaic, N. J. ADV. PG. 196.
- Garrett Co., Inc., G. K., D & Tioga Sts., Philadelphia 34, Pa.
- Greene Mfg. Corp., G. G., Warren, Pa.
- HELDOR MFG. CO., DIV. OF HELDOR BUSHING & TERMINAL INC., 225 Belleville Ave., Bloomfield, N. J. ADV. PG. 242.
- Hingham Ordnance Co., Hingham Industrial Centre, Hingham, Mass.
- Industrial Precision Products Co., 315-325 N. Hoyne Ave., Chicago 12, Ill.
- Insuline Corp. of America, 36-02 35th Ave., Long Island City, N. Y.
- Intervox Corp., 2701 California Ave., Seattle 6, Calif.
- JOHNSON CO., E. F., Waseca, Minn. ADV. PG. 118, 121.
- KARP METAL PRODUCTS CO., INC., 215 63rd St., Brooklyn 20, N. Y. ADV. PG. 105.
- La Magna Mfg. Co., Inc., East Rutherford, N. J.
- LOJACK PRECISION CORP., 32-60 62nd St., Woodside, N. Y. ADV. PG. 415.
- Magna Electronics Co., 3707-11 W. Jefferson Blvd., Los Angeles 16, Calif.
- Measurement Engineering, Ltd., Arnprior, Ontario, Canada.
- Minute Man Products, Inc., 430 E. 102nd St., New York, N. Y.
- Molded Insulation Co., 335 E. Price St., Philadelphia 44, Pa.
- MULTI METAL CO., 1350 Garrison Ave., New York 59, N. Y. ADV. PG. 221.
- Newcomb Audio Products Co., 6824 Lexington Ave., Hollywood 38, Calif.
- OLYMPIC METAL PRODUCTS CO., INC., Phillipsburg, N. J. ADV. PG. 358.
- Par-Metal Products Corp., 32-62 49th St., Long Island City 3, N. Y.
- Pierce Template Corp., 2646 N. Coral St., Philadelphia 25, Pa.
- REF Mfg. Corp., Jericho Turnpike, Mineola, N. Y.
- Repath Co., Paul R., 641 E. 61st St., Los Angeles 1, Calif.
- SHERRON ELECTRONICS CO., 1201 Flushing Ave., Brooklyn 6, N. Y. ADV. PG. 145.
- Stamford Metal Specialty Co., Inc., 429 W. Broadway, New York 12, N. Y.
- Walter Co., Inc., S., 1400 Atlantic Ave., Brooklyn 16, N. Y.
- Worcester Pressed Aluminum Corp., 13-15 Hope Ave., Worcester, Mass.

CHASSIS—Wood

- Ingraham Co., E., Bristol, Conn.
- KEPCO LABS. INC., 149-14 41st Ave., Flushing, N. Y. ADV. PG. 54.
- Magna Electronics Co., 3707-11 W. Jefferson Blvd., Los Angeles 16, Calif.
- Short Wave Plastic Forming Co., 2921 Alameda St., Burbank, Calif.
- TRAD TELEVISION CORP., 1001 First Ave., Asbury Park, N. J. ADV. PG. 355.

CHECKERS

See also Analyzers

CHECKERS—Crystal Rectifier

- Airborne Instrument Lab., Inc., 160 Old Country Rd., Mineola, L. I., N. Y.
- AMERICAN ELECTROENGINEERING CORP., 5025-29 W. Jefferson Blvd., Los Angeles 16, Calif. ADV. PG. 136.
- Berkshire Laboratories, 580 Lexington Ave., Concord, Mass.
- MARION ELECTRICAL INSTRUMENT CO., Manchester, N. H. ADV. PG. 200.
- Transmitter Equipment Mfg. Co., Inc., 345 Hudson St., New York 14, N. Y.

CHECKERS—QX

- BOONTON RADIO CORP., Boonton, N. J. ADV. PG. 96.
- Clough Brengle Co., 6014 N. Broadway, Chicago, Ill.
- MARCONI INSTRUMENTS, LTD., 23 Beaver St., New York 4, N. Y. ADV. PG. 270.

V indicates . . . IN PRODUCTION • AVAILABILITY • UNRESTRICTED FOR GENERAL USE

CHECKERS—*vhf Circuit*

- BOONTON RADIO CORP., Boonton, N. J. ADV. PG. 96.
- WESTON ELECTRICAL INSTRUMENT CORP., 595 Frelinghuysen Ave., Newark 5, N. J. ADV. PG. 243.

CHEMICALS—*Electronic*

- Baker Chemical Co., J. T., Phillipsburg, N. J.
- Electro-Technical Products Div. of Sun Chemical Corp., 113 E. Centre St., Nutley 10, N. J.
- GENERAL CHEMICAL DIV., Allied Chemical & Dye Corp., 40 Rector St., New York 6, N. Y. ADV. PG. 84.
- Mallinckrodt Chemical Works, Second & Mallinckrodt Sts., St. Louis 7, Mo.

CHEMICALS—*Luminescent*

- Canadian Radium & Uranium Corp., 630 Fifth Ave., New York 20, N. Y.
- du Pont de Nemours & Co., Inc., E. I., Wilmington, Del.
- General Cement Mfg. Co., 919 Taylor Ave., Rockford, Ill.
- Mallinckrodt Chemical Works, Second & Mallinckrodt Sts., St. Louis 7, Mo.
- Mercck & Co., Inc., Rahway, N. J.
- Shannon Luminous Materials Co., 7356 Santa Monica Blvd., Hollywood 46, Calif.
- SYLVANIA ELECTRIC PRODUCTS, INC., 1740 Broadway, New York 19, N. Y. ADV. PG. 432-436.

NOTE:

Throughout all choke listings:
(h) indicates hermetically sealed types

CHOKES—*Audio*

- ACME ELECTRONICS, INC., 300 N. Lake Ave., Pasadena 4, Calif. ADV. PG. 182. (h)
- Acro Products Co., 215 Arch St., Philadelphia 6, Pa. (h)
- Acro Transformer Mfg. Corp., 26-02 4th St., Astoria 2, N. Y. (h)
- AIRDESIGN, INC., 241 Fairfield Ave., Upper Darby, Pa. ADV. PG. 368.
- AIRPAX PRODUCTS CO., Middle River, Baltimore 20, Md. ADV. PG. 289.
- Altec Lansing Corp., 9356 Santa Monica Blvd., Beverly Hills, Calif.
- Arco Transformer & Electric Corp., 1602 S. Hanna St., Fort Wayne, Ind. (h)
- Audio Development Co., 2833 13th Ave. S., Minneapolis 7, Minn. (h)
- CHICAGO TRANSFORMER DIV., Essex Wire Corp., 3501 W. Addison St., Chicago 18, Ill. ADV. PG. 205.
- Crest Transformer Corp., 1834-36 W. North Ave., Chicago 22, Ill. (h)
- Davis & Co., Inc., Dean W., 3418 N. Milwaukee Ave., Chicago, Ill. (h)
- Deutschmann Corp., Tobe, 921 Providence Highway, Norwood, Mass.
- Dormitzer Electric Co., Inc., 89 Brighton Ave., Boston 34, Mass.
- Edwards Co., Inc., 86 Boston Post Rd., Norwalk, Conn. Electron Mfg. Co., 1901 N. Clybourn, Chicago, Ill. (h)
- Electrical Windings, Inc., 2015 N. Kolmar Ave., Chicago 39, Ill. (h)
- Electronic Products Div., Epco Products, Inc., 2430 Atlantic Ave., Brooklyn 33, N. Y.
- ELECTRONIC TRANSFORMER CO., INC., 215 W. 25th St., New York, N. Y. ADV. PG. 278. (h)
- Engineering Lab., Inc., 602 E. 4th St., Tulsa 3, Okla.
- FERRANTI ELECTRIC, INC., 30 Rockefeller Plaza, New York 20, N. Y. ADV. PG. 159. (h)
- FREED TRANSFORMER CO., INC., 1736 Weirfield St., Brooklyn 27, N. Y. ADV. PG. 149.
- GENERAL ELECTRIC CO., Schenectady 5, N. Y. ADV. PG. 1 to 22. (h)
- General Transformer Corp., 18240 Harwood Ave., Home-wood, Ill. (h)
- Goslin Electric & Mfg. Co., 2921 W. Olive St., Burbank, Calif. (h)
- Guthman Inc., Edwin I., 15 Throop St., Chicago, Ill.
- HIGHLAND ENGINEERING CO., Main St. & Urban Ave., Westbury, N. Y. ADV. PG. 360. (h)
- Hycor Co., Inc., 11423 Vanowen St., North Hollywood, Calif. (h)
- Inductive Equipment Co., Gettysburg, Pa.
- Jefferson Electric Co., Bellwood, Ill.
- KENYON TRANSFORMER CO., INC., 840 Barry St., New York 59, N. Y. ADV. PG. 325. (h)
- LANGEVIN MANUFACTURING CORP., 37 W. 65th St., New York 23, N. Y. ADV. PG. 348. (h)
- Leonard Electric Products Co., Inc., 1562 61st St., Brooklyn 19, N. Y. (h)
- Magnatran Incorporated, Kearney, N. J.
- Magnetic Windings Div., Essex Wire Corp., Freemans-burg Ave. at Hobson Blvd., Easton, Pa. (h)
- MEASUREMENTS CORP., Boonton, N. J. ADV. PG. 99.
- MID-WEST COIL & TRANSFORMER CO., 1642 N. Halsted St., Chicago 14, Ill. ADV. PG. 165. (h)

- NATIONAL CO., INC., 61 Sherman St., Malden 48, Mass. ADV. PG. 280, 281.
- NEW YORK TRANSFORMER CO., INC., Third Ave., Alpha, N. J. ADV. PG. 288. (h)
- PARMEKO LTD., 366 Madison Ave., New York 17, N. Y. ADV. PG. 336. (h)
- Peerless Electrical Products Co., Div. of Altec-Lansing Corp., 6920 McKinley Ave., Los Angeles, Calif.
- PERMOFLUX CORP., 4900 W. Grand Ave., Chicago 33, Ill. ADV. PG. 321.
- Presto Electric Co., Inc., 4513 New York Ave., Union City, N. J. (h)
- Radionic Transformer Co., 411 S. Sangamon St., Chi-cago 7, Ill.
- Red Arrow Electric Corp., 100 Coit St., Irvington 11, N. J. (h)
- Rola Co., Inc., The, 2530 Superior Ave., Cleveland 14, Ohio. (h)
- Rollan Electrical Co., 8020 S. South Park, Chicago, Ill.
- S. N. C. Mfg. Co., Inc., Box 277, Oshkosh, Wis. (h)
- Southwestern Industrial Electronics Co., 2831 Post Oak Rd., P. O. Box 13058, Houston 19, Texas. (h)
- Standard Telephones & Cables Ltd., Connaught House, Aldwych, London, W. C. 2, England.
- STANDARD TRANSFORMER CORP., Elston, Kedzie & Addison, Chicago 18, Ill. ADV. PG. 144.
- Super Electric Products Corp., 46 Oliver St., Newark, N. J.
- Tartak-Stolle Electronics, Inc., 3970 S. Grand Ave., Los Angeles 37, Calif. (h)
- Tetrad Co., 4921 Exposition Blvd., Los Angeles 16, Calif. (h)
- Thermador Electric Mfg. Co., 5119 District Blvd., Los Angeles 22, Calif. (h)
- Thordarson-Meissner Mfg. Divs., 500 W. Huron St., Chicago 10, Ill. (h)
- Triad Transformer Mfg. Co., 2254 Sepulveda Blvd., Los Angeles 64, Calif. (h)
- UNITED TRANSFORMER CO., 150 Varlick St., New York 13, N. Y. ADV. PG. Inside Front Cover. (h)
- Vokar Corp., 7300 Huron River Drive, Dexter, Mich. (h)

CHOKES—*Filter*

- ACME ELECTRIC CORP., 31 Water St., Cuba, N. Y. ADV. PG. 90.
- ACME ELECTRONICS, INC., 300 N. Lake Ave., Pasade-na 4, Calif. ADV. PG. 182. (h)
- Acro Products Co., 215 Arch St., Philadelphia 6, Pa. (h)
- Acro Transformer Mfg. Corp., 26-02 4th St., Astoria 2, N. Y. (h)
- AIRDESIGN, INC., 241 Fairfield Ave., Upper Darby, Pa. ADV. PG. 368.
- AIRPAX PRODUCTS CO., Middle River, Baltimore 20, Md. ADV. PG. 289.
- Altec Lansing Corp., 9356 Santa Monica Blvd., Beverly Hills, Calif. (h)
- Arco Transformer & Electric Corp., 1601 S. Hanna St., Fort Wayne, Ind. (h)
- Audio Development Co., 2833 13th Ave. S., Minne-apolis 7, Minn. (h)
- CHICAGO TRANSFORMER DIV., Essex Wire Corp., 3501 W. Addison St., Chicago 18, Ill. ADV. PG. 205. (h)
- Coil Winders, Inc., 61 Bergen St., Brooklyn 2, N. Y.
- Continental Electric Co., Inc., 334 Ferry St., Newark 5, N. J.
- Crest Transformer Corp., 1834-36 W. North Ave., Chicago 22, Ill.
- Davis & Co., Inc., Dean W., 3418 N. Milwaukee Ave., Chicago, Ill. (h)
- Dormitzer Electric Co., Inc., 89 Brighton Ave., Boston 34, Mass.
- Edwards Co., Inc., 86 Boston Post Rd., Norwalk, Conn. Electron Mfg. Co., 1901 N. Clybourn, Chicago, Ill. (h)
- Electrical Windings, Inc., 2015 N. Kolmar Ave., Chicago 39, Ill. (h)
- Electricoil Transformer Co., Westerly Rd., Ossining, N. Y.
- Electro Engineering Works, 6021 College Ave., Oakland 18, Calif. (h)
- ELECTRONIC TRANSFORMER CO., INC., 215 W. 25th St., New York, N. Y. ADV. PG. 278. (h)
- Electronic Products Div., Epco Products, Inc., 2430 Atlantic Ave., Brooklyn 33, N. Y.
- Essex Electronics, Berkeley Heights, N. J.
- FERRANTI ELECTRIC, INC., 30 Rockefeller Plaza, New York 20, N. Y. ADV. PG. 159. (h)
- Filttron Co., Inc., 131-05 Fowler Ave., Flushing, N. Y.
- FREED TRANSFORMER CO., INC., 1736 Weirfield St., Brooklyn 27, N. Y. ADV. PG. 149. (h)
- GENERAL ELECTRIC CO., Schenectady 5, N. Y. ADV. PG. 1 to 22. (h)
- General Transformer Co., 18240 Harwood Ave., Home-wood, Ill. (h)
- Goslin Electric & Mfg. Co., 2921 W. Olive St., Bur-bank, Calif. (h)
- Guthman Inc., Edwin I., 15 Throop St., Chicago, Ill.
- HIGHLAND ENGINEERING CO., Main St. & Urban Ave., Westbury, N. Y. ADV. PG. 360. (h)
- Inductive Equipment Co., Gettysburg, Pa.
- Jefferson Electric Co., Bellwood, Ill.
- KENYON TRANSFORMER CO., INC., 840 Barry St., New York 59, N. Y. ADV. PG. 325. (h)
- LANGEVIN MANUFACTURING CORP., 37 W. 65th St., New York 23, N. Y. ADV. PG. 348. (h)

- Leonard Electric Products Co., Inc., 1562 61st St., Brooklyn 19, N. Y. (h)
- Magnatran Incorporated, Kearney, N. J.
- Mallory & Co., Inc., P. R., 3029 E. Washington St., Indianapolis 6, Ind.
- MEASUREMENTS CORP., Boonton, N. J. ADV. PG. 99.
- Melpar, Inc., 552 Swann Ave., Alexandria, Va.
- Merit Transformer Corp., 4427 N. Clark St., Chicago 40, Ill.
- MID-WEST COIL & TRANSFORMER CO., 1642 N. Halsted St., Chicago 14, Ill. ADV. PG. 165. (h)
- NATIONAL CO., INC., 61 Sherman St., Malden 48, Mass. ADV. PG. 280, 281.
- NEW YORK TRANSFORMER CO., INC., Third Ave., Alpha, N. J. ADV. PG. 288. (h)
- Nothelr Winding Labs., 9 Albemarle Ave., Trenton 3, N. J.
- OPAD-GREEN CO., 71-5 Warren St., New York 7, N. Y. ADV. PG. 314.
- PARMEKO LTD., 366 Madison Ave., New York 17, N. Y. ADV. PG. 336. (h)
- Peerless Electrical Products Co., Div. of Altec-Lansing Corp., 6920 McKinley Ave., Los Angeles 1, Calif.
- PERMOFLUX CORP., 4900 W. Grand Ave., Chicago 33, Ill. ADV. PG. 321.
- Philco Corp., Tioga & C Sts., Philadelphia 34, Pa.
- Presto Electric Co., Inc., 4513 New York Ave., Union City, N. J.
- Radionic Transformer Co., 411 S. Sangamon St., Chi-cago 7, Ill.
- Red Arrow Electric Corp., 100 Coit St., Irvington 11, N. J. (h)
- Rola Co., Inc., The, 2530 Superior Ave., Cleveland 14, Ohio. (h)
- Rollan Electrical Co., 8020 S. South Park, Chicago, Ill.
- S. N. C. Mfg. Co., Inc., Box 277, Oshkosh, Wis. (h)
- Standard Telephones & Cables Ltd., Connaught House, Aldwych, London, W. C. 2, England.
- STANDARD TRANSFORMER CORP., Elston, Kedzie & Addison, Chicago 18, Ill. ADV. PG. 144.
- Standard Winding Corp., 44-62 Johnes St., New-burgh, N. Y.
- Super Electric Products Corp., 46 Oliver St., Newark, N. J.
- Tartak-Stolle Electronics, Inc., 3970 S. Grand Ave., Los Angeles 37, Calif. (h)
- Tetrad Co., 4921 Exposition Blvd., Los Angeles 16, Calif. (h)
- Thermador Electric Mfg. Co., 5119 District Blvd., Los Angeles 22, Calif. (h)
- Thordarson-Meissner Mfg. Divs., 500 W. Huron St., Chicago 10, Ill. (h)
- Triad Transformer Mfg. Co., 2254 Sepulveda Blvd., Los Angeles 64, Calif. (h)
- U. S. ELECTRONICS CORP., 276 Warren Lyndhurst, N. J. ADV. PG. 76.
- UNITED TRANSFORMER CO., 150 Varlick St., New York 13, N. Y. Inside Front Cover. (h)
- Vokar Corp., 7300 Huron River Drive, Dexter, Mich. (h)
- WESTINGHOUSE ELECTRIC CORP., 511 Wood St., P. O. Box 868, Pittsburgh 30, Pa. ADV. PG. 107-113.

CHOKES—*Power*

- Acro Products Co., 215 Arch St., Philadelphia 6, Pa. (h)
- Acro Transformer Mfg. Corp., 26-02 4th St., Astoria 2, N. Y. (h)
- AIRDESIGN, INC., 241 Fairfield Ave., Upper Darby, Pa. ADV. PG. 368.
- AIRPAX PRODUCTS CO., Middle River, Baltimore 20, Md. ADV. PG. 289.
- Altec Lansing Corp., 9356 Santa Monica Blvd., Beverly Hills, Calif. (h)
- Arco Transformer & Electric Corp., 1602 S. Hanna St., Fort Wayne, Ind. (h)
- Audio Development Co., 2833 13th Ave. S., Minne-apolis 7, Minn. (h)
- CHICAGO TRANSFORMER DIV., Essex Wire Corp., 3501 W. Addison St., Chicago 18, Ill. ADV. PG. 205.
- Crest Transformer Corp., 1834-26 W. North Ave., Chicago 22, Ill.
- Davis & Co., Inc., Dean W., 3418 N. Milwaukee Ave., Chicago, Ill. (h)
- Dormitzer Electric Co., Inc., 89 Brighton Ave., Boston 34, Mass.
- Edwards Co., Inc., 86 Boston Post Rd., Norwalk, Conn.
- Electran Mfg. Co., 1901 N. Clybourn, Chicago, Ill. (h)
- Electrical Windings, Inc., 2015 N. Kolmar Ave., Chicago 39, Ill. (h)
- Electricoil Transformer Co., Westerly Rd., Ossining, N. Y.
- Electronic Products Div., Epco Products, Inc., 2430 Atlantic Ave., Brooklyn 33, N. Y.
- ELECTRONIC TRANSFORMER CO., INC., 215 W. 25th St., New York, N. Y. ADV. PG. 278. (h)
- Etraco Mfg. Co., Inc., Woods Church Rd., Flemington, N. J.
- FERRANTI ELECTRIC, INC., 30 Rockefeller Plaza, New York 20, N. Y. ADV. PG. 159. (h)
- FREED TRANSFORMER CO., INC., 1736 Weirfield St., Brooklyn 27, N. Y. ADV. PG. 149. (h)
- Gardner Electric Mfg. Co., 4227 Hollis St., Emeryville 8, Calif.
- GENERAL ELECTRIC CO., Schenectady 5, N. Y. ADV. PG. 1 to 22.

V indicates . . . IN PRODUCTION • AVAILABILITY • UNRESTRICTED FOR GENERAL USE

- Ⓞ General Transformer Co., 18240 Harwood Ave., Home-wood, Ill. (h)
- Ⓞ Goslin Electric & Mfg. Co., 2921 W. Olive St., Burbank, Calif. (h)
- Ⓞ HIGHLAND ENGINEERING CO., Main St. & Urban Ave., Westbury, N. Y. ADV. PG. 360.
- Ⓞ Industrial Equipment Co., Gettysburg, Pa.
- Ⓞ KENYON TRANSFORMER CO., INC., 840 Barry St., New York 59, N. Y. ADV. PG. 325. (h)
- Ⓞ LANGEVIN MANUFACTURING CORP., 37 W. 65th St., New York, N. Y. ADV. PG. 348.
- Ⓞ Lectrohm, Inc., 5939 Archer Ave., Chicago 38, Ill. Leonard Electric Products Co., Inc., 1562 61st St., Brooklyn 19, N. Y. (h)
- Ⓞ Light Electric Corp., 214 Lackawanna Ave., Newark 4, N. J.
- Ⓞ Magnatran Incorporated, Kearney, N. J.
- Ⓞ MEASUREMENTS CORP., Boonton, N. J. ADV. PG. 99.
- Ⓞ MID-WEST COIL & TRANSFORMER CO., 1642 N. Halsted St., Chicago 14, Ill. ADV. PG. 165. (h)
- Ⓞ NATIONAL CO., INC., 61 Sherman St., Malden 48, Mass. ADV. PG. 280, 281.
- Ⓞ NEW YORK TRANSFORMER CORP., Third Ave., Alpha, N. J. ADV. PG. 288. (h)
- Ⓞ Nothelfer Winding Labs., 9 Albermarle Ave., Trenton 3, N. J.
- Ⓞ OHMITE MFG. CO., 4835 W. Flournoy St., Chicago 44, Ill. ADV. PG. 41.
- Ⓞ PARMEKO LTD., 366 Madison Ave., New York 17, N. Y. ADV. PG. 336. (h)
- Ⓞ Peerless Electrical Products Co., Div. of Altec-Lansing Corp., 6920 McKinley Ave., Los Angeles 1, Calif.
- Ⓞ Presto Electric Co., Inc., 4513 New York Ave., Union City, N. J. (h)
- Ⓞ Radionic Transformer Co., 411 S. Sangamon St., Chicago 7, Ill.
- Ⓞ Red Arrow Electric Corp., 100 Coit St., Irvington 11, N. J. (h)
- Ⓞ S. N. C. Mfg. Co., Inc., Box 277, Oshkosh, Wis. (h)
- Ⓞ SORENSEN & CO., INC., 375 Fairfield Ave., Stamford, Conn. ADV. PG. 66, 67. (h)
- Ⓞ Standard Telephones & Cables Ltd., Connaught House, Aldwych, London, W. C. 2, England.
- Ⓞ STANDARD TRANSFORMER CORP., Elston, Kedzie, & Addison, Chicago 18, Ill. ADV. PG. 144.
- Ⓞ Standard Winding Corp., 44-62 Johnes St., Newburgh, N. Y.
- Ⓞ Super Electric Products Corp., 46 Oliver St., Newark, N. J.
- Ⓞ Tartak-Stolle Electronics, Inc., 3970 S. Grand Ave., Los Angeles 37, Calif. (h)
- Ⓞ Tetrad Co., 4921 Exposition Blvd., Los Angeles 16, Calif. (h)
- Ⓞ Thermador Electric Mfg. Co., 5119 District Blvd., Los Angeles 22, Calif. (h)
- Ⓞ Thordarson-Meissner Mfg. Divs., 500 W. Huron St., Chicago 10, Ill. (h)
- Ⓞ Triad Transformer Mfg. Co., 2254 Sepulveda Blvd., Los Angeles 64, Calif. (h)
- Ⓞ U. S. ELECTRONICS CORP., 276 Warren St., Lyndhurst, N. J. ADV. PG. 76. (h)
- Ⓞ UNITED TRANSFORMER CO., 150 Varick St., New York 13, N. Y. ADV. PG. Inside Front Cover. (h)
- Ⓞ WESTINGHOUSE ELECTRIC CORP., 511 Wood St., P. O. Box 868, Pittsburgh 30, Pa. ADV. PG. 107-113.

CHOKES—r-f (Heavywire Low Voltage)

- Ⓞ Aero Coil Inc., 507-26th St., Union City, N. J. (h)
- Ⓞ AIRPAX PRODUCTS CO., Middle River, Baltimore 20, Md. ADV. PG. 289.
- Ⓞ Altec Lansing Corp., 9356 Santa Monica Blvd., Beverly Hills, Calif.
- Ⓞ BELLING & LEE LTD., 366 Madison Ave., New York 17, N. Y. ADV. PG. 336.
- Ⓞ COILCRAFT, INC., 3716 N. Cicero Ave., Chicago 41, Ill. ADV. PG. 360.
- Ⓞ Coil Winders, Inc., 61 Bergen St., Brooklyn 2, N. Y.
- Ⓞ Davis & Co., Inc., Dean W., 3418 N. Milwaukee Ave., Chicago, Ill. (h)
- Ⓞ Deuschmann Corp., Tobe, 921 Providence Highway, Norwood, Mass.
- Ⓞ Edwards Co., Inc., 86 Boston Post Rd., Norwalk, Conn.
- Ⓞ ELECTRONIC COILS, INC., Box 1641, 44 Taylor St., Springfield, Mass. ADV. PG. 400.
- Ⓞ Electronic Engineering Corp., 469 Elm St., Arlington, N. J.
- Ⓞ Essex Electronics, Berkeley Heights, N. J.
- Ⓞ FAST & CO., JOHN E., 3101 N. Pulaski Rd., Chicago 43, Ill. ADV. PG. 368.
- Ⓞ Filtron Co., Inc., 131-05 Fowler Ave., Flushing, N. Y.
- Ⓞ FUGLE-MILLER LABORATORIES, INC., 399 Main St., Metuchen, N. J. ADV. PG. 218.
- Ⓞ Gardner Electric Mfg. Co., 4227 Hollis St., Emeryville 8, Calif.
- Ⓞ Gates Radio Co., Quincy, Ill.
- Ⓞ Guthman Inc., Edwin I., 15 Throop St., Chicago, Ill.
- Ⓞ HOULIHAN CO., T. J., 2508-14 W. Lawrence Ave., Chicago 25, Ill. ADV. PG. 336.
- Ⓞ Industrial Equipment Co., Gettysburg, Pa.
- Ⓞ INTERNATIONAL RESISTANCE CO., 401 N. Broad St., Philadelphia 8, Pa. ADV. PG. 134, 135.
- Ⓞ JOHNSON CO., E. F., Waseca, Minn. ADV. PG. 118, 121.

- Ⓞ Lectrohm, Inc., 5939 Archer Ave., Chicago 38, Ill. Leonard Electric Products Co., Inc., 1562 61st St., Brooklyn 19, N. Y. (h)
- Ⓞ MEASUREMENTS CORP., Boonton, N. J. ADV. PG. 99.
- Ⓞ Millen Mfg. Co., James, 150 Exchange St., Malden, Mass.
- Ⓞ Miller Co., J. W., 5917 S. Main St., Los Angeles 3, Calif.
- Ⓞ NATIONAL CO., INC., 61 Sherman St., Malden 48, Mass. ADV. PG. 280, 281.
- Ⓞ OHMITE MFG. CO., 4835 W. Flournoy St., Chicago 44, Ill. ADV. PG. 41.
- Ⓞ Rollan Electrical Co., 8020 S. South Park, Chicago, Ill.
- Ⓞ Sickles Co., F. W., 165 Front St., Chicopee, Mass.
- Ⓞ STANDARD COIL PRODUCTS CO., 2329 N. Pulaski Rd., Chicago 39, Ill. ADV. PG. 97.
- Ⓞ Standard Winding Corp., 44-62 Johnes St., Newburgh, N. Y.
- Ⓞ Tetrad Co., 4921 Exposition Blvd., Los Angeles 16, Calif. (h)
- Ⓞ Thordarson-Meissner Mfg. Divs., 500 W. Huron St., Chicago 10, Ill. (h)
- Ⓞ UNITED TRANSFORMER CO., 150 Varick St., New York 13, N. Y. ADV. PG. Inside Front Cover.
- Ⓞ U. S. ELECTRONICS CORP., 276 Warren St., Lyndhurst, N. J. ADV. PG. 76. (h)

CHOKES—r-f & i-f

- Ⓞ ACME ELECTRONICS, INC., 300 N. Lake Ave., Pasadena 4, Calif. ADV. PG. 182.
- Ⓞ Aero Coil Inc., 507-26th St., Union City, N. J.
- Ⓞ AEROLITE ELECTRONIC HARDWARE CORP., 507 26th St., Union City, N. J. ADV. PG. 355.
- Ⓞ Atlas Coil Winders, Inc., Stamford, Conn.
- Ⓞ BARKER & WILLIAMSON, 235 Fairfield Ave., Upper Darby, Pa. ADV. PG. 292.
- Ⓞ Bud Radio, Inc., 2118 E. 55th St., Cleveland 3, Ohio.
- Ⓞ Bunnell & Co., J. H., 81 Prospect St., Brooklyn, N. Y.
- Ⓞ CADELL-BURNS MFG. CO., 40 E. Second St., Minnola, N. Y. ADV. PG. 224.
- Ⓞ CAMBRIDGE THERMIONIC CORP., 445 Concord Ave., Cambridge 38, Mass. ADV. PG. 37.
- Ⓞ Carron Mfg. Co., 415 S. Aberdeen St., Chicago, Ill.
- Ⓞ Clippard Instrument Laboratory, Inc., 1125 Bank St., Cincinnati 14, Ohio.
- Ⓞ Coil Winders Inc., 61 Bergen St., Brooklyn 2, N. Y.
- Ⓞ COILCRAFT, INC., 3716 N. Cicero Ave., Chicago 41, Ill. ADV. PG. 360.
- Ⓞ Coto-Coil Co., Inc., 65 Pavilion Ave., Providence 5, R. I.
- Ⓞ Davis & Co., Inc., Dean W., 3418 N. Milwaukee Ave., Chicago, Ill. (h)
- Ⓞ Deuschmann Corp., Tobe, 921 Providence Highway, Norwood, Mass.
- Ⓞ DIETZ DESIGN & MFG. CO., Grandview 6, Mo. ADV. PG. 323. (h)
- Ⓞ Edwards Co., Inc., 86 Boston Post Rd., Norwalk, Conn.
- Ⓞ ELECTRONIC COILS, INC., P. O. Box 1641, 44 Taylor St., Springfield, Mass. ADV. PG. 400.
- Ⓞ Essex Electronics, Berkeley Heights, N. J.
- Ⓞ FUGLE-MILLER LABORATORIES, 399 Main St., Metuchen, N. J. ADV. PG. 218. (h)
- Ⓞ Guthman Inc., Edwin I., 15 Throop St., Chicago, Ill.
- Ⓞ HARNETT ELECTRIC CORP., 138 Haven Ave., Port Washington, L. I., N. Y. ADV. PG. 399.
- Ⓞ HILLBURN ELECTRONIC PRODUCTS CO., 55 Nassau Ave., Brooklyn 22, N. Y. ADV. PG. 362.
- Ⓞ HOULIHAN CO., T. J., 2508-14 W. Lawrence Ave., Chicago, Ill. ADV. PG. 336.
- Ⓞ Industrial Equipment Co., Gettysburg, Pa.
- Ⓞ INTERNATIONAL RESISTANCE CO., 401 N. Broad St., Philadelphia 8, Pa. ADV. PG. 134, 135.
- Ⓞ JEFFERS ELECTRONICS CO., DuBois, Pa. ADV. PG. 406.
- Ⓞ JOHNSON CO., E. F., Waseca, Minn. ADV. PG. 118, 121.
- Ⓞ Leonard Electric Products Co., 1562 61st St., Brooklyn, N. Y.
- Ⓞ LEWIS SPRING & MFG. CORP., 2646 W. North Ave., Chicago 47, Ill. ADV. PG. 293.
- Ⓞ Loral Electronics Corp., 794 E. 140th St., New York 54, N. Y.
- Ⓞ MEASUREMENTS CORP., Boonton, N. J. ADV. PG. 99.
- Ⓞ Millen Mfg. Co., James, 150 Exchange St., Malden, Mass.
- Ⓞ Miller Co., J. W., 5917 S. Main St., Los Angeles 3, Calif.
- Ⓞ Muter Co., 1255 S. Michigan Ave., Chicago, Ill.
- Ⓞ NATIONAL CO., INC., 61 Sherman St., Malden 48, Mass. ADV. PG. 280, 281.
- Ⓞ OHMITE MFG. CO., 4835 W. Flournoy St., Chicago 44, Ill. ADV. PG. 41.
- Ⓞ Philco Corp., Tioga & C Sts., Philadelphia 34, Pa.
- Ⓞ Rollan Electrical Co., 8020 S. South Park, Chicago, Ill.
- Ⓞ Ross Mfg. Co., 860 Washington St., Burlington, Iowa.
- Ⓞ Sickles Co., F. W., 165 Front St., Chicopee, Mass.
- Ⓞ STANDARD COIL PRODUCTS CO., 2329 N. Pulaski Rd., Chicago 39, Ill. ADV. PG. 97.
- Ⓞ Standard Winding Corp., 44-62 Johnes St., Newburgh, N. Y.
- Ⓞ Stanwyck Winding Co., 137 Walsh Ave., Newburgh, N. Y.

- Ⓞ Super Electric Products Corp., 46 Oliver St., Newark, N. J.
- Ⓞ Teleradio Engineering Corp., 99 Wall St., New York, N. Y. (h)
- Ⓞ Tetrad Co., 4921 Exposition Blvd., Los Angeles 16, Calif. (h)
- Ⓞ Thordarson-Meissner Mfg. Divs., 500 W. Huron St., Chicago 10, Ill. (h)
- Ⓞ U. S. ELECTRONICS CORP., 276 Warren St., Lyndhurst, N. J. ADV. PG. 76. (h)
- Ⓞ Vokar Corp., 7300 Huron River Drive, Dexter, Mich. (h)

CHOPPERS—DC-AC

- Ⓞ AIRPAX PRODUCTS CO., Middle River, Baltimore 20, Md. ADV. PG. 289.
- Ⓞ Applied Science Corp. of Princeton, P. O. Box 44, Princeton, N. J.
- Ⓞ Atlas Coil Winders Inc., Stamford, Conn.
- Ⓞ INDUSTRIAL CONTROL CO., Straight Path & Arlington Ave., Wyandanch, N. Y. ADV. PG. 130.
- Ⓞ Ionic Electronic Equipment Co., 1705 N. Kenmore, Los Angeles 27, Calif.
- Ⓞ MINNEAPOLIS-HONEYWELL REGULATOR CO., INDUSTRIAL DIV., Wayne & Roberts Aves., Philadelphia 44, Pa. ADV. PG. 208, 209.
- Ⓞ SERVOMECHANISMS, INC., Whaleneck Rd. & Stewart Ave., Westbury, L. I., N. Y. ADV. PG. 188.
- Ⓞ STEVENS-ARNOLD INC., 22 Elkins St., South Boston, Mass. ADV. PG. 295.
- Ⓞ Vokar Corp., 7300 Huron River Drive, Dexter, Mich.

CHRONAXIMETERS

- Dallons Labs., 5066 Santa Monica Blvd., Los Angeles, Calif.
- Ⓞ Electro-Medical Lab., Inc., South Woodstock, Vt.

CHRONOGRAPHS—Inertialess

- Ⓞ Airlectron Inc., P. O. Box 151, Caldwell, N. J.
- Ⓞ Electro-Medical Lab. Inc., South Woodstock, Vt.
- Ⓞ Midwestern Geophysical Laboratory, 3400 S. Harvard, Tulsa, Okla.
- Ⓞ POTTER INSTRUMENT CO., INC., 115 Cutter Mill Rd., Great Neck, N. Y. ADV. PG. 318.

CHRONOSCOPES

- Ⓞ AMERICAN CHRONOSCOPE CORP., 316 W. First St., Mt. Vernon, N. Y. ADV. PG. 316.
- Ⓞ POTTER INSTRUMENT CO., INC., 115 Cutter Mill Rd., Great Neck, N. Y. ADV. PG. 318.
- Ⓞ Rawson Electrical Co., 111 Potter St., Cambridge 42, Mass.
- Ⓞ Sticht Co., Inc., Herman, 27 Park Place, New York 7, N. Y.

CIRCUITS—Printed or Stamped

- Ⓞ AMERICAN LAVA CORP., Chattanooga 5, Tenn. ADV. PG. 143.
- Ⓞ Avion Instrument Corp., Paramus, N. J.
- Ⓞ CENTRALAB DIV. OF GLOBE-UNION, INC., 900 E. Keefe Ave., Milwaukee 1, Wis. ADV. PG. 85-88.
- Ⓞ DAVEN CO., 191 Central Ave., Newark 4, N. J. ADV. PG. 157.
- Ⓞ Decimeter, Inc., 1430 Market St., Denver 2, Colo.
- Ⓞ duPont de Nemours & Co., Inc., E. I., Wilmington 98, Del.
- Ⓞ ELECTRICAL REACTANCE CORP., Seneca Ave., Olean, N. Y. ADV. PG. 56, 57.
- Ⓞ Electrochemical Industries, Inc., Jacques St., Worcester, Mass.
- Ⓞ Elm Laboratories, 18 South Broadway, Dobbs Ferry, N. Y.
- Ⓞ EMELOID CO., INC., THE, 1239 Central Ave., Hillside 5, N. J. ADV. PG. 102.
- Ⓞ ERIE RESISTOR CORP., 644 W. 12th St., Erie, Pa. ADV. PG. 91.
- Ⓞ FRANKLIN AIRLOOP CORP., 43-20 34th St., Long Island City 1, N. Y. ADV. PG. 45.
- Ⓞ FRANKLIN MFG. CORP., A. W., 43-20 34th St., Long Island City 1, N. Y. ADV. PG. 44.
- Ⓞ GENERAL CERAMICS & STEATITE CORP., Keasbey, N. J. ADV. PG. 126, 127.
- Ⓞ General Instrument Corp., 829 Newark Ave., Elizabeth 3, N. J.
- Ⓞ Herlec Corp., 422 N. 5th St., Milwaukee 3, Wis.
- Ⓞ Mallory & Co., Inc., P. R., 3029 E. Washington St., Indianapolis 6, Ind.
- Ⓞ Metaplast Process Inc., 9-17 37th Ave., Long Island City 1, N. Y.
- Ⓞ Molded Insulation Co., 335 E. Price St., Philadelphia 44, Pa.
- Ⓞ Photocircuits Corp., Glen Cove, N. Y.
- Ⓞ Plastics & Electronics Co., Inc., P. O. Box 38, Station J, Buffalo 8, N. Y.
- Ⓞ RADIO MATERIALS CORP., 1708 Belmont Ave., Chicago 13, Ill. ADV. PG. 223.
- Ⓞ Sears Co., M. J., 52 Clark St., Brooklyn 2, N. Y.
- Ⓞ Sprague Electric Co., North Adams, Mass.
- Ⓞ STANDARD COIL PRODUCTS CO., 2329 N. Pulaski Rd., Chicago 39, Ill. ADV. PG. 97.

V indicates . . . IN PRODUCTION • AVAILABILITY • UNRESTRICTED FOR GENERAL USE

- ⓈTUPAKOFF CERAMIC & MFG. CO., Latrobe, Pa. ADV. PG. 167.
- ⓈTEFLON PRODUCTS DIVISION, U. S. GASKET CO., P.O. Box 93, Camden, N. J. ADV. PG. 176.
- ⓈTelevision Laboratories, Inc., 5045 W. Lake St., Chicago 44, Ill.

CLAMPS for TUBES

- ⓈBELLING & LEE LTD., 366 Madison Ave., New York 17, N. Y. ADV. PG. 336.
- ⓈBirtcher Corp., 5087 Huntington Drive, Los Angeles 32, Calif.
- ⓈBUCK ENGINEERING CO., 37-41 Marcy St., Freehold, N. J. ADV. PG. 374.
- ⓈCINCH MFG. CORP., 1026 S. Homan Ave., Chicago 24, Ill. ADV. PG. 186, 187.
- ⓈGENERAL ACCESSORIES CO., LTD., 366 Madison Ave., New York 17, N. Y. ADV. PG. 336.
- ⓈJ F D MFG. CO., 6101-23 Sixteenth Ave., Brooklyn, N. Y. ADV. PG. 407.
- ⓈMelpar, Inc., 552 Swann Ave., Alexandria, Va.
- ⓈMillen Mfg. Co., James, 150 Exchange St., Malden, Mass.
- ⓈNATIONAL CO., INC., 61 Sherman St., Malden 48, Mass. ADV. PG. 280, 281.
- ⓈRadiation Counter Laboratories, Inc., 1844 W. 21st St., Chicago 8, Ill.
- ⓈRemler Co., Ltd., 2101 Bryant St., San Francisco 10, Calif.
- ⓈThompson Corp., George S., South Pasadena, Calif.
- ⓈTinnerman Products, Inc., P. O. Box 6688, Dept. No. 16, Cleveland 1, Ohio.

CLIPS—Grid

- ⓈAEROLITE ELECTRONIC HARDWARE CORP., 506 26th St., Union City, N. J. ADV. PG. 355.
- ⓈAIRCRAFT-MARINE PRODUCTS, INC., 2100 Paxton St., Harrisburg 10, Pa. ADV. PG. 367.
- ⓈAMERICAN PHENOLIC CORP., 1530 S. 54th Ave., Chicago 50, Ill. ADV. PG. 61.
- ⓈCINCH MFG. CORP., 1026 S. Homan Ave., Chicago 24, Ill. ADV. PG. 186, 187.
- ⓈFEDERAL SCREW PRODUCTS INC., 224 W. Huron St., Chicago 10, Ill. ADV. PG. 76.
- ⓈFRANKLIN AIRLOOP CORP., 43-20 34th St., Long Island City, N. Y. ADV. PG. 45.
- ⓈFRANKLIN MFG. CORP. A. W., 43-20 34th St., Long Island City, N. Y. ADV. PG. 44.
- ⓈGENERAL ACCESSORIES CO., LTD., 366 Madison Ave., New York 17, N. Y. ADV. PG. 336.
- ⓈGeneral Cement Mfg. Co., 919 Taylor Ave., Rockford, Ill.
- ⓈInsuline Corp. of America, 36-02 35th Ave., Long Island City, N. Y.
- ⓈJ F D MFG. CO., 6101-23 Sixteenth Ave., Brooklyn, N. Y. ADV. PG. 407.
- ⓈJOHNSON CO., E. F., Waseca, Minn. ADV. PG. 118, 121.
- ⓈKULKA ELECTRIC MFG. CO., INC., 30 South St., Mount Vernon, N. Y. ADV. PG. 317.
- ⓈMillen Mfg. Co., James, 150 Exchange St., Malden, Mass.
- ⓈNATIONAL CO., INC., 61 Sherman St., Malden 48, Mass. ADV. PG. 280, 281.
- ⓈPIX MFG. CO., INC., 24 Bedford St., Newark, N. J. ADV. PG. 136.
- ⓈSchott Co., Walter L., 3225 Exposition Pl., Los Angeles 18, Calif.
- ⓈWEBSTER SPRING CO., 176-182 Johnson St., Brooklyn 1, N. Y. ADV. PG. 394.
- ⓈZierick Mfg. Corp., Beechwood & Rockdale Aves., New Rochelle, N. Y.

CLIPS & CLAMPS—Test & Tube

- ⓈAEROLITE ELECTRONIC HARDWARE CORP., 506 26th St., Union City, N. J. ADV. PG. 355.
- ⓈBELLING & LEE LTD., 366 Madison Ave., New York 17, N. Y. ADV. PG. 336.
- ⓈBUCK ENGINEERING CO., 37-41 Marcy St., Freehold, N. J. ADV. PG. 374.
- ⓈGENERAL ACCESSORIES CO., LTD., 366 Madison Ave., New York 17, N. Y. ADV. PG. 336.
- ⓈGeneral Cement Mfg. Co., 919 Taylor Ave., Rockford, Ill.
- ⓈGRAYHILL, 4524 W. Madison St., Chicago 24, Ill. ADV. PG. 380.
- ⓈInsuline Corp. of America, 36-02 35th Ave., Long Island City, N. Y.
- ⓈJ F D MFG. CO., 6101-23 Sixteenth Ave., Brooklyn, N. Y. ADV. PG. 407.
- ⓈKoltan Electric Mfg. Co., 123 New Jersey Railroad Ave., Newark 5, N. J.
- ⓈMueller Electric Co., 1583 E. 31st St., Cleveland 14, Ohio.
- ⓈPenn-Union Electric Corp., 315 State Street, Erie, Pa.
- ⓈPIX MFG. CO., INC., 24 Bedford St., Newark, N. J. ADV. PG. 136.
- ⓈRapid Specialties Co., 325 W. Huron St., Chicago 10, Ill.
- ⓈThompson Corp., George S., South Pasadena, Calif.
- ⓈTIMES FACISMILE CORP., 540 W. 58th St., New York 19, N. Y. ADV. PG. 288.
- ⓈUnited Technical Labs., Box 425-W, Morristown, N. J.

CLOTHS—Speaker Grille

- ⓈBestcraft Products, 626 Broadway, New York, N. Y.
- ⓈFLOCK PROCESS CO., INC., 28 Fahey St., Springdale, Conn. ADV. PG. 196.
- ⓈGeneral Cement Mfg. Co., 919 Taylor Ave., Rockford, Ill.
- ⓈJ F D MFG. CO., 6101-23 Sixteenth Ave., Brooklyn, N. Y. ADV. PG. 407.
- ⓈSchott Co., Walter L., 3225 Exposition Pl., Los Angeles 18, Calif.

CLOTHS—Woven Wire

- ⓈBestcraft Products, 626 Broadway, New York, N. Y.
- ⓈChase Brass & Copper Co., Inc., 236 Grand St., Waterbury 20, Conn.
- ⓈFLOCK PROCESS CO., INC., 28 Fahey St., Springdale, Conn. ADV. PG. 196.
- ⓈGeneral Cement Mfg. Co., 919 Taylor Ave., Rockford, Ill.
- ⓈMULTI METAL CO., 1350 Garrison Ave., New York 59, N. Y. ADV. PG. 221.
- ⓈRoebling's Sons Co., John A., 640 Broad St., Trenton 2, N. J.
- ⓈSchott Co., Walter L., 3225 Exposition Pl., Los Angeles 18, Calif.

COATINGS—Conductive

See Also, Graphite, Colloidal

- ⓈAcheson Colloids Corp., Port Huron, Mich.
- ⓈAMERICAN PHENOLIC CORP., 1830 S. 54th Ave., Chicago 54, Ill. ADV. PG. 61.
- ⓈDixon Crucible Co., Joseph, Jersey City 3, N. J.
- ⓈDu Pont de Nemours & Co., Inc., E. I., Wilmington 98, Del.
- ⓈElectro Chemical Engineering Co., 750 Broad St., Emmaus, Pa.
- ⓈGeneral Cement Mfg. Co., 919 Taylor Ave., Rockford, Ill.
- ⓈHague & Co., Alfred, 227 34th St., Brooklyn 32, N. Y.
- ⓈMetaplast Process Inc., 9-17 37th Ave., Long Island City 1, N. Y.
- ⓈMICRO-CIRCUITS CO., New Buffalo, Mich. ADV. PG. 50.
- ⓈPfanstiehl Chemical Co., 104 Lake View Ave., Waukegan, Ill.
- ⓈSauereisen Cements Co., Sauereisen Bldg., Pittsburgh 15, Pa.
- ⓈSears Co., M. J., 52 Clark St., Brooklyn 2, N. Y.
- ⓈShort Wave Plastic Forming Co., 2921 Alameda St., Burbank, Calif.
- ⓈWoodwelding, Inc., 3000 W. Olive Ave., Burbank, Calif.

COATINGS-CONDUCTIVE—Tube Interior

- ⓈAcheson Colloids Corp., Port Huron, Mich.
- ⓈDixon Crucible Co., Joseph, Jersey City 3, N. J.
- ⓈHague & Co., Alfred, 227 34th St., Brooklyn 32, N. Y.
- ⓈMetaplast Process Inc., 9-17 37th Ave., Long Island City 1, N. Y.
- ⓈOptical Film Engineering Co., 2125 Cherry St., Philadelphia 3, Pa.

COATINGS—Protective

- ⓈArco Co., 7301 Bessemer Ave., Cleveland 27, Ohio.
- ⓈBarrett Varnish Co., 1532 S. 50th Court, Cicero 50, Ill.
- ⓈBrooklyn Varnish Mfg. Co., 50 Jay St., Brooklyn, N. Y.
- ⓈCIBA CO., INC., 627 Greenwich St., New York 14, N. Y. ADV. PG. 276.
- ⓈCommunication Products Co., Inc., Marlboro, N. J.
- ⓈDixon Crucible Co., Joseph, Jersey City 3, N. J.
- ⓈDow Chemical Co., Midland, Mich.
- ⓈDu Pont de Nemours & Co., Inc., E. I., Wilmington 98, Del.
- ⓈEgyptian Lacquer Mfg. Co., Lafayette, Ind.
- ⓈElectro Chemical Engineering Co., 750 Broad St., Emmaus, Pa.
- ⓈGeneral Cement Mfg. Co., 919 Taylor Ave., Rockford, Ill.
- ⓈHague & Co., Alfred, 227 34th St., Brooklyn 32, N. Y.
- ⓈHalowax Products Division, Union Carbide & Carbon Corp., 30 E. 42nd St., New York 17, N. Y.
- ⓈHamilton Kent Mfg. Co., Kent, Ohio.
- ⓈHoughton Laboratories, Inc., 322 Bush St., Olean, N. Y.
- ⓈINSL-X CO., INC., Water St., Ossining, N. Y. ADV. PG. 386.
- ⓈIRVINGTON VARNISH & INSULATOR CO., 6 Argyle Terrace, Irvington 13, N. J. ADV. PG. 92, 93.
- ⓈLukens Steel Co. and Divisions, By-Products Steel Co. and Lukensweld, 447 Lukens Building, Coatesville, Pa.
- ⓈMaas & Waldstein Co., 438 River Ave., Newark 4, N. J.
- ⓈMarblette Corp., 37-21 30th St., Long Island City, N. Y.
- ⓈMelpar, Inc., 552 Swann Ave., Alexandria, Va.
- ⓈMICRO-CIRCUITS CO., New Buffalo, Mich. ADV. PG. 50.
- ⓈMinnesota Mining & Mfg. Co., 900 Fauquier Ave., St. Paul 6, Minn.

- ⓈNew Jersey Wood Finishing Co., Amboy Ave., Woodbridge, N. J.
- ⓈNukem Products Corp., 111 Colgate Ave., Buffalo 20, N. Y.
- ⓈPanco Mirrors, Inc., 2958 Los Feliz Blvd., Los Angeles 39, Calif.
- ⓈProduction Engineering Co., 173 Sargeant Ave., Clifton, N. J.
- ⓈSauereisen Cements Co., Sauereisen Bldg., Pittsburgh 15, Pa.
- ⓈSchenectady Varnish Co., Schenectady, N. Y.
- ⓈStevenson Bro. & Co., 110 Race St., Philadelphia 6, Pa.
- ⓈTEFLON PRODUCTS DIVISION, U. S. GASKET CO., P.O. Box 93, Camden, N. J. ADV. PG. 176.
- ⓈUnion Bay State Chemical Co., Cambridge, Mass.
- ⓈU. S. Rubber Co., 1230 Avenue of the Americas, New York 20, N. Y.
- ⓈWESTINGHOUSE ELECTRIC CORP., 511 Wood St., P.O. Box 868, Pittsburgh 30, Pa. ADV. PG. 107-113.
- ⓈZOPHAR MILLS, INC., 112-130 26th St., Brooklyn 32, N. Y. ADV. PG. 397.

COATINGS—Salt Spray Resistance

- ⓈAcheson Colloids Corp., Port Huron, Mich.
- ⓈAcme Wire Co., New Haven 14, Conn.
- ⓈArco Co., 7301 Bessemer Ave., Cleveland 27, Ohio.
- ⓈBrooklyn Varnish Mfg. Co., 50 Jay St., Brooklyn, N. Y.
- ⓈCommunication Products Co., Inc., Marlboro, N. J.
- ⓈDu Pont de Nemours & Co., Inc., E. I., Wilmington 98, Del.
- ⓈEgyptian Lacquer Mfg. Co., Lafayette, Ind.
- ⓈElectro Chemical Engineering Co., 750 Broad St., Emmaus, Pa.
- ⓈHague & Co., Alfred, 227 34th St., Brooklyn 32, N. Y.
- ⓈHamilton Kent Mfg. Co., Kent, Ohio.
- ⓈHoughton Laboratories, Inc., 322 Bush St., Olean, N. Y.
- ⓈINSL-X CO., INC., Water St., Ossining, N. Y. ADV. PG. 386.
- ⓈIRVINGTON VARNISH & INSULATOR CO., 6 Argyle Terrace, Irvington 13, N. J. ADV. PG. 92, 93.
- ⓈMaas & Waldstein Co., 438 River Ave., Newark 4, N. J.
- ⓈMarblette Corp., 37-21 30th St., Long Island City, N. Y.
- ⓈMelpar, Inc., 552 Swann Ave., Alexandria, Va.
- ⓈMICRO-CIRCUITS CO., New Buffalo, Mich. ADV. PG. 50.
- ⓈMinnesota Mining Mfg. Co., 900 Fauquier Ave., St. Paul 6, Minn.
- ⓈNukem Products Corp., 111 Colgate Ave., Buffalo 20, N. Y.
- ⓈPanco Mirrors, Inc., 2958 Los Feliz Blvd., Los Angeles 39, Calif.
- ⓈSauereisen Cements Co., Sauereisen Bldg., Pittsburgh 15, Pa.
- ⓈSchenectady Varnish Co., Schenectady, N. Y.
- ⓈSpecial Chemicals Corp., 30 Irving Pl., New York, N. Y.
- ⓈTEFLON PRODUCTS DIVISION, U. S. GASKET CO., P. O. Box 93, Camden, N. J. ADV. PG. 176.
- ⓈWESTINGHOUSE ELECTRIC CORP., 511 Wood St., P. O. Box 868, Pittsburgh 30, Pa. ADV. PG. 107-113.
- ⓈZOPHAR MILLS, INC., 112-130 26th St., Brooklyn 32, N. Y. ADV. PG. 397.

CODE & TAB MARKERS

- ⓈBrady Co., W. H., 1612 E. Spring St., Chippewa Falls, Wis.
- ⓈBRAND & CO., INC., Wm., North & Valley Sts., Willimantic, Conn. ADV. PG. 248, 249.
- ⓈTopflight Tape Co., 116 E. Market St., York, Pa.
- ⓈWestern Lithograph Co., E-Z Code Div., 600 E. Second St., Los Angeles 54, Calif.

COIL ASSEMBLIES

- ⓈA.P.W. Co., 72 W. Main St., Rockaway, N. J.
- ⓈACME ELECTRICS, INC., 300 N. Lake Ave., Pasadena 4, Calif. ADV. PG. 182.
- ⓈAero Coil Inc., 507-26th St., Union City, N. J.
- ⓈAEROLITE ELECTRONIC HARDWARE CORP., 507 26th St., Union City, N. J. ADV. PG. 355.
- ⓈALDEN PRODUCTS CO., 117 N. Main St., Brockton 64, Mass. ADV. PG. 327.
- ⓈALLIED CONTROL CO., INC., 2 East End Ave., New York 21, N. Y. ADV. PG. 62, 63.
- ⓈAmerican Relay & Controls Inc., 4901 W. Flournoy St., Chicago 44, Ill.
- ⓈAtlas Coil Winders, Inc., Stamford, Conn.
- ⓈAurex Corp., Chicago 10, Ill.
- ⓈBARKER & WILLIAMSON, 235 Fairfield Ave., Upper Darby, Pa. ADV. PG. 292.
- ⓈBassett, Inc., Rex, 307-11 N.W. First Ave., Fort Lauderdale, Fla.
- ⓈBest Mfg. Co., 1200 Grove St., Irvington 11, N. J.
- ⓈBOGUE ELECTRIC MFG. CO., 52 Iowa Ave., Paterson 3, N. J. ADV. PG. 155.
- ⓈBOND ELECTRONICS CORP., 88 Franklin Place, Summit, N. J. ADV. PG. 403.

V indicates . . . IN PRODUCTION • AVAILABILITY • UNRESTRICTED FOR GENERAL USE

- Bud Radio, Inc., 2118 E. 55th St., Cleveland 3, Ohio.
- CADDELL-BURNS MFG. CO., 40 E. Second St., Mineola, N. Y. ADV. PG. 224.
- CAMBRIDGE THERMIONIC CORP., 445 Concord Ave., Cambridge 38, Mass. ADV. PG. 37.
- Carter Parts Co., 213 Institute Place, Chicago 10, Ill.
- Clippard Instrument Laboratory, Inc., 1125 Bank St., Cincinnati 14, Ohio.
- Coil Winders Inc., 61 Bergen St., Brooklyn 2, N. Y.
- COILCRAFT, INC., 3716 N. Cicero Ave., Chicago 41, Ill., ADV. PG. 360.
- COMAR ELECTRIC CO., 3349 W. Addison St., Chicago 18, Ill. ADV. PG. 335.
- Connecticut Telephone & Electric Corp., 70 Britannia St., Meriden, Conn.
- DX Radio Products Co., Inc., 2304 Armitage Ave., Chicago 47, Ill.
- DANO ELECTRIC CO., Main St., Winsted, Conn. ADV. PG. 266.
- Davis & Co., Dean W., 3418 N. Milwaukee Ave., Chicago, Ill.
- Delco Radio Div., General Motors Corp., Kokomo, Ind.
- Douglas-Randall, Inc., 102 High St., Westerly, R. I.
- Eastern Specialty Co., Philadelphia 40, Pa.
- Ecco High Frequency Corp., 7020 Hudson Blvd., North Bergen, N. J.
- Edwards Co., Inc., 86 Boston Post Rd., Norwalk, Conn.
- Electran Mfg. Co., 1901 N. Clybourn, Chicago, Ill.
- Electrical Windings, Inc., 2015 N. Kolmar Ave., Chicago 39, Ill.
- ELECTRONIC COILS, INC., P. O. Box 1641, 44 Taylor St., Springfield, Mass. ADV. PG. 400.
- Electronic Indicator Corp., 259 Green St., Brooklyn 22, N. Y.
- Electronic Products Div., Epco Products, Inc., 2430 Atlantic Ave., Brooklyn 22, N. Y.
- ELECTRONIC TRANSFORMER CO., INC., 215 W. 25th St., New York, N. Y. ADV. PG. 278.
- Ensign Coil Co., 2516 S. Pulaski Rd., Chicago, Ill.
- Essex Electronics, Berkeley Heights, N. J.
- Etraco Mfg. Co., Inc., Woods Church Rd., Flemington, N. J.
- FERRANTI ELECTRIC, INC., 30 Rockefeller Plaza, New York 20, N. Y. ADV. PG. 159.
- FUGLE-MILLER LABORATORIES, 398 Main St., Metuchen, N. J. ADV. PG. 218.
- Gaveco Labs., Inc., 2 East End Ave., New York 21, N. Y.
- General Transformer Co., 18240 Harwood Ave., Homewood, Ill.
- GLASER-STEERS CORP., 2 Main St., Belleville 9, N. J. ADV. PG. 359.
- Guthman Inc., Edwin I., 15 S. Throop St., Chicago, Ill.
- HARNETT ELECTRIC CORP., 138 Haven Ave., Port Washington, L. I., N. Y. ADV. PG. 399.
- HEPPNER MFG. CO., P. O. Box 612, Round Lake, Ill. ADV. PG. 413.
- HIGHLAND ENGINEERING CO., Main St. & Urban Ave., Westbury, N. Y. ADV. PG. 360.
- HILLBURN ELECTRONIC PRODUCTS CO., 55 Nassau St., Brooklyn 22, N. Y. ADV. PG. 362.
- HOULIHAN CO., T. J., 2508-14 W. Lawrence Ave., Chicago 25, Ill. ADV. PG. 336.
- Inductive Equipment Co., Gettysburg, Pa.
- KURMAN ELECTRIC CO., INC., 35-18 37th St., Long Island City 1, N. Y. ADV. PG. 196.
- Leonard Electric Products Co., Inc., 1562 61st St., Brooklyn 19, N. Y.
- Loral Electronics Corp., 794 E. 140th St., New York 54, N. Y.
- Master Appliance Mfg. Co., Fourth & Ontario Sts., Racine, Wis.
- Measurement Engineering, Ltd., Arnprior, Ontario, Canada.
- MEASUREMENTS CORP., Boonton, N. J. ADV. PG. 99.
- MEPCO, INC., 35-37 Abbett Ave., Morristown, N. J. ADV. PG. 138.
- Mid-West Coil & Transformer Co., 1642 N. Halsted St., Chicago 14, Ill. ADV. PG. 165.
- Millen Mfg. Co., James, 150 Exchange St., Malden, Mass.
- Miller Co., J. W., 5917 S. Main St., Los Angeles 3, Calif.
- Monroe Coil Co., 2839 N. Narragansett Ave., Chicago 34, Ill.
- NATIONAL CO., INC., 61 Sherman St., Malden 48, Mass. ADV. PG. 280, 281.
- Peerless Electrical Products Co., Div. of Altec-Lansing Corp., 6920 McKinley Ave., Los Angeles 1, Calif.
- PICKERING & CO., 309 Woods Ave., Oceanside, N. Y. ADV. PG. 284.
- Pilot Radio Corp., 37-06 36th St., Long Island City 1, N. Y.
- Polytron Corp., 133 Martine Ave., White Plains, N. Y.
- Radex Corp., 2076 N. Elston Ave., Chicago 14, Ill.
- Red Arrow Electric Corp., 100 Coit St., Irvington 11, N. J.
- Rollan Electrical Co., 8020 S. South Park, Chicago, Ill.
- Ross Mfg. Co., 860 Washington St., Burlington, Iowa.
- Sickles Co., F. W., 165 Front St., Chicopee, Mass.
- SPEER RESISTOR CORP., St. Marys, Pa. ADV. PG. 406.

- SPERRY GYROSCOPE CO., Div. of the Sperry Corp., Great Neck, N. Y. ADV. PG. 103, 104.
- STANDARD COIL PRODUCTS CO., 2329 N. Pulaski Rd., Chicago 39, Ill. ADV. PG. 97.
- Standard Telephones & Cables Ltd., Connaught House, Aldwych, London W.C. 2, England.
- Standard Winding Corp., 44-62 Johnes St., Newburgh, N. Y.
- Stanwyck Winding Co., 137 Walsh Ave., Newburgh, N. Y.
- Summit Coil Co., 67 Union Pl., Summit, N. J.
- Sun Copper & Wire Co., 132 Beckwith Ave., Paterson, N. J.
- Super Electric Products Corp., 46 Oliver St., Newark, N. J.
- Tartak-Stolle Electronics, Inc., 3970 S. Grand Ave., Los Angeles 37, Calif.
- Teleradio Engineering Corp., 99 Wall St., New York 5, N. Y.
- Television Laboratories, Inc., 5045 W. Lake St., Chicago 44, Ill.
- Tetrad Co., 4921 Exposition Blvd., Los Angeles 16, Calif.
- Thordarson-Meissner Mfg. Divs., 500 W. Huron St., Chicago 10, Ill.
- Trenton Transformer Corp., P. O. Box 568, Trenton, N. J.
- U. S. ELECTRONICS CORP., 276 Warren St., Lyndhurst, N. J. ADV. PG. 76.
- Vokar Corp., 7300 Huron River Drive, Dexter, Mich.
- Wheeler Insulated Wire Co., Inc., 150 E. Aurora St., Waterbury 91, Conn.

COIL WINDING MACHINES
See Machines—Coil Winding

COIL WINDINGS

- A.P.W. Co., 72 W. Main St., Rockaway, N. J.
- ACME ELECTRONICS, INC., 300 N. Lake Ave., Pasadena 4, Calif. ADV. PG. 182.
- Acme Wire Co., New Haven 14, Conn.
- Acro Products Co., 215 Arch St., Philadelphia 6, Pa.
- Aero Coil Inc., 507-26th St., Union City, N. J.
- AEROLITE ELECTRONIC HARDWARE CORP., 507 26th St., Union City, N. J. ADV. PG. 355.
- AIRDESIGN, INC., 241 Fairfield Ave., Upper Darby, Pa. ADV. PG. 368.
- ALLIED CONTROL CO., INC., 2 East End Ave., New York 21, N. Y. ADV. PG. 62, 63.
- Altec Lansing Corp., 9356 Santa Monica Blvd., Beverly Hills, Calif.
- American Relay & Controls Inc., 4901 W. Flournoy St., Chicago 44, Ill.
- Atlas Coil Winders, Inc., Stamford, Conn.
- Aurex Corp., Chicago 10, Ill.
- BARKER & WILLIAMSON, 235 Fairfield Ave., Upper Darby, Pa. ADV. PG. 292.
- Best Mfg. Co., 1200 Grove St., Irvington 11, N. J.
- BOGUE ELECTRIC MFG. CO., 52 Iowa Ave., Paterson 3, N. J. ADV. PG. 155.
- BOND ELECTRONICS CORP., 88 Franklin Place, Summit, N. J. ADV. PG. 403.
- Bunnell & Co., J. H., 81 Prospect St., Brooklyn, N. Y.
- CADDELL-BURNS MFG. CO., 40 E. Second St., Mineola, N. Y. ADV. PG. 224.
- CAMBRIDGE THERMIONIC CORP., 445 Concord Ave., Cambridge 38, Mass. ADV. PG. 37.
- Carter Parts Co., 213 Institute Place, Chicago 10, Ill.
- CENTRONICS CO., 5065 Broadway, New York, N. Y. ADV. PG. 364.
- CHICAGO TRANSFORMER DIV., Essex Wire Corp., 3501 W. Addison St., Chicago 18, Ill. ADV. PG. 205.
- Clippard Instrument Laboratory, Inc., 1125 Bank St., Cincinnati 14, Ohio.
- Coil Winders, Inc., 61 Bergen St., Brooklyn 2, N. Y.
- COILCRAFT, INC., 3716 N. Cicero Ave., Chicago 41, Ill. ADV. PG. 360.
- COMAR ELECTRIC CO., 3349 W. Addison St., Chicago 18, Ill. ADV. PG. 335.
- Connecticut Telephone & Electric Corp., 70 Britannia St., Meriden, Conn.
- Coto-Coil Co., Inc., 65 Pavilion Ave., Providence 5, R. I.
- Crest Transformer Corp., 1834-36 W. North Ave., Chicago 22, Ill.
- DX Radio Products Co., Inc., 2304 Armitage Ave., Chicago 47, Ill.
- DANO ELECTRIC CO., Main St., Winsted, Conn. ADV. PG. 266.
- Davis & Co., Dean W., 3418 N. Milwaukee Ave., Chicago, Ill.
- Delco Radio Div., General Motors Corp., Kokomo, Ind.
- Deuschmann Corp., Tobe, 921 Providence Highway, Norwood, Mass.
- DIETZ DESIGN & MFG. CO., Grandview 6, Mo. ADV. PG. 323.
- Dormitzer Electric Co., Inc., 89 Brighton Ave., Boston 34, Mass.
- Douglas-Randall, Inc., 102 High St., Westerly, R. I.
- Durakool, Inc., 1010 N. Main St., Elkhart, Ind.
- Eastern Specialty Co., Philadelphia 40, Pa.
- Ecco High Frequency Corp., 7020 Hudson Blvd., North Bergen, N. J.

- Edwards Co., Inc., 86 Boston Post Rd., Norwalk, Conn.
- Electran Mfg. Co., 1901 N. Clybourn, Chicago, Ill.
- Electrical Windings, Inc., 2015 N. Kolmar Ave., Chicago 39, Ill.
- Electricoil Transformer Co., Westerly Rd., Ossining, N. Y.
- ELECTRONIC COILS, INC., P. O. Box 1641, 44 Taylor St., Springfield, Mass. ADV. PG. 400.
- Electronic Indicator Corp., 259 Green St., Brooklyn 22, N. Y.
- Electronic Products Div., Epco Products, Inc., 2430 Atlantic Ave., Brooklyn 22, N. Y.
- ELECTRONIC TRANSFORMER CO., INC., 215 W. 25th St., New York, N. Y. ADV. PG. 278.
- Electyme Motor Products Corp., 565 W. Washington Blvd., Chicago 6, Ill.
- Ensign Coil Co., 2516 S. Pulaski Rd., Chicago, Ill.
- Etraco Mfg. Co., Inc., Woods Church Rd., Flemington, N. J.
- FERRANTI ELECTRIC, INC., 30 Rockefeller Plaza, New York 20, N. Y. ADV. PG. 159.
- FUGLE-MILLER LABORATORIES, INC., 399 Main St., Metuchen, N. J. ADV. PG. 218.
- Gaveco Labs., Inc., 2 East End Ave., New York 21, N. Y.
- General Transformer Co., 18240 Harwood Ave., Homewood, Ill.
- GLASER-STEERS CORP., 2 Main St., Belleville 9, N. J. ADV. PG. 359.
- GRAMER TRANSFORMER CO., 2734 N. Pulaski Rd., Chicago 39, Ill. ADV. PG. 383.
- Guthman Inc., Edwin I., 15 S. Throop St., Chicago, Ill.
- HEPPNER MFG. CO., P. O. Box 612, Round Lake, Ill. ADV. PG. 413.
- HIGHLAND ENGINEERING CO., Main St. & Urban Ave., Westbury, N. Y. ADV. PG. 360.
- HILLBURN ELECTRONIC PRODUCTS CO., 55 Nassau Ave., Brooklyn 22, N. Y. ADV. PG. 362.
- Hoffman Engineering Corp., Anoka, Minn.
- HOULIHAN CO., T. J., 2508-14 W. Lawrence Ave., Chicago 25, Ill. ADV. PG. 336.
- I-T-E Circuit Breaker Co., 19th & Hamilton Sts., Philadelphia 30, Pa.
- Inductive Equipment Co., Gettysburg, Pa.
- King Electric Equipment Co., 9123 Inman Ave., Cleveland 5, Ohio.
- KURMAN ELECTRIC CO., INC., 35-18 37th St., Long Island City 1, N. Y. ADV. PG. 196.
- Leonard Electric Products Co., Inc., 6125 61st St., Brooklyn, N. Y.
- Magnetic Windings Div., Essex Wire Corp., Freemanburg Ave. & Hobson Blvd., Easton, Pa.
- Master Appliance Mfg. Co., Fourth & Ontario Sts., Racine, Wis.
- Measurement Engineering, Ltd., Arnprior, Ontario, Canada.
- MEASUREMENTS CORP., Boonton, N. J. ADV. PG. 99.
- MEPCO, INC., 35-37 Abbett Ave., Morristown, N. J. ADV. PG. 138.
- MID-WEST COIL & TRANSFORMER CO., 1642 N. Halsted St., Chicago 14, Ill. ADV. PG. 165.
- Millen Mfg. Co., James, 150 Exchange St., Malden, Mass.
- Miller Co., J. W., 5917 S. Main St., Los Angeles 3, Calif.
- MODELECTRIC PRODUCTS CORP., 1500 Bangs Ave., Asbury Park, N. J. ADV. PG. 204.
- Monroe Coil Co., 2839 N. Narragansett Ave., Chicago 34, Ill.
- NATIONAL CO., INC., 61 Sherman St., Malden 48, Mass. ADV. PG. 280, 281.
- Phelps Dodge Copper Products Corp., 40 Wall St., New York 5, N. Y.
- PICKERING & CO., 309 Woods Ave., Oceanside, N. Y. ADV. PG. 284.
- Polytron Corp., 133 Martine Ave., White Plains, N. Y.
- Radex Corp., 2076 N. Elston Ave., Chicago 14, Ill.
- Raypar, Inc., 7800 W. Addison St., Chicago, Ill.
- Red Arrow Electric Corp., 100 Coit St., Irvington 11, N. J.
- Richmond Engineering Co., Inc., 48 Water St., South Norwalk, Conn.
- Rollan Electrical Co., 8020 S. South Park, Chicago, Ill.
- Ross Mfg. Co., 860 Washington St., Burlington, Iowa.
- Sag Harbor Industries, Inc., Bay St., Sag Harbor, N. Y.
- Sickles Co., F. W., 165 Front St., Chicopee, Mass.
- SPERRY GYROSCOPE CO., Div. of the Sperry Corp., Great Neck, N. Y. ADV. PG. 103, 104.
- STANDARD COIL PRODUCTS CO., 2329 N. Pulaski Rd., Chicago 39, Ill. ADV. PG. 97.
- Standard Winding Corp., 44-62 Johnes St., Newburgh, N. Y.
- Stanwyck Winding Co., 137 Walsh Ave., Newburgh, N. Y.
- Summit Coil Co., 67 Union Pl., Summit, N. J.
- Sun Copper & Wire Co., 132 Beckwith Ave., Paterson, N. J.
- Tartak-Stolle Electronics, Inc., 3970 S. Grand Ave., Los Angeles 37, Calif.
- Teleradio Engineering Corp., 99 Wall St., New York, N. Y.
- Television Laboratories, Inc., 5045 W. Lake St., Chicago, 44 Ill.
- Tetrad Co., 4921 Exposition Blvd., Los Angeles 16, Calif.

V indicates . . . IN PRODUCTION • AVAILABILITY • UNRESTRICTED FOR GENERAL USE

- ⊙ Thordarson-Meissner Mfg. Divs., 500 W. Huron St., Chicago 10, Ill.
- ⊙ Trenton Transformer Corp., P. O. Box 568, Trenton, N. J.
- ⊙ Triad Transformer Mfg. Co., 2254 Sepulveda Blvd., Los Angeles 64, Calif.
- ⊙ UNION ELECTRIC PRODUCTS CO., 24 Edison Pl., Newark 2, N. J. ADV. PG. 60.
- ⊙ U. S. ELECTRONICS CORP., 276 Warren St., Lyndhurst, N. J. ADV. PG. 76.
- Vokar Corp., 7300 Huron River Drive, Dexter, Mich.
- ⊙ WEBSTER SPRING CORP., 176-182 Johnson St., Brooklyn 1, N. Y. ADV. PG. 394.
- ⊙ Weymouth Instrument Co., 1440 Commercial St., East Weymouth 89, Mass.

COILS—Antenna

- ⊙ Aero Coil Inc., 507-26th St., Union City, N. J.
- ⊙ AEROLITE ELECTRONIC HARDWARE CORP., 507 26th St., Union City, N. J. ADV. PG. 355.
- ⊙ BARKER & WILLIAMSON, 235 Fairfield Ave., Upper Darby, Pa. ADV. PG. 292.
- ⊙ BOND ELECTRONICS CORP., 88 Franklin Pl., Summit, N. J. ADV. PG. 403.
- ⊙ CADDELL-BURNS MFG. CO., 40 E. Second St., Mineola, N. Y. ADV. PG. 224.
- ⊙ CAMBRIDGE THERMIONIC CORP., 445 Concord Ave., Cambridge 38, Mass. ADV. PG. 37.
- ⊙ CARON MFG. CO., 415 S. Aberdeen St., Chicago, Ill.
- ⊙ CENTRONICS CO., 5065 Broadway, New York, N. Y. ADV. PG. 364.
- ⊙ COILCRAFT, INC., 3716 N. Cicero Ave., Chicago 41, Ill. ADV. PG. 360.
- Coil Winders, Inc., 61 Bergen St., Brooklyn 2, N. Y.
- ⊙ Copperwell Steel Co., Glassport, Pa.
- ⊙ Davis & Co., Inc., Dean W., 3418 N. Milwaukee Ave., Chicago, Ill.
- ⊙ Delco Radio Div., General Motors Corp., Kokomo, Ind.
- ⊙ DIETZ DESIGN & MFG. CO., Grandview 6, Mo. ADV. PG. 323.
- ⊙ ELECTRONIC DESIGNS, INC., 28-30 School St., Yonkers, N. Y. ADV. PG. 332.
- Electronic Indicator Corp., 259 Green St., Brooklyn 22, N. Y.
- ⊙ Essex Electronics, Berkeley Heights, N. J.
- ⊙ FUGLE-MILLER LABORATORIES, INC., 399 Main St., Metuchen, N. J. ADV. PG. 218.
- Guthman Inc., Edwin I., 15 S. Throop St., Chicago, Ill.
- ⊙ HARTNETT ELECTRIC CORP., 138 Haven Ave., Port Washington, L. I., N. Y. ADV. PG. 399.
- ⊙ HILLBURN ELECTRONIC PRODUCTS CO., 55 Nassau Ave., Brooklyn 22, N. Y. ADV. PG. 362.
- ⊙ HOULIHAN CO., T. J., 2508-14 W. Lawrence Ave., Chicago 25, Ill. ADV. PG. 336.
- ⊙ JOHNSON CO., E. F., Waseca, Minn. ADV. PG. 118, 121.
- Loral Electronics Corp., 794 E. 140th St., New York 54, N. Y.
- ⊙ MEASUREMENTS CORP., Boonton, N. J. ADV. PG. 99.
- ⊙ Miller Co., J. W., 5917 S. Main St., Los Angeles 3, Calif.
- Monroe Coil Co., 2839 N. Narragansett Ave., Chicago 34, Ill.
- ⊙ Muter Co., 1255 S. Michigan Ave., Chicago, Ill.
- ⊙ Phelps Dodge Copper Products Corp., 40 Wall St., New York 5, N. Y.
- ⊙ Philco Corp., Tioga & C Sts., Philadelphia 34, Pa.
- ⊙ Polytron Corp., 133 Martine Ave., White Plains, N. Y.
- ⊙ Radex Corp., 2076 N. Elston Ave., Chicago 14, Ill.
- Ross Mfg. Co., 860 Washington St., Burlington, Iowa.
- Sickles Co., F. W., 165 Front St., Chicopee, Mass.
- ⊙ STANDARD COIL PRODUCTS CO., 2329 N. Pulaski Rd., Chicago 39, Ill. ADV. PG. 97.
- ⊙ Standard Winding Corp., 44-62 Johnes St., Newburgh, N. Y.
- ⊙ Stanwyck Winding Co., 137 Walsh Ave., Newburgh, N. Y.
- ⊙ Summit Coil Co., 67 Union Pl., Summit, N. J.
- ⊙ Suer Electric Products Corp., 46 Oliver St., Newark, N. J.
- ⊙ Teleradio Engineering Corp., 99 Wall St., New York 5, N. Y.
- ⊙ Tetrac Co., 4921 Exposition Blvd., Los Angeles 16, Calif.
- ⊙ Thordarson-Meissner Mfg. Divs., 500 W. Huron St., Chicago 10, Ill.
- ⊙ U. S. ELECTRONICS CORP., 276 Warren St., Lyndhurst, N. J. ADV. PG. 76.
- ⊙ Ward Products Corp., Div. of The Gabriel Co., 1523 W. 45th St., Cleveland 3, Ohio.
- ⊙ WEBSTER SPRING CORP., 176-182 Johnson St., Brooklyn 1, N. Y. ADV. PG. 394.

COILS—Choke

- ⊙ A. P. W. Co., 72 W. Main St., Rockaway, N. J.
- ⊙ ACME ELECTRONICS, INC., 300 N. Lake Ave., Pasadena 4, Calif. ADV. PG. 90.
- Acro Products Co., 215 Arch St., Philadelphia 6, Pa.
- ⊙ Acro Transformer Mfg. Corp., 26-02 4th St., Astoria 2, N. Y.
- ⊙ Aero Coil Inc., 507-26th St., Union City, N. J.

- ⊙ AEROLITE ELECTRONIC HARDWARE CORP., 507 26th St., Union City, N. J. ADV. PG. 355.
- ⊙ ALLIED CONTROL CO., INC., 2 East End Ave., New York 21, N. Y. ADV. PG. 62, 63.
- ⊙ Altec Lansing Corp., 9356 Santa Monica Blvd., Beverly Hills, Calif.
- ⊙ Atlas Coil Winders, Inc., Stamford, Conn.
- ⊙ Automatic Mfg. Corp., 65 Gouverneur St., Newark, N. J.
- ⊙ BARKER & WILLIAMSON, 235 Fairfield Ave., Upper Darby, Pa. ADV. PG. 292.
- ⊙ BOND ELECTRONICS CORP., 88 Franklin Place, Summit, N. J. ADV. PG. 403.
- ⊙ CADDELL-BURNS MFG. CO., 40 E. Second St., Mineola, N. Y. ADV. PG. 224.
- ⊙ CAMBRIDGE THERMIONIC CORP., 445 Concord Ave., Cambridge 38, Mass. ADV. PG. 37.
- ⊙ CENTRONICS CO., 5065 Broadway, New York, N. Y. ADV. PG. 364.
- ⊙ Clippard Instrument Laboratory, Inc., 1125 Bank St., Cincinnati 14, Ohio.
- ⊙ COILCRAFT, INC., 3716 N. Cicero Ave., Chicago 41, Ill. ADV. PG. 360.
- Coil Winders Inc., 61 Bergen St., Brooklyn 2, N. Y.
- ⊙ COMAR ELECTRIC CO., 3349 W. Addison St., Chicago 18, Ill. ADV. PG. 335.
- ⊙ Continental Electric Co., Inc., 334 Ferry St., Newark 5, N. J.
- ⊙ Coto-Coil Co., Inc., 65 Pavillion Ave., Providence 5, R. I.
- ⊙ Crest Transformer Corp., 1834-36 W. North Ave., Chicago 22, Ill.
- ⊙ DANO ELECTRIC CO., Main St., Winsted, Conn. ADV. PG. 266.
- ⊙ Davis & Co., Dean W., 3418 N. Milwaukee Ave., Chicago, Ill.
- ⊙ Delco Radio Div., General Motors Corp., Kokomo, Ind.
- ⊙ DIETZ DESIGN & MFG. CO., Grandview 6, Mo. ADV. PG. 323.
- ⊙ Dormitzer Electric Co., Inc., 89 Brighton Ave., Boston 34, Mass.
- ⊙ Douglas-Randall, Inc., 102 High St., Westerly, R. I.
- ⊙ DX Radio Products Co., Inc., 2304 Armitage Ave., Chicago 47, Ill.
- ⊙ Edwards Co., Inc., 86 Boston Post Rd., Norwalk, Conn.
- Electran Mfg. Co., 1901 N. Clybourn, Chicago, Ill.
- ⊙ ELECTRICAL REACTANCE CORP., Seneca Ave., Olean, N. Y. ADV. PG. 56, 57.
- ⊙ Electrical Windings, Inc., 2015 N. Kolmar Ave., Chicago 39, Ill.
- Electricoil Transformer Co., Westerly Rd., Ossining, N. Y.
- ⊙ ELECTRONIC COILS, INC., P. O. Box 1641, 44 Taylor St., Springfield, Mass. ADV. PG. 400.
- Electronic Indicator Corp., 259 Green St., Brooklyn 22, N. Y.
- Electronic Products Div., Epco Products, Inc., 2430 Atlantic Ave., Brooklyn 33, N. Y.
- ⊙ ELECTRONIC TRANSFORMER CO., INC., 215 W. 25th St., New York, N. Y. ADV. PG. 278.
- ⊙ Empire Coil Co., Inc., New Rochelle, N. Y.
- ⊙ Ensign Coil Co., 2516 S. Pulaski Rd., Chicago, Ill.
- ⊙ Essex Electronics, Berkeley Heights, N. J.
- ⊙ Etraco Mfg. Co., Inc., Woods Church Rd., Flemington, N. J.
- ⊙ FERRANTI ELECTRIC, INC., 30 Rockefeller Plaza, New York 20, N. Y. ADV. PG. 159.
- ⊙ FREED TRANSFORMER CO., INC., 1736 Weirfield St., Brooklyn 27, N. Y. ADV. PG. 149.
- ⊙ FUGLE-MILLER LABORATORIES, INC., 399 Main St., Metuchen, N. J. ADV. PG. 218.
- ⊙ Gates Radio Co., Quincy, Ill.
- ⊙ General Transformer Co., 18240 Harwood Ave., Homewood, Ill.
- ⊙ GRAMER TRANSFORMER CO., 2734 N. Pulaski Rd., Chicago 39, Ill. ADV. PG. 383.
- Guthman Inc., Edwin I., 15 S. Throop St., Chicago, Ill.
- ⊙ HARNETT ELECTRIC CORP., 138 Haven Ave., Port Washington, L. I., N. Y. ADV. PG. 399.
- ⊙ HIGHLAND ENGINEERING CO., Main St. & Urban Ave., Westbury, N. Y. ADV. PG. 360.
- ⊙ HILLBURN ELECTRONIC PRODUCTS CO., 55 Nassau Ave., Brooklyn 22, N. Y. ADV. PG. 362.
- ⊙ HOULIHAN CO., T. J., 2508-14 W. Lawrence Ave., Chicago 25, Ill. ADV. PG. 336.
- Inductive Equipment Co., Gettysburg, Pa.
- ⊙ INSTRUMENT RESISTORS CO., 1036 Commerce Ave., Union, N. J. ADV. PG. 392, 393.
- ⊙ Insuline Corp. of America, 36-02 35th Ave., Long Island City, N. Y.
- ⊙ INTERNATIONAL RESISTANCE CO., 401 N. Broad St., Philadelphia 8, Pa. ADV. PG. 134, 135.
- ⊙ I-T-E Circuit Breaker Co., 19th & Hamilton Sts., Philadelphia 30, Pa.
- ⊙ JEFFERS ELECTRONICS CO., DuBois, Pa. ADV. PG. 406.
- ⊙ JOHNSON CO., E. F., Waseca, Minn. ADV. PG. 118, 121.
- Leonard Electric Products Co., Inc., 1562 61st St., Brooklyn, N. Y.
- ⊙ LEWIS SPRING & MFG. CORP., 2646 W. North Ave., Chicago 47, Ill. ADV. PG. 293.
- Loral Electronics Corp., 794 E. 140th St., New York 54, N. Y.
- ⊙ Magnetic Windings Div., Essex Wire Corp., Freemansburg Ave. & Hobson Blvd., Easton, Pa.
- ⊙ Mallory & Co., Inc., P. R., 3029 E. Washington St., Indianapolis 6, Ind.
- ⊙ MEASUREMENTS CORP., Boonton, N. J. ADV. PG. 99.

- Melco Products, Inc., 22 E. Hennepin Ave., Minneapolis 1, Minn.
- ⊙ Millen Mfg. Co., James, 150 Exchange St., Malden, Mass.
- ⊙ Miller Co., J. W., 5917 S. Main St., Los Angeles 3, Calif.
- Monroe Coil Co., 2839 N. Narragansett Ave., Chicago 34, Ill.
- ⊙ NATIONAL CO., INC., 61 Sherman St., Malden 48, Mass. ADV. PG. 280, 281.
- ⊙ OHMITE MFG. CO., 4835 W. Flournoy St., Chicago 44, Ill. ADV. PG. 41.
- ⊙ Peerless Electrical Products Co., Div. of Altec-Lansing Corp., 6920 McKinley Ave., Los Angeles, Calif.
- ⊙ Phelps Dodge Copper Products Corp., 40 Wall St., New York 5, N. Y.
- ⊙ Philco Corp., Tioga & C Sts., Philadelphia 34, Pa.
- Presto Electric Co., Inc., 4513 New York Ave., Union City, N. J.
- ⊙ Radex Corp., 2076 N. Elston Ave., Chicago 14, Ill.
- Red Arrow Electric Corp., 100 Coit St., Irvington 11, N. J.
- ⊙ Richmond Engineering Co., Inc., 48 Water St., South Norwalk, Conn.
- Rollan Electrical Co., 8020 S. South Park, Chicago Ill.
- Ross Mfg. Co., 860 Washington St., Burlington, Iowa.
- Sickles Co., F. W., 165 Front St., Chicopee, Mass.
- ⊙ SPERRY GYROSCOPE CO., Div. of The Sperry Corp., Great Neck, N. Y. ADV. PG. 103, 104.
- ⊙ STANDARD COIL PRODUCTS CO., 2329 N. Pulaski Rd., Chicago 39, Ill. ADV. PG. 97.
- ⊙ STANDARD TRANSFORMER CORP., Elston, Kedzie & Addison, Chicago 18, Ill. ADV. PG. 144.
- ⊙ Standard Winding Corp., 44-62 Johnes St., Newburgh, N. Y.
- ⊙ Stanwyck Winding Co., 137 Walsh Ave., Newburgh, N. Y.
- ⊙ Summit Coil Co., 67 Union Pl., Summit, N. J.
- ⊙ Super Electric Products Corp., 46 Oliver St., Newark, N. J.
- ⊙ Tartak-Stolle Electronics, Inc., 3970 S. Grand Ave., Los Angeles 37, Calif.
- ⊙ Teleradio Engineering Corp., 99 Wall St., New York 5, N. Y.
- ⊙ Tetrac Co., 4921 Exposition Blvd., Los Angeles 16, Calif.
- ⊙ Thordarson-Meissner Mfg. Divs., 500 W. Huron St., Chicago 10, Ill.
- ⊙ Triad Transformer Mfg., Co., 2254 Sepulveda Blvd., Los Angeles 64, Calif.
- ⊙ UNION ELECTRIC PRODUCTS CO., 24 Edison Pl., Newark 2, N. J. ADV. PG. 60.
- ⊙ U. S. ELECTRONICS CORP., 276 Warren St., Lyndhurst, N. J. ADV. PG. 76.
- ⊙ UNITED TRANSFORMER CO., 150 Varlick St., New York 13, N. Y. ADV. PG. Inside Front Cover.
- Vokar Corp., 7300 Huron River Drive, Dexter, Mich.
- ⊙ WEBSTER SPRING CORP., 176-182 Johnson St., Brooklyn 1, N. Y. ADV. PG. 394.

COILS—Electronic Heating Inductor

- ⊙ Aero Coil Inc., 507-26 St., Union City, N. J.
- ⊙ AEROLITE ELECTRONIC HARDWARE CORP., 507 26th St., Union City, N. J. ADV. PG. 355.
- ⊙ BARKER & WILLIAMSON, 235 Fairfield Ave., Upper Darby, Pa. ADV. PG. 292.
- Coil Winders, Inc., 61 Bergen St., Brooklyn 2, N. Y.
- Electricoil Transformer Co., Westerly Rd., Ossining, N. Y.
- Electronic Brazing Co., 146 Glenridge Ave., Montclair, N. J.
- ⊙ Electronic Engineering Corp., 469 Elm St., Arlington N. J.
- ⊙ ELECTRONIC TRANSFORMER CO., INC., 215 W. 25th St., New York, N. Y. ADV. PG. 278.
- ⊙ High Frequency Heating Co., 143 Glen Park Ave., Gary, Ind.
- ⊙ HIGHLAND ENGINEERING CO., Main St. & Urban Ave., Westbury, N. Y. ADV. PG. 360.
- ⊙ JOHNSON CO., E. F., Waseca, Minn. ADV. PG. 118-121.
- ⊙ Phelps Dodge Copper Products Corp., 40 Wall St., New York 5, N. Y.
- ⊙ Reeve Electronics, Inc., 609 W. Lake St., Chicago 6, Ill.
- ⊙ Sherman Industrial Electronics Co., Inc., 505 Washington Ave., Belleville 9, N. J.
- ⊙ Tartak-Stolle Electronics, Inc., 3970 S. Grand Ave., Los Angeles 37, Calif.
- ⊙ Thordarson-Meissner Mfg. Divs., 500 W. Huron St., Chicago 10, Ill.
- ⊙ Tocco Division, Ohio Crankshaft Co., 3800 Harvard Ave., Cleveland 1, Ohio.
- ⊙ U. S. ELECTRONICS CORP., 276 Warren St., Lyndhurst, N. J. ADV. PG. 76.
- ⊙ WESTINGHOUSE ELECTRIC CORP., 511 Wood St., P. O. Box 868, Pittsburgh 30, Pa. ADV. PG. 107-113.

COILS—Flyback

- ⊙ Aero Coil Inc., 507-26th St., Union City, N. J.
- ⊙ AEROLITE ELECTRONIC HARDWARE CORP., 507 26th St., Union City, N. J. ADV. PG. 355.

V indicates . . . IN PRODUCTION • AVAILABILITY • UNRESTRICTED FOR GENERAL USE

BARKER & WILLIAMSON, 235 Fairfield Ave., Upper Darby, Pa. ADV. PG. 292.
BOND ELECTRONICS CORP., 88 Franklin Place, Summit, N. J. ADV. PG. 403.
 Coil Winders, Inc., 61 Bergen St., Brooklyn 2, N. Y.
COILCRAFT, INC., 3716 N. Cicero Ave., Chicago 41, Ill. ADV. PG. 360.
D X Radio Products Co., Inc., 2304 Armitage Ave., Chicago, Ill.
Du Mont Laboratories, Inc., Allen B., Electronic Parts Div., 35 Market St., East Paterson, N. J.
Empire Coil Co., Inc., Beechwood Ave. & Second St., New Rochelle, N. Y.
 Guthman Inc., Edwin I., 15 S. Throop St., Chicago, Ill.
HEPPNER MFG. CO., P. O. Box 612, Round Lake, Ill. ADV. PG. 413.
HILLBURN ELECTRONIC PRODUCTS CO., 55 Nassau St., Brooklyn 22, N. Y. ADV. PG. 362.
 Leonard Electric Products Co., Inc., 1562 61st St., Brooklyn 19, N. Y.
 M. P. Concert Installations, Fairfield 10, Conn.
 Monroe Coil Co., 2839 N. Narragansett Ave., Chicago 34, Ill.
RADIO CORP. OF AMERICA, Tube Dept., Harrison, N. J. ADV. PG. 177, Inside Back & Back Covers.
Rola Co., Inc., 2530 Superior Ave., Cleveland 14, Ohio.
 Ross Mfg. Co., 860 Washington St., Burlington, Iowa.
 Sickles Co., F. W., 165 Front St., Chicopee, Mass.
STANDARD COIL PRODUCTS CO., 2329 N. Pulaski Rd., Chicago 39, Ill. ADV. PG. 97.
Standard Winding Co., 44-62 Johnes St., Newburgh, N. Y.
Stanwyck Winding Co., 137 Walsh Ave., Newburgh, N. Y.
Tartak-Stolle Electronics, Inc., 3970 S. Grand Ave., Los Angeles 37, Calif.
Teleradio Engineering Corp., 99 Wall St., New York, N. Y.
TEL-RAD MFG. CO., INC., 7th & Madison St., Fennimore, Wis. ADV. PG. 412.
Tetrad Co., 4921 Exposition Blvd., Los Angeles 16, Calif.
Thordarson-Meissner Mfg. Divs., 500 W. Huron St., Chicago 10, Ill.
Triad Transformer Mfg. Co., 2254 Sepulveda Blvd., Los Angeles 64, Calif.
U. S. ELECTRONICS CORP., 276 Warren St., Lyndhurst, N. J. ADV. PG. 76.

COILS—Magnet

A. P. W. Co., 72 W. Main St., Rockaway, N. J.
Acme Wire Co., New Haven 14, Conn.
Acro Products Co., 215 Arch St., Philadelphia 6, Pa.
Aero Coil Inc., 507-26th St., Union City, N. J.
AEROLITE ELECTRONIC HARDWARE CORP., 507 26th St., Union City, N. J. ADV. PG. 355.
ALLIED CONTROL CO., INC., 2 East End Ave., New York 21, N. Y. ADV. PG. 62, 63.
American Relay & Controls, Inc., 4901 W. Flournoy St., Chicago 44, Ill.
Best Mfg. Co., 1200 Grove St., Irvington 11, N. J.
BOND ELECTRONICS CORP., 88 Franklin Place, Summit, N. J. ADV. PG. 403.
CADDELL-BURNS MFG. CO., 40 E. Second St., Mineola, N. Y. ADV. PG. 224.
 Coil Winders Inc., 61 Bergen St., Brooklyn 2, N. Y.
COILCRAFT, INC., 3716 N. Cicero Ave., Chicago 41, Ill. ADV. PG. 360.
Connecticut Telephone & Electric Corp., 70 Britannia St., Meriden, Conn.
Coto-Coil Co., Inc., 65 Pavillion Ave., Providence 5, R. I.
DANO ELECTRIC CO., Main St., Winsted, Conn. ADV. PG. 266.
Davis & Co., Inc., Dean W., 3418 N. Milwaukee Ave., Chicago, Ill.
 Davis Electric Co., Cape Girardeau, Mo.
DIETZ DESIGN & MFG. CO., Grandview 6, Mo. ADV. PG. 323.
Douglas-Randall, Inc., 102 High St., Westerly, R. I.
Edwards Co., Inc., 86 Boston Post Rd., Norwalk, Conn.
 ElectrAn Mfg. Co., 1901 N. Clybourn, Chicago, Ill.
Electrical Windings, Inc., 2015 N. Kolmar Ave., Chicago 39, Ill.
 Electricoil Transformer Co., Westerly Rd., Ossining, N. Y.
ELECTRONIC COILS, INC., P. O. Box 1641, 44 Taylor St., Springfield, Mass. ADV. PG. 400.
 Electronic Products Div., Epco Products, Inc., 2430 Atlantic Ave., Brooklyn 33, N. Y.
ELECTRONIC TRANSFORMER CO., INC., 215 W. 25th St., New York, N. Y. ADV. PG. 278.
Empire Coil Co., Inc., Beechwood Ave. & Second St., New Rochelle, N. Y.
Etraco Mfg. Co., Inc., Woods Church Rd., Flemington, N. J.
FERRANTI ELECTRIC, INC., 30 Rockefeller Plaza, New York 20, N. Y. ADV. PG. 159.
FUGLE-MILLER LABORATORIES, INC., 399 Main St., Metuchen, N. J. ADV. PG. 218.
GLASER-STEERS CORP., 2 Main St., Belleville 9, N. J. ADV. PG. 359.
GRAMER TRANSFORMER CO., 2734 N. Pulaski Rd., Chicago 39, Ill. ADV. PG. 383.

Guthman Inc., Edwin I., 15 S. Throop St., Chicago, Ill.
HILLBURN ELECTRONIC PRODUCTS CO., 55 Nassau St., Brooklyn 22, N. Y. ADV. PG. 362.
HOULIHAN CO., T. J., 2508-14 W. Lawrence Ave., Chicago 25, Ill. ADV. PG. 336.
 Inductive Equipment Co., Gettysburg, Pa.
KELLOGG SWITCHBOARD & SUPPLY CO., 6650 S. Cicero Ave., Chicago 38, Ill. ADV. PG. 294.
KURMAN ELECTRIC CO., INC., 35-18 37th St., Long Island City 1, N. Y. ADV. PG. 196.
 Loral Electronics Corp., 794 E. 140th St., New York 54, N. Y.
Master Appliance Mfg. Co., Fourth & Ontario Sts., Racine, Wis.
McQuay-Norris Mfg. Co., 2320 Marconi Ave., St. Louis 10, Mo.
 Melco Products, Inc., 22 E. Hennepin Ave., Minneapolis 1, Minn.
MEPCO, INC., 35-37 Abnett Ave., Morristown, N. J. ADV. PG. 138.
MID-WEST COIL & TRANSFORMER CO., 1642 N. Halsted St., Chicago 14, Ill. ADV. PG. 165.
Miller Co., J. W., 5917 S. Main St., Los Angeles 3, Calif.
Peerless Electrical Products Co., Div. of Altec-Lansing Corp., 6920 McKinley Ave., Los Angeles, Calif.
Phelps Dodge Copper Products Corp., 40 Wall St., New York 5, N. Y.
 Presto Electric Co., Inc., 4513 New York Ave., Union City, N. J.
 Radlonic Transformer Co., 411 S. Sangamon St., Chicago 7, Ill.
 Red Arrow Electric Corp., 100 Coit St., Irvington 11, N. J.
Richmond Engineering Co., Inc., 48 Water St., South Norwalk, Conn.
 Rollan Electrical Co., 8020 S. South Park, Chicago, Ill.
 Sag Harbor Industries, Inc., Bay St., Sag Harbor, N. Y.
STANDARD COIL PRODUCTS CO., 2329 N. Pulaski Rd., Chicago 39, Ill. ADV. PG. 97.
Summit Coil Co., 67 Union Pl., Summit, N. J.
Super Electric Products Corp., 46 Oliver St., Newark, N. J.
Tartak-Stolle Electronics, Inc., 3970 S. Grand Ave., Los Angeles 37, Calif.
Teleradio Engineering Corp., 99 Wall St., New York, N. Y.
Tetrad Co., 4921 Exposition Blvd., Los Angeles 16, Calif.
Thordarson-Meissner Mfg. Divs., 500 W. Huron St., Chicago 10, Ill.
Triad Transformer Mfg. Co., 2254 Sepulveda Blvd., Los Angeles 64, Calif.
UNION ELECTRIC PRODUCTS CO., 24 Edison Pl., Newark 2, N. J. ADV. PG. 60.
U. S. ELECTRONICS CORP., 276 Warren St., Lyndhurst, N. J. ADV. PG. 76.
Weymouth Instrument Co., 1440 Commercial St., East Weymouth 89, Mass.

COILS—Motor & Generator Field

Aero Coil Inc., 507 26th St., Union City, N. J.
AIR ASSOCIATES, INC., Teterboro, N. J. ADV. PG. 211.
BOGUE ELECTRIC MFG. CO., 52 Iowa Ave., Paterson 3, N. J. ADV. PG. 155.
COMMUNICATION ACCESSORIES CO., Box 345, 110th St. & Hillcrest Rd., Hickman Hills, Mo. ADV. PG. 168.
Continental Electric Co., Inc., 334 Ferry St., Newark 5, N. J.
Davis & Co., Inc., Dean W., 3418 N. Milwaukee Ave., Chicago, Ill.
 Davis Electric Co., Cape Girardeau, Mo.
 Guthman Inc., Edwin I., 15 S. Throop St., Chicago, Ill.
 Hose-McCann Telephone Co., Inc., 25th St. & 3rd Ave., Brooklyn 32, N. Y.
Master Appliance Mfg. Co., Fourth & Ontario Sts., Racine, Wis.
Peerless Electrical Products Co., Div. of Altec-Lansing Corp., 6920 McKinley Ave., Los Angeles 1, Calif.
Phelps Dodge Copper Products Corp., 40 Wall St., New York 5, N. Y.
Radex Corp., 2076 N. Elston Ave., Chicago 14, Ill.
Rae Motor Corp., Box 291, Racine, Wis.
 Rollan Electrical Co., 8020 S. South Park, Chicago, Ill.
 Sag Harbor Industries, Inc., Bay St., Sag Harbor, N. Y.
SPERRY GYROSCOPE CO., Div. of The Sperry Corp., Great Neck, N. Y. ADV. PG. 103, 104.
Tetrad Co., 4921 Exposition Blvd., Los Angeles 16, Calif.
Thordarson-Meissner Mfg. Divs., 500 W. Huron St., Chicago 10, Ill.
WESTINGHOUSE ELECTRIC CORP., 511 Wood St., P. O. Box 868, Pittsburg 30, Pa. ADV. PG. 107-113.

COILS—Multiple Wound

A. P. W. Co., 72 W. Main St., Rockaway, N. J.
Acme Wire Co., New Haven 14, Conn.
Acro Products Co., 215 Arch St., Philadelphia 6, Pa.
Acro Transformer Mfg. Corp., 26-02 4th St., Astoria 2, N. Y.
Aero Coil Inc., 507-26th St., Union City, N. J.
AEROLITE ELECTRONIC HARDWARE CORP., 507 26th St., Union City, N. J. ADV. PG. 355.

AIRDESIGN, INC., 241 Fairfield Ave., Upper Darby, Pa. ADV. PG. 368.
ALLIED CONTROL CO., INC., 2 East End Ave., New York 21, N. Y. ADV. PG. 62, 63.
Altec Lansing Corp., 9356 Santa Monica Blvd., Beverly Hills, Calif.
American Relay & Controls, Inc., 4901 W. Flournoy St., Chicago 44, Ill.
Atlas Coil Winders, Inc., Stamford, Conn.
BARKER & WILLIAMSON, 235 Fairfield Ave., Upper Darby, Pa. ADV. PG. 292.
BOND ELECTRONICS CORP., 88 Franklin Place, Summit, N. J. ADV. PG. 403.
CADDELL-BURNS MFG. CO., 40 E. Second St., Mineola, N. Y. ADV. PG. 224.
CAMBRIDGE THERMIONIC CORP., 445 Concord Ave., Cambridge 38, Mass. ADV. PG. 37.
 Coil Winders, Inc., 61 Bergen St., Brooklyn 2, N. Y.
COILCRAFT, INC., 3716 N. Cicero Ave., Chicago 41, Ill. ADV. PG. 360.
COMAR ELECTRIC CO., 3349 W. Addison St., Chicago 18, Ill. ADV. PG. 335.
Connecticut Telephone & Electric Corp., 70 Britannia St., Meriden, Conn.
Coto-Coil Co., Inc., 65 Pavillion Ave., Providence 5, R. I.
Crest Transformer Corp., 1834-36 W. North Ave., Chicago 22, Ill.
DANO ELECTRIC CO., Main St., Winsted, Conn. ADV. PG. 266.
Davis & Co., Inc., Dean W., 3418 N. Milwaukee Ave., Chicago, Ill.
 Davis Electric Co., Cape Girardeau, Mo.
Delco Radio Div., General Motors Corp., Kokomo, Ind.
DIETZ DESIGN & MFG. CO., Grandview 6, Mo. ADV. PG. 323.
Douglas-Randall, Inc., 102 High St., Westerly, R. I.
Electran Mfg. Co., 1901 N. Clybourn, Chicago, Ill.
Electrical Windings, Inc., 2015 N. Kolmar Ave., Chicago 39, Ill.
ELECTRONIC COILS, INC., P. O. Box 1641, 44 Taylor St., Springfield, Mass. ADV. PG. 400.
 Electronic Indicator Corp., 259 Green St., Brooklyn 22, N. Y.
 Electronic Products Div., Epco Products, Inc., 2430 Atlantic Ave., Brooklyn 33, N. Y.
Electronic Surgical Equipment Co., Inc., N. E. Cor. 23 & Arch Sts., Philadelphia 3, Pa.
ELECTRONIC TRANSFORMER CO., INC., 215 W. 25th St., New York, N. Y. ADV. PG. 278.
Empire Coil Co., Inc., Beechwood Ave. & Second St., New Rochelle, N. Y.
Ensign Coil Co., 2516 S. Pulaski Rd., Chicago, Ill.
Essex Electronics, Berkeley Heights, N. J.
FERRANTI ELECTRIC, INC., 30 Rockefeller Plaza, New York 20, N. Y. ADV. PG. 159.
FREED TRANSFORMER CO., INC., 1736 Weirfield St., Brooklyn 27, N. Y. ADV. PG. 149.
FUGLE-MILLER LABORATORIES, INC., 399 Main St., Metuchen, N. J. ADV. PG. 218.
General Transformer Co., 18240 Harwood Ave., Homewood, Ill.
GRAMER TRANSFORMER CO., 2734 N. Pulaski Rd., Chicago 39, Ill. ADV. PG. 383.
 Guthman Inc., Edwin I., 15 S. Throop St., Chicago, Ill.
HARNETT ELECTRIC CORP., 138 Haven Ave., Port Washington, L. I., N. Y. ADV. PG. 399.
HIGHLAND ENGINEERING CO., Main St. & Urban Ave., Westbury, N. Y. ADV. PG. 360.
HILLBURN ELECTRONIC PRODUCTS CO., 55 Nassau St., Brooklyn 22, N. Y. ADV. PG. 362.
HOULIHAN CO., T. J., 2508-14 W. Lawrence Ave., Chicago 25, Ill. ADV. PG. 336.
I-T-E Circuit Breaker Co., 19th & Hamilton Sts., Philadelphia 30, Pa.
 Inductive Equipment Co., Gettysburg, Pa.
JEFFERS ELECTRONICS CO., Du Bois, Pa. ADV. PG. 406.
 Leonard Electric Products Co., Inc., 1562 61st St., Brooklyn 19, N. Y.
Magnetic Windings Div., Essex Wire Corp., Freemansburg Ave. & Hobson Blvd., Easton, Pa.
MEASUREMENTS CORP., Bonton, N. J. ADV. PG. 99.
 Melco Products, Inc., 22 E. Hennepin Ave., Minneapolis 1, Minn.
MID-WEST COIL & TRANSFORMER CO., 1642 N. Halsted St., Chicago 14, Ill. ADV. PG. 165.
Millen Mfg. Co., James, 150 Exchange St., Malden, Mass.
Miller Co., J. W., 5917 S. Main St., Los Angeles 3, Calif.
Peerless Electrical Products Co., Div. of Altec-Lansing Corp., 6920 McKinley Ave., Los Angeles, Calif.
Phelps Dodge Copper Products Corp., 40 Wall St., New York 5, N. Y.
 Presto Electric Co., Inc., 4513 New York Ave., Union City, N. J.
 Radlonic Transformer Co., 411 S. Sangamon St., Chicago 7, Ill.
 Red Arrow Electric Corp., 100 Coit St., Irvington 11, N. J.
 Rollan Electrical Co., 8020 S. South Park, Chicago, Ill.
 Ross Mfg. Co., 860 Washington St., Burlington, Iowa.
 Sag Harbor Industries, Inc., Bay St., Sag Harbor, N. Y.
STANDARD COIL PRODUCTS CO., 2329 N. Pulaski Rd., North Chicago 39, Ill. ADV. PG. 97.
Summit Coil Co., 67 Union Pl., Summit, N. J.
Sun Copper & Wire Co., 132 Beckwith Ave., Paterson, N. J.

Ⓜ indicates . . . IN PRODUCTION • AVAILABILITY • UNRESTRICTED FOR GENERAL USE

- Ⓜ Super Electric Products Corp., 46 Oliver St., Newark, N. J.
- Ⓜ Teleradio Engineering Corp., 99 Wall St., New York 5, N. Y.
- Ⓜ Tetrad Co., 4921 Exposition Blvd., Los Angeles 16, Calif.
- Ⓜ Thordarson-Meissner Mfg. Divs., 500 W. Huron St., Chicago 10, Ill.
- Ⓜ Transformer Engineers, 389 S. Arroyo Parkway, Pasadena, Calif.
- Ⓜ Trenton Transformer Corp., P. O. Box 568, Trenton, N. J.
- Ⓜ Triad Transformer Mfg. Co., 2254 Sepulveda Blvd., Los Angeles 64, Calif.
- Ⓜ U. S. ELECTRONICS CORP., 276 Warren St., Lyndhurst, N. J. ADV. PG. 76.
- Ⓜ WESTINGHOUSE ELECTRIC CORP., 511 Wood St., P. O. Box 868, Pittsburgh 30, Pa. ADV. PG. 107-113.

COILS—Pickup

- Ⓜ A. P. W. Co., 72 W. Main St., Rockaway, N. J.
- Ⓜ Aero Coil Inc., 507 26th St., Union City, N. J.
- Ⓜ BOND ELECTRONICS CORP., 88 Franklin Place, Summit, N. J. ADV. PG. 403.
- Ⓜ Coil Winders, Inc., 61 Bergen St., Brooklyn 2, N. Y.
- Ⓜ Davis & Co., Inc., Dean W., 3418 N. Milwaukee Ave., Chicago, Ill.
- Ⓜ ELECTRONIC COILS, INC., Box 1641, 44 Taylor St., Springfield, Mass. ADV. PG. 400.
- Ⓜ ELECTRONIC TRANSFORMER CO., INC., 215 W. 25th St., New York, N. Y. ADV. PG. 278.
- Ⓜ Guthman Inc., Edwin I., 15 S. Throop St., Chicago, Ill.
- Ⓜ Magnetic Windings Div., Essex Wire Corp., Freemansburg Ave. at Hobson Blvd., Easton, Pa.
- Ⓜ Miller Co., J. W., 5917 S. Main St., Los Angeles 3, Calif.
- Ⓜ Monarch Radio & Television Corp., 2430 Atlantic Ave., Brooklyn 33, N. Y.
- Ⓜ Phelps Dodge Copper Products Corp., 40 Wall St., New York 5, N. Y.
- Ⓜ Sag Harbor Industries, Inc., Bay St., Sag Harbor, N. Y.
- Ⓜ Super Electric Products Corp., 46 Oliver St., Newark, N. J.
- Ⓜ Tetrad Co., 4921 Exposition Blvd., Los Angeles 16, Calif.
- Ⓜ Thordarson-Meissner Mfg. Divs., 500 W. Huron St., Chicago 10, Ill.
- Ⓜ U. S. ELECTRONICS CORP., 276 Warren St., Lyndhurst, N. J. ADV. PG. 76.

COILS—Power & a-f Coil Windings

- Acro Products Co., 215 Arch St., Philadelphia 6, Pa.
- Ⓜ Acro Transformer Mfg. Corp., 26-02 4th St., Astoria 2, N. Y.
- Ⓜ AIRPAX PRODUCTS CO., Middle River, Baltimore 20, Md. ADV. PG. 289.
- Ⓜ ALLIED CONTROL CO., INC., 2 East End Ave., New York 21, N. Y. ADV. PG. 62, 63.
- Ⓜ Altec Lansing Corp., 9356 Santa Monica Blvd., Beverly Hills, Calif.
- Ⓜ Atlas Coil Winders, Inc., Stamford, Conn.
- Ⓜ BARKER & WILLIAMSON, 235 Fairfield Ave., Upper Darby, Pa. ADV. PG. 292.
- Ⓜ BOND ELECTRONICS CORP., 88 Franklin Place, Summit, N. J. ADV. PG. 403.
- Ⓜ CHICAGO TRANSFORMER DIV., ESSEX WIRE CORP., 3501 W. Addison St., Chicago 18, Ill. ADV. PG. 205.
- Ⓜ Coil Winders, Inc., 61 Bergen St., Brooklyn 2, N. Y.
- Ⓜ COILCRAFT, INC., 3716 N. Cicero Ave., Chicago 41, Ill. ADV. PG. 360.
- Ⓜ Crest Transformer Corp., 1834-36 W. North Ave., Chicago 22, Ill.
- Ⓜ Davis & Co., Inc., Dean W., 3418 N. Milwaukee Ave., Chicago, Ill.
- Ⓜ Delco Radio Div., General Motors Corp., Kokomo, Ind.
- Ⓜ DIETZ DESIGN & MFG. CO., Grandview 6, Mo. ADV. PG. 323.
- Ⓜ Dormitzer Electric Co., Inc., 89 Brighton Ave., Boston 34, Mass.
- Ⓜ Douglas-Randall, Inc., 102 High St., Westerly, R. I.
- Ⓜ Electron Mfg. Co., 1901 N. Clybourn, Chicago, Ill.
- Ⓜ Electrical Windings, Inc., 2015 N. Kolmar Ave., Chicago 39, Ill.
- Ⓜ Electronic Products Div., Epco Products, Inc., 2430 Atlantic Ave., Brooklyn 33, N. Y.
- Ⓜ ELECTRONIC TRANSFORMER CO., INC., 215 West 25th St., New York, N. Y. ADV. PG. 278.
- Ⓜ Etraco Mfg. Co., Inc., Woods Church Rd., Flemington, N. J.
- Ⓜ FERRANTI ELECTRIC, INC., 30 Rockefeller Plaza, New York 20, N. Y. ADV. PG. 159.
- Ⓜ FREED TRANSFORMER CO., INC., 1736 Weirfield St., Brooklyn 27, N. Y. ADV. PG. 149.
- Ⓜ General Transformer Co., 18240 Harwood Ave., Homewood, Ill.
- Ⓜ GRAMER TRANSFORMER CO., 2734 N. Pulaski Rd., Chicago 39, Ill. ADV. PG. 383.
- Ⓜ Guthman Inc., Edwin I., 15 S. Throop St., Chicago, Ill.
- Ⓜ HIGHLAND ENGINEERING CO., Main St. & Urban Ave., Westbury, N. Y. ADV. PG. 360.
- Ⓜ Inductive Equipment Co., Gettysburg, Pa.
- Ⓜ Leonard Electric Products Co., Inc., 1562 61st St., Brooklyn 19, N. Y.
- Ⓜ Loral Electronics Corp., 794 E. 140th St., New York 54, N. Y.

- Ⓜ Melpar, Inc., 552 Swann Ave., Alexandria, Va.
- Ⓜ MID-WEST COIL & TRANSFORMER CO., 1642 N. Halsted St., Chicago 14, Ill. ADV. PG. 165.
- Ⓜ PARMEKO LTD., 366 Madison Ave., New York 17, N. Y. ADV. PG. 336.
- Ⓜ Peerless Electrical Products Co., Div. of Altec-Lansing Corp., 6920 McKinley Ave., Los Angeles 1, Calif.
- Ⓜ Phelps Dodge Copper Products Corp., 40 Wall St., New York 5, N. Y.
- Ⓜ Red Arrow Electric Corp., 100 Coit St., Irvington 11, N. J.
- Ⓜ Richmond Engineering Co., Inc., 48 Water St., South Norwalk, Conn.
- Ⓜ Rollan Electrical Co., 8020 S. South Park, Chicago, Ill.
- Ⓜ Sag Harbor Industries, Inc., Bay St., Sag Harbor, N. Y.
- Ⓜ SPERRY GYROSCOPE CO., Div. of The Sperry Corp., Great Neck, N. Y. ADV. PG. 103, 104.
- Ⓜ STANDARD TRANSFORMER CORP., Elston, Kedzie & Addison, Chicago 18, Ill. ADV. PG. 144.
- Ⓜ Stanwyck Winding Co., 137 Walsh Ave., Newburgh, N. Y.
- Ⓜ Super Electric Products Corp., 46 Oliver St., Newark, N. J.
- Ⓜ Tartak-Stolle Electronics, Inc., 3970 S. Grand Ave., Los Angeles 37, Calif.
- Ⓜ Tetrad Co., 4921 Exposition Blvd., Los Angeles 16, Calif.
- Ⓜ Thordarson-Meissner Mfg. Divs., 500 W. Huron St., Chicago 10, Ill.
- Ⓜ Transformer Engineers, 389 S. Arroyo Parkway, Pasadena, Calif.
- Ⓜ Trenton Transformer Corp., P. O. Box 568, Trenton, N. J.
- Ⓜ Triad Transformer Mfg. Co., 2254 Sepulveda Blvd., Los Angeles 64, Calif.
- Ⓜ U. S. ELECTRONICS CORP.; 276 Warren St., Lyndhurst, N. J. ADV. PG. 76.

COILS—r-f & i-f Receiving or Transmitting

- Ⓜ ACME ELECTRONICS, INC., 300 N. Lake Ave., Pasadena 4, Calif. ADV. PG. 182.
- Ⓜ Aero Coil Inc., 507-26th St., Union City, N. J.
- Ⓜ AEROLITE ELECTRONIC HARDWARE CORP., 507 26th St., Union City, N. J. ADV. PG. 355.
- Ⓜ Associated Production Co., 162 N. Clinton St., Chicago 6, Ill.
- Ⓜ Atlas Coil Winders, Inc., Stamford, Conn.
- Ⓜ BARKER & WILLIAMSON, 235 Fairfield Ave., Upper Darby, Pa. ADV. PG. 292.
- Ⓜ BOND ELECTRONICS CORP., 88 Franklin Place, Summit, N. J. ADV. PG. 403.
- Ⓜ Bud Radio, Inc., 2118 E. 55th St., Cleveland 3, Ohio.
- Ⓜ Bunnell & Co., J. H., 81 Prospect St., Brooklyn, N. Y.
- Ⓜ CADDELL-BURNS MFG. CO., 40 E. Second St., Mineola, N. Y. ADV. PG. 224.
- Ⓜ CAMBRIDGE THERMIONIC CORP., 445 Concord Ave., Cambridge 38, Mass. ADV. PG. 37.
- Ⓜ CENTRONICS CO., 5065 Broadway, New York, N. Y. ADV. PG. 364.
- Ⓜ Clippard Instrument Laboratory, Inc., 1125 Bank St., Cincinnati 14, Ohio.
- Ⓜ Coil Winders, Inc., 61 Bergen St., Brooklyn 2, N. Y.
- Ⓜ COILCRAFT, INC., 3716 N. Cicero Ave., Chicago 41, Ill. ADV. PG. 360.
- Ⓜ DX Radio Products Co., Inc., 2304 Armitage Ave., Chicago 47, Ill.
- Ⓜ Delco Radio Div., General Motors Corp., Kokomo, Ind.
- Ⓜ DIETZ DESIGN & MFG. CO., Grandview 6, Mo. ADV. PG. 323.
- Ⓜ DuMont Laboratories, Inc., Allen B., Electronic Parts Div., 35 Market St., East Paterson, N. J.
- Ⓜ ELECTRONIC COILS, INC., P. O. Box 1641, 44 Taylor St., Springfield, Mass. ADV. PG. 400.
- Ⓜ ELECTRONIC DESIGNS, INC., 28-30 School St., Yonkers, N. Y. ADV. PG. 332.
- Ⓜ Electronic Indicator Corp., 259 Green St., Brooklyn 22, N. Y.
- Ⓜ Electronic Surgical Equipment Co., Inc., N. E. Cor. 23 & Arch Sts., Philadelphia 3, Pa.
- Ⓜ Ensign Coil Co., 2516 S. Pulaski Rd., Chicago, Ill.
- Ⓜ Essex Electronics, Berkeley Heights, N. J.
- Ⓜ FUGLE-MILLER LABORATORIES, INC., 399 Main St., Metuchen, N. J. ADV. PG. 218.
- Ⓜ Guthman Inc., Edwin I., 15 S. Throop St., Chicago, Ill.
- Ⓜ HARNETT ELECTRIC CORP., 138 Haven Ave., Port Washington, L. I., N. Y. ADV. PG. 399.
- Ⓜ HILLBURN ELECTRONIC PRODUCTS CO., 55 Nassau Ave., Brooklyn 22, N. Y. ADV. PG. 362.
- Ⓜ HOULIHAN CO., T. J., 2508-14 W. Lawrence Ave., Chicago 25, Ill. ADV. PG. 336.
- Ⓜ Inductive Equipment Co., Gettysburg, Pa.
- Ⓜ Insuline Corp. of America, 36-02 35th Ave., Long Island City, N. Y.
- Ⓜ JOHNSON CO., E. F., Waseca, Minn. ADV. PG. 118, 121.
- Ⓜ Leonard Electric Products Co., Inc., 1562 61st St., Brooklyn, N. Y.
- Ⓜ LEWIS SPRING & MFG. CO., 2646 W. North Ave., Chicago 47, Ill. ADV. PG. 293.
- Ⓜ Loral Electronics Corp., 794 E. 140th St., New York 54, N. Y.
- Ⓜ Measurement Engineering, Ltd., Arncliffe, Ontario, Canada.
- Ⓜ MEASUREMENTS CORP., Boonton, N. J. ADV. PG. 99.
- Ⓜ Millen Mfg. Co., James, 150 Exchange St., Malden, Mass.

- Ⓜ Miller Co., J. W., 5917 S. Main St., Los Angeles 3, Calif.
- Ⓜ Monroe Coil Co., 2839 N. Narragansett Ave., Chicago 34, Ill.
- Ⓜ Muter Co., 1255 S. Michigan Ave., Chicago, Ill.
- Ⓜ NATIONAL CO., INC., 61 Sherman St., Malden 48, Mass. ADV. PG. 280, 281.
- Ⓜ Phelps Dodge Copper Products Corp., 40 Wall St., New York 5, N. Y.
- Ⓜ Pilot Radio Corp., 37-06 36th St., Long Island City 1, N. Y.
- Ⓜ Radex Corp., 2076 N. Elston Ave., Chicago 14, Ill.
- Ⓜ Reliable Spring & Wire Forms Co., Fulton Rd. & Paris Ave., Cleveland 9, Ohio.
- Ⓜ Ross Mfg. Co., 860 Washington St., Burlington, Iowa.
- Ⓜ Sickles Co., F. W., 165 Front St., Chicopee, Mass.
- Ⓜ SPELLMAN TELEVISION CO., INC., 3029 Webster Ave., New York 67, N. Y. ADV. PG. 277.
- Ⓜ SPERRY GYROSCOPE CO. DIV. OF THE SPERRY CORP., Great Neck, N. Y. ADV. PG. 103, 104.
- Ⓜ STANDARD COIL PRODUCTS CO., 2329 N. Pulaski Rd., Chicago 39, Ill. ADV. PG. 97.
- Ⓜ Standard Winding Corp., 44-62 Johnes St., Newburgh, N. Y.
- Ⓜ Stanwyck Winding Co., 137 Walsh Ave., Newburgh, N. Y.
- Ⓜ Summit Coil Co., 67 Union Pl., Summit, N. J.
- Ⓜ Super Electric Products Corp., 46 Oliver St., Newark, N. J.
- Ⓜ Teleradio Engineering Corp., 99 Wall St., New York 5, N. Y.
- Ⓜ TEL-RAD MFG. CO., INC., 7th & Madison St., Fennimore, Wis. ADV. PG. 412.
- Ⓜ Tetrad Co., 4921 Exposition Blvd., Los Angeles 16, Calif.
- Ⓜ Thordarson-Meissner Mfg. Divs., 500 W. Huron St., Chicago 10, Ill.
- Ⓜ U. S. ELECTRONICS CORP., 276 Warren St., Lyndhurst, N. J. ADV. PG. 76.
- Ⓜ Vokar Corp., 7300 Huron River Drive, Dexter, Mich.
- Ⓜ WEBSTER SPRING CORP., 176-182 Johnson St., Brooklyn 1, N. Y. ADV. PG. 394.

COILS—Relay & Solenoid

See Coils, Magnet

COILS—Speaker

- Ⓜ Acme Wire Co., New Haven 14, Conn.
- Ⓜ Aero Coil Inc., 507-26th St., Union City, N. J.
- Ⓜ AEROLITE ELECTRONIC HARDWARE CORP., 507 26th St., Union City, N. J. ADV. PG. 355.
- Ⓜ Altec Lansing Corp., 9356 Santa Monica Blvd., Beverly Hills, Calif.
- Ⓜ Associated Production Co., 162 N. Clinton St., Chicago 6, Ill.
- Ⓜ Best Mfg. Co., Inc., 1200 Grove St., Irvington 11, N. J.
- Ⓜ Carron Mfg. Co., 415 S. Aberdeen St., Chicago, Ill.
- Ⓜ COILCRAFT, INC., 3716 N. Cicero Ave., Chicago 41, Ill. ADV. PG. 360.
- Ⓜ DX Radio Products Co., Inc., 2304 Armitage Ave., Chicago 47, Ill.
- Ⓜ DANO ELECTRIC CO., Main St., Winsted, Conn. ADV. PG. 266.
- Ⓜ Davis & Co., Inc., Dean W., 3418 N. Milwaukee Ave., Chicago, Ill.
- Ⓜ Delco Radio Div., General Motors Corp., Kokomo, Ind.
- Ⓜ ELECTRONIC COILS, INC., P. O. Box 1641, 44 Taylor St., Springfield, Mass. ADV. PG. 400.
- Ⓜ Electronic Products Div., Epco Products, Inc., 2430 Atlantic Ave., Brooklyn 22, N. Y.
- Ⓜ Ensign Coil Co., 2516 S. Pulaski Rd., Chicago, Ill.
- Ⓜ Guthman Inc., Edwin I., 15 S. Throop St., Chicago, Ill.
- Ⓜ HEPPNER MFG. CO., P. O. Box 612, Round Lake, Ill. ADV. PG. 413.
- Ⓜ Holl Audio Industries, 9215 Venice Blvd., Los Angeles 34, Calif.
- Ⓜ Inductive Equipment Co., Gettysburg, Pa.
- Ⓜ Magnetic Windings, Div., Essex Wire Corp., Freemansburg Ave. & Hobson Blvd., Easton, Pa.
- Ⓜ MID-WEST COIL & TRANSFORMER CO., 1642 N. Halsted St., Chicago 14, Ill. ADV. PG. 165.
- Ⓜ Molded Insulation Co., 335 E. Price St., Philadelphia 44, Pa.
- Ⓜ Peerless Electrical Products Co., Div. of Altec-Lansing Corp., 6920 McKinley Ave., Los Angeles 1, Calif.
- Ⓜ Phelps Dodge Copper Products Corp., 40 Wall St., New York 5, N. Y.
- Ⓜ Television Laboratories, Inc., 5045 W. Lake St., Chicago 44, Ill.
- Ⓜ Tetrad Co., 4921 Exposition Blvd., Los Angeles 16, Calif.
- Ⓜ Triad Transformer Mfg. Co., 2254 Sepulveda Blvd., Los Angeles 64, Calif.
- Ⓜ U. S. ELECTRONICS CORP., 276 Warren St., Lyndhurst, N. J. ADV. PG. 76.

COILS—Television Focusing

- Ⓜ A.P.W. Co., 72 W. Main St., Rockaway, N. J.
- Ⓜ Aero Coil Inc., 507 26th St., Union City, N. J.
- Ⓜ Associated Production Co., 162 N. Clinton St., Chicago 6, Ill.

V indicates . . . IN PRODUCTION • AVAILABILITY • UNRESTRICTED FOR GENERAL USE

- BARKER & WILLIAMSON**, 235 Fairfield Ave., Upper Darby, Pa. ADV. PG. 292.
Best Mfg. Co., Inc., 1200 Grove St., Irvington 11, N. J.
 Coil Winders Inc., 61 Bergen St., Brooklyn 2, N. Y.
DANO ELECTRIC CO., Main St., Winsted, Conn. ADV. PG. 266.
Davis & Co., Inc., Dean W., 3418 N. Milwaukee Ave., Chicago, Ill.
 Davis Electric Co., Cape Girardeau, Mo.
ELECTRO ACOUSTIC INDUSTRIES, LTD., 366 Madison Ave., New York 17, N. Y. ADV. PG. 336.
Empire Coil Co., Inc., Beechwood Ave. & Second St., New Rochelle, N. Y.
Ensign Coil Co., 2516 S. Pulaski Rd., Chicago, Ill.
GLASER-STEERS CORP., 2 Main St., Belleville 9, N. J. ADV. PG. 359.
GUARDIAN ELECTRIC MFG. CO., 1621 W. Walnut St., Chicago 12, Ill. ADV. PG. 147.
 Guthman Inc., Edwin I., 15 S. Throop St., Chicago, Ill.
HARNETT ELECTRIC CORP., 138 Haven Ave., Port Washington, L. I., N. Y. ADV. PG. 399.
I-T-E Circuit Breaker Co., 19th & Hamilton Sts., Philadelphia 30, Pa.
 Inductive Equipment Co., Gettysburg, Pa.
Magnetic Windings Div., Essex Wire Corp., Freemansburg Ave. & Hobson Blvd., Easton, Pa.
Merit Transformer Corp., 4427 N. Clark St., Chicago 40, Ill.
 Monroe Coil Co., 2839 N. Narragansett Ave., Chicago 34, Ill.
Peerless Electrical Products Co., Div. of Altec-Lansing Corp., 6920 McKinley Ave., Los Angeles 1, Calif.
Phelps Dodge Copper Products Corp., 40 Wall St., New York 5, N. Y.
Philo Corp., Tioga & C Sts., Philadelphia 34, Pa.
 ROLLAN Electrical Co., 8020 S. South Park, Chicago, Ill.
STANDARD TRANSFORMER CORP., Eiston, Kedzie & Addison, Chicago 18, Ill. ADV. PG. 144.
Super Electric Products Corp., 46 Oliver St., Newark, N. J.
Tartak-Stolle Electronics, Inc., 3970 S. Grand Ave., Los Angeles 37, Calif.
Teleradio Engineering Corp., 99 Wall St., New York 5, N. Y.
TEL-RAD MFG. CO., INC., 7th & Madison St., Fennimore, Wis. ADV. PG. 412.
Television Laboratories, Inc., 5045 W. Lake St., Chicago 44, Ill.
Tetrad Co., 4921 Exposition Blvd., Los Angeles 16, Calif.
Triad Transformer Mfg. Co., 2254 Sepulveda Blvd., Los Angeles 64, Calif.
U. S. ELECTRONICS CORP., 276 Warren St., Lyndhurst, N. J. ADV. PG. 76.

COILS—Toroidal

- A.P.W. Co.**, 72 W. Main St., Rockaway, N. J.
ACME ELECTRONICS, INC., 300 N. Lake Ave., Pasadena 4, Calif. ADV. PG. 182.
Aero Coil Inc., 507 26th St., Union City, N. J.
ALDEN PRODUCTS CO., 117 N. Main St., Brockton 64, Mass. ADV. PG. 327.
 Associated Production Co., 162 N. Clinton St., Chicago 6, Ill.
BARKER & WILLIAMSON, 235 Fairfield Ave., Upper Darby, Pa. ADV. PG. 292.
Best Mfg. Co., 1200 Grove St., Irvington 11, N. J.
BOGUE ELECTRIC MFG. CO., 52 Iowa Ave., Paterson 3, N. J. ADV. PG. 155.
BOND ELECTRONICS CORP., 88 Franklin Place, Summit, N. J. ADV. PG. 403.
BURNELL & CO., 45 Warburton Ave., Yonkers 2, N. Y. ADV. PG. 75.
C. G. S. LABORATORIES, INC., 391 Ludlow St., Stamford, Conn. ADV. PG. 389.
 Coil Winders, Inc., 61 Bergen St., Brooklyn 2, N. Y.
COMMUNICATION ACCESSORIES CO., Box 345, 110th St. & Hillcrest Rd., Hickman Hills, Missouri. ADV. PG. 168.
Connecticut Telephone & Electric Corp., 70 Britania St., Meridan, Conn.
Coto-Coil Co., Inc., 65 Pavilion Ave., Providence 5, R. I.
DX Radio Products Co., Inc., 2324 Armitage Ave., Chicago 47, Ill.
DECOURSEY ENGINEERING LAB., P. O. Box 235, Los Angeles 25, Calif. ADV. PG. 174.
DIETZ DESIGN & MFG. CO., Grandview 6, Mo. ADV. PG. 323.
Douglas-Randall, Inc., 102 High St., Westerly, R. I.
 Electronic Products Div., Epco Products, Inc., 2430 Atlantic Ave., Brooklyn 33, N. Y.
ELECTRONIC TRANSFORMER CO., INC., 215 W. 25th St., New York, N. Y. ADV. PG. 278.
Filtrol Co., Inc., 131-05 Fowler Ave., Flushing, N. Y.
FREED TRANSFORMER CO., INC., 1736 Weirfield St., Brooklyn 27, N. Y. ADV. PG. 149.
GLASER-STEERS CORP., 2 Main St., Belleville 9, N. J. ADV. PG. 359.
Guthman Inc., Edwin I., 15 S. Throop St., Chicago, Ill.
HEPPNER MFG. CO., P. O. Box 612, Round Lake, Ill. ADV. PG. 413.
Hycor Co., Inc., 11423 Vanowen St., North Hollywood, Calif.
 Inductive Equipment Co., Gettysburg, Pa.

- LENKURT ELECTRIC CO., INC.**, San Carlos, Calif. ADV. PG. 412.
 Leonard Electric Products Co., Inc., 1562 61st St., Brooklyn 19, N. Y.
Lynch Co., F. W., 96 Jessie St., San Francisco, Calif.
MICO INSTRUMENT CO., 76 Trowbridge St., Cambridge 38, Mass. ADV. PG. 381.
PARMEKO LTD., 366 Madison Ave., New York 17, N. Y. ADV. PG. 336.
Phelps Dodge Copper Products Corp., 40 Wall St., New York 5, N. Y.
Railway Communications, Inc., P. O. Box 1783, Lincoln, Nebr.
Standard Telephones & Cables, Ltd., Connaught House, Aldwych, London, W.C. 2, England.
Tartak-Stolle Electronics, Inc., 3970 S. Grand Ave., Los Angeles 37, Calif.
Television Laboratories, Inc., 5045 W. Lake St., Chicago 44, Ill.
Tetrad Co., 4921 Exposition Blvd., Los Angeles 16, Calif.
Torocoi Co., 1002 Blendon Ave., Richmond Heights, Mo.
Transformer Engineers, 389 S. Arroyo Parkway, Pasadena, Calif.
Triad Transformer Mfg. Co., 2254 Sepulveda Blvd., Los Angeles 64, Calif.
U. S. ELECTRONICS CORP., 276 Warren St., Lyndhurst, N. J. ADV. PG. 76.
UNITED TRANSFORMER CO., 150 Varick St., New York 13, N. Y. ADV. PG. Inside Front Cover.
UNIVERSAL MFG. CO., INC., 410 Hillside Ave., Hillside, N. J. ADV. PG. 385.
WESTINGHOUSE ELECTRIC CORP., 511 Wood St., P. O. Box 868, Pittsburgh 30, Pa. ADV. PG. 107-113.

COILS—Transformer Coils & Windings

- A.P.W. Co.**, 72 W. Main St., Rockaway, N. J.
Acme Wire Co., New Haven 14, Conn.
Acro Products Co., 215 Arch St., Philadelphia 6, Pa.
Acro Transformer Mfg. Corp., 26-02 4th St., Astoria 2, N. Y.
Aero Coil Inc., 507 26th St., Union City, N. J.
AIRDESIGN, INC., 241 Fairfield Ave., Upper Darby, Pa. ADV. PG. 368.
AIRPAX PRODUCTS CO., Middle River, Baltimore 20, Md. ADV. PG. 289.
ALLIED CONTROL CO., INC., 2 East End Ave., New York 23, N. Y. ADV. PG. 62, 63.
Altec Lansing Corp., 9356 Santa Monica Blvd., Beverly Hills, Calif.
 Associated Production Co., 162 N. Clinton St., Chicago 6, Ill.
Atlas Coil Winders, Inc., Stamford, Conn.
Aurex Corp., Chicago 10, Ill.
Best Mfg. Co., Inc., 1200 Grove St., Irvington 11, N. J.
BOGUE ELECTRIC MFG. CO., 52 Iowa Ave., Paterson 3, N. J. ADV. PG. 155.
BOND ELECTRONICS CORP., 88 Franklin Place, Summit, N. J. ADV. PG. 403.
CHICAGO TRANSFORMER DIV., Essex Wire Corp., 3501 W. Addison St., Chicago 18, Ill. ADV. PG. 205.
 Coil Winders, Inc., 61 Bergen St., Brooklyn 2, N. Y.
COLLCRAFT, INC., 3716 N. Cicero Ave., Chicago 41, Ill. ADV. PG. 360.
COMAR ELECTRIC CO., 3349 W. Addison St., Chicago 18, Ill. ADV. PG. 335.
Coto-Coil Co., Inc., 65 Pavilion Ave., Providence 5, R. I.
Crest Transformer Corp., 1834-36 W. North Ave., Chicago 22, Ill.
DANO ELECTRIC CO., Main St., Winsted, Conn. ADV. PG. 266.
Davis & Co., Inc., Dean W., 3418 N. Milwaukee Ave., Chicago, Ill.
 Davis Electric Co., Cape Girardeau, Mo.
Delco Radio Div., General Motors Corp., Kokomo, Ind.
DIETZ DESIGN & MFG. CO., Grandview 6, Mo. ADV. PG. 323.
Dormitzer Electric Co., Inc., 89 Brighton Ave., Boston 34, Mass.
Douglas-Randall, Inc., 102 High St., Westerly, R. I.
Durakool, Inc., 1010 N. Main St., Elkhart, Ind.
Eastern Specialty Co., Philadelphia 40, Pa.
Ecco High Frequency Corp., 7020 Hudson Blvd., North Bergen, N. J.
Ewards Co., Inc., 86 Boston Post Rd., Norwalk, Conn.
EISLER ENGINEERING CO., INC., 740 S. 13th St., Newark 3, N. J. ADV. PG. 378.
 Electron Mfg. Co., 1901 N. Clybourn, Chicago, Ill.
Electrical Windings, Inc., 2015 N. Kolmar Ave., Chicago 39, Ill.
 Electricoil Transformer Co., Westerly Rd., Ossining, N. Y.
 Electronic Products Div., Epco Products, Inc., 2430 Atlantic Ave., Brooklyn 33, N. Y.
Electronic Surgical Equipment Co., Inc., N.E. Cor. 23 & Arch Sts., Philadelphia 3, Pa.
ELECTRONIC TRANSFORMER CO., INC., 215 W. 25th St., New York, N. Y. ADV. PG. 278.
Empire Coil Co., Inc., Beechwood Ave. & Second St., New Rochelle, N. Y.

- Ensign Coil Co.**, 2516 S. Pulaski Rd., Chicago, Ill.
Essex Electronics, Berkeley Heights, N. J.
Etraco Mfg. Co., Inc., Woods Church Rd., Flemington, N. J.
FERRANTI ELECTRIC, INC., 30 Rockefeller Plaza, New York 20, N. Y. ADV. PG. 159.
FREED TRANSFORMER CO., INC., 1736 Weirfield St., Brooklyn 27, N. Y. ADV. PG. 149.
Gardner Electric Mfg. Co., 4227 Hollis St., Emeryville 8, Calif.
Gaveco Labs., Inc., 2 East End Ave., New York 21, N. Y.
General Transformer Co., 18240 Harwood Ave., Homewood, Ill.
GRAMER TRANSFORMER CO., 2734 N. Pulaski Rd., Chicago 39, Ill. ADV. PG. 383.
 Guthman Inc., Edwin I., 15 S. Throop St., Chicago, Ill.
HIGHLAND ENGINEERING CO., Main St. & Urban Ave., Westbury, N. Y. ADV. PG. 360.
 Inductive Equipment Co., Gettysburg, Pa.
 Leonard Electric Products Co., Inc., 1562 61st St., Brooklyn 19, N. Y.
Magnetic Windings Div., Essex Wire Corp., Freemansburg Ave. & Hobson Blvd., Easton, Pa.
Melco Products, Inc., 22 E. Hennepin Ave., Minneapolis 1, Minn.
Melpar, Inc., 552 Swann Ave., Alexandria, Va.
MID-WEST COIL & TRANSFORMER CO., 1642 N. Halsted St., Chicago 14, Ill. ADV. PG. 165.
Miller Co., J. W., 5917 S. Main St., Los Angeles 3, Calif.
PARMEKO LTD., 366 Madison Ave., New York 17, N. Y. ADV. PG. 336.
Peerless Electrical Products Co., Div. of Altec-Lansing Corp., 6920 McKinley Ave., Los Angeles 1, Calif.
PERMOFLUX CORP., 4900 W. Grand Ave., Chicago 33, Ill. ADV. PG. 321.
Phelps Dodge Copper Products Corp., 40 Wall St., New York 5, N. Y.
Presto Electric Co., Inc., 4513 New York Ave., Union City, N. J.
Radionic Transformer Co., 411 S. Sangamon St., Chicago 7, Ill.
Red Arrow Electric Corp., 100 Coit St., Irvington 11, N. J.
Richmond Engineering Co., Inc., 48 Water St., South Norwalk, Conn.
Rola Co., Inc., 2530 Superior Ave., Cleveland 14, Ohio.
 Rollan Electrical Co., 8020 S. South Park, Chicago, Ill.
Sag Harbor Industries, Inc., Bay St., Sag Harbor, N. Y.
SPERRY GYROSCOPE CO., Div. of The Sperry Corp., Great Neck, N. Y. ADV. PG. 103, 104.
STANDARD TRANSFORMER CORP., Elston, Kedzie & Addison, Chicago 18, Ill. ADV. PG. 144.
Stanwyck Winding Co., 137 Walsh Ave., Newburgh, N. Y.
Sun Copper & Wire Co., 132 Beckwith Ave., Paterson, N. J.
Super Electric Products Corp., 46 Oliver St., Newark, N. J.
Tartak-Stolle Electronics, Inc., 3970 S. Grand Ave., Los Angeles 37, Calif.
Teleradio Engineering Corp., 99 Wall St., New York 5, N. Y.
Tetrad Co., 4921 Exposition Blvd., Los Angeles 16, Calif.
Ther Electric & Machine Works, 15 S. Jefferson St., Chicago, Ill.
Thordarson-Meissner Mfg. Divs., 500 W. Huron St., Chicago 10, Ill.
Transformer Engineers, 389 S. Arroya Parkway, Pasadena, Calif.
Trenton Transformer Corp., P. O. Box 568, Trenton, N. J.
Triad Transformer Mfg. Co., 2254 Sepulveda Blvd., Los Angeles 64, Calif.
UNION ELECTRIC PRODUCTS CO., 24 Edison Pl., Newark 2, N. J. ADV. PG. 60.
U. S. ELECTRONICS CORP., 276 Warren St., Lyndhurst, N. J. ADV. PG. 76.
Weymouth Instrument Co., 1440 Commercial St., East Weymouth 89, Mass.

COILS—Width Control

- Aero Coil Inc.**, 507-26th St., Union City, N. J.
AEROLITE ELECTRONIC HARDWARE CORP., 507 26th St., Union City, N. J. ADV. PG. 355.
BOND ELECTRONICS CORP., 88 Franklin Place, Summit, N. J. ADV. PG. 403.
CADELL-BURNS MFG. CO., 40 E. Second St., Minneola, N. Y. ADV. PG. 224.
CENTRONICS CO., 5065 Broadway, New York, N. Y. ADV. PG. 364.
Clippard Instrument Laboratory, Inc., 1125 Bank St., Cincinnati 14, Ohio.
COLLCRAFT, INC., 3716 N. Cicero Ave., Chicago 41, Ill. ADV. PG. 360.
 Coil Winders, Inc., 61 Bergen St., Brooklyn 2, N. Y.
DIETZ DESIGN & MFG. CO., Grandview 6, Mo. ADV. PG. 323.
Empire Coil Co., Inc., Beechwood Ave. & Second St., New Rochelle, N. Y.

Ⓢ indicates . . . IN PRODUCTION • AVAILABILITY • UNRESTRICTED FOR GENERAL USE

- ⓈEssex Electronics, Berkeley Heights, N. J.
- ⓈFUGLE-MILLER LABORATORIES, INC., 399 Main St., Metuchen, N. J. ADV. PG. 218.
- Guthman Inc., Edwin I., 15 S. Throop St., Chicago, Ill.
- ⓈHILLBURN ELECTRONIC PRODUCTS CO., 55 Nassau Ave., Brooklyn 22, N. Y. ADV. PG. 362.
- ⓈHOULIHAN CO., T. J., 2508-14 W. Lawrence Ave., Chicago 25, Ill. ADV. PG. 336.
- Leonard Electric Products Co., Inc., 1562 61st St., Brooklyn, N. Y.
- M. P. Concert Installations, Fairfield 10, Conn.
- ⓈMerit Transformer Corp., 4427 N. Clark St., Chicago 40, Ill.
- ⓈMiller Co., J. W., 5917 S. Main St., Los Angeles 3, Calif.
- ⓈPhilco Corp., Tioga & C Sts., Philadelphia 34, Pa.
- ⓈRADIO CORP. OF AMERICA, Tube Dept., Harrison, N. J. ADV. PG. 177, Inside Back and Back Cover.
- Ross Mfg. Co., 860 Washington St., Burlington, Iowa.
- Sickles Co., F. W. 165 Front St., Chicopee, Mass.
- ⓈSTANDARD COIL PRODUCTS CO., 2329 N. Pulaski Rd., Chicago 39, Ill. ADV. PG. 97.
- ⓈStandard Winding Co., 44-62 Johns St., Newburgh, N. Y.
- ⓈStanwyck Winding Co., 137 Walsh Ave., Newburg, N. Y.
- ⓈSummit Coil Co., 67 Union Pl., Summit, N. J.
- ⓈTartak-Stolle Electronics, Inc., 3970 S. Grand Ave., Los Angeles 37, Calif.
- ⓈTEL-RAD MFG. CO., INC., 7th & Madison St., Fennimore, Wis. ADV. PG. 412.
- ⓈTeledio Engineering Corp., 99 Wall St., New York, N. Y.
- ⓈTetrad Co., 4921 Exposition Blvd., Los Angeles 16, Calif.
- ⓈThordarson-Meissner Mfg. Divs., 500 W. Huron St., Chicago 10, Ill.
- ⓈU. S. ELECTRONICS CORP., 276 Warren St., Lyndhurst, N. J. ADV. PG. 76.

COLORIMETERS—Photoelectric

- ⓈAirllectron Inc., P. O. Box 151, Caldwell, N. J.
- American Instrument Co., 8030 Georgia Ave., Silver Spring, Md.
- ⓈBeckman Instruments, Inc., 820 Mission St., South Pasadena, Calif.
- ⓈBrociner Electronics Laboratory, 1546 Second Ave., New York 28, N. Y.
- ⓈColeman Instruments, Inc., 318 Madison St., Maywood, Ill.
- ⓈFarrand Optical Co., Inc., Bronx Blvd. at 238th St., New York 70, N. Y.
- ⓈFisher Scientific Co., 717 Forbes St., Pittsburgh 19, Pa.
- ⓈGENERAL ELECTRIC CO., Schenectady 5, N. Y. ADV. PG. 1 to 22.
- ⓈInstrument Development Laboratories, Inc., 163 Highland Ave., Needham Heights, Mass.
- ⓈPhotobell Company, 116 Nassau St., New York 7, N. Y.
- ⓈPhotovolt Corp., 95 Madison Ave., New York 16, N. Y.
- Process & Instruments, 60 Greenpoint Ave., Brooklyn 22, N. Y.
- ⓈRubicon Co., 3761 Ridge Ave., Philadelphia 29, Pa.

COLUMBIUM See Metals

COMMUNICATION SYSTEMS

1. Aircraft
2. Airport Traffic Control
3. Carrier Current
4. Facsimile
5. Induction
6. Marine Radio-Telephone
7. Microwave
8. Portable Installation
9. Radioteletype
10. Railroad
11. Vehicular

- ⓈAcme Electronix Div. of NEA Service Inc., West Third & Lakeside, Cleveland 13, Ohio. 4.
- ⓈAeronautical Communication Equipment, Inc., 3090 Douglas Rd., Miami 33, Fla. 1.
- ⓈAIR ASSOCIATES, INC., Teterboro, N. J. 1-2-4-6-9. ADV. PG. 211.
- ⓈALDEN PRODUCTS CO., 117 N. Main St., Brockton 64, Mass. 4. ADV. PG. 327.
- ⓈAMERICAN ELECTROENGINEERING CORP., 5025-29 W. Jefferson Blvd., Los Angeles 16, Calif. 7-11. ADV. PG. 136.
- ⓈAutomatic Electric Sales Corp., 1033 W. Van Buren St., Chicago 7, Ill. 3.
- ⓈAvion Instrument Corp., Paramus, N. J. 1.
- ⓈBARKER & WILLIAMSON, 235 Fairfield Ave., Upper Darby, Pa. 4-9-11. ADV. PG. 292.
- ⓈBassett Inc., Rex, 307-11 N. W. First Ave., Fort Lauderdale, Fla. 1-2-6.
- ⓈBendix Radio Division, Bendix Aviation Corp., Baltimore 4, Md. 1-2-6-8-10-11.

- ⓈBludworth Marine Div., National Simplex-Bludworth, Inc., 92 Gold St., New York 38, N. Y. 6.
- ⓈBrelco Electronics Corp., 55 Vandam St., New York 13, N. Y. 3.
- Bunnell & Co., J. H., 215 Fulton St., New York, N. Y. 1-2-3-4-6-7-8-9-10.
- ⓈCapehart-Farnsworth Corp., Fort Wayne, Indiana. 10.
- ⓈCollins Radio Co., Cedar Rapids, Iowa. 1-9.
- ⓈCommunications Co., Inc., 300 Greco Ave., Coral Gables 34, Fla., 1-2-6-8-10-11.
- ⓈCossor (Canada) Ltd., 301-303 Windsor St., Halifax, N. S., Canada. 1.
- ⓈDAVEN CO., 191 Central Ave., Newark 4, N. J. 2. ADV. PG. 157.
- ⓈDoolittle Radio, Inc., 7421 S. Loomis Blvd., Chicago 36, Ill. 8.
- ⓈElectronic Surgical Equipment Co., Inc., N. E. Cor. 23 & Arch Sts., Philadelphia 3, Pa. 8
- Elm Laboratories, 18 South Broadway, Dobbs Ferry, N. Y. 8.
- Erco Radio Labs., Inc., East Stewart Ave., Garden City, N. Y. 2-6-8-9.
- Espey Mfg. Co., Inc., 528 E. 72nd St., New York, N. Y. 4.
- ⓈFEDERAL TELECOMMUNICATION LABS., INC., 500 Washington Ave., Nutley, N. J. 7. ADV. PG. 164.
- ⓈFEDERAL TELEPHONE & RADIO CORP., 88 Kingsland Rd., Clifton, N. J. 2-3-7-10-11. ADV. PG. 161-163.
- ⓈFinch Telecommunications, Inc., Passaic, N. J. 4.
- ⓈFisher Research Lab., 1961 University Ave., Palo Alto, Calif. 6.
- ⓈGalbraith & Son Electric Corp., C. C., 450 Sixth Ave., New York 11, N. Y. 8.
- ⓈGates Radio Co., Quincy, Ill. 6-8.
- ⓈGENERAL ELECTRIC CO., Schenectady 5, N. Y. ADV. PG. 1 to 22.
- ⓈGodfrey Mfg. Co., 171 S. 2nd St., Milwaukee 4, Wis. 8.
- ⓈHammarlund Mfg. Co., 460 W. 34th St., New York 1, N. Y. 3-7-11.
- ⓈHEINTZ & KAUFMAN EQUIPMENT DIV. OF THE ROBERT DOLLAR CO., 50 Drumm St., San Francisco 11, Calif. 2-6-9-11. ADV. PG. 301.
- ⓈHogan Laboratories, Inc., 155 Perry St., New York 14, N. Y. 4.
- Hose-McCann Telephone Co., Inc., 25th St. & 3rd Ave., Brooklyn 32, N. Y. 6.
- ⓈIntervox Corp., 2701 California Ave., Seattle 6, Wash. 6.
- Jarvis Electronics Corp., 6058 W. Fullerton Ave., Chicago 39, Ill. 1.
- ⓈJefferson, Inc., Ray, 40 E. Merrick Rd., Freeport, N. Y. 6.
- ⓈKaar Engineering Co., 2995 Middlefield Road, P. O. Box 1320, Palo Alto, Calif. 6-11.
- ⓈLENKURT ELECTRIC CO., INC., San Carlos, Calif. 3. ADV. PG. 412.
- Loral Electronics Corp., 794 E. 140th St., New York 54, N. Y. 1.
- ⓈLynch Co., F. W., 96 Jessie St., San Francisco, Calif. 3.
- ⓈMARCONI INSTRUMENTS, LTD., 23 Beaver St., New York 4, N. Y. 1-8. ADV. PG. 270.
- ⓈMcElroy Mfg. Corp., Littleton, Mass. 4-9.
- ⓈMeasurement Engineering, Ltd., Arnprior, Ontario, Canada. 6-11.
- ⓈMITCHELL INDUSTRIES, INC., Camp Wolters, Mineral Wells, Texas 1. ADV. PG. 298.
- ⓈMonarch Radio & Television Corp., 2430 Atlantic Ave., Brooklyn 33, N. Y. 1-2-11.
- ⓈMuirhead & Co., Ltd., Beckman-Kent-England 4.
- ⓈNATIONAL CO., INC., 61 Sherman St., Malden 48, Mass. 2-9. ADV. PG. 280, 281.
- ⓈNational Electronics Labs., Inc., 1713 Kalorama Rd., N.W., Washington 9, D. C. 11.
- ⓈNORTHERN RADIO CO., INC., 143-145 W. 22nd St., New York 11, N. Y. 9. ADV. PG. 262, 263.
- ⓈPhilco Corp., Tioga & C Streets, Philadelphia 34, Pa. 4-7-10.
- ⓈPOLARAD ELECTRONICS CORP., 100 Metropolitan Ave., Brooklyn 11, N. Y. 5. ADV. PG. 184, 185.
- ⓈPress Wireless Mfg. Co., Inc., Cantiague Rd., Hicksville, N. Y. 1-2-4-7-9.
- ⓈRacon Electric Co., 52 E. 19th St., New York 3, N. Y. 10.
- ⓈRADIO CORP. OF AMERICA, RCA Victor Div., Camden, N. J., General Offices. 1-7-8-11. ADV. PG. 177, Inside Back and Back Covers.
- ⓈRadio Engineering Labs., Inc., 36-40 37th St., Long Island City 1, N. Y. 7-8-9-10-11.
- ⓈRadio Specialty Mfg. Co., 2023 S. E. Sixth Ave., Portland 14, Ore. 11.
- ⓈRadiomarine Corp. of America, 75 Varick St., New York 13, N. Y. 6.
- ⓈRailway Communications, Inc., P. O. Box 1783, Lincoln, Nebr. 3-10.
- ⓈRosen Engineering Products, Inc., Raymond, 32nd & Walnut Sts., Philadelphia 4, Pa. 7-8-9.
- ⓈSchuttig & Co., Inc., 9th & Kearney Sts., N. E. Washington 17, D. C. 2-9.
- ⓈSPERRY GYROSCOPE CO., Div. of The Sperry Corp., Great Neck, N. Y. 1-2-7. ADV. PG. 103, 104.
- ⓈStandard Electronics Corp., 25 W 43rd St., New York 18, N. Y. 6.
- ⓈStandard Telephones & Cables Ltd., Connaught House, Aldwych, London, W. C. 2, England. 1-2-3-4-6-7-8-9-10-11.

- ⓈTechnical Materiel Corp., The, P. O. Box 142, 121 Spencer Place, Mamaroneck, N. Y. 1-9-11.
- ⓈTelephonics Corp., Park Ave., Huntington, N. Y. 1.
- ⓈTRAD TELEVISION CORP., 1001 First Ave., Asbury Park, N. J. 6-9-11. ADV. PG. 355.
- ⓈTransmitter Equipment Mfg. Co., Inc., 345 Hudson St., New York 14, N. Y. 1-2-7-9-11.
- ⓈU. S. Instrument Corp., 409 Broad St., Summit, N. J. 8-10.
- ⓈWest Coast Electronics Co., 1601 S. Burlington St., Los Angeles 6, Calif. 10-11.
- ⓈWESTINGHOUSE ELECTRIC CORP., 511 Wood St., P. O. Box 868, Pittsburgh 30, Pa. 2-3-6-7-9-10-11. ADV. PG. 107-113.
- ⓈWeymouth Instrument Co., 1440 Commercial St., East Weymouth 89, Mass. 7.
- ⓈWilcox Electric Co., 1400 Chestnut St., Kansas City, Mo. 1-2.

COMPARATORS—Automatic Resistance

- ⓈAvion Instrument Corp., Paramus, N. J.
- ⓈClippard Instrument Laboratory, Inc., 1125 Bank St., Cincinnati 14, Ohio.
- ⓈFREED TRANSFORMER CO., INC., 1736 Weirfield St., Brooklyn 27, N. Y. ADV. PG. 149.
- ⓈGENERAL ELECTRIC CO., Schenectady 5, N. Y. ADV. PG. 1 to 22.

COMPARATORS, Circuit Linearity

- ⓈDavies Laboratories, Inc., 4705 Queensbury Rd., Riverdale, Md.

COMPARATORS—Crystal

- ⓈBARKER & WILLIAMSON, 235 Fairfield Ave., Upper Darby, Pa. ADV. PG. 292.
- ⓈBassett, Inc., Rex, 307-11 N. W. First Ave., Fort Lauderdale, Fla.
- ⓈMeasurement Engineering, Ltd., Arnprior, Ontario, Canada.
- ⓈMenlo Research Laboratory, Menlo Park, Calif.
- ⓈPolytech Devices, Inc., 1180 E. Grand St., Elizabeth, N. J.
- ⓈPOTTER INSTRUMENT CO., INC., 115 Cutter Mill Rd., Great Neck, N. Y. ADV. PG. 318.
- Scherr Co., Inc., George, 200 Lafayette St., New York 12, N. Y.

COMPARATORS, Surface See Analyzers, Surface

COMPARATORS—Voltage

- ⓈArma Corp., 254 36th St., Brooklyn, N. Y.
- ⓈHart Associates, 8430 Grand River, Detroit 4, Mich.
- ⓈINDUSTRIAL ELECTRONICS, INC., 8080 Wheeler St., Detroit 10, Mich. ADV. PG. 234, 235.
- ⓈLeeds & Northrup Co., 4970 Stenton Ave., Philadelphia 44, Pa.
- ⓈSensitive Research Instrument Corp., 9 Elm Ave., Mt. Vernon, N. Y.

COMPASSES—Electronic Gyro

- ⓈSPERRY GYROSCOPE CO., Div. of The Sperry Corp., Great Neck, N. Y. ADV. PG. 103, 104.

COMPUTERS, ELECTRONIC See Machines

CONDENSERS See Capacitors

CONES, METAL TY

- ⓈI-T-E Circuit Breaker Co., 19th & Hamilton Sts., Philadelphia 30, Pa.
- ⓈSpincraft, Inc., 4128 W. State St., Milwaukee 8, Wis.
- ⓈTeiner Co., Inc., Roland, 134 Tremont St., Everett 49, Mass.

CONES—Speaker

- ⓈBest Mfg. Co., 1200 Grove St., Irvington 11, N. J.
- ⓈHawley Products Co., St. Charles, Ill.
- ⓈStevens Products Inc., 86-88 Main St., East Orange, N. J.

CONNECTORS—Cable Connectors & Couplings

- ⓈAEROLITE ELECTRONIC HARDWARE CORP., 507 26th St., Union City, N. J. ADV. PG. 355.
- ⓈALDEN PRODUCTS CO., 117 North Main St., Brockton 64, Mass. ADV. PG. 327.
- ⓈAluminum Co. of America, Gulf Bldg., Pittsburgh 30, Pa.

V indicates . . . IN PRODUCTION • AVAILABILITY • UNRESTRICTED FOR GENERAL USE

AMERICAN PHENOLIC CORP., 1830 S. 54th St., Chicago 50, Ill. ADV. PG. 61.
Ark-Les Switch Corp., 55 Water St., Watertown 72, Mass.
ATOMIC INSTRUMENT CO., 84 Massachusetts Ave., Cambridge 39, Mass. ADV. PG. 410.
Automatic Metal Products Co., 315 Berry St., Brooklyn 11, N. Y.
BELLING & LEE LTD., 366 Madison Ave., New York 17, N. Y. ADV. PG. 336.
BELOCK INSTRUMENT CORP., 111th St. & 14th Ave., College Point, N. Y. ADV. PG. 371.
BUCHANAN ELECTRICAL PRODUCTS CORP., 223 Route 29, Hillside, N. J. ADV. PG. 332.
Buggie & Co., H. H., 726 Stanton St., Toledo, Ohio.
Burndy Engineering Co., Inc., 107 Bruckner Blvd., New York 54, N. Y.
Cannon Electric Development Co., 3209 Humboldt St., Los Angeles 31, Calif.
CINCH MFG. CORP., 1026 S. Homan Ave., Chicago 24, Ill. ADV. PG. 186, 187.
Clarke Instrument Div., National Electrical Machine Shops, Inc., 919 Jesup-Blair Dr., Silver Spring, Md.
Connecticut Telephone & Electric Corp., 70 Britannia St., Meriden, Conn.
DAGE ELECTRIC CO., 4007 E. Michigan Ave., Indianapolis 1, Ind. ADV. PG. 405.
Dante Electric Mfg. Co., Bantam, Conn.
DIAL LIGHT CO. OF AMERICA, 900 Broadway, New York 3, N. Y. ADV. PG. 60.
Diamond Mfg. Co., Wakefield, Mass.
Drake Mfg. Co., 1713 Hubbard St., Chicago 22, Ill.
EBVY, INC., HUGH H., 4700 Stenton Ave., Philadelphia 44, Pa. ADV. PG. 214.
Elco Corp., 190 W. Glenwood Ave., Philadelphia 40, Pa.
ELECTRO DEVELOPMENT CORP., 6014 W. Washington Blvd., Culver City, Calif. ADV. PG. 408.
Electro Precision Products Inc., 119-01 22nd Ave., College Point, N. Y.
Equipment & Service Co., 6815 Oriole Drive, Dallas 9, Texas.
Frankel Connector Co., 177 Hudson St., New York, N. Y.
General R-F Fittings Co., 702 Beacon St., Boston 15, Mass.
GENERAL RADIO CO., 275 Massachusetts Ave., Cambridge 39, Mass. ADV. PG. 48, 49.
HOBSON BROTHERS, 4049 W. Fullerton St., Chicago 39, Ill. ADV. PG. 322.
IlSCO Copper Tube & Products Inc., Mariemont Ave., Mariemont, Cincinnati 27, Ohio.
Javex, 921 State, Garland, Texas.
JOHNSON CO., E. F., Waseca, Minn. ADV. PG. 118, 121.
JONES, DIV., HOWARD B., Cinch Mfg. Corp., 1026 S. Homan Ave., Chicago 24, Ill. ADV. PG. 186, 187.
Joy Mfg. Co., Mines Equipment Div., Oliver Bldg., Pittsburgh 22, Pa.
Kamm Co., L. J., 40 W. 96th St., New York 25, N. Y.
KINGS ELECTRONICS, 40 Marbledale Rd., Tuckahoe, N. Y. ADV. PG. 180, 181.
Magna Electronics Co., 3707-11 W. Jefferson Blvd., Los Angeles 16, Calif.
Micarta Fabricators, Inc., 5324 Ravenswood Ave., Chicago 40, Ill.
Morse Co., Frank W., 1300 Soldiers Field Rd., Boston 35, Mass.
Molded Insulation Co., 335 E. Price St., Philadelphia 44, Pa.
Pacific Electriccord Co., 3217 Exposition Place, Los Angeles 18, Calif.
Philo Corp., Tioga & C Sts., Philadelphia 34, Pa.
PIX MFG. CO., INC., 24 Bedford St., Newark, N. J. ADV. PG. 136.
PRODUCT DEVELOPMENT CO., INC., Arlington, N. J. ADV. PG. 362.
RADIO CORP. OF AMERICA, RCA Victor Div., General Offices, Camden, N. J. ADV. PG. 177, Inside Back & Back Covers.
Remler Co., Ltd., 2101 Bryant St., San Francisco 10, Calif.
RUSSELL & STOLL CO., INC., 125 Barclay St., New York 7, N. Y. ADV. PG. 337.
Scintilla Magneto Div. of Bendix Aviation Corp., Sidney, N. Y.
Selectar Industries, Inc., 401 East 138th St., New York 54, N. Y.
SHERMAN MFG. CO., H. B., 22 Barney St., Battle Creek, Mich. ADV. PG. 156.
Standard Telephones & Cables Ltd., Connaught House, Aldwych, London, W. C. 2, England.
Thomas & Betts Co., Inc., 40 Butler St., Elizabeth 1, N. J.
Tinnerman Products, Inc., P.O. Box 6688, Dept. No. 16, Cleveland 1, Ohio.
Wade Electric Products Co., 211 Jacob St., Sturgis, Mich.
WALTHAM HOROLOGICAL CORP., Waltham, Mass. ADV. PG. 409.
WINCHESTER ELECTRONICS, INCORPORATED, Glenbrook, Conn. ADV. PG. 201.
Winslow Co., Inc., 9 Liberty St., Newark 5, N. J.
WORKSHOP ASSOCIATES, INC., THE, 66 Needham St., Newton Highlands 61, Mass. ADV. PG. 233.

CONNECTORS—Ceramic Cable

Andrew Corp., 363 E. 75th St., Chicago 19, Ill.
BELLING & LEE LTD., 366 Madison Ave., New York 17, N. Y. ADV. PG. 336.
Birnbach Radio Co., Inc., 145 Hudson St., New York, N. Y.
CENTRALAB, Div. of Globe Union Inc., 900 E. Keefe Ave., Milwaukee 1, Wis. ADV. PG. 85-88.
Clarke Instrument Div., National Electrical Machine Shops, Inc., 919 Jesup-Blair Dr., Silver Spring, Md.
GENERAL CERAMICS & STEATITE CORP., Kearsbey, N. J. ADV. PG. 126, 127.

CONNECTORS—Coaxial Cable

AEROLITE ELECTRONIC HARDWARE CORP., 507 26th St., Union City, N. J. ADV. PG. 355.
AMERICAN PHENOLIC CORP., 1830 S. 54th Ave., Chicago 50, Ill. ADV. PG. 61.
Andrew Corp., 363 E. 75th St., Chicago 19, Ill.
Astatic Corp., The, Conneaut, Ohio.
Automatic Metal Products Co., 315 Berry St., Brooklyn 11, N. Y.
BARKER & WILLIAMSON, 235 Fairfield Ave., Upper Darby, Pa. ADV. PG. 292.
BELLING & LEE LTD., 366 Madison Ave., New York 17, N. Y. ADV. PG. 336.
Birnbach Radio Co., Inc., 145 Hudson St., New York, N. Y.
Brach Mfg. Corp., 200 Central Ave., Newark 4, N. J.
Buggie & Co., H. H., 726 Stanton St., Toledo, Ohio.
Burndy Engineering Co., Inc., 107 Bruckner Blvd., New York 54, N. Y.
Cannon Electric Development Co., 3209 Humboldt St., Los Angeles 31, Calif.
Communication Products Co., Inc., Marlboro, N. J.
DAGE ELECTRIC CO., 4007 E. Michigan Ave., Indianapolis 1, Ind. ADV. PG. 405.
Electro Precision Products Inc., 119-01 22nd Ave., College Point, N. Y.
General R-F Fittings Co., 702 Beacon St., Boston 15, Mass.
GENERAL RADIO CO., 275 Massachusetts Ave., Cambridge 39, Mass. ADV. PG. 48, 49.
J F D MFG. CO., 6101-23 Sixteenth Ave., Brooklyn, N. Y. ADV. PG. 407.
Joy Mfg. Co., Mines Equipment Div., Oliver Bldg., Pittsburgh 22, Pa.
KINGS ELECTRONICS, 40 Marbledale Rd., Tuckahoe, N. Y. ADV. PG. 180, 181.
Molded Insulation Co., 335 E. Price St., Philadelphia, Pa.
Pacific Electriccord Co., 3217 Exposition Place, Los Angeles 18, Calif.
Philo Corp., Tioga & C Sts., Philadelphia 34, Pa.
PRODUCT DEVELOPMENT CO., INC., Arlington, N. J. ADV. PG. 362.
RADIO CORP. OF AMERICA, RCA Victor Div., General Offices, Camden, N. J. ADV. PG. 177, Inside Back & Back Covers.
Selectar Industries, Inc., 401 E. 138th St., New York 54, N. Y.
SPERRY GYROSCOPE CO., Div. of The Sperry Corp., Great Neck, N. Y. ADV. PG. 103, 104.
Standard Telephones & Cables Ltd., Connaught House, Aldwych, London, W. C. 2, England.
Thomas & Betts Co., Inc., 40 Butler St., Elizabeth 1, N. J.
Transradio Ltd., 138A Cromwell Rd., London S. W. 7, England.
Ucinite Co. Division, United-Carr Fastener Corp., 459 Watertown St., Newtonville, Mass.
WALTHAM HOROLOGICAL CORP., Waltham, Mass. ADV. PG. 409.
Weymouth Instrument Co., 1440 Commercial St., East Weymouth 89, Mass.
WORKSHOP ASSOCIATES, INC., THE, 66 Needham St., Newton Highlands 61, Mass. ADV. PG. 233.

CONNECTORS—Stand-off & Cone

BELLING & LEE LTD., 366 Madison Ave., New York 17, N. Y. ADV. PG. 336.
Birnbach Radio Co., Inc., 145 Hudson St., New York, N. Y.
GENERAL ACCESSORIES CO., LTD., 366 Madison Ave., New York 17, N. Y. ADV. PG. 336.
GENERAL CERAMICS & STEATITE CORP., Kearsbey, N. J. ADV. PG. 126, 127.
HEPPNER MFG. CO., P. O. Box 612, Round Lake, Ill. ADV. PG. 413.
Millen Mfg. Co., James, 150 Exchange St., Malden, Mass.

CONTACTORS

Allen-Bradley Co., 136 W. Greenfield Ave., Milwaukee 4, Wis.
Automatic Switch Co., 391 Lakeside Ave., Orange, N. J.
CINCH MFG. CORP., 1026 S. Homan Ave., Chicago 24, Ill. ADV. PG. 186, 187.
Clark Controller Co., The, 1146 E. 152nd St., Cleveland 10, Ohio.

Cutler-Hammer, Inc., 411 N. 12th St., Milwaukee 1, Wis.
Edwards Co., Inc., 86 Boston Post Rd., Norwalk, Conn.
Fansteel Metallurgical Corp., 2200 Sheridan Rd., North Chicago, Ill.
JOHNSON CO., E. F., Waseca, Minn. ADV. PG. 118, 121.
Lumenite Electric Co., 407 S. Dearborn St., Chicago 5, Ill.
McQuay-Norris Mfg. Co., 2320 Marconi Ave., St. Louis 10, Mo.
MAKEPEACE CO., D. E., Attleboro, Mass. ADV. PG. 72.
Struthers-Dunn Inc., 150 N. 13th St., Philadelphia 7, Pa.
Trumbull Electric Mfg. Co., Plainville, Conn.
Veeder-Root, Inc., 20 Sargeant St., Hartford 2, Conn.
WARD LEONARD ELECTRIC CO., 31 South St., Mt. Vernon, N. Y. ADV. PG. 69, 70.
Weltronic Co., 19500 West Eight Mile Rd., Detroit 19, Mich.
WESTINGHOUSE ELECTRIC CORP., 511 Wood St., P. O. Box 868, Pittsburgh 30, Pa. ADV. PG. 107-113.
Zenith Electric Co., 152 W. Walton St., Chicago 10, Ill.

CONTACTS—Electrical

ALDEN PRODUCTS CO., 117 N. Main St., Brockton 64, Mass. ADV. PG. 327.
AMERICAN PHENOLIC CORP., 1830 S. 54th Ave., Chicago 54, Ill. ADV. PG. 61.
Arrow-Hart & Hegeman Electric Co., 100 Hawthorn St., Hartford 6, Conn.
Automatic Metal Products Co., 315 Berry St., Brooklyn 11, N. Y.
Baker Co., Inc., 113 Astor St., Newark 5, N. J.
BEAD CHAIN MFG. CO., 110 Mountain Grove St., Bridgeport 5, Conn. ADV. PG. 136.
BRAININ CO., C. S., 320 Washington St., Mt. Vernon, N. Y. ADV. PG. 142.
Cannon Electric Development Co., 3209 Humboldt St., Los Angeles 31, Calif.
CINCH MFG. CORP., 1026 S. Homan Ave., Chicago 24, Ill. ADV. PG. 186, 187.
Electro Development Corp., 6014 W. Washington Blvd., Culver City, Calif.
Fansteel Metallurgical Corp., 2200 Sheridan Rd., North Chicago, Ill.
FRANKLIN AIRLOOP CORP., 43-20 34th St., Long Island City, N. Y. ADV. PG. 45.
FRANKLIN MFG. CORP., A. W., 43-20 34th St., Long Island City 1, N. Y. ADV. PG. 44.
GENERAL PLATE DIVISION, Metals & Controls Corp., Attleboro, Mass. ADV. PG. 300.
Gibson Electric Co., 8361 Frankstown Ave., Pittsburgh 21, Pa.
GRAPHITE METALLIZING CORP., 1041 Nepperhan Ave., Yonkers 3, N. Y. ADV. PG. 192.
KEYSTONE CARBON CO., INC., Saint Mary's Pa. ADV. PG. 308.
MAKEPEACE CO., D. E., Attleboro, Mass. ADV. PG. 72.
MALCO TOOL & MFG. CO., 4025 W. Lake St., Chicago 24, Ill. ADV. PG. 385.
Mallory & Co., Inc., P. R., 3029 E. Washington St., Indianapolis 6, Ind.
Neomatic Inc., 879 Wellesley Ave., Los Angeles 49, Calif.
NEY CO., J. M., 179 Elm St., Hartford, Conn. ADV. PG. 246.
PIX MFG. CO., INC., 24 Bedford St., Newark, N. J. ADV. PG. 136.
Spencer Thermostat Div. Metals & Controls Corp., 34 Forest St., Attleboro, Mass.
STACKPOLE CARBON CO., St. Marys, Pa. ADV. PG. 170, 171.
Stamford Metal Specialty Co., Inc., 429 Broadway, New York 12, N. Y.
Standard Metals Corp., 262 Broad St., North Attleboro, Mass.
Tinnerman Products, Inc., P.O. Box 6688, Dept. No. 16, Cleveland 1, Ohio.
Tricon Mfg. Co., 8318 S. Racine Ave., Chicago, Ill.
Ucinite Co. Division, United-Carr Fastener Corp., 459 Watertown St., Newtonville, Mass.
WESTINGHOUSE ELECTRIC CORP., 511 Wood St., P. O. Box 868, Pittsburgh 30, Pa. ADV. PG. 107-113.
Wilson Co., H. A., The, 105 Chestnut St., Newark 5, N. J.

CONTROLS—Alarm System

Adams & Westlake Co., Michigan St., Elkhart, Ind.
Airlectron, Inc., P. O. Box 151, Caldwell, N. J.
ATOMIC INSTRUMENT CO., 84 Massachusetts Ave., Cambridge 39, Mass. ADV. PG. 410.
Autocal Co., The, Shelby, Ohio.
Automatic Temperature Control Co., Inc., 5212 Pulaski Ave., Philadelphia 44, Pa.
Bristol Co., The, Waterbury 20, Conn.
Deitz Co., S. J., Box 65, West Englewood, N. J.
De-Tec-Tronic Laboratories, Inc., 1711 Terra Cotta Pl., Chicago 14, Ill.

Ⓜ indicates . . . IN PRODUCTION • AVAILABILITY • UNRESTRICTED FOR GENERAL USE

- Ⓜ Edwards Co., Inc., 86 Boston Post Rd., Norwalk, Conn.
- Ⓜ Electro Chemical Engineering Co., 750 Broad St., Emmaus, Pa.
- Ⓜ EL-TRONICS, INC., 2649 N. Howard St., Philadelphia 33, Pa. ADV. PG. 299.
- Ⓜ General Controls Co., Glendale 1, Calif.
- Ⓜ Hastings Instrument Co., Inc., Hampton 9, Va.
- Ⓜ Hose-McCann Telephone Co., Inc., 25th St. & 3rd Ave., Brooklyn 32, N. Y.
- Ⓜ Industrial Electronics Co., Hanover, Mass.
- Ⓜ JONES ELECTRONICS CO., M. C., Bristol Conn. ADV. PG. 384.
- Ⓜ Lumenite Electric Co., 407 S. Dearborn St., Chicago 5, Ill.
- Ⓜ MERCROID CORP., 4201 Belmont Ave., Chicago 41, Ill. ADV. PG. 192.
- Ⓜ Neomatic Inc., 879 Wellesley Ave., Los Angeles 49, Calif.
- Ⓜ Photobell Company, 116 Nassau St., New York 7, N. Y.
- Ⓜ Photoswitch, Inc., 77 Broadway, Cambridge 42, Mass.
- Ⓜ Ripley Co., Inc., Middletown, Conn.
- Ⓜ RUSSELL & STOLL CO., INC., 125 Barclay St., New York 7, N. Y. ADV. PG. 337.
- Ⓜ SERVO-TEK PRODUCTS CO., 4 Godwin Ave., Paterson 1, N. J. ADV. PG. 356.
- Ⓜ SIGNAL ENGINEERING & MFG. CO., 154-6 W. 14th St., New York, N. Y. ADV. PG. 256.
- Ⓜ U. S. Gauge Div., American Machine & Metals, Inc., Sellersville, Pa.
- Ⓜ Vapor Recovery Systems Co., 2820 N. Alameda, Compton, Calif.
- Ⓜ Warrick Co., Charles F., 16251 Hamilton Ave., Detroit 3, Mich.
- Ⓜ WESTINGHOUSE ELECTRIC CORP., 511 Wood St., P. O. Box 868, Pittsburgh 30, Pa. ADV. PG. 107-113.
- Ⓜ Worner Electronic Devices, Rankin, Ill.

CONTROLS—Auto Radio Remote

- Ⓜ Croname, Inc., 3701 Ravenswood Ave., Chicago, Ill.
- Ⓜ Delco Radio Div., General Motors Corp., Kokomo, Ind. Elm Laboratories, 18 South Broadway, Dobbs Ferry, N. Y.
- Ⓜ Gasket Engineering Co., 2440 Charlotte St., Kansas City 8, Mo.
- Ⓜ Hart Associates, 8430 Grand River, Detroit 4, Mich.
- Ⓜ Kupfrian Mfg. Co., 218 Prospect Ave., Binghamton, N. Y.
- Ⓜ WHITE DENTAL MFG. CO., S. S., Industrial Div., 10 E. 40th St., New York, N. Y. ADV. PG. 291.

CONTROLS—Automatic Tuning

- Ⓜ AIR ASSOCIATES, INC., Teterboro, N. J. ADV. PG. 211.
- Ⓜ Atlas Metal Stamping Co., Castor & Kensington Aves., Philadelphia 24, Pa.
- Ⓜ Bunnell & Co., J. H., 81 Prospect St., Brooklyn, N. Y.
- Ⓜ Delco Radio Div., General Motors Corp., Kokomo, Ind. Elm Laboratories, 18 South Broadway, Dobbs Ferry, N. Y.

CONTROL—Automatic Voltage Regulating

- Ⓜ AIRMEC LABORATORIES LTD., 366 Madison Ave., New York 17, N. Y. ADV. PG. 336.
- Ⓜ Atlantic Electronics, 4 Manhasset Ave., Manorhaven, N. Y.
- Ⓜ BOGUE ELECTRIC MFG. CO., 52 Iowa Ave., Paterson 3, N. J. ADV. PG. 155.
- Ⓜ Burlington Instrument Co., Burlington, Iowa.
- Ⓜ Doelcam Corp., 56 Elmwood St., Newton 58, Mass.
- Ⓜ Edwards Co., Inc., 86 Boston Post Rd., Norwalk, Conn. Electron Equipment Corp., 917 Meridian Ave., South Pasadena, Calif.
- Ⓜ FERRANTI ELECTRIC, INC., 30 Rockefeller Plaza, New York 20, N. Y. ADV. PG. 159.
- Ⓜ Furst Electronics, 10 S. Jefferson St., Chicago 6, Ill.
- Ⓜ Gates Radio Co., Quincy, Ill.
- Ⓜ GENERAL ELECTRIC CO., Schenectady 5, N. Y. ADV. PG. 1 to 22.
- Ⓜ Industrial Electronics Co., Hanover, Mass.
- Ⓜ Inet, Inc., 8655 S. Main St., Los Angeles 3, Calif.
- Ⓜ J F D MFG. CO., 6101-23 Sixteenth Ave., Brooklyn, N. Y. ADV. PG. 407.
- Ⓜ KEPCO LABS, INC., 149-14 41st Ave., Flushing, N. Y. ADV. PG. 54.
- Ⓜ SOLA ELECTRIC CO., 4633 W. 16th St., Chicago 50, Ill. ADV. PG. 312.
- Ⓜ SORENSEN & CO., INC., 375 Fairfield Ave., Stamford, Conn. ADV. PG. 66, 67.
- Ⓜ SUPERIOR ELECTRIC CO., THE, 4000 Church St., Bristol, Conn. ADV. PG. 190, 191.
- Ⓜ UNITED TRANSFORMER CO., 150 Varick St., New York 13, N. Y. ADV. PG. Inside Front Cover.
- Ⓜ Weltronic Co., 19500 W. Eighth Mile Rd., Detroit 19, Mich.
- Ⓜ WESTINGHOUSE ELECTRIC CORP., 511 Wood St., P. O. Box 868, Pittsburgh 30, Pa. ADV. PG. 107-113.

CONTROLS—Capacitance Operated

- Ⓜ Federal Tool Engineering Co., 532 Mulberry St., Newark 5, N. J.
- Ⓜ Fielden Instrument Corp., 2920 N. 4th St., Philadelphia 33, Pa.
- Ⓜ Hart Associates, 8430 Grand River, Detroit 4, Mich.
- Ⓜ Lumenite Electric Co., 407 S. Dearborn St., Chicago 5, Ill.
- Ⓜ Niagara Electron Laboratories, Andover, N. Y.
- Ⓜ Photobell Company, 116 Nassau St., New York 7, N. Y.
- Ⓜ Weltronic Co., 19500 W. Eight Mile Rd., Detroit 19, Mich.

CONTROLS—Chemical

- Ⓜ Automatic Temperature Control Co., Inc., 5212 Pulaski Ave., Philadelphia 44, Pa.
- Ⓜ Clippard Instrument Laboratory, Inc., 1125 Bank St., Cincinnati 14, Ohio.
- Ⓜ GENERAL ELECTRIC CO., Schenectady 5, N. Y. ADV. PG. 1 to 22.
- Ⓜ Leeds & Northrup Co., 4970 Stenton Ave., Philadelphia 44, Pa.
- Ⓜ Niagara Electron Laboratories, Andover, N. Y.
- Ⓜ Robinette Co., W. C., 802 Fair Oaks Ave., South Pasadena, Calif.

CONTROLS—Counting & Sorting

- Ⓜ AIRMEC LABORATORIES LTD., 366 Madison Ave., New York 17, N. Y. ADV. PG. 336.
- Ⓜ Arma Corp., 254 36th St., Brooklyn 32, N. Y.
- Ⓜ ATOMIC INSTRUMENT CO., 84 Massachusetts Ave., Cambridge 39, Mass. ADV. PG. 410.
- Ⓜ Automatic Temperature Control Co., Inc., 5212 Pulaski Ave., Philadelphia 44, Pa.
- Ⓜ Berkshire Laboratories, 580 Lexington Ave., Concord, Mass.
- Ⓜ Dietz Co., S. J., Box 65, W. Englewood, N. J.
- Ⓜ Eagle Signal Corp., Moline, Illinois.
- Ⓜ Electrodyne Company, 32 Oliver St., Boston, Mass.
- Ⓜ Electronic Associates Inc., Long Branch, N. J.
- Ⓜ Electronic Control Corp., 1573 E. Forest St., Detroit, Mich.
- Ⓜ Fielden Instrument Corp., 2920 N. 4th St., Philadelphia 33, Pa.
- Ⓜ GENERAL ELECTRIC CO., Schenectady 5, N. Y. ADV. PG. 1 to 22.
- Ⓜ Hart Associates, 8430 Grand River, Detroit 4, Mich.
- Ⓜ Industrial Electronics Co., Hanover, Mass.
- Ⓜ INDUSTRIAL ELECTRONICS, INC., 8080 Wheeler St., Detroit 10, Mich. ADV. PG. 130.
- Ⓜ Ionic Electronic Equipment Co., 1705 N. Kenmore, Los Angeles 27, Calif.
- Ⓜ Photoswitch, Inc., 77 Broadway, Cambridge 42, Mass.
- Ⓜ POTTER INSTRUMENT CO., INC., 115 Cutter Mill Rd., Great Neck, N. Y. ADV. PG. 318.
- Ⓜ Production Instrument Co., 710 W. Jackson Blvd., Chicago 6, Ill.
- Ⓜ Standard Electronics Research Corp., 2 East End Ave., New York 21, N. Y.
- Ⓜ WESTINGHOUSE ELECTRIC CORP., 511 Wood St., P. O. Box 868, Pittsburgh 30, Pa. ADV. PG. 107-113.
- Ⓜ Worner Electronic Devices, Rankin, Ill.

CONTROLS—Density

See Controls Specific Gravity

CONTROLS—Dimension

- Ⓜ Automatic Temperature Control Co., Inc., 5212 Pulaski Ave., Philadelphia 44, Pa.
- Ⓜ Berkshire Laboratories, 580 Lexington Rd., Concord, Mass.
- Ⓜ Electronic Control Corp., 1573 E. Forest St., Detroit, Mich.
- Ⓜ Fielden Instrument Corp., 2920 N. 4th St., Philadelphia 33, Pa.
- Ⓜ Pratt & Whitney Div., Niles-Bement-Pond Co., West Hartford 3, Conn.
- Ⓜ Robinette Co., W. C., 802 Fair Oaks Ave., South Pasadena, Calif.
- Ⓜ Standard Electronics Research Corp., 2 East End Ave., New York 21, N. Y.
- Ⓜ WESTINGHOUSE ELECTRIC CORP., 511 Wood St., P. O. Box 868, Pittsburgh 30, Pa. ADV. PG. 107-113.

CONTROLS—Door

- Ⓜ AIR ASSOCIATES, INC., Teterboro, N. J. ADV. PG. 211.
- Ⓜ Arrow-Hart & Hegeman Electric Co., 100 Hawthorn St., Hartford 6, Conn.
- Ⓜ Edwards Co., Inc., 86 Boston Post Rd., Norwalk, Conn.
- Ⓜ Electronic Control Corp., 1573 E. Forest St., Detroit, Mich.

- Ⓜ GENERAL ELECTRIC CO., Schenectady 5, N. Y. ADV. PG. 1 to 22.
- Ⓜ Industrial Electronics Co., Hanover, Mass.
- Ⓜ Photobell Company, 116 Nassau St., New York 7, N. Y.
- Ⓜ Photoswitch, Inc., 77 Broadway, Cambridge 42, Mass.
- Ⓜ WESTINGHOUSE ELECTRIC CORP., 511 Wood St., P. O. Box 868, Pittsburgh 30, Pa. ADV. PG. 107-113.

CONTROLS—Electronic Motor

- Ⓜ AIR ASSOCIATES, INC., Teterboro, N. J. ADV. PG. 211.
- Ⓜ Ampex Electric Corp., 1155 Howard Ave., San Carlos, Calif.
- Ⓜ Automatic Temperature Control Co., Inc., 5212 Pulaski Ave., Philadelphia 44, Pa.
- Ⓜ BELOCK INSTRUMENT CORP., 111th St. & 14th Ave., College Point, N. Y. ADV. PG. 371.
- Ⓜ Clark Controller Co., The, 1146 E. 152nd St., Cleveland 10, Ohio.
- Ⓜ Cutler-Hammer, Inc., 411 N. 12th St., Milwaukee 1, Wis. Doelcam Corp., 56 Elmwood St., Newton 58, Mass.
- Ⓜ EBERT ELECTRONICS CORP., 185-09 Jamaica Ave., Hollis 7, N. Y. ADV. PG. 413.
- Ⓜ ECLIPSE-PIONEER DIV. BENDIX AVIATION CORP., Teterboro, N. J. ADV. PG. 198, 199.
- Ⓜ Electric Machinery Mfg. Co., 1331 N. E. Tyler St., Minneapolis 13, Minn. Electron Equipment Corp., 917 Meridian Ave., South Pasadena, Calif.
- Ⓜ Federal Electric Products Co., 50 Paris St., Newark 5, N. Y.
- Ⓜ Flader, Inc., Frederic, 1330 Laskey Rd., Toledo 12, Ohio.
- Ⓜ GENERAL ELECTRIC CO., Schenectady 5, N. Y. ADV. PG. 1 to 22.
- Ⓜ GENERAL RADIO CO., 275 Massachusetts Ave., Cambridge 39, Mass. ADV. PG. 48, 49.
- Ⓜ Hart Associates, 8430 Grand River, Detroit 4, Mich.
- Ⓜ Heller Co., Gerald K., 1542 Ridgely St., Baltimore 30, Md.
- Ⓜ INDUSTRIAL CONTROL CO., Straight Path & Arlington Ave., Wyandanch, N. Y. ADV. PG. 130.
- Ⓜ Industrial Electronics Co., Hanover, Mass.
- Ⓜ Mosher Electronic Controls, 25 Boston Post Rd., Larchmont, N. Y.
- Ⓜ RAYTHEON MFG. CO., Equipment Soles Div., Waltham 54, Mass. ADV. PG. 80, 81.
- Ⓜ Ripley Co., Inc., Middletown, Conn.
- Ⓜ Robinette Co., W. C., 802 Fair Oaks Ave., S. Pasadena, Calif.
- Ⓜ Robotron Corp., 5570 W. Chicago Blvd., Detroit 4, Mich.
- Ⓜ SERVO CORP. OF AMERICA, 20-20 Jericho Turnpike, New Hyde Park, N. Y. ADV. PG. 150, 151.
- Ⓜ SERVO-TEK PRODUCTS CO., 4 Godwin Ave., Paterson 1, N. J. ADV. PG. 356.
- Ⓜ SERVOMECHANISMS, INC., Whaleneck Rd. & Stewart Ave., Westbury, L. I., N. Y. ADV. PG. 188.
- Ⓜ Ther Electric & Machine Works, 15 S. Jefferson St., Chicago, Ill.
- Ⓜ Worner Electronic Devices, Rankin, Ill.
- Ⓜ Weltronic Co., 19500 W. Eight Mile Rd., Detroit 19, Mich.
- Ⓜ WESTINGHOUSE ELEC. CORP., 511 Wood St., P. O. Box 868, Pittsburgh 30, Pa. ADV. PG. 107-113.

CONTROLS—Elevator Leveling

- Ⓜ Airtronc, Inc., P. O. Box 151 Caldwell, N. J.
- Ⓜ GENERAL ELECTRIC CO., Schenectady 5, N. Y. ADV. PG. 1 to 22.

CONTROLS—Film Thickness

- Ⓜ Electronic Control Corp., 1573 E. Forest St., Detroit, Mich.
- Ⓜ Fielden Instrument Corp., 2920 N. 4th St., Philadelphia 33, Pa.
- Ⓜ MARCONI INSTRUMENTS, LTD., 23 Beaver St., New York 4, N. Y. ADV. PG. 270.
- Ⓜ Short Wave Plastic Forming Co., 2921 Alameda St., Burbank, Calif.
- Ⓜ Standard Electronics Research Corp., 2 East End Ave., New York 21, N. Y.
- Ⓜ Tracerlab, Inc., 130 High St., Boston 10, Mass.
- Ⓜ Woodwesting, Inc., 3000 W. Olive Ave., Burbank, Calif.

CONTROLS—Fluid Conductivity

- Ⓜ Coral Designs Div. of Henry G. Dietz Co., 12-16 Astoria Blvd., Long Island City 2, N. Y.
- Ⓜ Industrial Electronics Co., Hanover, Mass.
- Ⓜ Leeds & Northrup Co., 4970 Stenton Ave., Philadelphia 44, Pa.
- Ⓜ MINNEAPOLIS-HONEYWELL REGULATOR CO., INDUSTRIAL DIV., Wayne & Roberts Aves., Philadelphia 44, Pa. ADV. PG. 208, 209.
- Ⓜ Network Mfg. Corp., Bayonne, N. J.
- Ⓜ Photoswitch, Inc., 77 Broadway, Cambridge 42, Mass.

V indicates . . . **IN PRODUCTION • AVAILABILITY • UNRESTRICTED FOR GENERAL USE**

CONTROLS—Fluid Flow

- ⓪ Adel Div. of General Metals Corp., 10777 Van Owen St., Burbank, Calif.
- ⓪ Askania Regulator Co., 240 E. Ontario St., Chicago 11, Ill.
- ⓪ Bailey Meter Co., 1044 Ivanhoe Rd., Cleveland 10, Ohio.
- ⓪ Bristol Co., The, Waterbury 20, Conn.
- ⓪ Bunnell & Co., J. H., 81 Prospect St., Brooklyn, N. Y.
- ⓪ Caltron Co., 1406 So. Hobart Blvd., Los Angeles 6, Calif.
- ⓪ Coral Designs Div. of Henry G. Dietz Co., 12-16 Astoria Blvd., Long Island City 2, N. Y.
- ⓪ Feilden Instrument Corp., 2920 N. 4th St., Philadelphia 33, Pa.
- ⓪ Fischer & Porter Co., Hatboro, Pa.
- ⓪ Foxboro Co., The, Foxboro, Mass.
- ⓪ General Controls Co., Glendale 1, Calif.
- ⓪ **INDUSTRIAL ELECTRONICS, INC.**, 8080 Wheeler St., Detroit 10, Mich. ADV. PG. 234, 235.
- ⓪ **MINNEAPOLIS-HONEYWELL REGULATOR CO., INDUSTRIAL DIV.**, Wayne & Roberts Aves., Philadelphia 44, Pa. ADV. PG. 208, 209.
- ⓪ **ROTRON MFG. CO.**, 7-9 Schoonmaker Lane, Woodstock, N. Y. ADV. PG. 410.
- ⓪ **WESTINGHOUSE ELECTRIC CORP.**, 511 Wood St., P. O. Box 868, Pittsburgh 30, Pa. ADV. PG. 107-113.

CONTROLS—Food Processing

- ⓪ Askania Regulator Co., 240 E. Ontario St., Chicago 11, Ill.
- ⓪ Coral Designs Div. of Henry G. Dietz Co., 12-16 Astoria Blvd., Long Island City 2, N. Y.
- ⓪ De-Tec-Tronic Laboratories, Inc., 1711 Terra Cotta Pl., Chicago 14, Ill.
- ⓪ Fischer & Porter Co., Hatboro, Pa.
- ⓪ Leeds & Northrup Co., 4970 Stenton Ave., Philadelphia 44, Pa.
- ⓪ Lumenite Electric Co., 407 S. Dearborn St., Chicago, Ill.
- ⓪ **MERCROID CORP.**, 4201 Belmont Ave., Chicago 41, Ill. ADV. PG. 192.
- ⓪ **MINNEAPOLIS-HONEYWELL REGULATOR CO., INDUSTRIAL DIV.**, Wayne & Roberts Aves., Philadelphia 44, Pa. ADV. PG. 208, 209.
- ⓪ Neomatic Inc., 879 Wellesley Ave., Los Angeles 49, Calif.
- ⓪ Nuclear Research Corp., 2707 Federal St., Philadelphia 46, Pa.
- ⓪ Photoswitch, Inc., 77 Broadway, Cambridge 42, Mass.
- ⓪ Thompson & Associates, John E., 7210 S. Yates Ave., Chicago 49, Ill.
- ⓪ **WESTINGHOUSE ELECTRIC CORP.**, 511 Wood St., P. O. Box 868, Pittsburgh 30, Pa. ADV. PG. 107-113.

CONTROLS—Frequency

- ⓪ **BARKER & WILLIAMSON**, 235 Fairfield Ave., Upper Darby, Pa. ADV. PG. 292.
- ⓪ Bassett, Inc., Rex, 307-11 N. W. First Ave., Fort Lauderdale, Fla.
- ⓪ **BOGUE ELECTRIC MFG. CO.**, 52 Iowa Ave., Paterson 3, N. J. ADV. PG. 155.
- ⓪ Burlington Instrument Co., Burlington, Iowa.
- ⓪ **CLARK CRYSTAL CO.**, 2 Farm Rd., Marlboro, Mass. ADV. PG. 366.
- ⓪ Dallons Labs., 5066 Santa Monica Blvd., Los Angeles, Calif.
- ⓪ **DAVEN CO.**, 191 Central Ave., Newark 4, N. J. ADV. PG. 157.
- ⓪ Electric Regulator Corp., 1938 Park Ave., New York 35, N. Y.
- ⓪ Gates Radio Co., Quincy, Ill.
- ⓪ Gaveco Labs., Inc., 2 East End Ave., New York 21, N. Y.
- ⓪ **GENERAL ELECTRIC CO.**, Schenectady 5, N. Y. ADV. PG. 1 to 22.
- ⓪ Leeds & Northrup Co., 4970 Stenton Ave., Philadelphia 44, Pa.
- ⓪ **NORRMAN LABORATORIES**, Ernst, Williams Bay, Wis. ADV. PG. 346.
- ⓪ Piezo Products Co., Whitney St., Framingham, Mass.
- ⓪ **POTTER INSTRUMENT CO., INC.**, 115 Cutter Mill Rd., Great Neck, N. Y. ADV. PG. 318.
- ⓪ Varo Mfg. Co., Inc., Box 638, Garland, Texas.
- ⓪ Weltronic Co., 19500 W. Eight Mile Rd., Detroit 19, Mich.
- ⓪ **WESTINGHOUSE ELECTRIC CORP.**, 511 Wood St., P. O. Box 868, Pittsburgh 30, Pa. ADV. PG. 107-113.

CONTROLS—Gain

See Attenuators

CONTROLS—Heat Treating

- ⓪ **AIRMEC LABORATORIES LTD.**, 366 Madison Ave., New York 17, N. Y. ADV. PG. 336.
- ⓪ Askania Regulator Co., 240 E. Ontario St., Chicago 11, Ill.
- ⓪ Assembly Products, Inc., Chagrin Falls 6, Ohio.
- ⓪ Automatic Temperature Control Co., Inc., 5212 Pulaski Ave., Philadelphia 44, Pa.

- ⓪ Bristol Co., The, Waterbury 20, Conn.
- ⓪ Burling Instrument Co., 5 Vose Ave., South Orange, N. J.
- ⓪ **EBERT ELECTRONICS CORP.**, 185-09 Jamaica Ave., Hollis 7, N. Y. ADV. PG. 413.
- ⓪ **Electronic Engineering Corp.**, 469 Elm St., Arlington, N. J.
- ⓪ **GENERAL ELECTRIC CO.**, Schenectady 5, N. Y. ADV. PG. 1 to 22.
- ⓪ Gordon Co., Claud S., 3000 S. Wallace St., Chicago 16, Ill.
- ⓪ Leeds & Northrup Co., 4970 Stenton Ave., Philadelphia 44, Pa.
- ⓪ Loudon Instruments, Inc., 5644 Lake Park Ave., Chicago 37, Ill.
- ⓪ Macdonald Co., Inc., W. S., 33 University Rd., Cambridge 38, Mass.
- ⓪ **Meters, Inc.**, 915 Westfield Blvd., Indianapolis 20, Ind.
- ⓪ Tocco Division, Ohio Crankshaft Co., 3800 Harvard Ave., Cleveland, Ohio.
- ⓪ **WESTINGHOUSE ELECTRIC CORP.**, 511 Wood St., P. O. Box 868, Pittsburgh 30, Pa. ADV. PG. 107-113.
- ⓪ Wheelock Instruments Co., 847 W. Harrison St., Chicago 7, Ill.

CONTROLS—Humidity

- ⓪ American Instrument Co., 8030 Georgia Ave., Silver Spring, Md.
- ⓪ Bristol Co., The, Waterbury 20, Conn.
- ⓪ Communication Products Co., Inc., Marlboro, N. J.
- ⓪ Feilden Instrument Corp., 2920 N. 4th St., Philadelphia 33, Pa.
- ⓪ Foxboro Co., The, Foxboro, Mass.
- ⓪ General Controls Co., Glendale 1, Calif.
- ⓪ **GENERAL ELECTRIC CO.**, Schenectady 5, N. Y. ADV. PG. 1 to 22.
- ⓪ Leeds & Northrup Co., 4970 Stenton Ave., Philadelphia 44, Pa.
- ⓪ Minneapolis-Honeywell Regulator Co., 2753 Fourth Ave. S., Minneapolis, Minn.
- ⓪ **MINNEAPOLIS-HONEYWELL REGULATOR CO., INDUSTRIAL DIV.**, Wayne & Roberts Aves., Philadelphia 44, Pa. ADV. PG. 208, 209.
- ⓪ Serdex, Inc., 91 Cambridge St., Boston, Mass.
- ⓪ Tagliabue Div., Weston Electrical Instrument Corp., 614 Frelinghuysen Ave., Newark 5, N. J.
- ⓪ Thermo Instrumental Co., Box 336, Belmont, Calif.
- ⓪ **Worner Electronic Devices**, Rankin, Ill.

CONTROLS—Illumination

- ⓪ Deitz Co., S. J., Box 65, West Englewood, N. J.
- ⓪ Drake Mfg. Co., 1713 Hubbard St., Chicago 22, Ill.
- ⓪ Fisher-Pierce Co., Inc., 170 Pearl St., S. Braintree (Boston 85), Mass.
- ⓪ **GENERAL ELECTRIC CO.**, Schenectady 5, N. Y. ADV. PG. 1 to 22.
- ⓪ **GENERAL RADIO CO.**, 275 Massachusetts Ave., Cambridge 39, Mass. ADV. PG. 48, 49.
- ⓪ Industrial Electronics Co., Hanover, Mass.
- ⓪ Lumenite Electric Co., 407 S. Dearborn St., Chicago, Ill.
- ⓪ Nuclear Research Corp., 2707 Federal St., Philadelphia 46, Pa.
- ⓪ Photobell Company, 116 Nassau St., New York 7, N. Y.
- ⓪ Ripley Co., Inc., Middletown, Conn.
- ⓪ Robinette Co., W. C., 802 Fair Oaks Ave., S. Pasadena, Calif.
- ⓪ **SUPERIOR ELECTRIC CO.**, The, 4000 Church St., Bristol, Conn. ADV. PG. 190, 191.
- ⓪ **WESTINGHOUSE ELECTRIC CORP.**, 511 Wood St., P. O. Box 868, Pittsburgh 30, Pa. ADV. PG. 107-113.
- ⓪ **WESTON ELECTRICAL INSTRUMENT CORP.**, 595 Frelinghuysen Ave., Newark 5, N. J. ADV. PG. 243.
- ⓪ **Worner Electronic Devices**, Rankin, Ill.

CONTROLS—Inspection

- ⓪ Aircraft Electronics Associates Inc., 94 Silas Deane Highway, Rocky Hill, Conn.
- ⓪ Arma Corp., 254 36th St., Brooklyn 32, N. Y.
- ⓪ Automatic Temperature Control Co., Inc., 5212 Pulaski Ave., Philadelphia 44, Pa.
- ⓪ Berkshire Laboratories, 580 Lexington Rd., Concord, Mass.
- ⓪ Deitz Co., S. J., Box 65, West Englewood, N. J.
- ⓪ De-Tec-Tronic Laboratories, Inc., 1711 Terra Cotta Pl., Chicago 14, Ill.
- ⓪ Electronic Associates, Inc., Long Branch, N. J.
- ⓪ **GENERAL ELECTRIC CO.**, Schenectady 5, N. Y. ADV. PG. 1 to 22.
- ⓪ Gerett Corp., M. A., 724 W. Winnebago St., Milwaukee 5, Wis.
- ⓪ Industrial Electronics Co., Hanover, Mass.
- ⓪ **INDUSTRIAL ELECTRONICS, INC.**, 8080 Wheeler St., Detroit 10, Mich. ADV. PG. 234, 235.
- ⓪ Ionic Electronic Equipment Co., 1705 N. Kenmore, Los Angeles 27, Calif.
- ⓪ **MARCONI INSTRUMENTS, LTD.**, 23 Beaver St., New York 4, N. Y. ADV. PG. 270.
- ⓪ Photoswitch, Inc., 77 Broadway, Cambridge 42, Mass.
- ⓪ Pratt & Whitney Div., Niles-Bement-Pond Co., West Hartford 1, Conn.

- ⓪ Standard Electronics Research Corp., 2 East End Ave., New York 21, N. Y.
- ⓪ Weltronic Co., 19500 W. Eight Mile Rd., Detroit 19, Mich.
- ⓪ **WESTINGHOUSE ELECTRIC CORP.**, 511 Wood St., P. O. Box 868, Pittsburgh 30, Pa. ADV. PG. 107-113.

CONTROLS—Liquid Level

- ⓪ **AIR ASSOCIATES, INC.**, Teterboro, N. J. ADV. PG. 211.
- ⓪ Airlectron, Inc., P. O. Box 151, Caldwell, N. J.
- ⓪ Askania Regulator Co., 240 E. Ontario St., Chicago 11, Ill.
- ⓪ Automatic Temperature Control Co., Inc., 5212 Pulaski Ave., Philadelphia 44, Pa.
- ⓪ Bailey Meter Co., 1044 Ivanhoe Rd., Cleveland 10, Ohio.
- ⓪ Baldwin-Lima-Hamilton Corp., Paschall P.O. Station, Philadelphia 42, Pa.
- ⓪ **BOGUE ELECTRIC MFG. CO.**, 52 Iowa Ave., Paterson 3, N. J. ADV. PG. 155.
- ⓪ Bristol Co., The, Waterbury 20, Conn.
- ⓪ Bunnell & Co., J. H., 81 Prospect St., Brooklyn, N. Y.
- ⓪ Coral Designs Div. of Henry G. Dietz Co., 12-16 Astoria Blvd., Long Island City 2, N. Y.
- ⓪ Cutler-Hammer, Inc., 411 No. 12th St., Milwaukee 1, Wis.
- ⓪ Deitz Co., S. J., Box 65, West Englewood, N. J.
- ⓪ Engineering Lab., Inc., 602 E. 4th St., Tulsa 3, Okla.
- ⓪ Feilden Instrument Corp., 2920 N. 4th St., Philadelphia 33, Pa.
- ⓪ Fischer & Porter Co., Hatboro, Pa.
- ⓪ Foxboro Co., The, Foxboro, Mass.
- ⓪ General Controls Co., Glendale 1, Calif.
- ⓪ **GENERAL ELECTRIC CO.**, Schenectady 5, N. Y. ADV. PG. 1 to 22.
- ⓪ Industrial Electronics Co., Hanover, Mass.
- ⓪ Lumenite Electric Co., 407 S. Dearborn St., Chicago, Ill.
- ⓪ **MERCROID CORP.**, 4201 Belmont Ave., Chicago 41, Ill. ADV. PG. 192.
- ⓪ Minneapolis-Honeywell Regulator Co., 2753 Fourth Ave. S., Minneapolis, Minn.
- ⓪ **MINNEAPOLIS-HONEYWELL REGULATOR CO., INDUSTRIAL DIV.**, Wayne & Roberts Aves., Philadelphia 44, Pa. ADV. PG. 208, 209.
- ⓪ Mosher Electronic Controls, 25 Boston Post Rd., Larchmont, N. Y.
- ⓪ Photoswitch, Inc., 77 Broadway, Cambridge 42, Mass.
- ⓪ Ripley Co., Inc., Middletown, Conn.
- ⓪ Robinette Co., W. C., 802 Fair Oaks Ave., South Pasadena, Calif.
- ⓪ **SERVO-TEK PRODUCTS CO.**, 4 Godwin Ave., Paterson, N. J. ADV. PG. 356.
- ⓪ Tagliabue Div., Weston Electrical Instrument Corp., 614 Frelinghuysen Ave., Newark 5, N. J.
- ⓪ Thermo Instruments Co., Box 336, Belmont, Calif.
- ⓪ Warrick Co., Charles F., 16251 Hamilton Ave., Detroit 3, Mich.
- ⓪ **WESTINGHOUSE ELECTRIC CORP.**, 511 Wood St., P. O. Box 868, Pittsburgh 30, Pa. ADV. PG. 107-113.
- ⓪ **Worner Electronic Devices**, Rankin, Ill.

CONTROLS—Loop Regulation

- ⓪ Airlectron, Inc., P. O. Box 151, Caldwell, N. J.
- ⓪ Automatic Temperature Control Co., Inc., 5212 Pulaski Ave., Philadelphia 44, Pa.
- ⓪ Deitz Co., S. J., Box 65, West Englewood, N. J.
- ⓪ **GENERAL ELECTRIC CO.**, Schenectady 5, N. Y. ADV. PG. 1 to 22.
- ⓪ Industrial Electronics Co., Hanover, Mass.
- ⓪ Philbrick Researches, Inc., George A., 230 Congress St., Boston 10, Mass.
- ⓪ **WESTINGHOUSE ELECTRIC CORP.**, 511 Wood St., P. O. Box 868, Pittsburgh 30, Pa. ADV. PG. 107-113.

CONTROLS—Machine Safety

- ⓪ Aircraft Electronics Associates Inc., 94 Silas Deane Highway, Rocky Hill, Conn.
- ⓪ **CRAMER CO., INC.**, R. W., Box 13, Centerbrook, Conn. ADV. PG. 202.
- ⓪ Deitz Co., S. J., Box 65, West Englewood, N. J.
- ⓪ De-Tec-Tronic Laboratories, Inc., 1711 Terra Cotta Pl., Chicago 14, Ill.
- ⓪ **EBERT ELECTRONICS CORP.**, 185-09 Jamaica Ave., Hollis 7, N. Y. ADV. PG. 413.
- ⓪ Electronic Control Corp., 1573 E. Forest St., Detroit, Mich.
- ⓪ **GENERAL ELECTRIC CO.**, Schenectady 5, N. Y. ADV. PG. 1 to 22.
- ⓪ Gerett Corp., M. A., 724 W. Winnebago St., Milwaukee 5, Wis.
- ⓪ Industrial Electronics Co., Hanover, Mass.
- ⓪ **INDUSTRIAL ELECTRONICS, INC.**, 8080 Wheeler St., Detroit 10, Mich. ADV. PG. 234, 235.
- ⓪ Lumenite Electric Co., 407 S. Dearborn St., Chicago, Ill.
- ⓪ Minneapolis-Honeywell Regulator Co., 2753 Fourth Ave. S., Minneapolis, Minn.
- ⓪ Neomatic Inc., 879 Wellesley Ave., Los Angeles 49, Calif.

V Indicates . . . IN PRODUCTION • AVAILABILITY • UNRESTRICTED FOR GENERAL USE

- ⊙RUSSELL & STOLL CO., INC., 125 Barclay St., New York 7, N. Y. ADV. PG. 337.
- ⊙SERVO-TEK PRODUCTS CO., 4 Godwin Ave., Paterson, N. J. ADV. PG. 356.
- ⊙Standard Telephones & Cables Ltd., Connaught House, Aldwych, London, W. C. 2, England.
- ⊙WESTINGHOUSE ELECTRIC CORP., 511 Wood St., P. O. Box 868, Pittsburgh 30, Pa. ADV. PG. 107-113.

CONTROLS—Materials Thickness

- ⊙Automatic Temperature Control Co., Inc., 5212 Pulaski Ave., Philadelphia 44, Pa.
- ⊙Electric Eye Equipment Co., 16 W. Fairchild St., Danville, Ill.
- ⊙EL-TRONICS, INC., 2649 N. Howard St., Philadelphia 33, Pa. ADV. PG. 299.
- ⊙Fielden Instrument Corp., 2920 N. 4th St., Philadelphia 33, Pa.
- ⊙GENERAL ELECTRIC CO., Schenectady 5, N. Y. ADV. PG. 1 to 22.
- ⊙Gerett Corp., M. A., 724 W. Winnebago St., Milwaukee 5, Wis.
- ⊙Industrial Electronics Co., Hanover, Mass.
- ⊙INDUSTRIAL ELECTRONICS, INC., 8080 Wheeler St., Detroit 10, Mich. ADV. PG. 234, 235.
- ⊙Kelley-Koett Instrument Co., 962 York St., Cincinnati 14, Ohio.
- ⊙Pratt & Whitney Div., Niles-Bement-Pond Co., West Hartford 1, Conn.
- ⊙Schaevitz Engineering, Crescent Blvd., at Drexel Ave., Pennsauken Township, Camden 11, N. J.
- ⊙Standard Electronics Research Corp., 2 East End Ave., New York 21, N. Y.
- ⊙Tracerlab, Inc., 130 High St., Boston 10, Mass.
- ⊙WESTINGHOUSE ELECTRIC CORP., 511 Wood St., P. O. Box 868, Pittsburgh 30, Pa. ADV. PG. 107-113.

CONTROLS—Mechanical Overload

- ⊙INDUSTRIAL ELECTRONICS, INC., 8080 Wheeler St., Detroit 10, Mich. ADV. PG. 234, 235.
- ⊙Peerless Instrument Co., 90-15 Corona Ave., Elmhurst, N. Y.

CONTROLS—Mechanical Switch

- ⊙AIR ASSOCIATES, INC., Teterboro, N. J. ADV. PG. 211.
- ⊙Carter Parts Co., 213 Institute Place, Chicago 10, Ill.
- ⊙DAVEN CO., 191 Central Ave., Newark 4, N. J. ADV. PG. 157.
- ⊙Edwards Co., Inc., 86 Boston Post Rd., Norwalk, Conn.
- ⊙Gale Dorothea Mechanisms, 37-61 85th St., Jackson Heights, N. Y.
- ⊙GENERAL ELECTRIC CO., Schenectady 5, N. Y. ADV. PG. 1 to 22.
- ⊙MERCROID CORP., 4201 Belmont Ave., Chicago 41, Ill. ADV. PG. 192.
- ⊙Minneapolis-Honeywell Regulator Co., 2753 Fourth Ave. S., Minneapolis, Minn.
- ⊙PAINTON & CO., INC., LTD., 366 Madison Ave., New York 17, N. Y. ADV. PG. 336.
- ⊙Tech Laboratories, Inc., Bergen & Edsall Bldvs., Palisades Park, N. J.
- ⊙WESTINGHOUSE ELECTRIC CORP., 511 Wood St., P. O. Box 868, Pittsburgh 30, Pa. ADV. PG. 107-113.

CONTROLS—Moisture

- American Instrument Co., 8030 Georgia Ave., Silver Spring, Md.
- ⊙Communication Products Co., Inc., Marlboro, N. J.
- ⊙Fielden Instrument Corp., 2920 N. 4th St., Philadelphia 33, Pa.
- ⊙Foxboro Co., The, Foxboro, Mass.
- ⊙Lumenite Electric Co., 407 S. Dearborn St., Chicago 5, Ill.
- ⊙MARCONI INSTRUMENTS, LTD., 23 Beaver St., New York 4, N. Y. ADV. PG. 270.
- ⊙MINNEAPOLIS-HONEYWELL REGULATOR CO., INDUSTRIAL DIV., Wayne & Roberts Aves., Philadelphia 44, Pa. ADV. PG. 208, 209.
- ⊙Tagliabue Div., Weston Electrical Instrument Corp., 614 Frelinghuysen Ave., Newark 5, N. J.
- ⊙Tech Laboratories, Inc., Bergen & Edsall Blvd., Palisades Park, N. J.

CONTROLS—Oxygen

- ⊙Communication Products Co., Inc., Marlboro, N. J.
- ⊙Leeds & Northrup Co., 4970 Stenton Ave., Philadelphia 44, Pa.

CONTROLS—Ozone

- ⊙Communication Products Co., Inc., Marlboro, N. J.

CONTROLS—Package Wrapping

- ⊙Deltz Co., S. J., Box 65, West Englewood, N. J.
- ⊙De-Tec-Tronic Laboratories, Inc., 1711 Terra Cotta Pl., Chicago 14, Ill.
- ⊙GENERAL ELECTRIC CO., Schenectady 5, N. Y. ADV. PG. 1 to 22.
- ⊙Industrial Electronics Co., Hanover, Mass.
- ⊙Neomatic Inc., 879 Wellesley Ave., Los Angeles 49, Calif.
- ⊙Photoswitch, Inc., 77 Broadway, Cambridge 42, Mass.
- ⊙POTTER INSTRUMENT CO., INC., 115 Cutter Mill Rd., Great Neck, N. Y. ADV. PG. 318.
- ⊙Ripley Co., Inc., Middletown, Conn.
- ⊙WESTINGHOUSE ELECTRIC CORP., 511 Wood St., P. O. Box 868, Pittsburgh 30, Pa. ADV. PG. 107-113.
- ⊙Worner Electronic Devices, Rankin, Ill.

CONTROLS—pH

- ⊙Beckman Instruments, Inc., 820 Mission St., South Pasadena, Calif.
- ⊙Bristol Co., The, Waterbury 20, Conn.
- ⊙Central Scientific Co., 1700 Irving Park Rd., Chicago 13, Ill.
- ⊙Foxboro Co., The, Foxboro, Mass.
- ⊙LaMotte Chemical Products Co., Towson 4, Baltimore, Md.
- ⊙Leeds & Northrup Co., 4970 Stenton Ave., Philadelphia 44, Pa.
- ⊙MARCONI INSTRUMENTS, LTD., 23 Beaver St., New York 4, N. Y. ADV. PG. 270.
- ⊙MINNEAPOLIS-HONEYWELL REGULATOR CO., INDUSTRIAL DIV., Wayne & Roberts Aves., Philadelphia 44, Pa. ADV. PG. 208, 209.

CONTROLS—Photoelectric

- ⊙Airlotron, Inc., P. O. Box 151, Caldwell, N. J.
- ⊙AIRMEC LABORATORIES LTD., 366 Madison Ave., New York 17, N. Y. ADV. PG. 336.
- ⊙Autotron Co., The, Danville, Ill.
- ⊙BARKER & WILLIAMSON, 235 Fairfield Ave., Upper Darby, Pa. ADV. PG. 292.
- ⊙Berkshire Laboratories, 580 Lexington Rd., Concord, Mass.
- ⊙Deltz Co., S. J., Box 65, West Englewood, N. J.
- ⊙De-Tec-Tronic Laboratories, Inc., 1711 Terra Cotta Pl., Chicago 14, Ill.
- ⊙Edgerton, Germeshausen & Grier, Inc., 160 Brookline Ave., Boston, Mass.
- ⊙Electronic Control Corp., 1573 E. Forest St., Detroit, Mich.
- ⊙Ess Specialty Corp., 96 So. Washington Ave., Bergenfield, N. J.
- ⊙Farrand Optical Co., Inc., Bronx Blvd. at 238th St., New York 70, N. Y.
- ⊙Fisher-Pierce Co., Inc., 170 Pearl St., S. Braintree (Boston 85), Mass.
- ⊙GENERAL ELECTRIC CO., Schenectady 5, N. Y. ADV. PG. 1 to 22.
- ⊙Hart Associates, 8430 Grand River, Detroit 4, Mich.
- ⊙Hoffman Engineering Corp., Anoka, Minn.
- ⊙Industrial Electronics Co., Hanover, Mass.
- ⊙Lumenite Electric Co., 407 S. Dearborn St., Chicago, Ill.
- ⊙McElroy Mfg. Co., Littleton, Mass.
- ⊙Minneapolis-Honeywell Regulator Co., 2753 Fourth Avenue S., Minneapolis, Minn.
- ⊙Monarch Radio & Television Corp., 2430 Atlantic Ave., Brooklyn 33, N. Y.
- ⊙Neomatic Inc., 879 Wellesley Ave., Los Angeles 49, Calif.
- ⊙Photobell Company, 116 Nassau St., New York 7, N. Y.
- ⊙Photoswitch, Inc., 77 Broadway, Cambridge 42, Mass.
- ⊙POTTER INSTRUMENT CO., INC., 115 Cutter Mill Rd., Great Neck, N. Y. ADV. PG. 318.
- ⊙Ripley Co., Inc., Middletown, Conn.
- ⊙Skaneateles Mfg. Co., Inc., 122 Dickerson St., Syracuse 2, N. Y.
- ⊙Standard Electronics Research Corp., 2 East End Ave., New York 21, N. Y.
- ⊙WESTINGHOUSE ELECTRIC CORP., 511 Wood St., P. O. Box 868, Pittsburgh 30, Pa. ADV. PG. 107-113.
- ⊙WESTON ELECTRICAL INSTRUMENT CORP., 595 Frelinghuysen Ave., Newark 5, N. J. ADV. PG. 243.
- ⊙Worner Electronic Devices, Rankin, Ill.

CONTROLS—Photographic Exposure

- ⊙GENERAL ELECTRIC CO., Schenectady 5, N. Y. ADV. PG. 1 to 22.
- ⊙General Photo Products Co., 15 Summit Ave., Chatham, N. J.
- ⊙Industrial Timer Corp., 115 Edison Pl., Newark 5, N. J.
- ⊙Ionic Electronic Equipment Co., 1705 N. Kenmore, Los Angeles 27, Calif.
- ⊙WESTON ELECTRICAL INSTRUMENT CORP., 595 Frelinghuysen Ave., Newark 5, N. J. ADV. PG. 243.

CONTROLS—Positioning

- ⊙AIR ASSOCIATES, INC., Teterboro, N. J. ADV. PG. 211.
- ⊙Airlotron, Inc., P. O. Box 151, Caldwell, N. J.
- ⊙Askania Regulator Co., 240 E. Ontario St., Chicago 11, Ill.
- ⊙Automatic Temperature Control Co., Inc., 5212 Pulaski Ave., Philadelphia 44, Pa.
- ⊙Avion Instrument Corp., Paramus, N. J.
- ⊙Barber Colman Co., Rockford, Ill.
- ⊙BARKER & WILLIAMSON, 235 Fairfield Ave., Upper Darby, Pa. ADV. PG. 292.
- ⊙BELOCK INSTRUMENT CORP., 111th St. & 14th Ave., College Point, N. Y. ADV. PG. 371.
- ⊙Deltz Co., S. J., Box 65, West Englewood, N. J.
- ⊙Doelcam Corp., 56 Elmwood St., Newton 58, Mass.
- ⊙ECLIPSE-PIONEER DIV., Bendix Aviation Corp., Teterboro, N. J. ADV. PG. 198, 199.
- ⊙Flader, Inc., Fredric, 1330 Laskey Rd., Toledo 12, Ohio.
- ⊙Gadgets, Inc., 3629 N. Dixie Drive, Dayton 4, Ohio.
- ⊙GENERAL ELECTRIC CO., Schenectady 5, N. Y. ADV. PG. 1 to 22.
- ⊙Gerett Corp., M. A., 724 W. Winnebago St., Milwaukee 5, Wis.
- ⊙INDUSTRIAL CONTROL CO., Straight Path & Arlington Ave., Wyandanch, N. Y. ADV. PG. 130.
- ⊙Industrial Electronics Co., Hanover, Mass.
- ⊙INDUSTRIAL ELECTRONICS, INC., 8080 Wheeler St., Detroit 10, Mich. ADV. PG. 234, 235.
- ⊙Lear, Inc., 110 Ionia Ave., N. W., Grand Rapids 2, Mich.
- ⊙Minneapolis-Honeywell Regulator Co., 2753 Fourth Ave. S., Minneapolis, Minn.
- ⊙Neomatic Inc., 879 Wellesley Ave., Los Angeles 49, Calif.
- ⊙ORTHON CORP., 196 Albion Ave., Paterson 2, N. J. ADV. PG. 156.
- ⊙PERFECTION ELECTRIC CO., 2635 S. Wabash Ave., Chicago 16, Ill. ADV. PG. 102, 142, 256, 405.
- ⊙REEVES INSTRUMENT CORP., 215 E. 91st St., New York, N. Y. ADV. PG. 315.
- ⊙Robinette Co., W. C., 802 Fair Oaks Ave., South Pasadena, Calif.
- ⊙Schaevitz Engineering, Crescent Blvd. at Drexel Ave., Pennsauken Township, Camden 11, N. J.
- ⊙SERVO CORP. OF AMERICA, 20-20 Jericho Turnpike, New Hyde Park, N. Y. ADV. PG. 150, 151.
- ⊙SERVO-TEK PRODUCTS CO., 4 Godwin Ave., Paterson, N. J. ADV. PG. 356.
- ⊙SUPERIOR ELECTRIC CO., 4000 Church St., Bristol, Conn. ADV. PG. 190, 191.
- ⊙Synchro Start Products, Inc., 1046 W. Fullerton Ave., Chicago 14, Ill.
- ⊙Varo Mfg. Co., Inc., Box 638, Garland, Texas.
- ⊙WESTINGHOUSE ELECTRIC CORP., 511 Wood St., P. O. Box 868, Pittsburgh 30, Pa. ADV. PG. 107-113.

CONTROLS—Power Level

- ⊙PAINTON & CO., INC., LTD., 366 Madison Ave., New York 17, N. Y. ADV. PG. 336.

CONTROLS—Pressure

- ⊙Acro Mfg. Co., Columbus 16, Ohio.
- ⊙AIR ASSOCIATES, INC., Teterboro, N. J. ADV. PG. 211.
- ⊙Askania Regulator Co., 240 E. Ontario St., Chicago 11, Ill.
- ⊙Automatic Temperature Control Co., Inc., 5212 Pulaski Ave., Philadelphia 44, Pa.
- ⊙Bailey Meter Co., 1044 Ivanhoe Rd., Cleveland 10, Ohio.
- ⊙Baldwin-Lima-Hamilton Corp., Paschall P. O. Station, Philadelphia 42, Pa.
- ⊙Bristol Co., The, Waterbury 20, Conn.
- ⊙Coral Designs Div. of Henry G. Dietz Co., 12-16 Astoria Blvd., Long Island City 2, N. Y.
- ⊙Cutler-Hammer, Inc., 411 No. 12th St., Milwaukee 1, Wis.
- ⊙Flader, Inc., Fredric, 1330 Laskey Rd., Toledo 12, Ohio.
- ⊙Foxboro Co., The, Foxboro, Mass.
- ⊙Fulton Syphon Div., Robertshaw-Fulton Controls Co., Knoxville 4, Tenn.
- ⊙General Controls Co., Glendale 1, Calif.
- ⊙GENERAL ELECTRIC CO., Schenectady 5, N. Y. ADV. PG. 1 to 22.
- ⊙Gerett Corp., M. A., 724 W. Winnebago St., Milwaukee 5, Wis.
- ⊙INDUSTRIAL ELECTRONICS, INC., 8080 Wheeler St., Detroit 10, Mich. ADV. PG. 234, 235.
- ⊙Manning, Maxwell & Moore, Inc., Stratford, Conn.
- ⊙MERCROID CORP., 4201 Belmont Ave., Chicago 41, Ill. ADV. PG. 192.
- ⊙Minneapolis-Honeywell Regulator Co., 2753 Fourth Ave. S., Minneapolis, Minn.
- ⊙MINNEAPOLIS-HONEYWELL REGULATOR CO., INDUSTRIAL DIV., Wayne & Roberts Aves., Philadelphia 44, Pa. ADV. PG. 208, 209.
- ⊙Process & Instruments, 60 Greenpoint Ave., Brooklyn 22, N. Y.
- ⊙Ranco, Inc., 601 W. Fifth Ave., Columbus, Ohio.
- ⊙Robinette Co., W. C., 802 Fair Oaks Ave., South Pasadena, Calif.

V indicates . . . **IN PRODUCTION • AVAILABILITY • UNRESTRICTED FOR GENERAL USE**

- Ⓢ Spencer Thermostat Div. Metals & Controls Corp., 34 Forest St., Attleboro, Mass.
- Ⓢ Tagliabue Div., Weston Electrical Instrument Corp., 614 Frelinghuysen Ave., Newark 5, N. J.
- Ⓢ U. S. Gauge Div., American Machine & Metals, Inc., Sellersville, Pa.
- Ⓢ Wallace & Tiernan Products, Inc., Belleville 9, N. J.
- Ⓢ WESTINGHOUSE ELECTRIC CORP., 511 Wood St., P. O. Box 868, Pittsburgh 30, Pa. ADV. PG. 107-113.

CONTROLS—Printing

- Ⓢ Askania Regulator Co., 240 E. Ontario St., Chicago 11, Ill.
- Ⓢ Cutler-Hammer, Inc., 411 N. 12th St., Milwaukee 1, Wis.
- Ⓢ Electric Eye Equipment Co., 16 W. Fairchild St., Danville, Ill.
- Ⓢ Electron Equipment Corp., 917 Meridian Ave., South Pasadena, Calif.
- Ⓢ GENERAL ELECTRIC CO., Schenectady 5, N. Y. ADV. PG. 1 to 22.
- Ⓢ Industrial Electronics Co., Hanover, Mass.
- Ⓢ Robinette Co., W. C., 802 Fair Oaks Ave., South Pasadena, Calif.
- Ⓢ WESTINGHOUSE ELECTRIC CORP., 511 Wood St., P. O. Box 868, Pittsburgh 30, Pa. ADV. PG. 107-113.

CONTROLS—Radio Remote

- Ⓢ Aeronautical Communications Equipment, Inc., 3090 Douglas Rd., Miami 33, Fla.
- Ⓢ Aeronautical Electronics, Inc., Raleigh-Durham Airport, P. O. Box 6043, Raleigh, N. C.
- Ⓢ AIR ASSOCIATES, INC., Teterboro, N. J. ADV. PG. 211.
- Ⓢ AMERICAN ELECTRONEERING CORP., 5025-29 W. Jefferson Blvd., Los Angeles 16, Calif. ADV. PG. 136.
- Ⓢ Avion Instrument Corp., Paramus, N. J.
- Ⓢ BARKER & WILLIAMSON, 235 Fairfield Ave., Upper Darby, Pa. ADV. PG. 292.
- Ⓢ Bassett, Inc., Rex, 307-11 N.W. First Ave., Fort Lauderdale, Fla.
- Ⓢ Breloco Electronics Corp., 55 Vandam St., New York 13, N. Y.
- Ⓢ Bunnell & Co., J. H., 81 Prospect St., Brooklyn, N. Y.
- Ⓢ Collins Radio Co., Cedar Rapids, Iowa.
- Ⓢ Communications Co., Inc., 300 Greco Ave., Coral Gables 34, Fla.
- Ⓢ Custom Craft Mfg. Co., 256 E. 98th St., Brooklyn, N. Y.
- Ⓢ Gasket Engineering Co., 2440 Charlotte St., Kansas City 8, Mo.
- Ⓢ Hastings Instrument Co., Inc., Hampton 9, Va.
- Ⓢ Intervox Corp., 2701 California Ave., Seattle 6, Wash.
- Ⓢ Kupfrian Mfg. Co., 218 Prospect Ave., Binghamton, N. Y.
- Ⓢ Lear, Inc., 110 Ionia Ave., N. W., Grand Rapids 2, Mich.
- Ⓢ Monarch Radio & Television Corp., 2430 Atlantic Ave., Brooklyn 33, N. Y.
- Ⓢ Motorola, Inc., 4545 Augusta Blvd., Chicago 51, Ill.
- Ⓢ RADIO CORP. OF AMERICA, RCA Victor Div., General Offices, Camden, N. J. ADV. PG. 177, Inside Back & Back Covers.
- Ⓢ Radiomarine Corp. of America, 75 Varick St., New York 13, N. Y.
- Ⓢ SPERRY GYROSCOPE CO., Div. of The Sperry Corp., Great Neck, N. Y. ADV. PG. 103, 104.
- Ⓢ Weltron Co., 19500 W. Eight Mile Rd., Detroit 9, Mich.
- Ⓢ WHITE DENTAL MFG. CO., S. S., Industrial Div., 10 E. 40th St., New York, N. Y. ADV. PG. 291.
- Ⓢ Wilcox Electric Co., 1400 Chestnut St., Kansas City, Mo.

CONTROLS—Register

- Ⓢ Aircraft Electronics Associates, Inc., 94 Silas Deane Highway, Rock Hill, Conn.
- Ⓢ Airlectron, Inc., P. O. Box 151, Caldwell, N. J.
- Ⓢ Askania Regulator Co., 240 E. Ontario St., Chicago 11, Ill.
- Ⓢ Deitz Co., S. J., Box 65, W. Englewood, N. J.
- Ⓢ Electric Eye Equipment Co., 16 W. Fairchild St., Danville, Ill.
- Ⓢ Fisher-Pierce Co., Inc., 170 Pearl St., S. Braintree (Boston 85), Mass.
- Ⓢ GENERAL ELECTRIC CO., Schenectady 5, N. Y. ADV. PG. 1 to 22.
- Ⓢ Industrial Electronics Co., Hanover, Mass.
- Ⓢ Photoswitch, Inc., 77 Broadway, Cambridge 42, Mass.
- Ⓢ Ripley Co., Inc., Middletown, Conn.
- Ⓢ WESTINGHOUSE ELECTRIC CORP., 511 Wood St., P. O. Box 868, Pittsburgh 30, Pa. ADV. PG. 107-113.

CONTROLS—Register Cutter

- Ⓢ Airlectron, Inc., P. O. Box 151, Caldwell, N. J.
- Ⓢ Deitz Co., S. J., Box 65, W. Englewood, N. J.
- Ⓢ GENERAL ELECTRIC CO., Schenectady 5, N. Y. ADV. PG. 1 to 22.

- Ⓢ Industrial Electronics Co., Hanover, Mass.
- Ⓢ Photobell Company, 116 Nassau St., New York 7, N. Y.
- Ⓢ Photoswitch, Inc., 77 Broadway, Cambridge 42, Mass.
- Ⓢ WESTINGHOUSE ELECTRIC CORP., 511 Wood St., P. O. Box 868, Pittsburgh 30, Pa. ADV. PG. 107-113.

CONTROLS—Servo

- Ⓢ Adel Div. of General Metals Corp., 10777 Van Owen St., Burbank, Calif.
- Ⓢ AIR ASSOCIATES, INC., Teterboro, N. J. ADV. PG. 211.
- Ⓢ Arlington Electric Products Inc., 500 W. 52nd St., New York 19, N. Y.
- Ⓢ Arma Corp., 254 36th St., Brooklyn, 32, N. Y.
- Ⓢ Askania Regulator Co., 240 E. Ontario St., Chicago 11, Ill.
- Ⓢ Atlantic Electronics, 4 Manhasset Ave., Manorhaven, N. Y.
- Ⓢ Automatic Temperature Control Co., Inc., 5212 Pulaski Ave., Philadelphia 44, Pa.
- Ⓢ Avion Instrument Corp., Paramus, N. J.
- Ⓢ BARKER & WILLIAMSON, 235 Fairfield Ave., Upper Darby, Pa. ADV. PG. 292.
- Ⓢ BELOCK INSTRUMENT CORP., 111th St. & 14th Ave., College Point, N. Y. ADV. PG. 371.
- Ⓢ Bunnell & Co., J. H., 81 Prospect St., Brooklyn, N. Y.
- Ⓢ ECLIPSE-PIONEER DIV. BENDIX AVIATION CORP., Teterboro, N. J. ADV. PG. 198, 199.
- Ⓢ Flader, Inc., Fredric, 1330 Laskey Rd., Toledo 12, Ohio.
- Ⓢ GENERAL ELECTRIC CO., Schenectady 5, N. Y. ADV. PG. 1 to 22.
- Ⓢ INDUSTRIAL CONTROL CO., Straight Path & Arlington Ave., Wyandanch, N. Y. ADV. PG. 130.
- Ⓢ Jarvis Electronics Corp., 6058 W. Fullerton Ave., Chicago 38, Ill.
- Ⓢ Ketay Mfg. Corp., 555 Broadway, New York, N. Y.
- Ⓢ Lear, Inc., 110 Ionia Ave., NW, Grand Rapids 2, Mich.
- Ⓢ Minnesota Electronics Corp., 47 W. Water St., St. Paul 1, Minn.
- Ⓢ Northeastern Engineering Inc., Manchester, N. H.
- Ⓢ ORTHON CORP., 196 Albion Ave., Paterson 2, N. J. ADV. PG. 156.
- Ⓢ Philbrick Researches, Inc., George A., 230 Congress St., Boston 10, Mass.
- Ⓢ Press Wireless Mfg. Co., Inc., Cantiague Rd., Hicksville, N. Y.
- Ⓢ REEVES INSTRUMENT CORP., 215 E. 91st St., New York, N. Y. ADV. PG. 315.
- Ⓢ Robinette Co., W. C., 802 Fair Oaks Ave., South Pasadena, Calif.
- Ⓢ SERVO CORP. OF AMERICA, 20-20 Jericho Turnpike, New Hyde Park, N. Y. ADV. PG. 150, 151.
- Ⓢ SERVO-TEK PRODUCTS CO., 4 Godwin Ave., Paterson, N. J. ADV. PG. 356.
- Ⓢ SERVOMECHANISMS, INC., Whaleneck Rd. & Stewart Ave., Westbury, L. I., N. Y. ADV. PG. 188.
- Ⓢ SHERRON ELECTRONICS CO., 1201 Flushing Ave., Brooklyn 6, N. Y. ADV. PG. 145.
- Ⓢ SPERRY GYROSCOPE CO., Div. of The Sperry Corp., Great Neck, N. Y. ADV. PG. 103, 104.
- Ⓢ Standard Electronics Research Corp., 2 East End Ave., New York 21, N. Y.
- Ⓢ TRANSICOID CORP., 107 Grand St., New York, N. Y. ADV. PG. 116.
- Ⓢ Trans-Sonics, Inc., Bedford Airport, Bedford, Mass.
- Ⓢ VECTRON, INC., 235 High St., Waltham, Mass. ADV. PG. 214.
- Ⓢ WESTINGHOUSE ELECTRIC CORP., 511 Wood St., P. O. Box 868, Pittsburgh 30, Pa. ADV. PG. 107-113.

CONTROLS—Skew

- Ⓢ Avion Instrument Corp., Paramus, N. J.
- Ⓢ Industrial Electronics Co., Hanover, Mass.

CONTROLS—Smoke & Combustion

- Ⓢ Bailey Meter Co., 1044 Ivanhoe Rd., Cleveland, Ohio.
- Ⓢ Combustion Control Corp., 77 Broadway, Cambridge 42, Mass.
- Ⓢ Deitz Co., S. J., Box 65, W. Englewood, N. J.
- Ⓢ De-Tec-Tronic Laboratories, Inc., 1711 Terra Cotta Pl., Chicago 14, Ill.
- Ⓢ Edwards Co., Inc., 86 Boston Post Rd., Norwalk, Conn.
- Ⓢ Electronic Control Corp., 1573 E. Forest St., Detroit, Mich.
- Ⓢ Ess Specialty Corp., 96 So. Washington Ave., Bergenfield, N. J.
- Ⓢ GENERAL ELECTRIC CO., Schenectady 5, N. Y. ADV. PG. 1 to 22.
- Ⓢ Industrial Electronics Co., Hanover, Mass.
- Ⓢ Leeds & Northrup Co., 4970 Stenton Ave., Philadelphia 44, Pa.
- Ⓢ Lumenite Electric Co., 407 S. Dearborn St., Chicago 5, Ill.
- Ⓢ Paragon Electric Co., Two Rivers, Wisconsin.
- Ⓢ Photobell Company, 116 Nassau St., New York 7, N. Y.
- Ⓢ Ripley Co., Inc., Middletown, Conn.
- Ⓢ Worner Electronic Devices, Rankin, Ill.

CONTROLS—Sound System

- Ⓢ Carter Parts Co., 213 Institute Place, Chicago 10, Ill.
- Ⓢ CINEMA ENGINEERING CO., 1510 W. Verdugo Ave., Burbank, Calif. ADV. PG. 204.
- Ⓢ CLAROSTAT MFG. CO., INC., Dover, N. H. ADV. PG. 100, 101.
- Ⓢ DAVEN CO., 191 Central Ave., Newark 4, N. J. ADV. PG. 157.
- Ⓢ Edwards Co., Inc., 86 Boston Post Rd., Norwalk, Conn.
- Ⓢ Gale Dorothea Mechanisms, 37-61 85th St., Jackson Heights, N. Y.
- Ⓢ Hose-McCann Telephone Co., Inc., 25th St. & 3rd Ave., Brooklyn 32, N. Y.
- Ⓢ Lear, Inc., 110 Ionia Ave., NW, Grand Rapids 2, Mich.
- Ⓢ Montgomery Mfg. Co., 204 S. Main St., Owensville, Ind.
- Ⓢ Operadio Mfg. Co., 135th & Indiana Sts., St. Charles, Ill.
- Ⓢ PAINTON & CO., INC., LTD., 366 Madison Ave., New York 17, N. Y. ADV. PG. 336.
- Ⓢ RADIO CORP. OF AMERICA, RCA Victor Div., General Offices, Camden, N. J. ADV. PG. 177, Inside Back & Back Covers.
- Ⓢ Rauland-Borg Corp., 3523 W. Addison St., Chicago 18, Ill.
- Ⓢ Waveforms, Inc., 333 Sixth Ave., New York 14, N. Y.
- Ⓢ Wirt Co., 5221 Greene St., Philadelphia 44, Pa.

CONTROLS—Specific Gravity

- Ⓢ Askania Regulator Co., 240 E. Ontario St., Chicago 11, Ill.
- Ⓢ Fielden Instrument Corp., 2920 N. 4th St., Philadelphia 33, Pa.
- Ⓢ Fischer & Porter Co., Hatboro, Pa.
- Ⓢ Industrial Electronics Co., Hanover, Mass.
- Ⓢ Leeds & Northrup Co., 4970 Stenton Ave., Philadelphia 44, Pa.
- Ⓢ MINNEAPOLIS-HONEYWELL REGULATOR CO., INDUSTRIAL DIV., Wayne & Roberts Aves., Philadelphia 44, Pa. ADV. PG. 208, 209.
- Ⓢ Thermo Instruments Co., Box 336, Belmont, Calif.

CONTROLS—Strain

- Ⓢ Baldwin-Lima-Hamilton Corp., Paschal P.O. Station, Philadelphia 42, Pa.
- Ⓢ Gerett Corp., M. A., 724 W. Winnebago St., Milwaukee 4, Wis.
- Ⓢ INDUSTRIAL ELECTRONICS, INC., 8080 Wheeler St., Detroit 10, Mich. ADV. PG. 234, 235.
- Ⓢ Leeds & Northrup Co., 4970 Stenton Ave., Philadelphia 44, Pa.

CONTROLS—Temperature

See Also Pyrometers

- Ⓢ Acro Mfg. Co., 2040 E. Main St., Columbus, Ohio.
- Ⓢ AIR ASSOCIATES, INC., Teterboro, N. J. ADV. PG. 211.
- Ⓢ American Instrument Co., 8030 Georgia Ave., Silver Spring, Md.
- Ⓢ Askania Regulator Co., 240 E. Ontario St., Chicago 16, Ill.
- Ⓢ Assembly Products, Inc., Chagrin Falls 6, Ohio.
- Ⓢ Atlantic Electronics, 4 Manhasset Ave., Manorhaven, N. Y.
- Ⓢ Automatic Temperature Control Co., Inc., 5212 Pulaski Ave., Philadelphia 44, Pa.
- Ⓢ Bailey Meter Co., 1044 Ivanhoe Rd., Cleveland 10, Ohio.
- Ⓢ Barber-Colman Co., Rockford, Ill.
- Ⓢ Bristol Co., The, Waterbury 20, Conn.
- Ⓢ Burling Instrument Co., 5 Vose Ave., South Orange, N. J.
- Ⓢ Central Scientific Co., 1700 Irving Park Rd., Chicago 13, Ill.
- Ⓢ Cutler-Hammer, Inc., 411 N. 12th St., Milwaukee 1, Wis.
- Ⓢ EDISON INC., THOMAS A., Instrument Div., West Orange, N. J. ADV. PG. 212, 213.
- Ⓢ Edwards Co., Inc., 86 Boston Post Rd., Norwalk, Conn.
- Ⓢ ELECTRIC SOLDERING IRON CO., W. Elm St., Deep River, Conn. ADV. PG. 68.
- Ⓢ Electronic Control Corp., 1573 E. Forest St., Detroit, Mich.
- Ⓢ Fielden Instrument Corp., 2920 N. 4th St., Philadelphia 33, Pa.
- Ⓢ Fenwal Inc., 43 Pleasant St., Ashland, Mass.
- Ⓢ Fischer & Porter Co., Hatboro, Pa.
- Ⓢ Foxboro Co., The, Foxboro, Mass.
- Ⓢ Fulton Syphon Div., Robertshaw-Fulton Controls Co., Knoxville 4, Tenn.
- Ⓢ General Controls Co., Glendale 1, Calif.
- Ⓢ GENERAL ELECTRIC CO., Schenectady 5, N. Y. ADV. PG. 1 to 22.
- Ⓢ Gordon Co., Claud S., 3000 S. Wallace St., Chicago 16, Ill.
- Ⓢ G-V Controls, Inc., 28 Hollywood Plaza, East Orange, N. J.
- Ⓢ Illinois Testing Labs., Inc., 420 N. LaSalle St., Chicago 10, Ill.
- Ⓢ INDUSTRIAL ELECTRONICS, INC., 8080 Wheeler St., Detroit 10, Mich. ADV. PG. 234, 235.

V indicates . . . IN PRODUCTION • AVAILABILITY • UNRESTRICTED FOR GENERAL USE

- ①Lear, Inc., 110 Ionia Ave., NW., Grand Rapids 2, Mich.
- ①Leeds & Northrup Co., 4970 Stenton Ave., Philadelphia 44, Pa.
- ①Loudon Instruments, Inc., 5644 Lake Park Ave., Chicago 44, Ill.
- ①Macdonald & Co., Inc., W. S., 33 University Rd., Cambridge 38, Mass.
- ①Manning, Maxwell & Moore, Inc., Stratford, Conn.
- ①McQuay-Norris Mfg. Co., 2320 Marconi Ave., St. Louis 10, Mo.
- ①MERCROID CORP., 4201 Belmont Ave., Chicago 41, Ill. ADV. PG. 192.
- ①Meters, Inc., 915 Westfield Blvd., Indianapolis 20, Ind.
- ①Minneapolis-Honeywell Regulator Co., 2753 Fourth Ave. S., Minneapolis, Minn.
- ①MINNEAPOLIS-HONEYWELL REGULATOR CO., INDUSTRIAL DIV., Wayne & Roberts Aves., Philadelphia 44, Pa. ADV. PG. 208, 209.
- ①Neomatic Inc., 879 Wellesley Ave., Los Angeles 49, Calif.
- ①Philadelphia Thermometer Co., 4401 N. Sixth St., Philadelphia, Pa.
- ①Phico Corp., Tioga & C Sts., Philadelphia 34, Pa. Process & Instruments, 60 Greenpoint Ave., Brooklyn 22, N. Y.
- ①Ranco, Inc., 601 W. Fifth Ave., Columbus, Ohio.
- ①SERVO CORP. OF AMERICA, 20-20 Jericho Turnpike, New Hyde Park, N. Y. ADV. PG. 150, 151.
- ①Spencer Thermostat Div. Metals & Controls Corp., 34 Forest St., Attleboro, Mass.
- ①Standard Electronics Research Corp., 2 East End Ave., New York 21, N. Y.
- ①STEVENS MFG. CO., INC., 69 S. Walnut St., Mansfield, Ohio. ADV. PG. 334.
- ①Tagliabue Div., Weston Electrical Instrument Corp., 614 Frelinghuysen Ave., Newark 5, N. Y.
- ①TENNEY ENGINEERING, INC., 26 Avenue B, Newark 5, N. J. ADV. PG. 98.
- ①Trans-Sonics, Inc., Bedford Airport, Bedford, Mass.
- ①Ulanet Co., George, 413 Market St., Newark 5, N. J.
- ①U. S. Gauge Div., American Machine & Metals, Inc., Sellersville, Pa.
- ①Waage Electric Inc., 54 Park Place, New York 7, N. Y.
- ①WESTINGHOUSE ELECTRIC CORP., 511 Wood St., P. O. Box 868, Pittsburgh 30, Pa. ADV. PG. 107-113.
- ①Wheelco Instruments Co., 847 W. Harrison St., Chicago 7, Ill.

CONTROLS—Tentering

- ①Airlectron, Inc., P. O. Box 151, Caldwell, N. J.
- ①Automatic Temperature Control Co., Inc., 5212 Pulaski Ave., Philadelphia 44, Pa.
- ①WESTINGHOUSE ELECTRIC CORP., 511 Wood St., P. O. Box 868, Pittsburgh 30, Pa. ADV. PG. 107-113.

CONTROLS—Timing

- ①Adams & Westlake Co., Michigan St., Elkhart, Ind.
- ①Airborne Electronics Co., Metropolitan Airport; Hangar No. 3, Van Nuys, Calif.
- ①AIRMEC LABORATORIES LTD., 366 Madison Ave., New York 17, N. Y. ADV. PG. 336.
- ①AMERICAN GAS ACCUMULATOR CO., 1029 Newark Ave., Elizabeth 3, N. J. ADV. PG. 76.
- ①American Scientific Co., P. O. Box 11, High Bridge Station, New York 52, N. Y.
- ①ATOMIC INSTRUMENT CO., 84 Massachusetts Ave., Cambridge 39, Mass. ADV. PG. 410.
- ①Automatic Temperature Control Co., Inc., 5212 Pulaski Ave., Philadelphia 44, Pa.
- ①Bristol Co., The, Waterbury 20, Conn.
- ①Condor Radio Mfg. Co., 631 Whipple, Prescott, Ariz.
- ①CRAMER CO., INC., R. W., Box 13, Centerbrook, Conn. ADV. PG. 202.
- ①Cutler-Hammer, Inc., 411 No. 12th St., Milwaukee 1, Wis.
- ①Deitz Co., S. J., Box 65, West Englewood, N. J.
- ①Durakool, Inc., 1010 N. Main St., Elkhart, Ind.
- ①Eagle Signal Corp., Moline, Illinois.
- ①Edgerton, Gerneshausen & Grier, Inc., 160 Brookline Ave., Boston, Mass.
- ①Edwards Co., Inc., 86 Boston Post Rd., Norwalk, Conn. Electronic Brazing Co., 140 Glenridge Ave., Montclair, N. J.
- ①Electronic Control Corp., 1573 E. Forest St., Detroit, Mich.
- ①Farmer Electric Co., 21 Mossfield Rd., Waban 68, Mass.
- ①Federal Tool Engineering Co., 532 Mulberry St., Newark 5, N. J.
- ①Gale Dorothea Mechanisms, 37-61 85th St., Jackson Heights, N. Y.
- ①General Control Company, 1200 Soldiers Field Rd., Boston 34, Mass.
- ①GENERAL ELECTRIC CO., Schenectady 5, N. Y. ADV. PG. 1 to 22.
- ①Gerett Corp., M. A., 724 W. Winnebago St., Milwaukee 5, Wis.
- ①Gorrell & Gorrell, Haworth, N. J.
- ①G-V Controls, Inc., 28 Hollywood Plaza, East Orange, N. J.

- ①HAYDON CO., A. W., The, 232 N. Elm St., Waterbury 20, Conn. ADV. PG. 402.
- ①HAYDON MFG. CO., INC., 584 E. Elm St., Torrington, Conn. ADV. PG. 216, 217.
- ①Industrial Electronics Co., Hanover, Mass.
- ①Industrial Timer Co., 115 Edison Pl., Newark 5, N. J.
- ①Ingraham Co., E., Bristol, Conn.
- ①Ionic Electronic Equipment Co., 1705 N. Kenmore, Los Angeles 27, Calif.
- ①Lear, Inc., 110 Ionia Ave., N. W., Grand Rapids 2, Mich.
- ①Lektra Laboratories, 154-11th Ave., New York 3, N. Y.
- ①Lumenite Electric Co., 407 S. Dearborn St., Chicago 5, Ill.
- ①Mallory & Co., Inc., P. R., 3029 E. Washington St., Indianapolis 6, Ind.
- ①Minnesota Electronics Corp., 47 W. Water St., St. Paul 1, Minn.
- ①Montgomery Mfg. Co., 204 S. Main St., Owensville, Ind.
- ①Neomatic Inc., 879 Wellesley Ave., Los Angeles 49, Calif.
- ①Northeastern Engineering, Inc., Manchester, N. H.
- ①Paragon Electric Co., Two Rivers, Wisconsin.
- ①Photoswitch, Inc., 77 Broadway, Cambridge 42, Mass.
- ①POTTER INSTRUMENT CO., INC., 115 Cutter Mill Rd., Great Neck, N. Y. ADV. PG. 318.
- ①Ripley Co., Inc., Middletown, Conn.
- ①Sherman Industrial Electronics Co., Inc., 505 Washington Ave., Belleville 9, N. J.
- ①Special Instruments Laboratories, Inc., 1003 Highland Ave., Knoxville, Tenn.
- ①STANDARD ELECTRIC TIME CO., 89 Logan St., Springfield, Mass. ADV. PG. 40.
- ①Tork Clock Co., Inc., 1 Grove St., Mt. Vernon, N. Y.
- ①Ulanet Co., George, 413 Market St., Newark 5, N. J.
- ①Varo Mfg. Co., Inc., Box 638, Garland, Texas.
- ①Weltron Co., 19500 W. Eight Mile Rd., Detroit 19, Mich.
- ①Western Gold & Platinum Works, 589 Bryant St., San Francisco, Calif.
- ①WESTINGHOUSE ELECTRIC CORP., 511 Wood St., P. O. Box 868, Pittsburgh 30, Pa. ADV. PG. 107-113.
- ①Wilson & Co., G. C., 2 N. Passaic Ave., Chatham, N. J.

CONTROLS—Torque

- ①AIR ASSOCIATES, INC., Teterboro, N. J. ADV. PG. 211.
- ①Atlas Metal Stamping Co., Castor & Kensington Aves., Philadelphia 24, Pa.
- ①Automatic Temperature Control Co., Inc., 5212 Pulaski Ave., Philadelphia 44, Pa.
- ①Avion Instrument Corp., Paramus, N. J.
- ①Baldwin-Lima-Hamilton Corp., Paschall P. O. Station, Philadelphia 42, Pa.
- ①ECLIPSE-PIONEER DIV. BENDIX AVIATION CORP., Teterboro, N. J. ADV. PG. 198, 199.
- ①INDUSTRIAL CONTROL CO., Straight Path & Arlington Ave., Wyandanch, N. Y. ADV. PG. 130.
- ①INDUSTRIAL ELECTRONICS, INC., 8080 Wheeler St., Detroit 10, Mich. ADV. PG. 234, 235.
- ①Ingraham Co., E., Bristol, Conn.
- ①Lear, Inc., 110 Ionia Ave., N. W., Grand Rapids 2, Mich.
- ①Robinette Co., W. C., 802 Fair Oaks Ave., South Pasadena, Calif.
- ①SERVO-TEK PRODUCTS CO., 4 Godwin Ave., Paterson, N. J. ADV. PG. 356.

CONTROLS—Turbidity

- ①Electric Eye Equipment Co., 16 W. Fairchild St., Danville, Ill.
- ①Photobell Company, 116 Nassau St., New York 7, N. Y.
- ①Thompson & Associates, John E., 7210 S. Yates Ave., Chicago 49, Ill.
- ①Worner Electronics Devices, Rankin, Ill.

CONTROLS—Ultrasonic

- ①BRUSH DEVELOPMENT CO., 3405 Perkins Ave., Cleveland 14, Ohio. ADV. PG. 228, 229.
- ①DAVEN CO., 191 Central Ave., Newark 4, N. J. ADV. PG. 157.
- ①Edo Corp., College Point, N. Y.
- ①Rich-Roth Labs., East Hartford, Conn.
- ①Vendo Co., 7400 E. 12th St., Kansas City 8, Mo.

CONTROLS—Vacuum

- ①Automatic Temperature Control Co., Inc., 5212 Pulaski Ave., Philadelphia 44, Pa.
- ①Bailey Meter Co., 1044 Ivanhoe Rd., Cleveland 10, Ohio.
- ①Bristol Co., The, Waterbury 20, Conn.
- ①Coral Designs Div. of Henry G. Dietz Co., 12-16 Astoria Blvd., Long Island City 2, N. Y.
- ①Cutler-Hammer, Inc., 411 N. 12th St., Milwaukee 1, Wis.

- ①Distillation Products Div. of Eastman Kodak Co., 755 Ridge Rd. W., Rochester 3, N. Y.
- ①Electronic Engineering Corp., 469 Elm St., Arlington, N. J.
- ①GENERAL ELECTRIC CO., Schenectady 5, N. Y. ADV. PG. 1 to 22.
- ①Hastings Instrument Co., Inc., Hampton 9, Va.
- ①MERCROID CORP., 4201 Belmont Ave., Chicago 41, Ill. ADV. PG. 192.
- ①Minneapolis-Honeywell Regulator Co., 2753 Fourth Ave. S., Minneapolis, Minn.
- ①MINNEAPOLIS-HONEYWELL REGULATOR CO., INDUSTRIAL DIV., Wayne & Roberts Aves., Philadelphia 44, Pa. ADV. PG. 208, 209.
- ①National Research Corp., 70 Memorial Drive, Cambridge 42, Mass.
- ①Process & Instruments, 60 Greenpoint Ave., Brooklyn 20, N. Y.
- ①Skaneateles Mfg. Co., Inc., 122 Dickerson St., Syracuse 2, N. Y.
- ①Tagliabue Div., Weston Electrical Corp., 614 Frelinghuysen Ave., Newark 5, N. J.
- ①U. S. Gauge Div., American Machine & Metals, Inc., Sellersville, Pa.
- ①Wallace & Tiernan Products, Inc., Belleville 9, N. J.
- ①Weltron Co., 19500 W. Eight Mile Rd., Detroit 9, Mich.
- ①Winslow Co., Inc., 9 Liberty St., Newark 5, N. J.

CONTROLS—Ventilating Control System

- ①Automatic Temperature Control Co., Inc., 5212 Pulaski Ave., Philadelphia 44, Pa.
- ①Barber Colman Co., Rockford, Ill.
- ①Coral Designs Div. of Henry G. Dietz Co., 12-16 Astoria Blvd., Long Island City 2, N. Y.
- ①De-Tec-Tronic Laboratories, Inc., 1711 Terra Cotta Pl., Chicago 14, Ill.
- ①Edwards Co., Inc., 86 Boston Post Rd., Norwalk, Conn.
- ①General Controls Co., Glendale 1, Calif.
- ①GENERAL ELECTRIC CO., Schenectady 5, N. Y. ADV. PG. 1 to 22.
- ①Industrial Electronics Co., Hanover, Mass.
- ①Lear, Inc., 110 Ionia Ave., NW., Grand Rapids 2, Mich.
- ①MERCROID CORP., 4201 Belmont Ave., Chicago, Ill. ADV. PG. 192.
- ①Minneapolis-Honeywell Regulator Co., 2753 Fourth Ave. S., Minneapolis, Minn.
- ①Photoswitch, Inc., 77 Broadway, Cambridge 42, Mass.
- ①Robinette Co., W. C., 802 Fair Oaks Ave., South Pasadena, Calif.
- ①ROTRON MFG. CO., 7-9 Schoonmaker Lane, Woodstock, N. Y. ADV. PG. 410.
- ①WESTINGHOUSE ELECTRIC CORP., 511 Wood St., P. O. Box 868, Pittsburgh 30, Pa. ADV. PG. 107-113.
- ①Worner Electronic Devices, Rankin, Ill.

CONTROLS—Volume & Tone

- ①Allen-Bradley Co., 136 W. Greenfield Ave., Milwaukee 4, Wis.
- ①Astatic Corp., The, Conneaut, Ohio.
- ①Carter Parts Co., 213 Institute Place, Chicago 10, Ill.
- ①CENTRALAB DIV. of Globe Union, Inc., 900 E. Keefe Ave., Milwaukee 1, Wis. ADV. PG. 85-88.
- ①CHICAGO TELEPHONE SUPPLY CORP., 1142 W. Beardsley Ave., Elkhart, Ind. ADV. PG. 78, 79.
- ①CLAROSTAT MFG. CO., INC., Dover, N. H. ADV. PG. 100, 101.
- ①DAVEN CO., 191 Central Ave., Newark 4, N. J. ADV. PG. 157.
- ①INTERNATIONAL RESISTANCE CO., 401 N. Broad St., Philadelphia 8, Pa. ADV. PG. 134, 135.
- ①Mallory & Co., Inc., P. R., 3029 E. Washington St., Indianapolis 6, Ind.
- ①OHMITE MFG. CO., 4835 W. Flournoy St., Chicago 44, Ill. ADV. PG. 41.
- ①PAINTON & CO., INC., LTD., 366 Madison Ave., New York 17, N. Y. ADV. PG. 336.
- ①Philco Corp., Tioga & C Sts., Philadelphia 34, Pa.
- ①Precision Electronic Components Ltd., P. O. Box 264, Grandby, Quebec, Canada.
- ①STACKPOLE CARBON CO., St. Mary's Pa. ADV. PG. 170, 171.
- ①Tech Laboratories, Inc., Bergen & Edsall Blvds., Palisades Park, N. J.
- ①Wirt Co., 5221 Greene St., Philadelphia 44, Pa.

CONTROLS—Weight

- ①Automatic Temperature Control Co., Inc., 5212 Pulaski Ave., Philadelphia 44, Pa.
- ①De-Tec-Tronic Laboratories, Inc., 1711 Terra Cotta Pl., Chicago 14, Ill.
- ①INDUSTRIAL ELECTRONICS, INC., 8080 Wheeler St., Detroit 10, Mich. ADV. PG. 234, 235.
- ①Intervox Corp., 2701 California Ave., Seattle 6, Wash.
- ①Leeds & Northrup Co., 4970 Stenton Ave., Philadelphia 44, Pa.
- ①Streeter-Amet Corp., 4101 N. Ravenswood Ave., Chicago 13, Ill.

V indicates . . . IN PRODUCTION • AVAILABILITY • UNRESTRICTED FOR GENERAL USE

CONTROLS—Welding

- Ⓞ Federal Tool Engineering Co., 532 Mulberry St., Newark 5, N. J.
- Ⓞ GENERAL ELECTRIC CO., Schenectady 5, N. Y. ADV. PG. 1 to 22.
- Ⓞ Industrial Electronics Co., Hanover, Mass.
- Ⓞ OHMITE MFG. CO., 4835 W. Flournoy St., Chicago 44, Ill. ADV. PG. 41.
- Ⓞ Photoswitch, Inc., 77 Broadway, Cambridge 42, Mass.
- Ⓞ PRATHEON MFG. CO., Equipment Sales Div., Waltham 54, Mass. ADV. PG. 80, 81.
- Ⓞ Robotron Corp., 5570 W. Chicago Blvd., Detroit 4, Mich.
- Ⓞ Scialoy Bros., Inc., 4915 W. 67th St., Chicago 38, Ill.
- Ⓞ Weltronic Co., 19500 W. Eight Mile Rd., Detroit 19, Mich.
- Ⓞ WESTINGHOUSE ELECTRIC CORP., 511 Wood St., P. O. Box 868, Pittsburgh 30, Pa. ADV. PG. 107-113.

CONVERTERS—f-m

- Ⓞ Bunnell & Co., J. H., 81 Prospect St., Brooklyn, N. Y.
- Ⓞ MEASUREMENTS CORP., Boonton, N. J. ADV. PG. 99.
- Ⓞ Monarch Radio & Television Corp., 2430 Atlantic Ave., Brooklyn 33, N. Y.
- Ⓞ Peek, Inc., Walter E., 132 E. 44th St., Indianapolis, Ind.

CONVERTERS—Frequency Shift

- Ⓞ AIR ASSOCIATES, INC., Teterboro, N. J. ADV. PG. 211.
- Ⓞ BARKER & WILLIAMSON, 235 Fairfield Ave., Upper Darby, Pa. ADV. PG. 292.
- Ⓞ Boehme, Inc., H. O., 915 Broadway, New York 10, N. Y.
- Ⓞ Bunnell & Co., J. H., 81 Prospect St., Brooklyn, N. Y.
- Ⓞ Erco Radio Labs., Inc., East Stewart Ave., Garden City, N. Y.
- Ⓞ McElroy Mfg. Corp., Littleton, Mass.
- Ⓞ NORTHERN RADIO CO., INC., 143-145 W. 22nd St., New York 11, N. Y. ADV. PG. 262, 263.
- Ⓞ Press Wireless Mfg. Co., Inc., Cantiague Rd., Hicksville, N. Y.
- Ⓞ Radio Frequency Labs., Inc., Boonton 2, N. J.
- Ⓞ Technical Materiel Corp., The, P. O. Box 142, 121 Spencer Place, Mamaroneck, N. Y.
- Ⓞ Varo Mfg. Co., Inc., Box 638, Garland, Texas.
- Ⓞ Weltronic Co., 19500 W. Eight Mile Rd., Detroit 9, Mich.

CONVERTERS—High Frequency

- Ⓞ AIR ASSOCIATES, INC., Teterboro, N. J. ADV. PG. 211.
- Ⓞ BARKER & WILLIAMSON, 235 Fairfield Ave., Upper Darby, Pa. ADV. PG. 292.
- Ⓞ Bassett, Inc., Rex, 307-11 N. W. First Ave., Fort Lauderdale, Fla.
- Ⓞ BOGUE ELECTRIC MFG. CO., 52 Iowa Ave., Paterson 3, N. J. ADV. PG. 155.
- Ⓞ Bunnell & Co., J. H., 81 Prospect St., Brooklyn, N. Y.
- Ⓞ CARTER MOTOR CO., 2646 N. Maplewood Ave., Chicago 47, Ill. ADV. PG. 332.
- Ⓞ CLARK CRYSTAL CO., 2 Farm Rd., Marlboro, Mass. ADV. PG. 366.
- Ⓞ COILCRAFT, INC., 3716 N. Cicero Ave., Chicago 41, Ill. ADV. PG. 360.
- Ⓞ Ecco High Frequency Corp., 7020 Hudson Blvd., North Bergen, N. J.
- Ⓞ GENERAL ELECTRIC CO., Schenectady 5, N. Y. ADV. PG. 1 TO 22.
- Ⓞ Gonset Co., 72 E. Tujunga Ave., Burbank, Calif.
- Ⓞ Lepel High Frequency Labs., Inc., 39 W. 60th St., New York 23, N. Y.
- Ⓞ Monarch Radio & Television Corp., 2430 Atlantic Ave., Brooklyn 33, N. Y.
- Ⓞ Peek, Inc., Walter E., 132 E. 44th St., Indianapolis, Ind.
- Ⓞ POLARAD ELECTRONICS CORP., 100 Metropolitan Ave., Brooklyn 11, N. Y. ADV. PG. 184, 185.
- Ⓞ Radio Mfg. Engineering, Inc., 300-302 First Ave., Peoria 6, Ill.
- Ⓞ Radio Transceiver Labs., 116-23 Jamaica Ave., Peoria 6, Ill.
- Ⓞ Reeve Electronics, Inc., 609 W. Lake St., Chicago 6, Ill.
- Ⓞ Robbins & Myers, Inc., 1345 Lagonda Ave., Springfield 99, Ohio.
- Ⓞ Varo Mfg. Co., Inc., Box 638, Garland, Texas.
- Ⓞ Weltronic Co., 19500 W. Eight Mile Rd., Detroit 9, Mich.

CONVERTERS—Low Frequency

- Ⓞ AIRPAX PRODUCTS CO., Middle River, Baltimore 20, Md. ADV. PG. 289.
- Ⓞ BARKER & WILLIAMSON, 235 Fairfield Ave., Upper Darby, Pa. ADV. PG. 292.
- Ⓞ BOGUE ELECTRIC MFG. CO., 52 Iowa Ave., Paterson 3, N. J. ADV. PG. 155.

- Ⓞ Bunnell & Co., J. H., 81 Prospect St., Brooklyn, N. Y.
- Ⓞ COILCRAFT, INC., 3716 N. Cicero Ave., Chicago 41, Ill. ADV. PG. 360.
- Ⓞ Continental Electric Co., Inc., 334 Ferry St., Newark 5, N. J.
- Ⓞ GENERAL ELECTRIC CO., Schenectady 5, N. Y. ADV. PG. 1 to 22.
- Ⓞ Lepel High Frequency Labs., Inc., 39 W. 60th St., New York 23, N. Y.
- Ⓞ Monarch Radio & Television Corp., 2430 Atlantic Ave., Brooklyn 33, N. Y.
- Ⓞ NORRMAN LABORATORIES, ERNST, Williams Bay, Wis. ADV. PG. 346.
- Ⓞ Peek, Inc., Walter E., 132 E. 44th St., Indianapolis, Ind.
- Ⓞ POLARAD ELECTRONICS CORP., 100 Metropolitan Ave., Brooklyn 11, N. Y. ADV. PG. 184, 185.
- Ⓞ Varo Mfg. Co., Inc., Box 638, Garland, Texas.
- Ⓞ Weltronic Co., 19500 W. Eight Mile Rd., Detroit 9, Mich.

CONVERTERS—Magnetic

- Ⓞ ALDEN CO., 117 N. Main St., Brockton 64, Mass. ADV. PG. 252.
- Ⓞ Allis Chalmers Mfg. Co., 935 S. 70th St., Milwaukee, Wis.
- Ⓞ BOGUE ELECTRIC MFG. CO., 52 Iowa Ave., Paterson 3, N. J. ADV. PG. 155.
- Ⓞ Cook Research Labs., 1457 Diversey Parkway, Chicago 14, Ill.
- Ⓞ ECLIPSE-PIONEER DIV., Bendix Aviation Corp., Teterboro, N. J. ADV. PG. 198, 199.
- Ⓞ FEDERAL TELEPHONE & RADIO CORP., 88 Kingsland Rd., Clifton, N. J. ADV. PG. 161-163.
- Ⓞ Kearfott Mfg. Corp., 75 Hudson St., Newark, N. J.
- Ⓞ MAGNETIC AMPLIFIERS INC., 1154 44th Drive, Long Island City 1, N. Y. ADV. PG. 346.
- Ⓞ Magnetics, Inc., 135 Bloomfield Ave., Bloomfield, N. J.
- Ⓞ SORENSEN & CO., INC., 375 Fairfield Ave., Stamford, Conn. ADV. PG. 66, 67.
- Ⓞ Standard Electrical Products Co., 400 Linden Ave., Dayton, Ohio.
- Ⓞ Transducer Corp., 1085 Commonwealth Ave., Boston 15, Mass.
- Ⓞ Varo Mfg. Co., Inc., Box 638, Garland, Texas.
- Ⓞ WARD-LEONARD ELECTRIC CO., 31 South St., Mt. Vernon, N. Y. ADV. PG. 69, 70.

CONVERTERS—Microwave

- Ⓞ CORNELL-DUBILIER ELECTRIC CORP., South Plainfield, N. J. ADV. PG. 146.
- Ⓞ KINGS MICROWAVE CO., INC., 50 Marbledale Rd., Tuckahoe 7, N. Y. ADV. PG. 178, 179.
- Ⓞ POLARAD ELECTRONICS CORP., 100 Metropolitan Ave., Brooklyn 11, N. Y. ADV. PG. 184, 185.
- Ⓞ Press Wireless Mfg. Co., Inc., Cantiague Rd., Hicksville, N. Y.
- Ⓞ SPERRY GYROSCOPE CO., Div. of The Sperry Corp., Great Neck, N. Y. ADV. PG. 103, 104.
- Ⓞ Varian Associates, 99 Washington St., San Carlos, Calif.
- Ⓞ VECTRON, INC., 235 High St., Waltham, Mass. ADV. PG. 214.
- Ⓞ Wheeler Laboratories, Inc., Great Neck, N. Y.

CONVERTERS—Rotary

- Ⓞ Bendix Radio Division, Bendix Aviation Corp., Baltimore 4, Md.
- Ⓞ Bludworth Marine Div., National-Simplex-Bludworth, Inc., 92 Gold St., New York 38, N. Y.
- Ⓞ BOGUE ELECTRIC MFG. CO., 52 Iowa Ave., Paterson 3, N. J. ADV. PG. 155.
- Ⓞ CARTER MOTOR CO., 2646 N. Maplewood Ave., Chicago 47, Ill. ADV. PG. 332.
- Ⓞ Continental Electric Co., Inc., 334 Ferry St., Newark 5, N. J.
- Ⓞ ECLIPSE-PIONEER DIV., Bendix Aviation Corp., Teterboro, N. J. ADV. PG. 198, 199.
- Ⓞ Elicor Inc., 1501 W. Congress St., Chicago 7, Ill.
- Ⓞ GENERAL ELECTRIC CO., Schenectady 5, N. Y. ADV. PG. 1 to 22.
- Ⓞ Gothard Mfg. Co., 2110 Clear Lake Ave., Springfield, Ill.
- Ⓞ Great Lakes Electric Mfg. Co., 17 S. Desplaines St., Chicago 6, Ill.
- Ⓞ Janette Mfg. Co., 556 W. Monroe St., Chicago 6, Ill.
- Ⓞ Kato Engineering Co., 1415 First Ave., Mankato, Minn.
- Ⓞ RED BANK DIVISION, Bendix Aviation Corp., Red Bank, N. J. ADV. PG. 197.
- Ⓞ Varo Mfg. Co., Inc., Box 638, Garland, Texas.

CONVERTERS—Static

- Ⓞ ELECTRONIC MEASUREMENTS COMPANY, Red Bank, N. J. ADV. PG. 312.
- Ⓞ Inet, Inc., 8655 S Main St., Los Angeles 3, Calif.
- Ⓞ Reeve Electronics, Inc., 609 W. Lake St., Chicago 6, Ill.
- Ⓞ Ther Electric & Machine Works, 15 S. Jefferson St., Chicago, Ill.
- Ⓞ Varo Mfg. Co., Inc., Box 638, Garland, Texas.

CONVERTERS—Vibrator Type

- Ⓞ AIRPAX PRODUCTS CO., Middle River, Baltimore 20, Md. ADV. PG. 289.
- Ⓞ AMERICAN TELEVISION & RADIO CO., 300 E. Fourth St., St. Paul 1, Minn. ADV. PG. 266.
- Ⓞ Bendix Radio Division, Bendix Aviation Corp., Baltimore 4, Md.
- Ⓞ Bunnell & Co., J. H., 81 Prospect St., Brooklyn, N. Y.
- Ⓞ CORNELL-DUBILIER ELECTRIC CORP., South Plainfield, N. J. ADV. PG. 146.
- Ⓞ Edwards Corp., Inc., 86 Boston Post Rd., Norwalk, Conn.
- Ⓞ ELECTRO PRODUCTS LABS., 4501 N. Ravenswood Ave., Chicago 40, Ill. ADV. PG. 199.
- Ⓞ Ionic Electronic Equipment Co., 1705 N. Kenmore, Los Angeles 27, Calif.
- Ⓞ Mallory & Co., Inc., P. R., 3029 E. Washington St., Indianapolis 6, Ind.
- Ⓞ MINNEAPOLIS-HONEYWELL REGULATOR CO., INDUSTRIAL DIV., Wayne & Roberts Aves., Philadelphia 44, Pa. ADV. PG. 208, 209.
- Ⓞ Nuclear Instrument & Chemical Corp., 223 W. Erie St., Chicago 10, Ill.
- Ⓞ Radlart Corp., The, 3571 W. 62nd St., Cleveland, Ohio.
- Ⓞ Varo Mfg. Co., Inc., Box 638, Garland, Texas.

COOKERS—Electronic

- Ⓞ Weltronic Co., 19500 W. Eight Mile Rd., Detroit 9, Mich.

CORD SETS

- Ⓞ ALDEN PRODUCTS CO., 117 No. Main St., Brockton 64, Mass. ADV. PG. 327.
- Ⓞ Alpha Wire Corp., 430 Broadway, New York, N. Y.
- Ⓞ American Electric Cable Co., 181 Appleton St., Holyoke, Mass.
- Ⓞ Belden Mfg. Co., 4647 W. Van Buren St., Chicago 44, Ill.
- Ⓞ Birnbach Radio Co., Inc., 145 Hudson St., New York, N. Y.
- Ⓞ Cable Electric Products Co., Providence, R. I.
- Ⓞ Caltron Co., 1406 S. Hobart Blvd., Los Angeles 6, Calif.
- Ⓞ CINEMA ENGINEERING CO., 1510 W. Verdugo Ave., Burbank, Calif. ADV. PG. 204.
- Ⓞ COLUMBIA WIRE & SUPPLY CO., 2850 Irving Park Rd., Chicago 18, Ill. ADV. PG. 396.
- Ⓞ Connecticut Telephone & Electric Corp., 70 Britannia St., Meriden, Conn.
- Ⓞ CORNISH WIRE CO., 50 Church St., New York 7, N. Y. ADV. PG. 71.
- Ⓞ Diamond Wire & Cable Co., Sycamore, Ill.
- Ⓞ Englewood Electrical Supply Co., 5801 S. Halsted St., Chicago, Ill.
- Ⓞ Essex Wire Corp., 1601 Wall St., Fort Wayne 6, Ind.
- Ⓞ Etraco Mfg. Co., Inc., Woods Church Rd., Flemington, N. J.
- Ⓞ General Cement Mfg. Co., 919 Taylor Ave., Rockford, Ill.
- Ⓞ GENERAL ELECTRIC CO., Construction Materials Dept., 1285 Boston Ave., Bridgeport 2, Conn. ADV. PG. 1 TO 22.
- Ⓞ General Insulated Wire Works, Inc., 69 Gordon Ave., Providence 5, R. I.
- Ⓞ J F D MFG. CO., 6101-23 Sixteenth Ave., Brooklyn, N. Y. ADV. PG. 407.
- Ⓞ Koiled Kords, Inc., Box K, New Haven 14, Conn.
- Ⓞ KULKA ELECTRIC MFG. CO., INC., 30 South St., Mount Vernon, N. Y. ADV. PG. 317.
- Ⓞ MODELECTRIC PRODUCTS CORP., 1500 Bangs Ave., Asbury Park, N. J. ADV. PG. 204.
- Ⓞ Molded Insulation Co., 335 E. Price St., Philadelphia, Pa.
- Ⓞ Pacific Electriccord Company, 3217 Exposition Place, Los Angeles 18, Calif.
- Ⓞ PHALO PLASTICS CORP., 25 Foster St., Worcester 8, Mass. ADV. PG. 282.
- Ⓞ Plastic Wire & Cable Corp., Jewett City, Conn.
- Ⓞ Rhode Island Insulated Wire Co., Inc., 50 Burnham Ave., Cranston, R. I.
- Ⓞ ROANWELL CORP., 662 Pacific St., Brooklyn 17, N. Y. ADV. PG. 403.
- Ⓞ Rockbestos Products Corp., 285 Nicollet St., New Haven 4, Conn.
- Ⓞ Rupp's Assembling & Mfg. Works, 2341 N. Seminary Ave., Chicago 14, Ill.
- Ⓞ Schott Co., Walter L., 3225 Exposition Pl., Los Angeles 18, Calif.
- Ⓞ Selector Industries, Inc., 401 E. 138th St., New York 54, N. Y.
- Ⓞ Sheldon Electric Co., Div. of Allied Electric Products Inc., 76 Coit St., Irvington 11, N. J.
- Ⓞ Standard Telephones & Cables Ltd., Connaught House, Aldwych, London, W. C. 2, England.
- Ⓞ Television Specialty Co., Haverstraw, N. Y.
- Ⓞ TENSOLITE INSULATED WIRE CO., 198 Main St., Tarrytown, N. Y. ADV. PG. 316.
- Ⓞ Trimm, Inc., 400 W. Lake St., Libertyville, Ill.
- Ⓞ UNITED MFG. & SERVICE CO., 405 S. Sixth St., Milwaukee 4, Wis. ADV. PG. 324.
- Ⓞ Winslow Co., Inc., 9 Liberty St., Newark 5, N. J.

Ⓜ indicates . . . IN PRODUCTION • AVAILABILITY • UNRESTRICTED FOR GENERAL USE

CORDS—Dial Cords & Cables

- Ⓜ Alpha Wire Corp., 430 Broadway, New York, N. Y.
- Birnback Radio Co., Inc., 145 Hudson St., New York, N. Y.
- Ⓜ Connecticut Telephone & Electric Corp., 70 Britannia St., Meriden, Conn.
- Ⓜ General Cement Mfg. Co., 919 Taylor Ave., Rockford, Ill.
- Ⓜ HEMINWAY & BARTLETT MFG. CO., 500 Fifth Ave., New York 18, N. Y. ADV. PG. 266.
- Ⓜ J F D MFG CO., 6101-23 Sixteenth Ave., Brooklyn, N. Y. ADV. PG. 407.
- Ⓜ Philco Corp., Tioga & C Sts., Philadelphia 34, Pa.
- Ⓜ Rhode Island Insulated Wire Co., Inc., 50 Burnham Ave., Cranston, R. I.
- Ⓜ Runzel Cord & Wire Co., 4723-31 W. Montrose Ave., Chicago 41, Ill.
- Ⓜ Schott Co., Walter L., 3225 Exposition Pl., Los Angeles 18, Calif.
- Ⓜ Smith, Inc., Herman H., 436 18th St., Brooklyn 15, N. Y.
- Ⓜ Standard Telephones & Cables Ltd., Connaught House, Aldwych, London W. C. 2, England.
- Ⓜ UNITED MFG. & SERVICE CO., 405 S. Sixth St., Milwaukee 4, Wis. ADV. PG. 324.
- Ⓜ Whitaker Cable Corp., Kansas City 16, Mo.

CORDS—Line

- Ⓜ ALDEN PRODUCTS CO., 117 No. Main St., Brockton 64 Mass. ADV. PG. 327.
- Ⓜ Alpha Wire Corp., 430 Broadway, New York, N. Y.
- Ⓜ American Electric Cable Co., 181 Appleton St., Holyoke, Mass.
- Ⓜ Belden Mfg. Co., 4647 W. Van Buren St., Chicago 44, Ill.
- Birnback Radio Co., Inc., 145 Hudson St., New York, N. Y.
- Ⓜ COLUMBIA WIRE & SUPPLY CO., 2850 Irving Park Rd., Chicago 18, Ill. ADV. PG. 396.
- Ⓜ Connecticut Telephone & Electric Corp., 70 Britannia St., Meriden, Conn.
- Ⓜ CORNISH WIRE CO., 50 Church St., New York 7, N. Y. ADV. PG. 71.
- Ⓜ Diamond Wire & Cable Co., Sycamore, Ill.
- Ⓜ Englewood Electrical Supply Co., 5801 S. Halsted St., Chicago, Ill.
- Ⓜ General Cement Mfg. Co., 919 Taylor Ave., Rockford, Ill.
- Ⓜ General Insulated Wire Works, Inc., 69 Gordon Ave., Providence 5, R. I.
- Ⓜ J F D MFG. CO., 6101-23 Sixteenth Ave., Brooklyn, N. Y. ADV. PG. 407.
- Ⓜ Kolled Kords, Inc., Box K, New Haven 14, Conn.
- Ⓜ MODELECTRIC PRODUCTS CORP., 1500 Bangs Ave., Asbury Park, N. J. ADV. PG. 204.
- Ⓜ Pacific Electriccord Company, 3217 Exposition Place, Los Angeles 18, Calif.
- Ⓜ PHALO PLASTICS CORP., 25 Foster St., Worcester 8, Mass. ADV. PG. 282.
- Ⓜ Philco Corp., Tioga & C Sts., Philadelphia 34, Pa.
- Ⓜ Plastic Wire & Cable Corp., Jewett City, Conn.
- Ⓜ Rupp's Assembling & Mfg. Works, 2341 N. Seminary Ave., Chicago 14, Ill.
- Ⓜ Schott Co., Walter L., 3225 Exposition Pl., Los Angeles 18, Calif.
- Ⓜ Selectar Industries, Inc., 401 E. 138th St., New York 54, N. Y.
- Ⓜ Standard Telephones & Cables Ltd., Connaught House, Aldwych, London, W. C. 2, England.
- Ⓜ UNITED MFG. & SERVICE CO., 405 S. Sixth St., Milwaukee 4, Wis. ADV. PG. 324.
- Ⓜ Western Insulated Wire Co., 2421 E. 30th St., Los Angeles 1, Calif.

CORDS—Line Resistance

- Ⓜ American Electric Cable Co., 181 Appleton St., Holyoke, Mass.
- Ⓜ Belden Mfg. Co., 4647 W. Van Buren St., Chicago 44, Ill.
- Birnback Radio Co., Inc., 145 Hudson St., New York, N. Y.
- Ⓜ COLUMBIA WIRE & SUPPLY CO., 2850 Irving Park Rd., Chicago 18, Ill. ADV. PG. 396.
- Ⓜ Insuline Corp. of America, 36-02 35th Ave., Long Island City, N. Y.
- Ⓜ J F D MFG. CO., 6101-23 Sixteenth Ave., Brooklyn, N. Y. ADV. PG. 407.
- Ⓜ UNITED MFG. & SERVICE CO., 405 S. Sixth St., Milwaukee 4, Wis. ADV. PG. 324.

CORDS—Patch

- Ⓜ Audio Development Co., 2833 13th Ave. S., Minneapolis 7, Minn.
- Ⓜ Audio Equipment Sales, 153 W. 33rd St., New York 1, N. Y.
- Ⓜ Buggie & Co., H. H., 726 Stanton St., Toledo, Ohio.
- Ⓜ CINEMA ENGINEERING CO., 1510 W. Verdugo Ave., Burbank, Calif. ADV. PG. 207.
- Ⓜ Connecticut Telephone & Electric Corp., 70 Britannia St., Meriden, Conn.
- Ⓜ EDIN CO., INC., 207 Main St., Worcester, Mass. ADV. PG. 285.
- Ⓜ Electronic Brazing Co., 140 Glenridge Ave., Montclair, N. J.

- Ⓜ FEDERAL TELEPHONE & RADIO CORP., 88 Kingsland Rd., Clifton, N. J. ADV. PG. 161-163.
- Ⓜ General Insulated Wire Works, Inc., 69 Gordon Ave., Providence 5, R. I.
- Ⓜ GENERAL RADIO CO., 275 Massachusetts Ave., Cambridge 39, Mass. ADV. PG. 48, 49.
- Ⓜ KELLOGG SWITCHBOARD & SUPPLY CO., 6650 S. Cicero Ave., Chicago 38, Ill. ADV. PG. 294.
- Ⓜ LENZ ELECTRIC MFG. CO., 1751 North Western Ave., Chicago 47, Ill. ADV. PG. 236.
- Ⓜ NATIONAL CO., INC., 61 Sherman St., Malden 48, Mass. ADV. PG. 280, 281.
- Ⓜ RADIO CORP. OF AMERICA, RCA Victor Div., General Offices, Camden, N. J. ADV. PG. 177, Inside Back & Back Covers.
- Ⓜ REEVES INSTRUMENT CORP., 215 E. 91st St., New York, N. Y. ADV. PG. 315.
- Ⓜ Runzel Cord & Wire Co., 4723 W. Montrose Ave., Chicago 41, Ill.
- Ⓜ Selectar Industries, Inc., 401 E. 138th St., New York 54, N. Y.
- Ⓜ TRAD TELEVISION CORP., 1001 First Ave., Asbury Park, N. J. ADV. PG. 355.
- Ⓜ Trimm, Inc., 400 W. Lake St., Libertyville, Ill.
- Ⓜ UNITED MFG. & SERVICE CO., 405 S. Sixth St., Milwaukee 4, Wis. ADV. PG. 324.

CORES—Ceramic

- Ⓜ AMERICAN LAVA CORP., Chattanooga 5, Tenn. ADV. PG. 143.
- Ⓜ CENTRALAB DIV. of Globe Union Inc., 900 E. Keefe Ave., Milwaukee, Wis. ADV. PG. 85-88.
- Ⓜ CROWLEY & CO., INC., HENRY L., 1 Central Ave., West Orange, N. J. ADV. PG. 231.
- Ⓜ Electrical Refractories Co., 50 Clark St., East Palestine, Ohio.
- Ⓜ ERIE RESISTOR CORP., 644 W. 12th St., Erie, Pa. ADV. PG. 91.
- Ⓜ Ferricore Inc., 15 School St., Yonkers 2, N. Y.
- Ⓜ Ferroxcube Corp. of America, 50 E. 41st St., New York, N. Y.
- Ⓜ GENERAL ACCESSORIES CO. LTD., 366 Madison Ave., New York 17, N. Y. ADV. PG. 336.
- Ⓜ GENERAL CERAMICS & STEATITE CORP., Keasbey, N. J. ADV. PG. 126, 127.
- Ⓜ Isolantite Mfg. Corp., Stirling, N. J.
- Ⓜ Kirchnerberger & Co., Inc., M., 1425 37th St., Brooklyn 18, N. Y.
- Ⓜ LOUTHAN MFG. CO., East Liverpool, Ohio. ADV. PG. 284.
- Ⓜ MAGNETIC CORE CORP., 142-144 S. Highland Ave., Ossining, N. Y. ADV. PG. 414.
- Ⓜ Steward Mfg. Co., D. M., 3600 Jerome Ave., Chattanooga 1, Tenn.
- Ⓜ Western Gold & Platinum Works, 589 Bryant St., San Francisco, Calif.
- Ⓜ Wisconsin Porcelain Co., Sun Prairie, Wis.

CORES—High Permeability Magnetic

- Ⓜ Aladdin Radio Industries, Inc., 501 W. 35th St., Chicago 16, Ill.
- Ⓜ Arnold Engineering Co., Marengo, Ill.
- Ⓜ CROWLEY & CO., INC., HENRY L., 1 Central Ave., West Orange, N. J. ADV. PG. 231.
- Ⓜ Delco Radio Div., General Motors Corp., Kokomo, Ind.
- Ⓜ Ferricore Inc., 15 School St., Yonkers 2, N. Y.
- Ⓜ Ferroxcube Corp. of America, 50 E. 41st St., New York, N. Y.
- Ⓜ GENERAL CERAMICS & STEATITE CORP., Keasbey, N. J. ADV. PG. 126, 127.
- Ⓜ MAGNETIC CORE CORP., 142-144 S. Highland Ave., Ossining, N. Y. ADV. PG. 414.
- Ⓜ MAGNETICS, INC., P. O. Box 761, Butler, Pa. ADV. PG. 381.
- Ⓜ Mallory & Co., Inc., P. R., 3029 E. Washington St., Indianapolis 6, Ind.
- Ⓜ NATIONAL MOLDITE CO., 1410 Chestnut Ave., Hillside 5, N. J. ADV. PG. 232.
- Ⓜ PYROFERRIC CO., 621 E. 216th St., New York 67, N. Y. ADV. PG. 287.
- Ⓜ RADIO CORES, INC., 9540 Tulley Ave., Oak Lawn, Ill. ADV. PG. 396.
- Ⓜ STACKPOLE CARBON CO., St. Marys, Pa. ADV. PG. 170, 171.
- Ⓜ Standard Telephones & Cables Ltd., Connaught House, Aldwych, London, W. C. 2, England.
- Ⓜ Steward Mfg. Co., D. M., 3600 Jerome Ave., Chattanooga 1, Tenn.
- Ⓜ WESTINGHOUSE ELECTRIC CORP., 511 Wood St., P. O. Box 868, Pittsburgh 30, Pa. ADV. PG. 107-113.

CORES—Iron

- Ⓜ Aladdin Radio Industries, Inc., 501 W. 35th St., Chicago 16, Ill.
- Ⓜ CROWLEY & CO., INC., HENRY L., 1 Central Ave., West Orange, N. J. ADV. PG. 231.
- Ⓜ Delco Radio Div., General Motors Corp., Kokomo, Ind.
- Ⓜ GENERAL CERAMICS & STEATITE CORP., Keasbey, N. J. ADV. PG. 126, 127.
- Ⓜ MAGNETIC CORE CORP., 142-144 S. Highland Ave., Ossining, N. Y. ADV. PG. 414.
- Ⓜ Mallory & Co., Inc., P. R., 3029 E. Washington St., Indianapolis 6, Ind.

- Ⓜ MEASUREMENTS CORP., Boonton, N. J. ADV. PG. 99.
- Ⓜ NATIONAL MOLDITE CO., 1410 Chestnut Ave., Hillside 5, N. J. ADV. PG. 232.
- Ⓜ RADIO CORES, INC., 9540 Tulley Ave., Oak Lawn, Ill. side 5, N. J. ADV. PG. 232.
- Ⓜ PYROFERRIC CO., 621 E. 216th St., New York 67, N. Y. ADV. PAGE 287.
- Ⓜ RADIO CORES, INC., 9540 Tulley Ave., Oak Lawn, Ill. ADV. PG. 396.
- Ⓜ SPEER RESISTOR CORP., St. Marys, Pa. ADV. PG. 406.
- Ⓜ Standard Telephones & Cables Ltd., Connaught House, Aldwych, London, W. C. 2, England.

CORES—Powdered Iron

- Ⓜ Aladdin Radio Industries, Inc., 501 W. 35th St., Chicago 16, Ill.
- Ⓜ Amplex Division, Chrysler Corp., Detroit 31, Mich.
- Ⓜ Delco Radio Div., General Motors Corp., Kokomo, Ind.
- Ⓜ Ferricore Inc., 15 School St., Yonkers, N. Y.
- Ⓜ LENKURT ELECTRIC CO., INC., San Carlos, Calif. ADV. PG. 412.
- Ⓜ MAGNETIC CORE CORP., 142-144 South Highland Ave., Ossining, N. Y. ADV. PG. 414.
- Ⓜ Mallory & Co., Inc., P. R., 3029 E. Washington St., Indianapolis 6, Ind.
- Ⓜ MEASUREMENTS CORP., Boonton, N. J. ADV. PG. 99.
- Ⓜ Melpar, Inc., 552 Swann Ave., Alexandria, Va.
- Ⓜ NATIONAL MOLDITE CO., 1410 Chestnut Ave., Hillside 5, N. J. ADV. PG. 232.
- Ⓜ Powdered Metal Products Corp., Franklin Park, Ill.
- Ⓜ PYROFERRIC CO., 621 E. 216th St., New York 67, N. Y. ADV. PG. 287.
- Ⓜ Quality Components, Inc., St. Marys, Pa.
- Ⓜ RADIO CORES, INC., 9540 Tulley Ave., Oak Lawn, Ill. ADV. PG. 396.
- Ⓜ SPEER RESISTOR CORP., St. Marys, Pa. ADV. PG. 406.
- Ⓜ STACKPOLE CARBON CO., St. Marys, Pa. ADV. PG. 170, 171.
- Ⓜ Standard Telephones & Cables Ltd., Connaught House, Aldwych, London, W. C. 2, England.

CORES—Slug Tuning Units

- Ⓜ Aladdin Radio Industries, Inc., 501 W. 35th St., Chicago 16, Ill.
- Ⓜ Delco Radio Div., General Motors Corp., Kokomo, Ind.
- Ⓜ Ferricore Inc., 15 School St., Yonkers 2, N. Y.
- Ⓜ Ferroxcube Corp. of America, 50 E. 41st St., New York, N. Y.
- Ⓜ GENERAL CERAMICS & STEATITE CORP., Keasbey, N. J. ADV. PG. 126, 127.
- Ⓜ Gries Reproducer Corp., 100 Willow Ave., New York 54, N. Y.
- Ⓜ MAGNETIC CORE CORP., 142-144 S. Highland Ave., Ossining, N. Y. ADV. PG. 414.
- Ⓜ Monroe Coil Co., 2839 N. Narragansett Ave., Chicago 34, Ill.
- Ⓜ PYROFERRIC CO., 621 E. 216th St., New York 67, N. Y. ADV. PG. 287.
- Ⓜ Quality Components Inc., St. Marys, Pa.
- Ⓜ RADIO CORES INC., 9540 Tulley Ave., Oak Lawn, Ill. ADV. PG. 396.
- Ⓜ SPEER RESISTOR CORP., St. Marys, Pa. ADV. PG. 406.
- Ⓜ Standard Telephones & Cables Ltd., Connaught House, Aldwych, London, W. C. 2, England.

CORTICAL STIMULATORS

- Ⓜ EDIN CO., INC., 207 Main St., Worcester, Mass. ADV. PG. 285.
- Ⓜ Process & Instruments, 60 Greenpoint Ave., Brooklyn 22, N. Y.
- Ⓜ RAHM INSTRUMENTS, INC., 12 W. Broadway, New York 7, N. Y. ADV. PG. 354.
- Ⓜ Wappler, Inc., 27 W. 24th St., New York 10, N. Y.

COUNTERS, ELECTRON AND NUCLEAR See Indicators, Geiger Counter or Counters, Radiation

COUNTERS—Mechanical

- Ⓜ Arlington Electric Products, Inc., 500 W. 52nd St., New York 19, N. Y.
- Ⓜ BELOCK INSTRUMENT CORP., 111th St. & 14th Ave., College Point, N. Y. ADV. PG. 371.
- Ⓜ Durant Mfg. Co., 1912 N. Buffum St., Milwaukee 1, Wis.
- Ⓜ Gorrell & Gorrell, Haworth, N. J.
- Ⓜ Production Instrument Co., 710 W. Jackson Blvd., Chicago 6, Ill.
- Ⓜ Veeder-Root, Inc., 20 Sargeant St., Hartford 2, Conn.

COUNTERS—Radiation

- Ⓜ AIRMEC LABORATORIES LTD., 366 Madison Ave., New York 17, N. Y. ADV. PG. 336.
- Ⓜ Anton Electronic Labs., Inc., 1226-1238 Flushing Ave., Brooklyn 6, N. Y.

V indicates . . . IN PRODUCTION • AVAILABILITY • UNRESTRICTED FOR GENERAL USE

- ATOMIC INSTRUMENT CO., 84 Massachusetts Ave., Cambridge 39, Mass. ADV. PG. 410.
- BALLANTINE LABORATORIES, INC., Boonton, N. J. ADV. PG. 125.
- BARKER & WILLIAMSON, 235 Fairfield Ave., Upper Darby, Pa. ADV. PG. 292.
- Beckman Instruments, Inc., 820 Mission St., South Pasadena, Calif.
- Clarkstan Corp., 11921 SW Pico Blvd., Los Angeles 64, Calif.
- Cyclotron Specialties Co., Moraga 8, Calif.
- Douglas Radio Labs., 176 Norfolk Ave., Boston 19, Mass.
- Electronic Products Co., 111 E. Third St., Mt. Vernon, N. Y.
- EL-TRONICS, INC., 2649 N. Howard St., Philadelphia 33, Pa. ADV. PG. 299.
- Flader, Inc., Fredric, 1330 Laskey Rd., Toledo 12, Ohio.
- Forty Niner Co., 5245 Grand River, Detroit 8, Mich.
- GENERAL RADIO CO., 275 Massachusetts Ave., Cambridge 39, Mass. ADV. PG. 48, 49.
- Georator Corp., 1820 N. Nash St., Arlington, Va.
- Kelley-Koett Instrument Co., 962 York St., Cincinnati 14, Ohio.
- Loudon Instruments, Inc., 5644 Lake Park Ave., Chicago 44, Ill.
- Macdonald Co., Inc., W. S., 33 University Rd., Cambridge 38, Mass.
- Measurement Engineering, Ltd., Arnprior, Ontario, Canada.
- Nuclear Development Lab., P. O. Box 7034, Kansas City, Mo.
- Nuclear Instrument & Chemical Corp., 223 W. Erie St., Chicago 10, Ill.
- Nuclear Measurements Corp., 3339 Central Ave., Indianapolis 5, Ind.
- Nuclear Research Corp., 2707 Federal St., Philadelphia 46, Pa.
- Nucleon Corp. of America, The, 497 Union St., Brooklyn 31, N. Y.
- POTTER INSTRUMENT CO., INC., 115 Cutter Mill Rd., Great Neck, N. Y. ADV. PG. 318.
- Precision Radiation Instruments, Inc., 4113 W. Jefferson Blvd., Los Angeles 16, Calif.
- Production Instrument Co., 710 W. Jackson Blvd., Chicago 6, Ill.
- R-C Scientific Instrument Co., 335 Culver Blvd., Playa Del Rey, Calif.
- Radiation Counter Laboratories, Inc., 1844 W. 21st St., Chicago 8, Illinois.
- Radioactive Products, Inc., 443 W. Congress St., Detroit 26, Mich.
- RADIO CORP. OF AMERICA, RCA Victor Div., General Offices, Camden, N. J. ADV. PG. 177, Inside Back and Back Covers.
- Special Instruments Laboratories, Inc., 1003 Highland Ave., Knoxville, Tenn.
- Streeter-Amet Corp., 4101 N. Ravenswood Ave., Chicago 13, Ill.
- Technical Associates, 3730 San Fernando Rd., Glendale 4, Calif.
- Technitrol Engineering Co., 3211 Woodland Ave., Philadelphia 4, Pa.
- Tracerlab Inc., 130 High St., Boston 10, Mass.
- Walkirt Co., 5808 Marilyn Ave., Culver City, Calif.
- Wood Laboratory, N. 5646 Harper Ave., Chicago 37, Ill.

COUNTERS—Revolution

- Durant Mfg. Co., 1912 N. Buffum St., Milwaukee 1, Wis.
- HEWLETT-PACKARD CO., 395 Page Mill Rd., Palo Alto, Calif. ADV. PG. 33-36.
- POTTER INSTRUMENT CO., INC., 115 Cutter Mill Rd., Great Neck, N. Y. ADV. PG. 318.
- Production Instrument Co., 710 W. Jackson Blvd., Chicago 6, Ill.
- Veeder-Root, Inc., 20 Sargeant St., Hartford 2, Conn.

COUPLERS—Directional

- Bunnell & Co., J. H., 81 Prospect St., Brooklyn, N. Y.
- C. G. S. LABORATORIES, INC., 391 Ludlow St., Stamford, Conn. ADV. PG. 389.
- Diamond Mfg. Co., Wakefield, Mass.
- Gates Radio Co., Quincy, Ill.
- General R-F Fittings Co., 702 Beacon St., Boston 15, Mass.
- HEWLETT-PACKARD CO., 395 Page Mill Rd., Palo Alto, Calif. ADV. PG. 33-36.
- JOHNSON CO., E. F. Waseca, Minn. ADV. PG. 118, 121.
- JONES ELECTRONICS CO., M. C., Bristol, Conn. ADV. PG. 384.
- KINGS MICROWAVE CO., INC., 50 Marbledale Rd., Tuckahoe 7, N. Y. ADV. PG. 178, 179.
- Microwave Equipment Co., Inc., North Caldwell, N. J.
- Network Mfg. Corp., Bayonne, N. J.
- POLYTECHNIC RESEARCH & DEVELOPMENT CO., INC., 202 Tillary St., Brooklyn 11, N. Y. ADV. PG. 172, 173.
- SPERRY GYROSCOPE CO., Div. of The Sperry Corp., Great Neck, N. Y. ADV. PG. 103, 104.
- VECTRON, INC., 235 High St., Waltham, Mass. ADV. PG. 214.
- Wheeler Laboratories, Inc., Inc., Great Neck, N. Y.

COUPLINGS, SHAFT—Reducers and Extensions

- AEROLITE ELECTRONIC HARDWARE CORP., 507 26th St., Union City, N. J.
- BARKER & WILLIAMSON, 235 Fairfield Ave., Upper Darby, Pa. ADV. PAGE 355
- Birnbach Radio Co., Inc., 145 Hudson St., New York, N. Y.
- Bud Radio Inc., 2118 E. 55th St., Cleveland 3, Ohio.
- Cardwell Mfg. Co., Allan D., 97 Whiting St., Plainville, Conn.
- General Cement Mfg. Co., 919 Taylor Ave., Rockford, Ill.
- Insuline Corp. of America, 36-02 35th Ave., Long Island City, N. Y.
- JOHNSON CO., E. F. Waseca, Minn. ADV. PG. 118, 121.
- Kupfrian Mfg. Co., 218 Prospect Ave., Binghamton, N. Y.
- Millen Mfg. Co., James, 150 Exchange St., Malden, Mass.
- NATIONAL CO., INC., 61 Sherman St., Malden 48, Mass. ADV. PG. 280, 281.
- REEVES INSTRUMENT CORP., 215 E. 91st St., New York, N. Y. ADV. PG. 315.

COUPLINGS, SHAFT—Rigid & Flexible

- AEROLITE ELECTRONIC HARDWARE CORP., 507 26th St., Union City, N. J. ADV. PG. 355.
- BARKER & WILLIAMSON, 235 Fairfield Ave., Upper Darby, Pa. ADV. PG. 292.
- Bawkin Machine Co., 30 Burtis Ave., New Canaan, Conn.
- Bud Radio, Inc., 2118 E. 55th St., Cleveland 3, Ohio.
- General Cement Mfg. Co., 919 Taylor Ave., Rockford, Ill.
- Hammarlund Mfg. Co., 460 W. 34th St., New York 1, N. Y.
- Insuline Corp. of America, 36-02 35th Ave., Long Island City, N. Y.
- JOHNSON CO., E. F. Waseca, Minn. ADV. PG. 118, 121.
- Koppers Co., Inc., Chemical Div., Koppers Bldg., Pittsburgh 19, Pa.
- Kupfrian Mfg., Co., 218 Prospect Ave., Binghamton, N. Y.
- LORD MFG. CO., 1635 W. 12th St., Erie, Pa. ADV. PG. 51.
- Millen Mfg. Co., James, 150 Exchange St., Malden, Mass.
- NATIONAL CO., INC., 61 Sherman St., Malden 48, Mass. ADV. PG. 280, 281.
- REEVES INSTRUMENT CORP., 215 E. 91st St., New York, N. Y. ADV. PG. 315.
- WHITE DENTAL MFG. CO., S. S. Industrial Div., 10 York, N. Y. ADV. PG. 315.

CRYSTAL ANALYSIS EQUIPMENT

- Airborne Instruments Lab., 160 Old Country Rd., Mineola, N. Y.
- Bassett, Inc., Rex, 307-11 N. W. First Ave., Fort Lauderdale, Fla.
- Berkshire Laboratories, 580 Lexington Rd., Concord, Mass.
- General Electric X-ray Corp., 4855 Electric Ave., Milwaukee, Wis.
- KAY ELECTRIC CO., 14 Maple Ave., Pine Brook, N. J. ADV. PG. 340.
- Menlo Research Laboratory, Menlo Park, Calif.
- North American Philips Co., Inc., 100 E. 42nd St., New York 17, N. Y.

CRYSTAL CARTRIDGES

- American Microphone Co., 370 S. Fair Oaks Ave., Pasadena 1, Calif.
- Astatic Corp., Inc., Conneaut, Ohio.
- ELECTRO-VOICE, INC., Buchanan, Mich. ADV. PG. 345.
- Philco Corp., Tioga & C Sts., Philadelphia 34, Pa.
- RADIO CORP. OF AMERICA, Tube Dept., Harrison, N. J. ADV. PG. 177, Inside Back and Back Cover.
- SHURE BROTHERS, INC., 225 W. Huron St., Chicago 10, Ill. ADV. PG. 230.
- TURNER CO., THE, 909 17th St., N. E., Cedar Rapids, Iowa. ADV. PG. 73.
- Webster Electric Co., 1900 Clark St., Racine, Wis.
- Weymouth Instrument Co., 1440 Commercial St., East Weymouth 89, Mass.

CRYSTAL DIODES
See Crystals, Germanium
Crystals, Silicon

CRYSTALS—Barium Titanate-Transducer

- AMERICAN LAVA CORP., Chattanooga 5, Tenn. ADV. PG. 143.
- BRUSH DEVELOPMENT CO., 3405 Perkins Ave., Cleveland 14, Ohio. ADV. PG. 228, 229.
- CENTRALAB DIV., of Globe-Union, Inc., 900 E. Keefe Ave., Milwaukee 1, Wis. ADV. PG. 85-88.

- ELECTRO-VOICE, INC., Buchanan, Mich. ADV. PG. 345.
- Glenco Corp., Metuchen, N. J.
- Gulton Mfg. Corp., Metuchen, N. J.
- Massa Laboratories, 3868 Carnegie St., Cleveland, Ohio.

CRYSTALS—Germanium-Rectifying & Amplifying

- Berkshire Laboratories, 580 Lexington Rd., Concord, Mass.
- Bomac Laboratories Inc., Salem Rd., Beverly, Mass.
- Kemtron Electron Products, Inc., 23 Brown St., Salem, Mass.
- Standard Telephones & Cables Ltd., Connaught House, Aldwych, London, W. C. 2, England.
- SYLVANIA ELECTRIC PRODUCTS, INC., 1740 Broadway, New York 19, N. Y. ADV. PG. 432-436.

CRYSTALS—Quartz-Frequency Control

- Basselett, Inc., Rex, 307-11 N. W. First Ave., Fort Lauderdale, Fla.
- BLILEY ELECTRIC CO., Union Station Bldg., Erie, Pa. ADV. PG. 311, 407.
- Breon Laboratories, 1520 Evergreen Rd., Williamsport, Pa.
- CLARK CRYSTAL CO., 2 Farm Rd., Marlboro, Mass. ADV. PG. 366.
- Dallons Labs., 5066 Santa Monica Blvd., Los Angeles, Calif.
- Eidson Electronic Co., 1802 N. Third St., Temple, Texas.
- HUNT CORP., 455 Lincoln St., Carlisle, Pa. ADV. PG. 413.
- Kaar Engineering Co., 2995 Middlefield Rd., P. O. Box 1320, Palo Alto, Calif.
- KNIGHTS CO., JAMES, 131 S. Wells St., Sandwich, Ill. ADV. PG. 328.
- MARCONI INSTRUMENTS, LTD., 23 Beaver St., New York 4, N. Y. ADV. PG. 270.
- Miller, August E., 9226 Hudson Blvd., North Bergen, N. J.
- Monitor Products Co., 815 Fremont Ave., South Pasadena, Calif.
- Motorola, Inc., 4545 Augusta Blvd., Chicago 51, Ill.
- Nebel Lab., R. E., 1104 Lincoln Place, Brooklyn 13, N. Y.
- NORMAN LABORATORIES, ERNST, Williams Bay, Wis. ADV. PG. 346.
- Piezo Products Co., Whitney St., Framingham, Mass.
- Polytech Devices, Inc., 1180 E. Grand St., Elizabeth, N. J.
- Precision Piezo Service, 427 Mayflower St., Baton Rouge, La.
- RADIO CORP. OF AMERICA, RCA Victor Div., General Offices, Camden, N. J. ADV. PG. 177, Inside Back and Back Covers.
- Radio Specialty Mfg. Co., 2023 S. E. Sixth Ave., Portland 14, Ore.
- REEVES-HOFFMAN CORP., 321 Cherry St., Carlisle, Pa. ADV. PG. 286.
- Ross Mfg. Co., 860 Washington St., Burlington, Iowa.
- Scientific Radio Service, 4301 Sheridan St., University Park, Md.
- STANDARD CRYSTAL CO., 400 Armstrong Ave., Kansas City 1, Kans. ADV. PG. 156.
- Standard Piezo Co., 127 Cedar St., Carlisle, Pa.
- Standard Telephones & Cables Ltd., Connaught House, Aldwych, London, W. C. 2, England.
- Valpey Crystals, Highland St., Holliston, Mass.
- Westline Electronics Co., 11656 Olympic Blvd., Los Angeles 25, Calif.

CRYSTALS—Quartz-Transducer

- Bassett, Inc., Rex, 307-11 N. W. First Ave., Fort Lauderdale, Fla.
- BLILEY ELECTRIC CO., Union Station Bldg., Erie, Pa. ADV. PG. 311, 407.
- CLARK CRYSTAL CO., 2 Farm Rd., Marlboro, Mass. ADV. PG. 311, 366.
- Dallons Labs., 5066 Santa Monica Blvd., Los Angeles, Calif.
- HUNT CORP., 455 Lincoln St., Carlisle, Pa. ADV. PG. 413.
- Miller, August E., 9226 Hudson Blvd., North Bergen, N. J.
- Monitor Products Co., 815 Fremont Ave., South Pasadena, Calif.
- Piezo Products Co., Whitney St., Framingham, Mass.
- Polytech Devices, Inc., 1180 E. Grand St., Elizabeth, N. J.
- Precision Piezo Service, 427 Mayflower St., Baton Rouge, La.
- REEVES-HOFFMAN CORP., 321 Cherry St., Carlisle, Pa. ADV. PG. 286.
- STANDARD CRYSTAL CO., 400 Armstrong Ave., Kansas City 1, Kans. ADV. PG. 156.
- Standard Telephones & Cables Ltd., Connaught House, Aldwych, London, W. C. 2, England.
- Valpey Crystals, Highland St., Holliston, Mass.

CRYSTALS—Rochelle Salts, Transducer

- BRUSH DEVELOPMENT CO., 3405 Perkins Ave., Cleveland 14, Ohio. ADV. PG. 228, 229.

V indicates . . . IN PRODUCTION • AVAILABILITY • UNRESTRICTED FOR GENERAL USE

- ⑦ Edo Corp., College Point, N. Y.
- ⑦ ELECTRO-VOICE, INC., Buchanan, Mich. ADV. PG. 345.
- ⑦ Glenco Corp., Metuchen, N. J.
- ⑦ Gulton Mfg. Corp., Metuchen, N. J.
- ⑦ Massa Laboratories, 3868 Carnegie St., Cleveland, Ohio.
- ⑦ Tibbetts Industries, Inc., Camden, Maine.

CRYSTALS—Scintillation Counter

- ⑦ ATOMIC INSTRUMENT CO., 84 Massachusetts Ave., Cambridge 39, Mass. ADV. PG. 410.
- ⑦ Macdonald Co., Inc., W. S., 33 University Rd., Cambridge 38, Mass.
- ⑦ Standard Electronics Research Corp., 2 East End Ave., New York 21, N. Y.
- ⑦ Nuclear Research Corp., 2707 Federal St., Philadelphia 46, Pa.
- ⑦ Organic Specialties Co., Paterson, N. J.
- ⑦ Pilot Chemicals, Inc., 47 Felton St., Waltham 54, Mass.
- ⑦ Radiation Counter Laboratories, Inc., 1844 W. 21st St., Chicago 8, Ill.
- ⑦ Standard Electronics Research Corp., 2 East End Ave., New York 21, N. Y.
- ⑦ Technical Associates, 3730 San Fernando Rd., Glendale 4, Calif.
- ⑦ Tracerlab, Inc., 130 High St., Boston 10, Mass.

CRYSTALS—Silicon-Rectifying & Amplifying

- ⑦ Bomac Laboratories Inc., Salem Rd., Beverly, Mass.
- ⑦ Kemtron Electron Products, Inc., 23 Brown St., Salem, Mass.
- ⑦ SYLVANIA ELECTRIC PRODUCTS, INC., 1740 Broadway, New York 19, N. Y. ADV. PG. 432-436.

CRYSTALS—Tourmaline-Frequency Control

- ⑦ Bassett, Inc., Rex, 307-11 N. W. First Ave., Fort Lauderdale, Fla.
- ⑦ CAMBRIDGE THERMIONIC CORP., 445 Concord Ave., Cambridge 38, Mass. ADV. PG. 37.
- ⑦ CLARK CRYSTAL CO., 2 Farm Rd., Marlboro, Mass. ADV. PG. 366.
- ⑦ MARCONI INSTRUMENTS, LTD., 23 Beaver St., New York 4, N. Y. ADV. PG. 270.
- ⑦ Miller, August E., 9226 Hudson Blvd., North Bergen, N. J.
- ⑦ Polytech Devices, Inc., 1180 E. Grand Ave., Elizabeth, N. J.
- ⑦ Valpey Crystals, Highland St., Holliston, Mass.

CYCLOTRONS

- ⑦ BOGUE ELECTRIC MFG. CO., 52 Iowa Ave., Paterson 3, N. J. ADV. PG. 155.
- ⑦ Collins Radio Co., Cedar Rapids, Iowa.
- ⑦ GENERAL ELECTRIC CO., Schenectady 5, N. Y. ADV. PG. 1 to 22.

DECADE BOXES—Capacitance

- ⑦ CORNELL-DUBILIER ELECTRIC CORP., South Plainfield, N. J. ADV. PG. 146.
- ⑦ Custom Craft Mfg. Co., 256 E. 98th St., Brooklyn, N. Y.
- ⑦ FREED TRANSFORMER CO., INC., 1736 Weirfield St., Brooklyn 27, N. Y. ADV. PG. 149.
- ⑦ GENERAL RADIO CO., 275 Massachusetts Ave., Cambridge 39, Mass. ADV. PG. 48, 49.
- ⑦ Industrial Instruments, Inc., 17 Pollack Ave., Jersey City 5, N. J.
- ⑦ Leeds & Northrup Co., 4970 Stenton Ave., Philadelphia 44, Pa.
- Metropolitan Electronics & Instruments Co., 106 Fifth Ave., New York 11, N. Y.
- ⑦ Muirhead & Co., Ltd., Beckenham, Kent, England.
- ⑦ Tech Laboratories, Inc., Bergen & Edsall Blvds., Palisades Park, N. J.
- ⑦ Welch Scientific Co., W. M., 1515 Sedgwick St., Chicago 10, Ill.

DECADE BOXES—Inductance

- ⑦ DE COURSEY ENGINEERING LAB., P. O. Box 235, Los Angeles 25, Calif. ADV. PG. 174.
- ⑦ FREED TRANSFORMER CO., INC., 1736 Weirfield St., Brooklyn 27, N. Y. ADV. PG. 149.
- ⑦ GENERAL RADIO CO., 275 Massachusetts Ave., Cambridge 39, Mass. ADV. PG. 48, 49.
- ⑦ Hycor Co., Inc., 11423 Vanowen St., North Hollywood, Calif.
- Metropolitan Electronics & Instruments Co., 106 Fifth Ave., New York 11, N. Y.

DECADE BOXES—Resistance

- ⑦ Berkshire Laboratories, 580 Lexington Rd., Concord, Mass.
- ⑦ Brown Electro-Measurement Corp., 4637 S. E., Hawthorne Blvd., Portland 15, Oregon.
- ⑦ Bunnell & Co., J. H., 81 Prospect St., Brooklyn, N. Y.
- ⑦ CINEMA ENGINEERING CO., 1510 W. Verdugo Ave., Burbank, Calif. ADV. PG. 204.

- ⑦ CLAROSTAT MFG. CO., INC., Dover, N. H. ADV. PG. 100, 101.
- ⑦ Cole Instrument Co., 1320 S. Grand Ave., Los Angeles 15, Calif.
- ⑦ Custom Craft Mfg. Co., 256 E. 98th St., Brooklyn, N. Y.
- ⑦ DAVEN CO., 191 Central Ave., Newark 4, N. J. ADV. PG. 157.
- ⑦ ELECTRONIC INSTRUMENT CO., INC., 276 Newport St., Brooklyn 12, N. Y. ADV. PG. 129.
- ⑦ GENERAL RADIO CO., 275 Massachusetts Ave., Cambridge 39, Mass. ADV. PG. 48, 49.
- ⑦ HEATH CO., Benton Harbor, Mich. ADV. PG. 264.
- ⑦ Hycor Co., Inc., 11423 Vanowen St., North Hollywood, Calif.
- ⑦ Industrial Instruments, Inc., 17 Pollack Ave., Jersey City 5, N. J.
- ⑦ INSTRUMENTS RESISTORS CO., 1036 Commerce Ave., Union, N. J. ADV. PG. 392, 393.
- ⑦ Leeds & Northrup Co., 4970 Stenton Ave., Philadelphia 44, Pa.
- ⑦ Marma Electronic Co., 703 Willow St., Chicago 14, Ill.
- Metropolitan Electronics & Instruments Co., 106 Fifth Ave., New York 11, N. Y.
- ⑦ Monarch Radio & Television Corp., 2430 Atlantic Ave., Brooklyn 33, N. Y.
- ⑦ Muirhead & Co., Ltd., Beckenham-Kent-England.
- ⑦ OHMITE MFG. CO., 4835 W. Flournoy St., Chicago 44, Ill. ADV. PG. 41.
- ⑦ PAINTON & CO., LTD., 366 Madison Ave., New York 17, N. Y. ADV. PG. 336.
- ⑦ Rubicon Co., 3761 Ridge Ave., Philadelphia 29, Pa.
- ⑦ SHALLCROSS MFG. CO., 10 Jackson Ave., Collingdale, Pa. ADV. PG. 261.
- Sticht Co., Inc., Herman H., 27 Park Place, New York 7, N. Y.
- ⑦ Tech Laboratories, Inc., Bergen & Edsall Blvds., Palisades Park, N. J.
- ⑦ Technology Instrument Corp., 531 Main St., Acton, Mass.
- ⑦ Welch Scientific Co., W. M., 1515 Sedgwick St., Chicago 10, Ill.
- ⑦ Winslow Co., Inc., 9 Liberty St., Newark 5, N. J.

DEFLECTION YOKES

See Yokes, Deflection

DEHYDRATORS—Automatic

- ⑦ Communication Products Co., Inc., Marlboro, N. J.

DELAY LINES

- ⑦ Brew & Co., Inc., Richard D., 106 Concord Ave., Belmont 78, Mass.
- ⑦ GENERAL ELECTRIC CO., Schenectady 5, N. Y. ADV. PG. 1 to 22.
- ⑦ SHALLCROSS MFG. CO., 10 Jackson Ave., Collingdale, Pa. ADV. PG. 261.

DENSITOMETERS

- ⑦ Applied Research Labs., 4336 San Fernando Rd., Glendale 4, Calif.
- ⑦ Bausch & Lomb Optical Co., 635 St. Paul St., Rochester 2, N. Y.
- ⑦ Eastman Kodak Co., Industrial Photographic Div., 343 State St., Rochester 4, N. Y.
- ⑦ Hart Associates, 8430 Grand River, Detroit 4, Mich.
- ⑦ Hogan Laboratories, Inc., 155 Perry St., New York 14, N. Y.
- ⑦ Jarrel-Ash Co., 165 Newberry St., Boston 16, Mass.
- ⑦ Leeds & Northrup Co., 4970 Stenton Ave., Philadelphia 44, Pa.
- ⑦ Photobell Company, 116 Nassau St., New York 7, N. Y.
- ⑦ Photovolt Corp., 95 Madison Ave., New York 16, N. Y.
- ⑦ Welch Scientific Co., W. M., 1515 Sedgwick St., Chicago 10, Ill.
- ⑦ WESTON ELECTRICAL INSTRUMENT CORP., 595 Frelinghuysen Ave., Newark 5, N. J. ADV. PG. 243.

DEPTH SOUNDERS

- ⑦ Bludworth Marine Div., National-Simplex-Bludworth, Inc., 92 Gold St., New York 38, N. Y.
- ⑦ BOGUE ELECTRIC MFG. CO., 52 Iowa Ave., Paterson 3, N. J. ADV. PG. 155.
- ⑦ Edo Corp., College Point, N. Y.
- ⑦ Kaar Engineering Co., 2995 Middlefield Rd., P. O. Box 1320, Palo Alto, Calif.
- ⑦ RAYTHEON MFG. CO., Equipment Sales Div., Waltham 54, Mass. ADV. PG. 80, 81.

DETECTORS—Alpha

- ⑦ AIRMEC LABORATORIES LTD., 366 Madison Ave., New York 17, N. Y. ADV. PG. 336.
- ⑦ Anton Electronic Laboratories, Inc., 1226-1238 Flushington Ave., Brooklyn 6, N. Y.
- ⑦ ATOMIC INSTRUMENT CO., 84 Massachusetts Ave., Cambridge 39, Mass. ADV. PG. 410.
- ⑦ BARKER & WILLIAMSON, 235 Fairfield Ave., Upper Darby, Pa. ADV. PG. 292.

- ⑦ Beckman Instruments, Inc., 800 Mission St., South Pasadena, Calif.
- ⑦ Electronic Products Co., 111 E. Third St., Mt. Vernon, N. Y.
- ⑦ EL-TRONICS, INC., 2649 N. Howard St., Philadelphia 33, Pa. ADV. PG. 299.
- ⑦ GENERAL ELECTRIC CO., Schenectady 5, N. Y. ADV. PG. 1 to 22.
- ⑦ GENERAL RADIO CO., 275 Massachusetts Ave., Cambridge 39, Mass. ADV. PG. 48, 49.
- ⑦ Kelley-Koett Instrument Co., 962 York St., Cincinnati 14, Ohio.
- ⑦ Loudon Instruments, Inc., 5644 Lake Park Ave., Chicago 44, Ill.
- ⑦ Macdonald Co., Inc., W. S., 33 University Rd., Cambridge 38, Mass.
- ⑦ North American Philips Co., Inc., 100 E. 42nd St., New York 17, N. Y.
- ⑦ Nuclear Development Lab., P. O. Box 7034, Kansas City, Mo.
- ⑦ Nuclear Instrument & Chemical Corp., 223 W. Erie St., Chicago 10, Ill.
- ⑦ Nuclear Measurements Corp., 3339 Central Ave., Indianapolis 5, Ind.
- ⑦ Nuclear Research Corp., 2707 Federal St., Philadelphia 46, Pa.
- ⑦ Nuclonic Corp. of America, The, 497 Union St., Brooklyn 31, N. Y.
- ⑦ Radiation Counter Laboratories, Inc., 1844 W. 21st St., Chicago 8, Ill.
- ⑦ Radioactive Products, Inc., 443 W. Congress St., Detroit 26, Mich.
- ⑦ R-C Scientific Instrument Co., 335 Culver Blvd., Playa Del Rey, Calif.
- ⑦ Special Instruments Laboratories, Inc., 1003 Highland Ave., Knoxville, Tenn.
- ⑦ Technical Associates, 3730 San Fernando Rd., Glendale 4, Calif.
- ⑦ Tracerlab, Inc., 130 High St., Boston 10, Mass.
- ⑦ Wood Counter Laboratory, N., 5646 Harper Ave., Chicago 37, Ill.

DETECTORS—Beta

- ⑦ AIRMEC LABORATORIES LTD., 366 Madison Ave., New York 17, N. Y. ADV. PG. 336.
- ⑦ Anton Electronic Laboratories, Inc., 1226-1238 Flushington Ave., Brooklyn 6, N. Y.
- ⑦ ATOMIC INSTRUMENT CO., 84 Massachusetts Ave., Cambridge 39, Mass. ADV. PG. 410.
- ⑦ BARKER & WILLIAMSON, 235 Fairfield Ave., Upper Darby, Pa. ADV. PG. 292.
- ⑦ Beckman Instruments, Inc., 800 Mission St., South Pasadena, Calif.
- ⑦ Electronic Products Co., 111 E. Third St., Mt. Vernon, N. Y.
- ⑦ EL-TRONICS, INC., 2649 N. Howard St., Philadelphia 33, Pa. ADV. PG. 299.
- ⑦ Forty Niner Co., 5245 Grand River, Detroit 8, Mich.
- ⑦ GENERAL ELECTRIC CO., Schenectady 5, N. Y. ADV. PG. 1 to 22.
- ⑦ GENERAL RADIO CO., 275 Massachusetts Ave., Cambridge 39, Mass. ADV. PG. 48, 49.
- ⑦ Georator Corp., 1820 N. Nash St., Arlington, Va.
- ⑦ Kelley-Koett Instrument Co., 962 York St., Cincinnati 14, Ohio.
- ⑦ Loudon Instruments, Inc., 5644 Lake Park Ave., Chicago 44, Ill.
- ⑦ Macdonald Co., Inc., W. S., 33 University Rd., Cambridge 38, Mass.
- ⑦ North American Philips Co., Inc., 100 E. 42nd St., New York 17, N. Y.
- ⑦ Nuclear Development Lab., P. O. Box 7034, Kansas City, Mo.
- ⑦ Nuclear Instrument & Chemical Corp., 223 W. Erie St., Chicago 10, Ill.
- ⑦ Nuclear Measurements Corp., 3339 Central Ave., Indianapolis 5, Ind.
- ⑦ Nuclear Research Corp., 2707 Federal St., Philadelphia 46, Pa.
- ⑦ Nuclonic Corp. of America, The, 497 Union St., Brooklyn 31, N. Y.
- ⑦ Radiation Counter Laboratories, Inc., 1844 W. 21st St., Chicago 8, Ill.
- ⑦ Radioactive Products, Inc., 443 W. Congress St., Detroit 26, Mich.
- ⑦ R-C Scientific Instrument Co., 335 Culver Blvd., Playa Del Rey, Calif.
- ⑦ Special Instruments Laboratories, Inc., 1003 Highland Ave., Knoxville, Tenn.
- ⑦ Technical Associates, 3730 San Fernando Rd., Glendale 4, Calif.
- ⑦ Tracerlab, Inc., 130 High St., Boston 10, Mass.
- ⑦ Wood Counter Laboratory, N., 5646 Harper Ave., Chicago 37, Ill.

DETECTORS—Crystal

- ⑦ Feiler Engineering Co., 8026 Monticello Ave., Skokie, Ill.
- ⑦ Kemtron Electron Products, Inc., 23 Brown St., Salem, Mass.
- ⑦ Nuclear Research Corp., 2707 Federal St., Philadelphia 46, Pa.
- ⑦ Philmore Mfg. Co., Inc., 113 University Place, New York 3, N. Y.
- ⑦ Radiation Counter Laboratories, Inc., 1844 W. 21st St., Chicago 8, Ill.

Ⓢ indicates . . . IN PRODUCTION • AVAILABILITY • UNRESTRICTED FOR GENERAL USE

- ⓈR-C Scientific Instrument Co., 335 Culver Blvd., Playa Del Rey, Calif.
- ⓈSPERRY GYROSCOPE CO., Div. of The Sperry Corp., Great Neck, N. Y. ADV. PG. 103, 104.
- ⓈWeymouth Instrument Co., 1440 Commercial St., East Weymouth 89, Mass.

DETECTORS—Crystal Germanium

See Crystals, Germanium

DETECTORS—Crystal Silicon

See Crystals, Silicon

DETECTORS—Explosive Gas

- ⓈHEILAND RESEARCH CORP., 130 E. 5th Ave., Denver 9, Colo. ADV. PG. 401.
- ⓈJohnson-Williams, Ltd., Palo Alto, Calif.

DETECTORS—Fire

- ⓈC-O-Two Fire Equipment Co., P. O. Box 390, U. S. Highway 1, Newark 1, N. J.
- ⓈDiamond Power Specialty Corp., Lancaster, Ohio.
- ⓈEDISON INC., THOMAS A., Instrument Div., West Orange, N. J. ADV. PG. 212, 213.
- ⓈEdwards Co., Inc., 86 Boston Post Rd., Norwalk, Conn.
- ⓈElectronic Control Corp., 1573 E. Forest St., Detroit, Mich.
- ⓈEL-TRONICS, INC., 2649 N. Howard St., Philadelphia 33, Pa. ADV. PG. 299.
- ⓈFenwal, Inc., 43 Pleasant St., Ashland, Mass.
- ⓈGAMEWELL CO., THE, Newton Upper Falls 64, Mass. ADV. PG. 306.
- ⓈMinneapolis-Honeywell Regulator Co., 2753 Fourth Ave. S., Minneapolis, Minn.
- ⓈSERVO CORP. of AMERICA, 20-20 Jericho Turnpike, New Hyde Park, N. Y. ADV. PG. 150, 151.

DETECTORS—Flaw & Defect

- ⓈBRANSON INSTRUMENTS, INC., 438 Fairfield Ave., Stamford, Conn. ADV. PG. 90.
- ⓈDiamond Power Specialty Corp., Lancaster, Ohio.
- ⓈDice Co., J. W., Englewood, N. J.
- ⓈEDIN CO., INC., 207 Main St., Worcester, Mass. ADV. PG. 285.
- ⓈGENERAL ELECTRIC CO., Schenectady 5, N. Y. ADV. PG. 1 to 22.
- ⓈINDUSTRIAL ELECTRONICS, INC., 8080 Wheeler St., Detroit 10, Mich. ADV. PG. 234, 235.
- ⓈMenlo Research Laboratory, Menlo Park, Calif.
- ⓈSperry Products, Inc., Danbury, Conn.
- ⓈVacuum-Electronic Engineering Co., 756 Third Ave., Brooklyn 32, N. Y.

DETECTORS—Galena

- ⓈCarron Mfg. Co., 415 S. Aberdeen St., Chicago, Ill.
- ⓈElm Laboratories, 18 South Broadway, Dobbs Ferry, N. Y.

DETECTORS—Impedance

- ⓈAIRMEC LABORATORIES LTD., 366 Madison Ave., New York 17, N. Y. ADV. PG. 336.
- ⓈCOMMUNICATION MEASUREMENTS LAB. INC., 120 Greenwich St., New York 6, N. Y. ADV. PG. 290.
- ⓈEDIN CO., INC., 207 Main St., Worcester, Mass. ADV. PG. 285.
- ⓈMARCONI INSTRUMENTS, LTD., 23 Beaver St., New York 4, N. Y. ADV. PG. 270.
- ⓈPOLYTECHNIC RESEARCH & DEVELOPMENT CO., INC., 202 Tillary St., Brooklyn 1, N. Y. ADV. PG. 172, 173.

DETECTORS—Leak

- ⓈConsolidated Engineering Corp., 300 N. Sierra Madre Villa, Pasadena 8, Calif.
- ⓈDistillation Products Div. of Eastman Kodak Co., 755 Ridge Rd., W., Rochester 3, N. Y.
- ⓈElectronic Engineering Corp., 469 Elm St., Arlington, N. J.
- ⓈFisher Research Lab., 1961 University Ave., Palo Alto, Calif.
- ⓈGENERAL ELECTRIC CO., Schenectady 5, N. Y. ADV. PG. 1 to 22.
- ⓈNational Research Corp., 70 Memorial Drive, Cambridge 42, Mass.
- ⓈVacuum-Electronic Engineering Co., 756 Third Ave., Brooklyn 32, N. Y.

DETECTORS—Null

- ⓈAIRMEC LABORATORIES LTD., 366 Madison Ave., New York 17, N. Y. ADV. PG. 336.
- ⓈBARKER & WILLIAMSON, 235 Fairfield Ave., Upper Darby, Pa. ADV. PG. 292.

- ⓈBrown Electro-Measurement Corp., 4637 SE Hawthorne Blvd., Portland 15, Ore.
- ⓈDoelcam Corp., 56 Elmwood St., Newton 58, Mass.
- ⓈEDIN CO., INC., 207 Main St., Worcester, Mass. ADV. PG. 285.
- ⓈFRED TRANSFORMER CO., INC., 1736 Weirfield St., Brooklyn 27, N. Y. ADV. PG. 149.
- ⓈGENERAL RADIO CO., 275 Massachusetts Ave., Cambridge 39, Mass. ADV. PG. 48, 49.
- ⓈHEWLETT-PACKARD CO., 395 Page Mill Rd., Palo Alto, Calif. ADV. PG. 33-36.
- ⓈINDUSTRIAL CONTROL CO., Straight Path & Arlington Ave., Wyandanch, N. Y. ADV. PG. 130.
- ⓈLeeds & Northrup Co., 4970 Stenton Ave., Philadelphia 44, Pa.
- ⓈMacdonald Co., Inc., W. S., 33 University Rd., Cambridge 38, Mass.
- ⓈMARCONI INSTRUMENTS LTD., 23 Beaver St., New York 4, N. Y. ADV. PG. 270.
- ⓈMEASUREMENTS CORP., Boonton, N. J. ADV. PG. 99.
- ⓈMINNEAPOLIS-HONEYWELL REGULATOR CO., INDUSTRIAL DIV., Wayne & Roberts Ave., Philadelphia 44, Pa. ADV. PG. 208, 209.
- ⓈRubicon Co., 3761 Ridge Ave., Philadelphia 29, Pa.
- ⓈSHALLCROSS MFG. CO., 10 Jackson Ave., Collingdale, Pa. ADV. PG. 261.
- ⓈWinslow Co., Inc., 9 Liberty St., Newark 5, N. J.

DETECTORS—Null—r-f

- ⓈAIRMEC LABORATORIES LTD., 366 Madison Ave., New York 17, N. Y. ADV. PG. 336.
- ⓈGENERAL RADIO CO., 275 Massachusetts Ave., Cambridge 39, Mass. ADV. PG. 48, 49.
- ⓈHEWLETT-PACKARD CO., 395 Page Mill Rd., Palo Alto, Calif. ADV. PG. 33-36.
- ⓈMcMurdo Silver Co., Inc., 473 Lafayette St., New York, N. Y.
- ⓈMARCONI INSTRUMENTS, LTD., 23 Beaver St., New York 4, N. Y. ADV. PG. 270.
- ⓈNetwork Mfg. Corp., Bayonne, N. J.

DETECTORS—Null—VTVM

- ⓈAIRMEC LABORATORIES LTD., 366 Madison Ave., New York 17, N. Y. ADV. PG. 336.
- ⓈFRED TRANSFORMER CO., INC., 1736 Weirfield St., Brooklyn 27, N. Y. ADV. PG. 149.
- ⓈGENERAL RADIO CO., 275 Massachusetts Ave., Cambridge 39, Mass. ADV. PG. 48, 49.
- ⓈHEWLETT-PACKARD CO., 395 Page Mill Rd., Palo Alto, Calif. ADV. PG. 33-36.
- ⓈINDUSTRIAL CONTROL CO., Straight Path & Arlington Ave., Wyandanch, N. Y. ADV. PG. 130.
- ⓈLeeds & Northrup Co., 4970 Stenton Ave., Philadelphia 44, Pa.
- ⓈMcMurdo Silver Co., Inc., 473 Lafayette St., New York, N. Y.
- ⓈMARCONI INSTRUMENTS, LTD., 23 Beaver St., New York 4, N. Y. ADV. PG. 270.
- ⓈNetwork Mfg. Corp., Bayonne, N. J.

DETECTORS—Reactance

- ⓈAIRMEC LABORATORIES LTD., 366 Madison Ave., New York 17, N. Y. ADV. PG. 336.
- ⓈCOMMUNICATION MEASUREMENTS LAB. INC., 120 Greenwich St., New York 6, N. Y. ADV. PG. 290.
- ⓈEDIN CO., INC., 207 Main St., Worcester, Mass. ADV. PG. 285.
- ⓈSpecial Instruments Laboratories, Inc., 1003 Highland Ave., Knoxville, Tenn.

DETECTORS—Standing Wave

- ⓈDiamond Mfg. Co., Wakefield, Mass.
- ⓈGENERAL RADIO CO., 275 Massachusetts Ave., Cambridge 39, Mass. ADV. PG. 48, 49.
- ⓈHEWLETT-PACKARD CO., 395 Page Mill Rd., Palo Alto, Calif. ADV. PG. 33-36.
- ⓈINDUSTRIAL CONTROL CO., Straight Path & Arlington Ave., Wyandanch, N. Y. ADV. PG. 130.
- ⓈJONES ELECTRONICS CO., M. C., Bristol, Conn. ADV. PG. 384.
- ⓈKINGS MICROWAVE CO., INC., 50 Marbledale Rd., Tuckahoe 7, N. Y. ADV. PG. 178, 179.
- ⓈMARCONI INSTRUMENTS, LTD., 23 Beaver St., New York 4, N. Y. ADV. PG. 270.
- ⓈMicrowave Equipment Co., Inc., North Caldwell, N. J.
- ⓈNetwork Mfg. Corp., Bayonne, N. J.
- ⓈPOLYTECHNIC RESEARCH & DEVELOPMENT CO., INC., 202 Tillary St., Brooklyn 1, N. Y. ADV. PG. 172, 173.
- ⓈRollin Co., 2070 N. Fair Oaks Ave., Pasadena 3, Calif.
- ⓈShort Wave Plastic Forming Co., 2921 Alameda St., Burbank, Calif.
- ⓈSPERRY GYROSCOPE CO., Div. of The Sperry Corp., Great Neck, N. Y. ADV. PG. 103, 104.
- ⓈWeymouth Instrument Co., 1440 Commercial St., East Weymouth 89, Mass.
- ⓈWoodwelding, Inc., 3000 W. Olive Ave., Burbank, Calif.

DETECTORS—Vibration

- ⓈAircraft Electronics Associates, Inc., 94 Silas Deane Highway, Rocky Hill, Conn.
- ⓈAstatic Corp., The, Connetquot, N. Y.
- ⓈC. G. S. LABORATORIES, INC., 391 Ludlow St., Stamford, Conn. ADV. PG. 389.
- ⓈConsolidated Engineering Corp., 300 N. Sierra Madre Villa, Pasadena 8, Calif.
- ⓈEDIN CO., INC., 207 Main St., Worcester, Mass. ADV. PG. 285.
- ⓈELECTRO PRODUCTS LABS., 4501 N. Ravenswood Ave., Chicago 40, Ill. ADV. PG. 199.
- ⓈELECTRONIC ENGINEERING ASSOCIATES, LTD., 1048 Brittan Ave., San Carlos, Calif. ADV. PG. 393.
- Flader, Inc., Fredric, 1330 Laskey Rd., Toledo 12, Ohio.
- ⓈGENERAL ELECTRIC CO., Schenectady 5, N. Y. ADV. PG. 1 to 22.
- ⓈGENERAL RADIO CO., 275 Massachusetts Ave., Cambridge 39, Mass. ADV. PG. 48, 49.
- ⓈHEILAND RESEARCH CORP., 130 E. 5th Ave., Denver 9, Colo. ADV. PG. 401.
- ⓈINDUSTRIAL ELECTRONICS, INC., 8080 Wheeler St., Detroit 10, Mich. ADV. PG. 234, 235.
- ⓈKAY ELECTRIC CO., 14 Maple Ave., Pine Brook, N. J. ADV. PG. 340.
- ⓈMidwestern Geophysical Laboratory, 3400 S. Harvard, Tulsa, Okla.
- ⓈScott, Inc., Hermon Hosmer, 385 Putnam Ave., Cambridge 39, Mass.
- ⓈSouthwestern Industrial Electronics Co., 2831 Post Oak Rd., P. O. Box 13058, Houston 19, Texas.
- ⓈSPERRY GYROSCOPE CO., Div. of The Sperry Corp., Great Neck, N. Y. ADV. PG. 103, 104.

DETECTORS—Water Leak

- ⓈEdo Corp., College Point, N. Y.
- ⓈFisher Research Lab., 1961 University Ave., Palo Alto, Calif.
- ⓈNilsson Electrical Laboratory, Inc., 103 Lafayette St., New York 13, N. Y.

DIAL CRYSTALS

- ⓈEMELOID CO., INC., THE, 1239 Central Ave., Hillside 5, N. J. ADV. PG. 102.
- Felsenthal & Sons, Inc., G., 4100 W. Grand Ave., Chicago 51, Ill.
- ⓈGeneral Cement Mfg. Co., 919 Taylor Ave., Rockford, Ill.
- ⓈParisian Novelty Co., 3510 South Western Ave., Chicago 9, Ill.
- ⓈPhilco Corp., Tioga & C Sts., Philadelphia 34, Pa. Plastic Accessories, Inc., 93 Mercer St., New York 12, N. Y.
- Printloid Inc., 95 Mercer St., New York, N. Y.
- ⓈSillocks-Miller Co., 10 Parker Ave. W., So. Orange, N. J.

DIALS—Instrument

- ⓈAcromark Co., The, 442 Morrell St., Elizabeth 4, N. J.
- ⓈAmerican Laubscher Corp., 333 W. 52nd St., New York 19, N. Y.
- ⓈAssociated Research, Inc., 3758 W. Belmont, Chicago 18, Ill.
- Austin Co., O., 335 Throop Ave., Brooklyn 21, N. Y.
- ⓈBELOCK INSTRUMENT CORP., 111th St. & 14th Ave., College Point, N. Y. ADV. PG. 371.
- ⓈBORG EQUIPMENT DIVISION, The George W. Borg Corp., Delavan, Wis. ADV. PG. 155.
- ⓈBud Radio, Inc., 2118 E. 55th St., Cleveland 3, Ohio.
- Bunnell & Co., J. H., 81 Prospect St., Brooklyn, N. Y.
- ⓈCINEMA ENGINEERING CO., 1510 W. Verdugo Ave., Burbank, Calif. ADV. PG. 204.
- ⓈConsolidated Molded Products Corp., Scranton 2, Pa.
- ⓈCortland Industries, Inc., 4545 Cortland St., Chicago 39, Ill.
- ⓈCroname, Inc., 3701 Ravenswood Ave., Chicago, Ill.
- ⓈEMELOID CO., INC., THE, 1239 Central Ave., Hillside 5, N. J. ADV. PG. 102.
- Felsenthal & Sons, Inc., G., 4100 W. Grand Ave., Chicago 51, Ill.
- ⓈFLOCK PROCESS CO., INC., 28 Fahey St., Springfield, Conn. ADV. PG. 196.
- ⓈFoxboro Co., The, Foxboro, Mass.
- ⓈGENERAL RADIO CO., 275 Massachusetts Ave., Cambridge 39, Mass. ADV. PG. 48, 49.
- ⓈGits Molding Corp., 4600 W. Huron St., Chicago 44, Ill.
- ⓈHELIPOT CO., 916 Meridian Ave., So. Pasadena, Calif. ADV. PG. 153.
- ⓈInsulating Fabricators of New England, Inc., 69 Grove St., Watertown 72, Mass.
- ⓈJOHNSON CO., E. F., Waseca, Minn. ADV. PG. 118, 121.
- ⓈMica Insulator Co., Schenectady 1, N. Y.
- ⓈMillen Mfg. Co., James, 150 Exchange St., Malden, Mass.
- ⓈMolded Insulation Co., 335 E. Price St., Philadelphia, Pa.

Ⓜ indicates . . . IN PRODUCTION • AVAILABILITY • UNRESTRICTED FOR GENERAL USE

- Ⓜ NATIONAL CO., INC., 61 Sherman St., Malden 48, Mass. ADV. PG. 280, 281.
- Ⓜ PAINTON & CO., INC., LTD., 366 Madison Ave., New York 17, N. Y. ADV. PG. 336
- Ⓜ Parisian Novelty Co., 3510 S. Western Ave., Chicago 9, Ill.
- Plastic Accessories, Inc., 93 Mercer St., New York 17 N. Y.
- Plastic Fabricators Co., 440 Sansome St., San Francisco 11, Calif.
- Ⓜ Premier Metal Etching Co., 21-03 44th Ave., Long Island City, N. Y.
- Printoid, Inc., 95 Mercer St., New York, N. Y.
- Ⓜ Radiocrafters, 1156 Commonwealth Ave., Boston 34, Mass.
- Ⓜ REEVES INSTRUMENT CORP., 215 E. 91st St., New York, N. Y. ADV. PG. 315
- Ⓜ SHALLCROSS MFG. CO., 10 Jackson Ave., Collingdale, Pa. ADV. PG. 261.
- Ⓜ Sillocks-Miller Co., 10 Parker Ave. W., So. Orange, N. J.
- Ⓜ Tagliabue Div., Weston Electrical Instrument Corp., 614 Frelinghuysen Ave., Newark 5, N. J.
- Ⓜ Technology Instrument Corp., 531 Main St., Acton, Mass.
- Ⓜ U. S. Radium Corp., 535 Pearl St., New York 7, N. Y.

DIALS—Precision

- Ⓜ Acromark Co., The, 422 Morrell St., Elizabeth 4, N. J.
- Ⓜ American Laubscher Corp., 333 W. 52nd St., New York 19, N. Y.
- Ⓜ Baldwin-Lima-Hamilton Corp., Paschall P. O. Station, Philadelphia 42, Pa.
- Ⓜ CINEMA ENGINEERING CO., 1510 W. Verdugo Ave., Burbank, Calif. ADV. PG. 204.
- Ⓜ Croname, Inc., 3701 Ravenswood Ave., Chicago, Ill.
- Ⓜ EMELOID CO., INC., THE, 1239 Central Ave., Hillside 5, N. J. ADV. PG. 102.
- Felsenthal & Sons, Inc., G., 4100 W. Grand Ave., Chicago 51, Ill.
- Ⓜ FLOCK PROCESS CO., INC., 28 Fahey St., Springdale, Conn. ADV. PG. 196.
- Ⓜ Gaertner Scientific Corp., 1201 Wrightwood Ave., Chicago 14, Ill.
- Ⓜ GENERAL RADIO CO., 275 Massachusetts Ave., Cambridge 39, Mass. ADV. PG. 48, 49.
- Ⓜ Instrument Laboratories, 315 W. Walton Place, Chicago 10, Ill.
- Ⓜ Millen Mfg. Co., James, 150 Exchange St., Malden, Mass.
- Ⓜ NATIONAL CO., INC., 61 Sherman St., Malden 48, Mass. ADV. PG. 280, 281.
- Plastic Accessories, Inc., 93 Mercer St., New York 12, N. Y.
- Printoid, Inc., 95 Mercer St., New York, N. Y.
- Ⓜ REEVES INSTRUMENT CORP., 215 E. 91st St., New York, N. Y. ADV. PG. 315.
- Ⓜ SERVO CORP. OF AMERICA, 20-20 Jericho Turnpike, New Hyde Park, N. Y. ADV. PG. 150, 151.
- Ⓜ Tagliabue Div., Weston Electrical Instrument Corp., 614 Frelinghuysen Ave., Newark 5, N. J.
- Ⓜ Transradio, Ltd., 138A Cromwell Rd., London S. W. 7, England.
- Ⓜ U. S. Radium Corp., 535 Pearl St., New York 7, N. Y.

DIAPHRAGMS

- Ⓜ Fulton Siphon Div., Robertshaw-Fulton Control Co., Knoxville 4, Tenn.
- Ⓜ Garlock Packing Co., Palmyra, N. Y.
- Ⓜ Hawley Products Co., St. Charles, Ill.
- Ⓜ LORD MFG. CO., 1635 W. 12th St., Erie, Pa. ADV. PG. 51.
- Ⓜ Racon Electric Co., 52 E. 19th St., New York 3, N. Y.
- Ⓜ Stevens Products Inc., 86-88 Main St., East Orange, N. J.
- Ⓜ TEFLON PRODUCTS DIVISION, U. S. GASKET CO., P. O. Box 93, Camden, N. J. ADV. PG. 176.
- Ⓜ Wappler, Inc., 27 W. 24th St., New York 10, N. Y.
- Ⓜ WESTINGHOUSE ELECTRIC CORP., 511 Wood St., P. O. Box 868, Pittsburgh 30, Pa. ADV. PG. 107-113.

DIATHERMY

- Ⓜ American Diathermy Products, Inc., 11858 Mississippi Ave., Los Angeles 25, Calif.
- Dallons Labs., 5066 Santa Monica Blvd., Los Angeles, Calif.
- Ⓜ Electronic Surgical Equipment Co., Inc., N. E. Cor. 23 & Arch Sts., Philadelphia 3, Pa.
- Ⓜ General Electric X-Ray Corp., 4855 Electric Ave., Milwaukee, Wis.
- Ⓜ Hanovia Chemical & Mfg. Co., 233 N. J. RR Ave., Newark, N. J.
- Ⓜ Lepel High Frequency Labs., Inc., 39 W. 60th St., New York 23, N. Y.
- Ⓜ Liebel-Flarshelm Co., 303 W. Third St., Cincinnati 2, Ohio.
- Ⓜ Magna Electronics Co., 3707-11 W. Jefferson Blvd., Los Angeles 16, Calif.

- Ⓜ Mooradian High Frequency Labs., 13 E. Fort Lee Rd., Bogota, N. J.
- Ⓜ Wappler, Inc., 27 W. 24th St., New York 10, N. Y.

DIELECTRIC HEATING See Heating, Dielectric

DIELECTRICS—Gas

- Ⓜ GENERAL CHEMICAL DIV., ALLIED CHEMICAL & DYE CORP., 40 Rector St., New York 6, N. Y. ADV. PG. 84.

DIELECTRICS—Liquids & Solids

- Ⓜ ANTARA PRODUCTS DIVISION, General Dyestuff Corp., 435 Hudson St., New York 14, N. Y. ADV. PG. 268.
- Ⓜ CROWLEY & CO., INC., HENRY L., 1 Central Ave., West Orange, N. J. ADV. PG. 231.
- Ⓜ Dielectric Materials Co., 5315-17 N. Ravenswood Ave., Chicago 40, Ill.
- Ⓜ Dow Corning Corp., Midland, Mich.
- Ⓜ GENERAL CERAMICS & STEATITE CORP., Kearsbey, N. J. ADV. PG. 126, 127.
- Ⓜ Halowax Products Division, Union Carbide & Carbon Corp., 30 E. 42nd St., New York 17, N. Y.
- Ⓜ Houghton Laboratories, Inc., 322 Bush St., Olean, N. Y.
- Ⓜ Schweitzer, Inc., Peter J., 405 Lexington Ave., New York 17, N. Y.
- Ⓜ TEFLON PRODUCTS DIVISION, U. S. Gasket Co., P. O. Box 93, Camden, N. J. ADV. PG. 176.
- Ⓜ ZOPHAR MILLS, INC., 112-130 26th St., Brooklyn 32, N. Y. ADV. PG. 397.

DIES

- Ⓜ ABALON PRECISION MFG. CORP., 540 Casanova St., Bronx 59, N. Y. ADV. PG. 348.
- Ⓜ Acklin Stamping Co., 1923 Nebraska Ave., Toledo 7, Ohio.
- Ⓜ Acromark Co., The, 422 Morrell St., Elizabeth 4, N. J.
- Ⓜ ART-LLOYD METAL PRODUCTS CORP., 2973 Cropsey Ave., Brooklyn 14, N. Y. ADV. PG. 364.
- Ⓜ Askania Regulator Co., 240 E. Ontario St., Chicago 11, Ill.
- Ⓜ Barrett Bindery Co., 1332 W. Monroe St., Chicago 7, Ill.
- Ⓜ CITATION PRODUCTS CO., 233 E. 146th St., New York 51, N. Y. ADV. PG. 388.
- Ⓜ Electro Craft Inc., 52 Davenport St., Stamford, Conn.
- Ⓜ Felsenthal & Sons, Inc., G., 4100 W. Grand Ave., Chicago 51, Ill.
- Ⓜ Felt Products Mfg. Co., 1504 W. Carroll Ave., Chicago 7, Ill.
- Ⓜ Greene Mfg. Corp., G. G., Warren, Pa.
- Ⓜ HELDOR MFG. CO., Div. of Helder Bushing & Terminal Inc., 225 Belleville Ave., Bloomfield, N. J. ADV. PG. 242.
- Ⓜ Hovis Screwlock Co., 8100 E. Nine Mile Rd., Van Dyke, Mich.
- Ⓜ Industrial Precision Products Co., 315-325 N. Hoyle Ave., Chicago 12, Ill.
- La Magna Mfg. Co., Inc., East Rutherford, N. J.
- Ⓜ Micacraft Products, Inc., 701 McCarter Highway, Newark 5, N. J.
- Ⓜ Miller Mfg. Co., M. A., 1169 E. 43rd St., Chicago 15, Ill.
- Ⓜ North American Philips Co., Inc., 100 E. 42nd St., New York 17, N. Y.
- Ⓜ O'Neil Irwin Mfg. Co., 316 8th Ave., Lake City, Minn.
- Ⓜ PIX MFG. CO., INC., 24 Bedford St., Newark, N. J. ADV. PG. 136.
- Ⓜ Precision Devices, Inc., 147-149 Cedar St., New York 6, N. Y.
- Ⓜ Repath Co., Paul R., 641 E. 61st St., Los Angeles 1, Calif.
- Ⓜ Romac Products Co., 112 Bleecker St., New York 12, N. Y.
- Ⓜ Sheffield Corp., Dayton 1, Ohio.
- Ⓜ Toman & Co., E., 2621 E. 21st Place, Chicago 8, Ill.
- Ⓜ Whistler & Sons, Inc., S. B., 752 Military Rd., Buffalo 17, N. Y.
- Ⓜ Zierick Mfg. Corp., Beechwood & Rockdale Aves., New Rochelle, N. Y.

DIRECTION FINDERS

- Ⓜ Aeronautical Electronics, Inc., Raleigh-Durham Airport, P. O. Box 6043, Raleigh, N. C.
- Ⓜ AIR ASSOCIATES, INC., Teterboro, N. J. ADV. PG. 211.
- Ⓜ AMERICAN ELECTRONIC ENGINEERING CORP., 5025-29 W. Jefferson Blvd., Los Angeles 16, Calif. ADV. PG. 136.
- Ⓜ Applied Electronics Co., 1246 Folsom St., San Francisco 3, Calif.
- Ⓜ BARKER & WILLIAMSON, 235 Fairfield Ave., Upper Darby, Pa. ADV. PG. 292.
- Ⓜ Bludworth Marine Div., National-Simplex-Bludworth, Inc., 92 Gold St., New York 38, N. Y.

- Ⓜ Elm Laboratories, 18 South Broadway, Dobbs Ferry, N. Y.
- Ⓜ FAIRCHILD CAMERA & INSTRUMENT CORP., 88-06 Van Wyck Blvd., Jamaica 1, N. Y. ADV. PG. 244, 245.
- Ⓜ FEDERAL TELECOMMUNICATION LABS., INC., 500 Washington Ave., Nutley 10, N. J. ADV. PG. 164.
- Ⓜ FEDERAL TELEPHONE & RADIO CORP., 88 Kingsland Rd., Clifton, N. J. ADV. PG. 161-163.
- Ⓜ Fisher Research Lab., 1961 University Ave., Palo Alto, Calif.
- Ⓜ Intervox Corp., 2701 California Ave., Seattle 6, Wash.
- Ⓜ Jarvis Electronics Corp., 6058 Fullerton Ave., Chicago 39, Ill.
- Ⓜ Jefferson, Inc., Ray, 40 E. Merrick Rd., Freeport, N. Y.
- Ⓜ Kaar Engineering Co., 2995 Middlefield Rd., P. O. Box 1320, Palo Alto, Calif.
- La Magna Mfg. Co., Inc., East Rutherford, N. J.
- Ⓜ Lear, Inc., 110 Ionia Ave., N. W., Grand Rapids 2, Mich.
- Ⓜ MARCONI INSTRUMENTS, LTD., 23 Beaver St., New York 4, N. Y. ADV. PG. 270.
- Ⓜ Radiomarine Corp. of America, 75 Varick St., New York 13, N. Y.
- Ⓜ RAYTHEON MFG. CO., Equipment Sales Div., Waltham 54, Mass. ADV. PG. 80, 81.
- Ⓜ SERVO CORP. OF AMERICA, 20-20 Jericho Turnpike, New Hyde Park, N. Y. ADV. PG. 150, 151.
- Ⓜ Standard Telephones & Cables Ltd., Connaught House, Aldwych, London, W. C. 2, England.

DISCS—Blank Recording

- Ⓜ Advance Recording Products Co., 36-12 34th St., Long Island City, N. Y.
- Ⓜ Allied Recording Products Co., 21-09 43rd Ave., Long Island City 1, N. Y.
- Ⓜ AUDIO DEVICES, INC., 444 Madison Ave., New York 22, N. Y. ADV. PG. 77.
- Ⓜ Caltron Co., 1406 S. Hobart Blvd., Los Angeles 6, Calif.
- Ⓜ DUOTONE CO., INC., Keyport, N. Y. ADV. PG. 307.
- Ⓜ Edison Inc., Thomas A., Ediphone Div., 51 Lakeside Ave., West Orange, N. J.
- Ⓜ Home Recording Products Corp., Freeport, L. I., N. Y.
- Ⓜ Mirror Record Corp., 4025-206 St., Bayside, N. Y.
- Ⓜ Philco Corp., Tioga & C Sts., Philadelphia 34, Pa.
- Ⓜ PRESTO RECORDING CORP., Paramus, N. J. ADV. PG. 52, 53.
- Ⓜ Recordisc Corp., 395 Broadway, New York, N. Y.
- Ⓜ Reoton Corp., 251 Fourth Ave., New York 10, N. Y.
- Ⓜ REEVES SOUNDRAFT CORP., 10 E. 52nd St., New York, N. Y. ADV. PG. 372.
- Ⓜ Sonic Recording Products, Inc., 58 Mill Road, Freeport, N. Y.
- Ⓜ Soundscriber Corp., 146 Munson St., New Haven 4, Conn.
- Ⓜ Zephyr Products Co., 160 E. 116th St., New York 29, N. Y.

DRAFTING EQUIPMENT

- Ⓜ Art Specialty Co., 3245 W. Lake St., Chicago, Ill.
- Ⓜ Bruning Co., Inc., Charles, 102 Reade St., New York, N. Y.
- Ⓜ Clearprint Paper Co., 677 Folsom St., San Francisco, Calif.
- Ⓜ Dietzgen Co., Eugene, 2425 Sheffield Ave., Chicago, Ill.
- Ⓜ Eberhard Faber Pencil Co., 37 Greenpoint Ave., Brooklyn 22, N. Y.
- Ⓜ Holliston Mills Inc., Norwood, Mass.
- Ⓜ Keuffel & Esser Co., Hoboken, N. J.
- Ⓜ Koh-I-Noor Pencil Co., Bloomsbury, N. J.
- Ⓜ Pease Co., C. F., 2601 W. Irving Park Rd., Chicago, Ill.
- Ⓜ Post Co., Frederick, 3650 N. Avondale Ave., P. O. Box 803, Chicago 90, Ill.
- Ⓜ Staedtler Inc., J. S., 55 Worth St., New York, N. Y.
- Ⓜ Universal Drafting Machine Corp., 7960 Lorain Ave., Cleveland 2, Ohio.

DRIVERS—Recording

- Ⓜ Clarke Instrument Div., National Electrical Machine Shops, Inc., 919 Jesup-Blair Dr., Silver Spring, Md.
- Ⓜ Eastern Air Devices, Inc., 585 Dean St., Brooklyn 17, N. Y.
- Ⓜ Lear, Inc., 110 Ionia Ave., N. W., Grand Rapids 2, Mich.

DRIVES—Small Electric Drive Mechanisms

- Ⓜ AIR ASSOCIATES, INC., Teterboro, N. J. ADV. PG. 211.
- Ⓜ Bodine Electric Co., Ohio St. & Oakley Blvd., Chicago 12, Ill.
- Ⓜ Bunnell & Co., J. H., 81 Prospect St., Brooklyn, N. Y.
- Ⓜ DoAll Co., 254 N. Laurel Ave., Des Plaines, Ill.
- Ⓜ Doelcam Corp., 56 Elmwood Ave., Newton 58, Mass.
- Ⓜ Eastern Air Devices, Inc., 585 Dean St., Brooklyn 17, N. Y.
- Ⓜ Gale Dorothea Mechanisms, 37-61 85th St., Jackson Heights, N. Y.
- Ⓜ INDUSTRIAL CONTROL CO., Straight Path & Arlington Ave., Wyandanch, N. Y. ADV. PG. 130.
- Ⓜ Lear, Inc., 110 Ionia Ave., N. W., Grand Rapids 2, Mich.

(V) indicates . . . **IN PRODUCTION • AVAILABILITY • UNRESTRICTED FOR GENERAL USE**

- ⓂMcElroy Mfg. Corp., Littleton, N. J.
- ⓂSERVO CORP. OF AMERICA, 20-20 Jericho Turnpike, New Hyde Park, N. Y. ADV. PG. 150, 151.
- ⓂSoundscriber Corp., 146 Munson St., New Haven 4, Conn.

DRYERS, ELECTRONIC—Dehydration and Drying

- ⓂCommunication Products Co., Inc., Marlboro, N. J.
- ⓂFostoria Pressed Steel Corp., Fostoria, Ohio.
- ⓂMiskella Infra-Red Co., E. 73rd & Grand Ave., Cleveland 4, Ohio.
- ⓂStokes Machine Co., F. J., 5850 Tabor Rd., Olney P. O., Philadelphia 20, Pa.

DYNAMOMETERS

- ⓂAvion Instrument Corp., Paramus, N. J.
- ⓂDillon & Co., Inc., W. C., 1421 S. Circle Ave., Forest Park, Ill.
- ⓂGENERAL ELECTRIC CO., Schenectady 5, N. Y. ADV. PG. 1 to 22.
- ⓂL. A. B. Corp., 31 Union Place, Summit, N. J.
- ⓂLeaar, Inc., 110 Ionia Ave., N. W., Grand Rapids 2, Mich.
- ⓂMission Electric Mfg. Co., 132 W. Colorado Blvd., Pasadena, Calif.
- ⓂSensitive Research Instrument Corp., 9 Elm Ave., Mt. Vernon, N. Y.
- ⓂTriplett Electrical Instrument Co., Harmon Road, Bluffton, Ohio.
- ⓂWESTINGHOUSE ELECTRIC CORP., 511 Wood St., P. O. Box 868, Pittsburgh 30, Pa. ADV. PG. 107-113.

DYNAMOTORS

See Generators, Motor

ELECTRO MAGNETS

See Magnets

ELECTROCARDIOGRAPHS

- ⓂCOSSOR, LTD., A. C., 350 Fifth Ave., New York 3, N. Y. ADV. PG. 412.
- ⓂCossor (Canada) Ltd., 301-303 Windsor St., Halifax, N. S., Canada.
- ⓂEDIN CO., INC., 207 Main St., Worcester, Mass. ADV. PG. 285.
- ⓂElectro-Physical Laboratories, Inc., Harvard Ave., Stamford, Conn.
- ⓂGeneral Electric X-Ray Corp., 4855 Electric Ave., Milwaukee, Wis.
- ⓂHathaway Instrument Co., 1315 S. Clarkson St., Denver 10, Colo.
- ⓂMARCONI INSTRUMENTS, LTD., 23 Beaver St., New York 4, N. Y. ADV. PG. 270.
- ⓂOak Ridge Products Mfg. Div. of Video Television, Inc., 37-01 Vernon Blvd., Long Island City 1, N. Y.
- ⓂPhoton Instrument Co., 6516 Detroit Ave., Cleveland 2, Ohio.
- ⓂSANBORN CO., 39 Osborn St., Cambridge 39, Mass. ADV. PG. 391.
- ⓂTech Laboratories, Inc., Bergen & Edsall Blvds., Pallsades Park, N. J.

ELECTRODES—High Frequency

- ⓂBranston Electric Mfg. Co., Inc., 62 Gill Place, Buffalo 22, N. Y.
- ⓂEcco High Frequency Corp., 7020 Hudson Blvd., North Bergen, N. J.
- ⓂElectronic Surgical Equipment Co., Inc., N. E. Cor. 23 & Arch Sts., Philadelphia 3, Pa.
- ⓂGasket Engineering Co., 2440 Charlotte St., Kansas City 8, Mo.
- ⓂShort Wave Plastic Forming Co., 2921 W. Alameda St., Burbank, Calif.
- ⓂWappler, Inc., 27 W. 24th St., New York 10, N. Y.
- ⓂWoodwelding, Inc., 3000 W. Olive Ave., Burbank, Calif.

ELECTRODYNAMOMETERS

- ⓂAvion Instrument Corp., Paramus, N. J.
- ⓂGENERAL ELECTRIC CO., Schenectady 5, N. Y. ADV. PG. 1 to 22.
- ⓂRawson Electrical Instrument Co., 111 Potter St., Cambridge 42, Mass.
- ⓂTriplett Electrical Instrument Co., Harmon Road, Bluffton, Ohio.
- ⓂWESTINGHOUSE ELECTRIC CORP., 511 Wood St., P. O. Box 868, Pittsburgh 30, Pa. ADV. PG. 107-113.

ELECTROENCEPHALOGRAPHS

- ⓂEDIN CO., INC., 207 Main St., Worcester, Mass. ADV. PG. 285.
- ⓂElectro-Medical Lab., Inc., South Woodstock, Vt.
- ⓂGrass Instrument Co., 101 Old Colony Ave., Quincy, Mass.
- ⓂMARCONI INSTRUMENTS, LTD., 23 Beaver St., New York 4, N. Y. ADV. PG. 270.

- ⓂOffner Electronics, Inc., 5320 N. Kedzie Ave., Chicago 25, Ill.
- ⓂRAHM INSTRUMENTS, INC., 12 W. Broadway, New York 7, N. Y. ADV. PG. 354.

ELECTROMYOGRAPHS

- ⓂEDIN CO., INC., 207 Main St., Worcester, Mass. ADV. PG. 285.
- ⓂElectro-Medical Lab., Inc., South Woodstock, Vt.
- ⓂMARCONI INSTRUMENTS, LTD., 23 Beaver St., New York 4, N. Y. ADV. PG. 270.
- ⓂRAHM INSTRUMENTS, INC., 12 W. Broadway, New York 7, N. Y. ADV. PG. 354.

ELECTROPLETHYSMOGRAPHS

- ⓂEDIN CO., INC., 207 Main St., Worcester, Mass. ADV. PG. 285.
- ⓂGrass Instrument Co., 101 Old Colony Ave., Quincy, Mass.
- ⓂProcess & Instruments, 60 Greenpoint Ave., Brooklyn 22, N. Y.
- ⓂTechnitrol Engineering Co., 3211 Woodland Ave., Philadelphia 4, Pa.
- ⓂTorgren Co., Inc., C. W., 236 Pearl St., Somerville 45, Mass.
- ⓂWelch Scientific Co., W. M., 1515 Sedgwick St., Chicago 10, Ill.

ELECTRO-SHOCK THERAPY APPARATUS

- ⓂAerolux Light Corp., 653 11th Ave., New York 19, N. Y.
- ⓂEDIN CO., INC., 207 Main St., Worcester, Mass. ADV. PG. 285.
- ⓂElectronic Surgical Equipment Co., Inc., N. E. Cor. 23 & Arch Sts., Philadelphia 3, Pa.
- ⓂLektra Laboratories, 154 11th Ave., New York 3, N. Y.
- ⓂOffner Electronics, Inc., 5320 N. Kedzie Ave., Chicago 25, Ill.
- ⓂRAHM INSTRUMENTS, INC., 12 W. Broadway, New York 7, N. Y. ADV. PG. 354.

ELECTRO-SURGICAL APPARATUS

- ⓂAmerican Diathermy Products, Inc., 11858 Mississippi Ave., Los Angeles 25, Calif.
- ⓂBaldwin-Lima-Hamilton Corp., Paschall P. O. Station, Philadelphia 42, Pa.
- ⓂDalton Labs., 5066 Santa Monica Blvd., Los Angeles, Calif.
- ⓂEDIN CO., INC., 207 Main St., Worcester, Mass. ADV. PG. 354.
- ⓂElectronic Surgical Equipment Co., Inc., N. E. Cor. 23 & Arch Sts., Philadelphia 3, Pa.
- ⓂGeneral Electric X-Ray Corp., 4855 Electric Ave., Milwaukee, Wis.
- ⓂGlenco Corp., Metuchen, N. J.
- ⓂGulton Mfg. Corp., Metuchen, N. J.
- ⓂLiebel-Flarsheim Co., 303 W. Third St., Cincinnati 2, Ohio.
- ⓂMooradian High Frequency Labs., 13 E. Fort Lee Rd., Bogota, N. J.
- ⓂNew London Instrument Co., Box 189, New London, Conn.
- ⓂProcess & Instruments, 60 Greenpoint Ave., Brooklyn 22, N. Y.
- ⓂTechnitrol Engineering Co., 3211 Woodland Ave., Philadelphia 4, Pa.
- ⓂWappler, Inc., 27 W. 24th St., New York 10, N. Y.

ELEMENTS, HEATING—Crystal Oven

- ⓂBassett, Inc., Rex, 307-11 N. W. First Ave., Fort Lauderdale, Fla.
- ⓂGasket Engineering Co., 2440 Charlotte St., Kansas City 8, Mo.
- ⓂMonitor Products Co., 815 Fremont St., So. Pasadena, Calif.
- ⓂStates Co., 19 New Park Ave., Hartford 6, Conn.

ESCUTCHEONS

- ⓂAllmetal Screw Products Co., Inc., 33 Greene St., New York 13, N. Y.
- ⓂAMERICAN PHENOLIC CORP., 1830 S. 54th Ave., Chicago 50, Ill. ADV. PG. 61.
- ⓂCatalin Corp. of America, 1 Park Ave., New York 16, N. Y.
- ⓂCroname, Inc., 3701 Ravenswood Ave., Chicago, Ill.
- ⓂDelco Radio Div., General Motors Corp., Kokomo, Ind.
- ⓂEMELOID CO., INC., THE, 1239 Central Ave., Hillside 5, N. J. ADV. PG. 102.
- ⓂERIE RESISTOR CORP., 644 12th St., Erie, Pa. ADV. PG. 91.
- ⓂEtched Products Corp., 39-01 Queens Blvd., Long Island City, N. Y.
- ⓂGemloid Corp., 70-10 Albion Ave., Elmhurst, N. Y.
- ⓂGits Molding Corp., 4600 W. Huron St., Chicago 44, Ill.

- ⓂHarper Co., H. M., 8200 Lehigh Ave., Morton Grove, Ill.
- ⓂParisian Novelty Co., 3510 South Western Ave., Chicago 9, Ill.
- ⓂPlastimold Corp., Attleboro, Mass.
- ⓂPrecision Plastic Products, Inc., 628-30 W. Lake St., Chicago 6, Ill.
- ⓂStronghold Screw Products Inc., 216-222 W. Hubbard St., Chicago 10, Ill.
- ⓂSyracuse Ornamental Co., 581 So. Clinton St., Syracuse, N. Y.

EYELETS

- ⓂAMERICAN BRASS CO., 25 Broadway, New York 4, N. Y. ADV. PG. 330.
- ⓂAMERICAN LAVA CORP., Chattanooga 5, Tenn. ADV. PG. 143.
- ⓂART WIRE & STAMPING CO., 227 High St., Newark 2, N. J. ADV. PG. 38.
- ⓂAtlas Tack Corp., Pleasant St., Fairhaven, Mass.
- ⓂBarrett Bindery Co., 1332 W. Monroe St., Chicago 7, Ill.
- ⓂCINCH MFG. CORP., 1026 S. Homan Ave., Chicago 24, Ill. ADV. PG. 186, 187.
- ⓂEyelet Tool Co., 188 Dorchester Ave., Boston, Mass.
- ⓂFEDERAL SCREW PRODUCTS INC., 224 W. Huron St., Chicago 10, Ill. ADV. PG. 76.
- ⓂGENERAL ACCESSORIES CO., LTD., 366 Madison Ave., New York 17, N. Y. ADV. PG. 336.
- ⓂGeneral Cement Mfg. Co., 919 Taylor Ave., Rockford, Ill.
- ⓂJOHNSON & HOFFMAN, INC., 65 Ongley St., Rockville Center, N. Y. ADV. PG. 353.
- ⓂPIX MFG. CO., INC., 24 Bedford St., Newark, N. J. ADV. PG. 136.
- ⓂPlume & Atwood Mfg. Co., 220 Broadway, New York, N. Y.
- ⓂRevere Copper & Brass, Inc., 230 Park Ave., New York 17, N. Y.
- ⓂScovill Mfg. Co., Industrial Fastener Div., Waterbury, Conn.
- ⓂSegal, Edward, 72 Spring St., New York 12, N. Y.
- ⓂStimpson Co., Inc., Edwin B., 74 Franklin Ave., Brooklyn 5, N. Y.
- ⓂStronghold Screw Products, Inc., 216-222 W. Hubbard St., Chicago 10, Ill.
- ⓂUcinite Co. Division United Carr Fastener Corp., 459 Watertown St., Newtonville, Mass.
- ⓂUnited Carr Fastener Corp., Cambridge 42, Mass.
- ⓂUnited Shoe Machinery Corp., 142 Federal St., Boston, Mass.

FABRIC

See Insulation Materials

FACSIMILE

See Recorders, Facsimile

FACSIMILE RECORDING PAPERS

See Recorders Facsimile

FANS—Tube Cooling

- ⓂAIR-MARINE MOTORS, INC., 2183 Jackson Ave., Seaford, N. Y. ADV. PG. 376.
- ⓂDynamic Air Engineering Inc., 1619 S. Alameda St., Los Angeles, Calif.
- ⓂEastern Air Devices, Inc., 585 Dean St., Brooklyn 17, N. Y.
- ⓂFasco Industries, Inc., Rochester 2, N. Y.
- ⓂIlg Electric Ventilating Co., 2850 N. Crawford Ave., Chicago 41, Ill.
- ⓂRobbins & Myers, Inc., 1345 Lagonda Ave., Springfield 99, Ohio.
- ⓂROTRON MFG. CO., 7-9 Schoonmaker Lane, Woodstock, N. Y. ADV. PG. 410.
- ⓂSmall Motors, Inc., 2076 Elston Ave., Chicago 14, Ill.

FASTENERS & FASTENING DEVICES

- ⓂALDEN PRODUCTS CO., 117 N. Main St., Brockton-64, Mass. ADV. PG. 327.
- ⓂALLEN MFG. CO., Hartford, Conn. ADV. PG. 252.
- ⓂAllmetal Screw Products Co., Inc., 33 Greene St., New York 13, N. Y.
- ⓂAmerican Scientific Co., P. O. Box 11, High Bridge-Station, New York 52, N. Y.
- ⓂAmerican Screw Co., Willimantic, Conn.
- ⓂAnti-Corrosive Products Co., Castleton-on-Hudson, N. Y.
- ⓂBristol Co., The, Waterbury 20, Conn.
- ⓂCamloc Fastener Corp., 420 Lexington Ave., New York 17, N. Y.
- ⓂCentral Screw Co., 3501 Shields Ave., Chicago 9, Ill.
- ⓂCherry Rivet Co., A Div. of Townsend Co., 231 Winston St., Los Angeles 13, Calif.
- ⓂCINCH MFG. CORP., 1026 S. Homan Ave., Chicago 24, Ill. ADV. PG. 186, 187.
- ⓂContinental Screw Co., New Bedford, Mass.
- ⓂDimco-Gray Co., 207 E. Sixth St., Dayton, Ohio.
- ⓂDzus Fastener Co., Inc., Box 785, Babylon, N. Y.
- ⓂElastic Stop Nut Corp., of America, 2330 Vauxhall Rd., Union, N. J.

Ⓥ indicates . . . IN PRODUCTION • AVAILABILITY • UNRESTRICTED FOR GENERAL USE

- Ⓥ FEDERAL SCREW PRODUCTS, INC., 224 W. Huron St., Chicago 10, Ill. ADV. PG. 76.
- Ⓥ GENERAL ACCESSORIES CO., LTD., 366 Madison Ave., New York 17, N. Y. ADV. PG. 336.
- Ⓥ General Cement Mfg. Co., 919 Taylor Ave., Rockford, Ill.
- Ⓥ Greene Mfg. Corp., G. G., Warren, Pa.
- Ⓥ Gries Reproducer Corp., 100 Willow Ave., New York 54, N. Y.
- Ⓥ Hubbell Inc., Harvey, Bridgeport 2, Conn.
- Ⓥ National Screw & Mfg. Co., Cleveland 4, Ohio.
- Ⓥ Palnut Co., Inc., 77 Cordier St., Irvington 11, N. J.
- Ⓥ Penn Engineering & Mfg. Coru., Box 311, Doylestown, Pa.
- Ⓥ Pheoil Mfg. Co., 5700 Roosevelt Rd., Chicago 50, Ill.
- Ⓥ Scovill Mfg. Co., Industrial Fastener Div., Waterbury, Conn.
- Ⓥ SET SCREW MFG. CO., 470 Main St., Bartlett, Ill. ADV. PG. 406.
- Ⓥ Shakeproof Inc., Div. of Illinois Tool Works, 2501 N. Keeler Ave., Chicago 39, Ill.
- Ⓥ Simmons Fastener Corp., North Broadway, Albany 1, N. Y.
- Ⓥ Star Expansion Products Co., 147-149 Cedar St., New York 6, N. Y.
- Ⓥ Stimpson Co., Inc., Edwin B., 74 Franklin Ave., Brooklyn 5, N. Y.
- Ⓥ Stronghold Screw Products, Inc., 216-22 West Hubbard St., Chicago 10, Ill.
- Ⓥ Tinnerman Products, Inc., P. O. Box 6688, Dept. No. 16, Cleveland 1, Ohio.
- Ⓥ United-Carr Fastener Corp., Cambridge 42, Mass.
- Ⓥ United Screw & Bolt Corp., 2513 W. Cullerton St., Chicago 8, Ill.
- Ⓥ Waldes Kohinor Inc., 47-16 Austel Place, Long Island City 1, N. Y.

FELTS & FELT PARTS

- Ⓥ Auburn Mfg. Co., Pease Ave. & Stack St., Middletown, Conn.
- Ⓥ Felt Products Mfg. Co., 1504 W. Carroll Ave., Chicago 7, Ill.
- Ⓥ Felters Co., 210 South St., Boston, Mass.
- Ⓥ General Cement Mfg. Co., 919 Taylor Ave., Rockford, Ill.
- Western Felt Works, 4029 Ogden Ave., Chicago, Ill.

FERRITE CORES & SHIELDS

- Ⓥ CROWLEY & CO., INC., HENRY L., I Central Ave., West Orange, N. J. ADV. PG. 231.
- Ⓥ ERIE RESISTOR CORP., 644 W-12th St., Erie, Pa. ADV. PG. 91.
- Ⓥ Ferricore Inc., 15 School St., Yonkers 2, N. Y.
- Ⓥ Ferroxcube Corp. of America, 50 E. 41st St., New York, N. Y.
- Ⓥ GENERAL CERAMICS & STEATITE CORP., Keasbey, N. J. ADV. PG. 126, 127.
- Ⓥ NATIONAL MOLDITE CO., 1410 Chestnut Ave., Hillside 5, N. J. ADV. PG. 232.
- Ⓥ STACKPOLE CARBON CO., St. Marys, Pa. ADV. PG. 170, 171.
- Ⓥ Steward Mfg. Co., D. M., 3600 Jerome Ave., Chattanooga 1, Tenn.

FIBRE

See Insulation Materials

FILTERS—Antenna

- Ⓥ Aero Coil Inc., 507 26th St., Union City, N. J.
- Ⓥ AEROLITE ELECTRONIC HARDWARE CORP., 507 26th St., Union City, N. J. ADV. PG. 355.
- Ⓥ ASTRON CORP., 255 Grant Ave., East Newark, N. J. ADV. PG. 137.
- Ⓥ BARKER & WILLIAMSON, 235 Fairfield Ave., Upper Darby, Pa. ADV. PG. 292.
- Ⓥ BIRD ELECTRONIC CORP., 1800 E. 38th St., Cleveland 14, Ohio. ADV. PG. 331.
- Coil Winders, Inc., 61 Bergen St., Brooklyn 2, N. Y.
- Ⓥ Custom Craft Mfg. Co., 256 E. 98th St., Brooklyn, N. Y.
- Ⓥ Deuschman Corp., Tobe, 921 Providence Highway, Norwood, Mass.
- Ⓥ Filtron Co., Inc., 131-05 Fowler Ave., Flushing, N. Y.
- Ⓥ Gates Radio Co., Quincy, Ill.
- Ⓥ JOHNSON CO., E. F., Waseca, Minn. ADV. PG. 118, 121.
- Ⓥ KINGS MICROWAVE CO., INC., 50 Marbledale Rd., Tuckahoe 7, N. Y. ADV. PG. 178, 179.
- Ⓥ LA POINTE-PLASCOMOLD CORP., Windsor Locks, Conn. ADV. PG. 297.
- Ⓥ Lynmar Engineers, Inc., 1721 Delancey St., Philadelphia 3, Pa.
- Ⓥ McMurdo Silver Co., Inc., 473 Lafayette St., New York, N. Y.
- Ⓥ Miller Co., J. W., 5917 S. Main St., Los Angeles 3, Calif.
- Ⓥ Northeastern Engineering, Inc., Manchester, N. H.
- Ⓥ ORTHON CORP., 196 Albion Ave., Paterson 2, N. J. ADV. PG. 156.
- Selectar Industries, Inc., 401 E. 138 St., New York 54, N. Y.

- Ⓥ Sierra Electronics Corp., San Carlos, Calif.
- Ⓥ U. S. ELECTRONICS CORP., 276 Warren St., Lyndhurst, N. J. ADV. PG. 76.

FILTERS—Band Elimination

- Ⓥ ACME ELECTRONICS, INC., 300 N. Lake Ave., Pasadena 4, Calif. ADV. PG. 182.
- Acro Products Co., 215 Arch St., Philadelphia 6, Pa.
- Ⓥ Acro Transformer Mfg. Corp., 26-02 4th St., Astoria 2, N. Y.
- Ⓥ Aero Coil Inc., 507 26th St., Union City, N. J.
- Ⓥ AEROLITE ELECTRONIC HARDWARE CORP., 507 26th St., Union City, N. J. ADV. PG. 355.
- Ⓥ Altec Lansing Corp., 9356 Santa Monica Blvd., Beverly Hills, Calif.
- Ⓥ ASTRON CORP., 255 Grant Ave., East Newark, N. J. ADV. PG. 137.
- Ⓥ Audio Development Co., 2833 13th Ave., S. Minneapolis 7, Minn.
- Ⓥ BARKER & WILLIAMSON, 235 Fairfield Ave., Upper Darby, Pa. ADV. PG. 292.
- Ⓥ Berkeley Custom Electronics, 2571 Shattuck Ave., Berkeley, Calif.
- Ⓥ BURNELL & CO., 45 Warburton Ave., Yonkers 2, N. Y. ADV. PG. 75.
- Ⓥ CINEMA ENGINEERING CO., 1510 W. Verdugo Ave., Burbank, Calif., ADV. PG. 204.
- Coil Winders, Inc., 61 Bergen St., Brooklyn 2, N. Y.
- Ⓥ COMMUNICATION ACCESSORIES CO., Box 345, 110th St. & Hillcrest Rd., Hickman Hills, Missouri. ADV. PG. 168.
- Ⓥ Custom Craft Mfg. Co., 256 E. 98th St., Brooklyn, N. Y.
- Ⓥ DeCOURSEY ENGINEERING LAB., P. O. Box 235, Los Angeles 25, Calif. ADV. PG. 174.
- Ⓥ Deuschmann Corp., Tobe, 921 Providence Highway, Norwood, Mass.
- Ⓥ DIETZ DESIGN & MFG. CO., Grandview 6, Mo. ADV. PG. 323.
- Electran Mfg. Co., 1901 N. Clybourn, Chicago, Ill.
- Electronic Products Div., Epco Products, Inc., 2430 Atlantic Ave., Brooklyn 33, N. Y.
- Ⓥ ELECTRONIC TRANSFORMER CO., INC., 215 W. 25th St., New York, N. Y. ADV. PG. 278.
- Ⓥ Fairchild Recording Equipment Co., 154th St. & Seventh Ave., Whitestone, N. Y.
- Ⓥ FERRANTI ELECTRIC, INC., 30 Rockefeller Plaza, New York 20, N. Y. ADV. PG. 159.
- Ⓥ Filtron Co., Inc., 131-05 Fowler Ave., Flushing, N. Y.
- Ⓥ FREED TRANSFORMER CO., INC., 1736 Weirfield St., Brooklyn 27, N. Y. ADV. PG. 149.
- Ⓥ GENERAL RADIO CO., 275 Massachusetts Ave., Cambridge 39, Mass. ADV. PG. 48, 49.
- Ⓥ HIGHLAND ENGINEERING CO., Main St., & Urban Ave., Westbury, N. Y. ADV. PG. 360.
- Ⓥ Hycor Co., Inc., 11423 Vanown St., North Hollywood, Calif.
- Ⓥ Kalbfed Labs., Inc., 1076 Morena Blvd., San Diego 10, Calif.
- Ⓥ KELLOGG SWITCHBOARD & SUPPLY CO., 6650 S. Cicero Ave., Chicago 38, Ill. ADV. PG. 294.
- Ⓥ KENYON TRANSFORMER CO., INC., 840 Barry St., New York 59, N. Y. ADV. PG. 325.
- Ⓥ KROHN-HITE INSTRUMENT CO., 580 Massachusetts Ave., Cambridge 39, Mass. ADV. PG. 43.
- Ⓥ LENKURT ELECTRIC CO., INC., San Carlos, Calif. ADV. PG. 412.
- Ⓥ Lear, Inc., 110 Ionia Ave., N. W., Grand Rapids 2, Mich.
- Ⓥ Lynch Co., F. W., 96 Jessie St., San Francisco, Calif.
- Ⓥ McMurdo Silver Co., Inc., 473 Lafayette St., New York, N. Y.
- Ⓥ Macdonald Co., Inc., W. S., 33 University Rd., Cambridge 38, Mass.
- Ⓥ MEASUREMENTS CORP., Boonton, N. J. ADV. PG. 99.
- Ⓥ Miller Co., J. W., 5917 S. Main St., Los Angeles 3, Calif.
- Ⓥ ORTHON CORP., 196 Albion Ave., Paterson 2, N. J. ADV. PG. 156.
- Ⓥ Railway Communications, Inc., P. O. Box 1783, Lincoln, Nebr.
- Ⓥ Sierra Electronic Corp., San Carlos, Calif.
- Ⓥ Southwestern Industrial Electronics Co., 2831 Post Oak Rd., P. O. Box 13058, Houston 19, Texas.
- Ⓥ STANDARD TRANSFORMER CORP., Elston, Kedzie & Addison, Chicago 18, Ill. ADV. PG. 144.
- Ⓥ Telechrome, Inc., 88 Merrick Rd., Amityville, N. Y.
- Ⓥ Thordarson-Meissner Mfg. Divs., 500 W. Huron St., Chicago 10, Ill.
- Ⓥ Transformer Engineers, 389 South Arroyo Parkway, Pasadena, Calif.
- Ⓥ U. S. ELECTRONICS CORP., 276 Warren St., Lyndhurst, N. J. ADV. PG. 76.
- Ⓥ UNITED TRANSFORMER CO., 150 Varick St., New York 13, N. Y. ADV. PG. Insert Front Cover.
- Ⓥ Waveforms, Inc., 333 Sixth Ave., New York 14, N. Y.

FILTERS—Band Pass

- Ⓥ ACME ELECTRONICS, INC., 300 N. Lake Ave., Pasadena 4, Calif. ADV. PG. 182.
- Acro Products Co., 215 Arch St., Philadelphia 6, Pa.
- Ⓥ Acro Transformer Mfg. Corp., 26-02 4th St., Astoria 2, N. Y.

- Ⓥ Aero Coil Inc., 507 26th St., Union City, N. J.
- Ⓥ AEROLITE ELECTRONIC HARDWARE CORP., 507 26th St., Union City, N. J. ADV. PG. 355.
- Ⓥ Altec Lansing Corp., 9356 Santa Monica Blvd., Beverly Hills, Calif.
- Ⓥ Audio Development Co., 2833 13th Ave., S. Minneapolis 7, Minn.
- Ⓥ Avion Instrument Corp., Paramus, N. J.
- Ⓥ Baird Associates, 33 University Rd., Cambridge 35, Mass.
- Ⓥ BARKER & WILLIAMSON, 235 Fairfield Ave., Upper Darby, Pa. ADV. PG. 292.
- Ⓥ Bassett, Inc., Rex, 307-11 N. W., First Ave., Fort Lauderdale, Fla.
- Ⓥ Bendix Aviation Corp., Pacific Division, 11600 Sherman Way, North Hollywood, Calif.
- Ⓥ Berkeley Custom Electronics, 2571 Shattuck Ave., Berkeley, Calif.
- Ⓥ BURNELL & CO., 45 Warburton Ave., Yonkers 2, N. Y. ADV. PG. 75.
- Ⓥ CHICAGO TRANSFORMER DIV., ESSEX WIRE CORP., 3501 W. Addison St., Chicago 18, Ill. ADV. PG. 205.
- Ⓥ CINEMA ENGINEERING CO., 1510 W. Verdugo Ave., Burbank, Calif. ADV. PG. 204.
- Coil Winders, Inc., 61 Bergen St., Brooklyn 2, N. Y.
- Ⓥ COMMUNICATION ACCESSORIES CO., Box 345, 110th St. & Hillcrest Rd., Hickman Hills, Missouri. ADV. PG. 168.
- Ⓥ Custom Craft Mfg. Co., 256 E. 98th St., Brooklyn, N. Y.
- Ⓥ DX Radio Products Co., Inc., 2304 Armitage Ave., Chicago 47, Ill.
- Ⓥ DeCOURSEY ENGINEERING LAB., P. O. Box 235, Los Angeles 25, Calif. ADV. PG. 174.
- Ⓥ Deuschmann Corp., Tobe, 921 Providence Highway, Norwood, Mass.
- Ⓥ DIETZ DESIGN & MFG. CO., Grandview 6, Mo. ADV. PG. 323.
- Electran Mfg. Co., 1901 N. Clybourn, Chicago, Ill.
- Ⓥ Electro Engineering & Mfg. Corp., 617 W. Alexandrine Ave., Detroit 1, Mich.
- Electronic Products Div., Epco Products, Inc., 2430 Atlantic Ave., Brooklyn 33, N. Y.
- Ⓥ ELECTRONIC TRANSFORMER CO., INC., 215 W. 25th St., New York, N. Y. ADV. PG. 278.
- Ⓥ Fairchild Recording Equipment Co., 154th St. & Seventh Ave., Whitestone, N. Y.
- Ⓥ FERRANTI ELECTRIC, INC., 30 Rockefeller Plaza, New York 20, N. Y. ADV. PG. 159.
- Ⓥ Filtron Co., Inc., 131-05 Fowler Ave., Flushing, N. Y.
- Ⓥ FREED TRANSFORMER CO., INC., 1736 Weirfield St., Brooklyn 27, N. Y. ADV. PG. 149.
- Ⓥ GENERAL RADIO CO., 275 Massachusetts Ave., Cambridge 39, Mass. ADV. PG. 48, 49.
- Ⓥ Gertsch Products, Inc., 11846 Mississippi Ave., Los Angeles 25, Calif.
- Ⓥ HIGHLAND ENGINEERING CO., Main St. & Urban Ave., Westbury, N. Y. ADV. PG. 360.
- Ⓥ Hycor Co., Inc., 11423 Vanown St., North Hollywood, Calif.
- Ⓥ KELLOGG SWITCHBOARD & SUPPLY CO., 6650 S. Cicero Ave., Chicago 38, Ill. ADV. PG. 294.
- Ⓥ KENYON TRANSFORMER CO., INC., 840 Barry St., New York 59, N. Y. ADV. PG. 325.
- Ⓥ KROHN-HITE INSTRUMENT CO., 580 Massachusetts Ave., Cambridge 39, Mass. ADV. PG. 43.
- Ⓥ Lear, Inc., 110 Ionia Ave., N. W., Grand Rapids 2, Mich.
- Ⓥ LENKURT ELECTRIC CO., INC., San Carlos, Calif. ADV. PG. 412.
- Ⓥ Loral Electronics Corp., 794 E. 140th St., New York 54, N. Y.
- Ⓥ Lynch Co., F. W., 96 Jessie St., San Francisco, Calif.
- Ⓥ McMurdo Silver Co., Inc., 473 Lafayette St., New York, N. Y.
- Ⓥ MEASUREMENTS CORP., Boonton, N. J. ADV. PG. 99.
- Ⓥ Millen Mfg. Co., James, 150 Exchange St., Malden, Mass.
- Ⓥ Miller Co., J. W., 5917 S. Main St., Los Angeles 3, Calif.
- Ⓥ Motorola, Inc., 4545 Augusta Blvd., Chicago 51, Ill.
- Ⓥ NORTHERN RADIO CO., INC., 143-145 W. 22nd St., New York 11, N. Y. ADV. PG. 262, 263.
- Ⓥ ORTHON CORP., 196 Albion Ave., Paterson 2, N. J. ADV. PG. 156.
- Ⓥ PARMEKO LTD., 366 Madison Ave., New York 17, N. Y. ADV. PG. 336.
- Ⓥ PRODUCT DEVELOPMENT CO., INC., Arlington, N. J. ADV. PG. 362.
- Ⓥ RAHM INSTRUMENTS, INC., 12 W. Broadway, New York 7, N. Y. ADV. PG. 354.
- Ⓥ Railway Communications, Inc., P. O. Box 1783, Lincoln, Nebr.
- Ⓥ Rollin Co., 2070 N. Fair Oaks Ave., Pasadena 3, Calif.
- Ⓥ Southwestern Industrial Electronics Co., 2831 Post Oak Rd., P. O. Box 13058, Houston 19, Texas.
- Ⓥ Standard Telephones & Cables Ltd., Connaught House, Adwyck, London, W. C. 2, England.
- Ⓥ STANDARD TRANSFORMER CORP., Elston, Kedzie & Addison, Chicago 18, Ill. ADV. PG. 144.
- Ⓥ TECHNICAL APPLIANCE CORP., Sherburne, N. Y. ADV. PG. 378.
- Ⓥ Telechrome, Inc., 88 Merrick Rd., Amityville, N. Y.
- Ⓥ Thordarson-Meissner Mfg. Divs., 500 W. Huron St., Chicago 10, Ill.
- Ⓥ Transformer Engineers, 389 South Arroyo Parkway, Pasadena, Calif.

(V) indicates . . . **IN PRODUCTION • AVAILABILITY • UNRESTRICTED FOR GENERAL USE**

- Ⓞ U. S. ELECTRONICS CORP., 276 Warren St., Lyndhurst, N. J. ADV. PG. 76.
- Ⓞ UNITED TRANSFORMER CO., 150 Varick St., New York 13, N. Y. ADV. PG. Inside Front Cover.
- Ⓞ UNIVERSITY LOUDSPEAKERS, INC., 80 S. Kensico Ave., White Plains, N. Y. ADV. PG. 38.
- Ⓞ Waveforms, Inc., 333 Sixth Ave., New York 14, N. Y.
- Ⓞ Western-Electro-Acoustic Labs., 204 S. Beverly Drive, Beverly Hills, Calif.

FILTERS—Crystal

- Ⓞ BARKER & WILLIAMSON, 235 Fairfield Ave., Upper Darby, Pa. ADV. PG. 292.
- Ⓞ Bassett, Inc., Rm. 307-11 N. W., First Ave., Fort Lauderdale, Fla.
- Ⓞ BILEY ELECTRIC CO., Union Station Bldg., Erie, Pa. ADV. PG. 311, 407.
- Ⓞ BURNELL & CO., 45 Warburton Ave., Yonkers 2, N. Y. ADV. PG. 75.
- Ⓞ CLARK CRYSTAL CO., 2 Farm Rd., Marlboro, Mass. ADV. PG. 366.
- Ⓞ Coil Winders, Inc., 61 Bergen St., Brooklyn 2, N. Y.
- Ⓞ FREED TRANSFORMER CO., INC., 1736 Weirfield St., Brooklyn 27, N. Y. ADV. PG. 149.
- Ⓞ KINGS MICROWAVE CO., INC., 50 Marbledale Rd., Tuckahoe 7, N. Y. ADV. PG. 178, 179.
- Ⓞ MARCONI INSTRUMENTS, LTD., 23 Beaver St., New York 4, N. Y. ADV. PG. 270.
- Ⓞ Melpar, Inc., 552 Swann Ave., Alexandria, Va.
- Ⓞ Monitor Products Co., 815 Fremont Ave., South Pasadena, Calif.
- Ⓞ Polytech Devices, Inc., 1180 E. Grand Ave., Elizabeth, N. J.
- Ⓞ STANDARD CRYSTAL CO., 400 Armstrong Ave., Kansas City 1, Kans. ADV. PG. 156.
- Ⓞ Valpey Crystals, Highland St., Holliston, Mass.
- Ⓞ Westline Electronics Co., 11656 Olympic Blvd., Los Angeles 25, Calif.

FILTERS—Electric Wave Section

- Ⓞ ACME ELECTRONICS, INC., 300 N. Lake Ave., Pasadena 4, Calif. ADV. PG. 182.
- Ⓞ Acro Transformer Mfg. Corp., 26-02 4th St., Astoria 2, N. Y.
- Ⓞ BARKER & WILLIAMSON, 235 Fairfield Ave., Upper Darby, Pa. ADV. PG. 292.
- Ⓞ BURNELL & CO., 45 Warburton Ave., Yonkers 2, N. Y. ADV. PG. 75.
- Ⓞ Coil Winders, Inc., 61 Bergen St., Brooklyn 2, N. Y.
- Ⓞ COMMUNICATION ACCESSORIES CO., Box 345, 110th St. & Hillcrest Rd., Hickman Hills, Missouri. ADV. PG. 168.
- Ⓞ Deutschmann Corp., Tobe, 921 Providence Highway, Norwood, Mass.
- Ⓞ DIETZ DESIGN & MFG. CO., Grandview 6, Mo. ADV. PG. 323.
- Ⓞ ELECTRONIC TRANSFORMER CO., INC., 215 W. 25th St., New York, N. Y. ADV. PG. 278.
- Ⓞ FERRANTI ELECTRIC, INC., 30 Rockefeller Plaza, New York 20, N. Y. ADV. PG. 159.
- Ⓞ FREED TRANSFORMER CO., INC., 1736 Weirfield St., Brooklyn 27, N. Y. ADV. PG. 149.
- Ⓞ GENERAL RADIO CO., 275 Massachusetts Ave., Cambridge 39, Mass. ADV. PG. 48, 49.
- Ⓞ Hycoor Co., Inc., 11423 Vanowen St., North Hollywood, Calif.
- Ⓞ KENYON TRANSFORMER CO., INC., 840 Barry St., New York 59, N. Y. ADV. PG. 325.
- Ⓞ Lear, Inc., 110 Ionia Ave., N. W., Grand Rapids 2, Mich.
- Ⓞ LENKURT ELECTRIC CO., INC., San Carlos, Calif. ADV. PG. 412.
- Ⓞ Lynch Co., F. W., 96 Jessie St., San Francisco, Calif.
- Ⓞ Miller Co., J. W., 5917 S. Main St., Los Angeles 3, Calif.
- Ⓞ Railway Communications, Inc., P. O. Box 1783, Lincoln, Nebr.
- Ⓞ STANDARD TRANSFORMER CORP., Elston, Kedzie & Addison, Chicago 18, Ill. ADV. PG. 144.
- Ⓞ Thordarson Meissner Mfg. Divs., 500 W. Huron St., Chicago 10, Ill.
- Ⓞ U. S. ELECTRONICS CORP., 276 Warren St., Lyndhurst, N. J. ADV. PG. 76.
- Ⓞ UNITED TRANSFORMER CO., 150 Varick St., New York 13, N. Y. ADV. PG. Inside Front Cover.
- Ⓞ Waveforms, Inc., 333 Sixth Ave., New York 14, N. Y.

FILTERS—Equalizer

- Acro Products Co., 215 Arch St., Philadelphia 6, Pa.
- Ⓞ Acro Transformer Mfg. Corp., 26-02 4th St., Astoria 2, N. Y.
- Ⓞ Altec Lansing Corp., 9356 Santa Monica Blvd., Beverly Hills, Calif.
- Ⓞ Arlington Electric Products, Inc., 500 W. 52nd St., New York 19, N. Y.
- Ⓞ Astatic Corp., The, Conneaut, Ohio.
- Ⓞ Audio Equipment Sales, 153 W. 33rd St., New York 1, N. Y.
- Ⓞ BARKER & WILLIAMSON, 235 Fairfield Ave., Upper Darby, Pa. ADV. PG. 292.
- Ⓞ Berkeley Custom Electronics, 2571 Shattuck Ave., Berkeley, Calif.
- Ⓞ BURNELL & CO., 45 Warburton Ave., Yonkers 2, N. Y. ADV. PG. 75.

- Ⓞ CINEMA ENGINEERING CO., 1510 W. Verdugo Ave., Burbank, Calif. ADV. PG. 204.
- Ⓞ Coil Winders, Inc., 61 Bergen St., Brooklyn 2, N. Y.
- Ⓞ COMMUNICATION ACCESSORIES CO., Box 345, 110th St. & Hillcrest Rd., Hickman Hills, Missouri. ADV. PG. 168.
- Ⓞ DECOURSEY ENGINEERING LAB., P. O. Box 235, Los Angeles 25, Calif. ADV. PG. 174.
- Ⓞ Deutschmann Corp., Tobe, 921 Providence Highway, Norwood, Mass.
- Ⓞ Electronic Products Div., Epco Products, Inc., 2430 Atlantic Ave., Brooklyn 33, N. Y.
- Ⓞ ELECTRONIC TRANSFORMER CO., INC., 215 W. 25th St., New York, N. Y. ADV. PG. 278.
- Ⓞ Fairchild Recording Equipment Corp., 154th St. & 7th Ave., Whitestone, N. Y.
- Ⓞ GRAY RESEARCH & DEVELOPMENT CO., INC., 16 Arbor St., Hartford 1, Conn. ADV. PG. 363.
- Ⓞ FERRANTI ELECTRIC, INC., 30 Rockefeller Plaza, New York 20, N. Y. ADV. PG. 159.
- Ⓞ FREED TRANSFORMER CO., INC., 1736 Weirfield St., Brooklyn 27, N. Y. ADV. PG. 149.
- Ⓞ Hycoor Co., Inc., 11423 Vanowen St., North Hollywood, Calif.
- Ⓞ Newcomb Audio Products Co., 6824 Lexington Ave., Hollywood 38, Calif.
- Ⓞ PAINTON & CO., INC., LTD., 366 Madison Ave., New York 17, N. Y. ADV. PG. 336.
- Ⓞ PICKERING & CO., 309 Woods Ave., Oceanside, N. Y. ADV. PG. 284.
- Ⓞ RADIO CORP. OF AMERICA, RCA Victor Div., General Offices, Camden, N. J. ADV. PG. 177 and Inside Back and Back Covers.
- Ⓞ Railway Communications, Inc., P. O. Box 1783, Lincoln, Nebr.
- Ⓞ STANDARD TRANSFORMER CORP., Elston, Kedzie & Addison, Chicago 18, Ill. ADV. PG. 144.
- Ⓞ Technical Materiel Corp., P. O. Box 142, 121 Spencer Place, Mamaroneck, N. Y.
- Ⓞ Telechrome, Inc., 88 Merrick Rd., Amityville, N. Y.
- Ⓞ Thordarson-Meissner Mfg. Divs., 500 W. Huron St., Chicago 10, Ill.
- Ⓞ Transformer Engineers, 389 South Arroyo Parkway, Pasadena, Calif.
- Ⓞ UNITED TRANSFORMER CO., 150 Varick St., New York 13, N. Y. ADV. PG. Inside Front Cover.
- Ⓞ Waveforms, Inc., 333 Sixth Ave., New York 14, N. Y.

FILTERS—Lighting (for radio towers)

- Ⓞ BARKER & WILLIAMSON, 235 Fairfield Ave., Upper Darby, Pa. ADV. PG. 292.
- Ⓞ Deutschmann Corp., Tobe, 921 Providence Highway, Norwood, Mass.
- Ⓞ Gates Radio Co., Quincy, Ill.
- Ⓞ JOHNSON CO., E. F., Waseca, Minn., Ill. ADV. PG. 118, 121.
- Ⓞ Kopp Glass, Inc., 1 E. 42nd St., New York 17, N. Y.
- Ⓞ Miller Co., J. W., 5917 S. Main St., Los Angeles 3, Calif.
- Ⓞ RADIO CORP. OF AMERICA, RCA Victor Div., General Offices, Camden, N. J. ADV. PG. 177, Inside Back & Back Covers.
- Ⓞ Thordarson-Meissner Mfg. Divs., 500 W. Huron St., Chicago 10, Ill.
- Ⓞ U. S. ELECTRONICS CORP., 276 Warren St., Lyndhurst, N. J. ADV. PG. 76.
- Ⓞ UNITED TRANSFORMER CO., 150 Varick St., New York 13, N. Y. ADV. PG. Inside Front Cover.

FILTERS—Microwave

- Ⓞ BIRD ELECTRONIC CORP., 1800 E. 38th St., Cleveland 14, Ohio. ADV. PG. 331.
- Ⓞ Bunnell & Co., J. H., 81 Prospect St., Brooklyn, N. Y.
- Ⓞ Deutschmann Corp., Tobe, 921 Providence Highway, Norwood, Mass.
- Ⓞ Electro Precision Products Inc., 119-01 22nd Ave., College Point, N. Y.
- Ⓞ HEWLETT-PACKARD CO., 395 Page Mill Rd., Palo Alto, Calif. ADV. PG. 33-36.
- Ⓞ KINGS MICROWAVE CO., INC., 50 Marbledale Rd., Tuckahoe 7, N. Y. ADV. PG. 178, 179.
- Ⓞ Microwave Equipment Co., Inc., North Caldwell, N. J.
- Ⓞ POLARAD ELECTRONICS CORP., 100 Metropolitan Ave., Brooklyn 11, N. Y. ADV. PG. 184, 185.
- Ⓞ POLYTECHNIC RESEARCH & DEVELOPMENT CO., INC., 202 Tillary St., Brooklyn 1, N. Y. ADV. PG. 172, 173.
- Ⓞ Potter Co., 1850 Sheridan Rd., North Chicago, Ill.
- Ⓞ PRODUCT DEVELOPMENT CO., INC., Arlington, N. J. ADV. PG. 362.
- Ⓞ Selector Industries, Inc., 401 E. 138th St., New York 54, N. Y.
- Ⓞ SPERRY GYROSCOPE CO., Div. of The Sperry Corp., Great Neck, N. Y. ADV. PG. 103, 104.
- Ⓞ Weymouth Instrument Co., 1440 Commercial St., East Weymouth 89, Mass.
- Ⓞ Wheeler Laboratories, Inc., Great Neck, N. Y.

FILTERS—Needle Scratch

- Ⓞ BARKER & WILLIAMSON, 235 Fairfield Ave., Upper Darby, Pa. ADV. PG. 292.
- Ⓞ Berkeley Custom Electronics, 2571 Shattuck Ave., Berkeley, Calif.

- Ⓞ Coil Winders, Inc., 61 Bergen St., Brooklyn 2, N. Y.
- Ⓞ COMMUNICATION ACCESSORIES CO., Box 345, 110th St. & Hillcrest Rd., Hickman Hills, Missouri. ADV. PG. 168.
- Ⓞ Deutschmann Corp., Tobe, 921 Providence Highway, Norwood, Mass.
- Ⓞ Fairchild Recording Equipment Corp., 154 St. & 7th Avenue, Whitestone, N. Y.
- Ⓞ Gates Radio Co., Quincy, Ill.
- Ⓞ Hartley Co., Ltd., H. A., 152 Hammersmith Rd., London W. C. 6, England.
- Ⓞ Lear, Inc., 110 Ionia Ave., N. W., Grand Rapids 2, Mich.
- Ⓞ Miller Co., J. W., 5917 S. Main St., Los Angeles 3, Calif.
- Ⓞ ORTHON CORP., 196 Albion Ave., Paterson 2, N. J. ADV. PG. 156.
- Ⓞ PICKERING & CO., 309 Woods Ave., Oceanside, N. Y. ADV. PG. 284.
- Ⓞ Scott, Inc., Herman Hosmer, 385 Putnam Ave., Cambridge 39, Mass.
- Ⓞ U. S. ELECTRONICS CORP., 276 Warren St., Lyndhurst, N. J. ADV. PG. 76.
- Ⓞ UNITED TRANSFORMER CO., 150 Varick St., New York 13, N. Y. ADV. PG. Inside Front Cover.
- Ⓞ Waveforms, Inc., 333 Sixth Ave., New York 14, N. Y.

FILTERS—Radio Interference

- Ⓞ Aero Coil Inc., 507 26th St., Union City, N. J.
- Ⓞ Aeronautical Electronics, Inc., Raleigh-Durham Airport, P. O. Box 6043, Raleigh, N. C.
- Ⓞ Aerovox Corp., 740 Belleville Ave., New Bedford, Mass.
- Ⓞ ASTRON CORP., 255 Grant Ave., East Newark, N. J. ADV. PG. 137.
- Ⓞ BARKER & WILLIAMSON, 235 Fairfield Ave., Upper Darby, Pa. ADV. PG. 292.
- Ⓞ BELLING & LEE LTD., 366 Madison Ave., New York 17, N. Y. ADV. PG. 336.
- Ⓞ Coil Winders, Inc., 61 Bergen St., Brooklyn 2, N. Y.
- Ⓞ COMMUNICATION ACCESSORIES CO., Box 345, 110th St. & Hillcrest Rd., Hickman Hills, Mo. ADV. PG. 168.
- Ⓞ CORNELL-DUBILIER ELECTRIC CORP., South Plainfield, N. J. ADV. PG. 146.
- Ⓞ Deutschmann Corp., Tobe, 921 Providence Highway, Norwood, Mass.
- Ⓞ DUMONT ELECTRIC CO., 308 Dyckman St., New York, N. Y. ADV. PG. 375.
- Ⓞ Filtron Co., Inc., 131-05 Fowler Ave., Flushing, N. Y.
- Ⓞ Hallett Mfg. Co., 1601 Florence Ave., Inglewood, Calif.
- Ⓞ Insuline Corp. of America, 36-02 35th Ave., Long Island City, N. Y.
- Ⓞ J. F. D. MFG. CO., 6101-23 Sixteenth Ave., Brooklyn 57, N. Y. ADV. PG. 407.
- Ⓞ Lear, Inc., 110 Ionia Ave., N. W., Grand Rapids 2, Mich.
- Ⓞ Miller Co., J. W., 5917 S. Main St., Los Angeles 3, Calif.
- Ⓞ MITCHELL INDUSTRIES, INC., Camp Wolters, Mineral Wells, Texas. ADV. PG. 298.
- Ⓞ Motorola, Inc., 4545 Augusta Blvd., Chicago 51, Ill.
- Ⓞ National Electronic Mfg. Corp., 4202 Vernon Blvd., Long Island City, N. Y.
- Ⓞ Network Mfg. Corp., Bayonne, N. J.
- Ⓞ ORTHON CORP., 196 Albion Ave., Paterson 2, N. J. ADV. PG. 156.
- Ⓞ Potter Co., 1850 Sheridan Rd., North Chicago, Ill.
- Ⓞ Pyramid Electric Co., 1445 Hudson Blvd., North Bergen, N. J.
- Ⓞ Radiomarine Corp., of America, 75 Varick St., New York 13, N. Y.
- Ⓞ Scintilla Magneto Div., Bendix Aviation Corp., Sidney, N. Y.
- Ⓞ Sprague Electric Co., North Adams, Mass.
- Ⓞ Thordarson-Meissner Mfg. Divs., 500 W. Huron St., Chicago 10, Ill.
- Ⓞ U. S. ELECTRONICS CORP., 276 Warren St., Lyndhurst, N. J. ADV. PG. 76.

FILTERS—Television

- Ⓞ AEROVOX CORP., 740 Belleville Ave., New Bedford, Mass. ADV. PG. 352.
- Ⓞ ASTRON CORP., 255 Grant Ave., East Newark, N. J. ADV. PG. 137.
- Ⓞ BARKER & WILLIAMSON, 235 Fairfield Ave., Upper Darby, Pa. ADV. PG. 292.
- Ⓞ Brach Mfg. Corp., 200 Central Ave., Newark 4, N. J.
- Ⓞ Coil Winders, Inc., 61 Bergen St., Brooklyn 2, N. Y.
- Ⓞ Collins Radio Co., Cedar Rapids, Iowa.
- Ⓞ Deutschmann Corp., Tobe, 921 Providence Highway, Norwood, Mass.
- Ⓞ Electrovox Co., Inc., 60 Franklin St., East Orange, N. J.
- Ⓞ Filtron Co., Inc., 131-05 Fowler Ave., Flushing, N. Y.
- Ⓞ J. F. D. MFG. CO., 6101-23 Sixteenth Ave., Brooklyn, N. Y. ADV. PG. 407.
- Ⓞ Miller Co., J. W., 5917 S. Main St., Los Angeles 3, Calif.
- Ⓞ Monarch Radio & Television Corp., 2430 Atlantic Ave., Brooklyn 33, N. Y.
- Ⓞ Monroe Coil Co., 2839 N. Narragansett Ave., Chicago 34, Ill.

Ⓢ indicates . . . IN PRODUCTION • AVAILABILITY • UNRESTRICTED FOR GENERAL USE

- Ⓢ ORTHON CORP., 196 Albion Ave., Paterson 2, N. J. ADV. PG. 156.
- Ⓢ Pioneer Scientific Corp., 295 Lafayette St., New York 12, N. Y.
- Ⓢ Precision Electronics Inc., 643 Milwaukee Ave., Chicago 22, Ill.
- Ⓢ Pyramid Electric Co., 1445 Hudson Blvd., North Bergen, N. J.
- Ⓢ Radio Merchandise Sales, Inc., 1165 Southern Blvd., New York 59, N. Y.
- Ⓢ Selector Industries, Inc., 401 E. 138th St., New York 54, N. Y.
- Ⓢ SPENCER-KENNEDY LABS., INC., 186 Massachusetts Ave., Cambridge 39, Mass. ADV. PG. 166.
- Ⓢ Techchrome, Inc., 88 Merrick Rd., Amityville, N. Y.
- Ⓢ Thorardson-Meissner Mfg. Divs., 500 W. Huron St., Chicago 10, Ill.
- Ⓢ Transmira Products Corp., 1650 Broadway, New York 19, N. Y.
- Ⓢ U. S. ELECTRONICS CORP., 276 Warren St., Lyndhurst, N. J. ADV. PG. 76.

FILTERS—uhf & vhf

- Ⓢ Aero Coll Inc., 507 26th St., Union City, N. J.
- Ⓢ ASTRON CORP., 255 Grant Ave., East Newark, N. J. ADV. PG. 137.
- Ⓢ BIRD ELECTRONIC CORP., 1800 E. 38th St., Cleveland 14, Ohio. ADV. PG. 331.
- Ⓢ Bunnell & Co., J. H., 81 Prospect St., Brooklyn, N. Y. Coil Winders, Inc., 61 Bergen St., Brooklyn 2, N. Y.
- Ⓢ Deutschwann Corp., Tobe, 921 Providence Highway, Norwood, Mass.
- Ⓢ Electro Precision Products Inc., 119-01 22nd Ave., College Point, N. Y.
- Ⓢ Filtron Co., Inc., 131-05 Fowler Ave., Flushing, N. Y.
- Ⓢ HARTNETT ELECTRIC CORP., 138 Haven Ave., Port Washington, L. I., N. Y. ADV. PG. 399.
- Ⓢ HEWLETT-PACKARD CO., 395 Page Mill Rd., Palo Alto, Calif. ADV. PG. 33-36.
- Ⓢ KINGS MICROWAVE CO., INC., 50 Marbledale Rd., Tuckaohoe 7, N. Y. ADV. PG. 178, 179.
- Ⓢ Lear, Inc., 110 Ionia Ave., N. W., Grand Rapids 2, Mich.
- Ⓢ Loral Electronics Corp., 794 E. 140th St., New York 54, N. Y.
- Ⓢ Microlab, 301 S. Ridgewood Rd., South Orange, N. J.
- Ⓢ Millen Mfg. Co., James, 150 Exchange St., Malden, Mass.
- Ⓢ Miller Co., J. W., 5917 S. Main St., Los Angeles 3, Calif.
- Ⓢ ORTHON CORP., 196 Albion Ave., Paterson 2, N. J. ADV. PG. 156.
- Ⓢ Potter Co., 1850 Sheridan Rd., North Chicago, Ill.
- Ⓢ Racon Electric Co., 52 E. 19th St., New York 3, N. Y.
- Ⓢ Rollin Co., 2070 N. Fair Oaks Ave., Pasadena 3, Calif.
- Ⓢ Selector Industries, Inc., 401 E. 138th St., New York 54, N. Y.
- Ⓢ SPERRY GYROSCOPE CO., Div. of The Sperry Corp., Great Neck, N. Y. ADV. PG. 103, 104.
- Ⓢ U. S. ELECTRONICS CORP., 276 Warren St., Lyndhurst, N. J. ADV. PG. 76.

FILTERS—Variable Electronic

- Ⓢ Arlington Electric Products, Inc., 500 W. 52nd St., New York 19, N. Y.
- Ⓢ C. G. S. LABORATORIES, INC., 391 Ludlow St., Stamford, Conn. ADV. PG. 389.
- Ⓢ Fairchild Recording Equipment Co., 154th St. & Seventh Ave., Whitestone, N. Y.
- Ⓢ FREED TRANSFORMER CO., INC., 1736 Weirfield St., Brooklyn 27, N. Y. ADV. PG. 149.
- Ⓢ KROHN-HITE INSTRUMENT CO., 580 Massachusetts Ave., Cambridge 39, Mass. ADV. PG. 43.
- Ⓢ Miller Co., J. W., 5917 S. Main St., Los Angeles 3, Calif.
- Ⓢ PICKERING & CO., 309 Woods Ave., Oceanside, N. Y. ADV. PG. 284.
- Ⓢ RAHM INSTRUMENTS, INC., 12 W. Broadway, New York 7, N. Y. ADV. PG. 354.
- Ⓢ SPENCER-KENNEDY LABS., INC., 186 Massachusetts Ave., Cambridge 39, Mass. ADV. PG. 166.
- Ⓢ Thorardson-Meissner Mfg. Divs., 500 W. Huron St., Chicago 10, Ill.
- Ⓢ Waveforms, Inc., 333 Sixth Ave., New York 14, N. Y.

FINISHES—Crystal

- Ⓢ Bassett, Inc., Rex, 307-11 N. W. First Ave., Fort Lauderdale, Fla.
- Ⓢ Dallons Labs., 5066 Santa Monica Blvd., Los Angeles, Calif.
- Ⓢ General Cement Mfg. Co., 919 Taylor Ave., Rockford, Ill.
- Ⓢ Maas & Waldstein Co., 438 River Ave., Newark 4, N. J.
- Ⓢ Phitco Corp. Tloga & C Sts., Philadelphia 34, Pa.
- Ⓢ Polytech Devices, Inc., 1180 E. Grand St., Elizabeth, N. J.

FINISHES—Enamel

- Ⓢ Arco Co., 7301 Bessemer Ave., Cleveland 27, Ohio.
- Ⓢ Barrett Varnish Co., 1532 S. 50th Court, Cicero 50, Ill.

- Ⓢ Brooklyn Varnish Mfg. Co., 50 Jay St., Brooklyn, N. Y.
- Ⓢ Dolph Co., John C., Monmouth Junction, N. J.
- Ⓢ Du Pont de Nemours & Co., Inc., E. I., Wilmington 98, Delaware.
- Ⓢ Egyptian Lacquer Mfg. Co., Lafayette, Ind.
- Ⓢ FLOCK PROCESS CO., INC., 28 Fahey St., Springdale, Conn. ADV. PG. 196.
- Ⓢ General Cement Mfg. Co., 919 Taylor Ave., Rockford, Ill.
- Ⓢ Horn Co., Inc., A. C., 10th St. & 44th Ave., Long Island City 1, N. Y.
- Ⓢ IRVINGTON VARNISH & INSULATOR CO., 6 Argyle Terrace, Irvington 11, N. J. ADV. PG. 92, 93.
- Ⓢ Maas & Waldstein Co., 438 Riverside Ave., Newark 4, N. J.
- Ⓢ Pittsburgh Plate Glass Co., 200 Grant Bldg., Pittsburgh 20, Pa.
- Ⓢ Schenectady Varnish Co., Schenectady, N. Y.
- Ⓢ SESSIONS CLOCK CO., TIMER DIV., Forestville, Conn. ADV. PG. 123.
- Ⓢ Standard Varnish Works, 2600 Richmond Terrace, Staten Island 3, N. Y.

FINISHES—Lacquer

- Ⓢ American Products Mfg. Co., Oleander & Dublin Sts., New Orleans 18, La.
- Ⓢ Arco Co., 7301 Bessemer Ave., Cleveland 27, Ohio.
- Ⓢ Barrett Varnish Co., 1532 S. 50th Court, Cicero 50, Ill.
- Ⓢ Communication Products Co., Inc., Marlboro, N. J.
- Ⓢ Dolph Co., John C., Monmouth Junction, N. J.
- Ⓢ Du Pont de Nemours & Co., Inc., E. I., Wilmington 98, Delaware.
- Ⓢ Egyptian Lacquer Mfg. Co., Lafayette, Ind.
- Ⓢ FLOCK PROCESS CO., INC., 28 Fahey St., Springdale, Conn. ADV. PG. 196.
- Ⓢ General Cement Mfg. Co., 919 Taylor Ave., Rockford, Ill.
- Ⓢ Horn Co., Inc., A. C., 10th St. & 44th Ave., Long Island City 1, N. Y.
- Ⓢ Houghton Laboratories, Inc., 322 Bush St., Olean, N. Y.
- Ⓢ INSL-X CO., INC., Water St., Ossining, N. Y. ADV. PG. 386.
- Ⓢ Maas & Waldstein Co., 438 Riverside Ave., Newark 4, N. J.
- Ⓢ MICRO-CIRCUITS CO., New Buffalo, Mich. ADV. PG. 50.
- Ⓢ Pittsburgh Plate Glass Co., 200 Grant Bldg., Pittsburgh 20, Pa.
- Ⓢ SESSIONS CLOCK CO., TIMER DIV., Forestville, Conn. ADV. PG. 123.
- Ⓢ Standard Varnish Works, 2600 Richmond Terrace, Staten Island 3, N. Y.

FINISHES—Luminous Materials

- Ⓢ American Products Mfg. Co., Oleander & Dublin Sts., New Orleans 18, La.
- Ⓢ General Cement Mfg. Co., 919 Taylor Ave., Rockford, Ill.
- Ⓢ Maas & Waldstein Co., 438 Riverside Ave., Newark 4, N. J.
- Ⓢ Shannon Luminous Materials Co., 7356 Santa Monica Blvd., Hollywood 46, Calif.
- Ⓢ U. S. Radium Corp., 535 Pearl St., New York 7, N. Y.

FINISHES—Ripple

- Ⓢ Arco Co., 7301 Bessemer Ave., Cleveland 27, Ohio.
- Ⓢ General Cement Mfg. Co., 919 Taylor Ave., Rockford, Ill.
- Ⓢ Maas & Waldstein Co., 438 Riverside Ave., Newark 4, N. J.
- Ⓢ Standard Varnish Works, 2600 Richmond Terrace, Staten Island 3, N. Y.

FINISHES—Varnish

- Ⓢ Arco Co., 7301 Bessemer Ave., Cleveland 27, Ohio.
- Ⓢ Barrett Varnish Co., 1532 S. 50th Court, Cicero 50, Ill.
- Ⓢ Brooklyn Varnish Mfg. Co., 50 Jay St., Brooklyn, N. Y.
- Ⓢ Communication Products Co., Inc., Marlboro, N. J.
- Ⓢ Du Pont de Nemours & Co., Inc., E. I., Wilmington 98, Delaware.
- Ⓢ Egyptian Lacquer Mfg. Co., Lafayette, Ind.
- Ⓢ General Cement Mfg. Co., 919 Taylor Ave., Rockford, Ill.
- Ⓢ Horn Co., Inc., A. C., 10th St. & 44th Ave., Long Island City 1, N. Y.
- Ⓢ INSL-X CO., INC., Water St., Ossining, N. Y. ADV. PG. 386.
- Ⓢ Maas & Waldstein Co., 438 Riverside Ave., Newark 4, N. J.
- Ⓢ New Wrinkle, Inc., 1819 Bankers Bldg., 105 W. Adams Ave., Chicago 3, Ill.
- Ⓢ Pittsburgh Plate Glass Co., 200 Grant Bldg., Pittsburgh 20, Pa.
- Ⓢ Schenectady Varnish Co., Schenectady, N. Y.
- Ⓢ SESSIONS CLOCK CO., TIMER DIV., Forestville, Conn. ADV. PG. 123.
- Ⓢ Standard Varnish Works, 2600 Richmond Terrace, Staten Island 3, N. Y.

FLEXIBLE SHAFT EQUIPMENT

See Machines

FLOCK & FLOCKED PAPER

- Ⓢ Bestcraft Products, 626 Broadway, New York, N. Y.
- Ⓢ Cellusuede Products, Inc., Rockford, Ill.
- Ⓢ FLOCK PROCESS CO., INC., 28 Fahey St., Springdale, Conn. ADV. PG. 196.
- Ⓢ General Cement Mfg. Co., 919 Taylor Ave., Rockford, Ill.
- Ⓢ Schott Co., Walter L., 3225 Exposition Pl., Los Angeles 18, Calif.

FLUORESCENT COMPOUNDS—Phosphors

- Ⓢ Canadian Radium & Uranium Corp., 630 Fifth Ave., New York 20, N. Y.
- Ⓢ Du Pont de Nemours & Co., Inc., E. I., Wilmington 98, Delaware.
- Ⓢ General Cement Mfg. Co., 919 Taylor Ave., Rockford, Ill.
- Ⓢ PRECISE MEASUREMENTS CO., 942 Kings Highway, Brooklyn 23, N. Y. ADV. PG. 401.
- Ⓢ RADIO CORP. OF AMERICA, Tube Dept., Harrison, N. J. ADV. PG. 177, Inside Back & Back Cover.
- Ⓢ Shannon Luminous Materials Co., 7356 Santa Monica Blvd., Hollywood 46, Calif.
- Ⓢ SYLVANIA ELECTRIC PRODUCTS, INC., 1740 Broadway, New York 19, N. Y. ADV. PG. 432-436.
- Ⓢ U. S. Radium Corp., 535 Pearl St., New York 7, N. Y.

FLUOROMETERS

- Ⓢ Coleman Instruments, Inc., 318 Madison St., Maywood, Ill.
- Ⓢ Farrand Optical Co., Inc., Bronx Blvd. at 238th St., New York 70, N. Y.
- Ⓢ Menlo Research Laboratory, Menlo Park, Calif.
- Ⓢ Rubicon Co., 3761 Ridge Ave., Philadelphia 29, Pa.

FLUX—Brazing & Soldering

- Ⓢ AMERICAN PLATINUM WORKS, N. J. R. R. Ave. at Oliver St., Newark 5, N. J. ADV. PG. 76.
- Ⓢ American Solder & Flux Co., 2152 E. Norris St., Philadelphia 25, Pa.
- Ⓢ Division Lead Co., 836 W. Kinzie St., Chicago 22, Ill.
- Ⓢ DUBOIS CO., LTD., 366 Madison Ave., New York 17, N. Y. ADV. PG. 336.
- Ⓢ Eutetic Welding Alloys Corp., 40 Worth St., New York 13, N. Y.
- Ⓢ Farrelly Co., 1245 N. 26th St., Philadelphia 21, Pa.
- Ⓢ General Cement Mfg. Co., 919 Taylor Ave., Rockford, Ill.
- Ⓢ GLASER LEAD CO., INC., 31 Wyckoff Ave., Brooklyn, N. Y. ADV. PG. 416.
- Ⓢ Goldsmith Bros. Smelting & Refining Co., 111 N. Wabash Ave., Chicago 2, Ill.
- Ⓢ Handy & Harman, 82 Fulton St., New York 32, N. Y.
- Ⓢ International Nickel Co., Inc., 67 Wall St., New York 5, N. Y.
- Ⓢ Johnson Mfg. Co., Inc., Mt. Vernon, Iowa.
- Ⓢ Linick Chemical Co., 29 E. Madison St., Chicago 2, Ill.
- Ⓢ Soldering Specialties Co., Summit, N. J.
- Ⓢ Special Chemicals Corp., 30 Irving Pl., New York 3, N. Y.
- Ⓢ Standard Metals Corp., 262 Broad St., North Attleboro, Mass.
- Ⓢ Tricon Mfg. Co., 8318 S. Racine Ave., Chicago, Ill.

FLUX—Soldering

- Ⓢ Allen Co., Inc., L. B., 6751 Bryn Mawr Ave., Chicago 31, Ill.
- Ⓢ Alpha Metals, Inc., 365 Hudson Ave., Brooklyn 1, N. Y.
- Ⓢ Aluminum Co. of America, Gulf Bldg., Pittsburgh 30, Pa.
- Ⓢ American Chemical Paint Co., Ambler, Pa.
- Ⓢ American Solder & Flux Co., 2152 E. Norris St., Philadelphia 25, Pa.
- Ⓢ Brach Mfg. Corp., 200 Central Ave., Newark 4, N. J.
- Ⓢ Burnley Battery & Mfg. Co., Clay St., North East, Pa.
- Ⓢ Division Lead Co., 836 W. Kinzie St., Chicago 22, Ill.
- Ⓢ DUBOIS CO., LTD., 366 Madison Ave., New York 17, N. Y. ADV. PG. 336.
- Ⓢ Du Pont de Nemours & Co., Inc., E. I., Wilmington 98, Delaware.
- Ⓢ Enthoven & Sons Ltd., H. J., London, England—Sls. Agt. Maurice H. Esser, Dept. A, 113 N. Water St., Rochester 4, N. Y.
- Ⓢ Eutetic Welding Alloys Corp., 40 Worth St., New York 13, N. Y.
- Ⓢ Farrelly Co., 1245 N. 26th St., Philadelphia 21, Pa.
- Ⓢ General Cement Mfg. Co., 919 Taylor Ave., Rockford, Ill.
- Ⓢ GLASER LEAD CO., INC., 31 Wyckoff Ave., Brooklyn, N. Y. ADV. PG. 416.
- Ⓢ Goldsmith Bros. Smelting & Refining Co., 111 N. Wabash Ave., Chicago 2, Ill.

V indicates . . . IN PRODUCTION • AVAILABILITY • UNRESTRICTED FOR GENERAL USE

- Ⓞ International Nickel Co., Inc., 67 Wall St., New York 5, N. Y.
- Johnson Mfg. Co., Inc., Mt. Vernon, Iowa.
- Ⓞ **KESTER SOLDER CO.**, 4212 Wrightwood Ave., Chicago 39, Ill. ADV. PG. 357.
- Ⓞ Merck & Co., Inc., Rahway, N. J.
- Ⓞ Linick Chemical Co., 29 E. Madison St., Chicago 2, Ill.
- Ⓞ **MICO INSTRUMENT CO.**, 76 Trowbridge St., Cambridge 38, Mass. ADV. PG. 381.
- Ⓞ National Lead Co., 111 Broadway, New York 6, N. Y.
- Ⓞ Ohio Carbon Co., 12508 Berea Rd., Cleveland 11, Ohio.
- Ⓞ Osborn Products, Glen Ellyn, Ill.
- Ⓞ Pfanstiel Chemical Co., Metallurgical Div., 104 Lake View Ave., Waukegan, Ill.
- Ⓞ Ruby Chemical Co., 68 MacDowell St., Columbus, Ohio.
- Ⓞ Soldering Specialties Co., Summit, N. J.
- Ⓞ Special Chemicals Corp., 30 Irving Place, New York 3, N. Y.
- Ⓞ Standard Metals Corp., 262 Broad St., North Attleboro, Mass.
- Ⓞ Super Flow Solder Co., Inc., 90 State St., Albany, N. Y.
- Ⓞ Tricon Mfg. Co., 8318 S. Racine Ave., Chicago, Ill.

FLUXMETERS

- Ⓞ **GENERAL ELECTRIC CO.**, Schenectady 5, N. Y. ADV. PG. 1 to 22.
- Ⓞ **MARION ELECTRICAL INSTRUMENT CO.**, Manchester, N. H. ADV. PG. 200.
- Ⓞ Rawson Electrical Instrument Co., 111 Potter St., Cambridge 42, Mass.
- Ⓞ Rubicon Co., 3761 Ridge Ave., Philadelphia 29, Pa.
- Ⓞ Sensitive Research Instrument Corp., 9 Elm Ave., Mt. Vernon, N. Y.
- Ⓞ Varian Associates, 99 Washington St., San Carlos, Calif.

FOCUS COILS

See Coils, Television Focusing

FORKS—Electrically Driven Tuning

- Ⓞ **AMERICAN TIME PRODUCTS, INC.**, 580 Fifth Ave., New York 19, N. Y. ADV. PG. 226.
- Ⓞ Gaertner Scientific Corp., 1201 Wrightwood Ave., Chicago 14, Ill.
- Ⓞ **GENERAL RADIO CO.**, 275 Massachusetts Ave., Cambridge 39, Mass. ADV. PG. 48, 49.
- Ⓞ Hathaway Instrument Co., 1315 S. Clarkson St., Denver 10, Colo.
- Ⓞ Midwestern Geophysical Laboratory, 3400 S. Harvard, Tulsa, Okla.
- Ⓞ Miller Corp., Wm., 325 N. Halstead St., Pasadena 8, Calif.
- Ⓞ Muirhead Co., Inc., Beckenham-Kent-England.
- Ⓞ **PHILAMON LABORATORIES**, 5717 Third Ave., Brooklyn 20, N. Y. ADV. PG. 302.
- Ⓞ Riverbank Laboratories, Dept. of Engineering, Geneva, Ill.
- Ⓞ Stancil-Hoffman Corp., 1016 N. Highland Ave., Hollywood 38, Calif.
- Ⓞ Varo Mfg. Co., Inc., Box 638, Garland, Texas.
- Ⓞ Welch Scientific Co., W. M., 1515 Sedgwick St., Chicago 10, Ill.

FORMS—Antenna

- Coil Winders, Inc., 61 Bergen St., Brooklyn 2, N. Y.
- Ⓞ Radio Engineering Labs., Inc., 36-40 37th St., Long Island City 1, N. Y.
- Ⓞ Standard Metals Corp., 262 Broad St., North Attleboro, Mass.

FORMS—Coil

See Also Bobbins

- Ⓞ **ACCURATE PAPER TUBE CO.**, 851 N. Noble St., Chicago 22, Ill. ADV. PG. 413.
- Ⓞ Aero Coil Inc., 507 26th St., Union City, N. J.
- Ⓞ **ALDEN PRODUCTS CO.**, 117 N. Main St., Brockton 64, Mass. ADV. PG. 327.
- Ⓞ **AMERICAN LAVA CORP.**, Chattanooga 5, Tenn. ADV. PG. 143.
- Ⓞ **AMERICAN MOLDED PRODUCTS CO.**, 1644 N. Honore St., Chicago 22, Ill. ADV. PG. 382.
- Ⓞ **AMERICAN PHENOLIC CORP.**, 1830 S. 54th Ave., Chicago 50, Ill. ADV. PG. 61.
- Ⓞ **CAMBRIDGE THERMIONIC CORP.**, 445 Concord Ave., Cambridge 38, Mass. ADV. PG. 37.
- Ⓞ **CENTRALAB DIV. of Globe Union, Inc.**, 900 E. Keefe Ave., Milwaukee 1, Wis. ADV. PG. 85-88.
- Ⓞ **CITATION PRODUCTS CO.**, 233 E. 146th St., New York 51, N. Y. ADV. PG. 388.
- Ⓞ **CLEVELAND CONTAINER CO., THE**, 6201 Barberton Ave., Cleveland 2, Ohio. ADV. PG. 89.
- Coil Winders Inc., 61 Bergen St., Brooklyn 2, N. Y.
- Ⓞ **CORNING GLASS WORKS**, Corning, N. Y. ADV. PG. 373.
- Ⓞ **CROWLEY CO., INC.**, HENRY L., 1 Central Ave., West Orange, N. J. ADV. PG. 231.

- Ⓞ **ELECTRONIC MECHANICS, INC.**, 70 Clifton Blvd., Clifton, N. J. ADV. PG. 309.
- Ⓞ **EMELOID CO., INC., THE**, 1239 Central Ave., Hillside 5, N. J. ADV. PG. 102.
- Felsenthal & Sons, Inc., G., 4100 W. Grand Ave., Chicago 51, Ill.
- Ⓞ **GENERAL ACCESSORIES CO., LTD.**, 366 Madison Ave., New York 17, N. Y. ADV. PG. 336.
- Ⓞ **GENERAL CERAMICS & STEATITE CORP.**, Keasbey, N. J. ADV. PG. 126, 127.
- Ⓞ Gries Reproducer Corp., 100 Willow Ave., New York 54, N. Y.
- Ⓞ Insulating Fabricators of New England, Inc., 69 Grove St., Watertown 72, Mass.
- Ⓞ Insulating Tube Co., 26 Cottage St., P. O. Box 1, Poughkeepsie, N. Y.
- Ⓞ Insuline Corp. of America, 36-02 35th Ave., Long Island City, N. Y.
- Ⓞ Isolantite Mfg. Corp., Stirling, N. J.
- Ⓞ **KELLER PRODUCTS CO.**, 41 Union St., Manchester, N. H. ADV. PG. 397.
- Ⓞ Kirchberger & Co., Inc., M., 1425 37th St., Brooklyn 18, N. Y.
- Ⓞ Locke, Inc., P. O. Box 57, Baltimore 3, Ohio.
- Ⓞ Mayfair Molded Products Corp., 4440 N. Elston Ave., Chicago 30, Ill.
- Micarta Fabricators Inc., 5324 Ravenswood Ave., Chicago 40, Ill.
- Ⓞ Millen Mfg. Co., James, 150 Exchange St., Malden, Mass.
- Ⓞ Molded Insulation Co., 335 E. Price St., Philadelphia 44, Pa.
- Ⓞ **NATIONAL CO. INC.**, 61 Sherman St., Malden 48, Mass. ADV. PG. 280, 281.
- Ⓞ **NATIONAL MOLDITE CO.**, 1410 Chestnut Ave., Hillside 5, N. J. ADV. PG. 232.
- Ⓞ **NEO-SIL CORP.**, 26 Cornelison Ave., Jersey City 4, N. J. ADV. PG. 253.
- Ⓞ Panelyte Div., St. Regis Paper Corp., 230 Park Ave., New York 17, N. Y.
- Plastic Accessories, Inc., 93 Mercer St., New York 12, N. Y.
- Ⓞ **PRECISION PAPER TUBE CO.**, 2033 W. Charleston St., Chicago 47, Ill. ADV. PG. 156.
- Printloid Inc., 95 Mercer St., New York, N. Y.
- Ⓞ Quality Components, Inc., St. Mary's, Pa.
- Ⓞ Railway Communications, Inc., P. O. Box 1783, Lincoln, Nebr.
- Ⓞ Spaulding Fibre Co., Inc., 310 Wheeler St., Tonawanda, N. Y.
- Ⓞ **SPEER RESISTOR CORP.**, St. Mary's Pa. ADV. PG. 406.
- Ⓞ **STACKPOLE CARBON CO.**, St. Mary's, Pa. ADV. PG. 170, 171.
- Ⓞ Stevens Products Inc., 86-88 Main St., East Orange, N. J.
- Ⓞ **STUPAKOFF CERAMIC & MFG. CO.**, Latrobe, Pa. ADV. PG. 167.
- Ⓞ Synthane Corp., Oaks, Pa.
- Ⓞ **TEFLON PRODUCTS DIVISION, U. S. GASKET CO.**, P. O. Box 93, Camden, N. J. ADV. PG. 176.
- Ⓞ **THOR CERAMICS INC.**, 225 Belleville Ave., Bloomfield, N. J. ADV. PG. 378.
- Ⓞ Welch Scientific Co., W. M., 1515 Sedgwick St., Chicago 10, Ill.

FORMS—Resistor

- Ⓞ **CENTRALAB**, Div. of Globe Union, Inc., 900 E. Keefe Ave., Milwaukee 1, Wis. ADV. PG. 85-88.
- Ⓞ **ELECTRONIC MECHANICS, INC.**, 70 Clifton Blvd., Clifton, N. J. ADV. PG. 309.
- Ⓞ **GENERAL CERAMICS & STEATITE CORP.**, Keasbey, N. J. ADV. PG. 126, 127.
- Ⓞ Isolantite Mfg. Corp., Stirling, N. J.
- Ⓞ Kirchberger & Co., Inc., M., 1425 37th St., Brooklyn 18, N. Y.
- Ⓞ **LOUTHAN MFG. CO.**, East Liverpool, Ohio. ADV. PG. 284.
- Ⓞ **NATIONAL MOLDITE CO.**, 1410 Chestnut Ave., Hillside 5, N. J. ADV. PG. 232.
- Ⓞ **PAINTON & CO., INC., LTD.**, 366 Madison Ave., New York 17, N. Y. ADV. PG. 336.
- Ⓞ Precision Resistor Co., 334 Badger Ave., Newark 8, N. J.
- Ⓞ **SHALLCROSS MFG. CO.**, 10 Jackson Ave., Collingdale, Pa. ADV. PG. 261.
- Ⓞ **SPEER RESISTOR CORP.**, St. Marys, Pa. ADV. PG. 406.
- Ⓞ **STUPAKOFF CERAMIC & MFG. CO.**, Latrobe, Pa. ADV. PG. 167.
- Ⓞ **TEFLON PRODUCTS DIVISION, U. S. GASKET CO.**, P. O. Box 93, Camden, N. J. ADV. PG. 176.
- Ⓞ **THOR CERAMICS INC.**, 225 Belleville Ave., Bloomfield, N. J. ADV. PG. 378.

FORMS—Wire

- Ⓞ **ART WIRE & STAMPING CO.**, 227 High St., Newark 2, N. J. ADV. PG. 38.
- Ⓞ **BRAININ CO., C. S.**, 320 Washington St., Mt. Vernon, N. Y. ADV. PG. 142.
- Coil Winders, Inc., 61 Bergen St., Brooklyn 2, N. Y.
- Ⓞ **Dudek & Bock Spring & Mfg. Co.**, 2100 W. Fulton, Chicago 12, Ill.

- Ⓞ **LEE MECHANICAL LABS.** Div. of Lee Spring Co., Inc., 30 Main St., Brooklyn 1, N. Y. ADV. PG. 303.
- Ⓞ **Plume & Atwood Mfg. Co.**, 220 Broadway, New York, N. Y.
- Ⓞ **TEFLON PRODUCTS DIVISION, U. S. GASKET CO.**, P. O. Box 93, Camden, N. J. ADV. PG. 176.
- Ⓞ **WEBSTER SPRING CORP.**, 176-182 Johnson St., Brooklyn 1, N. Y. ADV. PG. 394.
- Ⓞ Zierick Mfg. Corp., Beechwood & Rockdale Aves., New Rochelle, N. Y.

FREQUENCY STANDARDS

See Standards—Frequency

FURNACES—Electric for Electronic Component Production

- Ⓞ **DANIELS, INC.**, C. R., Daniels P. O., Baltimore, Md. ADV. PG. 342.

FURNACES—High Frequency

- Ⓞ Ajax Electrothermic Corp., Ajax Park, Trenton 5, N. J.
- Ⓞ Ecco High Frequency Corp., 7020 Hudson Blvd., North Bergen, N. J.
- Ⓞ Electronic Engineering Corp., 469 Elm St., Arlington, N. J.
- Ⓞ **GENERAL ELECTRIC CO.**, Schenectady 5, N. Y. ADV. PG. 1 to 22.
- Ⓞ High Frequency Heating Co., 143 Glen Park Ave., Gary, Ind.
- Ⓞ Lepel High Frequency Labs., Inc., 39 W. 60th St., New York 23, N. Y.
- Ⓞ Sherman Industrial Electronics Co., Inc., 505 Washington Ave., Belleville 9, N. J.
- Ⓞ Weltronic Co., 19500 W. Eight Mile Rd., Detroit 19, Mich.

FUSE HOLDERS

See Blocks

FUSES

- Ⓞ Bel Fuse Inc., 311 Mountain Road, Union City, N. J.
- Ⓞ Burndy Engineering Co., Inc., 107 Bruckner Blvd., New York 54, N. Y.
- Ⓞ **BUSSMANN MFG. CO.**, St. Louis 7, Mo. ADV. PG. 210.
- Ⓞ Eagle Electric Mfg. Co., Inc., 23-10 Bridge Plaza, S., Long Island City, N. Y.
- Economy Fuse & Mfg. Co., 2717 Greenview Ave., Chicago 14, Ill.
- Jefferson Electric Co., Bellwood, Ill.
- Ⓞ **LITTELFUSE, INC.**, 4757 Ravenswood Ave., Chicago 40, Ill. ADV. PG. 285.
- Ⓞ Philco Corp., Tioga & C Sts., Philadelphia 34, Pa.
- Ⓞ Trico Fuse Mfg. Co., 2948 N. Fifth, Milwaukee 12, Wis.
- Ⓞ **WESTINGHOUSE ELECTRIC CORP.**, 511 Wood St., P. O. Box 868, Pittsburgh 30, Pa. ADV. PG. 107-113.

GAGES—Comparator

- Ⓞ DoAll Co., 254 N. Laurel Ave., Des Plaines, Ill.
- Ⓞ Eastman Kodak Co., Industrial Photographic Div., 343 State St., Rochester 4, N. Y.
- Ⓞ **GENERAL ELECTRIC CO.**, Schenectady 5, N. Y. ADV. PG. 1 to 22.
- Ⓞ Hathaway Instrument Co., 1315 S. Clarkson St., Denver 10, Colo.
- Ⓞ **INDUSTRIAL ELECTRONICS, INC.**, 8080 Wheeler St., Detroit 10, Mich. ADV. PG. 234, 235.
- Ⓞ Metron Instrument Co., 432 Lincoln St., Denver 9, Colo.
- Ⓞ Pratt & Whitney Div., Niles-Bement-Pond Co., West Hartford, Conn.
- Scherr Co., Inc., Geo., 200 Lafayette St., New York 12, N. Y.
- Ⓞ Sheffield Corp., Dayton 1, Ohio.

GAGES—Displacement Measuring

- Ⓞ **AIR ASSOCIATES, INC.**, Teterboro, N. J. ADV. PG. 211.
- Ⓞ Carlson Micrometer Corp., 2 E. Main St., Little Falls, N. J.
- Ⓞ Clarke Instrument Div., National Electrical Machine Shops, Inc., 919 Jesup-Blair Drive, Silver Spring, Md.
- Ⓞ Control Engineering Corp., 863 Washington St., Canton, Mass.
- Ⓞ Coral Designs Div. of Henry G. Dietz Co., 12-16 Astoria Blvd., Long Island City 2, N. Y.
- Ⓞ Electronic Control Corp., 1573 E. Forest St., Detroit, Mich.
- Ⓞ Hart Associates, 8430 Grand River, Detroit 4, Mich.
- Ⓞ Hathaway Instrument Co., 1315 S. Clarkson St., Denver 10, Colo.
- Ⓞ **INDUSTRIAL ELECTRONICS, INC.**, 8080 Wheeler St., Detroit 10, Mich. ADV. PG. 234, 235.

Ⓢ indicates . . . IN PRODUCTION • AVAILABILITY • UNRESTRICTED FOR GENERAL USE

- Ⓢ Photocon Research Products, 1062 N. Allen Ave., Pasadena 7, Calif.
- Ⓢ Schaeffitz Engineering, Crescent Blvd. at Drexel Ave., Pennsauken Township, Camden 11, N. J.
- Ⓢ Statham Laboratories, Inc., 12401 W. Olympic Blvd., Los Angeles 64, Calif.

GAGES—Electronic Fuel Indicator

- Ⓢ AIR ASSOCIATES, INC., Teterboro, N. J. ADV. PG. 211.
- Ⓢ Atlantic Electronics, 4 Manhasset Ave., Manorhaven, N. Y.
- Ⓢ Glenco Corp., Metuchen, N. J.
- Ⓢ Gulton Mfg. Corp., Metuchen, N. J.

GAGES—Electronic Inspection

- Ⓢ Arma Corp., 254 36th St., Brooklyn 32, N. Y.
- Ⓢ BRANSON INSTRUMENTS, INC., 438 Fairfield Ave., Stamford, Conn. ADV. PG. 90.
- Ⓢ Carson Micrometer Corp., 2 E. Main St., Little Falls, N. J.
- Ⓢ Control Engineering Corp., 863 Washington St., Canton, Mass.
- Ⓢ DoAll Co., 254 N. Laurel Ave., Des Plaines, Ill.
- Ⓢ EDIN CO., INC., 207 Main St., Worcester, Mass. ADV. PG. 285.
- Ⓢ Electronic Control Corp., 1573 E. Forest St., Detroit, Mich.
- Ⓢ Hart Associates, 8430 Grand River, Detroit 4, Mich.
- Ⓢ Industrial Electronics Co., Hanover, Mass.
- Ⓢ INDUSTRIAL ELECTRONICS, INC., 8080 Wheeler St., Detroit 10, Mich. ADV. PG. 234, 235.
- Ⓢ Photobell Company, 116 Nassau St., New York 7, N. Y.
- Ⓢ Photocon Research Products, 1062 N. Allen Ave., Pasadena 7, Calif.
- Ⓢ Pratt & Whitney Div., Niles-Bement-Pond Co., West Hartford 1, Conn.
- Ⓢ Precision Devices, Inc., 147-149 Cedar St., New York 6, N. Y.
- Ⓢ Scherr Co. Inc., George, 200 Lafayette St., New York 12, N. Y.
- Ⓢ Sheffield Corp., Dayton 1, Ohio.
- Ⓢ Standard Electronics Research Corp., 2 East End Ave., New York 21, N. Y.
- Ⓢ Star Expansion Products Co., 147-149 Cedar St., New York 6, N. Y.

GAGES—Electronic Spring Checking

- Ⓢ Carson Micrometer Corp., 2 E. Main St., Little Falls, N. J.
- Ⓢ INDUSTRIAL ELECTRONICS, INC., 8080 Wheeler St., Detroit 10, Mich. ADV. PG. 234, 235.

GAGES—Ionization

- Ⓢ AIRMEC LABORATORIES LTD., 366 Madison Ave., New York 17, N. Y. ADV. PG. 336.
- Ⓢ Distillation Products Div. of Eastman Kodak Co., 755 Ridge Rd., W. Rochester 3, N. Y.
- Ⓢ Eitel-McCullough, Inc., San Bruno, Calif.
- Ⓢ Electronic Engineering Corp., 469 Elm St., Arlington, N. J.
- Ⓢ Fredericks Co., Geo. E. Bethayres, Pa.
- Ⓢ GENERAL ELECTRIC CO., Schenectady 5, N. Y. ADV. PG. 1 to 22.
- Ⓢ GENERAL ELECTRIC CO., Electronics Dept., Tube Div., Schenectady 5, N. Y. ADV. PG. 1 to 22.
- Ⓢ National Research Corp., 70 Memorial Drive, Cambridge 42, Mass.
- Ⓢ Process & Instruments, 60 Greenpoint Ave., Brooklyn 22, N. Y.
- Ⓢ RADIO CORP. OF AMERICA, RCA Victor Div., General Offices, Camden, N. J. ADV. PG. 177, Inside Back and Back Covers.
- Ⓢ Welch Scientific Co., W. M., 1515 Sedgwick St., Chicago 10, Ill.
- Ⓢ WESTINGHOUSE ELECTRIC CORP., 511 Wood St., P. O. Box 868, Pittsburgh 30, Pa. ADV. PG. 107-113.
- Ⓢ Glenco Corp., Metuchen, N. J.
- Ⓢ Gulton Mfg. Corp., Metuchen, N. J.
- Ⓢ Gluco Corp., Metuchen, N. J.
- Ⓢ Gupton Co., Claud S., 3000 S. Wallace St., Chicago 16, Ill.
- Ⓢ Gulton Mfg. Corp., Metuchen, N. J.
- Ⓢ Hathaway Instrument Co., 1315 S. Clarkson St., Denver 10, Colo.
- Ⓢ INDUSTRIAL ELECTRONICS, INC., 8080 Wheeler St., Detroit 10, Michigan. ADV. PG. 234, 235.
- Ⓢ Manning, Maxwell & Moore, Inc., Stratford, Conn.
- Ⓢ Midwestern Geophysical Laboratory, 3400 S. Harvard, Tulsa, Okla.
- Ⓢ MINNEAPOLIS-HONEYWELL REGULATOR CO., INDUSTRIAL DIV., Wayne & Roberts Aves., Philadelphia 44, Pa. ADV. PG. 208, 209.
- Ⓢ Photocon Research Products, 1062 N. Allen Ave., Pasadena 7, Calif.
- Ⓢ Schauer Mfg. Corp., 2119 Reading Rd., Cincinnati 2, Ohio.
- Ⓢ Sheffield Corp., Dayton 1, Ohio.
- Ⓢ Sierra Electronic Corp., San Carlos, Calif.
- Ⓢ Statham Laboratories, Inc., 12401 W. Olympic Blvd., Los Angeles 64, Calif.
- Ⓢ Tagliabue Div., Weston Electrical Instrument Corp., 614 Frelinghuysen Ave., Newark 5, N. J.
- Ⓢ Technitrol Engineering Co., 3211 Woodland Ave., Philadelphia 4, Pa.
- Ⓢ Trans-Sonics, Inc., Bedford Airport, Bedford, Mass.
- Ⓢ U. S. Gauge Div., American Machine & Metals, Inc., Sellersville, Pa.
- Ⓢ Wallace & Tiernan Products, Inc., Belleville 9, N. J.
- Ⓢ Weksler Thermometer Corp., 52 W. Houston St., New York 12, N. Y.
- Ⓢ Welch Scientific Co., W. M., 1515 Sedgwick St., Chicago 10, Ill.
- Ⓢ Winslow Co., Inc., 9 Liberty St., Newark 5, N. J.

GAGES—Paint Depth

- American Instrument Co., 8030 Georgia Ave., Silver Spring, Md.
- Ⓢ BRANSON INSTRUMENTS, INC., 438 Fairfield Ave., Stamford, Conn. ADV. PG. 90.
- Ⓢ Electronic Control Corp., 1573 E. Forest St., Detroit, Mich.
- Ⓢ GENERAL ELECTRIC CO., Schenectady 5, N. Y. ADV. PG. 1 to 22.
- Ⓢ Glenco Corp., Metuchen, N. J.
- Ⓢ Gulton Mfg. Corp., Metuchen, N. J.

GAGES—Photoelectric Dimension

- Ⓢ Berkshire Laboratories, 580 Lexington Rd., Concord, Mass.
- Ⓢ Electronic Control Corp., 1573 E. Forest St., Detroit, Mich.

- Ⓢ GENERAL ELECTRIC CO., Schenectady 5, N. Y. ADV. PG. 1 to 22.
- Ⓢ Hart Associates, 8430 Grand River, Detroit 4, Mich.
- Ⓢ Industrial Electronics Co., Hanover, Mass.
- Ⓢ Photobell Company, 116 Nassau St., New York 7, N. Y.
- Ⓢ Standard Electronics Research Corp., 2 East End Ave., New York 21, N. Y.
- Ⓢ WESTINGHOUSE ELECTRIC CORP., 511 Wood St., P. O. Box 868, Pittsburgh 30, Pa. ADV. PG. 107-113.

GAGES—Pirani

- Ⓢ CONTINENTAL ELECTRIC CO., Geneva, Ill. ADV. PG. 182.
- Ⓢ Distillation Products Div. of Eastman Kodak Co., 755 Ridge Rd., W. Rochester 3, N. Y.
- Ⓢ Electronic Engineering Corp., 469 Elm St., Arlington, N. J.
- Ⓢ Fredericks Co., Geo. E. Bethayres, Pa.
- Ⓢ GENERAL ELECTRIC CO., Electronics Dept., Tube Div., Schenectady 5, N. Y. ADV. PG. 1 to 22.
- Ⓢ Process & Instruments, 60 Greenpoint Ave., Brooklyn 22, N. Y.
- Ⓢ SYLVANIA ELECTRIC PRODUCTS, INC., 1740 Broadway, New York 19, N. Y. ADV. PG. 432-436.
- Ⓢ Welch Scientific Co., W. M., 1515 Sedgwick St., Chicago 10, Ill.
- Ⓢ Winslow Co., Inc., 9 Liberty St., Newark 5, N. J.

GAGES—Pressure

- Airplane & Marine Instruments, Inc., Clearfield, Pa.
- Ⓢ Bailey Meter Co., 1044 Ivanhoe Rd., Cleveland 10, Ohio.
- Ⓢ Baldwin-Lima-Hamilton Corp., Paschall P. O. Station, Philadelphia 42, Pa.
- Ⓢ Bendix Aviation Corp., Pacific Division, 11600 Sherman Way, North Hollywood, Calif.
- Ⓢ Bristol Co., The, Waterbury 20, Conn.
- Ⓢ Control Engineering Corp., 863 Washington St., Canton, Mass.
- Ⓢ Coral Designs Div. of Henry G. Dietz Co., 12-16 Astoria Blvd., Long Island City 2, N. Y.
- Ⓢ Dillon & Co., Inc., W. C., 1421 S. Circle Ave., Forest Park, Ill.
- Ⓢ ELECTRO PRODUCTS LABS., 4501 N. Ravenswood Ave., Chicago 40, Ill. ADV. PG. 199.
- Ⓢ Esterline-Angus Co., Inc., P. O. Box 596, Indianapolis 6, Ind.
- Ⓢ Flader, Inc., Fred, 1330 Lasky Rd., Toledo 12, Ohio.
- Ⓢ Foxboro Co., The, Foxboro, Mass.
- Ⓢ GENERAL ELECTRIC CO., Schenectady 5, N. Y. ADV. PG. 1 to 22.
- Ⓢ Glenco Corp., Metuchen, N. J.
- Ⓢ Gordon Co., Claud S., 3000 S. Wallace St., Chicago 16, Ill.
- Ⓢ Gulton Mfg. Corp., Metuchen, N. J.
- Ⓢ Hathaway Instrument Co., 1315 S. Clarkson St., Denver 10, Colo.
- Ⓢ INDUSTRIAL ELECTRONICS, INC., 8080 Wheeler St., Detroit 10, Michigan. ADV. PG. 234, 235.
- Ⓢ Manning, Maxwell & Moore, Inc., Stratford, Conn.
- Ⓢ Midwestern Geophysical Laboratory, 3400 S. Harvard, Tulsa, Okla.
- Ⓢ MINNEAPOLIS-HONEYWELL REGULATOR CO., INDUSTRIAL DIV., Wayne & Roberts Aves., Philadelphia 44, Pa. ADV. PG. 208, 209.
- Ⓢ Photocon Research Products, 1062 N. Allen Ave., Pasadena 7, Calif.
- Ⓢ Schauer Mfg. Corp., 2119 Reading Rd., Cincinnati 2, Ohio.
- Ⓢ Sheffield Corp., Dayton 1, Ohio.
- Ⓢ Sierra Electronic Corp., San Carlos, Calif.
- Ⓢ Statham Laboratories, Inc., 12401 W. Olympic Blvd., Los Angeles 64, Calif.
- Ⓢ Tagliabue Div., Weston Electrical Instrument Corp., 614 Frelinghuysen Ave., Newark 5, N. J.
- Ⓢ Technitrol Engineering Co., 3211 Woodland Ave., Philadelphia 4, Pa.
- Ⓢ Trans-Sonics, Inc., Bedford Airport, Bedford, Mass.
- Ⓢ U. S. Gauge Div., American Machine & Metals, Inc., Sellersville, Pa.
- Ⓢ Wallace & Tiernan Products, Inc., Belleville 9, N. J.
- Ⓢ Weksler Thermometer Corp., 52 W. Houston St., New York 12, N. Y.

GAGES—Strain

- American Instrument Co., 8030 Georgia Ave., Silver Spring, Md.
- Ⓢ Baldwin-Lima-Hamilton Corp., Paschall P. O. Station, Philadelphia 42, Pa.
- Ⓢ Bendix Aviation Corp., Pacific Division, 11600 Sherman Way, North Hollywood, Calif.
- Ⓢ Control Engineering Corp., 863 Washington St., Canton, Mass.
- Ⓢ Dillon & Co., Inc., W. C. 1421 S. Circle Ave., Forest Park, Ill.
- Ⓢ EDIN CO., INC., 207 Main St., Worcester, Mass. ADV. PG. 285.
- Ⓢ Foxboro Co., The, Foxboro, Mass.
- Ⓢ GENERAL ELECTRIC CO., Schenectady 5, N. Y. ADV. PG. 1 to 22.

- Ⓢ Glenco Corp., Metuchen, N. J.
- Ⓢ Gulton Mfg. Corp., Metuchen, N. J.
- Ⓢ Hathaway Instrument Co., 1315 S. Clarkson St., Denver 10, Colorado.
- Ⓢ Midwestern Geophysical Laboratory, 3400 S. Harvard, Tulsa, Okla.
- Ⓢ Muirhead & Co., Ltd., Beckenham-Kent-England.
- Ⓢ Pratt & Whitney Div., Niles-Bement-Pond Co., West Hartford 1, Conn.
- Ⓢ Statham Laboratories, Inc., 12401 W. Olympic Blvd., Los Angeles 64, Calif.
- Ⓢ Trans-Sonics, Inc., Bedford Airport, Bedford, Mass.

GAGES—Ultrasonic Thickness

- Ⓢ BRANSON INSTRUMENTS, INC., 438 Fairfield Ave., Stamford, Conn. ADV. PG. 90.
- Ⓢ Dice Co., J., W. Englewood, N. J.
- Ⓢ Glenco Corp., Metuchen, N. J.
- Ⓢ Gulton Mfg. Corp., Metuchen, N. J.
- Ⓢ Photocon Research Products, 1062 N. Allen Ave., Pasadena 7, Calif.
- Ⓢ Piezo Products Co., Whitney St., Framingham, Mass.
- Ⓢ Sperry Products, Inc., Danbury, Conn.

GAGES—Vacuum

- Ⓢ Bailey Meter Co., 1044 Ivanhoe Rd., Cleveland 10, Ohio.
- Ⓢ Bristol Co., The, Waterbury 20, Conn.
- Ⓢ Central Scientific Co., 1700 Irving Park Rd., Chicago 13, Ill.
- Ⓢ Clarke Instrument Div., National Electrical Machine Shops, Inc., 919 Jesup-Blair Drive, Silver Spring, Md.
- Ⓢ CONTINENTAL ELECTRIC CO., Geneva, Ill. ADV. PG. 182.
- Ⓢ Distillation Products Div. of Eastman Kodak Co., 755 Ridge Rd., W. Rochester 3, N. Y.
- Ⓢ Electronic Engineering Corp., 469 Elm St., Arlington, N. J.
- Ⓢ Esterline-Angus Co., Inc., P. O. Box 596, Indianapolis 6, Ind.
- Ⓢ Fredericks Co., Geo. E. Bethayres, Pa.
- Ⓢ GENERAL ELECTRIC CO., Schenectady 5, N. Y. ADV. PG. 1 to 22.
- Ⓢ Hastings Instrument Co., Inc., Hampton 9, Va.
- Ⓢ Hathaway Instrument Co., 1315 S. Clarkson St., Denver 10, Colo.
- Ⓢ King Electric Equipment Co., 9123 Inman Ave., Cleveland 5, Ohio.
- Ⓢ Manning, Maxwell & Moore, Inc., Stratford, Conn.
- Ⓢ National Research Corp., 70 Memorial Drive, Cambridge 42, Mass.
- Ⓢ Process & Instruments, 60 Greenpoint Ave., Brooklyn 22, N. Y.
- Ⓢ RADIO CORP. OF AMERICA, RCA Victor Div., General Offices, Camden, N. J. ADV. PG. 177, Inside Back and Back Covers.
- Ⓢ Research Electronics Lab., 2459 Susquehanna Rd., Roslyn, Pa.
- Ⓢ Schauer Mfg. Corp., 2119 Reading Rd., Cincinnati 2, Ohio.
- Ⓢ Skaneateles Mfg. Co., Inc., 122 Dickerson St., Syracuse 2, N. Y.
- Ⓢ Tagliabue Div., Weston Electrical Instrument Corp., 614 Frelinghuysen Ave., Newark 5, N. J.
- Ⓢ Technitrol Engineering Co., 3211 Woodland Ave., Philadelphia 4, Pa.
- Ⓢ U. S. Gauge Div., American Machine & Metals, Inc., Sellersville, Pa.
- Ⓢ Wallace & Tiernan Products, Inc., Belleville 9, N. J.
- Ⓢ Weksler Thermometer Corp., 52 W. Houston St., New York 12, N. Y.
- Ⓢ Welch Scientific Co., W. M., 1515 Sedgwick St., Chicago 10, Ill.
- Ⓢ Winslow Co., Inc., 9 Liberty St., Newark 5, N. J.

GALVANOMETERS

- Ⓢ Assembly Products, Inc., Chagrin Falls 6, Ohio.
- Ⓢ Associated Research, Inc., 3758 W. Belmont, Chicago 18, Ill.
- Ⓢ Berndt-Bach, Inc., 7373 Beverly Blvd., Los Angeles 36, Calif.
- Ⓢ Biddle Co., James G., 1316 Arch St., Philadelphia 7, Pa.
- Ⓢ Century Geophysical Corp., 1333 N. Utica, Tulsa 3, Okla.
- Ⓢ Cole Instrument Co., 1320 S. Grand Ave., Los Angeles 15, Calif.
- Ⓢ EDIN CO., INC., 207 Main St., Worcester, Mass. ADV. PG. 285.
- Ⓢ Engineering Lab., Inc., 602 E. 4th St., Tulsa 3, Okla.
- Ⓢ G-M LABORATORIES, INC., 4313 No. Knox Ave., Chicago, Ill. ADV. PG. 392.
- Ⓢ GENERAL ELECTRIC CO., Schenectady 5, N. Y. ADV. PG. 1 to 22.
- Ⓢ Hathaway Instrument Co., 1315 S. Clarkson St., Denver 10, Colo.
- Ⓢ HEILAND RESEARCH CORP., 130 E. 5th Ave., Denver 9, Colo. ADV. PG. 401.
- Ⓢ INDUSTRIAL CONTROL CO., Straight Path & Arlington Ave., Wyandanch, N. Y. ADV. PG. 130.

Ⓟ indicates . . . IN PRODUCTION • AVAILABILITY • UNRESTRICTED FOR GENERAL USE

- Ⓟ J B T INSTRUMENTS, INC., 431-B Chapel St., New Haven 8, Conn. ADV. PG. 351.
- Ⓟ Leeds & Northrup Co., 4970 Stenton Ave., Philadelphia 44, Pa.
- Ⓟ Meters, Inc., 915 Westfield Blvd., Indianapolis 20, Ind.
- Ⓟ Midwestern Geophysical Laboratory, 3400 S. Harvard, Tulsa, Okla.
- Ⓟ Miller Corp., Wm., 325 N. Halstead St., Pasadena 8, Calif.
- Ⓟ Muirhead & Co., Ltd., Beckenham-Kent-England.
- Ⓟ Rubicon Co., 3761 Ridge Ave., Philadelphia 29, Pa.
- Ⓟ SANBORN CO., 39 Osborn St., Cambridge 39, Mass. ADV. PG. 391.
- Ⓟ SHALLCROSS MFG. CO., 10 Jackson Ave., Collingsdale, Pa. ADV. PG. 261.
- Ⓟ Simpson Electric Co., Div., American Gage & Machine Co., 5218 W. Kinzie St., Chicago 44, Ill.
- Ⓟ Southwestern Industrial Electronics Co., 2831 Post Oak Rd., P. O. Box 13058, Houston 19, Texas.
- Ⓟ Welch Scientific Co., W. M., 1515 Sedgwick St., Chicago 10, Ill.
- Ⓟ WESTINGHOUSE ELECTRIC CORP., 511 Wood St., P. O. Box 868, Pittsburgh 30, Pa. ADV. PG. 107-113.
- Ⓟ WESTON ELECTRICAL INSTRUMENT CORP., 595 Frelinghuysen Ave., Newark 5, N. J. ADV. PG. 243.
- Ⓟ Winslow Co., Inc., 9 Liberty St., Newark 5, N. J.

GASES—Nitrogen

- Ⓟ Communication Products Co., Inc., Marlboro, N. J.
- Ⓟ Linde Air Products Co., Division of Union Carbide and Carbon Corp., 30 E. 42nd St., New York 17, N. Y.

GASES—Rare

- Ⓟ GENERAL CHEMICAL DIV. OF ALLIED CHEMICAL & DYE CORP., 40 Rector St., New York 6, N. Y. ADV. PG. 84.
- Ⓟ Linde Air Products Co., Division of Union Carbide and Carbon Corp., 30 E. 42nd St., New York 17, N. Y.

GASKETS

- Ⓟ Armstrong Cork Co., Lancaster, Pa.
- Ⓟ Auburn Mfg. Co., Pease Ave. & Stack St., Middletown, Conn.
- Ⓟ Baer Co., N. S., 9 Montgomery St., Hillside, N. J.
- Ⓟ Brandywine Fibre Co., 15th & Poplar Sts., Wilmington, Del.
- Ⓟ Chase Brass & Copper Co., Inc., 236 Grand St., Waterbury 20, Conn.
- Ⓟ CITATION PRODUCTS CO., 233 E. 146th St., New York 51, N. Y. ADV. PG. 388.
- Ⓟ Crane Packing Co., 1800 Cuyler Ave., Chicago 18, Ill.
- Ⓟ Felsenthal & Sons, Inc., G., 4100 W. Grand Ave., Chicago 51, Ill.
- Ⓟ Felt Products Mfg. Co., 1504 W. Carroll Ave., Chicago 7, Ill.
- Ⓟ Garlock Packing Co., Palmyra, N. Y.
- Ⓟ Gasket Engineering Co., 2440 Charlotte St., Kansas City 8, Mo.
- Ⓟ Johns-Manville, 22 E. 40th St., New York 16, N. Y.
- Ⓟ METAL TEXTILE CORP., 547 E. First Ave., Roselle, N. J. ADV. PG. 40.
- Ⓟ NEO-SIL CORP., 26 Cornelison Ave., Jersey City 4, N. J. ADV. PG. 253.
- Ⓟ Precision Devices, Inc., 147-149 Cedar St., New York 6, N. Y.
- Ⓟ Rogers Corp., Manchester, Conn.
- Ⓟ Spaulding Fibre Co., Inc., 310 Wheeler St., Tonawanda, N. Y.
- Ⓟ Star Expansion Products Co., 147-149 Cedar St., New York 6, N. Y.
- Ⓟ TEFLON PRODUCTS DIVISION, U. S. GASKET CO., P. O. Box 93, Camden N. J. ADV. PG. 176.
- Ⓟ U. S. Rubber Co., 1230 Avenue of the Americas, New York 20, N. Y.
- Ⓟ Western Felt Works, 4029 Ogden Ave., Chicago, Ill.

GEARS—Precision

- Ⓟ AIR ASSOCIATES, INC., Teterboro, N. J. ADV. PG. 211.
- Ⓟ Atlas Metal Stamping Co., Castor & Kensington Aves., Philadelphia 24, Pa.
- Ⓟ Beaver Gear Works, Inc., 1038 Parmele St., Rockford, Ill.
- Ⓟ BELOCK INSTRUMENT CORP., 111th St. & 14th Ave., College Point, N. Y. ADV. PG. 371.
- Ⓟ Berndt-Bach, Inc., 7373 Beverly Blvd., Los Angeles 36, Calif.
- Ⓟ Bunnell & Co., J. H., 81 Prospect St., Brooklyn, N. Y.
- Ⓟ Control Engineering Corp., 863 Washington St., Canton, Mass.
- Ⓟ Foote Brothers Gear & Machine Corp., 4545 S. Western Blvd., Chicago 9, Ill.
- Ⓟ Ford Instrument Co., Inc., 31-10 Thomson Ave., Long Island City, N. Y.
- Ⓟ Gear Specialties, 2635 W. Medill Ave., Chicago 47, Ill.
- Ⓟ Gries Reproducer Corp., 100 Willow Ave., New York 54, N. Y.

- Ⓟ Industrial Precision Products Co., 315-325 N. Hoyle Ave., Chicago 12, Ill.
- Ⓟ Metron Instrument Co., 432 Lincoln St., Denver 9, Colo.
- Ⓟ Peerless Instrument Co., 90-15 Corona Ave., Elmhurst, N. Y.
- Ⓟ Precision Devices, Inc., 147-149 Cedar St., New York 6, N. Y.
- Ⓟ QUAKER CITY GEAR WORKS, 1908-32 N. Front St., Philadelphia, Pa. ADV. PG. 166.
- Ⓟ REEVES INSTRUMENT CORP., 215 E. 91st St., New York, N. Y. ADV. PG. 315.
- Ⓟ Shakeproof, Inc., Div. of Illinois Tool Wks., 2501 N. Keeler Ave., Chicago 39, Ill.
- Ⓟ TRANSICIL CORP., 107 Grand St., New York, N. Y. ADV. PG. 116.

GENERATORS—Electronic Variable Frequency

- Ⓟ Airborne Instruments Lab., Inc., 160 Old Country Rd., Mineola, L. I., N. Y.
- Ⓟ BARKER & WILLIAMSON, 235 Fairfield Ave., Upper Darby, Pa. ADV. PG. 292.
- Ⓟ COMMUNICATION MEASUREMENTS LAB., INC., 120 Greenwich St., New York 6, N. Y. ADV. PG. 290.
- Ⓟ DAVEN CO., 191 Central Ave., Newark 4, N. J. ADV. PG. 157.
- Ⓟ ELECTRONIC MEASUREMENTS COMPANY, Red Bank, N. J. ADV. PG. 312.
- Ⓟ EL-TRONICS INC., 2649 N. Howard St., Philadelphia 33, Pa. ADV. PG. 299.
- Ⓟ FEDERAL MFG. & ENGR. CORP., 211 Steuben St., Brooklyn 5, N. Y. ADV. PG. 344.
- Ⓟ Gates Radio Co., Quincy, Ill.
- Ⓟ GENERAL ELECTRIC CO., Electronics Dept., Electronics Park, Syracuse, N. Y. ADV. PG. 1 to 22.
- Ⓟ GENERAL RADIO CO., 275 Massachusetts Ave., Cambridge 39, Mass. ADV. PG. 48, 49.
- Ⓟ HEWLETT-PACKARD CO., 395 Page Mill Rd., Palo Alto, Calif. ADV. PG. 33-36.
- Ⓟ HICKOK ELECTRICAL INSTRUMENT CO., 10514 Dupont Ave., Cleveland 8, Ohio. ADV. PG. 333.
- Ⓟ Ionic Electronic Equipment Co., 1705 N. Kenmore, Los Angeles 27, Calif.
- Ⓟ Jackson Electrical Instrument Co., 16 S. Patterson Blvd., Dayton 1, Ohio.
- Ⓟ KAY ELECTRIC CO., 14 Maple Ave., Pine Brook, N. J. ADV. PG. 340.
- Ⓟ KROHN-HITE INSTRUMENT CO., 580 Massachusetts Ave., Cambridge 39, Mass. ADV. PG. 43.
- Ⓟ MARCONI INSTRUMENTS, LTD., 23 Beaver St., New York 4, N. Y. ADV. PG. 270.
- Ⓟ MEASUREMENTS CORP., Boonton, N. J. ADV. PG. 99.
- Ⓟ McMurdo Silver Co., Inc., 473 Lafayette St., New York, N. Y.
- Ⓟ Philco Corp., Tioga & C Sts., Philadelphia 34, Pa.
- Ⓟ Phillips Petroleum Co., Market Development Div., Bartlesville, Okla.
- Ⓟ RAHM INSTRUMENTS, INC., 12 W. Broadway, New York 7, N. Y. ADV. PG. 354.
- Ⓟ SERVO CORP. OF AMERICA, 20-20 Jericho Turnpike, New Hyde Park, N. Y. ADV. PG. 150, 151.
- Ⓟ Short Wave Plastic Forming Co., 2921 W. Alameda St., Burbank, Calif.
- Ⓟ Southwestern Industrial Electronics Co., 2831 Post Oak Rd., P. O. Box 13058, Houston 19, Texas.
- Ⓟ SPERRY GYROSCOPE CO., Div. of The Sperry Corp., Great Neck, N. Y. ADV. PG. 103, 104.
- Ⓟ SYLVANIA ELECTRIC PRODUCTS, INC., 1740 Broadway, New York 19, N. Y. ADV. PG. 432-436.
- Ⓟ Tektronix, Inc., 712 S. E. Hawthorne Blvd., Portland 14, Ore.
- Ⓟ Thordarson-Meissner Mfg. Divs., 500 W. Huron St., Chicago 10, Ill.
- Ⓟ Tocco Division, Ohio Crankshaft Co., 3800 Harvard Ave., Cleveland 1, Ohio.
- Ⓟ Waveforms, Inc., 333 Sixth Ave., New York 14, N. Y.
- Ⓟ Weltronic Co., 19500 W. Eight Mile Rd., Detroit 19, Mich.
- Ⓟ WESTINGHOUSE ELECTRIC CORP., 511 Wood St., P. O. Box 868, Pittsburgh 30, Pa. ADV. PG. 107-113.
- Ⓟ Woodwelding, Inc., 3000 W. Olive Ave., Burbank, Calif.

GENERATORS—Electronic Wave

- Ⓟ AIRMEC LABORATORIES LTD., 366 Madison Ave., New York 17, N. Y. ADV. PG. 336.
- Ⓟ Barker & Williamson, 235 Fairfield Ave., Upper Darby, Pa. ADV. PG. 292.
- Ⓟ Berkshire Laboratories, 580 Lexington Rd., Concord, Mass.
- Ⓟ Doelcam Corp., 56 Elmwood St., Newton 58, Mass.
- Ⓟ GENERAL ELECTRIC CO., Electronics Dept., Electronics Park, Syracuse, N. Y. ADV. PG. 1 to 22.
- Ⓟ GENERAL RADIO CO., 275 Massachusetts Ave., Cambridge 39, Mass. ADV. PG. 48, 49.
- Ⓟ HEWLETT-PACKARD CO., 395 Page Mill Rd., Palo Alto, Calif. ADV. PG. 33-36.
- Ⓟ KAY ELECTRIC CO., 14 Maple Ave., Pine Brook, N. J. ADV. PG. 340.
- Ⓟ KROHN-HITE INSTRUMENT CO., 580 Massachusetts Ave., Cambridge 39, Mass. ADV. PG. 43.
- Ⓟ MARCONI INSTRUMENTS, LTD., 23 Beaver St., New York 4, N. Y. ADV. PG. 270.
- Ⓟ MEASUREMENTS CORP., Boonton, N. J. ADV. PG. 99.

- Ⓟ Philbrick Researches, Inc., George A., 230 Congress St., Boston 10, Mass.
- Ⓟ Southwestern Industrial Electronics Co., 2831 Post Oak Rd., P. O. Box 13058, Houston 19, Texas.
- Ⓟ SPERRY GYROSCOPE CO., Div. of The Sperry Corp., Great Neck, N. Y. ADV. PG. 103, 104.
- Ⓟ Thordarson-Meissner Mfg. Divs., 500 W. Huron St., Chicago 10, Ill.
- Ⓟ Varo Mfg. Co., Inc., Box 638, Garland, Texas.
- Ⓟ Wappler, Inc., 27 W. 24th St., New York 10, N. Y.
- Ⓟ Weltronic Co., 19500 W. Eight Mile Rd., Detroit 9, Mich.

GENERATORS—Gas-Engine Driven

- Ⓟ BOGUE ELECTRIC MFG. CO., 52 Iowa Ave., Paterson 3, N. J. ADV. PG. 155.
- Ⓟ Buda Co., The, Harvey, Ill.
- Ⓟ Century Electric Co., 1806 Pine St., St. Louis 3, Mo.
- Ⓟ Continental Electric Co., Inc., 334 Ferry St., Newark 5, N. J.
- Ⓟ Cyclohm Motor Corp. Div., Howard Industries, Inc., Racine, Wis.
- Ⓟ Electric Machinery Mfg. Co., 1331 N. E. Tyler St., Minneapolis 13, Minn.
- Ⓟ Electric Motor Corp., Div. Howard Industries, Inc., Racine, Wis.
- Ⓟ GENERAL ELECTRIC CO., Schenectady 5, N. Y. ADV. PG. 1 to 22.
- Ⓟ Georator Corp., 1820 N. Nash St., Arlington, Va.
- Ⓟ Homelite Corp., Port Chester, N. Y.
- Ⓟ Inet, Inc., 8655 S. Main St., Los Angeles 3, Calif.
- Ⓟ Kato Engineering Co., 1425 First Ave., Mankato, Minn.
- Ⓟ Leland Electric Co., The, 1501 Webster St., Dayton 1, Ohio.
- Ⓟ Midco Mfg. & Distributing Co., 607 8th St., Sheboygan, Wis.
- Ⓟ Motoresearch Co., 1600 Junction Ave., Racine, Wis.
- Ⓟ Onan & Sons, Inc., D. W., 3264 University Ave., SE, Minneapolis 14, Minn.
- Ⓟ Pioneer Electric Co., 3700 E. Olympic Blvd., Los Angeles 23, Calif.
- Ⓟ Ready Power Co., The Power Plant Div., 11231 Freud Ave., Detroit 14, Mich.

GENERATORS—Hand Driven

- Ⓟ Burke Electric Co., 12th & Cranberry Sts., Erie, Pa.
- Ⓟ Connecticut Telephone & Electric Corp., 70 Britannia St., Meriden, Conn.
- Ⓟ Continental Electric Co., Inc., 334 Ferry St., Newark 5, N. J.
- Ⓟ KELLOGG SWITCHBOARD & SUPPLY CO., 6650 S. Cicero Ave., Chicago 38, Ill. ADV. PG. 294.
- Ⓟ Welch Scientific Co., W. M., 1575 Sedgwick St., Chicago 10, Ill.

GENERATORS—Harmonic Frequency

- Ⓟ BARKER & WILLIAMSON, 235 Fairfield Ave., Upper Darby, Pa. ADV. PG. 292.
- Ⓟ Bassett, Inc., Rex, 307-11 N.W. First Ave., Fort Lauderdale, Fla.
- Ⓟ ELECTRONIC MEASUREMENTS COMPANY, Red Bank, N. J. ADV. PG. 312.
- Ⓟ GENERAL ELECTRIC CO., Schenectady 5, N. Y. ADV. PG. 1 to 22.
- Ⓟ Holtzer-Cabot Div. of National Pneumatic Co., Inc., 130 Amory St., Boston 19, Mass.
- Ⓟ KAY ELECTRIC CO., 14 Maple Ave., Pine Brook, N. J. ADV. PG. 340.
- Ⓟ LAVOIE LABORATORIES, Morganville, N. J. ADV. PG. 206.
- Ⓟ NORRMAN LABORATORIES, ERNST, Williams Bay, Wis. ADV. PG. 346.
- Ⓟ SERVO CORP. OF AMERICA, 20-20 Jericho Turnpike, New Hyde Park, N. Y. ADV. PG. 150, 151.
- Ⓟ Varo Mfg. Co., Inc., Box 638, Garland, Texas.

GENERATORS—High Frequency

- Ⓟ AIRMEC LABORATORIES LTD., 366 Madison Ave., New York 17, N. Y. ADV. PG. 336.
- Ⓟ Ajax Electrothermic Corp., Ajax Park, Trenton 5, N. J.
- Ⓟ Allis-Chalmers Mfg. Co., 935 South 70th St., Milwaukee 1, Wis.
- Ⓟ BRUSH DEVELOPMENT CO., 3405 Perkins Ave., Cleveland 14, Ohio. ADV. PG. 228, 229.
- Ⓟ DAVEN CO., 191 Central Ave., Newark 4, N. J. ADV. PG. 157.
- Ⓟ Ecco High Frequency Corp., 7020 Hudson Blvd., North Bergen, N. J.
- Ⓟ Electronic Engineering Corp., 469 Elm St., Arlington, N. J.
- Ⓟ FEDERAL MFG. & ENGR. CORP., 211 Steuben St., Brooklyn 5, N. Y. ADV. PG. 344.
- Ⓟ Gates Radio Co., Quincy, Ill.
- Ⓟ GENERAL ELECTRIC CO., Schenectady 5, N. Y. ADV. PG. 1 to 22.
- Ⓟ GENERAL ELECTRIC CO., Electronic Dept., Electronics Park, Syracuse, N. Y. ADV. PG. 1 to 22.
- Ⓟ GENERAL RADIO CO., 275 Massachusetts Ave., Cambridge 39, Mass. ADV. PG. 48, 49.
- Ⓟ Georator Corp., 1820 N. Nash St., Arlington, Va.
- Ⓟ Girdler Corp., 224 E. Broadway, Louisville 1, Ky.

V indicates . . . IN PRODUCTION • AVAILABILITY • UNRESTRICTED FOR GENERAL USE

- **HEWLETT-PACKARD CO.**, 395 Page Mill Rd., Palo Alto, Calif. ADV. PG. 33-36.
- **HICKOK ELECTRICAL INSTRUMENT CO.**, 10514 Dupont Ave., Cleveland 8, Ohio. ADV. PG. 333.
- **Holtzer-Cabot Div. of National Pneumatic Co., Inc.**, 130 Amory St., Boston 19, Mass.
- **Homelite Corp.**, Port Chester, N. Y.
- **Jackson Electrical Instrument Co.**, 16 S. Patterson Blvd., Dayton 1, Ohio.
- **Kato Engineering Co.**, 1415 First Ave., Mankato, Minn.
- **Leland Electric Co.**, The, 1501 Webster St., Dayton 1, Ohio.
- **MARCONI INSTRUMENTS, LTD.**, 23 Beaver St., New York 4, N. Y. ADV. PG. 270.
- **MEASUREMENTS CORP.**, Boonton, N. J. ADV. PG. 99.
- **Monarch Radio & Television Corp.**, 2430 Atlantic Ave., Brooklyn 33, N. Y.
- **RADIO CORP. OF AMERICA**, RCA Victor Div., General Offices, Camden, N. J. ADV. PG. 177, Inside Back & Back Covers.
- **RADIO RECEPTOR CO.**, 251 W. 19th St., New York 11, N. Y. ADV. PG. 250.
- **SERVO CORP. OF AMERICA**, 20-20 Jericho Turnpike, New Hyde Park, N. Y. ADV. PG. 150, 151.
- **Sherman Industrial Electronics Co., Inc.**, 505 Washington Ave., Belleville 9, N. J.
- **Short Wave Plastic Forming Co.**, 2921 W. Alameda St., Burbank, Calif.
- **Tocco Division, Ohio Crankshaft Co.**, 3800 Harvard Ave., Cleveland 1, Ohio.
- **Wampler, Inc.**, 27 W. 24th St., New York 10, N. Y.
- **Weltronic Co.**, 19500 W. Eight Mile Rd., Detroit 9, Mich.
- **WESTINGHOUSE ELECTRIC CORP.**, 511 Wood St., P. O. Box 868, Pittsburgh 30, Pa. ADV. PG. 107-113.
- **Woodwelding, Inc.**, 3000 W. Olive Ave., Burbank, Calif.

GENERATORS—Microwave

- **Airborne Instruments Lab., Inc.**, 160 Old Country Rd., Mineola, N. Y.
- **AMERICA ELECTROENGINEERING CORP.**, 5025-29 W. Jefferson Blvd., Los Angeles 16, Calif. ADV. PG. 136.
- **BOONTON RADIO CORP.**, Boonton, N. J. ADV. PG. 96.
- **ELECTRONIC MEASUREMENTS COMPANY**, Red Bank, N. J. ADV. PG. 312.
- **FEDERAL MFG. & ENGR. CORP.**, 211 Steuben St., Brooklyn 5, N. Y. ADV. PG. 344.
- **HEWLETT-PACKARD CO.**, 395 Page Mill Rd., Palo Alto, Calif. ADV. PG. 33-36.
- **KINGS MICROWAVE CO., INC.**, 50 Marbledale Rd., Tuckahoe 7, N. Y. ADV. PG. 178, 179.
- **Leru Laboratories, Inc.**, 360 Bleecker St., New York 14, N. Y.
- **MARCONI INSTRUMENTS, LTD.**, 23 Beaver St., New York 4, N. Y. ADV. PG. 270.
- **Microwave Equipment Co., Inc.**, North Caldwell, N. J.
- **Network Mfg. Corp.**, Bayonne, N. J.
- **POLARAD ELECTRONICS CORP.**, 100 Metropolitan Ave., Brooklyn 11, N. Y. ADV. PG. 184, 185.
- **POLYTECHNIC RESEARCH & DEVELOPMENT CO., INC.**, 202 Tillary St., Brooklyn 1, N. Y. ADV. PG. 172, 173.
- **SHERRON ELECTRONICS CO.**, 1201 Flushing Ave., Brooklyn 6, N. Y. ADV. PG. 145.
- **SPERRY GYROSCOPE CO.**, Div. of The Sperry Corp., Great Neck, N. Y. ADV. PG. 103, 104.
- **Varian Associates**, 99 Washington St., San Carlos, Calif.
- **VECTRON, INC.**, 235 High St., Waltham, Mass. ADV. PG. 214.
- **Weymouth Instrument Co.**, 1440 Commercial St., East Weymouth 89, Mass.

GENERATORS—Motor

- **AIR ASSOCIATES, INC.**, Teterboro, N. J. ADV. PG. 211.
- **Allis-Chalmers Mfg. Co.**, 935 South 70th St., Milwaukee 1, Wis.
- **Allis Co., Louis**, 427 E. Stewart St., Milwaukee 7, Wis.
- **American Electric Motors, Inc.**, 4811 Telegraph Rd., Los Angeles, Calif.
- **Berndt-Bach, Inc.**, 7373 Beverly Blvd., Los Angeles 36, Calif.
- **Bludworth Marine Div., National-Simplex-Bludworth, Inc.**, 92 Gold St., New York 38, N. Y.
- **BOGUE ELECTRIC MFG. CO.**, 52 Iowa Ave., Paterson, N. J. ADV. PG. 155.
- **Burke Electric Co.**, 12th & Cranberry Sts., Erie, Pa.
- **CARTER MOTOR CO.**, 2646 Maplewood Ave., Chicago 47, Ill. ADV. PG. 322.
- **Century Electric Co.**, 1806 Pine St., St. Louis 3, Mo.
- **Continental Electric Co., Inc.**, 334 Ferry St., Newark 5, N. J.
- **Eastern Air Devices, Inc.**, 585 Dean St., Brooklyn 17, N. Y.

- **Ecco High Frequency Corp.**, 7020 Hudson Blvd., North Bergen, N. J.
- **Eicor, Inc.**, 1501 W. Congress St., Chicago 7, Ill.
- **Electric Machinery Mfg. Co.**, 1331 N. E. Tyler St., Minneapolis 13, Minn.
- **GENERAL ELECTRIC CO.**, Schenectady 5, N. Y. ADV. PG. 1 to 22.
- **Georator Corp.**, 1820 N. Nash St., Arlington, Va.
- **Gothard Mfg. Co.**, 2110 Clear Lake Ave., Springfield, Ill.
- **Great Lakes Electric Mfg. Co.**, 17 S. Desplaines St., Chicago 6, Ill.
- **Holtzer-Cabot Div. of National Pneumatic Co., Inc.**, 130 Amory St., Boston 19, Mass.
- **Janette Mfg. Co.**, 556 W. Monroe St., Chicago 6, Ill.
- **Kato Engineering Co.**, 1415 First Ave., Mankato, Minn.
- **Lear, Inc.**, 110 Ionia Ave., N. W., Grand Rapids 2, Mich.
- **Leland Electric Co., The**, 1501 Webster St., Dayton 1, Ohio.
- **Motorresearch Co.**, 1600 Junction Ave., Racine, Wis.
- **Onan & Sons Inc.**, D. W., 3264 University Ave. SE, Minneapolis 14, Minn.
- **Pioneer Electric Co.**, 3700 E. Olympic Blvd., Los Angeles 23, Calif.
- **Rae Motor Corp.**, Box 291, Racine, Wis.
- **RED BANK DIVISION**, Bendix Aviation Corp., Red Bank, N. J. ADV. PG. 197.
- **Redmond Co., Inc.**, Owosso, Mich.
- **REEVES INSTRUMENT CORP.**, 215 E. 91st St., New York, N. Y. ADV. PG. 315.
- **Small Motors, Inc.**, 2076 Elston Ave., Chicago 14, Ill.
- **Star-Kimble Motor Div. of Miehle Prntg. Press & Mfg. Co.**, 200 Bloomfield Ave., Bloomfield, N. J.
- **Tocco Division, Ohio Crankshaft Co.**, 3800 Harvard Ave., Cleveland 1, Ohio.
- **WESTINGHOUSE ELECTRIC CORP.**, 511 Wood St., P. O. Box 868, Pittsburgh 30, Pa. ADV. PG. 107-113.

GENERATORS—Picture Signal

- **DuMont Laboratories, Inc.**, Allen B., Television Transmitter Div., 1000 Main Ave., Clifton, N. J.
- **POLARAD ELECTRONICS CORP.**, 100 Metropolitan Ave., Brooklyn 11, N. Y. ADV. PG. 184, 185.
- **RADIO CORP. OF AMERICA**, RCA Victor Div., General Offices, Camden, N. J. ADV. PG. 177, Inside Back & Back Cover.
- **Telegrip Radio Co.**, 2559 W. 21st St., Chicago 8, Ill.

GENERATORS—Pulse

- **ATOMIC INSTRUMENT CO.**, 84 Massachusetts Ave., Cambridge 39, Mass. ADV. PG. 410.
- **BARKER & WILLIAMSON**, 235 Fairfield Ave., Upper Darby, Pa. ADV. PG. 292.
- **Berkeley Scientific Corp.**, 2200 Wright Ave., Richmond, Calif.
- **Berkshire Laboratories**, 580 Lexington Rd., Concord, Mass.
- **Condor Radio Mfg. Co.**, 631 Whipple, Prescott, Ariz.
- **Davies Laboratories, Inc.**, 4705 Queensbury Rd., Riverdale, Md.
- **ELECTRONIC MEASUREMENTS COMPANY**, Red Bank, N. J. ADV. PG. 312.
- **EL-TRONICS INC.**, 2649 N. Howard St., Philadelphia 33, Pa. ADV. PG. 299.
- **Empire Devices, Inc.**, 38-25 Bell Blvd., Bayside, N. Y.
- **Flader, Inc., Fredric**, 1330 Laskey Rd., Toledo 12, Ohio.
- **GENERAL ELECTRIC CO.**, Schenectady 5, N. Y. ADV. PG. 1 to 22.
- **GENERAL RADIO CO.**, 275 Massachusetts Ave., Cambridge 39, Mass. ADV. PG. 48, 49.
- **HICKOK ELECTRICAL INSTRUMENT CO.**, 10514 Dupont Ave., Cleveland 8, Ohio. ADV. PG. 333.
- **Ionic Electronic Equipment Co.**, 1705 N. Kenmore, Los Angeles 27, Calif.
- **KAY ELECTRIC CO.**, 14 Maple Ave., Pine Brook, N. J. ADV. PG. 340.
- **LAVOIE LABORATORIES**, Morganville, N. J. ADV. PG. 206.
- **Loral Electronics Corp.**, 794 E. 140th St., New York 54, N. Y.
- **Manson Laboratories**, 76 Stage St., Stamford, Conn.
- **MEASUREMENTS CORP.**, Boonton, N. J. ADV. PG. 99.
- **Nuclear Instrument & Chemical Corp.**, 223 W. Erie St., Chicago 10, Ill.
- **Nuclear Research Corp.**, 2707 Federal St., Philadelphia 46, Pa.
- **POTTER INSTRUMENT CO., INC.**, 115 Cutter Mill Rd., Great Neck, N. Y. ADV. PG. 318.
- **Radar Engineers**, 110 University St., Seattle 1, Wash.
- **SERVO CORP. OF AMERICA**, 20-20 Jericho Turnpike, New Hyde Park, N. Y. ADV. PG. 150, 151.
- **TELETRONICS LABORATORY, INC.**, 352 Maple Ave., Westbury, N. Y. ADV. PG. 418.
- **Walkirt Co.**, 5808 Marilyn Ave., Culver City, Calif.
- **Waveforms, Inc.**, 333 Sixth Ave., New York 14, N. Y.
- **WESTINGHOUSE ELECTRIC CORP.**, 511 Wood St., P. O. Box 868, Pittsburgh 30, Pa. ADV. PG. 107-113.
- **Wilmette Inc.**, Raymond M., 1469 Church St., N. W., Washington 5, D. C.

GENERATORS—Square Wave

- **AIRMEC LABORATORIES LTD.**, 366 Madison Ave., New York 17, N. Y. ADV. PG. 336.
- **BARKER & WILLIAMSON**, 235 Fairfield Ave., Upper Darby, Pa. ADV. PG. 292.
- **Central Scientific Co.**, 1700 Irving Park Rd., Chicago 13, Ill.
- **Condor Mfg. Co.**, 631 Whipple, Prescott, Ariz.
- **DuMont Laboratories, Inc.**, Allen B., Instrument Div., 1000 Main Ave., Clifton, N. J.
- **Electro-Mechanical Research, Inc.**, Ridgefield, Conn.
- **ELECTRONIC MEASUREMENTS COMPANY**, Red Bank, N. J. ADV. PG. 312.
- **EL-TRONICS, INC.**, 2649 N. Howard St., Philadelphia 33, Pa. ADV. PG. 299.
- **Flader Inc., Fredric**, 1330 Laskey Rd., Toledo 12, Ohio.
- **GENERAL ELECTRIC CO.**, Electronics Dept., Electronics Park, Syracuse, N. Y. ADV. PG. 1 to 22.
- **KAY ELECTRIC CO.**, 14 Maple Ave., Pine Brook, N. J. ADV. PG. 340.
- **Loral Electronics Corp.**, 794 E. 140th St., New York 54, N. Y.
- **MARCONI INSTRUMENTS, LTD.**, 23 Beaver St., New York 4, N. Y. ADV. PG. 270.
- **MEASUREMENTS CORP.**, Boonton, N. J. ADV. PG. 99.
- **Nuclear Research Corp.**, 2707 Federal St., Philadelphia 46, Pa.
- **Philbrick Researches, Inc.**, George A., 230 Congress St., Boston 10, Mass.
- **Radio City Products Co., Inc.**, 152 W. 25th St., New York 1, N. Y.
- **Reiner Electronics Co.**, 152 W. 25th St., New York, N. Y.
- **SHERRON ELECTRONICS CO.**, 1201 Flushing Ave., Brooklyn 6, N. Y. ADV. PG. 145.
- **SPERRY GYROSCOPE CO.**, Div. of The Sperry Corp., Great Neck, N. Y. ADV. PG. 103, 104.
- **Tektronix, Inc.**, 712 S. E. Hawthorne Blvd., Portland 14, Ore.
- **Triumph Mfg. Co.**, 913 W. Van Buren St., Chicago 7, Ill.
- **Walkirt Co.**, 5808 Marilyn Ave., Culver City, Calif.
- **Waveforms, Inc.**, 333 Sixth Ave., New York 14, N. Y.

GENERATORS—Ultrasonic

- **AIRMEC LABORATORIES LTD.**, 366 Madison Ave., New York 17, N. Y. ADV. PG. 336.
- **Andersen Laboratories, Inc.**, 39 Talcott Rd., West Hartford, Conn.
- **BOONTON RADIO CORP.**, Boonton, N. J. ADV. PG. 96.
- **BRUSH DEVELOPMENT CO.**, 3405 Perkins Ave., Cleveland 14, Ohio. ADV. PG. 228, 229.
- **CLARK CRYSTAL CO.**, 2 Farm Rd., Marlboro, Mass. ADV. PG. 366.
- **Crystal Research Labs., Inc.**, 29 Allyn St., Hartford, Conn.
- **Dallons Labs.**, 5066 Santa Monica Blvd., Los Angeles, Calif.
- **Edo Corp.**, College Point, N. Y.
- **Flader, Inc., Fredric**, 1330 Laskey Rd., Toledo 12, Ohio.
- **GENERAL ELECTRIC CO.**, Schenectady 5, N. Y. ADV. PG. 1 to 22.
- **GENERAL PRECISION LAB., INC.**, Pleasantville, N. Y. ADV. PG. 58, 59.
- **GENERAL RADIO CO.**, 275 Massachusetts Ave., Cambridge 39, Mass. ADV. PG. 48, 49.
- **Glenco Corp., Metuchen, N. J.**
- **Gulton Mfg. Corp., Metuchen, N. J.**
- **Loral Electronics Corp.**, 794 E. 140th St., New York 54, N. Y.
- **Piezo Products Co.**, Whitney St., Framingham, Mass.
- **Scott, Inc., Hermon Hosmer**, 385 Putnam Ave., Cambridge 39, Mass.
- **Southwestern Industrial Electronics Co.**, 2831 Post Oak Rd., P. O. Box 13058, Houston 19, Texas.
- **Valpey Crystals, Highland St.**, Holliston, Mass.
- **Waveforms, Inc.**, 333 Sixth Ave., New York 14, N. Y.
- **Westline Electronics Co.**, 11660 Olympic Blvd., Los Angeles 25, Calif.

GENERATORS—Winddriven Generating Equipment

- **Kato Engineering Co.**, 1415 First Ave., Mankato, Minn.
- **Wincharger Corp.**, E. 7th & Division Sts., Sioux City, Iowa.
- **Wind Turbine Co., Tower & Antenna Div.**, E. Market St. & Penna. R., West Chester, Pa.

GENERATORS, SIGNAL—a-f

- **AIRMEC LABORATORIES LTD.**, 366 Madison Ave., New York 17, N. Y. ADV. PG. 336.
- **Altec Lansing Corp.**, 9356 Santa Monica Blvd., Beverly Hills, Calif.
- **AMERICAN ELECTROENGINEERING CO.**, 5025-29 W. Jefferson Blvd., Los Angeles 16, Calif. ADV. PG. 136.
- **AMERICAN TIME PRODUCTS, INC.**, 580 Fifth Ave., New York 19, N. Y. ADV. PG. 226.

V indicates . . . **IN PRODUCTION • AVAILABILITY • UNRESTRICTED FOR GENERAL USE**

- Approved Electronic Instrument Corp., 146 Liberty St., New York 6, N. Y.
- BARKER & WILLIAMSON**, 235 Fairfield Ave., Upper Darby, Pa. ADV. PG. 292.
- Clough Brengle Co., 6014 N. Broadway, Chicago, Ill.
- DAVEN CO.**, 191 Central Ave., Newark 4, N. J. ADV. PG. 157.
- ELECTRONIC INSTRUMENT CO., INC.**, 276 Newport St., Brooklyn 12, N. Y. ADV. PG. 129.
- ELECTRONIC MEASUREMENTS COMPANY**, Red Bank, N. J. ADV. PG. 99.
- EL-TRONICS, INC.**, 2649 N. Howard St., Philadelphia 33, Pa. ADV. PG. 299.
- Gaveco Labs., Inc., 2 East End Ave., New York 21, N. Y.
- GENERAL RADIO CO.**, 275 Massachusetts Ave., Cambridge 39, Mass. ADV. PG. 48, 49.
- HEATH CO.**, Benton Harbor, Mich. ADV. PG. 264.
- HEWLETT-PACKARD CO.**, 395 Page Mill Rd., Palo Alto, Calif. ADV. PG. 33-36.
- HICKOK ELECTRICAL INSTRUMENT CO.**, 10514 Dupont Ave., Cleveland 8, Ohio. ADV. PG. 333.
- Jackson Electrical Instrument Co., 16 S. Patterson Blvd., Dayton 1, Ohio.
- Loral Electronics Corp., 794 E. 140th St., New York 54, N. Y.
- MARCONI INSTRUMENTS, LTD.**, 23 Beaver St., New York 4, N. Y. ADV. PG. 270.
- McMurdo Silver Co., Inc., 473 Lafayette St., New York, N. Y.
- MEASUREMENTS CORP.**, Boonton, N. J. ADV. PG. 99.
- Metropolitan Electronics & Instruments Co., 106 Fifth Ave., New York 11, N. Y.
- Monarch Radio & Television Corp., 2430 Atlantic Ave., Brooklyn 33, N. Y.
- Muirhead & Co., Ltd., Beckenham-Kent-England.
- Oak Ridge Products Mfg. Div. of Video Television Inc., 37-01 Vernon Blvd., Long Island City 1, N. Y.
- Philbrick Researches Inc., George A., 230 Congress St., Boston 10, Mass.
- Radioactive Products, Inc., 443 W. Congress St., Detroit 26, Mich.
- Shevers, Inc., Harold, 123 W. 64th St., New York 23, N. Y.
- Simpson Electric Co., Div. of American Gage & Machine Co., 5218 W. Kinzie St., Chicago 44, Ill.
- Southwestern Industrial Electronics Co., 2831 Post Oak Rd., P.O. Box 13058, Houston 19, Texas.
- Standard Telephones & Cables Ltd., Connaught House, Aldwych, London, W. C. 2, England.
- Supreme, Inc., Greenwood, Miss.
- SYLVANIA ELECTRIC PRODUCTS, INC.**, 1740 Broadway, New York 19, N. Y. ADV. PG. 432-436.
- Thordarson-Meissner Mfg. Divs., 500 W. Huron St., Chicago 10, Ill.
- TRAD TELEVISION CORP.**, 1001 First Ave., Asbury Park, N. J. ADV. PG. 355.
- Triumph Mfg. Co., 913 Van Buren St., Chicago 7, Ill.
- Waveforms, Inc., 333 Sixth Ave., New York 14, N. Y.

GENERATORS, SIGNAL—f-m

- Approved Electronic Instrument Corp., 146 Liberty St., New York 6, N. Y.
- BOONTON RADIO CORP.**, Boonton, N. J. ADV. PG. 96.
- DAVEN CO.**, 191 Central Ave., Newark 4, N. J. ADV. PG. 157.
- ELECTRONIC INSTRUMENT CO., INC.**, 276 Newport St., Brooklyn 12, N. Y. ADV. PG. 129.
- Ferris Instrument Co., 110 Cornelia St., Boonton, N. J.
- Gaveco Labs., Inc., 2 East End Ave., New York 21, N. Y.
- GENERAL ELECTRIC CO.**, Electronics Dept., Electronics Park, Syracuse, N. Y. ADV. PG. 1 to 22.
- GENERAL RADIO CO.**, 275 Massachusetts Ave., Cambridge 39, Mass. ADV. PG. 48, 49.
- HICKOK ELECTRICAL INSTRUMENT CO.**, 10514 Dupont Ave., Cleveland 8, Ohio. ADV. PG. 333.
- Jackson Electrical Instrument Co., 16 S. Patterson Blvd., Dayton 1, Ohio.
- KAY ELECTRIC CO.**, 14 Maple Ave., Pine Brook, N. J. ADV. PG. 340.
- Magna Electronics Co., 3707-11 W. Jefferson Blvd., Los Angeles 16, Calif.
- MARCONI INSTRUMENTS, LTD.**, 23 Beaver St., New York 4, N. Y. ADV. PG. 270.
- McMurdo Silver Co., Inc., 473 Lafayette St., New York, N. Y.
- MEASUREMENTS CORP.**, Boonton, N. J. ADV. PG. 99.
- Metropolitan Electronics & Instruments Co., 106 Fifth Ave., New York 11, N. Y.
- Monarch Radio & Television Corp., 2430 Atlantic Ave., Brooklyn 33, N. Y.
- New London Instrument Co., Box 189, New London, Conn.
- Philco Corp., Tioga & C Sts., Philadelphia 34, Pa. Precision Apparatus Co., Inc., 92-27 Horace Harding Blvd., Elmhurst, N. Y.
- RADIO CORP. OF AMERICA**, Tube Dept., Harrison, N. J. ADV. PG. 177, Inside Back & Back Covers.

- Simpson Electric Co., Div. of American Gage & Machine Co., 5218 W. Kinzie St., Chicago 44, Ill.
- SPERRY GYROSCOPE CO.**, Div. of The Sperry Corp., Great Neck, N. Y. ADV. PG. 103, 104.
- Supreme, Inc., Greenwood, Miss.
- SYLVANIA ELECTRIC PRODUCTS, INC.**, 1740 Broadway, New York 19, N. Y. ADV. PG. 432-436.
- TRAD TELEVISION CORP.**, 1001 First Ave., Asbury Park, N. J. ADV. PG. 355.

GENERATORS, SIGNAL—r-f

- AIRMEC LABORATORIES LTD.**, 366 Madison Ave., New York 17, N. Y. ADV. PG. 336.
- AMERICAN ELECTROENGINEERING CO.**, 5025-29 W. Jefferson Blvd., Los Angeles 16, Calif. ADV. PG. 136.
- Approved Electronic Instrument Corp., 146 Liberty St., New York 6, N. Y.
- BARKER & WILLIAMSON**, 235 Fairfield Ave., Upper Darby, Pa. ADV. PG. 292.
- Bassett, Inc., Rex, 307-11 N.W. First Ave., Fort Lauderdale, Fla.
- BOONTON RADIO CORP.**, Boonton, N. J. ADV. PG. 96.
- Clough Brengle Co., 6014 N. Broadway, Chicago, Ill.
- DAVEN CO.**, 191 Central Ave., Newark 4, N. J. ADV. PG. 157.
- ELECTRONIC INSTRUMENT CO., INC.**, 276 Newport St., Brooklyn 12, N. Y. ADV. PG. 129.
- ELECTRONIC MEASUREMENTS COMPANY**, Red Bank, N. J. ADV. PG. 312.
- FEDERAL MFG. & ENGR. CORP.**, 211 Steuben St., Brooklyn 5, N. Y. ADV. PG. 344.
- Ferris Instrument Co., 110 Cornelia St., Boonton, N. J.
- Gaveco Labs., Inc., 2 East End Ave., New York 21, N. Y.
- General Communication Co., 530 Commonwealth Ave., Boston 15, Mass.
- GENERAL ELECTRIC CO.**, Electronics Dept., Electronics Park, Syracuse, N. Y. ADV. PG. 1 to 22.
- GENERAL RADIO CO.**, 275 Massachusetts Ave., Cambridge 39, Mass. ADV. PG. 48, 49.
- HEATH CO.**, Benton Harbor, Mich. ADV. PG. 264.
- HEWLETT-PACKARD CO.**, 395 Page Mill Rd., Palo Alto, Calif. ADV. PG. 33-36.
- HICKOK ELECTRICAL INSTRUMENT CO.**, 10514 Dupont Ave., Cleveland 8, Ohio. ADV. PG. 333.
- Jackson Electrical Instrument Co., 16 S. Patterson Blvd., Dayton 1, Ohio.
- KAY ELECTRIC CO.**, 14 Maple Ave., Pine Brook, N. J. ADV. PG. 340.
- McMurdo Silver Co., Inc., 473 Lafayette St., New York, N. Y.
- MARCONI INSTRUMENTS, LTD.**, 23 Beaver St., New York 4, N. Y. ADV. PG. 270.
- MEASUREMENTS CORP.**, Boonton, N. J. ADV. PG. 99.
- Metropolitan Electronics & Instruments Co., 106 Fifth Ave., New York 11, N. Y.
- Monarch Radio & Television Corp., 2430 Atlantic Ave., Brooklyn 33, N. Y.
- Oak Ridge Products Mfg. Div. of Video Television Inc., 37-01 Vernon Blvd., Long Island City 1, N. Y.
- Philco Corp., Tioga & C Sts., Philadelphia 34, Pa. Precision Apparatus Co., Inc., 92-27 Horace Harding Blvd., Elmhurst, N. Y.
- Radioactive Products, Inc., 443 W. Congress St., Detroit 26, Mich.
- Radio City Products Co., Inc., 152 W. 25th St., New York, N. Y.
- RADIO CORP. OF AMERICA**, Tube Dept., Harrison, N. J. ADV. PG. 177, Inside Back & Back Covers.
- Rollin Co., 2070 N. Fair Oaks Ave., Pasadena 3, Calif.
- SERVO CORP. OF AMERICA**, 20-20 Jericho Turnpike, New Hyde Park, N. Y. ADV. PG. 150, 151.
- Shevers, Inc., Harold, 123 W. 64th St., New York 23, N. Y.
- Simpson Electric Co., Div. of American Gage & Machine Co., 5218 W. Kinzie St., Chicago 44, Ill.
- Standard Telephones & Cables Ltd., Connaught House, Aldwych, London, W. C. 2, England.
- Supreme, Inc., Greenwood, Miss.
- SYLVANIA ELECTRIC PRODUCTS, INC.**, 1740 Broadway, New York 19, N. Y. ADV. PG. 432-436.
- Thordarson-Meissner Mfg. Divs., 500 W. Huron St., Chicago 10, Ill.
- TRAD TELEVISION CORP.**, 1001 First Ave., Asbury Park, N. J. ADV. PG. 355.
- Transvision, Inc., 460 North Ave., New Rochelle, N. Y.
- Triumph Mfg. Co., 913 W. Van Buren St., Chicago 7, Ill.
- Westline Electronics Co., 11660 Olympic Blvd., Los Angeles 25, Calif.

GENERATORS, SIGNAL—shf

- AIRMEC LABORATORIES LTD.**, 366 Madison Ave., New York 17, N. Y. ADV. PG. 336.
- AMERICAN ELECTROENGINEERING CO.**, 5025-29 W. Jefferson Blvd., Los Angeles 16, Calif. ADV. PG. 136.
- BARKER & WILLIAMSON**, 235 Fairfield Ave., Upper Darby, Pa. ADV. PG. 292.

- BOONTON RADIO CORP.**, Boonton, N. J. ADV. PG. 96.
- HEWLETT-PACKARD CO.**, 395 Page Mill Rd., Palo Alto, Calif. ADV. PG. 33-36.
- KAY ELECTRIC CO.**, 14 Maple Ave., Pine Brook, N. J. ADV. PG. 340.
- Loral Electronics Corp., 794 E. 140th St., New York 54, N. Y.
- MARCONI INSTRUMENTS, LTD.**, 23 Beaver St., New York 4, N. Y. ADV. PG. 270.
- Metropolitan Electronics & Instruments Co., 106 Fifth Ave., New York 11, N. Y.
- SPERRY GYROSCOPE CO.**, Div. of The Sperry Corp., Great Neck, N. Y. ADV. PG. 103, 104.
- Thordarson-Meissner Mfg. Divs., 500 W. Huron St., Chicago 10, Ill.
- TRAD TELEVISION CORP.**, 1001 First Ave., Asbury Park, N. J. ADV. PG. 355.
- Wheeler Laboratories, Inc., Great Neck, N. Y.

GENERATORS, SIGNAL—Sweeping

- Approved Electronic Instrument Corp., 146 Liberty St., New York 6, N. Y.
- Clough Brengle Co., 6014 N. Broadway, Chicago, Ill.
- Cossor (Canada) Ltd., 301-303 Windsor St., Halifax, N. S., Canada.
- ELECTRONIC INSTRUMENT CO., INC.**, 276 Newport St., Brooklyn 12, N. Y. ADV. PG. 129.
- EL-TRONICS, INC.**, 2649 N. Howard St., Philadelphia 33, Pa. ADV. PG. 299.
- GENERAL ELECTRIC CO.**, Electronics Dept., Electronics Park, Syracuse, N. Y. ADV. PG. 1 to 22.
- Jackson Electrical Instrument Co., 16 S. Patterson Blvd., Dayton 1, Ohio.
- KAY ELECTRIC CO.**, 14 Maple Ave., Pine Brook, N. J. ADV. PG. 340.
- McMurdo Silver Co., Inc., 473 Lafayette St., New York, N. Y.
- Manufacturers Engineering & Equipment Corp., Willow Grove, Pa.
- MARCONI INSTRUMENTS, LTD.**, 23 Beaver St., New York 4, N. Y. ADV. PG. 270.
- Metropolitan Electronics & Instruments Co., 106 Fifth Ave., New York 11, N. Y.
- Monarch Radio & Television Corp., 2430 Atlantic Ave., Brooklyn 33, N. Y.
- Philco Corp., Tioga & C Sts., Philadelphia 34, Pa.
- POLYTECHNIC RESEARCH & DEVELOPMENT CO., INC.**, 202 Tillary St., Brooklyn, N. Y. ADV. PG. 172, 173.
- Precision Apparatus Co., Inc., 92-27 Horace Harding Blvd., Elmhurst, N. Y.
- Radio City Products Co., Inc., 152 W. 25th St., New York 1, N. Y.
- RADIO CORP. OF AMERICA**, Tube Dept., Harrison, N. J. ADV. PG. 177, Inside Back & Back Covers.
- Simpson Electric Co., Div. of American Gage & Machine Co., 5218 W. Kinzie St., Chicago 44, Ill.
- SPERRY GYROSCOPE CO.**, Div. of The Sperry Corp., Great Neck, N. Y. ADV. PG. 103, 104.
- Supreme, Inc., Greenwood, Miss.
- SYLVANIA ELECTRIC PRODUCTS, INC.**, 1740 Broadway, New York 19, N. Y. ADV. PG. 432-436.
- Tel-Instrument Co., Inc., 50 Patterson Ave., East Rutherford, N. J.
- TRAD TELEVISION CORP.**, 1001 First Ave., Asbury Park, N. J. ADV. PG. 355.
- Triplett Electrical Instrument Co., Harmon Road, Bluffton, Ohio.

GENERATORS, SIGNAL—Television Synchronizing

- Fairchild Recording Equipment Co., 154th St. & Seventh Ave., Whitestone, N. Y.
- FEDERAL TELECOMMUNICATION LABS., INC.**, 500 Washington Ave., Nutley, N. J. ADV. PG. 164.
- GENERAL PRECISION LAB., INC.**, Pleasantville, N. Y. ADV. PG. 58, 59.
- HICKOK ELECTRICAL INSTRUMENT CO.**, 10514 Dupont Ave., Cleveland 8, Ohio. ADV. PG. 333.
- Jackson Electrical Instrument Co., 16 S. Patterson Blvd., Dayton 1, Ohio.
- MARCONI INSTRUMENTS, LTD.**, 23 Beaver St., New York 4, N. Y. ADV. PG. 270.
- MEASUREMENTS CORP.**, Boonton, N. J. ADV. PG. 99.
- Metropolitan Electronics & Instruments Co., 106 Fifth Ave., New York 11, N. Y.
- Oak Ridge Products Mfg. Div. of Video Television, Inc., 37-01 Vernon Blvd., Long Island City 1, N. Y.
- POLARAD ELECTRONICS CORP.**, 100 Metropolitan Ave., Brooklyn 11, N. Y. ADV. PG. 184, 185.
- Radio City Products Co., 152 W. 25th St., New York 1, N. Y.
- Simpson Electric Co., Div. of American Gage & Machine Co., 5218 W. Kinzie St., Chicago 44, Ill.
- Standard Telephones & Cables Ltd., Connaught House, Aldwych, London, W. C. 2, England.
- Supreme, Inc., Greenwood, Miss.
- Teletrome, Inc., 88 Merrick Rd., Amityville, N. Y.
- Teleguip Radio Co., 2559 W. 21st St., Chicago 8, Ill.
- Tel-Instrument Co., Inc., 50 Patterson Ave., East Rutherford, N. J.

Ⓜ indicates . . . IN PRODUCTION • AVAILABILITY • UNRESTRICTED FOR GENERAL USE

GENERATORS, SIGNAL—uhf

- Ⓜ Airborne Instruments Lab., Inc., 160 Old Century Rd., Mineola, N. Y.
- Ⓜ AIRCRAFT RADIO CORP., Boonton, N. J. ADV. PG. 400, 401.
- Ⓜ AIRMEC LABORATORIES LTD., 366 Madison Ave., New York 17, N. Y. ADV. PG. 336.
- Ⓜ AMERICAN ELECTROENGINEERING CO., 5025-29 W. Jefferson Blvd., Los Angeles 16, Calif. ADV. PG. 136.
- Ⓜ Approved Electronic Instrument Corp., 146 Liberty St., New York 6, N. Y.
- Ⓜ BOONTON RADIO CORP., Boonton, N. J. ADV. PG. 96.
- Ⓜ Electronic Associates, Inc., Long Branch, N. J.
- Ⓜ ELECTRONIC MEASUREMENTS COMPANY, Red Bank, N. J. ADV. PG. 312.
- Ⓜ Empire Devices, Inc., 38-25 Bell Blvd., Bayside, N. Y.
- Ⓜ FEDERAL MFG. & ENGR. CORP., 211 Steuben St., Brooklyn 5, N. Y. ADV. PG. 344.
- Ⓜ Ferris Instrument Co., 110 Cornelia St., Boonton, N. J.
- Ⓜ GENERAL ELECTRIC CO., Electronics Dept., Electronics Park, Syracuse, N. Y. ADV. PG. 1 to 22.
- Ⓜ GENERAL RADIO CO., 275 Massachusetts Ave., Cambridge 39, Mass. ADV. PG. 48, 49.
- Ⓜ HEWLETT-PACKARD CO., 395 Page Mill Rd., Palo Alto, Calif. ADV. PG. 33-36.
- Ⓜ HICKOK ELECTRICAL INSTRUMENT CO., 10514 Dupont Ave., Cleveland 8, Ohio. ADV. PG. 333.
- Ⓜ KAY ELECTRIC CO., 14 Maple Ave., Pine Brook, N. J. ADV. PG. 340.
- Ⓜ Loral Electronics Corp., 794 E. 140th St., New York 54, N. Y.
- Ⓜ McMurdo Silver Co., Inc., 473 Lafayette St., New York, N. Y.
- Ⓜ MARCONI INSTRUMENTS, LTD., 23 Beaver St., New York 4, N. Y. ADV. PG. 270.
- Ⓜ MEASUREMENTS CORP., Boonton, N. J. ADV. PG. 99.
- Ⓜ Metropolitan Electronics & Instruments Co., 106 Fifth Ave., New York 11, N. Y.
- Ⓜ POLYTECHNIC RESEARCH & DEVELOPMENT CO., INC., 202 Tillary St., Brooklyn 1, N. Y. ADV. PG. 172, 173.
- Ⓜ Radioactive Products, Inc., 443 W. Congress St., Detroit 26, Mich.
- Ⓜ Rollin Co., 2070 N. Fair Oaks Ave., Pasadena 3, Calif.
- Ⓜ SPERRY GYROSCOPE CO., Div. of The Sperry Corp., Great Neck, N. Y. ADV. PG. 103, 104.
- Ⓜ Standard Telephones & Cables Ltd., Connaught House, Aldwych, London, W. C. 2, England.
- Ⓜ TRAD TELEVISION CORP., 1001 First Ave., Asbury Park, N. J. ADV. PG. 355.
- Ⓜ Westline Electronics Co., 11660 Olympic Blvd., Los Angeles 25, Calif.

GENERATORS, SIGNAL—vhf

- Ⓜ Airborne Instruments Lab., Inc., 160 Old Country Road, Mineola, N. Y.
- Ⓜ AIRCRAFT RADIO CORP., Boonton, N. J. ADV. PG. 400, 401.
- Ⓜ AIRMEC LABORATORIES LTD., 366 Madison Ave., New York 17, N. Y. ADV. PG. 336.
- Ⓜ AMERICAN ELECTROENGINEERING CO., 5025-29 W. Jefferson Blvd., Los Angeles 16, Calif. ADV. PG. 136.
- Ⓜ BOONTON RADIO CORP., Boonton, N. J. ADV. PG. 96.
- Ⓜ ELECTRONIC MEASUREMENTS COMPANY, Red Bank, N. J. ADV. PG. 312.
- Ⓜ FEDERAL MFG. & ENGR. CORP., 211 Steuben St., Brooklyn 5, N. Y. ADV. PG. 344.
- Ⓜ Ferris Instrument Co., 110 Cornelia St., Boonton, N. J.
- Ⓜ GENERAL ELECTRIC CO., Electronics Dept., Electronics Park, Syracuse, N. Y. ADV. PG. 1 to 22.
- Ⓜ GENERAL RADIO CO., 275 Massachusetts Ave., Cambridge 39, Mass. ADV. PG. 48, 49.
- Ⓜ HEWLETT-PACKARD CO., 395 Page Mill Rd., Palo Alto, Calif. ADV. PG. 33-36.
- Ⓜ HICKOK ELECTRICAL INSTRUMENT CO., 10514 Dupont Ave., Cleveland 8, Ohio. ADV. PG. 333.
- Ⓜ Jackson Electrical Instrument Co., 16 S. Patterson Blvd., Dayton 1, Ohio.
- Ⓜ KAY ELECTRIC CO., 14 Maple Ave., Pine Brook, N. J. ADV. PG. 340.
- Ⓜ Loral Electronics Corp., 794 E. 140th St., New York 54, N. Y.
- Ⓜ MARCONI INSTRUMENTS, LTD., 23 Beaver St., New York 4, N. Y. ADV. PG. 270.
- Ⓜ McMurdo Silver Co., Inc., 473 Lafayette St., New York, N. Y.
- Ⓜ MEASUREMENTS CORP., Boonton, N. J. ADV. PG. 99.
- Ⓜ Metropolitan Electronics & Instruments Co., 106 Fifth Ave., New York 11, N. Y.
- Ⓜ Philco Corp., Tioga & C Sts., Philadelphia 34, Pa.
- Ⓜ POLYTECHNIC RESEARCH & DEVELOPMENT CO., INC., 202 Tillary St., Brooklyn 1, N. Y. ADV. PG. 172, 173.
- Ⓜ Radioactive Products, Inc., 443 W. Congress St., Detroit 26, Mich.
- Ⓜ Rollin Co., 2070 N. Fair Oaks Ave., Pasadena 3, Calif.
- Ⓜ Standard Telephones & Cables Ltd., Connaught House, Aldwych, London, W. C. 2, England.
- Ⓜ Supreme, Inc., Greenwood, Miss.

- Ⓜ Tel-Instrument Co., Inc., 50 Patterson Ave., East Rutherford, N. J.
- Ⓜ TRAD TELEVISION CORP., 1001 First Ave., Asbury Park, N. J. ADV. PG. 355.
- Ⓜ West Coast Electronics Co., 1601 S. Burlington St., Los Angeles 6, Calif.
- Ⓜ Westline Electronics Co., 11660 Olympic Blvd., Los Angeles 25, Calif.

GEOPHYSICAL APPARATUS

- Ⓜ BARKER & WILLIAMSON, 235 Fairfield Ave., Upper Darby, Pa. ADV. PG. 292.
- Ⓜ Bludworth Marine Div., National-Simplex-Bludworth, Inc., 92 Gold St., New York 38, N. Y.
- Ⓜ Century Geophysical Corp., 1333 N. Utica, Tulsa 3, Oklahoma.
- Ⓜ Engineering Lab., Inc., 602 E. 4th St., Tulsa 3, Okla.
- Ⓜ Engineering Research Corp., Shreveport, La.
- Ⓜ Geotronic Labs., Inc., Dallas 8, Texas.
- Ⓜ Georator Corp., 1820 N. Nash St., Arlington, Va.
- Ⓜ HEILAND RESEARCH CORP., 130 E. Fifth Ave., Denver 9, Colo. ADV. PG. 401.
- Ⓜ KAY ELECTRIC CO., 14 Maple Ave., Pine Brook, N. J. ADV. PG. 340.
- Ⓜ KROHN-HITE INSTRUMENT CO., 580 Massachusetts Ave., Cambridge 39, Mass. ADV. PG. 43.
- Ⓜ ORTHON CORP., 196 Albion Ave., Paterson 2, N. J. ADV. PG. 156.
- Ⓜ Post & Co., Frederick, 3650 N. Avondale Ave., P. O. Box 803, Chicago 90, Ill.
- Ⓜ SERVOMECHANISMS, INC., Whaleneck Rd. & Stewart Ave., Westbury, L. I., N. Y. ADV. PG. 188.
- Ⓜ Southwestern Industrial Electronics Co., 2831 Post Oak Rd., P. O. Box 13058, Houston 19, Texas.
- Ⓜ Varo Mfg. Co., Inc., Box 638, Garland, Texas.

GETTERS

See Tube Parts

GLASS

See Insulation Materials

GLASS BONDED MICA

See Insulation Materials

GLASS FIBRE

See Insulation Materials

GLASS—Metal-to-Glass Seals

See SEALS—Metal-to-Glass

GRAPHIC RECORDING INSTRUMENTS

See Instruments, Graphic Recording

GRAPHITE—Colloidal

- Ⓜ Acheson Colloids Corp., Port Huron, Mich.
- Ⓜ Dixon Crucible Co., Joseph, Jersey City 3, N. J.
- Ⓜ General Cement Mfg. Co., 919 Taylor Ave., Rockford, Ill.
- Ⓜ Grafo Colloids Corp., Sharon, Pa.
- Ⓜ Superior Flake Graphite Co., 33 S. Clark St., Chicago 3, Ill.

GRIDS AND GRID SUPPORTS

See Tube Parts

GRILLES—Metal

- Ⓜ ABALON PRECISION MFG. CORP., 540 Casanova St., Bronx 59, N. Y. ADV. PG. 348.
- Ⓜ Acklin Stamping Co., 1923 Nebraska Ave., Toledo 7, Ohio.
- Ⓜ Bestcraft Products, 626 Broadway, New York, N. Y.
- Ⓜ Bud Radio Inc., 2118 E. 55th St., Cleveland 3, Ohio.
- Ⓜ Chase Brass & Copper Co., Inc., 236 Grand St., Waterbury 20, Conn.
- Ⓜ Colgate Mfg. Corp., Lindenhurst, N. Y.
- Ⓜ Croname, Inc., 3701 Ravenswood Ave., Chicago, Ill.
- Ⓜ Donnelly Electric & Mfg. Co., 3050 Washington St., Boston 19, Mass.
- Ⓜ Etched Products Corp., 39-01 Queens Blvd., Long Island City, N. Y.
- Ⓜ FLOCK PROCESS CO., INC., 28 Fahey St., Springdale, Conn. ADV. PG. 196.
- Ⓜ General Cement Mfg. Co., 919 Taylor Ave., Rockford, Ill.
- Ⓜ Harrington & King Perforating Co., 5655 Fillmore St., Chicago 44, Ill.
- Ⓜ Schott Co., Walter L., 3225 Exposition Pl., Los Angeles 18, Calif.
- Ⓜ YORK CO., INC., OTTO H., 69 Glenwood Place, East Orange, N. J. ADV. PG. 174.

GRILLES—Molded Plastic

- Ⓜ American Insulator Corp., New Freedom, Pa.
- Ⓜ EMELOID CO., INC., THE, 1239 Central Ave., Hillside 5, N. J. ADV. PG. 102.
- Ⓜ ERIE RESISTOR CORP., 644 W. 12th St., Erie, Pa. ADV. PG. 91.
- Ⓜ Felsenthal & Sons, Inc., G., 4100 W. Grand Ave., Chicago 51, Ill.
- Ⓜ Gits Molding Corp., 4600 W. Huron St., Chicago 44, Ill.
- Ⓜ Insulation Mfg. Co., 11 New York Ave., Brooklyn, N. Y.
- Ⓜ Molded Insulation Co., 335 E. Price St., Philadelphia 44, Pa.
- Ⓜ Northern Industrial Chemical Co., 7-11 Elkins St., South Boston 27, Mass.

GRILLES—Speaker

- Ⓜ Bestcraft Products, 626 Broadway, New York, N. Y.
- Ⓜ Felsenthal & Sons, Inc., G., 4100 W. Grand Ave., Chicago 51, Ill.
- Ⓜ FLOCK PROCESS CO., INC., 28 Fahey St., Springdale, Conn. ADV. PG. 196.
- Ⓜ General Cement Mfg. Co., 919 Taylor Ave., Rockford, Ill.
- Ⓜ Holl Audio Industries, 9215 Venice Blvd., Los Angeles 34, Calif.
- Ⓜ Magna Electronics Co., 3707-11 W. Jefferson Blvd., Los Angeles 16, Calif.
- Ⓜ Schott Co., Walter L., 3225 Exposition Pl., Los Angeles 18, Calif.
- Ⓜ TRAD TELEVISION CORP., 1001 First Ave., Asbury Park, N. J. ADV. PG. 355.

GROMMETS

- Ⓜ AEROLITE ELECTRONIC HARDWARE CORP., 507 26th St., Union City, N. J. ADV. PG. 355.
- Ⓜ AMERICAN BRASS CO., 25 Broadway, New York 4, N. Y. ADV. PG. 330.
- Ⓜ ATLANTIC INDIA RUBBER WORKS, INC., 571 W. Polk St., Chicago 7, Ill. ADV. PG. 323.
- Ⓜ Auburn Mfg. Co., Pease Ave. & Stack St., Middletown, Conn.
- Ⓜ Chase Brass & Copper Co., Inc., 236 Grand St., Waterbury 20, Conn.
- Ⓜ EMELOID CO., INC., THE, 1239 Central Ave., Hillside 5, N. J. ADV. PG. 102.
- Ⓜ FEDERAL SCREW PRODUCTS, INC., 224 W. Huron St., Chicago 10, Ill. ADV. PG. 76.
- Ⓜ General Cement Mfg. Co., 919 Taylor Ave., Rockford, Ill.
- Ⓜ HEYMAN MFG. CO., 300 Michigan Ave., Kenilworth, N. J. ADV. PG. 381.
- Ⓜ Insuline Corp. of America, 36-02 35th Ave., Long Island City, N. Y.
- Ⓜ Lavelle Rubber Co., 424 N. Wood St., Chicago 22, Ill.
- Ⓜ LOUTHAN MFG. CO., East Liverpool, Ohio. ADV. PG. 284.
- Ⓜ Mayfair Molded Products Corp., 4440 N. Elston Ave., Chicago 30, Ill.
- Ⓜ NEO-SIL CORP., 26 Cornelson Ave., Jersey City 4, N. J. ADV. PG. 253.
- Ⓜ Philco Corp., Tioga & C Sts., Philadelphia 34, Pa.
- Ⓜ PIX MFG. CO., INC., 24 Bedford St., Newark, N. J. ADV. PG. 136.
- Ⓜ Plume & Atwood Mfg. Co., 220 Broadway, New York, N. Y.
- Ⓜ PRECISION PAPER TUBE CO., 2033 W. Charleston St., Chicago 47, Ill. ADV. PG. 156.
- Ⓜ Schott Co., Walter L., 3225 Exposition Pl., Los Angeles 18, Calif.
- Ⓜ Scovill Mfg. Co., Industrial Fastener Div., Waterbury, Conn.
- Ⓜ Smith, Inc., Herman H., 436 18th St., Brooklyn 15, N. Y.
- Ⓜ Stevens Products, Inc., 86-88 Main St., East Orange, N. J.
- Ⓜ Stimpson Co., Inc., Edwin B., 74 Franklin Ave., Brooklyn 5, N. Y.
- Ⓜ TEFLON PRODUCTS DIVISION, U. S. GASKET CO., P. O. Box 93, Camden, N. J. ADV. PG. 176.
- Ⓜ United Carr Fastener Corp., Cambridge 42, Mass.
- Ⓜ U. S. Rubber Co., 1230 Avenue of the Americas, New York 20, N. Y.
- Ⓜ U. S. Stoneware Co., Akron 9, Ohio.
- Ⓜ United Shoe Machinery Corp., 142 Federal St., Boston, Mass.
- Ⓜ Wolfe Co., Inc., Franklin C., 11723 Mississippi Ave., Los Angeles 25, Calif.

GROMMETS—Fibre

- Ⓜ Auburn Mfg. Co., Pease Ave. & Stack St., Middletown, Conn.
- Ⓜ Baer Co., N. S., 9 Montgomery St., Hillside, N. J.
- Ⓜ Brandywine Fibre Co., 15th & Poplar Sts., Wilmington, Del.
- Ⓜ General Cement Mfg. Co., 919 Taylor Ave., Rockford, Ill.
- Ⓜ Insuline Corp. of America, 36-02 35th Ave., Long Island City, N. Y.
- Ⓜ Keystone Electronics Corp., 423 Broome St., New York 12, N. Y.

V indicates . . . **IN PRODUCTION • AVAILABILITY • UNRESTRICTED FOR GENERAL USE**

- ⓄPhilco Corp., Tioga & C Sts., Philadelphia 34, Pa.
- ⓄRogers Corp., Manchester, Conn.
- ⓄSchott Co., Walter L., 3225 Exposition Pl., Los Angeles 18, Calif.
- ⓄSpaulding Fibre Co., Inc., 310 Wheeler St., Tonawanda, N. Y.

HARNESSES—Wire

See Also Cable Assemblies

- ⓄAcme Electric Heating Co., 1217 Washington St., Boston, Mass.
- ⓄAEROLITE ELECTRONIC HARDWARE CORP., 507 26th St., Union City, N. J. ADV. PG. 355.
- ⓄAeronautical Electronics, Inc., Raleigh-Durham Airport, P. O. Box 6043, Raleigh, N. C.
- ⓄALDEN PRODUCTS CO., 117 No. Main St., Brockton 64, Mass. ADV. PG. 327.
- ⓄAMERICAN PHENOLIC CORP., 1830 S. 54th Ave., Chicago 50, Ill. ADV. PG. 61.
- ⓄBARKER & WILLIAMSON, 235 Fairfield Ave., Upper Darby, Pa. ADV. PG. 292.
- ⓄBRAND & CO., INC., WM., North & Valley Sts., Willimantic, Conn. ADV. PG. 248, 249.
- ⓄBREEZE CORPS., INC., 41 S. Sixth St., Newark 7, N. J. ADV. PG. 193.
- ⓄCable Electric Products Co., Providence, R. I.
- ⓄCarol Cable Co., 190 Middle St., Pawtucket, R. I.
- ⓄCarter Parts Co., 213 Institute Place, Chicago 10 Ill.
- ⓄCITATION PRODUCTS CO., 233 E. 146th St., New York 51, N. Y. ADV. PG. 388.
- ⓄCOLUMBIA WIRE & SUPPLY CO., 2850 Irving Park Rd., Chicago 18, Ill. ADV. PG. 396.
- ⓄConnecticut Telephone & Electric Corp., 70 Britannia St., Meriden, Conn.
- ⓄDielectric Materials Co., 5315-17 N. Ravenswood Ave., Chicago 40, Ill.
- ⓄEdwards Co., Inc., 86 Boston Post Rd., Norwalk, Conn.
- ⓄElectro-Wire Service, 5 Beekman St., New York 7, N. Y.
- ⓄElectronic Brazing Co., 146 Glenridge Ave., Montclair, N. J.
- ⓄElectym Motor Products Corp., 565 W. Washington Blvd., Chicago 6, Ill.
- ⓄEssex Wire Corp., 1601 Wall St., Fort Wayne 6, Ind.
- ⓄEtraco Mfg. Co., Inc., Woods Church Rd., Flemington, N. J.
- ⓄHallett Mfg. Co., 1601 Florence Ave., Inglewood, Calif.
- ⓄHEPPNER MFG. CO., P. O. Box 612, Round Lake, Ill. ADV. PG. 413.
- ⓄIndustrial Electronics Co., Hanover, Mass.
- ⓄJ F D MFG. CO., 6101-23 Sixteenth Ave., Brooklyn, N. Y. ADV. PG. 407.
- ⓄKELLOGG SWITCHBOARD & SUPPLY CO., 6650 S. Cicero Ave., Chicago 38, Ill. ADV. PG. 294.
- ⓄLaMagna Mfg. Co., Inc., East Rutherford, N. J.
- ⓄLAPOINTE-PLASCOMOLD CORP., Windsor Locks, Conn. ADV. PG. 297.
- ⓄLoral Electronics Corp., 794 E. 140th St., New York 54, N. Y.

- ⓄMODELECTRIC PRODUCTS CORP., 1500 Bangs Ave., Asbury Park, N. J. ADV. PG. 204.
- ⓄMolded Insulation Co., 335 E. Price St., Philadelphia 44, Pa.
- ⓄNetwork Mfg. Corp., Bayonne, N. J.
- ⓄORTHOX CORP., 196 Albion Ave., Paterson 2, N. J. ADV. PG. 156.
- ⓄPacific Electricord Co., 3217 Exposition Place, Los Angeles 18, Calif.
- ⓄPeschel Electronics, Inc., 13 Garden St., New Rochelle, N. Y.
- ⓄPHALLO PLASTICS CORP., 25 Foster St., Worcester 8, Mass. ADV. PG. 282.
- ⓄPhilco Corp., Tioga & C Sts., Philadelphia 34, Pa.
- ⓄPlastic Wire & Cable Corp., Jewett City, Conn.
- ⓄPRODUCT DEVELOPMENT CO., INC., Arlington, N. J. ADV. PG. 362.
- ⓄRiverside Electrical Mfg. Co., 10221 Michigan Ave., Dearborn, Mich.
- ⓄRunzel Cord & Wire Co., 4723-31 W. Montrose Ave., Chicago 41, Ill.
- ⓄSchott Co., Walter L., 3225 Exposition Pl., Los Angeles 18, Calif.
- ⓄShevers, Inc., Harold, 123 W. 64th St., New York 23, N. Y.
- ⓄSittler Corp., 18 N. Ada St., Chicago 7, Ill.
- ⓄTelevision Laboratories, Inc., 5045 W. Lake St., Chicago 44, Ill.
- ⓄTENSOLITE INSULATED WIRE CO., 198 Main St., Tarrytown, N. Y. ADV. PG. 316.
- ⓄThordarson-Meissner Mfg. Divs., 500 W. Huron St., Chicago 10, Ill.
- ⓄTRAD TELEVISION CORP., 1001 First Ave., Asbury Park, N. J. ADV. PG. 355.
- ⓄUnited-Carr Fastener Corp., Cambridge 42, Mass.
- ⓄUNITED MFG. & SERVICE CO., 405 S. Sixth St., Milwaukee 4, Wis. ADV. PG. 324.
- ⓄWhittaker Cable Corp., Kansas City 16, Mo.
- ⓄWinslow Co., Inc., 9 Liberty St., Newark 5, N. J.

HEADPHONES & HEADSETS

- ⓄBendix Radio Division, Bendix Aviation Corp., Baltimore 4, Md.
- ⓄBRUSH DEVELOPMENT CO., 3405 Perkins Ave., Cleveland 14, Ohio. ADV. PG. 228, 229.

- ⓄCannon Co., C. F., Springwater, N. Y.
- ⓄConnecticut Telephone & Electric Corp., 70 Britannia St., Meriden, Conn.
- ⓄELECTRO-VOICE, INC., Buchanan, Mich. ADV. PG. 345.
- ⓄGLASER-STEERS CORP., 2 Main St., Belleville 9, N. J. ADV. PG. 359.
- ⓄHEPPNER MFG. CO., P. O. Box 612, Round Lake, Ill. ADV. PG. 413.
- ⓄInsuline Corp. of America, 36-02 35th Ave., Long Island City, N. Y.
- ⓄMaico Co., Inc., 21 N. 3rd St., Minneapolis, Minn.
- ⓄMARCONI INSTRUMENTS, LTD., 23 Beaver St., New York 14, N. Y. ADV. PG. 270.
- ⓄPERMOFLUX CORP., 4900 W. Grand Ave., Chicago 39, Ill. ADV. PG. 321.
- ⓄPhilmore Mfg. Co., Inc., 113 University Place, New York 3, N. Y.
- ⓄROANWELL CORP., 662 Pacific St., Brooklyn 17, N. Y. ADV. PG. 403.
- ⓄSoundscriber Corp., 146 Munson St., New Haven 4, Conn.
- ⓄTANNOY, 350 Fifth Ave., New York 1, N. Y. ADV. PG. 412.
- ⓄTELEX, INC., Telex Park, St. Paul 1, Minn. ADV. PG. 237.
- ⓄTelephonics Corp., Park Ave., Huntington, N. Y.
- ⓄTrimm, Inc., 400 W. Lake St., Libertyville, Ill.
- ⓄWinslow Co., Inc., 9 Liberty St., Newark 5, N. J.

HEADS—Recording

- ⓄAstac Corp., The, Conneaut, Ohio.
- ⓄBerlant Associates, 4917 W. Jefferson Blvd., Los Angeles 16, Calif.
- ⓄBRUSH DEVELOPMENT CO., 3405 Perkins Ave., Cleveland 14, Ohio. ADV. PG. 228, 229.
- ⓄCrescent Industries, Inc., 4140 Belmont Ave., Chicago 41, Ill.
- ⓄDaystrom Electric Corp., 837 Main St., Poughkeepsie, N. Y.
- ⓄDUOTONE CO., INC., Keyport, N. J. ADV. PG. 307.
- ⓄFairchild Recording Equipment Corp., 154th St. & 7th Ave., Whitestone, N. Y.
- ⓄINDIANA STEEL PRODUCTS CO., Valparaiso, Indiana. ADV. PG. 154.
- ⓄLipps, Edwin A., 1781 Rimpau Blvd., Los Angeles 6, Calif.
- ⓄPentron Corp., 221 E. Cullerton St., Chicago 16, Ill.
- ⓄRAYTHEON MFG. CO., Equipment Sales Div., Waltham 54, Mass. ADV. PG. 80, 81.
- ⓄSoundscriber Corp., 146 Munson St., New Haven 4, Conn.
- ⓄStancil-Hoffman Corp., 1016 N. Highland Ave., Hollywood 38, Calif.
- ⓄUnited Pressed Products Co., 741 W. Harrison St., Chicago 7, Ill.

HEADS—Wire & Tape Recording

- ⓄBerlant Associates, 4917 W. Jefferson Blvd., Los Angeles 16, Calif.
- ⓄBRUSH DEVELOPMENT CO., 3405 Perkins Ave., Cleveland 14, Ohio. ADV. PG. 228, 229.
- ⓄCINEMA ENGINEERING CO., 1510 W. Verdugo Ave., Burbank, Calif. ADV. PG. 204.
- ⓄDaystrom Electric Corp., 837 Main St., Poughkeepsie, N. Y.
- ⓄFairchild Recording Equipment Co., 154th St. & Seventh Ave., Whitestone, N. Y.
- ⓄINDIANA STEEL PRODUCTS CO., Valparaiso, Indiana. ADV. PG. 154.
- ⓄMonarch Radio & Television Corp., 2430 Atlantic Ave., Brooklyn 33, N. Y.
- ⓄPentron Corp., 221 E. Cullerton St., Chicago 16, Ill.
- ⓄRangertone, Inc., 73 Winthrop St., Newark 4, N. J.
- ⓄSHURE BROTHERS, INC., 225 W. Huron St., Chicago 10, Ill. ADV. PG. 230.
- ⓄSoundscriber Corp., 146 Munson St., New Haven 4, Conn.
- ⓄStancil-Hoffman Corp., 1016 N. Highland Ave., Hollywood 38, Calif.
- ⓄUnited Pressed Products Co., 741 W. Harrison St., Chicago 7, Ill.

HEARING AID TUBES

See Tubes—Hearing Aid

HEARING AIDS

- ⓄAurex Corp., Chicago 10, Ill.
- ⓄBeltone Hearing Aid Co., Beltone Bldg., 1450 W. 19th St., Chicago 8, Ill.
- ⓄGlobe Phone Mfg. Corp., 2 Linden St., Reading, Mass.
- ⓄHofmann Corp., C. L., 436 Blvd. of The Allies, Pittsburgh 19, Pa.
- ⓄLaurehk Radio Mfg. Co., 3931 Monroe Ave., Wayne, Mich.
- ⓄMaico Co., Inc., 21 N. 3rd St., Minneapolis, Minn.
- ⓄMicrotone Co., Ford Parkway on the Mississippi, St. Paul 1, Minn.
- ⓄModern Hearing Aids Laboratory, The, 6805 Fraser St., Vancouver, B. C., Canada.

- ⓄMyers & Sons, E. A., Radioear Bldg., Beverly Rd., Pittsburgh 16, Pa.
- ⓄParavox, Inc., 2056 East 4th St., Cleveland 15, Ohio.
- ⓄRochester Acoustical Laboratories, Inc., Rochester, Minn.
- ⓄSchulmerich Electronics, Inc., Sellersville, Pa.
- ⓄSonotone Corp., P. O. Box 200, Saw Mill River Road, Elmsford, N. Y.
- ⓄTELEX, INC., Telex Park, St. Paul 1, Minn. ADV. PG. 237.
- ⓄTrimm Inc., 400 W. Lake St., Libertyville, Ill.

HEATING, ELECTRONIC—Accessories and Associated Equipment

- ⓄAIRMEC LABORATORIES LTD., 366 Madison Ave., New York 17, N. Y. ADV. PG. 336.
- ⓄAjax Electrothermic Corp., Ajax Park, Trenton 5, N. J.
- ⓄBARKER & WILLIAMSON, 235 Fairfield Ave., Upper Darby, Pa. ADV. PG. 292.
- ⓄElectronic Brazing Co., 140 Glenridge Ave., Montclair, N. J.
- ⓄElectronic Engineering Corp., 469 Elm St., Arlington, N. J.
- ⓄGalbraith & Son Electric Corp., C. C., 450 Sixth Ave., New York 11, N. Y.
- ⓄGENERAL ELECTRIC CO., Schenectady 5, N. Y. ADV. PG. 1 to 22.
- ⓄHigh Frequency Heating Co., 143 Glen Park Ave., Gary, Ind.
- ⓄInduction Heating Corp., 181 Wythe Ave., Brooklyn 11, N. Y.
- ⓄInet, Inc., 8655 S. Main St., Los Angeles 3, Calif.
- ⓄLa Rose & Associates, Inc., W. T., 646 Second Ave., Troy, N. Y.
- ⓄLepel High Frequency Labs., Inc., 39 West 60th St., New York 23, N. Y.
- ⓄMinneapolis-Honeywell Regulator Co., 2753 Fourth Ave., S., Minneapolis, Minn.
- ⓄPreston-Eidson Electronics Co., 2760 Whittler Blvd., Los Angeles 23, Calif.
- ⓄReeve Electronics, Inc., 609 W. Lake St., Chicago 6, Ill.
- ⓄSherman Industrial Electronics Co., Inc., 505 Washington Ave., Belleville 9, N. J.
- ⓄShort Wave Plastic Forming Co., 2921 W. Alameda St., Burbank, Calif.
- ⓄStandard Telephones & Cables Ltd., Connaught House, Aldwych, London, W. C. 2, England.
- ⓄTENNEY ENGINEERING, INC., 26 Avenue B, Newark 5, N. J. ADV. PG. 98.
- ⓄTocco Division, Ohio Crankshaft Co., 3800 Harvard Ave., Cleveland 1, Ohio.
- ⓄWeltronic Co., 19500 W. Eight Mile Rd., Detroit 19, Mich.
- ⓄWESTINGHOUSE ELECTRIC CORP., 511 Wood St., P. O. Box 868, Pittsburgh 30, Pa. ADV. PG. 107-113.
- ⓄWoodwelding, Inc., 3000 W. Olive Ave., Burbank, Calif.

HEATING, ELECTRONIC—Dielectric

- ⓄAIRMEC LABORATORIES LTD., 366 Madison Ave., New York 17, N. Y. ADV. PG. 336.
- ⓄAirtronics Mfg. Co., 5145 W. San Fernando Rd., Los Angeles 39, Calif.
- ⓄAjax Electrothermic Corp., Ajax Park, Trenton 5, N. J.
- ⓄBARKER & WILLIAMSON, 235 Fairfield Ave., Upper Darby, Pa. ADV. PG. 292.
- ⓄElectronic Brazing Co., 140 Glenridge Ave., Montclair, N. J.
- ⓄElectronic Engineering Corp., 469 Elm St., Arlington, N. J.
- ⓄGirdler Corp., 224 E. Broadway, Louisville 1, Ky.
- ⓄHigh Frequency Heating Co., 143 Glen Park Ave., Gary, Ind.
- ⓄInduction Heating Corp., 181 Wythe Ave., Brooklyn 11, N. Y.
- ⓄLa Rose & Associates, Inc., W. T., 646 Second Ave., Troy, N. Y.
- ⓄLepel High Frequency Labs., Inc., 39 West 60th St., St., New York 23, N. Y.
- ⓄNew London Instrument Co., Box 189, New London, Conn.
- ⓄPreston-Eidson Electronics Co., 2760 Whittler Blvd., Los Angeles 23, Calif.
- ⓄRADIO CORP. OF AMERICA, RCA Victor Div., General Offices, Camden, N. J. ADV. PG. 177, Inside Back and Back Covers.
- ⓄReeve Electronics, Inc., 609 W. Lake St., Chicago 6, Ill.
- Ⓞ"S" CORRUGATED QUENCHED GAP CO., Scientific Electric Div., 105-119 Monroe St., Garfield, N. J. ADV. PG. 95.
- ⓄSherman Industrial Electronics Co., Inc., 505 Washington Ave., Belleville 9, N. J.
- ⓄShort Wave Plastic Forming Co., 2921 W. Alameda St., Burbank, Calif.
- ⓄSpectrum Mfg. Co., P. O. Box 189, New London, Conn.
- ⓄStandard Telephones & Cables Ltd., Connaught House, Aldwych, London, W. C. 2, England.
- ⓄWeltronic Co., 19500 W. Eight Mile Rd., Detroit 19, Mich.
- ⓄWESTINGHOUSE ELECTRIC CORP., 511 Wood St., P. O. Box 868, Pittsburgh 30, Pa. ADV. PG. 107-113.
- ⓄWoodwelding, Inc., 3000 W. Olive Ave., Burbank, Calif.

Ⓢ indicates . . . IN PRODUCTION • AVAILABILITY • UNRESTRICTED FOR GENERAL USE

HEATING, ELECTRONIC—Induction

- Ⓢ AIRMEC LABORATORIES LTD., 366 Madison Ave., New York 17, N. Y. ADV. PG. 336.
- Ⓢ Ajax Electrothermic Corp., Ajax Park, Trenton 5, N. J.
- Ⓢ BARKER & WILLIAMSON, 235 Fairfield Ave., Upper Darby, Pa. ADV. PG. 292.
- Ⓢ Electronic Brazing Co., 140 Glenridge Ave., Montclair, N. J.
- Ⓢ Electronic Engineering Corp., 469 Elm St., Arlington, N. J.
- Ⓢ GENERAL ELECTRIC CO., Schenectady 5, N. Y. ADV. PG. 1 to 22.
- Ⓢ HAYDU BROTHERS, Plainfield, N. J. ADV., PG. 55.
- Ⓢ High Frequency Heating Co., 143 Glen Park Ave., Gary, Ind.
- Ⓢ Induction Heating Corp., 181 Wythe Ave., Brooklyn 11, N. Y.
- Ⓢ Lepel High Frequency Labs., Inc., 39 West 60th St., New York 23, N. Y.
- Ⓢ MARION ELECTRICAL INSTRUMENT CO., Manchester, N. H. ADV. PG. 200.
- Ⓢ RADIO CORP. OF AMERICA, RCA Victor Div., General Offices, Camden, N. J. ADV. PG. 177, Inside Back & Back Covers.
- Ⓢ Reeve Electronics, Inc., 609 W. Lake St., Chicago 6, Ill.
- Ⓢ 'S' CORRUGATED QUENCHED GAP CO., Scientific Electric Div., 105-119 Monroe St., Garfield, N. J. ADV. PG. 95.
- Ⓢ Sherman Industrial Electronics Co., Inc., 505 Washington Ave., Belleville 9, N. J.
- Ⓢ SHERRON ELECTRONICS CO., 1201 Flushing Ave., Brooklyn 6, N. Y. ADV. PG. 145.
- Ⓢ Short Wave Plastic Forming Co., 2921 W. Alameda St., Burbank, Calif.
- Ⓢ Standard Telephones & Cables Ltd., Connaught House, Aldwych, London, W. C. 2, England.
- Ⓢ Tocco Division, Ohio Crankshaft Co., 3800 Harvard Ave., Cleveland 1, Ohio.
- Ⓢ VULCAN ELECTRIC CO., 88 Holten St., Danvers, Mass. ADV. PG. 50.
- Ⓢ Weltronic Co., 19500 W. Eight Mile Rd., Detroit 19, Mich.
- Ⓢ WESTINGHOUSE ELECTRIC CORP., 511 Wood St., P. O. Box 868, Pittsburgh 30, Pa. ADV. PG. 107-113.
- Ⓢ Woodwelding, Inc., 3000 W. Olive Ave., Burbank, Calif.

HEMOGLOBINOMETERS—Electronic

- Ⓢ Brociner Electronics Laboratory, 1546 Second Ave., New York 28, N. Y.
- Ⓢ Farrand Optical Co., Inc., Bronx Blvd. at 238th St., New York 70, N. Y.
- Ⓢ Fisher Scientific Co., 717 Forbes St., Pittsburgh 19, Pa.
- Ⓢ Rubicon Co., 3761 Ridge Ave., Philadelphia 29, Pa.

HOLDERS—Crystal

- Ⓢ AMERICAN PHENOLIC CORP., 1830 S. 54th Ave., Chicago 50, Ill. ADV. PG. 61.
- Ⓢ Bassett, Inc., Rex, 307-11 N.W. First Ave., Fort Lauderdale, Fla.
- Ⓢ Breon Labs., 1520 Evergreen Rd., Williamsport, Pa.
- Ⓢ ELECTRONIC MECHANICS INC., 70 Clifton Blvd., Clifton, N. J. ADV. PG. 309.
- Ⓢ Elm Laboratories, 18 South Broadway, Dobbs Ferry, N. Y.
- Ⓢ Etched Products Corp., 39-01 Queens Blvd., Long Island City, N. Y.
- Ⓢ Gasket Engineering Co., 2440 Charlotte St., Kansas City 8, Mo.
- Ⓢ General R-F Fittings Co., 702 Beacon St., Boston 15, Mass.
- Ⓢ HERMETIC SEAL PRODUCTS CO., 29-37 S. 6th St., Newark 7, N. J. ADV. PG. 175.
- Ⓢ Howard Mfg. Co., 1401 S. Main St., Council Bluffs, Iowa.
- Ⓢ KINGS MICROWAVE CO., INC., 50 Marbledale Rd., Tuckahoe 7, N. Y. ADV. PG. 178, 179.
- Ⓢ Millen Mfg. Co., James, 150 Exchange St., Malden, Mass.
- Ⓢ Nebel Lab., R. E., 1104 Lincoln Place, Brooklyn 13, N. Y.
- Ⓢ PIX MFG. CO., INC., 24 Bedford St., Newark, N. J. ADV. PG. 136.
- Ⓢ Precision Piezo Service, 427 Mayflower St., Baton Rouge, La.
- Ⓢ TEFLON PRODUCTS DIVISION, U. S. GASKET CO., P.O. Box 93, Camden, N. J. ADV. PG. 176.
- Ⓢ VECTRON, INC., 235 High St., Waltham, Mass. ADV. PG. 214.
- Ⓢ Westline Electronics Co., 11660 Olympic Blvd., Los Angeles 25, Calif.
- Ⓢ Weymouth Instrument Co., 1440 Commercial St., East Weymouth 89, Mass.

HORNS—Speaker Projector

- Ⓢ Altec Lansing Corp., 9356 Santa Monica Blvd., Beverly Hills, Calif.
- Ⓢ Atlas Sound Corp., 1443 39th St., Brooklyn 18, N. Y.

- Ⓢ Dilks Co., The, Seymour, Conn.
- Ⓢ ELECTRO-VOICE, INC., Buchanan, Mich. ADV. PG. 345.
- Ⓢ Holl Audio Industries, 9215 Venice Blvd., Los Angeles 34, Calif.
- Ⓢ Racon Electric Co., 52 E. 19th St., New York 3, N. Y.
- Ⓢ RADIO CORP. OF AMERICA, RCA Victor Div., General Offices, Camden, N. J. ADV. PG. 177, Inside Back & Back Covers.
- Ⓢ Stephens Mfg. Corp., 8538 Warner Drive, Culver City, Calif.
- Ⓢ TRIX ELECTRICAL MFG. CO., LTD., 366 Madison Ave., New York 17, N. Y. ADV. PG. 336.

HOUSINGS—Antenna

- Ⓢ Cutler Metal Products Co., 1025 Line St., Camden, N. J.
- Ⓢ KELLER PRODUCTS CO., 41 Union St., Manchester, N. H. ADV. PG. 397.
- Ⓢ Kennedy & Co., D. S., Cohasset, Mass.
- Ⓢ PRODUCT DEVELOPMENT CO., INC., Arlington, N. J. ADV. PG. 362.
- Ⓢ Racon Electric Co., 52 E. 19th St., New York 3, N. Y.
- Ⓢ Walter Co., Inc., S., 1400 Atlantic Ave., Brooklyn 16, N. Y.

HOUSINGS—Automobile Radio

- Ⓢ Colgate Mfg. Corp., Lindenhurst, N. Y.
- Ⓢ Cutler Metal Products Co., 1025 Line St., Camden, N. J.
- Ⓢ Delco Radio Div., General Motors Corp., Kokomo, Ind.
- Ⓢ Felsenthal & Sons, Inc., G., 4100 W. Grand Ave., Chicago 51, Ill.
- Ⓢ Insulation Mfg. Co., 11 New York Ave., Brooklyn, N. Y.
- Ⓢ Insuline Corp. of America, 36-02 35th Ave., Long Island City, N. Y.
- Ⓢ Minute Man Products, Inc., 430 E. 102nd St., New York, N. Y.
- Ⓢ Philco Corp., Tioga & C Sts., Philadelphia 34, Pa.
- Ⓢ Walter Co., Inc., S., 1400 Atlantic Ave., Brooklyn 16, N. Y.

HOUSINGS—Instrument

- Ⓢ ABALON PRECISION MFG. CORP., 540 Casanova St., Bronx 59, N. Y. ADV. PG. 348.
- Ⓢ ART-LLOYD METAL PRODUCTS CORP., 2973 Cropsey Ave., Brooklyn 14, N. Y. ADV. PG. 364.
- Ⓢ Berkshire Laboratories, 580 Lexington Rd., Concord, Mass.
- Ⓢ Bud Radio, Inc., 2118 E. 55th St., Cleveland 3, Ohio.
- Ⓢ Colgate Mfg. Corp., Lindenhurst, N. Y.
- Ⓢ Corry-Jamestown Mfg. Co., Corry, Pa.
- Ⓢ Felsenthal & Sons, Inc., G., 4100 W. Grand Ave., Chicago 51, Ill.
- Ⓢ Gale Dorothea Mechanisms, 37-61 85th St., Jackson Heights, N. Y.
- Ⓢ Insulation Mfg. Co., 11 New York Ave., Brooklyn, N. Y.
- Ⓢ Insuline Corp. of America, 36-02 35th Ave., Long Island City, N. Y.
- Ⓢ KARP METAL PRODUCTS CO., INC., 215 63rd St., Brooklyn 20, N. Y. ADV. PG. 105.
- Ⓢ Lorentzen Inc., Leveler, 391 W. Broadway, New York, N. Y.
- Ⓢ Minute Man Products, Inc., 430 E. 102nd St., New York, N. Y.
- Ⓢ MULTI METAL CO., 1350 Garrison Ave., New York 59, N. Y. ADV. PG. 221.
- Ⓢ OLYMPIC METAL PRODUCTS CO., INC., Phillipsburg, N. J. ADV. PG. 358.
- Ⓢ Plastimold Corp., Attleboro, Mass.
- Ⓢ REF Mfg. Corp., Jericho Turnpike, Mineola, N. Y.
- Ⓢ Walter Co., Inc., S., 1400 Atlantic Ave., Brooklyn 16, N. Y.

HOUSINGS—Plug-In

- Ⓢ DIETZ DESIGN & MFG. CO., Grandview 6, Mo. ADV. PG. 323.

HOUSINGS—Public Address System

- Ⓢ ABALON PRECISION MFG. CORP., 540 Casanova St., Bronx 59, N. Y. ADV. PG. 348.
- Ⓢ Altec Lansing Corp., 9356 Santa Monica Blvd., Beverly Hills, Calif.
- Ⓢ Catalin Corp. of America, 1 Park Ave., New York 16, N. Y.
- Ⓢ Colgate Mfg. Corp., Lindenhurst, N. Y.
- Ⓢ Cosor (Canada), Ltd., 301-303 Windsor St., Halifax, N. S., Canada.
- Ⓢ Cutler Metal Products Co., 1025 Line St., Camden, N. J.
- Ⓢ ELECTRO-VOICE, INC., Buchanan, Mich. ADV. PG. 345.
- Ⓢ Gale Dorothea Mechanisms, 37-61 85th St., Jackson Heights, N. Y.
- Ⓢ Magna Electronics Co., 3707-11 W. Jefferson Blvd., Los Angeles 16, Calif.
- Ⓢ Newcomb Audio Products Co., 6824 Lexington Ave., Hollywood 38, Calif.

- Ⓢ RADIO CORP. OF AMERICA, RCA Victor Div., General Offices, Camden, N. J. ADV. PG. 177, Inside Back & Back Covers.
- Ⓢ Walter Co., Inc., S., 1400 Atlantic Ave., Brooklyn 16, N. Y.

HOUSINGS—Speaker

- Ⓢ ABALON PRECISION MFG. CORP., 540 Casanova St., Bronx 59, N. Y. ADV. PG. 348.
- Ⓢ Acklin Stamping Co., 1923 Nebraska Ave., Toledo 7, Ohio.
- Ⓢ Altec Lansing Corp., 9356 Santa Monica Blvd., Beverly Hills, Calif.
- Ⓢ Amplex Division, Chrysler Corp., Detroit 31, Mich.
- Ⓢ ART-LLOYD METAL PRODUCTS CORP., 2973 Cropsey Ave., Brooklyn 14, N. Y. ADV. PG. 364.
- Ⓢ Atlas Sound Corp., 1443 39th St., Brooklyn 18, N. Y.
- Ⓢ Bud Radio Inc., 2118 E. 55th St., Cleveland 3, Ohio.
- Ⓢ Colgate Mfg. Corp., Lindenhurst, N. Y.
- Ⓢ Cutler Metal Products Co., 1025 Line St., Camden, N. J.
- Ⓢ ELECTRO-VOICE, INC., Buchanan, Mich. ADV. PG. 345.
- Ⓢ Hartley Co., Ltd., H. A., 152 Hammersmith Rd., London W. 6, England.
- Ⓢ Hawley Products Co., St. Charles, Ill.
- Ⓢ Holl Audio Industries, 9215 Venice Blvd., Los Angeles 34, Calif.
- Ⓢ Insuline Corp. of America, 36-02 35th Ave., Long Island City, N. Y.
- Ⓢ Jensen Mfg. Co., 6601 S. Laramie Ave., Chicago 38, Ill.
- Ⓢ Magna Electronics Co., 3707-11 W. Jefferson Blvd., Los Angeles 16, Calif.
- Ⓢ Racon Electric Co., 52 E. 19th St., New York 3, N. Y.
- Ⓢ RADIO CORP. OF AMERICA, RCA Victor Div., General Offices, Camden, N. J. ADV. PG. 177, Inside Back & Back Covers.
- Ⓢ Rauland-Borg Corp., 3523 W. Addison St., Chicago 18, Ill.
- Ⓢ Stephens Mfg. Corp., 8538 Warner Drive, Culver City, Calif.
- Ⓢ TRAD TELEVISION CORP., 1001 First Ave., Asbury Park, N. J. ADV. PG. 355.
- Ⓢ TRIX ELECTRICAL MFG. CO., LTD., 366 Madison Ave., New York 17, N. Y. ADV. PG. 336.
- Ⓢ UNIVERSITY LOUDSPEAKERS, INC., 80 S. Kensico Ave., White Plains, N. Y. ADV. PG. 38.
- Ⓢ Walter Co., Inc., S., 1400 Atlantic Ave., Brooklyn 16, N. Y.
- Ⓢ Waveforms, Inc., 333 Sixth Ave., New York 14, N. Y.

IGNITION SYSTEMS—Electronic

- Ⓢ AIRTRON, INC., 101 E. Elizabeth Ave., Linden, N. J. ADV. PG. 317.
- Ⓢ Hallett Mfg. Co., 1601 Florence Ave., Inglewood, Calif.
- Ⓢ Ionic Electronic Equipment Co., 1705 N. Kenmore, Los Angeles 27, Calif.
- Ⓢ Minneapolis-Honeywell Regulator Co., 2753 Fourth Ave. S., Minneapolis, Minn.
- Ⓢ MODELECTRIC PRODUCTS CORP., 1500 Bangs Ave., Asbury Park, N. J. ADV. PG. 204.
- Ⓢ Scintilla Magneto Div., Bendix Aviation Corp., Sidney, N. Y.
- Ⓢ WESTINGHOUSE ELECTRIC CORP., 511 Wood St., P.O. Box 868, Pittsburgh 30, Pa. ADV. PG. 107-113.
- Ⓢ Whitaker Cable Corp., Kansas City 16, Mo.

IGNITRON

See Tubes

ILLUMINATION CONTROLS

See Controls, Illumination

IMPREGNATING COMPOUNDS

See Insulating Compounds

IMPREGNATING MACHINES

See Machines

IMPREGNATING WAX

See Wax Impregnating

INDICATORS—Antenna Position

- Ⓢ AMERICAN PHENOLIC CORP., 1830 S. 54th Ave., Chicago 50, Ill. ADV. PG. 61.
- Ⓢ Avion Instrument Corp., Paramus, N. J.
- Ⓢ Doelcam Corp., 56 Elmwood St., Newton 58, Mass.
- Ⓢ Electro-Mechanical Instrument Co., 812 Chestnut St., Perkasie, Pa.
- Ⓢ GENERAL ELECTRIC CO., Apparatus Dept., Schenectady 5, N. Y. ADV. PG. 1 to 22.

V indicates . . . IN PRODUCTION • AVAILABILITY • UNRESTRICTED FOR GENERAL USE

- Ⓞ Network Mfg. Corp., Bayonne, N. J.
- Ⓞ Radiart Corp., The, 3571 W. 62nd St., Cleveland, Ohio.
- Ⓞ SHURITE METERS, 35-B Hamilton St., New Haven 8, Conn. ADV. PG. 390.

INDICATORS—Arc Back

- Ⓞ GENERAL ELECTRIC CO., Schenectady 5, N. Y. ADV. PG. 1 to 22.
- Ⓞ Press Wireless Mfg. Co., Inc., Cantiague Rd., Hicksville, N. Y.
- Ⓞ Walkirt Co., 5808 Marilyn Ave., Culver City, Calif.

INDICATORS—Broadcast Volume

- Ⓞ DAVEN CO., 191 Central Ave., Newark 4, N. J. ADV. PG. 157.
- Ⓞ Gates Radio Co., Quincy, Ill.
- Ⓞ GENERAL ELECTRIC CO., Schenectady 5, N. Y. ADV. PG. 1 to 22.

INDICATORS—Capacitor Leakage

- Ⓞ KEITHLEY INSTRUMENTS, 1507 Warrensville Center Rd., Cleveland 21, Ohio. ADV. PG. 337.
- Ⓞ Leeds & Northrup Co., 4970 Stenton Ave., Philadelphia 44, Pa.
- Ⓞ McMurdo Silver Co., Inc., 473 Lafayette St., New York, N. Y.
- Ⓞ Menlo Research Laboratory, Menlo Park, Calif.
- Ⓞ Network Mfg. Corp., Bayonne, N. J.
- Ⓞ Peschel Electronics, Inc., 13 Garden St., New Rochelle, N. Y.

INDICATORS—Density

See Indicators, Specific Gravity

INDICATORS—Detonation Indicators & Meters

- Ⓞ ELECTRO PRODUCTS LABS., 4501 N. Ravenswood Ave., Chicago 40, Ill. ADV. PG. 199.
- Ⓞ Photocou Research Products, 1062 N. Allen Ave., Pasadena 7, Calif.
- Ⓞ SPERRY GYROSCOPE CO., Div. of The Sperry Corp., Great Neck, N. Y. ADV. PG. 103, 104.

INDICATORS—Dew Point

- American Instrument Co., 8030 Georgia Ave., Silver Spring, Md.
- Ⓞ Foxboro Co., The, Foxboro, Mass.
- Ⓞ GENERAL ELECTRIC CO., Schenectady 5, N. Y. ADV. PG. 1 to 22.

INDICATORS—Dielectric Constant

- Ⓞ BOONTON RADIO CORP., Boonton, N. J. ADV. PG. 96.
- Ⓞ Fielden Instrument Corp., 2920 N. 4th St., Philadelphia 33, Pa.
- Ⓞ Leeds & Northrup Co., 4970 Stenton Ave., Philadelphia 44, Pa.
- Ⓞ MARCONI INSTRUMENTS, LTD., 23 Beaver St., New York 4, N. Y. ADV. PG. 270.
- Ⓞ Thompson & Associates, John E., 7210 S. Yates Ave., Chicago 49, Ill.

INDICATORS—Film Thickness

- American Instrument Co., 8030 Georgia Ave., Silver Spring, Md.
- Ⓞ BRANSON INSTRUMENTS, INC., 438 Fairfield Ave., Stamford, Conn. ADV. PG. 90.
- Ⓞ Fielden Instrument Corp., 2920 N. 4th St., Philadelphia 33, Pa.
- Ⓞ GENERAL ELECTRIC CO., Schenectady 5, N. Y. ADV. PG. 1 to 22.
- Ⓞ H. M. R. Electronics Inc., Grove St., New Canaan, Conn.
- Ⓞ MARCONI INSTRUMENTS, LTD., 23 Beaver St., New York 4, N. Y. ADV. PG. 270.
- Ⓞ North American Philips Co., Inc., 100 E. 42nd St., New York 17, N. Y.
- Ⓞ Short Wave Plastic Forming Co., 2921 W. Alameda St., Burbank, Calif.
- Ⓞ Standard Electronics Research Corp., 2 East End Ave., New York 21, N. Y.
- Ⓞ Tracerlab, Inc., 130 High St., Boston 10, Mass.

INDICATORS—Fluid Conductivity

- Ⓞ Bailey Meter Co., 1044 Ivanhoe Rd., Cleveland 10, Ohio.
- Ⓞ Beckman Instruments, Inc., 800 Mission St., South Pasadena, Calif.
- Ⓞ Foxboro Co., The, Foxboro, Mass.

- Ⓞ Leeds & Northrup Co., 4970 Stenton Ave., Philadelphia 44, Pa.
- Ⓞ MINNEAPOLIS-HONEYWELL REGULATOR CO., INDUSTRIAL DIV., Wayne & Roberts Aves., Philadelphia 44, Pa. ADV. PG. 208, 209.
- Ⓞ Network Mfg. Corp., Bayonne, N. J.
- Ⓞ Peschel Electronics, Inc., 13 Garden St., New Rochelle, N. Y.
- Ⓞ Thompson & Associates, John E., 7210 S. Yates Ave., Chicago 49, Ill.

INDICATORS—Fluid Flow

- Ⓞ Autocall Co., The, Shelby, Ohio.
- Ⓞ Bailey Meter Co., 1044 Ivanhoe Road, Cleveland 10, Ohio.
- Ⓞ Bristol Co., The, Waterbury 20, Conn.
- Ⓞ Bunnell & Co., J. H., 81 Prospect St., Brooklyn, N. Y.
- Ⓞ Coral Designs Div. of Henry G. Dietz Co., 12-16 Astoria Blvd., Long Island City 2, N. Y.
- Ⓞ ECLIPSE-PIONEER DIV., Bendix Aviation Corp., Teterboro, N. J. ADV. PG. 198, 199.
- Ⓞ Fieldman Instrument Corp., 2920 N. 4th St., Philadelphia 33, Pa.
- Ⓞ Fischer & Porter Co., Hatboro, Pa.
- Ⓞ Foxboro Co., The, Foxboro, Mass.
- Ⓞ INDUSTRIAL ELECTRONICS, INC., 8080 Wheeler St., Detroit 10, Mich. ADV. PG. 234, 235.
- Ⓞ Menlo Research Laboratory, Menlo Park, Calif.
- Ⓞ MINNEAPOLIS-HONEYWELL REGULATOR CO., INDUSTRIAL DIV., Wayne & Roberts Aves., Philadelphia 44, Pa. ADV. PG. 208, 209.
- Ⓞ Peschel Electronics, Inc., 13 Garden St., New Rochelle, N. Y.
- Ⓞ Short Wave Plastic Forming Co., 2921 W. Alameda St., Burbank, Calif.

INDICATORS—Frequency

- Ⓞ Aero Instrument Co., 11423 Vanowen St., North Hollywood, Calif.
- Ⓞ AIRMEC LABORATORIES LTD., 366 Madison Ave., New York 17, N. Y. ADV. PG. 336.
- Ⓞ BARKER & WILLIAMSON, 235 Fairfield Ave., Upper Darby, Pa. ADV. PG. 292.
- Ⓞ Bassett, Inc., Rex, 307-11 N. W. First Ave., Fort Lauderdale, Fla.
- Ⓞ Berkeley Scientific Corp., 2200 Wright Ave., Richmond, Calif.
- Ⓞ DAVEN CO., 191 Central Ave., Newark 4, N. J. ADV. PG. 157.
- Ⓞ EDIN CO., INC., 207 Main St., Worcester, Mass. ADV. PG. 285.
- Erco Radio Labs., Inc., East Stewart Ave., Garden City, N. Y.
- Ⓞ GENERAL ELECTRIC CO., Schenectady 5, N. Y. ADV. PG. 1 to 22.
- Ⓞ GENERAL RADIO CO., 275 Massachusetts Ave., Cambridge 39, Mass. ADV. PG. 48, 49
- Ⓞ HICKOK ELECTRICAL INSTRUMENT CO., 10514 Dupont Ave., Cleveland 8, Ohio. ADV. PG. 333.
- Ⓞ J-B-T INSTRUMENTS, INC., 431-B Chapel St., New Haven 8, Conn. ADV. PG. 351.
- Ⓞ Leeds & Northrup Co., 4970 Stenton Ave., Philadelphia 44, Pa.
- Ⓞ MEASUREMENTS CORP., Boonton, N. J. ADV. PG. 99.
- Ⓞ Nucleonic Corp., of America, 497 Union St., Brooklyn 31, N. Y.
- Ⓞ POLARAD ELECTRONICS CORP., 100 Metropolitan Ave., Brooklyn 11, N. Y. ADV. PG. 184, 185.
- Ⓞ POTTER INSTRUMENT CO., 115 Cutter Mill Rd., Great Neck, N. Y. ADV. PG. 318.
- Ⓞ SPERRY GYROSCOPE CO., Div. of The Sperry Corp., Great Neck, N. Y. ADV. PG. 103, 104.
- Ⓞ Walkirt Co., 5808 Marilyn Ave., Culver City, Calif.
- Ⓞ WESTON ELECTRICAL INSTRUMENT CORP., 595 Freylinghuysen Ave., Newark 5, N. J. ADV. PG. 243.

INDICATORS—Geiger Counter

- Aerolux Light Corp., 653 11th Ave., New York 19, N. Y.
- Ⓞ AIRMEC LABORATORIES LTD., 366 Madison Ave., New York 17, N. Y. ADV. PG. 336.
- Ⓞ Anton Electronic Laboratories, Inc., 1226-1238 Flushing Ave., Brooklyn 6, N. Y.
- Ⓞ ATOMIC INSTRUMENT CO., 84 Massachusetts Ave., Cambridge 39, Mass. ADV. PG. 410.
- Ⓞ Beckman Instruments, Inc., 800 Mission St., South Pasadena, Calif.
- Ⓞ Berkeley Scientific Corp., 2200 Wright Ave., Richmond, Calif.
- Ⓞ Douglas Radio Labs., 176 Norfolk Ave., Boston 19, Mass.
- Ⓞ Electronic Products Co., 111 E. Third St., Mt. Vernon, N. Y.
- Ⓞ EL-TRONICS, INC., 2649 N. Howard St., Philadelphia 33, Pa. ADV. PG. 299.
- Ⓞ Fisher Research Lab., 1961 University Ave., Palo Alto, Calif.
- Ⓞ Flader, Inc., Fredric, 1330 Laskey Rd., Toledo 12, Ohio.

- Ⓞ GENERAL RADIO CO., 275 Massachusetts Ave., Cambridge 39, Mass. ADV. PG. 48, 49.
- Ⓞ Georator Corp., 1820 N. Nash St., Arlington, Va.
- Ⓞ Kelly-Koett, Instrument Co., 962 York St., Cincinnati 14, Ohio.
- Ⓞ Magna Electronics Co., 3707-11 Jefferson Blvd., Los Angeles 16, Calif.
- Ⓞ North American Philips Co., Inc., 100 E. 42nd St., New York 17, N. Y.
- Ⓞ Nuclear Development Lab., P. O. Box 7034, Kansas City, Mo.
- Ⓞ Nuclear Instrument & Chemical Corp., 223 W. Erie St., Chicago 10, Ill.
- Ⓞ Nuclear Research Corp., 2707 Federal St., Philadelphia 46, Pa.
- Ⓞ Nucleonic Corp., of America, 497 Union St., Brooklyn 31, N. Y.
- Ⓞ POTTER INSTRUMENT CO., INC., 115 Cutter Mill Rd., Great Neck, N. Y. ADV. PG. 318.
- Ⓞ Precision Radiation Instruments, Inc., 4113 W. Jefferson Blvd., Los Angeles 16, Calif.
- Ⓞ R-C Scientific Instrument Co., 335 Culver Blvd., Playa Del Ray, Calif.
- Ⓞ Radiation Counter Laboratories, Inc., 1844 W. 21 St., Chicago 8, Ill.
- Ⓞ Radioactive Products, Inc., 443 W. Congress St., Detroit 26, Mich.
- Ⓞ Special Instruments Laboratories, Inc., 1003 Highland Ave., Knoxville, Tenn.
- Ⓞ Technical Associates, 3730 San Fernando Rd., Glendale 4, Calif.
- Ⓞ Technitrol Engineering Co., 3211 Woodland Ave., Philadelphia 4, Pa.
- Ⓞ Tracerlab, Inc., 130 High St., Boston 10, Mass.
- Ⓞ Triumph Mfg. Co., 913 W. Van Buren St., Chicago 7, Ill.
- Ⓞ VICTOREEN INSTRUMENT CO., 5806 Hough Ave., Cleveland 3, Ohio. ADV. PG. 272, 273.
- Ⓞ WESTINGHOUSE ELECTRIC CORP., 511 Wood St., P. O. Box 868, Pittsburgh 30, Pa. ADV. PG. 107-113.
- Ⓞ Wood Counter Laboratory, N., 5646 Harper Ave., Chicago 37, Ill.

INDICATORS—Hardness

- Ⓞ Barber-Colman Co., Rockford, Ill.
- Ⓞ Gordon Co., Claud S., 3000 S. Wallace St., Chicago 16, Ill.
- Ⓞ Hart Associates, 8430 Grand River, Detroit 4, Mich.
- Ⓞ INDUSTRIAL ELECTRONICS, INC., 8080 Wheeler St., Detroit 10, Mich. ADV. PG. 234, 235.
- Ⓞ Rubicon Co., 3761 Ridge Ave., Philadelphia 29, Pa.

INDICATORS—Humidity

- American Instrument Co., 8030 Georgia Ave., Silver Spring, Md.
- Ⓞ Bristol Co., The, Waterbury 20, Conn.
- Ⓞ Fielden Instrument Corp., 2920 N. 4th St., Philadelphia 33, Pa.
- Ⓞ Foxboro Co., The, Foxboro, Mass.
- Ⓞ Friez Instrument Div., Bendix Aviation Corp., Baltimore 4, Md.
- Ⓞ GENERAL ELECTRIC CO., Schenectady 5, N. Y. ADV. PG. 1 to 22.
- Ⓞ Manning, Maxwell & Moore, Inc., Stratford, Conn.
- Ⓞ MINNEAPOLIS-HONEYWELL REGULATOR CO., INDUSTRIAL DIV., Wayne & Roberts Aves., Philadelphia 44, Pa. ADV. PG. 208, 209.
- Ⓞ Serdex, Inc., 91 Cambridge St., Boston, Mass.
- Ⓞ Tech Laboratories, Inc., Bergen & Edsall Bldgs., Palisades Park, N. J.
- Ⓞ WESTON ELECTRICAL INSTRUMENT CORP., 595 Freylinghuysen Ave., Newark 5, N. J. ADV. PG. 243.

INDICATORS—Illumination

- Ⓞ Drake Mfg. Co., 1713 Hubbard St., Chicago 22, Ill.
- Ⓞ GENERAL ELECTRIC CO., Schenectady 5, N. Y. ADV. PG. 1 to 22.
- Ⓞ Industrial Electronics Co., Hanover, Mass.
- Ⓞ Lumenite Electric Co., 407 S. Dearborn St., Chicago 5, Ill.
- Ⓞ Nuclear Research Corp., 2707 Federal St., Philadelphia 46, Pa.
- Ⓞ WESTON ELECTRICAL INSTRUMENT CORP., 595 Freylinghuysen Ave., Newark 5, N. J. ADV. PG. 243.

INDICATORS—Liquid Level

- Ⓞ Airlectron Inc., P. O. Box 151, Caldwell, N. J.
- Ⓞ Autocall Co., The, Shelby, Ohio.
- Ⓞ Bailey Meter Co., 1044 Ivanhoe Rd., Cleveland 10, Ohio.
- Ⓞ Baldwin-Lima-Hamilton Corp., Paschall P. O. Station, Philadelphia 42, Pa.
- Ⓞ BOGUE ELECTRIC MFG. CO., 52 Iowa Ave., Paterson 3, N. J. ADV. PG. 155.
- Ⓞ Bristol Co., The, Waterbury 20, Conn.
- Ⓞ Bunnell & Co., J. H., 81 Prospect St., Brooklyn, N. Y.

V indicates . . . IN PRODUCTION • AVAILABILITY • UNRESTRICTED FOR GENERAL USE

- ✓Coral Designs Div. of Henry G. Dietz Co., 12-16 Astoria Blvd., Long Island City 2, N. Y.
- ✓Diamond Power Specialty Corp., Lancaster, Ohio.
- ✓ECLIPSE-PIONEER DIV., Bendix Aviation Corp., Teterboro, N. J. ADV. PG. 198, 199.
- ✓Fischer & Porter Co., Hatboro, Pa.
- ✓Fisher Research Lab., 1961 University Ave., Palo Alto, Calif.
- ✓Foxboro Co., The, Foxboro, Mass.
- ✓GENERAL ELECTRIC CO., Schenectady 5, N. Y. ADV. PG. 1 to 22.
- ✓Industrial Electronics Co., Hanover, Mass.
- ✓Lumenite Electric Co., 407 S. Dearborn St., Chicago 5, Ill.
- ✓Manning, Maxwell & Moore, Inc., Stratford, Conn.
- ✓MINNEAPOLIS-HONEYWELL REGULATOR CO., INDUSTRIAL DIV., Wayne & Roberts Aves., Philadelphia 44, Pa. ADV. PG. 208, 209.
- ✓Peschel Electronics, Inc., 13 Garden St., New Rochelle, N. Y.
- ✓Photostitch, Inc., 77 Broadway, Cambridge 42, Mass.
- ✓Tagliabue Div., Weston Electrical Instrument Corp., 614 Frelinghuysen Ave., Newark 5, N. J.
- ✓Thermo Instruments Co., Box 336, Belmont, Calif.
- ✓Vapor Recovery Systems Co., 2820 N. Alameda, Compton, Calif.
- ✓Warrick Co., Charles F., 16251 Hamilton Ave., Detroit 3, Mich.

INDICATORS—Materials Thickness

- ✓BRANSON INSTRUMENTS, INC., 438 Fairfield Ave., Stamford, Conn. ADV. PG. 90.
- ✓Electric Eye Equipment Co., 16 W. Fairchild St., Danville, Ill.
- ✓Fielden Instrument Corp., 2290 N. 4th St., Philadelphia 33, Pa.
- ✓GENERAL ELECTRIC CO., Schenectady 5, N. Y. ADV. PG. 1 to 22.
- ✓H. M. R. Electronics Inc., Grove St., New Canaan, Conn.
- ✓Hart Associates, 8430 Grand River, Detroit 4, Mich.
- ✓Industrial Electronics Co., Hanover, Mass.
- ✓INDUSTRIAL ELECTRONICS, INC., 8080 Wheeler St., Detroit 10, Mich. ADV. PG. 234, 235.
- ✓Kelley-Koett Instrument Co., 962 York St., Cincinnati 14, Ohio.
- ✓Pratt & Whitney Div., Niles-Bement-Pond Co., West Hartford 1, Conn.
- ✓Schaevitz Engineering, Crescent Blvd. at Drexel Ave., Pennsauken Township, Camden 11, N. J.
- ✓Sheffield Corp., Dayton 1, Ohio.
- ✓Standard Electronics Research Corp., 2 East End Ave., New York 21, N. Y.
- ✓Tracerlab, Inc., 130 High St., Boston 10, Mass.

INDICATORS—Moisture

- ✓Fielden Instrument Corp., 2290 N. 4th St., Philadelphia 33, Pa.
- ✓Foxboro Co., The, Foxboro, Mass.
- ✓GENERAL ELECTRIC CO., Schenectady 5, N. Y. ADV. PG. 1 to 22.
- ✓Gordon Co., Claud S., 3000 S. Wallace St., Chicago 16, Ill.
- ✓MARCONI INSTRUMENTS, LTD., 23 Beaver St., New York 4, N. Y. ADV. PG. 270.
- ✓MEASUREMENTS CORP., Boonton, N. J. ADV. PG. 99.
- ✓Tagliabue Div., Weston Electrical Instrument Corp., 614 Frelinghuysen Ave., Newark 5, N. J.
- ✓Tech Laboratories, Inc., Bergen & Edsall Bldgs., Palisades Park, N. J.

INDICATORS—Nuclear Radiation

- ✓AIRMEC LABORATORIES LTD., 366 Madison Ave., New York 17, N. Y. ADV. PG. 336.
- ✓Anton Electronic Laboratories, Inc., 1226-1238 Flushing Ave., Brooklyn 6, N. Y.
- ✓ATOMIC INSTRUMENT CO., 84 Massachusetts Ave., Cambridge 39, Mass. ADV. PG. 410.
- ✓BARKER & WILLIAMSON, 235 Fairfield Ave., Upper Darby, Pa. ADV. PG. 292.
- ✓Berkeley Scientific Corp., 2200 Wright Ave., Richmond, Calif.
- ✓Clarkstan Corp., 11921 SW. Pico Blvd., Los Angeles 64, Calif.
- ✓Douglas Radio Labs., 176 Norfolk Ave., Boston 19, Mass.
- ✓Electronic Products Co., 111 E. Third St., Mt. Vernon, N. Y.
- ✓EL-TRONICS, INC., 2649 N. Howard St., Philadelphia 33, Pa. ADV. PG. 299.
- ✓Flader, Inc., Fredric, 1330 Laskey Rd., Toledo 12, Ohio.
- ✓GENERAL ELECTRIC CO., Schenectady 5, N. Y. ADV. PG. 1 to 22.
- ✓GENERAL RADIO CO., 275 Massachusetts Ave., Cambridge 39, Mass. ADV. PG. 48, 49.
- ✓Georator Corp., 1820 N. Nash St., Arlington, Va.
- ✓Kelley-Koett Instrument Co., 962 York St., Cincinnati 14, Ohio.
- ✓Loudon Instruments, Inc., 5644 Lake Park Ave., Chicago 37, Ill.

- ✓MARCONI INSTRUMENTS, LTD., 23 Beaver St., New York 4, N. Y. ADV. PG. 270.
- ✓North American Phillips Co., 100 E. 42nd St., New York 17, N. Y.
- ✓Nuclear Instrument & Chemical Corp., 223 W. Erie St., Chicago 10, Ill.
- ✓Nuclear Measurements Corp., 3339 Central Ave., Indianapolis 5, Ind.
- ✓Nuclear Research Corp., 2707 Federal St., Philadelphia 46, Pa.
- ✓Nucleonic Corp. of America, 497 Union St., Brooklyn 31, N. Y.
- ✓POTTER INSTRUMENT CO., INC., 115 Cutter Mill Rd., Great Neck, N. Y. ADV. PG. 318.
- ✓R-C Scientific Instrument Co., 335 Culver Blvd., Playa Del Rey, Calif.
- ✓Radiation Counter Laboratories, Inc., 1844 W. 21st St., Chicago 8, Ill.
- ✓Radioactive Products, Inc., 443 W. Congress Ave., Detroit 26, Mich.
- ✓Special Instruments Laboratories, Inc., 1003 Highland Ave., Knoxville, Tenn.
- ✓Technical Associates, 3730 San Fernando Rd., Glendale 4, Calif.
- ✓Tracerlab, Inc., 130 High St., Boston 10, Mass.
- ✓VICTOREEN INSTRUMENT CO., 5806 Hough Ave., Cleveland 3, Ohio. ADV. PG. 272, 273.
- ✓WESTON ELECTRICAL INSTRUMENT CORP., 595 Frelinghuysen Ave., Newark 5, N. J. ADV. PG. 243.
- ✓Wood Counter Laboratory, N., 5646 Harper Ave., Chicago 37, Ill.

INDICATORS—Ocean Depth

- ✓Bludworth Marine Div., National-Simplex-Bludworth, Inc., 92 Gold St., New York 38, N. Y.
- ✓Intervox Corp., 2701 California Ave., Seattle 6, Wash.

INDICATORS—Oxygen

- ✓Bailey Meter Co., 1044 Ivanhoe Rd., Cleveland 10, Ohio.
- ✓Baker Co., Inc., 113 Astor St., Newark 5, N. J.

INDICATORS—pH

- ✓Bailey Meter Co., 1044 Ivanhoe Rd., Cleveland 10, Ohio.
- ✓Beckman Instruments, Inc., 800 Mission St., South Pasadena, Calif.
- ✓Bristol Co., The, Waterbury 20, Conn.
- ✓Central Scientific Co., 1700 Irving Park Rd., Chicago 13, Ill.
- ✓Foxboro Co., The, Foxboro, Mass.
- ✓La Motte Chemical Products Co., Towson 4, Baltimore, Md.
- ✓Leeds & Northrup Co., 4970 Stenton Ave., Philadelphia 44, Pa.
- ✓Mallinckrodt Chemical Works, Second & Mallinckrodt Sts., St. Louis 7, Mo.
- ✓MARCONI INSTRUMENTS, LTD., 23 Beaver St., New York 4, N. Y. ADV. PG. 270.
- ✓MINNEAPOLIS-HONEYWELL REGULATOR CO., INDUSTRIAL DIV., Wayne & Roberts Aves., Philadelphia 44, Pa. ADV. PG. 208, 209.
- ✓North American Phillips Co., Inc., 100 E. 42nd St., New York 17, N. Y.
- ✓Thwing-Albert Instrument Co., 5351 Pulaski Ave., Philadelphia 44, Pa.
- ✓Wallace & Tiernan Products, Inc., Belleville 9, N. J.

INDICATORS—Photographic Exposure

- ✓GENERAL ELECTRIC CO., Schenectady 5, N. Y. ADV. PG. 1 to 22.
- ✓HICKOK ELECTRICAL INSTRUMENT CO., 10514 Dupont Ave., Cleveland 8, Ohio. ADV. PG. 333.
- ✓MARION ELECTRICAL INSTRUMENT CO., Manchester, N. H. ADV. GP. 200.
- ✓Photocon Research Products, 1062 North Allen Ave., Pasadena 7, Calif.
- ✓WESTON ELECTRICAL INSTRUMENT CORP., 595 Frelinghuysen Ave., Newark 5, N. J. ADV. PG. 243.

INDICATORS—Positioning

- ✓Aeronautical Electronics, Inc., Raleigh-Durham Airport, P. O. Box 6043, Raleigh, N. C.
- ✓AIR ASSOCIATES, INC., Teterboro, N. J. ADV. PG. 211.
- ✓Airlectron, Inc., P. O. Box 151, Caldwell, N. J.
- ✓Allis-Chalmers Mfg. Co., 935 South 70th St., Milwaukee 1, Wis.
- ✓Avion Instrument Corp., Paramus, N. J.
- ✓Bunnell & Co., J. H., 81 Prospect St., Brooklyn, N. Y.
- ✓Diamond Power Specialty Corp., Lancaster, Ohio.
- ✓Doelcam Corp., 56 Elmwood St., Newton 58, Mass.
- ✓ECLIPSE-PIONEER DIV., Bendix Aviation Corp., Teterboro, N. J. ADV. PG. 198, 199.
- ✓GENERAL ELECTRIC CO., Schenectady 5, N. Y. ADV. PG. 1 to 22.

- ✓Hastings Instrument Co., Hampton 9, Va.
- ✓INDUSTRIAL ELECTRONICS, INC., 8080 Wheeler St., Detroit 10, Mich. ADV. PG. 234, 235.
- ✓Lear, Inc., 110 Ionia Ave., N. W., Grand Rapids 2, Mich.
- ✓REEVES INSTRUMENT CORP., 215 E. 91st St., New York, N. Y. ADV. PG. 315.
- ✓Robinette Co., W. C., 802 Fair Oaks Ave., South Pasadena, Calif.
- ✓Schaevitz Engineering, Crescent Blvd. at Drexel Ave., Pennsauken Township, Camden 11, N. J.
- ✓SERVO-TEK PRODUCTS CO., 4 Godwin Ave., Paterson 1, N. J. ADV. PG. 356.
- ✓Varo Mfg. Co., Inc., Box 638, Garland, Texas.

INDICATORS—Power Level

- ✓AIRMEC LABORATORIES LTD., 366 Madison Ave., New York 17, N. Y. ADV. PG. 336.
- ✓Assembly Products, Inc., Chagrin Falls 6, Ohio.
- ✓BIRD ELECTRONIC CORP., 1800 E. 38th St., Cleveland 14, Ohio. ADV. PG. 331.
- ✓DAVEN CO., 191 Central Ave., Newark 4, N. J. ADV. PG. 157.
- ✓GENERAL ELECTRIC CO., Schenectady 5, N. Y. ADV. PG. 1 to 22.
- ✓INTERNATIONAL INSTRUMENTS, INC., 331 East St., New Haven 13, Conn. ADV. PG. 322.
- ✓JONES ELECTRONICS CO., M. C., Bristol, Conn. ADV. PG. 384.
- ✓Leeds & Northrup Co., 4970 Stenton Ave., Philadelphia 40, Pa.
- ✓Meters, Inc., 915 Westfield Blvd., Indianapolis 20, Ind.
- ✓SPERRY GYROSCOPE CO., Div. of The Sperry Corp., Great Neck, N. Y. ADV. PG. 103, 104.
- ✓Triplet Electrical Instrument Co., Harmon Road, Bluffton, Ohio.
- ✓WESTINGHOUSE ELECTRIC CORP., 511 Wood St., P. O. Box 868, Pittsburgh 30, Pa. ADV. PG. 107-113.
- ✓WESTON ELECTRICAL INSTRUMENT CORP., 595 Frelinghuysen Ave., Newark 5, N. Y. ADV. PG. 243.

INDICATORS—Pressure

- ✓Autocall Co., The, Shelby, Ohio.
- ✓Bailey Meter Co., 1044 Ivanhoe Rd., Cleveland 10, Ohio.
- ✓Baldwin-Lima-Hamilton Corp., Paschall P. O. Station, Philadelphia 42, Pa.
- ✓Bristol Co., The, Waterbury 20, Conn.
- ✓Clarke Instrument Div., National Electrical Machine Shops, Inc., 919 Jesup-Blair Dr., Silver Spring, Md.
- ✓CONTINENTAL ELECTRIC CO., Geneva, Ill. ADV. PG. 182.
- ✓Control Engineering Corp., 863 Washington St., Canton, Mass.
- ✓Coral Designs Div. of Henry G. Dietz Co., 12-16 Astoria Blvd., Long Island City 2, N. Y.
- ✓ECLIPSE-PIONEER DIV., BENDIX AVIATION CORP., Teterboro, N. J. ADV. PG. 198, 199.
- ✓ELECTRO PRODUCTS LABS., 4501 N. Ravenswood Ave., Chicago 40, Ill. ADV. PG. 199.
- ✓Flader, Inc., Fredric, 1330 Laskey Rd., Toledo 12, Ohio.
- ✓Foxboro Co., The, Foxboro, Mass.
- ✓GENERAL ELECTRIC CO., Schenectady 5, N. Y. ADV. PG. 1 to 22.
- ✓INDUSTRIAL ELECTRONICS, INC., 8080 Wheeler St., Detroit 10, Mich. ADV. PG. 234, 235.
- ✓Manning, Maxwell & Moore, Inc., Stratford, Conn.
- ✓Midwestern Geophysical Laboratory, 3400 S. Harvard, Tulsa, Okla.
- ✓MINNEAPOLIS-HONEYWELL REGULATOR CO., INDUSTRIAL DIV., Wayne & Roberts Aves., Philadelphia 44, Pa. ADV. PG. 208, 209.
- ✓Photocon Research Products, 1062 N. Allen Ave., Pasadena 7, Calif.
- ✓Schaevitz Engineering, Crescent Blvd. at Drexel Ave., Pennsauken Township, Cambridge 11, N. J.
- ✓Sierra Electronic Corp., San Carlos, Calif.
- ✓Technitrol Engineering Co., 3211 Woodland Ave., Philadelphia 4, Pa.
- ✓Trans-Sonics, Inc., Bedford Airport, Bedford, Mass.
- ✓U. S. Gauge Div., American Machine & Metals, Inc., Sellersville, Pa.
- ✓Wallace & Tiernan Products, Inc., Belleville 9, N. J.

INDICATORS—Pulse Time Riser

- ✓AIRMEC LABORATORIES LTD., 366 Madison Ave., New York 17, N. Y. ADV. PG. 336.
- ✓Radioactive Products, Inc., 443 W. Congress St., Detroit 26, Mich.

INDICATORS—Recording Engine

- ✓Standard Telephones & Cables Ltd., Connaught House, Aldwych, London, W.C. 2, England.

V indicates . . . IN PRODUCTION • AVAILABILITY • UNRESTRICTED FOR GENERAL USE

INDICATORS—*rf Probe*

- ⊕AIRMEC LABORATORIES LTD., 366 Madison Ave., New York 17, N. Y. ADV. PG. 336.
- ⊕CITATION PRODUCTS CO., 233 E. 146th St., New York 51, N. Y. ADV. PG. 388.
- ⊕Feiler Engineering Co., 8026 Monticello Ave., Skokie, Ill.
- ⊕Javex, 921 State, Garland, Texas.
- ⊕KINGS MICROWAVE CO., INC., 50 Marbledale Rd., Tuckahoe 7, N. Y. ADV. PG. 178, 179.
- ⊕McMurdo Silver Co., Inc., 473 Lafayette St., New York, N. Y.
- ⊕MARCONI INSTRUMENTS, LTD., 23 Beaver St., New York 4, N. Y. ADV. PG. 270.
- ⊕WESTON ELECTRICAL INSTRUMENT CORP., 595 Frelinghuysen Ave., Newark 5, N. J. ADV. PG. 243.

INDICATORS—*Shorted Turn*

- ⊕AIRMEC LABORATORIES LTD., 366 Madison Ave., New York 17, N. Y. ADV. PG. 336.
- ⊕GENERAL ELECTRIC CO., Schenectady 5, N. Y. ADV. PG. 1 to 22.
- ⊕Kartron, Drawer 472, Huntington Beach, Calif.
- ⊕PENNSYLVANIA TESTING LABORATORY, Doylestown, Pa. ADV. PG. 350.
- ⊕Rubicon Co., 3761 Ridge Ave., Philadelphia 29, Pa.

INDICATORS—*Smoke & Combustion*

- ⊕Bailey Meter Co., 1044 Ivanhoe Road, Cleveland 10, Ohio.
- ⊕De-Tec-Tronic Laboratories, Inc., 1711 Terra Cotta Pl., Chicago 14, Ill.
- ⊕Diamond Power Specialty Corp., Lancaster, Ohio.
- ⊕Electronic Control Corp., 1573 E. Forest St., Detroit, Mich.
- ⊕Ess Specialty Corp., 96 So. Washington Ave., Bergenfield, N. J.
- ⊕GENERAL ELECTRIC CO., Schenectady 5, N. Y. ADV. PG. 1 to 22.
- ⊕Industrial Electronics Co., Hanover, Mass.
- ⊕Leeds & Northrup Co., 4970 Stenton Ave., Philadelphia 44, Pa.
- ⊕Lumenite Electric Co., 407 S. Dearborn St., Chicago 5, Ill.
- ⊕Photobell Company, 116 Nassau St., New York 7, N. Y.
- ⊕VICTORY ENGINEERING CORP., 744 Broad St., Newark, N. J. ADV. PG. 203.
- ⊕Worner Electronic Devices, Rankin, Ill.

INDICATORS—*Sound Level*

- ⊕AIRMEC LABORATORIES LTD., 366 Madison Ave., New York 17, N. Y. ADV. PG. 336.
- ⊕Bunnell & Co., J. H., 81 Prospect St., Brooklyn, N. Y.
- ⊕DAVEN CO., 191 Central Ave., Newark 4, N. J. ADV. PG. 157.
- ⊕Feiler Engineering Co., 8026 Monticello Ave., Skokie, Ill.
- ⊕GENERAL ELECTRIC CO., Schenectady 5, N. Y. ADV. PG. 1 to 22.
- ⊕GENERAL RADIO CO., 275 Massachusetts Ave., Cambridge 39, Mass. ADV. PG. 48, 49.
- ⊕McMurdo Silver Co., Inc., 473 Lafayette St., New York, N. Y.
- ⊕Massa Laboratories, 3868 Carnegie St., Cleveland, Ohio.
- ⊕Scott, Inc., Hermon Hosmer, 385 Putnam Ave., Cambridge 39, Mass.
- ⊕Standard Telephones & Cables Ltd., Connaught House, Aldwych, London, W.C. 2, England.
- ⊕Triplet Electrical Instrument Co., Harmon Road, Bluffton, Ohio.
- ⊕WESTON ELECTRICAL INSTRUMENT CORP., 595 Frelinghuysen Ave., Newark 5, N. J. ADV. PG. 243.

INDICATORS—*Specific Gravity*

- Engineering Lab., Inc., 602 E. 4th St., Tulsa 3, Okla.
- ⊕Ess Specialty Corp., 96 So. Washington Ave., Bergenfield, N. J.
- ⊕Fielden Instrument Corp., 2920 N. 4th St., Philadelphia 33, Pa.
- ⊕Fischer & Porter Co., Hatboro, Pa.
- ⊕HICKOK ELECTRICAL INSTRUMENT CO., 10514 Dupont Ave., Cleveland 8, Ohio. ADV. PG. 333.
- ⊕Leeds & Northrup Co., 4970 Stenton Ave., Philadelphia 44, Pa.
- ⊕MINNEAPOLIS-HONEYWELL REGULATOR CO., INDUSTRIAL DIV., Wayne & Roberts Aves., Philadelphia 44, Pa. ADV. PG. 208, 209.

INDICATORS—*Strain*

- ⊕Anderson, Arthur R., 110 Woodbury Ave., Springdale, Conn.
- ⊕Avion Instrument Corp., Paramus, N. J.
- ⊕Baldwin-Lima-Hamilton Corp., Paschall P. O. Station, Philadelphia 42, Pa.
- ⊕Cole Instrument Co., 1320 S. Grand Ave., Los Angeles 15, Calif.
- ⊕Control Engineering Corp., 863 Washington St., Canton, Mass.

- ⊕EDIN CO., INC., 207 Main St., Worcester, Mass. ADV. PG. 285.
- ⊕Ellis Associates, Box 77, Pelham 65, N. Y.
- ⊕GENERAL ELECTRIC CO., Schenectady 5, N. Y. ADV. PG. 1 to 22.
- ⊕Hathaway Instrument Co., 1315 S. Clarkson St., Denver 10, Colo.
- ⊕INDUSTRIAL ELECTRONICS, INC., 8080 Wheeler St., Detroit 10, Mich. ADV. PG. 234, 235.
- ⊕Leeds & Northrup Co., 4970 Stenton Ave., Philadelphia 44, Pa.
- ⊕Midwestern Geophysical Laboratory, 3400 S. Harvard, Tulsa, Okla.
- ⊕Schaevitz Engineering, Crescent Blvd. at Drexel Ave., Pennsauken Township, Camden 11, N. J.

INDICATORS—*Telemetry*

- ⊕Aeronautical Electronics, Inc., Raleigh-Durham Airport, P. O. Box 6043, Raleigh, N. C.
- ⊕AIR ASSOCIATES, INC., Teterboro, N. J. ADV. PG. 211.
- ⊕AIRMEC LABORATORIES LTD., 366 Madison Ave., New York 17, N. Y. ADV. PG. 336.
- ⊕Avion Instrument Corp., Paramus, N. J.
- ⊕Bailey Meter Co., 1044 Ivanhoe Rd., Cleveland 10, Ohio.
- ⊕Bendix Aviation Corp., Pacific Division, 11600 Sherman Way, N. Hollywood, Calif.
- ⊕Berkeley Scientific Corp., 2200 Wright Ave., Richmond, Calif.
- ⊕Bristol Co., The, Waterbury 20, Conn.
- ⊕Diamond Power Specialty Corp., Lancaster, Ohio.
- ⊕Flader, Inc., Fredric, 1330 Laskey Rd., Toledo 12, Ohio.
- ⊕GENERAL ELECTRIC CO., Schenectady 5, N. Y. ADV. PG. 1 to 22.
- ⊕Lear, Inc., 110 Ionia Ave., NW., Grand Rapids 2, Mich.
- ⊕RAHM INSTRUMENTS, INC., 12 W. Broadway, New York 7, N. Y. ADV. PG. 354.
- ⊕Thompson & Associates, John E., 7210 S. Yates Ave., Chicago 49, Ill.
- ⊕Trans-Sonics, Inc., Bedford Airport, Bedford, Mass.

INDICATORS—*Temperature*

- ⊕Assembly Products, Inc., Chagrin Falls 6, Ohio.
- ⊕Bailey Meter Co., 1044 Ivanhoe Rd., Cleveland 10, Ohio.
- ⊕Cole Instrument Co., 1320 S. Grand Ave., Los Angeles 15, Calif.
- ⊕Dillon & Co., W. C., 1421 S. Circle Ave., Forest Park, Ill.
- ⊕EDISON, INC., THOMAS A., Instrument Div., West Orange, N. J. ADV. PG. 212, 213.
- ⊕Foxboro Co., The, Foxboro, Mass.
- ⊕GENERAL ELECTRIC CO., Schenectady 5, N. Y. ADV. PG. 1 to 22.
- ⊕Gordon Co., Claud S., 3000 S. Wallace St., Chicago 16, Ill.
- ⊕H. M. R. Electronics Inc., Grove St., New Cannan, Conn.
- ⊕HICKOK ELECTRICAL INSTRUMENT CO., 10514 Dupont Ave., Cleveland 8, Ohio. ADV. PG. 333.
- ⊕Illinois Testing Labs., Inc., 420 N. LaSalle St., Chicago 10, Ill.
- ⊕J B T INSTRUMENTS, INC., 431-B Chapel St., New Haven 8, Conn. ADV. PG. 351.
- ⊕Leeds & Northrup Co., 4970 Stenton Ave., Philadelphia 44, Pa.
- ⊕Loudon Instruments, Inc., 5644 Lake Park Ave., Chicago 37, Ill.
- ⊕Meters, Inc., 915 Westfield Blvd., Indianapolis 20, Ind.
- ⊕MINNEAPOLIS-HONEYWELL REGULATOR CO., INDUSTRIAL DIV., Wayne & Roberts Aves., Philadelphia 44, Pa. ADV. PG. 208, 209.
- ⊕Philadelphia Thermometer Co., 4401 N. Sixth St., Philadelphia, Pa.
- ⊕Rubicon Co., 3761 Ridge Ave., Philadelphia 29, Pa.
- ⊕Serdex, Inc., 91 Cambridge St., Boston, Mass.
- ⊕SERVO CORP. OF AMERICA, 20-20 Jericho Turnpike, New Hyde Park, N. Y. ADV. PG. 150, 151.
- ⊕Simpson Electric Co., Div. of American Gage & Machine Co., 5218 W. Kinzie St., Chicago 44, Ill.
- ⊕Trans-Sonics, Inc., Bedford Airport, Bedford, Mass.
- ⊕U. S. Gauge Div., American Machine & Metals, Inc., Sellersville, Pa.
- ⊕Welch Scientific Co., W. M., 1515 Sedgwick St., Chicago 10, Ill.
- ⊕WESTINGHOUSE ELECTRIC CORP., 511 Wood St., P. O. Box 868, Pittsburgh 30, Pa. ADV. PG. 107-113.
- ⊕WESTON ELECTRICAL INSTRUMENT CORP., 595 Frelinghuysen Ave., Newark 5, N. J. ADV. 243.
- ⊕Wheeco Instruments Co., 847 W. Harrison St., Chicago 7, Ill.
- ⊕Winslow Co., Inc., 9 Liberty St., Newark 5, N. J.

INDICATORS—*Timing*

- ⊕AIRMEC LABORATORIES LTD., 366 Madison Ave., New York 17, N. Y. ADV. PG. 336.
- ⊕Berkeley Scientific Corp., 2200 Wright Ave., Richmond, Calif.

- ⊕Cossor (Canada) Ltd., 301-303 Windsor St., Halifax, N. S., Canada.
- ⊕CRAMER CO., INC., R. W., Box 13, Centerbrook, Conn. ADV. PG. 202.
- ⊕Electronic Tachometer Corp., 2218 Vine St., Philadelphia 3, Pa.
- ⊕GENERAL ELECTRIC CO., Schenectady 5, N. Y. ADV. PG. 1 to 22.
- ⊕Hart Associates, 8430 Grand River, Detroit 4, Mich.
- ⊕HAYDON CO., A. W., THE, 232 N. Elm St., Waterbury 20, Conn. ADV. PG. 402.
- ⊕HAYDON MFG. CO., INC., 584 E. Elm St., Torrington, Conn. ADV. PG. 216, 217.
- ⊕Ionic Electronic Equipment Co., 1705 N. Kenmore, Los Angeles 27, Calif.
- ⊕Lektra Laboratories, 154-11th Ave., New York, N. Y.
- ⊕Lumenite Electric Co., 407 S. Dearborn St., Chicago 5, Ill.
- ⊕POTTER INSTRUMENT CO., INC., 115 Cutter Mill Rd., Great Neck, N. Y. ADV. PG. 318.
- ⊕SESSIONS CLOCK CO., TIMER DIV., Forestville, Conn. ADV. PG. 123.
- ⊕Sherman Industrial Electronics Co., Inc., 505 Washington Ave., Belleville 9, N. J.
- ⊕Special Instruments Laboratories, Inc., 1003 Highland Ave., Knoxville, Tenn.
- ⊕STANDARD ELECTRIC TIME CO., 89 Logan St., Springfield, Mass. ADV. PG. 40.
- ⊕Walkirt Co., 5808 Marilyn Ave., Culver City, Calif.
- ⊕Weltronic Co., 19500 W. Eight Mile Rd., Detroit 9, Mich.
- ⊕WESTINGHOUSE ELECTRIC CORP., 511 Wood St., P. O. Box 868, Pittsburgh 30, Pa. ADV. PG. 107-113.

INDICATORS—*Torque*

- ⊕Avion Instrument Corp., Paramus, N. J.
- ⊕Baldwin-Lima-Hamilton Corp., Paschall P. O. Station, Philadelphia 42, Pa.
- ⊕Flader, Inc., Fredric, 1330 Laskey Rd., Toledo 12, Ohio.
- ⊕GENERAL ELECTRIC CO., Schenectady 5, N. Y. ADV. PG. 1 to 22.
- ⊕INDUSTRIAL ELECTRONICS, INC., 8080 Wheeler St., Detroit 10, Mich. ADV. PG. 234, 235.

INDICATORS—*Turbidity*

- ⊕GENERAL ELECTRIC CO., Schenectady 5, N. Y. ADV. PG. 1 to 22.
- ⊕Hart Associates, 8430 Grand River, Detroit 4, Mich.
- ⊕Photobell Company, 116 Nassau St., New York 7, N. Y.

INDICATORS—*Vacuum*

- ⊕Bailey Meter Co., 1044 Ivanhoe Rd., Cleveland 10, Ohio.
- ⊕Bristol Co., The, Waterbury 20, Conn.
- ⊕Central Scientific Co., 1700 Irving Park Road, Chicago 13, Ill.
- ⊕Clarke Instrument Div., National Electrical Machine Shops, Inc., 919 Jesup-Blair Dr., Silver Spring, Md.
- ⊕CONTINENTAL ELECTRIC CO., Geneva, Ill. ADV. PG. 182.
- ⊕Distillation Products Div. of Eastman Kodak Co., 755 Ridge Rd., W., Rochester 3, N. Y.
- ⊕Electronic Engineering Corp., 469 Elm St., Arlington, N. J.
- ⊕Fredericks Co., Geo. E., Bethayres, Pa.
- ⊕GENERAL ELECTRIC CO., Schenectady 5, N. Y. ADV. PG. 1 to 22.
- ⊕Hastings Instrument Co., Inc., Hampton 8, Va.
- ⊕Manning, Maxwell & Moore, Inc., Stratford, Conn.
- ⊕MINNEAPOLIS-HONEYWELL REGULATOR CO., INDUSTRIAL DIV., Wayne & Roberts Aves., Philadelphia 44, Pa. ADV. PG. 208, 209.
- ⊕National Research Corp., 70 Memorial Drive, Cambridge 42, Mass.
- ⊕Process & Instruments, 60 Greenpoint Ave., Brooklyn 22, N. Y.
- ⊕Research Electronics Lab., 2459 Susquehanna Rd., Roslyn, Pa.
- ⊕U. S. Gauge Div., American Machine & Metals, Inc., Sellersville, Pa.
- ⊕Wallace & Tiernan Products, Inc., Belleville 9, N. J.
- ⊕Welch Scientific Co., W. M., 1515 Sedgwick St., Chicago 10, Ill.
- ⊕Winslow Co., Inc., 9 Liberty St., Newark 5, N. J.

INDICATORS—*Volume*

- ⊕AIRMEC LABORATORIES LTD., 366 Madison Ave., New York 17, N. Y. ADV. PG. 336.
- ⊕CINEMA ENGINEERING CO., 1510 W. Verdugo Ave., Burbank, Calif. ADV. PG. 204.
- ⊕Fairchild Recording Equipment Corp., 154 St. & Seventh Avenue, Whitestone, N. Y.
- ⊕Feiler Engineering Co., 8026 Monticello Ave., Skokie, Ill.
- ⊕GENERAL ELECTRIC CO., Schenectady 5, N. Y. ADV. PG. 1 to 22.

Ⓢ indicates . . . IN PRODUCTION • AVAILABILITY • UNRESTRICTED FOR GENERAL USE

- Ⓢ Standard Telephones & Cables Ltd., Connaught House, Aldwych, London, W.C. 2, England.
- Ⓢ Triplett Electrical Instrument Co., Harmon Road, Bluffton, Ohio.

INDICATORS—Weight

- Ⓢ Baldwin-Lima-Hamilton Corp., Paschall P. O. Station, Philadelphia 42, Pa.
- Ⓢ Dillon & Co., Inc., W. C., 1421 S. Circle Ave., Forest Park, Ill.
- Ⓢ Flader, Inc., Fredric, 1330 Laskey Rd., Toledo 12, Ohio.
- Ⓢ INDUSTRIAL ELECTRONICS INC., 8080 Wheeler St., Detroit 10, Mich. ADV. PG. 234, 235.
- Ⓢ Leeds & Northrup Co., 4970 Stenton Ave., Philadelphia 44, Pa.
- Ⓢ Schaevitz Engineering, Crescent Blvd. at Drexel Ave., Pennsauken Township, Camden 11, N. J.

INDUCTANCES—Metalized Glass

- Ⓢ CORNING GLASS WORKS, Corning, N. Y. ADV. PG. 373.

INDUCTION HEATING

See Heating, Induction

INDUCTORS

See Chokes and Coils, Choke

INFRA-RED DRYING OVENS

See Ovens

INSPECTION EQUIPMENT—Lighting

- Ⓢ General Cement Mfg. Co., 919 Taylor Ave., Rockford, Ill.
- Ⓢ Menlo Research Laboratory, Menlo Park, Calif.
- Ⓢ St. John X-Ray Laboratory, Califon, N. J.
- Ⓢ Sheffield Corp., Dayton 1, Ohio.

INSTRUMENT PARTS—Precision

- Ⓢ American Laubscher Corp., 333 W. 52nd St., New York 19, N. Y.
- Ⓢ Arma Corp., 254 36th St., Brooklyn 32, N. Y.
- Ⓢ ART WIRE & STAMPING CO., 227 High St., Newark 2, N. J. ADV. PG. 38.
- Ⓢ Beede Electrical Instrument Co., Inc., Penacook, N. H.
- Ⓢ BELLOCK INSTRUMENT CORP., 111th St. & 14th Ave., College Point, N. Y. ADV. PG. 371.
- Ⓢ Berndt-Bach, Inc., 7373 Beverly Blvd., Los Angeles 36, Calif.
- Ⓢ CITATION PRODUCTS CO., 233 E. 146th St., New York 51, N. Y. ADV. PG. 388.
- Ⓢ DAVEN CO., 191 Central Ave., Newark 4, N. J. ADV. PG. 157.
- Ⓢ Eastern Specialty Co., Philadelphia 40, Pa.
- Ⓢ Farrand Optical Co., Inc., Bronx Blvd. at 238th St., New York 70, N. Y.
- Ⓢ Felsenthal & Sons Inc., G., 4100 W. Grand Ave., Chicago 51, Ill.
- Ⓢ Georator Corp., 1820 N. Nash St., Arlington, Va.
- Ⓢ Gorrell & Gorrell, Haworth, N. J.
- Ⓢ Keystone Electronics Corp., 423 Broome St., New York 12, N. Y.
- Ⓢ Lear, Inc., 110 Ionia Ave., N. W., Grand Rapids 2, Mich.
- Ⓢ LEE MECHANICAL LABS. DIV. OF LEE SPRING CO., INC., 30 Main St., Brooklyn 1, N. Y. ADV. PG. 303.
- Ⓢ McElroy Mfg. Corp., Littleton, Mass.
- Ⓢ NEEY CO., J. M., 179 Elm St., Hartford, Conn. ADV. PG. 246.
- Ⓢ Peerless Instrument Co., 90-15 Corona Ave., Elmhurst, N. Y.
- Ⓢ PIX MFG. CO., INC., 24 Bedford St., Newark, N. J. ADV. PG. 136.
- Ⓢ Plume & Atwood Mfg. Co., 220 Broadway, New York, N. Y.
- Ⓢ Precision Devices, Inc., 147-149 Cedar St., New York 6, N. Y.
- Ⓢ Process & Instruments, 60 Greenpoint Ave., Brooklyn 22, N. Y.
- Ⓢ REEVES INSTRUMENT CORP., 215 E. 91st Street, New York N. Y. ADV. PG. 315.
- Ⓢ Roller-Smith, Bethlehem, Pa.
- Ⓢ Rubicon Co., 3761 Ridge Ave., Philadelphia 29, Pa.
- Ⓢ Serdex, Inc., 91 Cambridge St., Boston, Mass.
- Ⓢ Stamford Metal Specialty Co., Inc., 429 W. Broadway, New York 12, N. Y.
- Ⓢ Uniform Tubes, Shurs Lane & Laruiston St., Roxborough, Philadelphia 28, Pa.
- Ⓢ Vallorbs Jewel Co., Lancaster, Pa.
- Ⓢ VECTOR, INC., 235 High St., Waltham, Mass. ADV. PG. 214.
- Ⓢ Walter Co., Inc., S., 1400 Atlantic Ave., Brooklyn 16, N. Y.
- Ⓢ Welch Scientific Co., W. M., 1515 Sedgwick St., Chicago 10, Ill.

INSTRUMENTS—Electronic Musical

- Ⓢ Applied Physics Corp., 362 W. Colorado St., Pasadena 1, Calif.
- Ⓢ Baldwin-Lima-Hamilton Corp., Paschall P.O. Station, Philadelphia 42, Pa.

- Ⓢ BRUSH DEVELOPMENT CO., 3405 Perkins Ave., Cleveland 14, Ohio. ADV. PG. 228, 229.
- Ⓢ CONN LTD., C. G., Electronics Div., 1001 Beardsley Ave., Elkhart, Ind. ADV. PG. 302.
- Ⓢ HICKOK ELECTRICAL INSTRUMENT CO., 10514 Dupont Ave., Cleveland 8, Ohio. ADV. PG. 333.
- Ⓢ Magna Electronics Co., 3707-11 W. Jefferson Blvd., Los Angeles 16, Calif.
- Ⓢ Roller-Smith, Bethlehem, Pa.
- Ⓢ Wheelco Instruments Co., 847 W. Harrison St., Chicago 7, Ill.
- Ⓢ Wurlitzer Co., Rudolph, The, N. Tonawanda, N. Y.

INSTRUMENTS—Graphic Recording

- Ⓢ AMERICAN TIME PRODUCTS, INC., 580 Fifth Ave., New York 19, N. Y. ADV. PG. 226.
- Ⓢ Antenna Research Lab., Inc., 797 Thomas Lane, Columbus 14, Ohio.
- Ⓢ Bailey Meter Co., 1044 Ivanhoe Rd., Cleveland 10, Ohio.
- Ⓢ Baldwin-Lima-Hamilton Corp., Paschall P.O. Station, Philadelphia 42, Pa.
- Ⓢ Boehme, Inc., H. O., 915 Broadway, New York 10, N. Y.
- Ⓢ Bristol Co., The, Waterbury 20, Conn.
- Ⓢ BRUSH DEVELOPMENT CO., 3405 Perkins Ave., Cleveland 14, Ohio. ADV. PG. 228, 229.
- Ⓢ Century Geophysical Corp., 1333 N. Utica, Tulsa 3, Okla.
- Ⓢ Consolidated Engineering Corp., 300 N. Sierra Madre Villa, Pasadena 8, Calif.
- Ⓢ EDIN CO., INC., 207 Main St., Worcester, Mass. ADV. PG. 285.
- Ⓢ Electric Tachometer Corp., 2218 Vine St., Philadelphia 3, Pa.
- Ⓢ Esterline-Angus Co., Inc., P. O. Box 596, Indianapolis 6, Ind.
- Ⓢ Fielden Instrument Corp., 2920 N. 4th St., Philadelphia 33, Pa.
- Ⓢ Flader, Inc., Fredric, 1330 Laskey Rd., Toledo 12, Ohio.
- Ⓢ GENERAL ELECTRIC CO., Schenectady 5, N. Y. ADV. PG. 1 to 22.
- Ⓢ Gorrell & Gorrell, Haworth, N. J.
- Ⓢ Hathaway Instrument Co., 1315 S. Clarkson St., Denver 10, Colo.
- Ⓢ Hogan Laboratories, Inc., 155 Perry St., New York 14, N. Y.
- Ⓢ KAY ELECTRIC CO., 14 Maple Ave., Pine Brook, N. J. ADV. PG. 340.
- Ⓢ Leeds & Northrup Co., 4970 Stenton Ave., Philadelphia 44, Pa.
- Ⓢ McElroy Mfg. Corp., Littleton, Mass.
- Ⓢ Manning, Maxwell & Moore, Inc., Stratford, Conn.
- Ⓢ Midwestern Geophysical Laboratory, 3400 S. Harvard, Tulsa, Okla.
- Ⓢ MINNEAPOLIS-HONEYWELL REGULATOR CO., INDUSTRIAL DIV., Wayne & Roberts Aves., Philadelphia 44, Pa. ADV. PG. 208, 209.
- Ⓢ Photron Instrument Co., 6516 Detroit Ave., Cleveland 2, Ohio.
- Ⓢ PRECISE MEASUREMENTS CO., 942 Kings Highway, Brooklyn 23, N. Y. ADV. PG. 401.
- Ⓢ RAHM INSTRUMENTS, INC., 12 W. Broadway, New York 7, N. Y. ADV. PG. 354.
- Ⓢ SANBORN CO., 39 Osborn St., Cambridge 39, Mass. ADV. PG. 391.
- Ⓢ Tagliabue Div., Weston Electrical Instrument Corp., 614 Frelinghuysen Ave., Newark 5, N. J.
- Ⓢ Thwing-Albert Instrument Co., 5351 Pulaski Ave., Philadelphia 44, Pa.
- Ⓢ Wallace & Tiernan Products, Inc., Belleville 9, N. J.
- Ⓢ WESTINGHOUSE ELECTRIC CORP., 511 Wood St., P.O. Box 868, Pittsburgh 30, Pa. ADV. PG. 107-113.
- Ⓢ Wheelco Instruments Co., 847 W. Harrison St., Chicago 7, Ill.

INSTRUMENTS—Panel

- Ⓢ ART-LOYD METAL PRODUCTS CORP., 2973 Cropsy Ave., Brooklyn 14, N. Y. ADV. PG. 364.
- Ⓢ Assembly Products, Inc., Chagrin Falls 6, Ohio.
- Ⓢ Associated Research, Inc., 3758 W. Belmont, Chicago 18, Ill.
- Ⓢ Bailey Meter Co., 1044 Ivanhoe Rd., Cleveland 10, Ohio.
- Ⓢ Baldwin-Lima-Hamilton Corp., Paschall P.O. Station, Philadelphia 42, Pa.
- Ⓢ Beede Electrical Instrument Co., Penacook, N. H.
- Ⓢ Bristol Co., The, Waterbury 20, Conn.
- Ⓢ Burlington Instrument Co., Burlington, Iowa.
- Ⓢ Cole Instrument Co., 1320 S. Grand Ave., Los Angeles 15, Calif.
- Ⓢ Corry-Jamestown Mfg. Co., Corry, Pa.
- Ⓢ Cutler Metal Products Co., 1025 Line St., Camden, N. J.
- Ⓢ DeJUR-AMSCO CORP., Northern Blvd. at 45th St., Long Island City 1, N. Y. ADV. PG. 377.
- Ⓢ Electro-Mechanical Instrument Co., 812 Chestnut St., Perkasie, Pa.
- Ⓢ Etched Products Corp., 39-01 Queens Blvd., Long Island City, N. Y.
- Ⓢ GENERAL ELECTRIC CO., Schenectady 5, N. Y. ADV. PG. 1 to 22.
- Ⓢ Gordon Co., Claud S., 3000 S. Wallace St., Chicago 16, Ill.

- Ⓢ HICKOK ELECTRICAL INSTRUMENT CO., 10514 Dupont Ave., Cleveland 8, Ohio. ADV. PG. 333.
- Ⓢ INTERNATIONAL INSTRUMENTS, INC., 331 East St., New Haven 11, Conn. ADV. PG. 322.
- Ⓢ Manning, Maxwell & Moore, Inc., Stratford, Conn.
- Ⓢ MARION ELECTRICAL INSTRUMENT CO., Manchester, N. H. ADV. PG. 200.
- Ⓢ Meters, Inc., 915 Westfield Blvd., Indianapolis 20, Ind.
- Ⓢ New London Instrument Co., Box 189, New London, Conn.
- Ⓢ Oak Ridge Products Mfg. Div. of Video Television, Inc., 37-01 Vernon Blvd., Long Island City 1, N. Y. Plastic Accessories Inc., 93 Mercer St., New York 12, N. Y.
- Ⓢ Printloid, Inc., 95 Mercer St., New York, N. Y.
- Ⓢ Q. V. S. Inc., 15 South Essex St., Orange, N. J.
- Ⓢ Reliance Instrument Co., 3027 W. Van Buren St., Chicago 12, Ill.
- Ⓢ Roller-Smith, Bethlehem, Pa.
- Ⓢ Sensitive Research Instrument Corp., 9 Elm Ave., Mt. Vernon, N. Y.
- Ⓢ SHURITE METERS, 35-B Hamilton St., New Haven 8, Conn. ADV. PG. 390.
- Ⓢ Simpson Electric Co., Div. of American Gage & Machine Co., 5218 W. Kinzie St., Chicago 44, Ill.
- Ⓢ Sterling Mfg. Co., 9205 Detroit Ave., Cleveland 2, Ohio.
- Ⓢ Triplett Electrical Instrument Co., Harmon Road, Bluffton, Ohio.
- Ⓢ Walter Co., Inc., S., 1400 Atlantic Ave., Brooklyn 16, N. Y.
- Ⓢ Welch Scientific Co., W. M., 1515 Sedgwick St., Chicago 10, Ill.
- Ⓢ WESTINGHOUSE ELECTRIC CORP., 511 Wood St., P.O. Box 868, Pittsburgh 30, Pa. ADV. PG. 107-113.
- Ⓢ WESTON ELECTRICAL INSTRUMENT CORP., 595 Frelinghuysen Ave., Newark 5, N. J. ADV. PG. 243.
- Ⓢ Winslow Co., Inc., 9 Liberty St., Newark 5, N. J.

INSTRUMENTS—Ultrasonic

- Ⓢ AIRMEC LABORATORIES LTD., 366 Madison Ave., New York 17, N. Y. ADV. PG. 336.
- Ⓢ BRANSON INSTRUMENTS, INC., 438 Fairfield Ave., Stamford, Conn. ADV. PG. 90.
- Ⓢ BRUSH DEVELOPMENT CO., 3405 Perkins Ave., Cleveland 14, Ohio. ADV. PG. 228, 229.
- Ⓢ CLARK CRYSTAL CO., 2 Farm Rd., Marlboro, Mass. ADV. PG. 366.
- Ⓢ Dallons Labs., 5066 Santa Monica Blvd., Los Angeles, Calif.
- Ⓢ DAVEN CO., 191 Central Ave., Newark 4, N. J. ADV. PG. 157.
- Ⓢ Dice Co., J. W., Englewood, N. J.
- Ⓢ Edo Corp., College Point, N. Y.
- Ⓢ Fisher Scientific Co., 717 Forbes St., Pittsburgh 19, Pa.
- Ⓢ Gertsch Products, Inc., 11846 Mississippi Ave., Los Angeles 25, Calif.
- Ⓢ Massa Laboratories, 3868 Carnegie St., Cleveland, Ohio.
- Ⓢ Photocon Research Products, 1062 N. Allen Ave., Pasadena 7, Calif.
- Ⓢ Piezo Products Co., Whitney St., Framingham, Mass.
- Ⓢ SPERRY PRODUCTS, INC., Danbury, Conn.
- Ⓢ Waveforms, Inc., 333 Sixth Ave., New York 14, N. Y.

INSULATING COMPOUNDS

Asphalts

- Ⓢ BIWAX CORP., 3445 Howard St., Skokie, Ill. ADV. PG. 380.
- Ⓢ Dolph Co., John C., Monmouth Junction, N. J.
- Ⓢ Electro Chemical Engineering Co., 750 Broad St., Emmaus, Pa.
- Ⓢ GENERAL ELECTRIC CO., Chemical Dept., Pittsfield, ADV. PG. 1 to 22.
- Ⓢ Horn Co., Inc., A. C., 10th St. & 44th Ave., Long Island City 1, N. Y.
- Ⓢ Johns-Manville, 22 E. 40th St., New York 16, N. Y.
- Ⓢ Midland Paint & Varnish Co., 9115 Reno Ave., Cleveland 5, Ohio.
- Ⓢ MITCHELL RAND INSULATION CO., INC., 51 Murray St., New York 7, N. Y. ADV. PG. 219.
- Ⓢ ZOPHAR MILLS, INC., 112-130 26th St., Brooklyn 32, N. Y. ADV. PG. 397.

Coil Dopes

- Ⓢ BISHOP MFG. CO., 254 W. 31st St., New York 1, N. Y. ADV. PG. 224.
- Ⓢ GENERAL CEMENT MFG. CO., 919 Taylor Ave., Rockford, Ill.
- Ⓢ Houghton Laboratories, Inc., 322 Bush St., Olean, N. Y.
- Ⓢ INSL-X CO., INC., Water St., Ossining, N. Y. ADV. PG. 386.
- Ⓢ Schenectady Varnish Co., Schenectady, N. Y.
- Ⓢ Schott Co., Walter L., 3225 Exposition Pl., Los Angeles 18, Calif.

Ⓢ indicates . . . IN PRODUCTION • AVAILABILITY • UNRESTRICTED FOR GENERAL USE

Enamel

- Ⓢ Acme Wire Co., New Haven 14, Conn.
- Ⓢ Brooklyn Varnish Mfg. Co., 50 Jay St., Brooklyn, N. Y.
- Ⓢ Du Pont de Nemours & Co., Inc., E. I., Wilmington 98, Delaware.
- Ⓢ General Cement Mfg. Co., 919 Taylor Ave., Rockford, Ill.
- Ⓢ GENERAL ELECTRIC CO., Chemical Dept., Pittsfield, Mass. ADV. PG. 1 to 22.
- Ⓢ IRVINGTON VARNISH & INSULATOR CO., 6 Argyle Terrace, Irvington 11, N. J. ADV. PG. 92, 93.
- Ⓢ Maas & Waldstein Co., 438 Riverside Ave., Newark 4, N. J.
- Ⓢ Midland Paint & Varnish Co., 9115 Reno Ave., Cleveland 5, Ohio.
- Ⓢ Schenectady Varnish Co., Schenectady, N. Y.
- Ⓢ Standard Varnish Works, 2600 Richmond Terrace, Staten Island 3, N. Y.

Impregnating Compounds

- Ⓢ Acme Wire Co., New Haven 14, Conn.
- Ⓢ Bakelite Co., A Div. of Union Carbide & Carbon Corp., 30 E. 42nd St., New York 17, N. Y.
- Ⓢ BISHOP MFG. CO., 254 W. 31st St., New York 1, N. Y. ADV. PG. 224.
- Ⓢ BIWAX CORP., 3445 Howard St., Skokie, Ill. ADV. PG. 380.
- Ⓢ BORTHIG CO., INC., GEORGE C., P. O. Box 115, East Rutherford, N. J. ADV. PG. 322.
- Ⓢ CIBA CO., INC., 627 Greenwich St., New York 14, N. Y. ADV. PG. 276.
- Ⓢ Dolph Co., John C., Monmouth Junction, N. J.
- Ⓢ Dow Corning Corp., Midland, Mich.
- Ⓢ Electro Chemical Engineering Co., 750 Broad St., Emmaus, Pa.
- Ⓢ General Cement Mfg. Co., 919 Taylor Ave., Rockford, Ill.
- Ⓢ GENERAL ELECTRIC CO., Chemical Dept., Pittsfield, Mass. ADV. PG. 1 to 22.
- Ⓢ Goodyear Tire & Rubber Co., Inc., Chemical Div., 1144 E. Market St., Akron 16, Ohio.
- Ⓢ Halowax Products Division, Union Carbide & Carbon Corp., 30 E. 42nd St., New York 17, N. Y.
- Ⓢ HI-TEST CHEMICAL CORP., 722 64th St., Brooklyn 20, N. Y. ADV. PG. 376.
- Ⓢ Houghton Laboratories, Inc., 322 Bush St., Olean, N. Y.
- Ⓢ INSL-X CO., INC., Water St., Ossining, N. Y. ADV. PG. 386.
- Ⓢ IRVINGTON VARNISH & INSULATOR CO., 6 Argyle Terrace, Irvington 11, N. J. ADV. PG. 92, 93.
- Ⓢ Juell Corp., Arcadia, Calif.
- Ⓢ MITCHELL RAND INSULATION CO., INC., 51 Murray St., New York 7, N. Y. ADV. PG. 219.
- Ⓢ Sauereisen Cements Co., Sauereisen Bldg., Pittsburgh 15, Pa.
- Ⓢ Schenectady Varnish Co., Schenectady, N. Y.
- Ⓢ Standard Varnish Works, 2600 Richmond Terrace, Staten Island 3, N. Y.
- Ⓢ Tricraft Products Co., 1535 N. Ashland Ave., Chicago 22, Ill.
- Ⓢ ZOPHAR MILLS, INC., 112-130 26th St., Brooklyn 32, N. Y. ADV. PG. 397.

Insulating Varnish

- Ⓢ Acme Wire Co., New Haven 14, Conn.
- Ⓢ Arco Co., 7301 Bessemer Ave., Cleveland 27, Ohio.
- Ⓢ Bakelite Co., A Div. of Union Carbide & Carbon Corp., 30 E. 42nd St., New York 17, N. Y.
- Ⓢ BORTHIG CO., INC., GEORGE C., P. O. Box 115, East Rutherford, N. J. ADV. PG. 322.
- Ⓢ Brooklyn Varnish Mfg. Co., 50 Jay St., Brooklyn, N. Y.
- Ⓢ CIBA CO., INC., 627 Greenwich St., New York 14, N. Y. ADV. PG. 276.
- Ⓢ Communication Products Co., Inc., Marlboro, N. J.
- Ⓢ Dolph, John C., Monmouth Junction, N. J.
- Ⓢ Dow Corning Corp., Midland, Mich.
- Ⓢ Du Pont de Nemours & Co., Inc., E. I., Wilmington 98, Delaware.
- Ⓢ General Cement Mfg. Co., 919 Taylor Ave., Rockford, Ill.
- Ⓢ GENERAL ELECTRIC CO., Chemical Dept., Pittsfield, Mass. ADV. PG. 1 to 22.
- Ⓢ Horn Co., Inc., A. C., 10th St. & 44th Ave., Long Island City 1, N. Y.
- Ⓢ Houghton Laboratories, Inc., 322 Bush St., Olean, N. Y.
- Ⓢ INSL-X CO., INC., Water St., Ossining, N. Y. ADV. PG. 386.
- Ⓢ IRVINGTON VARNISH & INSULATOR CO., 6 Argyle Terrace, Irvington 11, N. J. ADV. PG. 92, 93.
- Ⓢ Maas & Waldstein Co., 438 Riverside Ave., Newark 4, N. J.
- Ⓢ Midland Paint & Varnish Co., 9115 Reno Ave., Cleveland 5, Ohio.
- Ⓢ MITCHELL-RAND INSULATION CO., INC., 51 Murray St., New York 7, N. Y. ADV. PG. 219.
- Ⓢ Reichhold Chemicals, Inc., 601-707 Woodward Heights Blvd., Detroit 20, Mich.
- Ⓢ Schenectady Varnish Co., Schenectady, N. Y.
- Ⓢ Standard Varnish Works, 2600 Richmond Terrace, Staten Island 3, N. Y.

Lacquer

- Ⓢ Acme Wire Co., New Haven 14, Conn.
- Ⓢ Arco Co., 7301 Bessemer Ave., Cleveland 27, Ohio.
- Ⓢ Brooklyn Varnish Mfg. Co., 50 Jay St., Brooklyn, N. Y.
- Ⓢ Communication Products Co., Inc., Marlboro, N. J.
- Ⓢ Dolph Co., John C., Monmouth Junction, N. J.
- Ⓢ Du Pont de Nemours & Co., Inc., E. I., Wilmington 98, Delaware.
- Ⓢ General Cement Mfg. Co., 919 Taylor Ave., Rockford, Ill.
- Ⓢ Horn Co., Inc., A. C., 10th St. & 44th Ave., Long Island City 1, N. Y.
- Ⓢ INSL-X CO., INC., Water St., Ossining, N. Y. ADV. PG. 386.
- Ⓢ Maas & Waldstein Co., 438 Riverside Ave., Newark 4, N. J.
- Ⓢ MICRO-CIRCUITS CO., New Buffalo, Mich. ADV. PG. 50.
- Ⓢ Standard Varnish Works, 2600 Richmond Terrace, Staten Island 3, N. Y.

Phenolic Molding Compounds

- Ⓢ Acme Wire Co., New Haven 14, Conn.
- Ⓢ Bakelite Co., A Div. of Union Carbide & Carbon Corp., 30 E. 42nd St., New York 17, N. Y.
- Ⓢ BISHOP MFG. CO., 254 W. 31st St., New York 1, N. Y. ADV. PG. 224.
- Ⓢ Borden Co., The, Chemical Div., 350 Madison Ave., New York 17, N. Y.
- Ⓢ Dow Corning Corp., Midland, Mich.
- Ⓢ Durez Plastics & Chemicals, Inc., 1921 Walck Rd., N. Tonawanda, N. Y.
- Ⓢ Electro Chemical Engineering Co., 750 Broad St., Emmaus, Pa.
- Ⓢ General Cement Mfg. Co., 919 Taylor Ave., Rockford, Ill.
- Ⓢ GENERAL ELECTRIC CO., Chemical Dept., Pittsfield, Mass. ADV. PG. 1 to 22.
- Ⓢ IRVINGTON VARNISH & INSULATOR CO., 6 Argyle Terrace, Irvington 11, N. J. ADV. PG. 92, 93.
- Ⓢ Juell Corp., Arcadia, Calif.
- Ⓢ Kellogg Co., M. W., P.O. Box 469, Jersey City 4, N. J.
- Ⓢ MITCHELL RAND INSULATION CO., 51 Murray St., New York 7, N. Y. ADV. PG. 219.
- Ⓢ Sauereisen Cements Co., Sauereisen Bldg., Pittsburgh 15, Pa.
- Ⓢ Standard Varnish Works, 2600 Richmond Terrace, Staten Island 3, N. Y.
- Ⓢ Stevenson Bro. & Co., 110 Race St., Philadelphia 6, Pa.
- Ⓢ ZOPHAR MILLS, INC., 112-130 26th St., Brooklyn 32, N. Y. ADV. PG. 397.

Pitch

- Ⓢ General Cement Mfg. Co., 919 Taylor Ave., Rockford, Ill.
- Ⓢ MITCHELL RAND INSULATION CO., INC., 51 Murray St., New York 7, N. Y. ADV. PG. 219.
- Ⓢ Reilly Tar & Chemical Corp., 1615 Merchants Bank Bldg., 11 S. Meridian St., Indianapolis, Ind.
- Ⓢ ZOPHAR MILLS, INC., 112-130 26th St., Brooklyn 32, N. Y. ADV. PG. 397.

Protective Sealers

- Ⓢ Acme Wire Co., New Haven 14, Conn.
- Ⓢ BISHOP MFG. CO., 254 W. 31st St., New York 1, N. Y. ADV. PG. 224.
- Ⓢ BORTHIG CO., INC., GEORGE C., P. O. Box 115, East Rutherford, N. J. ADV. PG. 322.
- Ⓢ Brooklyn Varnish Mfg. Co., 50 Jay St., Brooklyn, N. Y.
- Ⓢ Communication Products Co., Inc., Marlboro, N. J.
- Ⓢ Electro Chemical Engineering Co., 750 Broad St., Emmaus, Pa.
- Ⓢ GENERAL ELECTRIC CO., Chemical Dept., Pittsfield, Mass. ADV. PG. 1 to 22.
- Ⓢ Halowax Products Division, Union Carbide & Carbon Corp., 30 E. 42nd St., New York 17, N. Y.
- Ⓢ HI-TEST CHEMICAL CORP., 722 64th St., Brooklyn 20, N. Y. ADV. PG. 376.
- Ⓢ Horn Co., Inc., A. C., 10th St. & 44th Ave., Long Island City 1, N. Y.
- Ⓢ IRVINGTON VARNISH & INSULATOR CO., 6 Argyle Terrace, Irvington 11, N. J. ADV. PG. 92, 93.
- Ⓢ Juell Corp., Arcadia, Calif.
- Ⓢ Maas & Waldstein Co., 438 Riverside Ave., Newark 4, N. J.
- Ⓢ Midland Paint & Varnish Co., 9115 Reno Ave., Cleveland 5, Ohio.
- Ⓢ Sauereisen Cements Co., Sauereisen Bldg., Pittsburgh 15, Pa.
- Ⓢ Schenectady Varnish Co., Schenectady, N. Y.
- Ⓢ Short Wave Plastic Forming Co., 2921 W. Alameda St., Burbank, Calif.
- Ⓢ Woodwelding, Inc., 3000 W. Olive Ave., Burbank, Calif.
- Ⓢ ZOPHAR MILLS, INC., 112-130 26th St., Brooklyn 32, N. Y. ADV. PG. 397.

Resins

- Ⓢ Bakelite Co., A Div. of Union Carbide & Carbon Corp., 30 E. 42nd St., New York 17, N. Y.
- Ⓢ Catlin Corp. of America, 1 Park Ave., New York 16, N. Y.

- Ⓢ CIBA CO., INC., 627 Greenwich St., New York 14, N. Y. ADV. PG. 276.
- Ⓢ Dow Corning Corp., Midland, Mich.
- Ⓢ Electro Chemical Engineering Co., 750 Broad St., Emmaus, Pa.
- Ⓢ GENERAL ELECTRIC CO., Chemical Dept., Pittsfield, Mass. ADV. PG. 1 to 22.
- Ⓢ Goodyear Tire & Rubber Co., Inc., Chemical Div., 1144 E. Market St., Akron 16, Ohio.
- Ⓢ Halowax Products Division, Union Carbide & Carbon Corp., 30 E. 42nd St., New York 17, N. Y.
- Ⓢ INSL-X CO., INC., Water St., Ossining, N. Y. ADV. PG. 386.
- Ⓢ IRVINGTON VARNISH & INSULATOR CO., 6 Argyle Terrace, Irvington 11, N. J. ADV. PG. 92, 93.
- Ⓢ Juell Corp., Arcadia, Calif.
- Ⓢ Melpar, Inc., 552 Swann Ave., Alexandria, Va.
- Ⓢ Minnesota Mining & Mfg. Co., 900 Fauquier Ave., St. Paul 6, Minn.
- Ⓢ Plaskon Div., Libbey-Owens-Ford Glass Co., 2112-24 Sylvan Ave., Toledo 6, Ohio.
- Ⓢ Reichhold Chemicals, Inc., 601-707 Woodward Heights Blvd., Detroit 20, Mich.
- Ⓢ Reilly Tar & Chemical Corp., 1615 Merchants Bank Bldg., 11 S. Meridian St., Indianapolis 4, Ind.
- Ⓢ Sauereisen Cements Co., Sauereisen Bldg., Pittsburgh 15, Pa.
- Ⓢ Schenectady Varnish Co., Schenectady, N. Y.

Silicone Compounds

- Ⓢ Dow Corning Corp., Midland, Mich.
- Ⓢ General Cement Mfg. Co., 919 Taylor Ave., Rockford, Ill.
- Ⓢ GENERAL ELECTRIC CO., Chemical Dept., Pittsfield, Mass. ADV. PG. 1 to 22.
- Ⓢ IRVINGTON VARNISH & INSULATOR CO., 6 Argyle Terrace, Irvington 11, N. J. ADV. PG. 92, 93.
- Ⓢ Maas & Waldstein Co., 438 Riverside Ave., Newark 4, N. J.
- Ⓢ MITCHELL RAND INSULATION CO., INC., 51 Murray St., New York 7, N. Y. ADV. PG. 219.
- Ⓢ Plaskon Div., Libbey-Owens-Ford Glass Co., 2112-24 Sylvan Ave., Toledo 6, Ohio.
- Ⓢ WESTINGHOUSE ELECTRIC CORP., 511 Wood St., P. O. Box 868, Pittsburgh 30, Pa. ADV. PG. 107-113.

Varnish Cambric Coatings

- Ⓢ Acme Wire Co., New Haven 14, Conn.
- Ⓢ Dielectric Materials Co., 5315-17 N. Ravenswood Ave., Chicago 40, Ill.
- Ⓢ Electro-Technical Products Div. of Sun Chemical Corp., 113 E. Centre St., Nutley 10, N. J.
- Ⓢ General Cement Mfg. Co., 919 Taylor Ave., Rockford, Ill.
- Ⓢ GENERAL ELECTRIC CO., Chemical Dept., Pittsfield, Mass. ADV. PG. 1 to 22.
- Ⓢ IRVINGTON VARNISH & INSULATOR CO., 6 Argyle Terrace, Irvington 11, N. J. ADV. PG. 92, 93.
- Ⓢ MITCHELL RAND INSULATION CO., INC., 51 Murray St., New York 7, N. Y. ADV. PG. 219.
- Ⓢ Schenectady Varnish Co., Schenectady, N. Y.
- Ⓢ WESTINGHOUSE ELECTRIC CORP., 511 Wood St., P. O. Box 868, Pittsburgh 30, Pa. ADV. PG. 107-113.

Waxes

- Ⓢ BIWAX CORP., 3445 Howard St., Skokie, Ill. ADV. PG. 380.
- Ⓢ Glyco Products Co., Inc., 26 Court St., Brooklyn, N. Y.
- Ⓢ Halowax Products Division, Union Carbide & Carbon Corp., 30 E. 42nd St., New York 17, New York.
- Ⓢ HI-TEST CHEMICAL CORP., 722 64th St., Brooklyn 20, N. Y. ADV. PG. 376.
- Ⓢ Horn Co., Inc., A. C., 10th St., & 44th Ave., Long Island City 1, N. Y.
- Ⓢ INSL-X CO., INC., Water St., Ossining, N. Y. ADV. PG. 386.
- Ⓢ MITCHELL RAND INSULATION CO., INC., 51 Murray St., New York 7, N. Y. ADV. PG. 219.
- Ⓢ Stevenson Bro. & Co., 110 Race St., Philadelphia 6, Pa.
- Ⓢ ZOPHAR MILLS, INC., 112-130 26th St., Brooklyn 32, N. Y. ADV. PG. 397.

INSULATION MATERIALS**Aluminum Oxide**

- Ⓢ Aluminum Co. of America, Gulf Bldg., Pittsburgh 30, Pa.
- Ⓢ GENERAL CERAMICS & STEATITE CORP., Keasbey, N. J. ADV. PG. 126, 127.
- Ⓢ Kaiser Aluminum & Chemical Sales, Inc., 1924 Broadway, Oakland 12, Calif.
- Ⓢ Merck & Co., Inc., Rahway, N. J.
- Ⓢ Norton Co., 1 New Bond St., Worcester 6, Mass.
- Ⓢ STUPAKOFF CERAMIC & MFG. CO., Latrobe, Pa. ADV. PG. 167.
- Ⓢ SYNCOR PRODUCTS CO., Malden, Mass. ADV. PG. 405.
- Ⓢ THOR CERAMICS INC., 225 Belleville Ave., Bloomfield, N. J. ADV. PG. 378.

Ⓟ indicates . . . IN PRODUCTION • AVAILABILITY • UNRESTRICTED FOR GENERAL USE

Asbestos

- Ⓟ Electro-Technical Products Div. of Sun Chemical Corp., 113 E. Centre St., Nutley 10, N. J.
- Ⓟ Formica Co., The, 4640 Spring Grove Ave., Cincinnati 32, Ohio.
- Ⓟ GENERAL ELECTRIC CO., Chemical Dept., Pittsfield, Mass. ADV. PG. 1 to 22.
- Ⓟ Johns-Manville, 22 E. 40th St., New York 16, N. Y.
- Ⓟ Keasbey & Mattison, Ambler, Pa.
- Ⓟ MITCHELL RAND INSULATION CO., INC., 51 Murray St., New York 7, N. Y. ADV. PG. 219.
- Ⓟ Powhatan Mining Co., Baltimore 7, Md.

Bead

- Ⓟ GENERAL CERAMICS & STEATITE CORP., Keasbey, N. J. ADV. PG. 126, 127.
- Ⓟ Gordon Co., Claud S., 3000 S. Wallace St., Chicago 16, Ill.
- Ⓟ Isolantite Mfg. Corp., Stirling, N. J.
- Ⓟ SYNCOR PRODUCTS CO., Malden, Mass. ADV. PG. 405.

Ceramic

- Ⓟ Akron Porcelain Co., Akron 14, Ohio.
- Ⓟ AMERICAN LAVA CORP., Chattanooga 5, Tenn. ADV. PG. 143.
- Ⓟ CENTRALAB, Div. of Globe Union Inc., 900 E. Keefe Ave., Milwaukee 1, Wis. ADV. PG. 85-88.
- Ⓟ Cook Ceramic Mfg. Co., 501 Prospect St., Trenton 1, N. J.
- Ⓟ CROWLEY & CO., INC., HENRY L., 1 Central Ave., West Orange, N. J. ADV. PG. 231.
- Ⓟ Electrical Refractories Co., 50 Clark St., East Palestine, Ohio.
- Ⓟ GENERAL CERAMICS & STEATITE CORP., Keasbey, N. J. ADV. PG. 126, 127.
- Ⓟ Isolantite Mfg. Corp., Stirling, N. J.
- Ⓟ Kirchberger & Co., Inc., M., 1425 37th St., Brooklyn 18, N. Y.
- Ⓟ Lapp Insulator Co., Inc., Radio Specialties Div., 31 Gilbert St., Le Roy, N. Y.
- Ⓟ Locke Incorporated, P. O. Box 57, Baltimore 3, Md.
- Ⓟ LOUTHAN MFG. CO., East Liverpool, Ohio. ADV. PG. 284.
- Ⓟ MYCALEX CORP. OF AMERICA, 60 Clifton Blvd., Clifton, N. J. ADV. PG. 258, 259.
- Ⓟ Mykroy, Inc., Arlington Heights Airport, Arlington Heights, Ill.
- Ⓟ Scintilla Magneto Div., Bendix Aviation Corp., Sidney, N. Y.
- Ⓟ Steward Mfg. Co., D. M., 3600 Jerome Ave., Chattanooga 1, Tenn.
- Ⓟ STUPAKOFF CERAMIC & MFG. CO., Latrobe, Pa. ADV. PG. 167.
- Ⓟ SYNCOR PRODUCTS CO., Malden, Mass. ADV. PG. 405.
- Ⓟ THOR CERAMICS INC., 225 Belleville Ave., Bloomfield, N. J. ADV. PG. 378.
- Ⓟ Western Gold & Platinum Works, 589 Bryant St., San Francisco, Calif.
- Ⓟ Wisconsin Porcelain Co., Sun Prairie, Wis.

Fabric

- Ⓟ Acme Wire Co., New Haven 14, Conn.
- Ⓟ BISHOP MFG. CO., 254 W. 31st St., New York 1, ADV. PG. 224.
- Ⓟ BRAND & CO., INC., WM., North & Valley Sts., Willimantic, Conn. ADV. PG. 248, 249.
- Ⓟ Electro-Technical Products Div. of Sun Chemical Corp., 113 E. Centre St., Nutley 10, N. J.
- Ⓟ Franklin Fibre-Lamitex Corp., 12th and French Sts., Wilmington, Del.
- Ⓟ General Cement Mfg. Co., 919 Taylor Ave., Rockford, Ill.
- Ⓟ GENERAL ELECTRIC CO., Chemical Dept., Pittsfield, Mass. ADV. PG. 1 to 22.
- Ⓟ Insuline Corp. of America, 36-02 35th Ave., Long Island City, N. Y.
- Ⓟ Johns-Manville, 22 E. 40th St., New York 16, N. Y.
- Ⓟ Minnesota Mining & Mfg. Co., 900 Fauquier Ave., St. Paul 6, Minn.
- Ⓟ MITCHELL RAND INSULATION CO., INC., 51 Murray St., New York 7, N. Y. ADV. PG. 219.
- Ⓟ NATIONAL VARNISHED PRODUCTS CORP., THE, 211 Randolph Ave., Woodbridge, N. J. ADV. PG. 152.

Fibre

- Ⓟ Baer Co., N. S., 9 Montgomery St., Hillside, N. J.
- Ⓟ Brandywine Fibre Co., 15th & Poplar Sts., Wilmington, Del.
- Ⓟ CONTINENTAL DIAMOND FIBRE CO., Newark 100, Del. ADV. PG. 25-32.
- Ⓟ Franklin Fibre-Lamitex Corp., 12th and French Sts., Wilmington, Del.
- Ⓟ Insulation Manufacturers Corp., 565 W. Washington Blvd., Chicago 6, Ill.
- Ⓟ Insuline Corp. of America, 36-02 35th Ave., Long Island City, N. Y.
- Ⓟ Johns-Manville, 22 E. 40th St., New York 16, N. Y.

- Ⓟ Minnesota Mining & Mfg. Co., 900 Fauquier Ave., St. Paul 6, Minn.
- Ⓟ MITCHELL RAND INSULATION CO., INC., 51 Murray St., New York 7, N. Y. ADV. PG. 219.
- Ⓟ NATIONAL VULCANIZED FIBRE CO., Wilmington, Del. ADV. PG. 251.
- Ⓟ Rogers Corp., Manchester, Conn.
- Ⓟ Spaulding Fibre Co., Inc., 310 Wheeler St., Tonawanda, N. Y.
- Ⓟ Wilmington Fibre Specialty Co., P. O. Drawer 1028, Wilmington 99, Del.

Glass

- Ⓟ Acme Wire Co., New Haven 14, Conn.
- Ⓟ CORNING GLASS WORKS, Corning, N. Y. ADV. PG. 373.
- Ⓟ Electro-Technical Products Div. of Sun Chemical Corp., 113 E. Centre St., Nutley 10, N. J.
- Ⓟ HERMETIC SEAL PRODUCTS CO., 29-37 S. 6th St., Newark 7, N. J. ADV. PG. 175.
- Ⓟ NATIONAL VARNISHED PRODUCTS CORP., THE, 211 Randolph St., Woodbridge, N. J. ADV. PG. 152.
- Ⓟ STUPAKOFF CERAMIC & MFG. CO., Latrobe, Pa. ADV. PG. 167.

Glass Banded Mica

- Ⓟ BRAND & CO., INC., WM., North & Valley Sts., Willimantic, Conn. ADV. PG. 248, 249.
- Ⓟ ELECTRONIC MECHANICS, INC., 70 Clifton Blvd., Clifton, N. J. ADV. PG. 309.
- Ⓟ GENERAL ELECTRIC CO., Chemical Dept., Pittsfield, Mass. ADV. PG. 1 to 22.
- Ⓟ Huse Liberty Mica Co., 171 Camden St., Boston, Mass.
- Ⓟ Insulation Manufacturers Corp., 565 W. Washington Blvd., Chicago 6, Ill.
- Ⓟ MITCHELL RAND INSULATION CO., INC., 51 Murray St., New York 7, N. Y. ADV. PG. 219.
- Ⓟ MYCALEX CORP. OF AMERICA, 60 Clifton Blvd., Clifton, N. J. ADV. PG. 258, 259.
- Ⓟ Mykroy, Inc., Arlington Heights Airport, Arlington Heights, Ill.
- Ⓟ National Electric Coil Co., Columbus 16, Ohio.

Glass Fibre

- Ⓟ Acme Wire Co., New Haven 14, Conn.
- Ⓟ Baer Co., N. S., 9 Montgomery St., Hillside, N. J.
- Ⓟ BENTLEY-HARRIS MFG. CO., Conshohocken, Pa. ADV. PG. 269.
- Ⓟ BISHOP MFG. CO., 254 W. 31st St., New York 1, N. Y. ADV. PG. 224.
- Ⓟ Dielectric Materials Co., 5315-17 N. Ravenswood Ave., Chicago 40, Ill.
- Ⓟ Electro-Technical Products Div. of Sun Chemical Corp., 113 E. Centre St., Nutley 10, N. J.
- Ⓟ Formica Co., The, 4640 Spring Grove Ave., Cincinnati 32, Ohio.
- Ⓟ Franklin Fibre-Lamitex Corp., 12th and French Sts., Wilmington, Delaware.
- Ⓟ GENERAL ELECTRIC CO., Chemical Dept., Pittsfield, Mass. ADV. PG. 1 to 22.
- Ⓟ Minnesota Mining & Mfg. Co., 900 Fauquier Ave., St. Paul 6, Minn.
- Ⓟ MITCHELL RAND INSULATION CO., INC., 51 Murray St., New York 7, N. Y. ADV. PG. 219.
- Ⓟ Owens-Corning Fiberglass Corp., 16 E. 56th St., New York 22, N. Y.
- Ⓟ Spaulding Fibre Co., Inc., 310 Wheeler St., Tonawanda, N. Y.

Glass Mica—Woven or Laminated

- Ⓟ BRAND & CO., INC., WM., North & Valley Sts., Willimantic, Conn. ADV. PG. 248, 249.
- Ⓟ GENERAL ELECTRIC CO., Chemical Dept., Pittsfield, Mass. ADV. PG. 1 to 22.
- Ⓟ Insulating Fabricators of New England, Inc., 69 Grove St., Watertown 72, Mass.
- Ⓟ Insulation Manufacturers Corp., 565 W. Washington Blvd., Chicago 6, Ill.
- Ⓟ IRVINGTON VARNISH & INSULATOR CO., 6 Argyle Terrace, Irvington 13, N. J. ADV. PG. 92, 93.
- Ⓟ Mica Insulator Co., Schenectady 1, N. Y.
- Ⓟ MITCHELL RAND INSULATION CO., INC., 51 Murray St., New York 7, N. Y. ADV. PG. 219.
- Ⓟ National Electric Coil Co., Columbus 16, Ohio.

Laminates, Woven Glass

- Ⓟ Baer Co., N. S., 9 Montgomery St., Hillside, N. J.
- Ⓟ Cortland Industries, Inc., 4545 Cortland St., Chicago 39, Ill.
- Ⓟ Formica Co., The, 4640 Spring Grove Ave., Cincinnati 32, Ohio.
- Ⓟ GENERAL ELECTRIC CO., Chemical Dept., Pittsfield, Mass. ADV. PG. 1 to 22.
- Ⓟ General Tire & Rubber Co., Silentbloc Div., Wabash, Ind.
- Ⓟ Houghton Laboratories, Inc., 322 Bush St., Olean, N. Y.
- Ⓟ Insulating Fabricators of New England, Inc., 69 Grove St., Watertown 72, Mass.

- Ⓟ IRVINGTON VARNISH & INSULATOR CO., 6 Argyle Terrace, Irvington 13, N. J. ADV. PG. 92, 93.
- Ⓟ Juel Corp., Arcadia, Calif.
- Ⓟ Laminated Plastics, Inc., 1823 E. 40th St., Cleveland 3, Ohio.
- Ⓟ Mica Insulator Co., Schenectady 1, N. Y.
- Ⓟ NATIONAL VULCANIZED FIBRE CO., Wilmington, Del. ADV. PG. 251.
- Ⓟ Panelyte Div., St. Regis Sales Co., 230 Park Ave., New York 17, N. Y.
- Ⓟ Penn Fibre & Specialty Co., 2020 E. Westmoreland St., Philadelphia 44, Pa.
- Ⓟ Synthane Corp., Oaks, Pa.
- Ⓟ Taylor Fibre Co., Norristown, Pa.
- Ⓟ TEFLON PRODUCTS DIVISION, U. S. GASKET CO., P. O. Box 93, Camden, N. J. ADV. PG. 176.
- Ⓟ WESTINGHOUSE ELECTRIC CORP., 511 Wood St., P. O. Box 868, Pittsburgh 30, Pa. ADV. PG. 107-113.

Mica

- Ⓟ AIRCRAFT MARINE PRODUCTS, INC., 2100 Paxton St., Harrisburg 10, Pa. ADV. PG. 367.
- Ⓟ Asheville-Schoonmaker Mica Co., 900 Jefferson Ave., Newport News, Va.
- Ⓟ BRAND & CO., INC., WM., North & Valley Sts., Willimantic, Conn. ADV. PG. 248, 249.
- Ⓟ CONTINENTAL DIAMOND FIBRE CO., Newark 100, Delaware. ADV. PG. 25-32.
- Ⓟ GENERAL ELECTRIC CO., Chemical Dept., Pittsfield, Mass. ADV. PG. 1 to 22.
- Ⓟ Huse Liberty Mica Co., 171 Camden St., Boston, Mass.
- Ⓟ Insulation Manufacturers Corp., 565 W. Washington Blvd., Chicago 6, Ill.
- Ⓟ IRVINGTON VARNISH & INSULATOR CO., 6 Argyle Terrace, Irvington 13, N. J. ADV. PG. 92, 93.
- Ⓟ Mica Insulator Co., Schenectady 1, N. Y.
- Ⓟ MITCHELL-RAND INSULATION CO., INC., 51 Murray St., New York 7, N. Y. ADV. PG. 219.
- Ⓟ National Electric Coil Co., Columbus 16, Ohio.

Paper

- Ⓟ Acme Wire Co., New Haven 14, Conn.
- Ⓟ BRAND & CO., INC., WM., North & Valley Sts., Willimantic, Conn. ADV. PG. 248, 249.
- Ⓟ Central Paper Co., Inc., 2400 Lakeshore Drive, Muskegon, Mich.
- Ⓟ Electro-Technical Products Div. of Sun Chemical Corp., 113 E. Centre St., Nutley 10, N. J.
- Ⓟ General Cement Mfg. Co., 919 Taylor Ave., Rockford, Ill.
- Ⓟ GENERAL ELECTRIC CO., Chemical Dept., Pittsfield, Mass. ADV. PG. 1 to 22.
- Ⓟ Insulation Manufacturers Corp., 565 W. Washington Blvd., Chicago 6, Ill.
- Ⓟ IRVINGTON VARNISH & INSULATOR CO., 6 Argyle Terrace, Irvington 13, N. J. ADV. PG. 92, 93.
- Ⓟ Mica Insulator Co., Schenectady 1, N. Y.
- Ⓟ Minnesota Mining & Mfg. Co., 900 Fauquier Ave., St. Paul 6, Minn.
- Ⓟ MITCHELL RAND INSULATION CO., INC., 51 Murray St., New York 7, N. Y. ADV. PG. 219.
- Ⓟ Moore Co., Howard J., 108 Park Row, New York 7, N. Y.
- Ⓟ Mosinee Paper Mills Co., Mosinee, Wis.
- Ⓟ NATIONAL VARNISHED PRODUCTS CORP., THE, 211 Randolph St., Woodbridge, N. J. ADV. PG. 152.
- Ⓟ Rogers Corp., Manchester, Conn.
- Ⓟ Schweitzer, Inc., Peter J., 405 Lexington Ave., New York 17, N. Y.

Plastic**See Plastic Materials****Rubber**

- Ⓟ American Hard Rubber Co., 11 Mercer St., New York 13, N. Y.
- Ⓟ General Tire & Rubber Co., Silentbloc Div., Wabash, Ind.
- Ⓟ Lavelle Rubber Co., 424 N. Wood St., Chicago 22, Ill.
- Ⓟ Luzerne Rubber Co., Muirhead Ave., Trenton, N. J.
- Ⓟ Mica Insulator Co., Schenectady 1, N. Y.
- Ⓟ U. S. Rubber Co., 1230 Avenue of the Americas, New York 20, N. Y.

Rubber—Conductive

- Ⓟ American Hard Rubber Co., 11 Mercer St., New York 13, N. Y.
- Ⓟ General Tire & Rubber Co., Silentbloc Div., Wabash, Ind.
- Ⓟ U. S. Rubber Co., 1230 Avenue of the Americas, New York 20, N. Y.

Steatite

- Ⓟ AMERICAN LAVA CORP., Chattanooga 5, Tenn. ADV. PG. 143.

V indicates . . . **IN PRODUCTION • AVAILABILITY • UNRESTRICTED FOR GENERAL USE**

- ⓪CENTRALAB DIV. of Globe Union, Inc., 900 E. Keefe Ave., Milwaukee 1, Wis. ADV. PG. 85-88.
- ⓪Cook Ceramic Mfg. Co., 501 Prospect St., Trenton 1, N. J.
- ⓪CROWLEY & CO., INC., Henry L., 1 Central Ave., West Orange, N. J. ADV. PG. 231.
- ⓪GENERAL CERAMICS & STEATITE CORP., Keasbey, N. J. ADV. PG. 126, 127.
- ⓪Lapp Insulator Co., Inc., Radio Specialties Div., 31 Gilbert St., LeRoy, N. Y.
- ⓪Locke, Inc., P. O. Box 57, Baltimore 3, Md.
- ⓪LOUTHAN MFG. CO., East Liverpool, Ohio. ADV. PG. 284.
- ⓪Steward Mfg. Co., D. M., 3600 Jerrome Ave., Chattanooga 1, Tenn.
- ⓪STUPAKOFF CERAMIC & MFG. CO., Latrobe, Pa. ADV. PG. 167.
- ⓪THOR CERAMICS INC., 225 Belleville Ave., Bloomfield, N. J. ADV. PG. 378.
- ⓪Western Gold & Platinum Works, 589 Bryant St., San Francisco, Calif.
- ⓪Wisconsin Porcelain Co., Sun Prairie, Wis.

INSULATION PARTS

Bead Insulation Parts

- ⓪AMERICAN LAVA CORP., Chattanooga 5, Tenn. ADV. PG. 143.
- ⓪Cook Ceramic Mfg. Co., 501 Prospect St., Trenton 1, N. J.
- ⓪Crane Packing Co., 1800 Cuyler Ave., Chicago 13, Ill.
- ⓪GENERAL CERAMICS & STEATITE CORP., Keasbey, N. J. ADV. PG. 126, 127.
- ⓪Gordon Co., Claud S., 3000 S. Wallace St., Chicago 16, Ill.
- ⓪HERMETIC SEAL PRODUCTS CO., 29-37 South 6th St., Newark 7, N. J. ADV. PG. 175.
- ⓪Isolantite Mfg. Corp., Stirling, N. J.
- ⓪Kirchberger & Co., Inc., M., 1425 37th St., Brooklyn 18, N. Y.
- ⓪Laconia Corp., 37 S. 6th St., Newark 7, N. J.
- ⓪Mykroy, Inc., Arlington Heights Airport, Arlington Heights, Ill.
- ⓪Star Porcelain Co., 61 Muirhead Ave., Trenton 9, N. J.
- ⓪Steward Mfg. Co., D. M., 3600 Jerrome Ave., Chattanooga 1, Tenn.
- ⓪STUPAKOFF CERAMIC & MFG. CO., Latrobe, Pa. ADV. PG. 167.
- ⓪SYNCOR PRODUCTS CO., Malden, Mass. ADV. PG. 405.
- ⓪TEFLON PRODUCTS DIVISION, U. S. GASKET CO., P. O. Box 93, Camden, N. J. ADV. PG. 176.
- ⓪THOR CERAMICS INC., 225 Belleville Ave., Bloomfield, N. J. ADV. PG. 378.
- ⓪Transradio, Ltd., 138A Cromwell Rd., London S.W. 7, England.

Capacitor Boxes

- ⓪Acme Folding Box Co., Inc., 149 E. 25th St., New York 10, N. Y.
- ⓪Moore Co., Howard J., 108 Park Row, New York 7, N. Y.
- ⓪PRECISION PAPER TUBE CO., 2033 W. Charleston St., Chicago 47, Ill. ADV. PG. 156.

Capacitor Films

- ⓪Asheville-Schoonmaker Mica Co., 900 Jefferson Ave., Newport News, Va.
- ⓪Mica Fabricating Co., 53 Central Ave., Rochelle Park, N. J.
- ⓪Mica Insulator Co., Schenectady 1, N. Y.
- ⓪Miccacraft Products, Inc., 701 McCarter Highway, Newark 5, N. J.
- ⓪TEFLON PRODUCTS DIVISION, U. S. GASKET CO., P. O. Box 93, Camden, N. J. ADV. PG. 176.

Ceramic Insulation Parts

- ⓪AMERICAN LAVA CORP., Chattanooga 5, Tenn. ADV. PG. 143.
- ⓪CENTRALAB DIV. OF GLOBE UNION, INC., 900 E. Keefe Ave., Milwaukee 1, Wis. ADV. PG. 85-88.
- ⓪CROWLEY & CO., INC., HENRY L., 1 Central Ave., West Orange, N. J. ADV. PG. 231.
- ⓪ELECTRICAL INDUSTRIES, INC., 44 Summer Ave., Newark 4, N. J. ADV. PG. 94.
- ⓪Electrical Refractories Co., 50 Clark St., East Palestine, Ohio.
- ⓪FRANKLIN AIRLOOP CORP., 43-20 34th St., Long Island City, N. Y. ADV. PG. 45.
- ⓪FRANKLIN MFG. CORP., A. W., 43-20 34th St., Long Island City 1, N. Y. ADV. PG. 44.
- ⓪GENERAL CERAMICS & STEATITE CORP., Keasbey, N. J. ADV. PG. 126, 127.
- ⓪Isolantite Mfg. Corp., Stirling, N. J.
- ⓪Jones Optical Works, A. D., Cambridge, Mass.
- ⓪Kirchberger & Co., M., 1425 37th St., Brooklyn 18, N. Y.

- ⓪Laconia Corp., 37 S. 6th St., Newark 7, N. J.
- ⓪Lapp Insulator Co., Inc., Radio Specialties Div., 31 Gilbert St., Le Roy, N. Y.
- ⓪LOUTHAN MFG. CO., East Liverpool, Ohio. ADV. PG. 284.
- ⓪Mica Fabricating Co., 53 Central Ave., Rochelle Park, N. J.
- ⓪Millen Mfg. Co., James, 150 Exchange St., Malden, Mass.
- ⓪MYCALEX CORP. OF AMERICA, 60 Clifton Blvd., Clifton, N. J. ADV. PG. 258, 259.
- ⓪Mykroy Inc., Arlington Heights Airport, Arlington Heights, Ill.
- ⓪Norton Co., 1 New Bond St., Worcester 6, Mass.
- ⓪Scintilla-Magneto Div. of Bendix Aviation Corp., Sidney, N. Y.
- ⓪Star Porcelain Co., 61 Muirhead Ave., Trenton 9, N. J.
- ⓪Steward Mfg. Co., D. M., 3600 Jerrome Ave., Chattanooga 1, Tenn.
- ⓪STUPAKOFF CERAMIC & MFG. CO., Latrobe, Pa. ADV. PG. 167.
- ⓪SYNCOR PRODUCTS CO., Malden, Mass. ADV. PG. 405.
- ⓪THOR CERAMICS INC., 225 Belleville Ave., Bloomfield, N. J. ADV. PG. 378.
- ⓪Western Gold & Platinum Works, 589 Bryant St., San Francisco, Calif.
- ⓪Wisconsin Porcelain Co., Sun Prairie, Wis.
- ⓪Wolfe Co., Inc., Franklin C., 11723 Mississippi Ave., Los Angeles 25, Calif.

Cut Insulation Parts

- ⓪AEROLITE ELECTRONIC HARDWARE CORP., 507 26th St., Union City, N. J. ADV. PG. 355.
- ⓪Auburn Mfg. Co., Pease Ave. & Stack St., Middletown, Conn.
- ⓪Baer Co., N. S., 9 Montgomery St., Hillside, N. J.
- ⓪BISHOP MFG. CO., 254 W. 31st St., New York 1, N. Y. ADV. PG. 224.
- ⓪BRAND & CO., INC., WM., North & Valley Sts., Willimantic, Conn. ADV. PG. 248, 249.
- ⓪Brandywine Fibre Co., 15th & Poplar Sts., Wilmington, Del.
- ⓪CAMBRIDGE THERMIONIC CORP., 445 Concord Ave., Cambridge 38, Mass. ADV. PG. 37.
- ⓪CITATION PRODUCTS CO., 233 E. 146th St., New York 51, N. Y. ADV. PG. 388.
- ⓪CROWLEY CO., INC., HENRY L., 1 Central Ave., West Orange, N. J. ADV. PG. 231.
- ⓪ELECTRONIC MECHANICS, INC., 70 Clifton Blvd., Clifton, N. J. ADV. PG. 309.
- ⓪EMELOID CO., INC., THE, 1239 Central Ave., Hillside 5, N. J. ADV. PG. 102.
- ⓪Felt Products Mfg. Co., 1504 W. Carroll Ave., Chicago 7, Ill.
- ⓪Gasket Engineering Co., 2440 Charlotte St., Kansas City 8, Mo.
- ⓪Insulating Fabricators of New England, Inc., 69 Grove St., Watertown 72, Mass.
- ⓪Insulating Fabricators of New England, Inc., 150 Union Ave., East Rutherford, N. J.
- ⓪Insulation Manufacturers Corp., 565 W. Washington Blvd., Chicago 6, Ill.
- ⓪Insuline Corp. of America, 36-02 35th Ave., Long Island City, N. Y.
- ⓪Mica Fabricating Co., 53 Central Ave., Rochelle Park, N. J.
- ⓪Mica Insulator Co., Schenectady 1, N. Y.
- ⓪Molded Insulation Co., 335 E. Price St., Philadelphia 44, Pa.
- ⓪Moore Co., Howard J., 108 Park Row, New York 7, N. Y.
- ⓪MYCALEX CORP. OF AMERICA, 60 Clifton Blvd., Clifton, N. J. ADV. PG. 258, 259.
- ⓪Mykroy, Inc., Arlington Heights Airport, Arlington Heights, Ill.
- ⓪NATIONAL VARNISHED PRODUCTS CORP., THE, 211 Randolph Ave., Woodbridge, N. J. ADV. PG. 152.
- ⓪RICHARDSON CO., THE, 2767 Lake St., Melrose Park, Ill. ADV. PG. 310.
- ⓪Rogers Corp., Manchester, Conn.
- ⓪Star Porcelain Co., 61 Muirhead Ave., Trenton 9, N. J.
- ⓪Stevens Products, Inc., 86-88 Main St., East Orange, N. J.
- ⓪TEFLON PRODUCTS DIVISION, U. S. GASKET CO., P. O. Box 93, Camden, N. J. ADV. PG. 176
- ⓪Varflex Corp., 308 N. Jay St., Rome, N. Y.
- ⓪Wilmington Fibre Specialty Co. P. O. Drawer 1028, Wilmington 99, Del.

Extruded Insulation Parts

- ⓪AMERICAN LAVA CORP., Chattanooga 5, Tenn. ADV. PG. 143.
- ⓪Anchor Plastics Co., Inc., 533-541 Canal St., New York 13, N. Y.
- ⓪BRAND & CO., INC., WM., North & Valley Sts., Willimantic, Conn. ADV. PG. 248, 249.
- ⓪CENTRALAB DIV. OF GLOBE UNION, INC., 900 E. Keefe Ave., Milwaukee 1, Wis. ADV. PG. 85-88.
- ⓪Crane Packing Co., 1800 Cuyler Ave., Chicago 13, Ill.
- ⓪CROWLEY & CO., INC., HENRY L., 1 Central Ave., West Orange, N. J. ADV. PG. 231.

- ⓪Electrical Refractories Co., 50 Clark St., East Palestine, Ohio.
- ⓪ELECTRONIC MECHANICS, INC., 70 Clifton Blvd., Clifton, N. J. ADV. PG. 309.
- ⓪Felt Products Mfg. Co., 1504 W. Carroll Ave., Chicago 7, Ill.
- ⓪General Cement Mfg. Co., 919 Taylor Ave., Rockford, Ill.
- ⓪GENERAL CERAMICS & STEATITE CORP., Keasbey, N. J. ADV. PG. 126, 127.
- ⓪General Tire & Rubber Co., Silentbloc Div., Wabash, Ind.
- ⓪Industrial Synthetics Corp., 225 North Ave., Garwood, N. J.
- ⓪Insulating Fabricators, Inc., 150 Union Ave., East Rutherford, N. J.
- ⓪Insuline Corp. of America, 36-02 35th Ave., Long Island City, N. Y.
- ⓪Isolantite Mfg. Corp., Stirling, N. J.
- ⓪Kirchberger & Co., Inc., M., 1425 37th St., Brooklyn 18, N. Y.
- ⓪Mica Fabricating Co., 53 Central Ave., Rochelle Park, N. J.
- ⓪MITCHELL RAND INSULATION CO., INC., 51 Murray St., New York 7, N. Y. ADV. PG. 219.
- ⓪Panelyte Div., St. Regis Sales Corp., 230 Park Ave., New York 17, N. Y.
- ⓪Plax Corp., P. O. Box 1019, Hartford 5, Conn.
- ⓪Smith, Inc., Herman, H., 436 18th St., Brooklyn 15, N. Y.
- ⓪Spaulding Fibre Co., Inc., 310 Wheeler St., Tonawanda, N. Y.
- ⓪Star Porcelain Co., 61 Muirhead Ave., Trenton 9, N. J.
- ⓪Steward Mfg. Co., D. M., 3600 Jerrome Ave., Chattanooga 1, Tenn.
- ⓪STUPAKOFF CERAMIC & MFG. CO., Latrobe, Pa. ADV. PG. 167.
- ⓪Surprenant Mfg. Co., 199 Washington St., Boston 10, Mass.
- ⓪TEFLON PRODUCTS DIVISION, U. S. GASKET CO., P. O. Box 93, Camden, N. J. ADV. PG. 176
- ⓪THOR CERAMICS INC., 225 Belleville Ave., Bloomfield, N. J. ADV. PG. 378.
- ⓪Varflex Corp., 308 N. Jay St., Rome, N. Y.

Fabricated Parts—Phenolic or Plastic

- ⓪AMERICAN LAVA CORP., Chattanooga 5, Tenn. ADV. PG. 143.
- ⓪Anchor Plastics Co., Inc., 533-541 Canal St., New York 13, N. Y.
- ⓪Auburn Mfg. Co., Pease Ave. & Stack St., Middletown, Conn.
- ⓪Baer Co., N. S., 9 Montgomery St., Hillside, N. J.
- ⓪BISHOP MFG. CO., 254 W. 31st St., New York 1, N. Y. ADV. PG. 224.
- ⓪BRAND & CO., INC., WM., North & Valley Sts., Willimantic, Conn. ADV. PG. 248, 249.
- ⓪Brandywine Fibre Co., 15th & Poplar Sts., Wilmington, Del.
- ⓪CAMBRIDGE THERMIONIC CORP., 445 Concord Ave., Cambridge 38, Mass. ADV. PG. 37.
- ⓪CINCH MFG. CORP., 1026 S. Homan Ave., Chicago 24, Ill. ADV. PG. 186, 187.
- ⓪CITATION PRODUCTS CO., 233 E. 146th St., New York 51, N. Y. ADV. PG. 388.
- ⓪Cortland Industries, Inc., 4545 Cortland St., Chicago 39, Ill.
- ⓪Crane Packing Co., 1800 Cuyler Ave., Chicago 13, Ill.
- ⓪CROWLEY CO., INC., HENRY L., 1 Central Ave., West Orange, N. J. ADV. PG. 231.
- ⓪ELECTRONIC MECHANICS, INC., 70 Clifton Blvd., Clifton, N. J. ADV. PG. 309.
- ⓪Felsenthal & Sons, Inc., G., 4100 W. Grand St., Chicago 51, Ill.
- ⓪Felt Products Mfg. Co., 1504 W. Carroll Ave., Chicago 7, Ill.
- ⓪FRANKLIN AIRLOOP CORP., 43-20 34th St., Long Island City, N. Y. ADV. PG. 45.
- ⓪Franklin Fibre-Lamitex Corp., 12th and French Sts., Wilmington, Del.
- ⓪FRANKLIN MFG. CORP., A. W., 43-20 34th St., Long Island City, N. Y. ADV. PG. 44.
- ⓪General Cement Mfg. Co., 919 Taylor Ave., Rockford, Ill.
- ⓪General R-F Fittings Co., 702 Beacon St., Boston 15, Mass.
- ⓪General Tire & Rubber Co., Silentbloc Div., Wabash, Ind.
- ⓪Houghton Laboratories, Inc., 322 Bush St., Olean, N. Y.
- ⓪Huse Liberty Mica Co., 171 Camden St., Boston, Mass.
- ⓪Insulating Fabricators, Inc., 150 Union Ave., East Rutherford, N. J.
- ⓪Insulating Fabricators of New England, Inc., 69 Grove St., Watertown 72, Mass.
- ⓪Insulation Manufacturers Corp., 565 W. Washington Blvd., Chicago 6, Ill.
- ⓪Insuline Corp. of America, 36-02 35th Ave., Long Island City, N. Y.
- ⓪Isolantite Mfg. Corp., Stirling, N. J.
- ⓪Keystone Electronics Corp., 423 Broome St., New York 12, N. Y.
- ⓪Kirchberger & Co., Inc., M., 1425 37th St., Brooklyn 18, N. Y.
- ⓪Laminated Plastics, Inc., 1823 E. 40th St., Cleveland 3, Ohio.

Ⓜ indicates . . . IN PRODUCTION • AVAILABILITY • UNRESTRICTED FOR GENERAL USE

- Mica Fabricating Co., 53 Central Ave., Rochelle Park, N. J.
- ⓂMica Insulator Co., Schenectady 1, N. Y.
- Micarta Fabricators, Inc., 5324 Ravenswood Ave., Chicago 40, Ill.
- ⓂMolded Insulation Co., 335 E. Price, Philadelphia 44, Pa.
- ⓂMoore Co., Howard J., 108 Park Row, New York 7, N. Y.
- ⓂMYCALEX CORP. OF AMERICA, 60 Clifton Blvd., Clifton, N. J. ADV. PG. 258, 259.
- ⓂMykroy Inc., Arlington Heights Airport, Arlington Heights, Ill.
- ⓂNATIONAL VULCANIZED FIBRE CO., Wilmington, Del. ADV. PG. 251.
- ⓂPanelyte Div., St. Regis Sales Co., 230 Park Ave., New York 17, N. Y.
- ⓂPenn Fibre & Specialty Co., 2020 E. Westmoreland St., Philadelphia 44, Pa.
- ⓂPlasticraft Products Co., 20 Hudson St., New York 13, N. Y.
- ⓂPlax Corp., P. O. Box 1019, Hartford 5, N. Y.
- ⓂPRECISION PAPER TUBE CO., 2033 W. Charleston St., Chicago 47, Ill. ADV. PG. 156.
- ⓂRICHARDSON CO., THE, 2767 Lake St., Melrose Park, Ill. ADV. PG. 310.
- ⓂSmith, Inc., Herman H., 436 18th St., Brooklyn 15, N. Y.
- ⓂSpaulding Fibre Co., Inc., 310 Wheeler St., Tonawanda, N. Y.
- ⓂStevens Products Inc., 86-88 Main St., East Orange, N. J.
- ⓂSteward Mfg. Co., D. M., 3600 Jerrome Ave., Chattanooga 1, Tenn.
- ⓂSynthane Corp., Oaks, Pa.
- ⓂTaylor Fibre Co., Norristown, Pa.
- ⓂTEFLON PRODUCTS DIVISION, U. S. GASKET CO., P. O. Box 93, Camden, N. J. ADV. PG. 176
- ⓂTHOR CERAMICS INC., 225 Belleville Ave., Bloomfield, N. J. ADV. PG. 378.
- ⓂTinnerman Products, Inc., P. O. Box 6688, Dept. No. 16, Cleveland 1, Ohio.
- ⓂVarflex Corp., 308 N. Jay St., Rome, N. Y.
- ⓂWilmington Fibre Specialty Co., P. O. Drawer 1028, Wilmington 99, Del.

Insulating Cord

- ⓂGordon Co., Claud S., 3000 S. Wallace St., Chicago 16, Ill.

Insulating Foil

- ⓂGasket Engineering Co., 2440 Charlotte St., Kansas City 8, Mo.
- ⓂJohnston Foil Mfg. Co., 6100 S. Broadway, St. Louis 11, Mo.

Insulating Sleeves

- ⓂAIRCRAFT-MARINE PRODUCTS, INC., 2100 Paxton St., Harrisburg 10, Pa. ADV. PG. 367.
- ⓂAMERICAN LAVA CORP., Chattanooga 5, Tenn. ADV. PG. 143.
- ⓂAnchor Industrial Co., 533-541 Canal St., New York 13, N. Y.
- ⓂBENTLEY-HARRIS MFG. CO., Conshohocken, Pa. ADV. PG. 269.
- ⓂBRAND & CO., INC., WM., North & Valley Sts., Willimantic, Conn. ADV. PG. 248, 249.
- Brandywine Fibre Co., 15th & Poplar Sts., Wilmington, Del.
- ⓂCLEVELAND CONTAINER CO., THE, 6201 Barberton Ave., Cleveland 2, Ohio. ADV. PG. 89.
- ⓂGeneral Cement Mfg. Co., 919 Taylor Ave., Rockford, Ill.
- ⓂGENERAL CERAMICS & STEATITE CORP., Keasbey, N. J. ADV. PG. 126, 127.
- ⓂIndustrial Synthetics Corp., 225 North Ave., Garwood, N. J.
- Insulating Fabricators, Inc., 150 Union Ave., East Rutherford, N. J.
- ⓂInsulating Fabricators of New England, Inc., 69 Grove St., Watertown 72, Mass.
- ⓂInsulation Manufacturers Corp., 565 W. Washington Blvd., Chicago 6, Ill.
- Mica Fabricating Co., 53 Central Ave., Rochelle Park, N. J.
- ⓂMITCHELL-RAND INSULATION CO., INC., 51 Murray St., New York 7, N. Y. ADV. PG. 219.
- ⓂMykroy, Inc., Arlington Heights Airport, Arlington Heights, Ill.
- ⓂNATIONAL VARNISHED PRODUCTS CORP., THE, 211 Randolph Ave., Woodbridge, N. J. ADV. PG. 152.
- ⓂPRECISION PAPER TUBE CO., 2033 W. Charleston St., Chicago 47, Ill. ADV. PG. 156.
- ⓂRICHARDSON CO., THE, 2767 Lake St., Melrose Park, Ill. ADV. PG. 310.
- ⓂSmith, Inc., Herman H., 436 18th St., Brooklyn 15, N. Y.
- ⓂSYNCRU PRODUCTS CO., Malden, Mass. ADV. PG. 405.
- ⓂTEFLON PRODUCTS DIVISION, U. S. GASKET CO., P. O. Box 93, Camden, N. J. ADV. PG. 176

- ⓂTHOR CERAMICS, INC., 225 Belleville Ave., Bloomfield, N. J. ADV. PG. 378.
- ⓂVarflex Corp., 308 N. Jay St., Rome, N. Y.
- ⓂWilmington Fibre Specialty Co., P.O. Drawer 1028, Wilmington 99, Del.

Laminated Insulation Parts

- ⓂBaer Co., N. S., 9 Montgomery St., Hillside, N. J.
- Brandywine Fibre Co., 15th & Poplar Sts., Wilmington, Del.
- ⓂCAMBRIDGE THERMIONIC CORP., 445 Concord Ave., Cambridge 38, Mass. ADV. PG. 37.
- ⓂCINCH MFG. CORP., 1026 S. Homan Ave., Chicago 24, Ill. ADV. PG. 186, 187.
- ⓂCITATION PRODUCTS CO., 233 E. 146th St., New York 51, N. Y. ADV. PG. 388.
- ⓂCLEVELAND CONTAINER CO., THE, 6201 Barberton Ave., Cleveland 2, Ohio. ADV. PG. 89.
- ⓂCortland Industries, Inc., 4545 Cortland St., Chicago 39, Ill.
- ⓂEMELOID CO., INC., THE, 1239 Central Ave., Hillside 5, N. J. ADV. PG. 102.
- ⓂFormica Co., The, 4640 Spring Grove Ave., Cincinnati 32, Ohio.
- ⓂFRANKLIN AIRLOOP CORP., 43-20 34th St., Long Island City, N. Y. ADV. PG. 45.
- ⓂFranklin Fibre-Lamitex Corp., 12th and French Sts., Wilmington, Del.
- ⓂFRANKLIN MFG. CORP., A. W., 43-20 34th St., Long Island City, N. Y. ADV. PG. 44.
- ⓂGeneral Tire & Rubber Co., Silentbloc Div., Wabash, Ind.
- ⓂHuse Liberty Mica Co., 171 Camden St., Boston, Mass.
- Insulating Fabricators, Inc., 150 Union Ave., East Rutherford, N. J.
- ⓂInsulating Fabricators of New England, Inc., 69 Grove St., Watertown 72, Mass.
- ⓂInsulating Tube Co., 26 Cottage St., P.O. Box 1, Poughkeepsie, N. Y.
- ⓂInsulation Manufacturers Corp., 565 W. Washington Blvd., Chicago 6, Ill.
- ⓂInsuline Corp. of America, 36-02 35th Ave., Long Island City, N. Y.
- ⓂJuel Corp., Arcadia, Calif.
- LaMagna Mfg. Co., Inc., East Rutherford, N. J.
- ⓂLaminated Plastics, Inc., 1823 E. 40th St. Cleveland 3, Ohio.
- Mica Fabricating Co., 53 Central Ave., Rochelle Park, N. J.
- ⓂMica Insulator Co., Schenectady 1, N. Y.
- Micarta Fabricators, Inc., 5324 Ravenswood Ave., Chicago 40, Ill.
- ⓂPanelyte Div., St. Regis Sales Co., 230 Park Ave., New York 17, N. Y.
- ⓂPenn Fibre & Specialty Co., 2020 E. Westmoreland St., Philadelphia 44, Pa.
- ⓂPlasticraft Products Co., 20 Hudson St., New York 13, N. Y.
- ⓂRICHARDSON CO., THE, 2767 Lake St., Melrose Park, Ill. ADV. PG. 310.
- ⓂRogers Corp., Manchester, Conn.
- ⓂSpaulding Fibre Co., Inc., 310 Wheeler St., Tonawanda, N. Y.
- ⓂStevens Products, Inc., 86-88 Main St., East Orange, N. J.
- ⓂSynthane Corp., Oaks, Pa.
- ⓂTaylor Fibre Co., Norristown, Pa.
- ⓂTEFLON PRODUCTS DIVISION, U. S. GASKET CO., P. O. Box 93, Camden, N. J. ADV. PG. 176
- ⓂUcinite Co. Division, United-Carr Fastener Corp., 459 Watertown St., Newtonville, Mass.
- ⓂWESTINGHOUSE ELECTRIC CORP., 511 Wood St., P.O. Box 868, Pittsburgh 30, Pa. ADV. PG. 107-113.
- ⓂWilmington Fibre Specialty Co., P.O. Drawer 1028, Wilmington 99, Del.

Molded Insulation Parts

- ⓂALDEN PRODUCTS CO., 117 No. Main St., Brockton 64, Mass. ADV. PG. 327.
- American Insulator Corp., New Freedom, Pa.
- ⓂAMERICAN MOLDED PRODUCTS CO., 1644 N. Honore St., Chicago 22, Ill. ADV. PG. 382.
- ⓂBIWAX CORP., 3445 Howard St., Skokie, Ill. ADV. PG. 380.
- ⓂCENTRALAB DIV. OF GLOBE UNION INC., 900 E. Keefe Ave., Milwaukee, Wis. ADV. PG. 85-88.
- ⓂCINCH MFG. CORP., 1026 S. Homan Ave., Chicago 24, Ill. ADV. PG. 186, 187.
- ⓂConsolidated Molded Products Corp., Scranton 2, Pa.
- ⓂCrane Packing Co., 1800 Cuyler Ave., Chicago 13, Ill.
- ⓂEBY, INC., HUGH H., 4700 Stenton Ave., Philadelphia 44, Pa. ADV. PG. 214.
- ⓂELECTRONIC MECHANICS INC., 70 Clifton Blvd., Clifton, N. J. ADV. PG. 309.
- ⓂEMELOID CO., INC., THE, 1239 Central Ave., Hillside 5, N. J. ADV. PG. 102.
- Felsenthal & Sons, Inc., G., 4100 W. Grand Ave., Chicago 51, Ill.
- ⓂFRANKLIN AIRLOOP CORP., 43-20 34th St., Long Island City, N. Y. ADV. PG. 45.
- ⓂFRANKLIN MFG. CORP., A. W., 43-20 34th St., Long Island City, N. Y. ADV. PG. 44.
- Gemold Corp., 79-10 Albion Ave., Elmhurst, N. Y.
- ⓂGits Molding Corp., 4600 W. Huron St., Chicago 14, Ill.
- ⓂIndustrial Devices, Inc., 22 State Rd., Edgewater, N. J.
- ⓂIndustrial Synthetic Corp., 225 North Ave., Garwood, N. J.
- ⓂInsulating Fabricators of New England, Inc., 69 Grove St., Watertown 72, Mass.
- Insulating Fabricators, Inc., 150 Union Ave., East Rutherford, N. J.
- ⓂInsuline Corp. of America, 36-02 35th Ave., Long Island City, N. Y.

- ⓂGENERAL CERAMICS & STEATITE CORP., Keasbey, N. J. ADV. PG. 126, 127.
- ⓂGeneral Tire & Rubber Co., Silentbloc Div., Wabash, Ind.
- ⓂGits Molding Corp., 4600 W. Huron St., Chicago 44, Ill.
- ⓂGries Reproducer Corp., 100 Willow Ave., New York 54, N. Y.
- ⓂHawley Products Co., St. Charles, Ill.
- ⓂIndustrial Devices, Inc., 22 State Rd., Edgewater, N. J.
- ⓂInsuline Corp. of America, 36-02 35th Ave., Long Island City, N. Y.
- Insulation Mfg. Co., 11 New York Ave., Brooklyn, N. Y.
- ⓂJuel Corp., Arcadia, Calif.
- ⓂKeasbey & Mattison, Ambler, Pa.
- ⓂKULKA ELECTRIC MFG. CO., INC., 30 South St., Mount Vernon, N. Y. ADV. PG. 317.
- ⓂLaminated Plastics, Inc., 1823 E. 40th St., Cleveland 3, Ohio.
- Mack Molding Co., Wayne, N. J.
- ⓂMayfair Molded Products Corp., 4440 N. Elston Ave., Chicago 30, Ill.
- ⓂMETHODE MFG. CORP., 2265 W. St. Paul Ave., Chicago 47, Ill. ADV. PG. 347.
- Mica Fabricating Co., 53 Central Ave., Rochelle Park, N. J.
- ⓂMillen Mfg. Co., James, 150 Exchange St., Malden, Mass.
- ⓂMolded Insulation Co., 335 E. Price St., Philadelphia 44, Pa.
- ⓂMYCALEX CORP. OF AMERICA, 60 Clifton Blvd., Clifton, N. J. ADV. PG. 258, 259.
- ⓂMykroy, Inc., Arlington Heights Airport, Arlington Heights, Ill.
- ⓂNEO-SIL CORP., 26 Cornelison Ave., Jersey City 4, N. J. ADV. PG. 253.
- ⓂNorthern Industrial Chemical Co., 7-11 Elkins St., South Boston 27, Mass.
- ⓂPanelyte Div., St. Regis Sales Co., 230 Park Ave., New York 17, N. Y.
- ⓂQuality Components, Inc., St. Marys, Pa.
- ⓂRemler Co., Ltd., 2101 Bryant St., San Francisco 10, Calif.
- ⓂRICHARDSON CO., THE, 2767 Lake St., Melrose Park, Ill. ADV. PG. 310.
- ⓂSmith, Inc., Herman H., 436 18th St., Brooklyn 15, N. Y.
- ⓂSteward Mfg. Co., D. M., 3600 Jerrome Ave., Chattanooga 1, Tenn.
- ⓂSTUPAKOFF CERAMIC & MFG. CO., Latrobe, Pa. ADV. PG. 167.
- ⓂTEFLON PRODUCTS DIVISION, U. S. GASKET CO., P. O. Box 93, Camden, N. J. ADV. PG. 176
- ⓂTHOR CERAMICS INC., 225 Belleville Ave., Bloomfield, N. J. ADV. PG. 378.
- ⓂTransradio, Ltd., 138A Cromwell Rd., London S. W. 7, England.
- ⓂWESTINGHOUSE ELECTRIC CORP., 511 Wood St., P.O. Box 868, Pittsburgh 30, Pa. ADV. PG. 107-113.

Plastic Insulation Parts

- American Insulator Corp., New Freedom, Pa.
- ⓂAMERICAN MOLDED PRODUCTS CO., 1644 N. Honore St., Chicago 22, Ill. ADV. PG. 382.
- ⓂAnchor Plastics Co., Inc., 533-541 Canal St., New York 13, N. Y.
- ⓂBaer Co., N. S., 9 Montgomery St., Hillside, N. J.
- ⓂBRAND & CO., INC., WM., North & Valley Sts., Willimantic, Conn. ADV. PG. 248, 249.
- Brandywine Fibre Co., 15th & Poplar Sts., Wilmington, Del.
- ⓂCINCH MFG. CORP., 1026 S. Homan Ave., Chicago 26, Ill. ADV. PG. 186, 187.
- ⓂCITATION PRODUCTS CO., 233 E. 146th St., New York 51, N. Y. ADV. PG. 388.
- ⓂConsolidated Molded Products Corp., Scranton 2, Pa.
- ⓂCortland Industries, Inc., 4545 Cortland St., Chicago 39, Ill.
- ⓂCrane Packing Co., 1800 Cuyler Ave., Chicago 13, Ill.
- ⓂDielectric Materials Co., 5315-17 N. Ravenswood Ave., Chicago 40, Ill.
- ⓂELECTRONIC MECHANICS, INC., 70 Clifton Blvd., Clifton, N. J. ADV. PG. 309.
- ⓂEMELOID CO., INC., THE, 1239 Central Ave., Hillside 5, N. J. ADV. PG. 102.
- Felsenthal & Sons, Inc., G., 4100 W. Grand Ave., Chicago 51, Ill.
- ⓂFormica Co., The, 4640 Spring Grove Ave., Cincinnati 32, Ohio.
- ⓂFRANKLIN AIRLOOP CORP., 43-20 34th St., Long Island City, N. Y. ADV. PG. 45.
- ⓂFRANKLIN MFG. CORP., A. W., 43-20 34th St., Long Island City, N. Y. ADV. PG. 44.
- Gemold Corp., 79-10 Albion Ave., Elmhurst, N. Y.
- ⓂGits Molding Corp., 4600 W. Huron St., Chicago 14, Ill.
- ⓂIndustrial Devices, Inc., 22 State Rd., Edgewater, N. J.
- ⓂIndustrial Synthetic Corp., 225 North Ave., Garwood, N. J.
- ⓂInsulating Fabricators of New England, Inc., 69 Grove St., Watertown 72, Mass.
- Insulating Fabricators, Inc., 150 Union Ave., East Rutherford, N. J.
- ⓂInsuline Corp. of America, 36-02 35th Ave., Long Island City, N. Y.

Ⓢ indicates . . . IN PRODUCTION • AVAILABILITY • UNRESTRICTED FOR GENERAL USE

- ⓈJuel Corp., Arcadia, Calif.
 ⓈKeystone Electronics Corp., 423 Broome St., New York 12, N. Y.
 ⓈKULKA ELECTRIC MFG. CO., INC., 30 South St., Mount Vernon, N. Y. ADV. PG. 317.
 ⓈLaminated Plastics, Inc., 1823 E. 40th St., Cleveland 3, Ohio.
 ⓈMack Molding Co., Wayne, N. J.
 ⓈMETHODE MFG. CORP., 2265 W. St. Paul Ave., Chicago 47, Ill. ADV. PG. 347.
 ⓈMica Fabricating Co., 53 Central Ave., Rochelle Park, N. J.
 ⓈMica Insulator Co., Schenectady 1, N. Y.
 ⓈMicrocraft Products Inc., 701 McCarter Highway, Newark 5, N. J.
 ⓈMicarta Fabricators, Inc., 5324 Ravenswood Ave., Chicago 40, Ill.
 ⓈMolded Insulation Co., 335 E. Price St., Philadelphia 44, Pa.
 ⓈMoore Co., Howard J., 108 Park Row, New York 7, N. Y.
 ⓈMYCALEX CORP. OF AMERICA, 60 Clifton Blvd., Clifton, N. J. ADV. PG. 258, 259.
 ⓈNATIONAL VULCANIZED FIBRE CO., Wilmington, Del. ADV. PG. 251.
 ⓈNEO-SIL CORP., 26 Cornelison Ave., Jersey City 4, N. J. ADV. PG. 253.
 ⓈNorthern Industrial Chemical Co., 7-11 Elkins St., South Boston 27, Mass.
 ⓈPanelyte Div., St. Regis Sales Co., 230 Park Ave., New York 17, N. Y.
 ⓈParisian Novelty Co., 3510 South Western Ave., Chicago 9, Ill.
 ⓈPenn Fibre & Specialty Co., 2020 E. Westmoreland St., Philadelphia 44, Pa.
 ⓈPlastic Accessories, Inc., 93 Mercer St., New York 12, N. Y.
 ⓈPlasticraft Products Co., 20 Hudson St., New York 13, N. Y.
 ⓈPlastimold Corp., Attleboro, Mass.
 ⓈPlax Corp., P. O. Box 1019, Hartford 5, Conn.
 ⓈPRECISION PAPER TUBE CO., 2033 W. Charleston St., Chicago 47, Ill. ADV. PG. 156.
 ⓈPrintloid Inc., 95 Mercer St., New York, N. Y.
 ⓈQuality Components, Inc., St. Marys, Pa.
 ⓈRemler Co., Ltd., 2101 Bryant St., San Francisco 10, Calif.
 ⓈRICHARDSON CO., THE, 2767 Lake St., Melrose Park, Ill. ADV. PG. 310.
 ⓈRogers Corp., Manchester, Conn.
 ⓈSillicocks-Miller Co., 10 Parker Ave. W., So. Orange, N. J.
 ⓈSmith, Inc., Herman H., 436 18th St., Brooklyn 15, N. Y.
 ⓈSpaulding Fibre Co., Inc., 310 Wheeler St., Tonawanda, N. Y.
 ⓈSurprenant Mfg. Co., 199 Washington St., Boston 8, Mass.
 ⓈSynthane Corp., Oaks, Pa.
 ⓈTEFLON PRODUCTS DIVISION, U. S. GASKET CO., P. O. Box 93, Camden, N. J. ADV. PG. 176.
 ⓈVarflex Corp., 308 N. Jay St., Rome, N. Y.
 ⓈWESTINGHOUSE ELECTRIC CORP., 511 Wood St., P. O. Box 868, Pittsburgh 30, Pa. ADV. PG. 107-113.

Rods

- ⓈAMERICAN LAVA CORP., Chattanooga 5, Tenn. ADV. PG. 143.
 ⓈAnchor Plastics Co., Inc., 533-541 Canal St., New York 13, N. Y.
 ⓈBaer Co., N. S., 9 Montgomery St., Hillside, N. J.
 ⓈBrandywine Fibre Co., 15th & Poplar Sts., Wilmington, Del.
 ⓈCortland Industries, Inc., 4545 Cortland St., Chicago 39, Ill.
 ⓈCrane Packing Co., 1800 Cuyler Ave., Chicago 13, Ill.
 ⓈFormica Co., The, 4640 Spring Grove Ave., Cincinnati 32, Ohio.
 ⓈFranklin Fibre-Lamitex Corp., 12th & French Sts., Wilmington, Del.
 ⓈGeneral Cement Mfg. Co., 919 Taylor Ave., Rockford, Ill.
 ⓈGENERAL ELECTRIC CO., Chemical Dept., Pittsfield, Mass. ADV. PG. 1 to 22.
 ⓈInsulating Fabricators of New England Inc., 69 Grove St., Watertown 72, Mass.
 ⓈInsulating Fabricators, Inc., 150 Union Ave., East Rutherford, N. J.
 ⓈInsuline Corp. of America, 36-02 35th Ave., Long Island City, N. Y.
 ⓈKirchberger & Co., Inc., M., 1425 37th St., Brooklyn, N. Y.
 ⓈLuzerne Rubber Co., Muirhead Ave., Trenton, N. J.
 ⓈMica Fabricating Co., 53 Central Ave., Rochelle Park, N. J.
 ⓈMYCALEX CORP. OF AMERICA, 60 Clifton Blvd., Clifton, N. J. ADV. PG. 258, 259.
 ⓈMykroy, Inc., Arlington Heights Airport, Arlington Heights, Ill.
 ⓈNATIONAL VULCANIZED FIBRE CO., Wilmington, Del. ADV. PG. 251.
 ⓈPenn Fibre & Specialty Co., 2020 E. Westmoreland St., Philadelphia 44, Pa.
 ⓈPlasticraft Products Co., 20 Hudson St., New York 13, N. Y.
 ⓈPlax Corp., P. O. Box 1019, Hartford 5, Conn.

- ⓈRICHARDSON CO., THE, 2767 Lake St., Melrose Park, Ill. ADV. PG. 310.
 ⓈSmith, Inc., Herman H., 436 18th St., Brooklyn, 15, N. Y.
 ⓈSpaulding Fibre Co. Inc., 310 Wheeler St., Tonawanda, N. Y.
 ⓈSteward Mfg. Co., D. M., 3600 Jerome Ave., Chattanooga 1, Tenn.
 ⓈSurprenant Mfg. Co., 199 Washington St., Boston 8, Mass.
 ⓈSynthane Corp., Oaks, Pa.
 ⓈTaylor Fibre Co., Norristown, Pa.
 ⓈTEFLON PRODUCTS DIVISION, U. S. GASKET CO., P. O. Box 93, Camden, N. J. ADV. PG. 176.
 ⓈWESTINGHOUSE ELECTRIC CORP., 511 Wood St., P. O. Box 868, Pittsburgh 30, Pa. ADV. PG. 107-113.
 ⓈWilmington Fibre Specialty Co., P. O. Drawer 1028, Wilmington 99, Del.

Screw Machine Parts

- ⓈAEROLITE ELECTRONIC HARDWARE CORP., 507 26th St., Union City, N. J. ADV. PG. 355.
 ⓈAllmetal Screw Products Co., Inc., 33 Greene St., New York 13, N. Y.
 ⓈART-LLOYD METAL PRODUCTS CORP., 2973 Cropsey Ave., Brooklyn 14, N. Y. ADV. PG. 367.
 ⓈAutoscrew Co., 216-222 W. 18th St., New York 11, N. Y.
 ⓈBassett, Inc., Rex., 307-11 N. W. First Ave., Fort Lauderdale, Fla.
 ⓈBawkins Machine Co., 30 Burtis Ave., New Canaan, Conn.
 ⓈBrandywine Fibre Co., 15th & Poplar Sts., Wilmington, Del.
 ⓈCAMBRIDGE THERMIONIC CORP., 445 Concord Ave., Cambridge 38, Mass. ADV. PG. 37.
 ⓈCITATION PRODUCTS CO., 233 E. 146th St., New York 51, N. Y. ADV. PG. 388.
 ⓈCortland Industries, Inc., 4545 Cortland St., Chicago 39, Ill.
 ⓈFranklin Fibre-Lamitex Corp., 12th and French Sts., Wilmington, Del.
 ⓈHoughton Laboratories, Inc., 322 Bush St., Olean, N. Y.
 ⓈIndustrial Precision Products Co., 315-325 N. Hoyme Ave., Chicago 12, Ill.
 ⓈInsuline Corp of America, 36-02 35th Ave., Long Island City, N. Y.
 ⓈInsulating Fabricators, Inc., 150 Union Ave., East Rutherford, N. J.
 ⓈInsulating Fabricators of New England, Inc., 69 Grove St., Watertown 72, Mass.
 ⓈJudd Co., H. L., 87 Chambers St., New York 7, N. Y.
 ⓈLa Magna Mfg. Co., Inc., East Rutherford, N. J.
 ⓈMolded Insulation Co., 335 E. Price St., Philadelphia 44, Pa.
 ⓈMykroy, Inc., Arlington Heights Airport, Arlington Heights, Ill.
 ⓈNational Tel-Tronics Corp., 35 St. Casimirs Ave., Yonkers, N. Y.
 ⓈNATIONAL VULCANIZED FIBRE CO., Wilmington, Del. ADV. PG. 251.
 ⓈPenn Fibre & Specialty Co., 2020 E. Westmoreland St., Philadelphia 44, Pa.
 ⓈPlume & Atwood Mfg. Co., 220 Broadway, New York, N. Y.
 ⓈPrecision Devices, Inc., 147-149 Cedar St., New York 6, N. Y.
 ⓈRemler Co., Ltd., 2101 Bryant St., San Francisco 10, Calif.
 ⓈScovill Mfg. Co., Industrial Fastener Div., Waterbury, Conn.
 ⓈSmith, Inc., Herman H., 436 18th St., Brooklyn 15, N. Y.
 ⓈSpaulding Fibre Co., Inc., 310 Wheeler St., Tonawanda, N. Y.
 ⓈStamford Metal Specialty Co., Inc., 429 W. Broadway, New York 12, N. Y.
 ⓈStimpson Co., Inc., Edwin B., 74 Franklin Ave., Brooklyn 5, N. Y.
 ⓈSynthane Corp., Oaks, Pa.
 ⓈTaylor Fibre Co., Norristown, Pa.
 ⓈTEFLON PRODUCTS DIVISION, U. S. GASKET CO., P. O. Box 93, Camden, N. J. ADV. PG. 176.
 ⓈUnited-Carr Fastener Corp., Cambridge 42, Mass.
 ⓈVitamite Co., 227 W. 64th St., New York 23, N. Y.

Sheets

- ⓈAMERICAN LAVA CORP., Chattanooga 5, Tenn. ADV. PG. 143.
 ⓈAnchor Plastics Co., Inc., 533-541 Canal St., New York 13, N. Y.
 ⓈBaer Co., N. S., 9 Montgomery St., Hillside, N. J.
 ⓈBISHOP MFG. CO., 254 W. 31st St., New York 1, N. Y. ADV. PG. 224.
 ⓈCortland Industries, Inc., 4545 Cortland St., Chicago 39, Ill.
 ⓈFormica Co., The, 4640 Spring Grove Ave., Cincinnati 32, Ohio.
 ⓈFranklin Fibre-Lamitex Corp., 12th and French Sts., Wilmington, Del.
 ⓈGasket Engineering Co., 2440 Charlotte St., Kansas City 8, Mo.

- ⓈGENERAL ELECTRIC CO., Chemical Dept., Pittsfield, Mass. ADV. PG. 1 to 22.
 ⓈInsulating Fabricators, Inc., 150 Union Ave., East Rutherford, N. J.
 ⓈInsulating Fabricators of New England, Inc., 69 Grove St., Watertown 72, Mass.
 ⓈMica Fabricating Co., 53 Central Ave., Rochelle Park, N. J.
 ⓈMica Insulator Co., Schenectady 1, N. Y.
 ⓈMYCALEX CORP. OF AMERICA, 60 Clifton Blvd., Clifton, N. J. ADV. PG. 258, 259.
 ⓈMykroy, Inc., Arlington Heights Airport, Arlington Heights, Ill.
 ⓈNATIONAL VULCANIZED FIBRE CO., Wilmington, Del. ADV. PG. 251.
 ⓈPenn Fibre & Specialty Co., 2020 E. Westmoreland St., Philadelphia 44, Pa.
 ⓈPlax Corp., P. O. Box 1019, Hartford, 5, Conn.
 ⓈRICHARDSON CO., THE, 2767 Lake St., Melrose Park, Ill. ADV. PG. 310.
 ⓈSpaulding Fibre Co., Inc., 310 Wheeler St., Tonawanda, N. Y.
 ⓈSynthane Corp., Oaks, Pa.
 ⓈTaylor Fibre Co., Norristown, Pa.
 ⓈTEFLON PRODUCTS DIVISION, U. S. GASKET CO., P. O. Box 93, Camden, N. J. ADV. PG. 176.
 ⓈWESTINGHOUSE ELECTRIC CORP., 511 Wood St., P. O. Box 868, Pittsburgh 30, Pa. ADV. PG. 107-113.
 ⓈWilmington Fibre Specialty Co., P. O. Drawer 1028, Wilmington 99, Del.

Stampings & Punchings—Ceramic

- ⓈAMERICAN LAVA CORP., Chattanooga 5, Tenn. ADV. PG. 143.
 ⓈART-LLOYD METAL PRODUCTS CORP., 2973 Cropsey Ave., Brooklyn 14, N. Y. ADV. PG. 364.
 ⓈCENTRALAB, DIV. OF GLOBE UNION INC., 900 E. Keefe Ave., Milwaukee 1, Wis. ADV. PG. 85-88.
 ⓈElectrical Refractories Co., 50 Clark St., East Palestine, Ohio.
 ⓈFRANKLIN AIRLOOP CORP., 43-20 34th St., Long Island City, N. Y. ADV. PG. 45.
 ⓈFRANKLIN MFG. CORP., A. W., 43-20 34th St., Long Island City 1, N. Y. ADV. PG. 44.
 ⓈGENERAL CERAMICS & STEATITE CORP., Keasbey, N. J. ADV. PG. 126, 127.
 ⓈIsolantite Mfg. Corp., Stirling, N. J.
 ⓈJudd Co., H. L., 87 Chamber St., New York 7, N. Y.
 ⓈKirchberger & Co., Inc., M., 1425 37th St., Brooklyn 18, N. Y.
 ⓈLacoria Corp., 375 S. 6th St., Newark 7, N. J.
 ⓈLa Magna Mfg. Co., Inc., East Rutherford, N. J.
 ⓈLOUTHAN MFG. CO., East Liverpool, Ohio. ADV. PG. 284.
 ⓈMica Fabricating Co., 53 Central Ave., Rochelle Park, N. J.
 ⓈMolded Insulation Co., 334 E. Price St., Philadelphia 44, Pa.
 ⓈNational Tel-Tronics Corp., 35 St. Casimirs Ave., Yonkers, N. Y.
 ⓈPenn Fibre & Specialty Co., 2020 E. Westmoreland St., Philadelphia 44, Pa.
 ⓈRepach Co., Paul R., 641 E. 61st St., Los Angeles 1, Calif.
 ⓈStar Porcelain Co., 61 Muirhead Ave., Trenton 9, N. J.
 ⓈSteward Mfg. Co., D. M., 3600 Jerome Ave., Chattanooga 1, Tenn.
 ⓈSTUPAKOFF CERAMIC & MFG. CO., Latrobe, Pa. ADV. PG. 167.
 ⓈSYLVANIA ELECTRIC PRODUCTS, INC., 1740 Broadway, New York 19, N. Y. ADV. PG. 432-436.
 ⓈSYNCOR PRODUCTS CO., Malden, Mass. ADV. PG. 405.
 ⓈTHOR CERAMICS INC., 225 Belleville Ave., Bloomfield, N. J. ADV. PG. 378.
 ⓈWestern Gold & Platinum Works, 589 Bryant St., San Francisco, Calif.
 ⓈWisconsin Porcelain Co., Sun Prairie, Wisconsin.

Stampings & Punchings—Plastics or Laminates

- ⓈAcme Electric Heating Co., 1217 Washington St., Boston, Mass.
 ⓈAcme Folding Box Co., Inc., 149 E. 25th St., New York 10, N. Y.
 ⓈAEROLITE ELECTRONIC HARDWARE CORP., 507 26th St., Union City, N. J. ADV. PG. 355.
 ⓈART-LLOYD METAL PRODUCTS CORP., 2973 Cropsey Ave., Brooklyn 14, N. Y. ADV. PG. 364.
 ⓈAuburn Mfg. Co., Pease Ave. & Stack St., Middletown, Conn.
 ⓈBaer Co., N. S., 9 Montgomery St., Hillside, N. J.
 ⓈBestcraft Products, 626 Broadway, New York, N. Y.
 ⓈBrandywine Fibre Co., 15th & Poplar Sts., Wilmington, Del.
 ⓈCINCH MFG. CORP., 1026 S. Homan Ave., Chicago 24, Ill. ADV. PG. 186, 187.
 ⓈCITATION PRODUCTS CO., 233 E. 146th St., New York 51, N. Y. ADV. PG. 388.
 ⓈCortland Industries, Inc., 4545 Cortland St., Chicago 39, Ill.
 ⓈDonnelly Electric & Mfg. Co., 3050 Washington St., Boston 19, Mass.

V indicates . . . IN PRODUCTION • AVAILABILITY • UNRESTRICTED FOR GENERAL USE

- EBY INC., Hugh H., 4700 Stenton Ave., Philadelphia 44, Pa. ADV. PG. 214.
- EMELOID CO., INC., THE, 1239 Central Ave., Hillside 5, N. J. ADV. PG. 102.
- Felt Products Mfg. Co., 1504 W. Carroll Ave., Chicago 7, Ill.
- FRANKLIN AIRLOOP CORP., 43-20 34th St., Long Island City, N. Y. ADV. PG. 45.
- Franklin Fibre-Lamitex Corp., 12th and French Sts., Wilmington, Del.
- FRANKLIN MFG. CORP., A. W., 43-20 34th St., Long Island City, N. Y. ADV. PG. 44.
- Gasket Engineering Co., 2440 Charlotte St., Kansas City 8, Mo.
- INDUSTRIAL HARDWARE MFG. CO., INC., 109 Prince St., New York, N. Y. ADV. PG. 360.
- Industrial Precision Products Co., 315-325 N. Hoyne Ave., Chicago 12, Ill.
- Insulating Fabricators of New England, Inc., 69 Grove St., Watertown 72, Mass.
- Insulating Fabricators, Inc., 150 Union Ave., East Rutherford, N. J.
- Insulation Manufacturers Corp., 565 W. Washington Blvd., Chicago 6, Ill.
- Insuline Corp. of America, 36-02 35th Ave., Long Island City, N. Y.
- Keystone Electronics Corp., 423 Broome St., New York 12, N. Y.
- La Magna Mfg. Co., Inc., East Rutherford, N. J.
- Magna Electronics Co., 3707-11 W. Jefferson Blvd., Los Angeles 16, Calif.
- Mica Fabricating Co., 52 Central Ave., Rochelle Park, N. J.
- Micarta Fabricators, Inc., 5324 Ravenswood Ave., Chicago 40, Ill.
- Molded Insulation Co., 335 E. Price St., Philadelphia 44, Pa.
- Moore Co., Howard J., 108 Park Row, New York 7, N. Y.
- NATIONAL VULCANIZED FIBRE CO., Wilmington, Del. ADV. PG. 251.
- Penn Fibre & Specialty Co., 2020 E. Westmoreland St., Philadelphia 44, Pa.
- Plasticraft Products Co., 20 Hudson St., New York 13, N. Y.
- Presto Electric Co., Inc., 4513 New York Ave., Union City, N. J.
- RICHARDSON CO., THE, 2767 Lake St., Melrose Park, Ill. ADV. PG. 310.
- Rogers Corp., Manchester, Conn.
- Smith, Inc., Herman H., 436 18th St., Brooklyn 15, N. Y.
- Spaulding Fibre Co., Inc., 310 Wheeler St., Tonawanda, N. Y.
- Stamford Metal Specialty Co., Inc., 429 W. Broadway, New York 12, N. Y.
- Taylor Fibre Co., Norristown, Pa.
- Tricraft Products Co., 1535 N. Ashland Ave., Chicago 22, Ill.
- Wilmington Fibre Specialty Co., P. O. Drawer 1028, Wilmington 99, Del.
- Wrought Washer Mfg. Co., 2264 S. Bay St., Milwaukee 7, Wis.

Stampings & Punchings—Paper—Mica

- Acme Folding Box Co., Inc., 149 E. 25th St., New York 10, N. Y.
- Asheville-Schoonmaker Mica Co., 900 Jefferson Ave., Newport News, Va.
- Auburn Mfg. Co., Pease Ave. & Stack St., Middletown, Conn.
- BRAND & CO., INC., WM., North & Valley Sts., Willimantic, Conn. ADV. PG. 248, 249.
- Brandywine Fibre Co., 15th & Poplar Sts., Wilmington, Del.
- CITATION PRODUCTS CO., 233 E. 146th St., New York 51, N. Y. ADV. PG. 388.
- Cortland Industries, Inc., 4545 Cortland St., Chicago 39, Ill.
- Felt Products Mfg. Co., 1504 W. Carroll Ave., Chicago 7, Ill.
- Ford Radio & Mica Corp., 436 63rd St., Brooklyn, N. Y.
- FRANKLIN AIRLOOP CORP., 43-20 34th St., Long Island City, N. Y. ADV. PG. 45.
- FRANKLIN MFG. CORP., A. W., 43-20 34th St., Long Island City, N. Y. ADV. PG. 44.
- Gasket Engineering Co., 2440 Charlotte St., Kansas City 8, Mo.
- Industrial Precision Products Co., 315-325 N. Hoyne Ave., Chicago 12, Ill.
- Insulating Fabricators, Inc., 150 Union Ave., East Rutherford, N. J.
- Insulation Manufacturers Corp., 565 W. Washington Blvd., Chicago 6, Ill.
- La Magna Mfg. Co., Inc., East Rutherford, N. J.
- Mica Fabricating Co., 53 Central Ave., Rochelle Park, N. J.
- Mica Insulator Co., Schenectady 1, N. Y.
- Molded Insulation Co., 335 E. Price St., Philadelphia 44, Pa.
- Moore Co., Howard J., 108 Park Row, New York, N. Y.
- Penn Fibre & Specialty Co., 2020 E. Westmoreland St., Philadelphia 44, Pa.
- Presto Electric Co., Inc., 4513 New York Ave., Union City, N. J.

- Rogers Corp., Manchester, Conn.
- STAVAR CO., INC., Box 431, Bayshore, N. Y. ADV. PG. 232.
- Stevens Products, Inc., 86-88 Main St., East Orange, N. J.
- Synthane Corp., Oaks, Pa.
- Wilmington Fibre Specialty Co., P. O. Drawer 99, Wilmington 99, Del.

Tapes, Insulating

- Accurate Mfg. Co., 44 Hepworth Place, Garfield, N. J.
- Bauer & Black, 222 W. Adams St., Chicago, Ill.
- BISHOP MFG. CORP., 254 W. 31st St., New York 1, N. Y. ADV. PG. 224.
- BRAND & CO., INC., WM., North & Valley Sts., Willimantic, Conn. ADV. PG. 248, 249.
- Crane Packing Co., 1800 Cuyler Ave., Chicago 13, Ill.
- Du Pont de Nemours & Co., Inc., E. I. Wilmington 98, Delaware.
- Electro-Technical Products Div. of Sun Chemical Corp., 113 E. Centre St., Nutley 10, N. J.
- General Cement Mfg. Co., 919 Taylor Ave., Rockford, Ill.
- GENERAL ELECTRIC CO., Chemical Dept., Pittsfield, Mass. ADV. PG. 1 to 22.
- Industrial Synthetics Corp., 225 North Ave., Garwood, N. J.
- Industrial Tape Corp., Route 25, New Brunswick, N. J.
- Insulation Manufacturers Corp., 565 W. Washington Blvd., Chicago 6, Ill.
- Johns-Manville, 22 E. 40th St., New York 16, N. Y.
- Keasbey & Mattison, Amherst, Pa.
- Mica Fabricating Co., 53 Central Ave., Rochelle Park, N. J.
- Mica Insulator Co., Schenectady 1, N. Y.
- Minnesota Mining & Mfg. Co., 900 Fauquier Ave., St. Paul 6, Minn.
- NATIONAL VARNISHED PRODUCTS CORP., 211 Randolph Ave., Woodbridge, N. J. ADV. PG. 152.
- New Jersey Wood Finishing Co., Amboy Ave., Woodbridge, N. J.
- Stevens Products, Inc., 86-88 Main St., East Orange, N. J.
- Surprenant Mfg. Co., 199 Washington St., Boston 8, Mass.
- TEFLON PRODUCTS DIVISION, U. S. GASKET CO., P. O. Box 93, Camden, N. J. ADV. PG. 176.
- U. S. Rubber Co., 1230 Avenue of the Americas, New York 20, N. Y.
- WESTINGHOUSE ELECTRIC CORP., 511 Wood St., P. O. Box 868, Pittsburgh 30, Pa. ADV. PG. 107-113.
- Wright & Sons Co., Wm E., West Warren, Mass.

INSULATORS—Antenna Insulators & Spring Assemblies

- Birnbach Radio Co., Inc., 145 Hudson St., New York, N. Y.
- CENTRALAB DIV. OF GLOBE-UNION, INC., 900 E. Keefe Ave., Milwaukee 1, Wis. ADV. PG. 85-88.
- CORNING GLASS WORKS, Corning, N. Y. ADV. PG. 373.
- Flader, Inc., Frederic, 1330 Laskey Rd., Toledo 12, Ohio.
- General Cement Mfg. Co., 919 Taylor Ave., Rockford, Ill.
- Insulation Mfg. Co., 11 New York Ave., Brooklyn, N. Y.
- Insuline Corp. of America, 36-02 35th Ave., Long Island City, N. Y.
- Isolantite Mfg. Corp., Stirling, N. J.
- JOHNSON CO., E. F., Waseca, Minn. ADV. PG. 118, 121.
- La Magna Mfg. Co., Inc., East Rutherford, N. J.
- Lapp Insulator Co., Inc., Radio Specialties Div., 31 Gilbert St., LeRoy, N. Y.
- Mikroy, Inc., Arlington Heights Airport, Arlington Heights, Ill.
- NATIONAL CO., INC., 61 Sherman St., Malden 48, Mass. ADV. PG. 280, 281.
- Premax Products Div., Chisholm-Ryder Co., Inc., Niagara Falls 2, N. Y.
- Radio Merchandise Sales, Inc., 1165 Southern Blvd., New York 59, N. Y.
- STUPAKOFF CERAMIC & MFG. CO., Latrobe, Pa. ADV. PG. 167.
- SYNCOR PRODUCTS CO., Malden, Mass. ADV. PG. 405.
- TECHNICAL APPLIANCE CORP., Sherburne, N. Y. ADV. PG. 378.
- TEFLON PRODUCTS DIVISION, U. S. GASKET CO., P. O. Box 93, Camden, N. J. ADV. PG. 176.
- THOR CERAMICS INC., 225 Belleville Ave., Bloomfield, N. J. ADV. PG. 378.
- Ward Products Corp., Div. of the Gabriel Co., 1523 E. 45th St., Cleveland 3, Ohio.

INSULATORS—Can Liner

- Acme Folding Box Co. Inc., 141 E. 25th St., New York 10, N. Y.

- AMERICAN MOLDED PRODUCTS CO., 1644 N. Honore St., Chicago 22, Ill. ADV. PG. 382.
- Moore Co., Howard J., 108 Park Row, New York 7, N. Y.
- PRECISION PAPER TUBE CO., 2033 W. Charleston St., Chicago 47, Ill. ADV. PG. 156.
- Rogers Corporation, Manchester, Conn.
- TEFLON PRODUCTS DIVISION, U. S. GASKET CO., P. O. Box 93, Camden, N. J. ADV. PG. 176.

INSULATORS—Ceramic

- AMERICAN LAVA CORP., Chattanooga 5, Tenn. ADV. PG. 143.
- Birnbach Radio Co., Inc., 145 Hudson St., New York, N. Y.
- Bud Radio, Inc., 2118 E. 55th St., Cleveland 3, Ohio.
- CAMBRIDGE THERMIONIC CORP., 445 Concord Ave., Cambridge 38, Mass. ADV. PG. 37.
- CENTRALAB DIV. OF GLOBE-UNION, INC., 900 E. Keefe Ave., Milwaukee 1, Wis. ADV. PG. 85-88.
- CROWLEY & CO., INC., HENRY L., 1 Central Ave., West Orange, N. J. ADV. PG. 231.
- Electrical Refractories Co., 50 Clark St., East Palestine, Ohio.
- FRANKLIN AIRLOOP CORP., 43-20 34th St., Long Island City, N. Y. ADV. PG. 145.
- FRANKLIN MFG. CORP., A. W., 43-20 34th St., Long Island City 1, N. Y. ADV. PG. 44.
- GENERAL CERAMICS & STEATITE CORP., Keasbey, N. J. ADV. PG. 126, 127.
- Gordon Co., Claude S., 3000 S. Wallace St., Chicago 16, Ill.
- HELDOR MFG. CO., Div. of Helder Bushing & Terminal Inc., 225 Belleville Ave., Bloomfield, N. J. ADV. PG. 242.
- Illionis Electric Porcelain Co., Macomb, Ill.
- Isolantite Mfg. Corp., Stirling, N. J.
- JOHNSON CO., E. F., Waseca, Minn. ADV. PG. 118, 121.
- Kirchnerberger & Co., Inc., M., 1425 37th St., Brooklyn 18, N. Y.
- Laconia Corp., 37 S. 6th St., Newark 7, N. J.
- Lapp Insulator Co., Inc., Radio Specialties Div., 31 Gilbert St., LeRoy, N. Y.
- Locke Incorporated, P. O. Box 57, Baltimore 3, Md.
- LOUTHAN MFG. CO., East Liverpool, Ohio. ADV. PG. 284.
- Mica Fabricating Co., 53 Central Ave., Rochelle Park, N. J.
- Millen Mfg. Co., James, 150 Exchange St., Malden, Mass.
- MYCALEX CORP. OF AMERICA, 60 Clifton Blvd., Clifton, N. J. ADV. PG. 258, 259.
- Mikroy, Inc., Arlington Heights Airport, Arlington Heights, Ill.
- National Ceramic Co., 400 Southard St., Trenton 2, N. J.
- NATIONAL CO., INC., 61 Sherman St., Malden 48, Mass. ADV. PG. 280, 281.
- Scintilla-Magneto Div. of Bendix Aviation Corp., Sidney, N. Y.
- Star Porcelain Co., 61 Muirhead Ave., Trenton 9, N. J.
- Steward Mfg. Co., D. M., 3600 Jerome Ave., Chattanooga 1, Tenn.
- STUPAKOFF CERAMIC & MFG. CO., Latrobe, Pa. ADV. PG. 167.
- SYNCOR PRODUCTS CO., Malden, Mass. ADV. PG. 405.
- THOR CERAMICS INC., 225 Belleville Ave., Bloomfield, N. J. ADV. PG. 378.
- Western Gold & Platinum Works, 589 Bryant St., San Francisco, Calif.
- WESTINGHOUSE ELECTRIC CORP., 511 Wood St., P. O. Box 868, Pittsburgh 30, Pa. ADV. PG. 107-113.
- Wheaton Co., T. G., Industrial Div., 220 G St., Millville, N. J.
- Wisconsin Porcelain Co., Sun Prairie, Wis.
- Wolfe Co., Inc., Franklin C., 11723 Mississippi Ave., Los Angeles 25, Calif.

INSULATORS—Feeder Spreader

- AMERICAN LAVA CORP., Chattanooga 5, Tenn. ADV. PG. 143.
- Birnbach Radio Co., Inc., 145 Hudson St., New York, N. Y.
- Bud Radio, Inc., 2118 E. 55th St., Cleveland 3, Ohio.
- GENERAL CERAMICS & STEATITE CORP., Keasbey, N. J. ADV. PG. 126, 127.
- Isolantite Mfg. Corp., Stirling, N. J.
- JOHNSON CO., E. F., Waseca, Minn. ADV. PG. 118, 121.
- Lapp Insulator Co., Inc., Radio Specialties Div., 31 Gilbert St., LeRoy, N. Y.
- Millen Mfg. Co., James, 150 Exchange St., Malden, Mass.
- National Ceramic Co., 400 Southard St., Trenton 2, N. J.
- NATIONAL CO., INC., 61 Sherman St., Malden 48, Mass. ADV. PG. 280, 281.
- Steward Mfg. Co., D. M., 3600 Jerome Ave., Chattanooga 1, Tenn.

(V) indicates . . . **IN PRODUCTION • AVAILABILITY • UNRESTRICTED FOR GENERAL USE**

- ⊙ **STUPAKOFF CERAMIC & MFG. CO.**, Latrobe, Pa. ADV. PG. 167.
- ⊙ **TEFLON PRODUCTS DIVISION, U. S. GASKET CO.**, P. O. Box 93, Camden, N. J. ADV. PG. 176.
- ⊙ **THOR CERAMICS INC.**, 225 Belleville Ave., Bloomfield, N. J. ADV. PG. 378.
- ⊙ **Transradio, Ltd.**, 138A Cromwell Rd., London S. W. 7, England.

INSULATORS—Fused Quartz

- Dallons Labs., 5066 Santa Monica Blvd., Los Angeles, Calif.
- ⊙ **GENERAL ELECTRIC CO.**, Lamp Dept., Nela Park, Cleveland 12, Ohio. ADV. PG. 1-22.
- ⊙ **Hanovia Chemical & Mfg. Co.**, 233 N. J. RR Ave., Newark, N. J.
- ⊙ **Jones Optical Works**, A. D. Cambridge, Mass.
- ⊙ **Mica Fabricating Co.**, 53 Central Ave., Rochelle Park, N. J.
- ⊙ **SYNCOR PRODUCTS CO.**, Malden, Mass. ADV. PG. 405.
- ⊙ **Thermal Syndicate Ltd.**, 12 E. 46th St., New York 17, N. Y.

INSULATORS—High Dielectric Paper

- ⊙ **Acme Folding Box Co., Inc.**, 149 E. 25th St., New York 10, N. Y.
- ⊙ **Auburn Mfg. Co.**, Pease Ave. & Stack St., Middletown, Conn.
- ⊙ **Bestcraft Products**, 626 Broadway, New York, N. Y.
- ⊙ **BRAND & CO., INC.**, WM., North & Valley Sts., Willimantic, Conn. ADV. PG. 248, 249.
- ⊙ **Brandywine Fibre Co.**, 15th & Poplar Sts., Wilmington, Del.
- ⊙ **CAMBRIDGE THERMIONIC CORP.**, 445 Concord Ave., Cambridge 38, Mass. ADV. PG. 37.
- ⊙ **CLEVELAND CONTAINER CO., THE**, 6201 Barberton Ave., Cleveland 2, Ohio. ADV. PG. 89.
- ⊙ **Electro-Technical Products Div. of Sun Chemical Corp.**, 113 E. Centre St., Nutley 10, N. J.
- ⊙ **Insulation Manufacturers Corp.**, 565 W. Washington Blvd., Chicago 6, Ill.
- ⊙ **Mica Fabricating Co.**, 53 Central Ave., Rochelle Park, N. J.
- ⊙ **Moore Co.**, Howard J., 108 Park Row, New York 7, N. Y.
- ⊙ **Penn Fibre & Specialty Co.**, 2020 E. Westmoreland St., Philadelphia 44, Pa.
- ⊙ **PRECISION PAPER TUBE CO.**, 2033 W. Charleston St., Chicago 47, Ill. ADV. PG. 156.
- ⊙ **Rogers Corp.**, Manchester, Conn.
- ⊙ **Stevens Products, Inc.**, 86-88 Main St., East Orange, N. J.

INSULATORS—Strain

- ⊙ **AMERICAN LAVA CORP.**, Chattanooga 5, Tenn. ADV. PG. 143.
- ⊙ **Bendix Radio Division**, Bendix Aviation Corp., Baltimore 4, Md.
- ⊙ **Birnback Radio Co., Inc.**, 145 Hudson St., New York N. Y.
- ⊙ **Brandywine Fibre Co.**, 15th & Poplar Sts., Wilmington, Del.
- ⊙ **CENTRALAB DIV. OF GLOBE UNION, INC.**, 900 E. Keefe Ave., Milwaukee 1, Wis. ADV. PG. 85-88.
- ⊙ **CORNING GLASS WORKS**, Corning, N. Y. ADV. PG. 373.
- ⊙ **Flader, Inc.**, Fredric, 1330 Laskey Rd., Toledo 12, Ohio.
- ⊙ **GENERAL CERAMICS & STEATITE CORP.**, Keasbey, N. J. ADV. PG. 126, 127.
- ⊙ **HEYMAN MFG. CO.**, 300 Michigan Ave., Kenilworth, N. J. ADV. PG. 381.
- ⊙ **Illinois Electric Porcelain Co.**, Macomb, Ill.
- ⊙ **Industrial Devices, Inc.**, 22 State Rd., Edgewater, N. J.
- ⊙ **Insulation Mfg. Co.**, 11 New York Ave., Brooklyn, N. Y.
- ⊙ **Isolantite Mfg. Corp.**, Stirling, N. J.
- ⊙ **JOHNSON CO.**, E. F. Waseca, Minn. ADV. PG. 118, 121.
- ⊙ **Lapp Insulator Co., Inc.**, Radio Specialties Div., 31 Gilbert St., LeRoy, N. Y.
- ⊙ **Locke Incorporated**, P. O. Box 57, Baltimore 3, Md.
- ⊙ **Mykroy Inc.**, Arlington Heights Airport, Arlington Heights, Ill.
- ⊙ **National Ceramic Co.**, 400 Southard St., Trenton 2, N. J.
- ⊙ **NATIONAL CO., INC.**, 61 Sherman St., Malden 48, Mass. ADV. PG. 280, 281.
- ⊙ **Philco Corp.**, Tioga & C Sts., Philadelphia 34, Pa.
- ⊙ **Smith, Inc.**, Herman H., 436 18th St., Brooklyn 15, N. Y.
- ⊙ **Steward Mfg. Co.**, D. M., 3600 Jerome Ave., Chattanooga 1, Tenn.
- ⊙ **STUPAKOFF CERAMIC & MFG. CO.**, Latrobe, Pa. ADV. PG. 167.
- ⊙ **TECHNICAL APPLIANCE CORP.**, Sherburne, N. Y. ADV. PG. 378.
- ⊙ **THOR CERAMICS INC.**, 225 Belleville Ave., Bloomfield, N. J. ADV. PG. 378.
- ⊙ **WESTINGHOUSE ELECTRIC CORP.**, 511 Wood St., P. O. Box 868, Pittsburgh 30, Pa. ADV. PG. 107-113.

- ⊙ **Wind Turbine Co.**, Tower & Antenna Div., E. Market St. & Penna. R. R., West Chester, Pa.
- ⊙ **Wisconsin Porcelain Co.**, Sun Prairie, Wis.

INSULATORS—Test Clip

- ⊙ **AEROLITE ELECTRONIC HARDWARE CORP.**, 507 26th St., Union City, N. J. ADV. PG. 355.
- ⊙ **BELLING & LEE LTD.**, 366 Madison Ave., New York 17, N. Y. ADV. PG. 336.
- ⊙ **Birnback Radio Co., Inc.**, 145 Hudson St., New York, N. Y.
- ⊙ **GENERAL ACCESSORIES CO., LTD.**, 366 Madison Ave., New York 17, N. Y. ADV. PG. 336.
- ⊙ **Industrial Devices, Inc.**, 22 State Rd., Edgewater, N. J.
- ⊙ **Insuline Corp. of America** 36-02 35th Ave., Long Island City, N. Y.
- ⊙ **J.F.D. MFG. CO.**, 6101-23 Sixteenth Ave., Brooklyn, N. Y. ADV. PG. 407.
- ⊙ **Mueller Electric Co.**, 1583 E. 31st St., Cleveland 14, Ohio.
- ⊙ **Smith, Inc.**, Herman H., 436 18th St., Brooklyn 15, N. Y.

INSULATORS—Thermocouple

- ⊙ **AMERICAN LAVA CORP.**, Chattanooga 5, Tenn. ADV. PG. 143.
- Dallons Labs., 5066 Santa Monica Blvd., Los Angeles, Calif.
- ⊙ **Electrical Refractories Co.**, 50 Clark St., East Palestine, Ohio.
- ⊙ **Gordon Co.**, Claud S., 3000 S. Wallace St., Chicago 16, Ill.
- ⊙ **Isolantite Mfg. Corp.**, Stirling, N. J.
- ⊙ **Kirchberger & Co., Inc.**, M., 1425 37th St., Brooklyn 18, N. Y.
- ⊙ **Richards Co. Inc.**, Arlroy S., 78 Winchester St., Newton Highlands 61, Mass.
- ⊙ **Steward Mfg. Co.**, D. M., 3600 Jerome Ave., Chattanooga 1, Tenn.
- ⊙ **STUPAKOFF CERAMIC & MFG. CO.**, Latrobe, Pa. ADV. PG. 167.
- ⊙ **Tagliabue Div.**, Weston Electrical Instrument Corp., 614 Frelinghuysen Ave., Newark 5, N. J.
- ⊙ **THOR CERAMICS INC.**, 225 Belleville Ave., Bloomfield, N. J. ADV. PG. 378.
- ⊙ **Wheeler Instruments Co.**, 847 W. Harrison St., Chicago 7, Ill.

INSULATORS—Tower

- ⊙ **AMERICAN LAVA CORP.**, Chattanooga 5, Tenn. ADV. PG. 143.
- ⊙ **GENERAL CERAMICS & STEATITE CORP.**, Keasbey, N. J. ADV. PG. 126, 127.
- ⊙ **Lapp Insulator Co., Inc.**, Radio Specialties Div., 31 Gilbert St., LeRoy, N. Y.
- ⊙ **Locke Incorporated**, P. O. Box 57, Baltimore 3, Md.
- ⊙ **Mykroy, Inc.**, Arlington Heights Airport, Arlington Heights, Ill.
- ⊙ **TEFLON PRODUCTS DIVISION, U. S. GASKET CO.**, P. O. Box 93, Camden, N. J. ADV. PG. 176.
- ⊙ **THOR CERAMICS INC.**, 225 Belleville Ave., Bloomfield, N. J. ADV. PG. 378.
- ⊙ **Wind Turbine Co.**, Tower & Antenna Div., E. Market St. & Penna. R. R., West Chester, Pa.

INSULATORS—Transmitting Antenna

- ⊙ **AMERICAN LAVA CORP.**, Chattanooga 5, Tenn. ADV. PG. 143.
- ⊙ **Birnback Radio Co., Inc.**, 145 Hudson St., New York, N. Y.
- ⊙ **Bunnell & Co., J. H.**, 81 Prospect St., Brooklyn, N. Y.
- ⊙ **Flader, Inc.**, Fredric, 1330 Laskey Rd., Toledo 12, Ohio.
- ⊙ **GENERAL CERAMICS & STEATITE CORP.**, Keasbey, N. J. ADV. PG. 126, 127.
- ⊙ **Isolantite Mfg. Corp.**, Stirling, N. J.
- ⊙ **JOHNSON CO., E. F.**, Waseca, Minn. ADV. PG. 118, 121.
- ⊙ **Lapp Insulator Co., Inc.**, Radio Specialties Div., 31 Gilbert St., LeRoy, N. Y.
- ⊙ **Locke Incorporated**, P. O. Box 57, Baltimore 3, Md.
- ⊙ **Mykroy, Inc.**, Arlington Heights Airport, Arlington Heights, Ill.
- ⊙ **Premax Products Div.**, Chisholm-Ryder Co., Inc., Niagara Falls 2, N. Y.
- ⊙ **STUPAKOFF CERAMIC & MFG. CO.**, Latrobe, Pa. ADV. PG. 167.
- ⊙ **TEFLON PRODUCTS DIVISION, U. S. GASKET CO.**, P. O. Box 93, Camden, N. J. ADV. PG. 176.
- ⊙ **THOR CERAMICS INC.**, 225 Belleville Ave., Bloomfield, N. J. ADV. PG. 378.
- ⊙ **Wind Turbine Co.**, Tower & Antenna Div., E. Market St. & Penna. R. R., West Chester, Pa.

INTEGRATORS—Electronic

- ⊙ **AMERICAN ELECTRONIC CORP.**, 5025-29 W. Jefferson Blvd., Los Angeles 16, Calif. ADV. PG. 136.

- ⊙ **Arma Corp.**, 254 36th St., Brooklyn 32, N. Y.
- ⊙ **ATOMIC INSTRUMENT CO.**, 84 Massachusetts Ave., Cambridge 39, Mass. ADV. PG. 410.
- ⊙ **BOGUE ELECTRIC MFG. CO.**, 52 Iowa Ave., Paterson 3, N. J. ADV. PG. 155.
- ⊙ **Computer Corp. of America**, 149 Church St., New York, N. Y.
- ⊙ **Davies Laboratories, Inc.**, 4705 Queensbury Rd., Riverdale, Md.
- ⊙ **Hart Associates**, 8430 Grand River, Detroit 4, Mich.
- ⊙ **Hathaway Instrument Co.**, 1315 S. Clarkson St., Denver 10, Colo.
- ⊙ **INDUSTRIAL CONTROL CO.**, Straight Path & Arlington Ave., Wyandanch, N. Y. ADV. PG. 130.
- ⊙ **Instron Engineering Corp.**, 2 Hancock St., Quincy 71, Mass.
- ⊙ **Philbrick Researches, Inc.**, George A., 230 Congress St., Boston 10, Mass.
- ⊙ **SERVO-TEK PRODUCTS CO.**, 4 Godwin Ave., Paterson 1, N. J. ADV. PG. 356.
- ⊙ **Standard Electronics Research Corp.**, 2 East End Ave., New York 21, N. Y.
- ⊙ **WESTON ELECTRICAL INSTRUMENT CORP.**, 595 Frelinghuysen Ave., Newark 5, N. J. ADV. PG. 243.

INTERCOMMUNICATION SYSTEMS

- ⊙ **Aeronautical Electronics, Inc.**, Raleigh-Durham Airport, P. O. Box 6043, Raleigh, N. C.
- ⊙ **Airlectron, Inc.**, P. O. Box 151, Caldwell, N. J.
- ⊙ **Automatic Electric Sales Corp.**, 1033 W. Van Buren St., Chicago 7, Ill.
- ⊙ **Bell Sound Systems, Inc.**, 555 Marion Rd., Columbus 7, Ohio.
- ⊙ **Bogen Co., Inc.**, David, 663 Broadway, New York 12, N. Y.
- ⊙ **Boom Electric & Amplifier Co.**, 1227 W. Washington Blvd., Chicago 7, Ill.
- ⊙ **Brelco Electronics Corp.**, 55 Vandam St., New York 13, N. Y.
- ⊙ **Connecticut Telephone & Electric Corp.**, 70 Britannia St., Meriden, Conn.
- ⊙ **Cooper Electronic Products Co.**, 4500 Melrose St., Philadelphia 24, Pa.
- ⊙ **Cossor (Canada) Ltd.**, 301-303 Windsor St., Halifax, N. S., Canada.
- ⊙ **Dalmo Victor Co.**, 1414 El Camino Real, San Carlos, California.
- ⊙ **Edwards Co., Inc.**, 86 Boston Post Rd., Norwalk, Conn.
- ⊙ **Elm Laboratories**, 18 South Broadway, Dobbs Ferry, N. Y.
- ⊙ **Executone Inc.**, 415 Lexington Ave., New York 17, N. Y.
- ⊙ **Ferrari Radio & Television Corp.**, 55 W. 26th St., New York 10, N. Y.
- ⊙ **Godfrey Mfg. Co.**, 171 S. 2nd St., Milwaukee 4, Wis.
- ⊙ **Gray Mfg. Co.**, The, 16 Arbor St., Hartford, Conn.
- ⊙ **Hose-McCann Telephone Co., Inc.**, 25th St. & 3rd Ave., Brooklyn 32, N. Y.
- ⊙ **Intervox Corp.**, 2701 California Ave., Seattle 6, Wash.
- ⊙ **KELLOGG SWITCHBOARD & SUPPLY CO.**, 6650 S. Cicero Ave., Chicago 38, Ill. ADV. PG. 294.
- ⊙ **Lake Mfg. Co.**, 2323 Chestnut St., Oakland 7, Calif.
- ⊙ **Loge Sound Engineers, J. M.**, 2171 W. Washington Blvd., Los Angeles 7, Calif.
- ⊙ **Lyman Electronic Corp.**, 12 Cass St., Springfield, Mass.
- ⊙ **National Intercommunicating Systems**, 1130 N. Milwaukee Ave., Chicago 22, Ill.
- ⊙ **Newcomb Audio Products Co.**, 6824 Lexington Ave., Hollywood 38, Calif.
- ⊙ **Operadio Mfg. Co.**, 135th & Indiana Sts., St. Charles, Ill.
- ⊙ **POLARAD ELECTRONICS CORP.**, 100 Metropolitan Ave., Brooklyn 11, N. Y. ADV. PG. 184, 185.
- ⊙ **RADIO CORP. OF AMERICA**, RCA Victor Div., General Offices, Camden, N. J. ADV. PG. 177, Inside Back & Back Covers.
- ⊙ **Rauland-Borg Corp.**, 3523 W. Addison St., Chicago 18, Ill.
- ⊙ **Remler Co., Ltd.**, 2101 Bryant St., San Francisco 10, Calif.
- ⊙ **Simpson Mfg. Co., Inc.**, Mark, 32-28 49th St., Long Island City 3, N. Y.
- ⊙ **Standard Telephones & Cables Ltd.**, Connaught House, Aldwych, London, W. C. 2, England.
- ⊙ **Talk-A-Phone Mfg. Co.**, 1512 S. Pulaski Rd., Chicago 23, Ill.
- ⊙ **Telephonics Corp.**, Park Ave., Huntington, N. Y.
- ⊙ **TRAD TELEVISION CORP.**, 1001 First Ave., Asbury Park, N. J. ADV. PG. 355.
- ⊙ **U. S. Instrument Corp.**, 409 Broad St., Summit, N. J.
- ⊙ **Webster Electric Co.**, 1900 Clark St., Racine, Wis.
- ⊙ **Western Sound & Electric Labs., Inc.**, 805 S. 5th St., Milwaukee 4, Wis.
- ⊙ **Wheeler Insulated Wire Co., Inc.**, 150 E. Aurora St., Waterbury 91, Conn.

INVERTERS

- ⊙ **AIRPAX PRODUCTS CO.**, Middle River, Baltimore 20, Md. ADV. PG. 289.
- ⊙ **AMERICAN TELEVISION & RADIO CO.**, 300 E. Fourth St., St. Paul 1, Minn. ADV. PG. 266.
- ⊙ **Continental Electric Co., Inc.**, 334 Ferry St., Newark 5, N. J.

V indicates . . . IN PRODUCTION • AVAILABILITY • UNRESTRICTED FOR GENERAL USE

- Ⓞ Cook Electric Co., 2700 Southport Ave., Chicago 14, Ill.
- Ⓞ CORNELL-DUBILIER ELECTRIC CORP., South Plainfield, N. J. ADV. PG. 146.
- Ⓞ Doelcam Corp., 56 Elmwood Ave., Newton 58, Mass.
- Ⓞ ECLIPSE-PIONEER DIV., BENDIX AVIATION CORP., Teterboro, N. J. ADV. PG. 198, 199.
- Ⓞ Edwards Co., Inc., 86 Boston Post Rd., Norwalk, Conn.
- Ⓞ Eicor, Inc., 1501 W. Congress St., Chicago 7, Ill.
- Ⓞ Electronic Specialty Co., 3456 Glendale Blvd., Los Angeles 39, Calif.
- Ⓞ GENERAL ELECTRIC CO., Schenectady 5, N. Y. ADV. PG. 1 to 22.
- Ⓞ Holtzer-Cabot Div. of National Pneumatic Co., 130 Amory St., Boston 19, Mass.
- Ⓞ Lear, Inc., 110 Ionia Ave., N. W., Grand Rapids 2, Mich.
- Ⓞ Leland Electric Co., The, 1501 Webster St., Dayton 1, Ohio.
- Ⓞ NORRMAN LABORATORIES, ERNST, Williams Bay, Wis. ADV. PG. 346.
- Ⓞ ORTHON CORP., 196 Albion Ave., Paterson 2, N. J. ADV. PG. 156.
- Ⓞ Rangertone, Inc., 73 Winthrop St., Newark 4, N. J.
- Ⓞ RED BANK DIVISION, BENDIX AVIATION CORP., Red Bank, N. J. ADV. PG. 197.
- Ⓞ SORENSEN & CO., INC., 375 Fairfield Ave., Stamford, Conn. ADV. PG. 66, 67.
- Ⓞ Standard Telephones & Cables Ltd., Connaught House, Aldwych, London, W. C. 2, England.
- Ⓞ Varo Mfg. Co., Inc., Box 638, Garland, Texas.
- Ⓞ Weltronic Co., 19500 W. Eight Mile Rd., Detroit 9, Mich.
- Ⓞ WESTINGHOUSE ELECTRIC CORP., 511 Wood St., P. O. Box 868, Pittsburgh 30, Pa. ADV. PG. 107-113.

ION TRAPS

- Ⓞ CLAROSTAT MFG. CO., INC., Dover, N. H. ADV. PG. 100, 101.
- Ⓞ Cossor (Canada), Ltd., 30-303 Windsor St., Halifax, N. S., Canada.
- Ⓞ DX Radio Products Co., Inc., 2304 Armitage Ave., Chicago 47, Ill.
- Ⓞ ELECTRO ACOUSTIC INDUSTRIES LTD., 366 Madison Ave., New York 17, N. Y. ADV. PG. 336.
- Ⓞ GLASER-STEERS CORP., 2 Main St., Belleville 9, N. J. ADV. PG. 359.
- Ⓞ HEPPNER MFG. CO., P. O. Box 612, Round Lake, Ill. ADV. PG. 413.
- Ⓞ INDIANA STEEL PRODUCTS CO., Valparaiso, Indiana. ADV. PG. 154.
- Ⓞ PERFECTION ELECTRIC CO., 2635 S. Wabash Ave., Chicago 16, Ill. ADV. PG. 102, 142, 256, 405.
- Ⓞ Philco Corp., Tioga & C Sts., Philadelphia 34, Pa.
- Ⓞ Quam Nichols Co., 526 E. 33rd Place, Chicago 16, Ill.
- Ⓞ Teleradio Engineering Corp., 99 Wall St., New York 5, N. Y.

IRONS—Electric Soldering

- Ⓞ Acme Electric Heating Co., 1217 Washington St., Boston, Mass.
- Ⓞ American Electrical Heater Co., 6110 Cass Ave., Detroit 2, Mich.
- Ⓞ Drake Electric Works, 3656 Lincoln Ave., Chicago 13, Ill.
- Ⓞ ELECTRIC SOLDERING IRON CO., W. Elm St., Deep River, Conn. ADV. PG. 68.
- Ⓞ GENERAL ELECTRIC CO., Schenectady 5, N. Y. ADV. PG. 1 to 22.
- Ⓞ Hexacon Electric Company, 130 W. Clay Ave., Roselle Park, N. J.
- Ⓞ KELLOGG SWITCHBOARD & SUPPLY CO., 6650 S. Cicero Ave., Chicago 38, Ill. ADV. PG. 294.
- Ⓞ Kelnor Mfg. Co., 215 Kearny St., San Francisco 8, Calif.
- Ⓞ Kemode Mfg. Co., 161 W. 18th St., New York 11, N. Y.
- Ⓞ Kwikheaf Mfg. Co., 3722 San Fernando Road, Glendale 4, Calif.
- Ⓞ Lenk Mfg. Co., 30 Cummington St., Boston 15, Mass.
- Ⓞ MITCHELL INDUSTRIES, INC., Camp Wolters, Mineral Wells, Texas. ADV. PG. 298.
- Ⓞ Multi-Products Tool Co., 123 Sussex Ave., Newark 4, N. J.
- Ⓞ Philco Corp., Tioga & C Sts., Philadelphia 34, Pa.
- Ⓞ Radiocrafters, 1156 Commonwealth Ave., Boston 34, Mass.
- Ⓞ Standard Telephones & Cables Ltd., Connaught House, Aldwych, London, W. C. 2, England.
- Ⓞ Stanley Tools Div., Stanley Works, Elm St., New Britain, Conn.
- Ⓞ Ungar Electric Tools, Inc., 615 Ducommun St., Los Angeles 54, Calif.
- Ⓞ VULCAN ELECTRIC CO., 88 Holten St., Danvers, Mass. ADV. PG. 50.
- Ⓞ Weller Electric Corp., 846 Packer St., Easton, Pa.

IRONS SOLDERING—Holders

- Ⓞ WILDER MFG. CO., INC., 411 Lexington Ave., Brooklyn 16, N. Y. ADV. PG. 264.

ISOTOPES—Radioactive

- Ⓞ ATOMIC INSTRUMENT CO., 84 Massachusetts Ave., Cambridge 39, Mass. ADV. PG. 410.
- Ⓞ Nuclear Instrument & Chemical Corp., 223 W. Erie St., Chicago 10, Ill.
- Ⓞ Nuclear Research Corp., 2707 Federal St., Philadelphia 46, Pa.
- Ⓞ Radioactive Products, Inc., 443 W. Congress St., Detroit 26, Mich.
- Ⓞ St. John X-Ray Laboratory, Califon, N. J.
- Ⓞ Special Instruments Laboratories, Inc., 1003 Highland Ave., Knoxville, Tenn.
- Ⓞ Technical Associates, 3730 San Fernando Rd., Glendale 4, Calif.
- Ⓞ Tracerlab, Inc., 130 High St., Boston 10, Mass.
- Ⓞ U. S. Radium Corp., 535 Pearl St., New York 7, N. Y.

JACKS

See Plugs and Jacks

JEWELS—Glass

- Ⓞ BIRD CO., RICHARD H., 1 Spruce St., Waltham, Mass. ADV. PG. 60.
- Ⓞ Drake Mfg. Co., 1713 Hubbard St., Chicago 22, Ill.
- Ⓞ General Cement Mfg. Co., 919 Taylor Ave., Rockford, Ill.
- Ⓞ Kopp Glass, Inc., 1 E. 42nd St., New York 17, N. Y.
- Ⓞ Smith, Inc., Herman H., 436 18th St., Brooklyn 15, N. Y.

JUMPERS—Bonding

- Ⓞ Hallett Mfg. Co., 1601 Florence Ave., Inglewood, Calif.
- Ⓞ KULKA ELECTRIC MFG. CO., INC., 30 South St., Mount Vernon, N. Y. ADV. PG. 317.
- Ⓞ Star Measurements Co., 442 E. 166th St., New York 56, N. Y.
- Ⓞ Thomas & Betts Co., Inc., 40 Butler St., Elizabeth 1, N. J.
- Ⓞ Whitaker Cable Corp., Kansas City 16, Mo.

KEYERS & COUPLERS

- Ⓞ Bunnell & Co., J. H., 81 Prospect St., Brooklyn, N. Y.
- Ⓞ ELECTRONIC MEASUREMENTS COMPANY, Red Bank, N. J. ADV. PG. 312.
- Ⓞ Erco Radio Labs, Inc., E. Stewart Ave., Garden City, N. Y.
- Ⓞ Gates Radio Co., Quincy, Ill.
- Ⓞ McElroy Mfg. Corp., Littleton, Mass.
- Ⓞ NORTHERN RADIO CO., INC., 143-145 W. 22nd St., New York 11, N. Y. ADV. PG. 262, 263.
- Ⓞ Press Wireless Mfg. Co., Inc., Cantigue Rd., Hicksville, N. Y.
- Ⓞ Technical Materiel Corp., P. O. Box 142, 121 Spencer Place, Mamaroneck, N. Y.
- Ⓞ TRAD TELEVISION CORP., 1001 First Ave., Asbury Park, N. J. ADV. PG. 355.
- Ⓞ Ultradyne Electronics, Oswego, Oregon.

KEYS & CODING EQUIPMENT

- Ⓞ Aeronautical Communications Equipment, Inc., 3090 Douglas Rd., Miami 33, Fla.
- Ⓞ ALDEN PRODUCTS CO., 117 No. Main St., Brockton 64, Mass. ADV. PG. 327.
- Ⓞ Boehme Inc., H. O., 915 Broadway, New York 10, N. Y.
- Ⓞ Breloc Electronics Corp., 55 Vandam St., New York 13, N. Y.
- Ⓞ Bunnell & Co., J. H., 81 Prospect St., Brooklyn, N. Y.
- Ⓞ Edwards Co., Inc., 86 Boston Post Rd., Norwalk, Conn.
- Ⓞ Hose-McCann Telephone Co., Inc., 25th St. and 3rd Ave., Brooklyn 32, N. Y.
- Ⓞ JOHNSON CO., E. F., Waseca, Minn. ADV. PG. 118, 121.
- Ⓞ McElroy Mfg. Corp., Littleton, Mass.
- Ⓞ Telephonics Corp., Park Ave., Huntington, N. Y.
- Ⓞ Vibroplex Co., Inc., 833 Broadway, New York, N. Y.
- Ⓞ Winslow Co., Inc., 9 Liberty St., Newark 5, N. J.

KILOVOLT METERS

- Ⓞ BETA ELECTRIC CORP., 333 E. 103rd St., New York 29, N. Y. ADV. PG. 399.
- Ⓞ Brujac Electronic Corp., 103 Lafayette St., New York 13, N. Y.
- Ⓞ ELECTRONIC INSTRUMENT CO., INC., 276 Newport St., Brooklyn 12, N. Y. ADV. PG. 129.
- Ⓞ Esterline-Angus Co., Inc., P. O. Box 596, Indianapolis 6, Ind.
- Ⓞ FERRANTI ELECTRIC, INC., 30 Rockefeller Plaza, New York 20, N. Y. ADV. PG. 159.
- Ⓞ GENERAL ELECTRIC CO., Schenectady 5, N. Y. ADV. PG. 1 to 22.
- Ⓞ Industrial Devices, Inc., 22 State Rd., Edgewater, N. J.

- Ⓞ Manufacturers Engr. & Equip. Corp., Willow Grove, Pa.
- Ⓞ MARION ELECTRICAL INSTRUMENT CO., Manchester, N. H. ADV. PG. 200.
- Ⓞ Meters, Inc., 915 Westfield Blvd., Indianapolis 20, Ind.
- Ⓞ Oak Ridge Products Mfg. Div. of Video Television, Inc., 37-01 Vernon Blvd., Long Island City 1, N. Y.
- Ⓞ PRECISE MEASUREMENTS CO., 942 Kings Highway, Brooklyn 23, N. Y. ADV. PG. 401.
- Ⓞ Rawson Electrical Instrument Co., 111 Potter St., Cambridge 42, Mass.
- Ⓞ Sensitive Research Instrument Corp., 9 Elm Ave., Mt. Vernon, N. Y.
- Ⓞ SHALLCROSS MFG. CO., 10 Jackson Ave., Collingdale, Pa. ADV. PG. 261.
- Ⓞ Star Measurements Co., 442 E. 166th St., New York 56, N. Y.
- Ⓞ SYLVANIA ELECTRIC PRODUCTS, INC., 1740 Broadway, New York 19, N. Y. ADV. PG. 432-436.
- Ⓞ Welch Scientific Co., W. M., 1515 Sedgwick St., Chicago 10, Ill.
- Ⓞ WESTINGHOUSE ELECTRIC CORP., 511 Wood St., P. O. Box 868, Pittsburgh 30, Pa. ADV. PG. 107-113.

KLYSTRON

See Tubes

KNOBBS—Plastic Molded

- Ⓞ ALDEN PRODUCTS CO., 117 No. Main St., Brockton 64, Mass. ADV. PG. 327.
- Ⓞ American Insulator Corp., New Freedom, Pa.
- Ⓞ AMERICAN MOLDED PRODUCTS CO., 1644 N. Honore St., Chicago 22, Ill. ADV. PG. 382.
- Ⓞ Catalin Corp., of America, 1 Park Ave., New York 16, N. Y.
- Ⓞ Chicago Die Mold Mfg. Co., 4001 Wrightwood Ave., Chicago 39, Ill.
- Ⓞ Consolidated Molded Products Corp., Scranton 2, Pa.
- Ⓞ DAVEN CO., 191 Central Ave., Newark 4, N. J. ADV. PG. 157.
- Ⓞ Davies Molding Co., Harry, 1428 N. Wells St., Chicago 10, Ill.
- Ⓞ Dimco-Gray Co., 207 E. Sixth St., Dayton, Ohio.
- Ⓞ EBV, INC., HUGH H., 4700 Stenton Ave., Philadelphia 44, Pa. ADV. PG. 214.
- Ⓞ EMELOID CO., INC., THE, 1239 Central Ave., Hillside 5, N. J. ADV. PG. 102.
- Ⓞ ERIE RESISTOR CORP., 644 W. 12th St., Erie, Pa. ADV. PG. 91.
- Ⓞ General Cement Mfg. Co., 919 Taylor Ave., Rockford, Ill.
- Ⓞ GENERAL RADIO CO., 275 Massachusetts Ave., Cambridge 39, Mass. ADV. PG. 48, 49.
- Ⓞ Gits Molding Corp., 4600 W. Huron St., Chicago 44, Ill.
- Ⓞ Insulation Mfg. Co., 11 New York Ave., Brooklyn, N. Y.
- Ⓞ Insuline Corp. of America, 36-02 35th Ave., Long Island City, N. Y.
- Ⓞ J F D MFG. CO., 6101-23 Sixteenth Ave., Brooklyn, N. Y. ADV. PG. 407.
- Ⓞ JOHNSON CO., E. F., Waseca, Minn. ADV. PG. 118, 121.
- Ⓞ Kurz-Kasch, Inc., 1415 S. Broadway, Dayton 1, Ohio.
- Ⓞ Millen Mfg. Co., James, 150 Exchange St., Malden, Mass.
- Ⓞ Molded Insulation Co., 335 E. Price St., Philadelphia 44, Pa.
- Ⓞ NATIONAL CO., INC., 61 Sherman St., Malden 48, Mass. ADV. PG. 280, 281.
- Ⓞ NEO-SIL CORP., 26 Cornelison Ave., Jersey City 4, N. J. ADV. PG. 253.
- Ⓞ PAINTON & CO., INC., LTD., 366 Madison Ave., New York 17, N. Y. ADV. PG. 336.
- Ⓞ PATENT BUTTON CO. OF TENNESSEE, 2005 Century St., Knoxville, Tenn. ADV. PG. 242.
- Ⓞ Philco Corp., Tioga & C Sts., Philadelphia 34, Pa.
- Ⓞ Plastimold Corp., Attleboro, Mass.
- Ⓞ RICHARDSON CO., THE, 2767 Lake St., Melrose Park, Ill. ADV. PG. 310.
- Ⓞ ROGAN BROS., 2500 W. Irving Pk., Chicago 18, Ill. ADV. PG. 264.
- Ⓞ ROHDEN MANUFACTURING COMPANY, 4739 Montrose Ave., Chicago 41, Ill. ADV. PG. 406.
- Ⓞ SHALLCROSS MFG. CO., 10 Jackson Ave., Collingdale, Pa. ADV. PG. 261.
- Ⓞ SYLVANIA ELECTRIC PRODUCTS, INC., 1740 Broadway, New York 19, N. Y. ADV. PG. 432-436.
- Ⓞ Technology Instrument Corp., 531 Main St., Acton, Mass.
- Ⓞ Winslow Co., Inc., 9 Liberty St., Newark 5, N. J.

LABORATORIES, TESTING

- Armour Research Foundation, 35 W. 33rd St., Chicago, Ill.
- Ⓞ Cook Research Labs., Div. Cook Electric Co., 1457 Diversey Parkway, Chicago 14, Ill.
- Ⓞ Electrical Testing Laboratories, East End Ave. & 79th St., New York, N. Y.
- Ⓞ Inland Testing Labs., Div. Cook Electric Co., 2700 Southport, Chicago 14, Ill.
- Ⓞ New York Testing Laboratories, Inc., 80 Washington St., New York 6, N. Y.

V indicates . . . IN PRODUCTION • AVAILABILITY • UNRESTRICTED FOR GENERAL USE

Tour & Co., Inc., Sam, 44 Trinity Place, New York, N. Y.
 UNITED STATES TESTING CO., INC., 1550 Park Ave., Hoboken, N. J. ADV. PG. 400.

LACQUER
 See Insulating Compounds

LAMINATIONS—Transformer

ABALON PRECISION MFG. CORP., 540 Casanova St., Bronx 59, N. Y. ADV. PG. 348.
 Brandywine Fibre Co., 15th & Poplar Sts., Wilmington, Del.
 Delco Radio Div., General Motors Corp., Kokomo, Ind.
 Eastern Specialty Co., Philadelphia 40, Pa.
 KELLER PRODUCTS CO., 41 Union St., Manchester, N. H. ADV. PG. 397.
 KOBZY TOOL CO., 1535 N. Dayton Ave., Chicago 22, Ill. ADV. PG. 343.
 Magnetic Metals Co., Hayes Ave. at 21st St., Camden, N. J.
 Masonite Corp., 111 W. Washington St., Chicago 2, Ill.
 PIX MFG. CO., INC., 24 Bedford St., Newark, N. J. ADV. PG. 136.
 Repath Co., Paul R., 641 E. 61st St., Los Angeles 1, Calif.
 Super Electric Products Corp., 46 Oliver St., Newark, N. J.
 THOMAS & SKINNER STEEL PRODUCTS CO., 1122 E. 23rd St., Indianapolis, Ind. ADV. PG. 403.
 Webster-Chicago Corp., 5622 Bloomingdale Ave., Chicago 39, Ill.
 WESTINGHOUSE ELECTRIC CORP., 511 Wood St., P. O. Box 868, Pittsburgh 30, Pa. ADV. PG. 107-113.

LANDING SYSTEMS—Microwave

AIR ASSOCIATES, INC., Teterboro, N. J. ADV. PG. 211.
 Bendix Radio Division, Bendix Aviation Corp., Baltimore 4, Md.
 SPERRY GYROSCOPE CO., Div. of the Sperry Corp., Great Neck, N. Y. ADV. PG. 103, 104.
 Standard Telephones & Cables Ltd., Connaught House, Aldwych, London, W. C. 2, England.

LEADS—Test

AEROLITE ELECTRONIC HARDWARE CORP., 507 26th St., Union City, N. J. ADV. PG. 355.
 Associated Research, Inc., 3758 W. Belmont, Chicago 18, Ill.
 BELLING & LEE LTD., 366 Madison Ave., New York 17, N. Y. ADV. PG. 336.
 Birnback Radio Co., Inc., 145 Hudson St., New York, N. Y.
 Bud Radio, Inc., 2118 E. 55th St., Cleveland 3, Ohio.
 Caltron Co., 1406 S. Hobart Blvd., Los Angeles 6, Calif.
 CITATION PRODUCTS CO., 233 E. 146th St., New York 51, N. Y. ADV. PG. 388.
 Corsor (Canada) Ltd., 301-303 Windsor St., Halifax, N. S., Canada.
 ELECTRONIC INSTRUMENT CO., INC., 276 Newport St., Brooklyn 12, N. Y. ADV. PG. 129.
 Feller Engineering Co., 8026 Monticello Ave., Skokie, Ill.
 Gadgets, Inc., 3629 N. Dixie Drive, Dayton 4, Ohio.
 GENERAL ACCESSORIES CO., LTD., 366 Madison Ave., New York 17, N. Y. ADV. PG. 336.
 General Cement Mfg. Co., 919 Taylor Ave., Rockford, Ill.
 Industrial Devices, Inc., 22 State Rd., Edgewater, N. J.
 Insuline Corp. of America, 36-02 35th Ave., Long Island City, N. Y.
 J F D MFG. CO., 6101-23 Sixteenth Ave., Brooklyn, N. Y. ADV. PG. 407.
 Keystone Electronics Corp., 423 Broome St., New York 12, N. Y.
 Network Mfg. Corp., Bayonne, N. J.
 Philco Corp., Tioga & C Sts., Philadelphia 34, Pa.
 Precision Apparatus Co., Inc., 92-27 Horace Harding Blvd., Elmhurst, N. Y.
 Simpson Electric Co., Div. of America Gage & Machine Co., 5218 W. Kinzie St., Chicago 44, Ill.
 Smith, Inc., Herman H., 436 18th St., Brooklyn 15, N. Y.
 Star Measurements Co., 442 E. 166th St., New York 56, N. Y.
 Supreme, Inc., Greenwood, Miss.
 Winslow Co., Inc., 9 Liberty St., Newark 5, N. J.

LEATHERETTE

General Cement Mfg. Co., 919 Taylor Ave., Rockford, Ill.
 U. S. Rubber Co., 1230 Avenue of the Americas, New York 20, N. Y.

LENSES—Television

Bache & Co., Semon, 636 Greenwich St., New York 14, N. Y.

Camera Equipment Co., 1600 Broadway, New York 19, N. Y.
 Eastman Kodak Co., Industrial Photographic Div., 343 State St., Rochester 4, N. Y.
 GENERAL PRECISION LAB., INC., Pleasantville, N. Y. ADV. PG. 58, 59.
 TRAD TELEVISION CORP., 1001 First Ave., Asbury Park, N. J. ADV. PG. 355.

LENSES—Television Magnifying

Bache & Co., Semon, 636 Greenwich St., New York 14, N. Y.
 Electrovox Co., Inc., 60 Franklin St., East Orange, N. J.
 Molded Insulation Co., 335 E. Price St., Philadelphia 44, Pa.
 TRAD TELEVISION CORP., 1001 First Ave., Asbury Park, N. J. ADV. PG. 355.

LENSES—Television Projection

Bache & Co., Semon, 636 Greenwich St., New York 14, N. Y.
 Bausch & Lomb Optical Co., 635 St. Paul St., Rochester 2, N. Y.
 Philco Corp., Tioga & C Sts., Philadelphia 34, Pa.
 SPELLMAN TELEVISION CO., INC., 3029 Webster Ave., New York 67, N. Y. ADV. PG. 277.
 TRAD TELEVISION CORP., 1001 First Ave., Asbury Park, N. J. ADV. PG. 355.

LIE DETECTORS—Electronic

Associated Research, Inc., 3758 W. Belmont, Chicago 18, Ill.
 Maico Co., Inc., 21 N. 3rd St., Minneapolis, Minn.
 Process & Instruments, 60 Greenpoint Ave., Brooklyn 22, N. Y.

LIGHTNING ARRESTORS

See Arrestors

LIGHTS—Dial and Panel

AEROLITE ELECTRONIC HARDWARE CORP., 507 26th St., Union City, N. J. ADV. PG. 355.
 ALDEN PRODUCTS CO., 117 No. Main St., Brockton 64, Mass. ADV. PG. 327.
 AMERICAN ELECTRONICS CORP., 157 Marconi Blvd., Columbus, Ohio. ADV. PG. 418.
 DIAL LIGHT CO. OF AMERICA, INC., 900 Broadway, New York 3, N. Y. ADV. PG. 60.
 Drake Mfg. Co., 1713 Hubbard St., Chicago 22, Ill.
 Edwards Co., Inc., 86 Boston Post Rd., Norwalk, Conn.
 FEDERAL SCREW PRODUCTS, INC., 224 W. Huron St., Chicago 10, Ill. ADV. PG. 76.
 Fosterla Pressed Steel Corp., Fostoria, Ohio.
 FRANKLIN AIRLOOP CORP., 43-20 34th St., Long Island City, N. Y. ADV. PG. 45.
 FRANKLIN MFG. CORP., A. W., 43-20 34th St., Long Island City, N. Y. ADV. PG. 44.
 GENERAL ACCESSORIES CO., LTD., 366 Madison Ave., New York 17, N. Y. ADV. PG. 336.
 General Cement Mfg. Co., 919 Taylor Ave., Rockford, Ill.
 GENERAL ELECTRIC CO., Lamp Dept., Nela Park, Cleveland 12, Ohio. ADV. PG. 1 to 22.
 Industrial Devices, Inc., 22 State Rd., Edgewater, N. J.
 JOHNSON CO., E. F., Waseca, Minn. ADV. PG. 118, 121.
 Kirkland Co., H. R., 8 King St., Morristown, N. J.
 Marco Industries, 210 S. Clementine Anaheim, Calif.
 Morse Co., Frank W., 1300 Soldiers Field Rd., Boston 35, Mass.
 NATIONAL UNION RADIO CORP., 350 Scotland Rd., Orange, N. J. ADV. PG. 296.
 Philco Corp., Tioga & C Sts., Philadelphia 34, Pa.
 RADIO CORP. OF AMERICA, Tube Dept., Harrison, N. J. ADV. PG. 177, Inside Back and Back Covers.
 RUSSELL & STOLL CO., INC. 125 Barclay St., New York 7, N. Y. ADV. PG. 337.
 Smith, Inc., Herman H., 436 18th St., Brooklyn, 15, N. Y.
 SYLVANIA ELECTRIC PRODUCTS, INC., 1740 Broadway, New York 19, N. Y. ADV. PG. 432 to 436.
 TUNG-SOL LAMP WORKS, INC., 95 Eighth Ave., Newark 4, N. J. ADV. PG. 169.
 Ucinite Co., Division, United-Carr Fastener Corp., 459 Watertown St., Newtonville, Mass.
 United-Carr Fastener Corp., Cambridge 42, Mass.
 WESTINGHOUSE ELECTRIC CORP., 511 Wood St., P. O. Box 868, Pittsburgh 30, Pa. ADV. PG. 107-113.

LIGHTS—Photoelectric Source

Berkshire Laboratories, 580 Lexington Rd., Concord, Mass.
 De-Tec-Tronic Laboratories, Inc., 1711 Terra Cotta Pl., Chicago 14, Ill.
 Electronic Control Corp., 1573 E. Forest St., Detroit, Mich.

GENERAL ELECTRIC CO., Lamp Dept., Nela Park, Cleveland 12, Ohio. ADV. PG. 1 to 22.
 GENERAL ELECTRIC CO., Schenectady 5, N. Y. ADV. PG. 1 to 22.
 Hoffman Engineering Corp. Anoka, Minn.
 Lumenite Electric Co., 407 So. Dearborn St., Chicago 5, Ill.
 Philco Corp., Tioga & C Sts., Philadelphia 34, Pa.
 Photobell Company, 116 Nassau St., New York 7, N. Y.
 Photoswitch, Inc., 77 Broadway, Cambridge 42, Mass.
 WESTHOUSE ELECTRIC CORP., 511 Wood St., P. O. Box 868, Pittsburgh 30, Pa. ADV. PG. 107-113.
 Wornor Electronic Devices, Rankin, Ill.

LIGHTS—Pilot

AEROLITE ELECTRONIC HARDWARE CORP., 507 26th St., Union City, N. J. ADV. PG. 355.
 ALDEN PRODUCTS CO., 117 No. Main St., Brockton 64, Mass. ADV. PG. 327.
 Cannon Electric Development Co., 3209 Humboldt St., Los Angeles 31, Calif.
 Carling Electric, Inc., 505 New Park Ave., West Hartford 10, Conn.
 DIAL LIGHT CO. OF AMERICA, INC., 900 Broadway, New York 3, N. Y. ADV. PG. 60.
 Drake Mfg. Co., 1713 Hubbard St., Chicago 22, Ill.
 Edwards Co., Inc., 86 Boston Post Rd., Norwalk, Conn.
 FEDERAL SCREW PRODUCTS INC., 224 W. Huron St., Chicago 10, Ill. ADV. PG. 76.
 FRANKLIN AIRLOOP CORP., 43-20 34th St., Long Island City, N. Y. ADV. PG. 45.
 FRANKLIN MFG. CORP., A. W., 43-20 34th St., Long Island City, N. Y. ADV. PG. 44.
 GENERAL ELECTRIC CO., Lamp Dept., Nela Park, Cleveland 12, Ohio. ADV. PG. 1 to 22.
 Herzog Miniature Lamp Works, Inc., 12-23 Jackson Ave., Long Island City 1, N. Y.
 Industrial Devices Inc., 22 State Rd., Edgewater, N. J.
 JOHNSON CO., E. F., Waseca, Minn. ADV. PG. 118, 121.
 Kirkland Co., H. R., 8 King St., Morristown, N. J.
 Marco Industries Co., 210 So. Clementine, Anaheim, Calif.
 NATIONAL CARBON CO., Division of Union Carbide & Carbon Corp., 30 E. 42nd St., New York 17, N. Y. ADV. PG. 42.
 NATIONAL UNION RADIO CORP., 350 Scotland Rd., Orange, N. J. ADV. PG. 296.
 North American Electric Lamp Co., 1014 Tyler St., St. Louis 6, Mo.
 Philco Corp., Tioga & C Sts., Philadelphia 34, Pa.
 RUSSELL & STOLL CO., INC., 125 Barclay St., New York 7, N. Y. ADV. PG. 337.
 Smith, Inc., Herman H., 436 18th St., Brooklyn 15, N. Y.
 TUNG-SOL LAMP WORKS, INC., 95 Eighth Ave., Newark 4, N. J. ADV. PG. 169.
 Ucinite Co. Division, United-Carr Fastener Corp., 459 Watertown St., Newtonville, Mass.
 United-Carr Fastener Corp., Cambridge 42, Mass.
 WESTINGHOUSE ELECTRIC CORP., 511 Wood St., P. O. Box 868, Pittsburgh 30, Pa. ADV. PG. 107-113.

LIGHTS—Signal

AEROLITE ELECTRONIC HARDWARE CORP., 507 26th St., Union City, N. J. ADV. PG. 355.
 Aerolux Light Corp., 653 11th Ave., New York 19, N. Y.
 AIR ASSOCIATES, INC., Teterboro, N. J. ADV. PG. 211.
 Amglo Corp., 4234 Lincoln Ave., Chicago 18, Ill.
 Cannon Electric Development Co., 3209 Humboldt St., Los Angeles 31, Calif.
 DIAL LIGHT CO. OF AMERICA, INC., 900 Broadway, New York 3, N. Y. ADV. PG. 60.
 Drake Mfg. Co., 1713 Hubbard St., Chicago, 22, Ill.
 Edwards Co., Inc., 86 Boston Post Rd., Norwalk, Conn.
 FEDERAL SCREW PRODUCTS, INC., 224 W. Huron St., Chicago 10, Ill. ADV. PG. 76
 GENERAL ELECTRIC, Lamp Dept., Nela Park, Cleveland 12, Ohio. ADV. PG. 1 to 22.
 Industrial Devices, Inc., 22 State Rd., Edgewater, N. J.
 JOHNSON CO., E. F., Waseca, Minn. ADV. PG. 118, 121.
 Kirkland Co., H. R., 8 King St., Morristown, N. J.
 Marco Industries Co., 210 So. Clementine, Anaheim, Calif.
 North American Electric Lamp Co., 1014 Tyler St., St. Louis 6, Mo.
 TUNG-SOL LAMP WORKS INC., 95 Eighth Ave., Newark 4, N. J. ADV. PG. 169.
 Western Union Telegraph Co., 60 Hudson St., New York 13, N. Y.
 WESTINGHOUSE ELECTRIC CORP., 511 Wood St., P. O. Box 868, Pittsburgh 30, Pa. ADV. PG. 107-113.

LIGHTS—Stroboscopic Source

Aerolux Light Corp., 653 11th Ave., New York 19, N. Y.

V indicates . . . IN PRODUCTION • AVAILABILITY • UNRESTRICTED FOR GENERAL USE

- Ⓞ Amglo Corp., 4234 Lincoln Ave., Chicago 18, Ill.
- Ⓞ Berkshire Laboratories, 580 Lexington Rd., Concord, Mass.
- Ⓞ Cossor (Canada) Ltd., 301-303 Windsor St., Halifax, N. S., Canada.
- Ⓞ Edgerton, Germeshausen & Grier, Inc., 160 Brookline Ave., Boston, Mass.
- Ⓞ ELECTRONIC MEASUREMENTS COMPANY, Red Bank, N. J. ADV. PG. 312
- Ⓞ GENERAL RADIO CO., 275 Massachusetts Ave., Cambridge 39, Mass. ADV. PG. 48, 49.
- Ⓞ Huggins Laboratories, 734 Hamilton Ave., Menlo Park, Calif.
- Ⓞ Kemlite Labs., 1819 W. Grand Ave., Chicago 22, Ill.
- Ⓞ Ripley Co., Inc., Middletown, Conn.
- Ⓞ SYLVANIA ELECTRIC PRODUCTS, INC., 1740 Broadway, New York 19, N. Y. ADV. PG. 432-436.
- Ⓞ WESTINGHOUSE ELECTRIC CORP., 511 Wood St., P. O. Box 868, Pittsburgh 30, Pa. ADV. PG. 107, 113.

LINES—Slotted

- Ⓞ FEDERAL TELECOMMUNICATION LABS., 500 Washington Ave., Nutley 10, N. J. ADV. PG. 164.
- Ⓞ Ferris Instrument Co., 110 Cornelia St., Boonton, N. J.
- Ⓞ GENERAL RADIO CO., 275 Massachusetts Ave., Cambridge 39, Mass. ADV. PG. 48, 49.
- Ⓞ HEWLETT-PACKARD CO., 395 Page Mill Road, Palo Alto, Calif. ADV. PG. 33-36.

LINKS—Antenna

- Ⓞ BARKER & WILLIAMSON, 235 Fairfield Ave., Upper Darby, Pa. ADV. PG. 292.
- Ⓞ CINCH MFG. CORP., 1026 S. Homan Ave., Chicago 24, Ill. ADV. PG. 186, 187.
- Ⓞ Network Mfg. Corp., Bayonne, N. J.
- Ⓞ PRODUCT DEVELOPMENT CO., INC., Arlington, N. J. ADV. PG. 362.
- Ⓞ Wind Turbine Co., Tower & Antenna Div., E. Market St. & Penna. R. R., West Chester, Pa.

LITHIUM COMPOUNDS

See Metals

LOCATORS—Electronic Metal Locators & Detectors

- Ⓞ Brilmayer Labs., Inc., E. W., 86 Fulton St., New York 38, N. Y.
- Ⓞ Engineering Lab., Inc., 602 E. 4th St., Tulsa 3, Okla.
- Ⓞ Fisher Research Lab., 1961 University Ave., Palo Alto, Calif.
- Ⓞ Nuclear Research Corp., 2707 Federal St., Philadelphia 46, Pa.

LOCATORS—Power Line Failure

- Ⓞ AIRMEC LABORATORIES LTD., 366 Madison Ave., New York 17, N. Y. ADV. PG. 336.
- Ⓞ Deutschmann Corp., Tobe, 921 Providence Highway, Norwood, Mass.
- Ⓞ Hathaway Instrument Co., 1315 S. Clarkson St., Denver 10, Colo.
- Ⓞ Jarvis Electronics Corp., 6058 W. Fullerton Ave., Chicago 39, Ill.
- Ⓞ Radar Engineers, 110 University Place, Seattle 1, Wash.
- Ⓞ Sprague Electric Co., North Adams, Mass.
- Ⓞ Standard Telephones & Cables Ltd., Connaught House, Aldwych, London, W.C. 2, England.
- Ⓞ Winslow Co., Inc., 9 Liberty St., Newark 5, N. J.

LOCATORS—Radio Interference

- Ⓞ Bassett, Inc., Rex, 307-11 N.W. First Ave., Fort Lauderdale, Fla.
- Ⓞ Deutschmann Corp., Tobe, 921 Providence Highway, Norwood, Mass.
- Ⓞ MEASUREMENTS CORP., Boonton, N. J. ADV. PG. 99.
- Ⓞ Sprague Electric Co., North Adams, Mass.

LOCKS—Dial

- Ⓞ Bud Radio, Inc., 2118 E. 55th St., Cleveland 3, Ohio.
- Ⓞ CAMBRIDGE THERMIONIC CORP., 445 Concord Ave., Cambridge 38, Mass. ADV. PG. 37.
- Ⓞ CITATION PRODUCTS CO., 233 E. 146th St., New York 51, N. Y. ADV. PG. 388.
- Ⓞ NATIONAL CO., INC., 61 Sherman St., Malden 48, Mass. ADV. PG. 280, 281.
- Ⓞ Tinnerman Products, Inc., P. O. Box 6688, Dept. No. 16, Cleveland 1, Ohio.

LOCKS—Shaft

- Ⓞ ALDEN PRODUCTS CO., 117 N. Main St., Brockton 64, Mass. ADV. PG. 327.

- Ⓞ CAMBRIDGE THERMIONIC CORP., 445 Concord Ave., Cambridge 38, Mass. ADV. PG. 37.
- Ⓞ CITATION PRODUCTS CO., 233 E. 146th St., New York 51, N. Y. ADV. PG. 388.
- Ⓞ NATIONAL CO., INC., 61 Sherman St., Malden 48, Mass. ADV. PG. 280, 281.
- Ⓞ Tinnerman Products, Inc., P. O. Box 6688, Dept. No. 16, Cleveland 1, Ohio.
- Ⓞ U. S. Engineering Co., 521 Commercial St., Glendale 3, Calif.

LORAN NAVIGATIONAL DEVICES

- Ⓞ Blutworth Marine Div., National-Simplex-Blutworth, Inc., 92 Gold St., New York 38, N. Y.
- Ⓞ BROWNING LABORATORIES, INC., 750 Main St., Winchester, Mass. ADV. PG. 257.
- Ⓞ RADIO CORP. OF AMERICA, RCA Victor Div., General Offices, Camden, N. J. ADV. PG. 177, Inside Back & Back Covers.
- Ⓞ Radiomarine Corp. of America, 75 Varick St., New York 13, N. Y.
- Ⓞ SPERRY GYROSCOPE CO., Div. of The Sperry Corp., Great Neck, N. Y. ADV. PG. 103, 104.

LOUDSPEAKER DRIVER UNITS

- Ⓞ Altec Lansing Corp., 9356 Santa Monica Blvd., Beverly Hills, Calif.
- Ⓞ Atlas Sound Corp., 1443 39th St., Brooklyn 18, N. Y.
- Ⓞ Cleveland Electronics, Inc., 6611 Euclid Ave., Cleveland, Ohio.
- Ⓞ Dilks Co., The, Seymour, Conn.
- Ⓞ ELECTRO-VOICE, INC., Buchanan, Mich. ADV. PG. 345.
- Ⓞ Holl Audio Industries, 9215 Venice Blvd., Los Angeles 34, Calif.
- Ⓞ Jensen Mfg. Co., 6601 S. Laramie Ave., Chicago 38, Ill.
- Ⓞ Lansing Sound, Inc., James B., 2439 Fletcher Drive, Los Angeles 26, Calif.
- Ⓞ Operadio Mfg. Co., 135th & Indiana Sts., St. Charles, Ill.
- Ⓞ Racon Electric Co., 52 E. 19th St., New York 3, N. Y.
- Ⓞ RADIO CORP. OF AMERICA, RCA Victor Div., General Offices, Camden, N. J. ADV. PG. 177, Inside Back & Back Covers.
- Ⓞ Stephens Mfg. Corp., 8538 Warner Drive, Culver City, Calif.
- Ⓞ TANNNOY, 350 Fifth Ave., New York 1, N. Y. ADV. PG. 412.
- Ⓞ UNIVERSITY LOUDSPEAKERS INC., 80 S. Kensico Ave., White Plains, N. Y. ADV. PG. 38.

LOUDSPEAKERS

- Ⓞ Altec Lansing Corp., 9356 Santa Monica Blvd., Beverly Hills, Calif.
- Ⓞ Best Mfg. Co., Inc., 1200 Grove St., Irvington 11, N. J.
- Ⓞ Bozak Co., R. T., 90 Montrose Ave., Buffalo 14, N. Y.
- Ⓞ British Industries Corp., 164 Duane St., New York 13, N. Y.
- Ⓞ Brociner Electronics Laboratory, 1546 Second Ave., New York 28, N. Y.
- Ⓞ Carboneau Industries, Inc., Grand Rapids, Mich.
- Ⓞ Carron Mfg. Co., 415 S. Aberdeen St., Chicago, Ill.
- Ⓞ Cinaudagraph Speakers, 7334 N. Clark St., Chicago 26, Ill.
- Ⓞ Cleveland Electronics, Inc., 6611 Euclid Ave., Cleveland, Ohio.
- Ⓞ Consolidated Radio Products Co., 350 W. Erie St., Chicago 10, Ill.
- Ⓞ Crescent Industries, Inc., 4140 Belmont Ave., Chicago 41, Ill.
- Ⓞ DX Radio Products Co., Inc., 2304 Armitage Ave., Chicago 47, Ill.
- Ⓞ Delco Radio Div., General Motors Corp., Kokomo, Ind.
- Ⓞ Dilks Co., The, Seymour, Conn.
- Ⓞ ELECTRO-VOICE, INC., Buchanan, Mich. ADV. PG. 345.
- Ⓞ ELECTRO ACOUSTIC INDUSTRIES LTD., 366 Madison Ave., New York 17, N. Y. ADV. PG. 336.
- Ⓞ Galbraith & Son Electric Corp., C. C., 450 Sixth Ave., New York 11, N. Y.
- Ⓞ GLASER-STEERS CORP., 2 Main St., Belleville 9, N. J. ADV. PG. 359.
- Ⓞ Hartley Co., Ltd., H. A., 152 Hammersmith Rd., London W. 6, England.
- Ⓞ HEPPNER MFG. CO., P. O. Box 612, Round Lake, Ill. ADV. PG. 413.
- Ⓞ Holl Audio Industries, 9215 Venice Blvd., Los Angeles 34, Calif.
- Ⓞ Horton Machine Products Co., Horton & Rockaway Aves., Valley Stream, N. Y.
- Ⓞ Jensen Mfg. Co., 6601 S. Laramie Ave., Chicago 38, Ill.
- Ⓞ Klipsch & Associates, Hope, Ark.
- Ⓞ Lansing Sound, Inc., James B., 2439 Fletcher Drive, Los Angeles 26, Calif.
- Ⓞ Magnavox Co., The, Components Div., Fort Wayne 4, Ind.
- Ⓞ Mellaphone Corp., Rochester 2, N. Y.
- Ⓞ Molded Insulation Co., 335 E. Price St., Philadelphia 44, Pa.

- Ⓞ Operadio Mfg. Co., 135th and Indiana Sts., St. Charles, Ill.
- Ⓞ Oxford Electric Corp., 3911 S. Michigan Ave., Chicago 15, Ill.
- Ⓞ PERFECTION ELECTRIC CO., 2635 S. Wabash Ave., Chicago 16, Ill. ADV. PG. 102, 142, 256, 405.
- Ⓞ PERMOFLUX CORP., 4900 W. Grand Avenue, Chicago 39, Ill. ADV. PG. 321.
- Ⓞ Philco Corp., Tioga and C Sts., Philadelphia 34, Pa. ADV. PG. 284.
- Ⓞ PICKERING & CO., 309 Woods Ave., Oceanside N. Y. ADV. PG. 284.
- Ⓞ Quam Nichols Co., 526 E. 33rd Place, Chicago 16, Ill.
- Ⓞ Racon Electric Co., 52 E. 19th St., New York 3, N. Y.
- Ⓞ RADIO CORP. OF AMERICA, Tube Dept., Harrison, N. J. ADV. PG. 177, Inside Back & Back Covers.
- Ⓞ RADIO CORP. OF AMERICA, RCA Victor Div., General Offices, Camden, N. J. ADV. PG. 177, Inside Back & Back Covers.
- Ⓞ Rola Co., Inc., The, 2530 Superior Ave., Cleveland 14, Ohio.
- Ⓞ Stephens Mfg. Corp., 8538 Warner Drive, Culver City, Calif.
- Ⓞ TANNNOY, 350 Fifth Ave., New York 1, N. Y. ADV. PG. 412.
- Ⓞ UNIVERSITY LOUDSPEAKERS, INC., 80 S. Kensico Ave., White Plains, N. Y. ADV. PG. 38.
- Ⓞ Utah Radio Products, Inc., E. Franklin St., Huntington, Ind.

LOUDSPEAKERS—Flame & Explosion-proof

- Ⓞ Atlas Sound Corp., 1443 39th St., Brooklyn 18, N. Y.
- Ⓞ ELECTRO-VOICE, INC., Buchanan, Mich. ADV. PG. 345.
- Ⓞ PERMOFLUX CORP., 4900 W. Grand Ave., Chicago 33, Ill. ADV. PG. 321.
- Ⓞ Racon Electric Co., 52 E. 19th St., New York 3, N. Y.
- Ⓞ RADIO CORP. OF AMERICA, RCA Victor Div., General Offices, Camden, N. J. ADV. PG. 177, Inside Back & Back Covers.
- Ⓞ TANNNOY, 350 Fifth Ave., New York 1, N. Y. ADV. PG. 412.
- Ⓞ Tartak-Stolle Electronics, Inc., 3970 S. Grand Ave., Los Angeles 37, Calif.
- Ⓞ UNIVERSITY LOUDSPEAKERS, INC., 80 S. Kensico Ave., White Plains, N. Y. ADV. PG. 38.

LOUDSPEAKERS—Marine Speaker Systems

- Ⓞ Altec Lansing Corp., 9356 Santa Monica Blvd., Beverly Hills, Calif.
- Ⓞ Atlas Sound Corp., 1443 39th St., Brooklyn 18, N. Y.
- Ⓞ Breico Electronics Corp., 55 Vandam St., New York 13, N. Y.
- Ⓞ Cleveland Electronics, Inc., 6611 Euclid Ave., Cleveland, Ohio.
- Ⓞ ELECTRO-VOICE, INC., Buchanan, Mich. ADV. PG. 345.
- Ⓞ Galbraith & Son Electric Corp., C. C., 450 Sixth Ave., New York 11, N. Y.
- Ⓞ Hose-McCann Telephone Co., Inc., 25th St. and 3rd Ave., Brooklyn 32, N. Y.
- Ⓞ Intervox Corp., 2701 California Ave., Seattle 6, Wash.
- Ⓞ Jensen Mfg. Co., 6601 S. Laramie Ave., Chicago 38, Ill.
- Ⓞ PERMOFLUX CORP., 4900 W. Grand Ave., Chicago 39, Ill. ADV. PG. 321.
- Ⓞ Racon Electric Co., 52 E. 19th St., New York 3, N. Y.
- Ⓞ RADIO CORP. OF AMERICA, RCA Victor Div., General Offices, Camden, N. J. ADV. PG. 177, Inside Back & Back Covers.
- Ⓞ Rola Co., Inc., The, 2530 Superior Ave., Cleveland 14, Ohio.
- Ⓞ Remler Co. Ltd., 2101 Bryant St., San Francisco 10, Calif.
- Ⓞ Stephens Mfg. Corp., 8538 Warner Drive, Culver City, Calif.
- Ⓞ TANNNOY, 350 Fifth Ave., New York 1, N. Y. ADV. PG. 412.
- Ⓞ UNIVERSITY LOUDSPEAKERS, INC., 80 S. Kensico Ave., White Plains, N. Y. ADV. PG. 412.

LOUDSPEAKERS—Tweeters & Woofers

- Ⓞ Altec Lansing Corp., 9356 Santa Monica Blvd., Beverly Hills, Calif.
- Ⓞ Atlas Sound Corp., 1443 39th St., Brooklyn 18, N. Y.
- Ⓞ Bozak Co., R. T., 90 Montrose Ave., Buffalo 14, N. Y.
- Ⓞ British Industries Corp., 164 Duane St., New York 13, N. Y.
- Ⓞ Cleveland Electronics, Inc., 6611 Euclid Ave., Cleveland, Ohio.
- Ⓞ ELECTRO-VOICE, INC., Buchanan, Mich. ADV. PG. 345.
- Ⓞ Holl Audio Industries, 9215 Venice Blvd., Los Angeles 34, Calif.
- Ⓞ Jensen Mfg. Co., 6601 S. Laramie Ave., Chicago 38, Ill.
- Ⓞ Klipsch & Associates, Hope, Ark.

Ⓢ indicates . . . IN PRODUCTION • AVAILABILITY • UNRESTRICTED FOR GENERAL USE

- Ⓢ Lansing Sound, Inc., James B., 2439 Fletcher Drive, Los Angeles 26, Calif.
- Ⓢ Magnavox Co., The Components Div., Fort Wayne 4, Ind.
- Ⓢ PERMOFLUX CORP., 4900 W. Grand Ave., Chicago 39, Ill. ADV. PG. 321.
- Ⓢ Philco Corp., Tioga & C Sts., Philadelphia 34, Pa.
- Ⓢ Quam Nichols Co., 526 E. 33rd Place, Chicago 16, Ill.
- Ⓢ Racon Electric Co., 52 E. 19th St., New York 3, N. Y.
- Ⓢ RADIO CORP. OF AMERICA, RCA Victor Div., General Offices, Camden, N. J. ADV. PG. 177, Inside Back & Back Covers.
- Ⓢ Stephens Mfg. Corp., 8538 Warner Drive, Culver City, Calif.
- Ⓢ TANNAY, 350 Fifth Ave., New York 1, N. Y. ADV. PG. 412.
- Ⓢ UNIVERSITY LOUDSPEAKERS, INC., 80 S. Kensico Ave., White Plains, N. Y. ADV. PG. 38.
- Ⓢ Utah Radio Products, Inc., E. Franklin St., Huntington, Ind.

LUGS AND TERMINALS

- Ⓢ AEROLITE ELECTRONIC HARDWARE CORP., 507 26th St., Union City, N. J. ADV. PG. 355.
- Ⓢ AIRCRAFT-MARINE PRODUCTS, INC., 2100 Paxton St., Harrisburg 10, Pa. ADV. PG. 367.
- Ⓢ ALDEN PRODUCTS CO., 117 N. Main St., Brockton 64, Mass. ADV. PG. 327.
- Ⓢ ART WIRE & STAMPING CO., 227 High St., Newark 2, N. J. ADV. PG. 38.
- Ⓢ BEAD CHAIN MFG. CO., 110 Mountain Grove St., Bridgeport 5, Conn. ADV. PG. 136.
- Ⓢ Belden Mfg. Co., 4647 W. Van Buren St., Chicago 44, Ill.
- Ⓢ Birnbach Radio Co., Inc., 145 Hudson St., Ntw York, N. Y.
- Ⓢ BUCHANAN ELECTRICAL PRODUCTS CORP., 223 Route 29, Hillside, N. J. ADV. PG. 332.
- Ⓢ CAMBRIDGE THERMIONIC CORP., 445 Concord Ave., Cambridge 38, Mass. ADV. PG. 37.
- Ⓢ CINCH MFG. CORP., 1026 S. Homan Ave., Chicago 24, Ill. ADV. PG. 186, 187.
- Ⓢ CITATION PRODUCTS CO., 233 E. 146th St., New York 51, N. Y. ADV. PG. 388.
- Ⓢ Dante Electric Mfg. Co., Bantam, Conn.
- Ⓢ FEDERAL SCREW PRODUCTS INC., 224 W. Huron St., Chicago 10, Ill. ADV. PG. 76.
- Ⓢ Frankel Connector Co., 177 Hudson St., New York, N. Y.
- Ⓢ FRANKLIN AIRLOOP CORP., 43-20 34th St., Long Island City, N. Y. ADV. PG. 45.
- Ⓢ FRANKLIN MFG. CORP., A. W., 43-20 34th St., Long Island City, N. Y. ADV. PG. 44.
- Ⓢ GENERAL ACCESSORIES CO., LTD., 366 Madison Ave., New York 17, N. Y. ADV. PG. 336.
- Ⓢ Hatheway Mfg. Co., 1500 Railroad Ave., Bridgeport, Conn.
- Ⓢ General Cement Mfg. Co., 919 Taylor Ave., Rockford, Ill.
- Ⓢ Greene Mfg. Corp., G. G., Warren, Pa.
- Ⓢ HEYMAN MFG. CO., 300 Michigan Ave., Kenilworth, N. J. ADV. PG. 381.
- Ⓢ Ilco Copper Tube Products, Inc., Mariemont Ave., Mariemont, Cincinnati 27, Ohio.
- Ⓢ INDUSTRIAL HARDWARE MFG. CO., INC., 109 Prince St., New York, N. Y. ADV. PG. 360.
- Ⓢ Insuline Corp. of America, 36-02 35th Ave., Long Island City, N. Y.
- Ⓢ JOHNSON CO., E. F., Waseca, Minn. ADV. PG. 118, 121.
- Ⓢ Keystone Electronics Corp., 423 Broome St., New York 12, N. Y.
- Ⓢ Kolton Electric Mfg Co., 123 New Jersey Railroad Ave., Newark 5, N. J.
- Ⓢ KULKHA ELECTRIC MFG. CO., INC., 30 South St., Mount Vernon, N. Y. ADV. PG. 317.
- Ⓢ MALCO TOOL & MFG. CO., 4025 W. Lake St., Chicago 24, Ill. ADV. PG. 385.
- Ⓢ METHODE MFG. CORP., 2265 W. St. Paul Ave., Chicago 47, Ill. ADV. PG. 347.
- Ⓢ NATIONAL CO., INC., 61 Sherman St., Malden 48, Mass. ADV. PG. 280, 281.
- Ⓢ National Tel-Tronics Corp., 35 St. Casmirs Ave., Yonkers, N. Y.
- Ⓢ PAINTON & CO., INC., LTD., 366 Madison Ave., New York 17, N. Y. ADV. PG. 336.
- Ⓢ Penn-Union Electric Corp., 315 State Street, Erie, Pa.
- Ⓢ PIX MFG. CO., INC., 24 Bedford St., Newark, N. J. ADV. PG. 136.
- Ⓢ PRECISION METAL PRODUCTS OF MALDEN, 41 Elm St., Stoneham 80, Mass. ADV. PG. 341.
- Ⓢ REEVES INSTRUMENT CORP., 215 E. 91st St., New York, N. Y. ADV. PG. 315.
- Ⓢ STAVER CO., INC., Box 431, Bayshore, N. Y. ADV. PG. 232.
- Ⓢ Schott Co., Walter L., 3225 Exposition Pl., Los Angeles 18, Calif.
- Ⓢ SHERMAN MFG. CO., H. B., 22 Barney St., Battle Creek, Mich. ADV. PG. 156.
- Ⓢ Smith, Inc., Herman H., 436 18th St., Brooklyn 15, N. Y.
- Ⓢ Stimpson Co., Inc., Edwin B., 74 Franklin Ave., Brooklyn 5, N. Y.
- Ⓢ Thomas & Betts Co., Inc., 40 Butler St., Elizabeth 1, N. J.

- Ⓢ Ucinite Co. Division, United-Carr Fastener Corp., 459 Watertown St., Newtonville, Mass.
- Ⓢ United Carr Fastener Corp., Cambridge 42, Mass.
- Ⓢ U. S. Engineering Co., 521 Commercial St., Glendale 3, Calif.
- Ⓢ Wade Electric Products Co., 211 Jacob St., Sturgis, Mich.
- Ⓢ Wheaton Co., T. G., Industrial Div., 220 G St., Millville, N. J.
- Ⓢ Winslow Co., Inc., 9 Liberty St., Newark 5, N. J.
- Ⓢ Zierick Mfg. Corp., Beechwood and Rockdale Aves., New Rochelle, N. Y.

MACHINES—Blueprint

- Ⓢ American Photocopy Equipment Co., 2849 N. Clark St., Chicago, Ill.
- Ⓢ Dietzgen Co., Eugene, 2425 Sheffield Ave., Chicago 14, Ill.
- Ⓢ Pease Co., C. F., 2601 W. Irving Park Rd., Chicago, Ill.
- Ⓢ Peck & Harvey, 5736-38 N. Western Ave., Chicago 45, Ill.
- Ⓢ Post Co., Frederick, 3650 N. Avondale Ave., P. O. Box 803, Chicago 90, Ill.

MACHINES—Coil Winding

- Ⓢ Associated Production Co., 162 N. Clinton St., Chicago 6, Ill.
- Ⓢ Boesch Mfg. Co., Danbury, Conn.
- Ⓢ COIL WINDING EQUIPMENT CO., 37 W. Main St., Oyster Bay, N. Y. ADV. PG. 415.
- Ⓢ Cosa Corp., 405 Lexington Ave., New York 17, N. Y.
- Ⓢ Douglas-Randall, Inc., 102 High St., Westerly, R. I.
- Ⓢ EISLER ENGINEERING CO., INC., 740 S. 13th St., Newark 3, N. J. ADV. PG. 378.
- Ⓢ MICO INSTRUMENT CO., 76 Trowbridge St., Cambridge 38, Mass. ADV. PG. 381.
- Ⓢ Seifert, Inc., E. R., 202-204 S. Beech St., Syracuse 10, N. Y.
- Ⓢ Stevens Mfg. Co., Inc., Geo., 6022 N. Rogers Ave., Pulaski and Peterson, Chicago 30, Ill.
- Ⓢ Universal Winding Co., P. O. Box 1605, Providence 1, R. I.
- Ⓢ Weymouth Instrument Co., 1440 Commercial St., East Weymouth 89, Mass.

MACHINES—Counting (Photoelectric)

- Ⓢ AIRMEC LABORATORIES LTD., 366 Madison Ave., New York 17, N. Y. ADV. PG. 336.
- Ⓢ Electro Craft Inc., 52 Davenport St., Stamford, Conn.
- Ⓢ Electronic Control Corp., 1573 E. Forest St., Detroit, Mich.
- Ⓢ GENERAL ELECTRIC CO., Schenectady 5, N. Y. ADV. PG. 1 to 22.
- Ⓢ Industrial Electronics Co., Hanover, Mass.
- Ⓢ Photobell Company, 116 Nassau St., New York 7, N. Y.
- Ⓢ POTTER INSTRUMENT CO., INC., 115 Cutter Hill Rd., Great Neck, N. Y. ADV. PG. 318.
- Ⓢ Production Instrument Co., 710 W. Jackson Blvd., Chicago 6, Ill.
- Ⓢ Ripley Co., Inc., Middletown, Conn.
- Ⓢ Worner Electronic Devices, Rankin, Ill.

MACHINES—Crystal Manufacturing & Finishing

- Ⓢ Bassett, Inc., Rex, 307-11 N. W. First Ave., Fort Lauderdale, Fla.
- Ⓢ CLARK CRYSTAL CO., 2 Farm Rd., Marlboro, Mass. ADV. PG. 366.
- Ⓢ Crane Packing Co., 1800 Cuyler Ave., Chicago 13, Ill.
- Ⓢ Distillation Products Div. of Eastman Kodak Co., 755 Ridge Rd. W., Rochester 3, N. Y.
- Ⓢ Polytech Devices, Inc., 1180 E. Grand St., Elizabeth, N. J.
- Ⓢ REEVES-HOFFMAN CORP., 321 Cherry St., Carlisle, Pa. ADV. PG. 286.

MACHINES—Electric Soldering

- Ⓢ Cole Radio Works, 86 Westville Ave., Caldwell, N. J.
- Ⓢ EISLER ENGINEERING CO., INC., 740 S. 13th St., Newark 3, N. J. ADV. PG. 378.
- Ⓢ Ideal Industries, Inc., Park and Borden Aves., Sycamore, Ill.
- Ⓢ Luma Electric Equipment Co., Box 132, Toledo 1, Ohio.
- Ⓢ Miskella Infra-Red Co., East 73rd & Grand Ave., Cleveland 4, Ohio.
- Ⓢ Multi-Products Tool Co., 123 Sussex Ave., Newark 4, N. J.
- Ⓢ Standard Telephones & Cables Ltd., Connaught House, Aldwych, London, W. C. 2, England.

MACHINES—Electronic Balancing

- Ⓢ AIRMEC LABORATORIES LTD., 366 Madison Ave., New York 17, N. Y. ADV. PG. 336
- Ⓢ Annis Co., R. B., 1101 N. Delaware St., Indianapolis, Ind.

- Ⓢ Leeds & Northrup Co., 4970 Stenton Ave., Philadelphia 44, Pa.
- Ⓢ SPERRY GYROSCOPE CO., Div of The Sperry Corp., Great Neck, N. Y. ADV. PG. 103, 104.
- Ⓢ WESTINGHOUSE ELECTRIC CORP., 511 Wood St., P. O. Box 868, Pittsburgh 30, Pa. ADV. PG. 107-113.

MACHINES—Electronic Beverage Inspection

- Ⓢ Industrial Electronics Co., Hanover, Mass.
- Ⓢ Leeds & Northrup Co., 4970 Stenton Ave., Philadelphia 44, Pa.
- Ⓢ Nuclear Research Corp., 2707 Federal St., Philadelphia 46, Pa.

MACHINES—Electronic Computing

- Ⓢ Arma Corp., 254 36th Ct., Brooklyn 32, N. Y.
- Ⓢ Atlantic Electronics, 4 Manhasset Ave., Manohaven, N. Y.
- Ⓢ ATOMIC INSTRUMENT CO., 84 Massachusetts Ave., Cambridge 39, Mass. ADV. PG. 410.
- Ⓢ Avion Instrument Corp., Paramus, N. J.
- Ⓢ BARKER & WILLIAMSON, 235 Fairfield Ave., Upper Darby, Pa. ADV. PG. 292.
- Ⓢ Computer Corp. of America, 149 Church St., New York, N. Y.
- Ⓢ Condon Radio Mfg. Co., 631 Whipple, Prescott, Ariz.
- Ⓢ Consolidated Engineering Corp., 300 N. Sierra Madre Blvd., Pasadena 8, Calif.
- Ⓢ Davies Laboratories, Inc., 4705 Queensbury Rd., Riverdale, Md.
- Ⓢ Doelcam Corp., 56 Elmwood St., Newton 58, Mass.
- Ⓢ Eckert-Mauchly Computer Corp., 3747 Ridge Ave., Philadelphia 32, Pa.
- Ⓢ Electronic Computer Corp., 265 Butler St., Brooklyn 17, N. Y.
- Ⓢ Fairchild Recording Equipment Co., 154th St. & Seventh Ave., Whitestone, N. Y.
- Ⓢ Hathaway Instrument Co., 1315 S. Clarkson St., Denver 10, Colo.
- Ⓢ Macdonald Co., Inc., W. S., 33 University Rd., Cambridge 38, Mass.
- Ⓢ Minnesota Electronics Corp., 47 W. Water St., St. Paul 1, Minn.
- Ⓢ Molded Insulation Co., 335 E. Price St., Philadelphia 44, Pa.
- Ⓢ Philbrick Researches, Inc., George A., 230 Congress St., Boston 10, Mass.
- Ⓢ Phillips Petroleum Co., Market Development Div., Bartlesville, Okla.
- Ⓢ POTTER INSTRUMENT CO., INC., 115 Cutter Mill Rd., Great Neck, N. Y. ADV. PG. 318.
- Ⓢ Radioactive Products, Inc., 443 W. Congress St., Detroit 26, Mich.
- Ⓢ SHERRON ELECTRONICS CO., 1201 Flushing Ave., Brooklyn 6, N. Y. ADV. PG. 145.
- Ⓢ Southwestern Industrial Electronics Co., 2831 Post Oak Rd., P. O. Box 13058, Houston 19, Texas.
- Ⓢ Thompson & Associates, John E., 7210 S. Yates Ave., Chicago 49, Ill.
- Ⓢ Walkirt Co., 5808 Marilyn Ave., Culver City, Calif.

MACHINES—Electronic Dictating

- Ⓢ Crescent Industries, Inc., 4140 Belmont Ave., Chicago 43, Ill.
- Ⓢ Dictaphone Corp., 420 Lexington Ave., New York 17, N. Y.
- Ⓢ Molded Insulation Co., 335 E. Price St., Philadelphia 44, Pa.
- Ⓢ Pentron Corp., 221 E. Cullerton St., Chicago 16, Ill.
- Ⓢ PERMOFLUX CORP., 4900 W. Grand Ave., Chicago 39, Ill. ADV. PG. 321.
- Ⓢ Press Wireless Mfg. Co., Inc., Cantiague Rd., Hicksville, N. Y.
- Ⓢ Proctor Soundex Corp., 133 N. 6th Ave., Mt. Vernon, N. Y.
- Ⓢ Soundscribe Corp., 146 Munson St., New Haven 4, Conn.

MACHINES—Electronic Transcribing

- Ⓢ Crescent Industries, Inc., 4140 Belmont Ave., Chicago 43, Ill.
- Ⓢ Dictaphone Corp., 420 Lexington Ave., New York 17, N. Y.
- Ⓢ Gates Radio Co., Quincy Ill.
- Ⓢ Pentron Corp., 221 E. Cullerton St., Chicago 16, Ill.
- Ⓢ PERMOFLUX CORP., 4900 W. Grand Ave., Chicago 39, Ill. ADV. PG. 321.
- Ⓢ Press Wireless Mfg. Co., Inc., Cantiague Rd., Hicksville, N. Y.
- Ⓢ Soundscribe Corp., 146 Munson St., New Haven 4, Conn.
- Ⓢ Thordarson-Meissner Mfg. Divs., 500 W. Huron St., Chicago 10, Ill.

MACHINES—Engraving and Profiling

- Ⓢ Annis Co., R. B., 1101 N. Delaware St., Indianapolis, Ind.

Ⓜ indicates . . . IN PRODUCTION • AVAILABILITY • UNRESTRICTED FOR GENERAL USE

- Ⓜ Auto Engraver Co., Ridgefield, Conn.
- Ⓜ GREEN INSTRUMENT CO., 385 Putnam Ave., Cambridge, Mass. ADV. PG. 224.
- Ⓜ MICO INSTRUMENT CO., 76 Trowbridge St., Cambridge 38, Mass. ADV. PG. 381.
- Ⓜ NEW HERMES, INC., 13-19 University Place, New York 3, N. Y. ADV. PG. 411.
- Ⓜ Pratt & Whitney Div., Niles-Bement-Pond Co., West Hartford 1, Conn.
- Ⓜ Preis Engraving Machine Co., H., 649 Highway No. 29, Hillside, N. J.
- Ⓜ Radiocrafters, 1156 Commonwealth Ave., Boston 34, Mass.

MACHINES—Glass Blowing

- Ⓜ EISLER ENGINEERING CO., INC., 740 S. 13th St., Newark 3, N. J. ADV. PG. 378.
- Ⓜ KAHLE ENGINEERING CO., 1307 Seventh St., North Bergen, N. J. ADV. PG. 369.

MACHINES—Glass Working

- Ⓜ EISLER ENGINEERING CO., INC., 740 S. 13th St., Newark 3, N. J. ADV. PG. 378.
- Ⓜ Federal Tool Engineering Co., 532 Mulberry St., Newark 5, N. J.
- Ⓜ KAHLE ENGINEERING CO., 1307 Seventh St., North Bergen, N. J. ADV. PG. 369.
- Ⓜ MICO INSTRUMENT CO., 76 Trowbridge St., Cambridge 38, Mass. ADV. PG. 381.
- Ⓜ Sommer & Maca Glass Machine Co., 3600 S. Oakley Ave., Chicago 9, Ill.

MACHINES—Impregnating

- Ⓜ Barrett Co., Leon J., P. O. Box 378, Worcester 1, Mass.
- Ⓜ Production Engineering Co., 173 Sargeant Ave., Clifton, N. J.

MACHINES—Instrument Shock Testing

- Ⓜ L.A.B. Corp., 31 Union Place, Summit, N. J.

MACHINES—Metal and Glass Marking

- Ⓜ Acromark Co., The, 422 Morrell St., Elizabeth 4, N. J.
- Ⓜ EISLER ENGINEERING CO., INC., 740 S. 13th St., Newark 3, N. J. ADV. PG. 378.
- Ⓜ Ideal Industries, Inc., Park & Borden Aves., Sycamore, Ill.
- Ⓜ KAHLE ENGINEERING CO., 1307 Seventh St., North Bergen, N. J. ADV. PG. 369.
- Ⓜ MARKEM MACHINE CO., Keene, N. H. ADV. PG. 238.
- Ⓜ Matthews Co., J. H., 470 Atlantic Ave., Boston 10, Mass.
- Ⓜ NEW HERMES, INC., 13-19 University Place, New York 3, N. Y. ADV. PG. 411.
- Ⓜ Noble & Westbrook Mfg. Co., 27 Westbrook St., East Hartford, 8, Conn.

MACHINES—Photocopy

- Ⓜ American Photocopy Equipment Co., 2849 N. Clark St., Chicago, Ill.
- Ⓜ Dietzgen Co., Eugene, 2425 Sheffield Ave., Chicago 14, Ill.
- Ⓜ General Photo Products Co., Inc., 15 Summit Ave., Chatham, N. J.
- Ⓜ Haloid Co., The, 6 Haloid St., Rochester, N. Y.
- Ⓜ Hunter Photo Copyist Co., 566 Spencer St., Syracuse, N. Y.
- Ⓜ Peerless Photo Products, Shoreham, L. I., N. Y.

MACHINES—Record Manufacturing

- Ⓜ Fairchild Recording Equipment Corp., 154th St. & Seventh Ave., Whitestone, N. Y.
- Ⓜ Poinsettia Co., Inc., 95 Cedar Ave., Pitman, N. J.

MACHINES—Shock Testing

- Ⓜ Glenco Corp., Metuchen, N. J.
- Ⓜ Gulton Mfg. Corp., Metuchen, N. J.
- Ⓜ L.A.B. Corp., 31 Union Place, Summit, N. J.

MACHINES—Tube Manufacturing

- Ⓜ Distillation Products Div. of Eastman Kodak Co., 755 Ridge Rd., W., Rochester 3, N. Y.
- Ⓜ Electronic Engineering Corp., 469 Elm St., Arlington, N. J.
- Ⓜ Elm Laboratories, 18 South Broadway, Dobbs Ferry, N. Y.
- Ⓜ Federal Tool Engineering Co., 532 Mulberry St., Newark 5, N. J.
- Ⓜ International Machine Works, 6904 Madison St., Guttenberg, N. J.

- Ⓜ KAHLE ENGINEERING CO., 1307 Seventh St., North Bergen, N. J. ADV. PG. 369.
- Ⓜ RADIO CORP. OF AMERICA, Tube Dept., Harrison, N. J. ADV. PG. 177, Inside Back & Back Covers.

MACHINES—Vibration Fatigue Testing

- Ⓜ Baldwin-Lima-Hamilton Corp., Paschall P. O. Station, Philadelphia 42, Pa.
- Ⓜ CALIDYNE CO., THE, 751 Main St., Winchester, Mass. ADV. PG. 329.
- Ⓜ Gates Radio Co., Quincy, Ill.
- Ⓜ GENERAL ELECTRIC CO., Schenectady 5, N. Y. ADV. PG. 1 to 22.
- Ⓜ Glenco Corp., Metuchen, N. J.
- Ⓜ Gulton Mfg. Corp., Metuchen, N. J.
- Ⓜ L.A.B. Corp., 31 Union Place, Summit, N. J.
- Ⓜ MB MFG. CO., 1060 State St., New Haven 11, Conn. ADV. PG. 365.
- Ⓜ Rollin Co., 2070 N. Fair Oaks Ave., Pasadena 3, Calif.
- Ⓜ Thordarson-Meissner Mfg. Divs., 500 W. Huron St., Chicago 10, Ill.
- Ⓜ WESTINGHOUSE ELECTRIC CORP., 511 Wood St., P. O. Box 868, Pittsburgh 30, Pa. ADV. PG. 107-113.

MACHINES—Whiteprint

- Ⓜ Bruning Co., Inc., Charles, 102 Reade St., New York, N. Y.
- Ⓜ Dietzgen Co., Eugene, 2425 Sheffield Ave., Chicago 14, Ill.
- Ⓜ General Photo Products Co., 15 Summit Ave., Chatham, N. J.
- Ⓜ Ozalid Div. of General Aniline & Film Corp., 770 Anasco Rd., Johnson City, N. Y.
- Ⓜ Pease Co., C. F., 2601 W. Irving Park Rd., Chicago, Ill.
- Ⓜ Peck & Harvey, 5736-38 North Western Ave., Chicago 45, Ill.

MACHINES—Wire Stripping

- Ⓜ AIRCRAFT-MARINE PRODUCTS, INC., 2100 Paxton St., Harrisburg 10, Pa. ADV. PG. 367.
- Ⓜ Artos Engineering Co., 2737 S. 28th St., Milwaukee, Wis.
- Ⓜ EISLER ENGINEERING CO., INC., 740 S. 13th St., Newark 3, N. J. ADV. PG. 378.
- Ⓜ Electro Precision Products Inc., 119-01 22nd Ave., College Point, N. Y.
- Ⓜ General Cement Mfg. Co., 919 Taylor Ave., Rockford, Ill.
- Ⓜ Ideal Industries, Inc., Park & Borden Aves., Sycamore, Ill.
- Ⓜ Industrial Precision Products Co., 215-325 N. Hoyle Ave., Chicago 12, Ill.
- Ⓜ J. F. D. MFG. CO., 6101-23 Sixteenth Ave., Brooklyn, N. Y. ADV. PG. 407.
- Ⓜ RUSH WIRE STRIPPER DIVISION, The Eraser Co., Inc., 104 S. State St., Syracuse 2, N. Y. ADV. PG. 398.
- Ⓜ Schott Co., Walter L., 3225 Exposition Pl., Los Angeles 18, Calif.
- Ⓜ Standard Telephones & Cables Ltd., Connaught House, Aldwych, London, W. C. 2, England.

MAGNETIC ANALYSIS EQUIPMENT

- Ⓜ Dice Co., J. W., Englewood, N. J.
- Ⓜ Fisher Scientific Co., 717 Forbes St., Pittsburgh 19, Pa.
- Ⓜ GENERAL ELECTRIC CO., Schenectady 5, N. Y. ADV. PG. 1 to 22.
- Ⓜ GENERAL RADIO CO., 275 Massachusetts Ave., Cambridge 39, Mass. ADV. PG. 48, 49.
- Ⓜ Magnetic Analysis Corp., 42-44 12th St., Long Island City 1, N. Y.

MAGNETIZERS AND DEMAGNETIZERS

- Ⓜ Annis Co., R. B., 1101 N. Delaware St., Indianapolis, Ind.
- Ⓜ DoAll Co., 254 N. Laurel Ave., Des Plaines, Ill.
- Ⓜ GENERAL ELECTRIC CO., Schenectady 5, N. Y. ADV. PG. 1 to 22.
- Ⓜ Ideal Industries, Inc., Park & Borden Aves., Sycamore, Ill.
- Ⓜ Luma Electric Equipment Co., P. O. Box 132, Toledo 1, Ohio.
- Ⓜ King Electric Equipment Co., 9123 Inman Ave., Cleveland 5, Ohio.
- Ⓜ Magnetic Analysis Corp., 42-44 12th St., Long Island City 1, N. Y.
- Ⓜ Minnesota Electronics Corp., 47 W. Water St., St. Paul 1, Minn.
- Ⓜ Ther Electric & Machine Works, 15 S. Jefferson St., Chicago, Ill.
- Ⓜ THOMAS & SKINNER STEEL PRODUCTS CO., 1122 E. 23rd St., Indianapolis, Ind. ADV. PG. 403.
- Ⓜ Radio Frequency Labs., Inc., Boonton 2, N. J.

MAGNETOMETERS

- Ⓜ GENERAL ELECTRIC CO., Schenectady 5, N. Y. ADV. PG. 1-22.

- Ⓜ Georator Corp., 1820 N. Nash St., Arlington, Va.
- Ⓜ HEILAND RESEARCH CORP., 130 E. 5th Ave., Colo. ADV. PG. 401.
- Ⓜ H. M. R. Electronics Inc., Grove St., New Canaan, Conn.
- Ⓜ Rawson Electrical Instrument Co., 111 Potter St., Cambridge 42, Mass.
- Ⓜ Welch Scientific Co., W. M., 1515 Sedgwick St., Chicago 10, Ill.

MAGNETRONS See Tubes

MAGNETS—Permanent

- Ⓜ Arnold Engineering Co., Marengo, Ill.
- Ⓜ CARBOLOY COMPANY INC., 11139 E. Eight Mile Blvd., Detroit 32, Mich. ADV. PG. 23.
- Ⓜ CRUCIBLE STEEL CO. OF AMERICA, 405 Lexington Ave., New York 17, N. Y. ADV. PG. 225.
- Ⓜ General Magnetic Corp., 10001 Erwin Ave., Detroit 5, Mich.
- Ⓜ Georator Corp., 1820 N. Nash St., Arlington, Va.
- Ⓜ INDIANA STEEL PRODUCTS CO., Valparaiso, Indiana. ADV. PG. 154.
- Ⓜ MAGNETIC CORE CORP., 142-144 S. Highland Ave., Ossining, N. Y. ADV. PG. 414.
- Ⓜ RADIO CORES, INC., 9540 Tulley Ave., Oak Lawn, Ill. ADV. PG. 396.
- Ⓜ Georator Corp., 1820 N. Nash St., Arlington, Va.
- Ⓜ SIMMONDS SAW & STEEL CO., Lockport, N. Y.
- Ⓜ SYLVANIA ELECTRIC PRODUCTS, INC., 1740 Broadway, New York 19, N. Y. ADV. PG. 432-436.
- Ⓜ THOMAS & SKINNER STEEL PRODUCTS CO., 1122 E. 23rd St., Indianapolis, Ind. ADV. PG. 403.

MARKERS, WIRE See Code and Tab Markers

MASKS—Television

- Ⓜ Croname, Inc., 3701 Ravenswood Ave., Chicago, Ill.
- Ⓜ Deitz Miracle Lens Co., 141 President St., Passaic, N. J.
- Ⓜ Electrovox Co., Inc., 60 Franklin St., East Orange, N. J.
- Ⓜ ERIE RESISTOR CORP., 644 W. 12th St., Erie, Pa. ADV. PG. 91.
- Ⓜ Parisian Novelty Co., 3510 So. Western Ave., Chicago 9, Ill.
- Ⓜ Philco Corp., Tioga & C Sts., Philadelphia 34, Pa.
- Ⓜ Precision Plastic Products Inc., 628-30 W. Lake St., Chicago 6, Ill.

MEGAPHONES—Electronic

- Ⓜ Audio Equipment Co., 80-20 45th Ave., Elmhurst, N. Y.
- Ⓜ Breloco Electronics Corp., 55 Vandam St., New York 13, N. Y.
- Ⓜ Monarch Radio & Television Corp., 2430 Atlantic Ave., Brooklyn 33, N. Y.

MEGOhMMETERS

- Ⓜ AIRMEC LABORATORIES LTD., 366 Madison Ave., New York 17, N. Y. ADV. PG. 336.
- Ⓜ Biddle Co., James G., 1316 Arch St., Philadelphia 7, Pa.
- Ⓜ Associated Research Inc., 3758 W. Belmont, Chicago 18, Ill.
- Ⓜ Cole Instrument Co., 1320 S. Grand Ave., Los Angeles 15, Calif.
- Ⓜ Dice Co., J. W., Englewood, N. J.
- Ⓜ EL-TRONICS, INC., 2649 N. Howard St., Philadelphia 33, Pa. ADV. PG. 299.
- Ⓜ FREED TRANSFORMER CO., INC., 1736 Weirfield St., Brooklyn 27, N. Y. ADV. PG. 149.
- Ⓜ GENERAL ELECTRIC CO., Schenectady 5, N. Y. ADV. PG. 1 to 22.
- Ⓜ GENERAL RADIO CO., 275 Massachusetts Ave., Cambridge 39, Mass. ADV. PG. 48, 49.
- Ⓜ McMurdo Silver Co., Inc., 473 Lafayette St., New York, N. Y.
- Ⓜ Precision Apparatus Co., Inc., 24-34 Horace Harding Blvd., Elmhurst, N. Y.
- Ⓜ Radio Frequency Labs., Inc., Boonton 2, N. J.
- Ⓜ SHALLCROSS MFG. CO., 10 Jackson Ave., Collingsdale, Pa. ADV. PG. 261.
- Ⓜ Sticht Co., Inc., Herman H., 27 Park Place, New York 7, N. Y.
- Ⓜ TRAD TELEVISION CORP., 1001 First Ave., Asbury Park, N. J. ADV. PG. 355.
- Ⓜ Winslow Co., Inc., 9 Liberty St., Newark 5, N. J.

MEGOhMMETERS—Vacuum Tube

- Ⓜ AIRMEC LABORATORIES LTD., 366 Madison Ave., New York 17, N. Y. ADV. PG. 336.
- Ⓜ Approved Electronic Instrument Corp., 146 Liberty St., New York 6, N. Y.
- Ⓜ Associated Research, Inc., 3758 W. Belmont, Chicago 18, Ill.
- Ⓜ BETA ELECTRIC CORP., 333 E. 103rd St., New York 29, N. Y. ADV. PG. 399.

Ⓢ Indicates . . . **IN PRODUCTION • AVAILABILITY • UNRESTRICTED FOR GENERAL USE**

- ⓈCOMMUNICATION MEASUREMENTS LAB., INC., 120 Greenwich St., New York 6, N. Y. ADV. PG. 290.
- ⓈELECTRONIC INSTRUMENT CO., INC., 276 Newport St., Brooklyn 12, N. Y. ADV. PG. 129.
- ⓈFeiler Engineering Co., 8026 Monticello Ave., Skokie, Ill.
- ⓈFREED TRANSFORMER CO., INC., 1736 Weirfield St., Brooklyn 27, N. Y. ADV. PG. 149.
- ⓈGENERAL ELECTRIC CO., Schenectady 5, N. Y. ADV. PG. 1 to 22.
- ⓈGENERAL RADIO CO., 275 Massachusetts Ave., Cambridge 39, Mass. ADV. PG. 48, 49.
- ⓈKelley-Koett Instrument Co., 962 York St., Cincinnati 14, Ohio.
- ⓈMcMurdo Silver Co., Inc., 473 Lafayette St., New York, N. Y.
- ⓈMacLeod & Hanopol, Inc., 10 Joiner St., Charlestown 29, Mass.
- ⓈMEASUREMENTS CORP., Boonton, N. J. ADV. PG. 99.
- ⓈReiner Electronics Co., 152 W. 25th St., New York, N. Y.
- ⓈSouthwestern Industrial Electronics Co., 2831 Post Oak Rd., P. O. Box 13058, Houston 19, Texas.

- ⓈInternational Powder Metallurgy Co., 439 W. Main St., Ridgway, Pa.
- ⓈKEYSTONE CARBON CO., INC., Saint Marys, Pa. ADV. PG. 308.
- ⓈMallory & Co., Inc., P. R., 3029 E. Washington St., Indianapolis 6, Ind.
- ⓈSt. Mary's Carbon Co., State Rd., St. Marys, Pa.
- ⓈSTACKPOLE CARBON CO., St. Marys, Pa. ADV. PG. 170, 171.

METAL PARTS—Screw Machine

- ⓈAce Mfg. Corp., Chalfont, Pa.
- ⓈAllmetal Screw Products Co., Inc., 33 Greene St., New York 13, N. Y.
- ⓈAmerican Laubscher Corp., 333 W. 52nd St., New York 19, N. Y.
- ⓈART-LLOYD METAL PRODUCTS CORP., 2973 Cropsey Ave., Brooklyn 14, N. Y. ADV. PG. 364.
- ⓈAutomatic Metal Products Co., 315 Barry St., Brooklyn, N. Y.
- ⓈAutoscrew Co., 216-222 W. 18th St., New York, N. Y.
- ⓈBARKER & WILLIAMSON, 235 Fairfield Ave., Upper Darby, Pa. ADV. PG. 292.
- ⓈBLAKE & JOHNSON CO., 1495 Thomaston Ave., Waterville 48, Conn. ADV. PG. 279.
- ⓈBassett, Inc., Rex, 307-11 N. W. First Ave., Fort Lauderdale, Fla.
- ⓈBawkins Machine Co., 30 Burtis Ave., New Canaan, Conn.
- ⓈCAMBRIDGE THERMIONIC CORP., 445 Concord Ave., Cambridge 38, Mass. ADV. PG. 37.
- ⓈCITATION PRODUCTS CO., 233 E. 146th St., New York 51, N. Y. ADV. PG. 388.
- ⓈDAGE ELECTRIC CO., 4007 E. Michigan Ave., Indianapolis 1, Ind. ADV. PG. 405.
- ⓈDelco Radio Div., General Motors Corp., Kokomo, Ind.
- ⓈEastern Specialty Co., Philadelphia 40, Pa.
- ⓈEdwards Co., Inc., 86 Boston Post Rd., Norwalk, Conn.
- ⓈElectro Craft Inc., 52 Davenport St., Stamford, Conn.
- ⓈENGINEERING CO., 27 Wright St., Newark 11, N. J. ADV. PG. 370.
- ⓈFEDERAL SCREW PRODUCTS, INC., 224 W. Huron St., Chicago 10, Ill. ADV. PG. 76.
- ⓈGadgets, Inc., 3629 N. Dixie Drive, Dayton 4, Ohio.
- ⓈGeneral Cement Mfg. Co., 919 Taylor Ave., Rockford, Ill.
- ⓈHAYDU BROTHERS, Plainfield, N. J. ADV. PG. 55.
- ⓈInstrument Parts Corp., P. O. 150, Ossining, N. Y.
- ⓈInsuline Corp. of America, 36-02 35th Ave., Long Island City, N. Y.
- ⓈJudd Co., H. L., 87 Chambers St., New York 7, N. Y.
- ⓈKeystone Electronics Corp., 423 Broome St., New York 12, N. Y.
- ⓈKupfrian Mfg. Co., 218 Prospect Ave., Binghamton, N. Y.
- ⓈLa Magna Mfg. Co., Inc., East Rutherford, N. J.
- ⓈMolded Insulation Co., 335 E. Price St., Philadelphia 44, Pa.
- ⓈNational Tel-Tronics Corp., 35 St. Casmirs Ave., Yonkers, N. Y.
- ⓈPlume & Atwood Mfg. Co., 220 Broadway, New York, N. Y.
- ⓈQUAKER CITY GEAR WORKS, 1908-32 N. Front St., Philadelphia 22, Pa. ADV. PG. 166.
- ⓈScovill Mfg. Co., Industrial Fastener Div., Waterbury, Conn.
- ⓈSmith, Inc., Herman H., 436 18th St., Brooklyn 15, N. Y.
- ⓈStimpson Co., Inc., Edwin B., 74 Franklin Ave., Brooklyn 5, N. Y.
- ⓈSYLVANIA ELECTRIC PRODUCTS, INC., 1740 Broadway, New York 19, N. Y. ADV. PG. 432-436.
- ⓈTorgren Co., Inc., C. W., 236 Pearl St., Somerville 45, Mass.
- ⓈTitan Metal Mfg. Co., Bellefonte, Pa.
- ⓈUnited-Carr Fastener Corp., Cambridge 42, Mass.
- ⓈUnited Screw & Bolt Corp., 2513 W. Cullerton St., Chicago 8, Ill.
- ⓈVitamite Co., 227 W. 64th St., New York 23, N. Y.
- ⓈWALTHAM HOROLOGICAL CORP., Waltham, Mass. ADV. PG. 409.
- ⓈWaltham Screw Co., 77 Rumford Ave., Waltham, Mass.

METAL PARTS—Small Metal Stampings

- ⓈABALON PRECISION MFG. CORP., 540 Casanova St., Bronx 59, N. Y. ADV. PG. 348.
- ⓈAccurate Spring Mfg. Co., 3811 W. Lake St., Chicago, Ill.
- ⓈAce Mfg. Corp., Chalfont, Pa.
- ⓈAcme Electric Heating Co., 1217 Washington St., Boston, Mass.
- ⓈAcklin Stamping Co., 1923 Nebraska Ave., Toledo 7, Ohio.
- ⓈAEROLITE ELECTRONIC HARDWARE CORP., 507 26th St., Union City, N. J. ADV. PG. 355.
- ⓈALDEN PRODUCTS CO., 117 No. Main St., Brockton 64, Mass. ADV. PG. 327.
- ⓈAMERICAN BRASS CO., 25 Broadway, New York 4, N. Y. ADV. PG. 330.
- ⓈAmerican Laubscher Corp., 333 W. 52nd St., New York 19, N. Y.
- ⓈAmerican Nut & Bolt Fastener Co., 2045 Doerr St., Pittsburgh 33, Pa.

- ⓈAmol Precision Corp., Dumont, N. J.
- ⓈART-LLOYD METAL PRODUCTS CORP., 2973 Cropsey Ave., Brooklyn 14, N. Y. ADV. PG. 364.
- ⓈART WIRE & STAMPING CO., 227 High St., Newark 2, N. J. ADV. PG. 38.
- ⓈAuburn Mfg. Co., Pease Ave. & Stack St., Middletown, Conn.
- ⓈAutomatic Metal Products Co., 315 Barry St., Brooklyn 1, N. Y.
- ⓈBARKER & WILLIAMSON, 235 Fairfield Ave., Upper Darby, Pa. ADV. PG. 292.
- ⓈBassett, Inc., Rex, 307-11 N. W. First Ave., Fort Lauderdale, Fla.
- ⓈBerndt-Bach, Inc., 7373 Beverly Blvd., Los Angeles 36, Calif.
- ⓈChase Brass & Copper Co., Inc., 236 Grand St., Waterbury 20, Conn.
- ⓈCINCH MFG. CORP., 1026 S. Homan Ave., Chicago 24, Ill. ADV. PG. 186, 187.
- ⓈCITATION PRODUCTS CO., 233 E. 146th St., New York 51, N. Y. ADV. PG. 388.
- ⓈColgate Mfg. Corp., Lindenhurst, N. Y.
- ⓈColumbia Metal Box Co., 260 E. 143rd St., New York, N. Y.
- ⓈCRAFT MFG. CO., 3949 W. Schubert St., Chicago, Ill. ADV. PG. 128.
- ⓈCrescent Industries, Inc., 4140 Belmont Ave., Chicago 41, Ill.
- ⓈCutler Metal Products Co., 1025 Line St., Camden, N. J.
- ⓈDante Electric Mfg. Co., Bantham, Conn.
- ⓈDelco Radio Div., General Motors Corp., Kokomo, Ind.
- ⓈDonnelly Electric & Mfg. Co., 3050 Washington St., Boston 19, Mass.
- ⓈEastern Specialty Co., Philadelphia 40, Pa.
- ⓈEBY, INC., HUGH H., 4700 Stenton Ave., Philadelphia 44, Pa. ADV. PG. 214.
- ⓈEdwards Co., Inc., 86 Boston Post Rd., Norwalk, Conn.
- ⓈElectro Craft Inc., 52 Davenport St., Stamford, Conn.
- ⓈElectronic Mfg. Co., 20 Orange St., Newark, N. J.
- ⓈENGINEERING CO., 27 Wright St., Newark, N. J. ADV. PG. 370.
- ⓈEtched Products Corp., 39-01 Queens Blvd., Long Island City, N. Y.
- ⓈFederal Tool & Mfg. Co., 3600 Alabama Ave., St. Louis Park, Minneapolis 16, Minn.
- ⓈFelt Products Mfg. Co., 1504 W. Carroll Ave., Chicago 7, Ill.
- ⓈFLOCK PROCESS CO., INC., 28 Fahey St., Springfield, Conn. ADV. PG. 196.
- ⓈFRANKLIN AIRLOOP CORP., 43-20 34th St., Long Island City, N. Y. ADV. PG. 45.
- ⓈFRANKLIN MFG. CORP., A. W., 43-20 34th St., Long Island City, N. Y. ADV. PG. 44.
- ⓈFrying Mfg. Co., 639 W. 12th St., Erie, Pa.
- ⓈGarrett Co., Inc., George K., D and Tioga Sts., Philadelphia 34, Pa.
- ⓈGasket Engineering Co., 2440 Charlotte St., Kansas City 8, Mo.
- ⓈGENERAL ACCESSORIES CO., LTD., 366 Madison Ave., New York 17, N. Y. ADV. PG. 336.
- ⓈGeneral Cement Mfg. Co., 919 Taylor Ave., Rockford, Ill.
- ⓈGoat Co., Inc., Fred, 314 Dean St., Brooklyn, N. Y.
- ⓈGreene Mfg. Corp., G. G., Warren, Pa.
- ⓈGRIEVE-HENDRY CO., 1101 N. Paulina St., Chicago 22, Ill. ADV. PG. 346.
- ⓈHAYDU BROTHERS, Plainfield, N. J. ADV. PG. 55.
- ⓈHELDOR MFG. CO., Div. of Heldor Bushing & Terminal Inc., 225 Belleville Ave., Bloomfield, N. J. ADV. PG. 242.
- ⓈHEYMAN MFG. CO., 300 Michigan Ave., Kenilworth, N. J. ADV. PG. 381.
- ⓈINDUSTRIAL HARDWARE MFG. CO., INC., 109 Prince St., New York, N. Y. ADV. PG. 360.
- ⓈIndustrial Precision Products Co., 315-325 N. Hoynes Ave., Chicago 12, Ill.
- ⓈInsuline Corp. of America, 36-02 35th Ave., Long Island City, N. Y.
- ⓈJavex, 921 State, Garland, Texas.
- ⓈJohanson Mfg. Co., Boonton, N. J.
- ⓈJOHNSON & HOFFMAN, INC., 65 Ongley St., Rockville Center, N. Y. ADV. PG. 353.
- ⓈJudd Co., H. L., 87 Chambers St., New York 7, N. Y.
- ⓈKeystone Electronics Corp., 423 Broome St., New York 12, N. Y.
- ⓈKing Laboratories, Inc., 127 Solar St., Syracuse 4, N. Y.
- ⓈKling Metal Spinning Co., 174 Centre St., New York 13, N. Y.
- ⓈKolton Electric Mfg. Co., 123 New Jersey Railroad Ave., Newark 5, N. J.
- ⓈKULKA ELECTRIC MFG. CO., 30 South St., Mount Vernon, N. Y. ADV. PG. 317.
- ⓈLa Magna Mfg. Co., Inc., East Rutherford, N. J.
- ⓈLEE MECHANICAL LABS. DIV. OF LEE SPRING CO., INC., 30 Main St., Brooklyn 1, N. Y. ADV. PG. 303.
- ⓈLorentzen Inc., Levolver, 391 W. Broadway, New York, N. Y.
- ⓈMagna Electronics Co., 3707-11 W. Jefferson Blvd., Los Angeles 16, Calif.
- ⓈMETHODE MFG. CORP., 2265 W. St. Paul Ave., Chicago 47, Ill. ADV. PG. 347.
- ⓈMinute Man Products, Inc., 430 E. 102nd St., New York, N. Y.

METAL CONES, TELEVISION
See Cones, Metal Television

METAL PARTS—Bushings

- ⓈAEROLITE ELECTRONIC HARDWARE CORP., 507 26th St., Union City, N. J. ADV. PG. 355.
- ⓈAmplex Division, Chrysler Corp., Detroit 31, Mich.
- ⓈBARKER & WILLIAMSON, 235 Fairfield Ave., Upper Darby, Pa. ADV. PG. 292.
- ⓈBEAD CHAIN MFG. CO., 110 Mountain Grove St., Bridgeport 5, Conn. ADV. PG. 136.
- ⓈCAMBRIDGE THERMIONIC CORP., 445 Concord Ave., Cambridge 38, Mass. ADV. PG. 37.
- ⓈChase Brass & Copper Co., Inc., 236 Grand St., Waterbury 20, Conn.
- ⓈCITATION PRODUCTS CO., 233 E. 146th St., New York 51, N. Y. ADV. PG. 388.
- ⓈDelco Radio Div., General Motors Corp., Kokomo, Ind.
- ⓈFEDERAL SCREW PRODUCTS, INC., 224 W. Huron St., Chicago 10, Ill. ADV. PG. 76.
- ⓈGadgets, Inc., 3629 N. Dixie Drive, Dayton 4, Ohio.
- ⓈGeneral Cement Mfg. Co., 919 Taylor Ave., Rockford, Ill.
- ⓈIndustrial Precision Products Co., 315-325 N. Hoynes Ave., Chicago 12, Ill.
- ⓈKEYSTONE CARBON CO., INC., Saint Marys, Pa. ADV. PG. 308.
- ⓈNATIONAL CO., INC., 61 Sherman St., Malden 48, Mass. ADV. PG. 280, 281.
- ⓈPIX MFG. CO., INC., 24 Bedford St., Newark, N. J. ADV. PG. 136.
- ⓈPrecision Devices, Inc., 147-149 Cedar St., New York 6, N. Y.
- ⓈSt. Mary's Carbon Co., State Rd., St. Marys, Pa.
- ⓈSmith, Inc., Herman H., 436 18th St., Brooklyn 15, N. Y.
- ⓈSYLVANIA ELECTRIC PRODUCTS, INC., 1740 Broadway, New York 19, N. Y. ADV. PG. 432-436.

METAL PARTS—Contacts
See Contacts, Electrical

METAL PARTS—Laminated

- ⓈAmerican Cladmetals Co., P. O. Box 544, Carnegie, Pa.
- ⓈBRAININ CO., C. S., 320 Washington St., Mt. Vernon, N. Y. ADV. PG. 142.
- ⓈPIX MFG. CO., INC., 24 Bedford St., Newark, N. J. ADV. PG. 136.
- ⓈStandard Metals Corp., 262 Broad St., North Attleboro, Mass.
- ⓈTricon Mfg. Co., 8318 S. Racine Ave., Chicago, Ill.

METAL PARTS—Lead

- ⓈAlpha Metals, Inc., 365 Hudson Ave., Brooklyn 1, N. Y.
- ⓈANCHOR METAL CO., 87 Walker St., New York 13, N. Y. ADV. PG. 270.
- ⓈNational Lead Co., 111 Broadway, New York 6, N. Y.
- ⓈPIX MFG. CO., INC., 24 Bedford St., Newark, N. J. ADV. PG. 136.
- ⓈPrecision Devices, Inc., 147-149 Cedar St., New York 6, N. Y.
- ⓈRomac Products Co., 112 Bleecker St., New York 12, N. Y.
- ⓈSTAVER CO., INC., Box 431, Bayshore, N. Y. ADV. PG. 232.
- ⓈVitamite Co., 227 W. 64th St., New York 23, N. Y.

METAL PARTS—Powdered

- ⓈAmplex Division, Chrysler Corp., Detroit 31, Mich.
- ⓈCROWLEY & CO., INC., Henry L., 1 Central Ave., West Orange, N. J. ADV. PG. 231.

Ⓜ indicates . . . IN PRODUCTION • AVAILABILITY • UNRESTRICTED FOR GENERAL USE

- Ⓜ Molded Insulation Co., 335 E. Price St., Philadelphia 44, Pa.
- Ⓜ MULTI METAL CO., 1350 Garrison St., New York 59, N. Y. ADV. PG. 221.
- Ⓜ National Tel-Tronics Corp., 35 St. Casmirs Ave., Yonkers, N. Y.
- Ⓜ OLYMPIC METAL PRODUCTS CO., INC., Phillipsburg, N. J. ADV. PG. 358.
- Ⓜ Paul & Beekman Inc., 1801 Cortland St., Philadelphia 40, Pa.
- Ⓜ Penn Fibre & Specialty Co., 2020 E. Westmoreland St., Philadelphia 44, Pa.
- Ⓜ Pilot Radio Corp., 37-06 36th St., Long Island City 1, N. Y.
- Ⓜ PIX MFG. CO., INC., 24 Bedford St., Newark, N. J. ADV. PG. 136.
- Ⓜ Plume & Atwood Mfg. Co., 220 Broadway, New York, N. Y.
- Ⓜ Precision Devices, Inc., 147-149 Cedar St., New York 6, N. Y.
- Ⓜ Quadriga Mfg. Co., 213 W. Grand Ave., Chicago 11, Ill.
- Ⓜ Raymond Mfg. Co., Div. of Associated Spring Corp., 226 S. Center St., Corry, Pa.
- Ⓜ Repath Co., Paul R., 641 E. 61st St., Los Angeles 1, Calif.
- Ⓜ Revere Copper & Brass, Inc., 230 Park Ave., New York 17, N. Y.
- Ⓜ Romac Products Co., 112 Bleeker St., New York 12, N. Y.
- Ⓜ Scovill Mfg. Co., Industrial Fastener Div., Waterbury, Conn.
- Ⓜ Serdex, Inc., 91 Cambridge St., Boston, Mass.
- Ⓜ Smith, Inc., Herman H., 436 18th St., Brooklyn 15, N. Y.
- Ⓜ Sperti Inc., Norwood Station, Cincinnati 12, Ohio.
- Ⓜ Spincraft, Inc., 4143 W. State St., Milwaukee 8, Wis.
- Ⓜ STAVER CO., INC., Box 431, Bayshore, N. Y. ADV. PG. 232.
- Ⓜ Stewart Stamping Co., 630 Central Park Ave., Yonkers 4, N. Y.
- Ⓜ Stimpson Co., Inc., Edwin, 74 Franklin Ave., Brooklyn 5, N. Y.
- Ⓜ SYLVANIA ELECTRIC PRODUCTS, INC., 1740 Broadway, New York 19, N. Y. ADV. PG. 432-436.
- Ⓜ TECHNICAL APPLIANCE CORP., Sherburne, N. Y. ADV. PG. 378.
- Ⓜ Timmerman Products Inc., P. O. Box 668, Dept. No. 16, Cleveland 1, Ohio.
- Ⓜ Torngren Co., Inc., C. W., 236 Pearl St., Somerville 45, Mass.
- Ⓜ Tricon Mfg. Co., 8318 S. Racine Ave., Chicago, Ill.
- Ⓜ Tricraft Products Co., 1535 N. Ashland Ave., Chicago 22, Ill.
- Ⓜ Ucinite Co. Division, United-Carr Fastener Corp., 459 Watertown St., Newtonville, Mass.
- Ⓜ United Carr Fastener Corp., Cambridge 42, Mass.
- Ⓜ United Screw & Bolt Corp., 2513 W. Cullerton St., Chicago 8, Ill.
- Ⓜ Vitamite Co., 227 W. 64th St., New York 23, N. Y.
- Ⓜ VOLKERT METAL STAMPINGS INC., JOHN, 222-34 96th Ave., Queens Village, N. Y. ADV. PG. 313.
- Ⓜ Walter Co., Inc., S., 1400 Atlantic Ave., Brooklyn 16, N. Y.
- Ⓜ WALTHAM HOROLOGICAL CORP., Waltham, Mass. ADV. PG. 407.
- Ⓜ Whitehead Stamping Co., 1691 W. Lafayette Blvd., Detroit 16, Mich.
- Ⓜ Worcester Pressed Aluminum Corp., 13-15 Hope Ave., Worcester 3, Mass.
- Ⓜ Wrought Washer Mfg. Co., 2264 S. Bay St., Milwaukee 7, Wis.
- Ⓜ Zierick Mfg. Corp., Beechwood and Rockdale Aves., New Rochelle, N. Y.

METAL PARTS—Spinnings

- Ⓜ Electronic Mfg. Co., 20 Orange St., Newark, N. J.
- Ⓜ GENERAL ACCESSORIES CO., LTD., 366 Madison Ave., New York 17, N. Y. ADV. PG. 336.
- Ⓜ HAYDU BROTHERS, Plainfield, N. J. ADV. PG. 55.
- Ⓜ Industrial Precision Products Co., 315-325 N. Hoyne Ave., Chicago 12, Ill.
- Ⓜ Kling Metal Spinning Co., 174 Centre St., New York 13, N. Y.
- Ⓜ Newark Spinning & Stamping Co., 472 Bloy St., Hillside 5, N. J.
- Ⓜ Spincraft, Inc., 4143 W. State St., Milwaukee 8, Wis.
- Ⓜ SYLVANIA ELECTRIC PRODUCTS, INC., 1740 Broadway, New York 19, N. Y. ADV. PG. 432-436.
- Ⓜ Teiner Co., Inc., Roland, 134 Tremont St., Everett 49, Mass.
- Ⓜ Teiner Engineering Corp., 115 Madison St., Malden, Mass.
- Ⓜ Torngren Co., Inc., C. W., 236 Pearl St., Somerville 45, Mass.

METAL PARTS—Trimings

- Ⓜ GENERAL ACCESSORIES CO., LTD., 366 Madison Ave., New York 17, N. Y. ADV. PG. 336.
- Ⓜ Industrial Precision Products Co., 315-325 N. Hoyne Ave., Chicago 12, Ill.
- Ⓜ PIX MFG. CO., INC., 24 Bedford St., Newark, N. J. ADV. PG. 136.
- Ⓜ SYLVANIA ELECTRIC PRODUCTS, INC., 1740 Broadway, New York 19, N. Y. ADV. PG. 432-436.

METALLIC PAINTS

See Paints

METALS

Aluminum

- Ⓜ Aluminum Co. of America, Gulf Bldg., Pittsburgh 30, Pa.
- Ⓜ Federated Metals Div. American Smelting & Refining Co., 120 Broadway, New York 5, N. Y.
- Ⓜ Kaiser Aluminum & Chemical Sales, Inc., 1924 Broadway, Oakland 12, Calif.
- Ⓜ North American Philips Co., Inc., 100 E. 42nd St., New York 17, N. Y.
- Ⓜ Revere Copper & Brass, Inc., 230 Park Ave., New York 17, N. Y.

Alnico

- Ⓜ Arnold Engineering Co., Marengo, Ill.
- Ⓜ CARBOLOY COMPANY, INC., 11139 E. Eight Mile Blvd., Detroit 32, Mich. ADV. PG. 23.
- Ⓜ Murex, Ltd., Rainham, Essex, England.
- Ⓜ Simmonds Saw & Steel Co., Lockport, N. Y.
- Ⓜ THOMAS & SKINNER STEEL PRODUCTS CO., 1122 E. 23rd St., Indianapolis, Ind., ADV. PG. 403.

Antimony

- Ⓜ ANCHOR METAL CO., 87 Walker St., New York 13, N. Y. ADV. PG. 270.
- Ⓜ Division Lead Co., 836 W. Kinzie St., Chicago 22, Ill.
- Ⓜ Federated Metals Div., American Smelting & Refining Co., 120 Broadway, New York 5, N. Y.

Barium

- Ⓜ KING LABORATORIES, INC., 127 Solar St., Syracuse 4, N. Y. ADV. PG. 395.

Beryllium and Beryllium Alloys

- Ⓜ Beryllium Corp., The, Reading, Pa.
- Ⓜ Brush Beryllium Co., The, 4301 Perkins Ave., Cleveland 3, Ohio.
- Ⓜ DRIVER CO., WILBUR B., 150 Riverside Ave., Newark 4, N. J. ADV. PG. 189.
- Ⓜ GENERAL PLATE DIVISION, Metals & Controls Corp., Attleboro, Mass. ADV. PG. 300.
- Ⓜ Mallory & Co., Inc., P. R., 3029 E. Washington St., Indianapolis 6, Ind.
- Ⓜ Standard Metals Corp., 262 Broad St., North Attleboro, Mass.

Brass and Bronze

- Ⓜ AMERICAN BRASS CO., 25 Broadway, New York 4, N. Y. ADV. PG. 330.
- Ⓜ Bridgeport Brass Co., 30 Grand St., Bridgeport, Conn.
- Ⓜ Chase Brass & Copper Co., Inc., 236 Grand St., Waterbury 20, Conn.
- Ⓜ Federated Metals Div., American Smelting & Refining Co., 120 Broadway, New York 5, N. Y.
- Ⓜ Mallory & Co., Inc., P. R., 3029 E. Washington St., Indianapolis 6, Ind.
- Ⓜ Phosphor Bronze Corp., 20 Franklin St., Seymour, Conn.
- Ⓜ Plume & Atwood Mfg. Co., 220 Broadway, New York, N. Y.
- Ⓜ Revere Copper & Brass, Inc., 230 Park Ave., New York 17, N. Y.
- Ⓜ Standard Metals Corp., 262 Broad St., North Attleboro, Mass.

Cadmium

- Ⓜ Division Lead Co., 836 W. Kinzie St., Chicago 22, Ill.
- Ⓜ Federated Metals Div., American Smelting & Refining Co., 120 Broadway, New York 5, N. Y.
- Ⓜ Mallory & Co., Inc., P. R., 3029 E. Washington St., Indianapolis 6, Ind.
- Ⓜ Merck & Co., Inc., Rahway, N. J.

Cesium Compounds

(For Photo-tubes)

- Ⓜ Foote Mineral Co., 18 W. Chelton Ave., Philadelphia 44, Pa.
- Ⓜ KING LABORATORIES, INC., 127 Solar St., Syracuse 4, N. Y. ADV. PG. 395.

Chromium

- Ⓜ Carpenter Steel Co., The, 142 West Bern St., Reading, Pa.
- Ⓜ Electro Metallurgical Division, Union Carbide & Carbon Corp., 30 E. 42nd St., New York 17, N. Y.
- Ⓜ Foote Mineral Co., 18 W. Chelton Ave., Philadelphia 44, Pa.
- Ⓜ Metal Hydrides, Inc., Beverly, Mass.
- Ⓜ Murex, Ltd., Rainham, Essex, England.

Coefficient Metals

- Ⓜ Carpenter Steel Co., The, 142 W. Bern St., Reading, Pa.
- Ⓜ DRIVER-HARRIS CO., 201 Middlesex St., Harrison, N. J. ADV. PG. 131.
- Ⓜ Metal Hydrides, Inc., Beverly, Mass.

- Ⓜ Simmonds Saw & Steel Co., Lockport, N. Y.
- Ⓜ STUPAKOFF CERAMIC & MFG. CO., Latrobe, Pa. ADV. PG. 167.

Columbium

- Ⓜ Electro Metallurgical Division, Union Carbide & Carbon Corp., 30 E. 42nd St., New York 17, N. Y.
- Ⓜ Fansteel Metallurgical Corp., 2200 Sheridan Rd., North Chicago, Ill.
- Ⓜ Metal Hydrides, Inc., Beverly, Mass.
- Ⓜ Murex, Ltd., Rainham, Essex, England.

Copper

- Ⓜ AMERICAN BRASS CO., 25 Broadway, New York 4, N. Y. ADV. PG. 330
- Ⓜ Bridgeport Brass Co., 30 Grand St., Bridgeport, Conn.
- Ⓜ Chase Brass & Copper Co., Inc., 236 Grand St., Waterbury 20, Conn.
- Ⓜ Division Lead Co., 836 W. Kinzie St., Chicago 22, Ill.
- Ⓜ Federated Metals Div., American Smelting & Refining Co., 120 Broadway, New York 5, N. Y.
- Ⓜ Mallory & Co., Inc., P. R., 3029 E. Washington St., Indianapolis 6, Ind.
- Ⓜ North American Philips Co., 100 E. 42nd St., New York 17, N. Y.
- Ⓜ Plume & Atwood Mfg. Co., 220 Broadway, New York, N. Y.
- Ⓜ Revere Copper & Brass Inc., 230 Park Ave., New York 17, N. Y.
- Ⓜ Standard Metals Corp., 262 Broad St., North Attleboro, Mass.

Electric Sheets—See Steel, Electric

Foil-Aluminum, Tin & Lead

- Ⓜ Alpha Metals, Inc., 365 Hudson Ave., Brooklyn 1, N. Y.
- Ⓜ Aluminum Co. of America, Gulf Bldg., Pittsburgh 30, Pa.
- Ⓜ ANCHOR METAL CO., 87 Walker St., New York 13, N. Y. ADV. PG. 270.
- Ⓜ Federated Metals Div., American Smelting & Refining Co., 120 Broadway, New York 5, N. Y.
- Ⓜ Johnston Foil Mfg. Co., 6100 S. Broadway, St. Louis 11, Mo.
- Ⓜ Kaiser Aluminum & Chemical Sales, Inc., 1924 Broadway, Oakland 12, Calif.
- Ⓜ REPUBLIC FOIL & METAL MILLS, INC., 55 Triangle St., Danbury, Conn. ADV. PG. 370.

Gold and Gold Alloys

- Ⓜ AMERICAN PLATINUM WORKS, N. J. R. R. Ave. at Oliver St., Newark 5, N. J. ADV. PG. 76.
- Ⓜ Baker & Co., Inc., 113 Astor St., Newark 5, N. J.
- Ⓜ BRAININ CO., C. S., 320 Washington St. Mount Vernon, N. Y. ADV. PG. 142.
- Ⓜ Eastern Smelting & Refining Corp., 107-109 W. Brookline St., Boston 18, Mass.
- Ⓜ GENERAL PLATE DIVISION, METALS & CONTROLS CORP., Attleboro, Mass. ADV. PG. 300.
- Ⓜ Goldsmith Bros. Smelting & Refining Co., 111 N. Wabash Ave., Chicago 2, Ill.
- Ⓜ Handy & Harman, 82 Fulton St., New York 38, N. Y.
- Ⓜ Linick Chemical Co., 29 E. Madison St., Chicago 2, Ill.
- Ⓜ MAKEPEACE CO., D. E., Attleboro, Mass. ADV. PG. 72.
- Ⓜ Mallory & Co., Inc., P. R., 3029 E. Washington St., Indianapolis 6, Ind.
- Ⓜ NEY CO., J. M., 179 Elm St., Hartford, Conn. ADV. PG. 246.
- Ⓜ Secon Metals Corp., 228 E. 45th St., New York 17, N. Y.
- Ⓜ Standard Metals Corp., 262 Broad St., North Attleboro, Mass.
- Ⓜ Western Gold & Platinum Works, 589 Bryant St., San Francisco, Calif.
- Ⓜ Wildberg Bros. Smelting & Refining Co., 742 Market St., San Francisco 2, Calif.
- Ⓜ Wilson Co., H. A., The, 105 Chestnut St., Newark 5, N. J.

High Permeability Alloys

- Ⓜ Allegheny Ludlum Steel Corp., H. W. Oliver Bldg., Pittsburgh 22, Pa.
- Ⓜ Alloy Metal Wire Co., 13th and Penna Ave., Prospect Park, Pa.
- Ⓜ Armco Steel Corp., 703 Curtis St., Middletown, Ohio.
- Ⓜ Arnold Engineering Co., Marengo, Ill.
- Ⓜ Carpenter Steel Co., The, 142 W. Bern St., Reading, Pa.
- Ⓜ CROWLEY CO., INC., HENRY L., 1 Central Ave., West Orange, N. J. ADV. PG. 231.
- Ⓜ DRIVER-HARRIS CO., 201 Middlesex St., Harrison, N. J. ADV. PG. 131.
- Ⓜ Mallory & Co., Inc., P. R., 3029 E. Washington St., Indianapolis 6, Ind.
- Ⓜ Simmonds Saw & Steel Co., Lockport, N. Y.
- Ⓜ Standard Telephones & Cables Ltd., Connaught House, Aldwych, London, W. C. 2, England.

V indicates . . . **IN PRODUCTION • AVAILABILITY • UNRESTRICTED FOR GENERAL USE**

WESTINGHOUSE ELECTRIC CORP., 511 Wood St., P.O. Box 868, Pittsburgh 30, Pa. ADV. PG. 107-113.

Laminated Metal Parts

- Ⓢ American Cladmetals Co., P. O. Box 544, Carnegie, Ill.
- Ⓢ Baker Co., Inc., 113 Astor St., Newark 5, N. J.
- Ⓢ BRAININ CO., C. S., 320 Washington St., Mount Vernon, N. Y. ADV. PG. 142.
- Ⓢ Eastern Smelting & Refining Corp., 107-109 W. Brookline St., Boston 18, Mass.
- Ⓢ IMPROVED SEAMLESS WIRE CO., 775 Eddy St., Providence, R. I. ADV. PG. 314.
- Ⓢ MAKEPEACE CO., D. E., Attleboro, Mass. ADV. PG. 72.
- Ⓢ Standard Metals Corp., 262 Broad St., North Attleboro, Mass.
- Ⓢ THOMAS & SKINNER STEEL PRODUCTS CO., 1123 E. 23rd St., Indianapolis, Ind. ADV. PG. 403.
- Ⓢ Tricon Mfg. Co., 8318 S. Racine Ave., Chicago, Ill.
- Ⓢ Wilson Co., H. A. The, 105 Chestnut St., Newark 5, N. J.

Lead

- Ⓢ Alpha Metals, Inc., 365 Hudson Ave., Brooklyn 1, N. Y.
- Ⓢ ANCHOR METAL CO., 87 Walker St., New York 13, N. Y. ADV. PG. 270.
- Ⓢ Bar-Ray Products, Inc., 209 25th St., Brooklyn 32, N. Y.
- Ⓢ Division Lead Co., 836 W. Kinzie St., Chicago 22, Ill.
- Ⓢ Federated Metals Div., American Smelting & Refining Co., 120 Broadway, New York 5, N. Y.
- Ⓢ National Lead Co., 111 Broadway, New York 6, N. Y.

Lithium Compounds (for cathode tube screen setting)

- Ⓢ Merck & Co., Inc., Rahway, N. J.

Magnesium

- Ⓢ Dow Chemical Co., Midland, Mich.
- Ⓢ Federated Metals Div., American Smelting & Refining Co., 120 Broadway, New York 5, N. Y.

Magnetic Iron Oxide (for cores)

- Ⓢ CROWLEY CO., INC., HENRY L., 1 Central Ave., West Orange, N. J. ADV. PG. 231.
- Ⓢ Mallory & Co., Inc., P. R., 3029 E. Washington St., Indianapolis 6, Ind.
- Ⓢ NATIONAL MOLDITE CO., 1410 Chestnut Ave., Hillside 5, N. J. ADV. PG. 232.
- Ⓢ Plastic Metals Division, National Radiator Co., 169 Bridge St., Johnstown, Pa.
- Ⓢ Williams & Co., C. K., 2001 Lynch Ave., East St. Louis, Ill.

Magnetostriction

See Nicksels and Nickel Alloys

Manganese

- Ⓢ Electro Metallurgical Division, Union Carbide and Carbon Corp., 30 E. 42nd St., New York 17, N. Y.
- Ⓢ Foote Mineral Co., 18 W. Chelton Ave., Philadelphia 44, Pa.
- Ⓢ Murex, Ltd., Rainham, Essex, England.

Mercury

- Ⓢ Central Scientific Co., 1700 Irving Park Rd., Chicago 13, Ill.
- Ⓢ Division Lead Co., 836 W. Kinzie St., Chicago 22, Ill.
- Ⓢ Eastern Smelting & Refining Corp., 107-109 W. Brookline St., Boston 18, Mass.
- Ⓢ Goldsmith Bros. Smelting & Refining Co., 111 N. Wabash Ave., Chicago 2, Ill.
- Ⓢ Mallinckrodt Chemical Works, Second & Mallinckrodt Sts., St. Louis 7, Mo.
- Ⓢ Merck & Co., Inc., Rahway, N. J.
- Ⓢ Wildberg Bros. Smelting & Refining Co., 742 Market St., San Francisco 2, Calif.

Molybdenum

- Ⓢ CROSS CO., H., 15 Beekman St., New York, N. Y. ADV. PG. 384.
- Ⓢ EISLER ENGINEERING CO., INC., 740 S. 13th St., Newark 3, N. J. ADV. PG. 378.
- Ⓢ Electro Metallurgical Division, Union Carbide & Carbon Corp., 30 E. 42nd St., New York 17, N. Y.
- Ⓢ Fansteel Metallurgical Corp., 2200 Sheridan Rd., North Chicago, Ill.
- Ⓢ Mallory & Co., Inc., P. R., 3029 E. Washington St., Indianapolis 6, Ind.
- Ⓢ Murex, Ltd., Rainham-Essex-England.
- Ⓢ North American Philips Co., Inc., 100 E. 42nd St., New York 17, N. Y.
- Ⓢ Wilson Co., H. A., The, 105 Chestnut St., Newark 5, N. J.

Monel

- Ⓢ Alloy Metal Wire Co., 13th & Penna Ave., Prospect Park, Pa.
- Ⓢ DRIVER CO., WILBUR B., 150 Riverside Ave., Newark, N. J. ADV. PG. 189.
- Ⓢ DRIVER-HARRIS CO., 201 Middlesex St., Harrison, N. J. ADV. PG. 131.
- Ⓢ International Nickel Co., Inc., 67 Wall St., New York 5, N. Y.
- Ⓢ Mallory & Co., Inc., P. R., 3029 E. Washington St., Indianapolis 6, Ind.
- Ⓢ Standard Metals Corp., 262 Broad St., North Attleboro, Mass.

Nickel and Nickel Alloys

- Ⓢ Allegheny Ludlum Steel Corp., H. W. Oliver Bldg., Pittsburgh 22, Pa.
- Ⓢ Alloy Metal Wire Co., 13th & Penna. Ave., Prospect Park, Pa.
- Ⓢ AMERICAN BRASS CO., 25 Broadway, New York 4, N. Y. ADV. PG. 330.
- Ⓢ Bridgeport Brass Co., 30 Grand St., Bridgeport, Conn.
- Ⓢ Carpenter Steel Co., The, 142 W. Bern St., Reading, Pa.
- Ⓢ DRIVER CO., WILBUR B., 150 Riverside Ave., Newark 4, N. J. ADV. PG. 189.
- Ⓢ DRIVER-HARRIS CO., 201 Middlesex St., Harrison, N. J. ADV. PG. 131.
- Ⓢ Haynes Stellite Division, Union Carbide and Carbon Corp., Kokomo, Indiana.
- Ⓢ International Nickel Co., Inc., 67 Wall St., New York 5, N. Y.
- Ⓢ Mallory & Co., Inc., P. R., 3029 E. Washington St., Indianapolis 6, Ind.
- Ⓢ Phosphor Bronze Corp., 20 Franklin St., Seymour, Conn.
- Ⓢ Simmonds Saw & Steel Co., Lockport, N. Y.
- Ⓢ Standard Metals Corp., 262 Broad St., North Attleboro, Mass.
- Ⓢ Revere Copper & Brass, Inc., 230 Park Ave., New York 17, N. Y.

Nickel Ribbon

- Ⓢ Alloy Metal Wire Co., 13th & Penna. Ave., Prospect Park, Pa.
- Ⓢ COHN CORP., SIGMUND, 44 Gold St., New York 7, N. Y. ADV. PG. 278.
- Ⓢ DRIVER CO., WILBUR B., 150 Riverside Ave., Newark, N. J. ADV. PG. 189.
- Ⓢ DRIVER-HARRIS CO., 201 Middlesex St., Harrison, N. J. ADV. PG. 131.
- Ⓢ Secon Metals Corp., 228 E. 45th St., New York 17, N. Y.

Palladium

- Ⓢ AMERICAN PLATINUM WORKS, N. J. R. R. Ave. at Oliver St., Newark 5, N. J. ADV. PG. 76.
- Ⓢ Baker & Co., Inc., 113 Astor St., Newark 5, N. J.
- Ⓢ BRAININ CO., C. S., 320 Washington St., Mount Vernon, N. Y. ADV. PG. 142.
- Ⓢ Eastern Smelting & Refining Corp., 107-109 W. Brookline St., Boston 18, Mass.
- Ⓢ GENERAL PLATE DIVISION, Metals & Controls Corp., Attleboro, Mass. ADV. PG. 300.
- Ⓢ Goldsmith Bros. Smelting & Refining Co., 111 N. Wabash Ave., Chicago 2, Ill.
- Ⓢ MAKEPEACE CO., D. E., Attleboro, Mass. ADV. PG. 72.
- Ⓢ Mallory & Co., Inc., P. R., 3029 E. Washington St., Indianapolis 6, Ind.
- Ⓢ NEY CO., J. M., 179 Elm St., Hartford, Conn. ADV. PG. 246.
- Ⓢ SAMUEL & CO., INC., J. A., 220 Broadway, New York 7, N. Y. ADV. PG. 413.
- Ⓢ Secon Metals Corp., 228 E. 45th St., New York 17, N. Y.
- Ⓢ Western Gold & Platinum Works, 589 Bryant St., San Francisco, Calif.
- Ⓢ Wildberg Bros. Smelting & Refining Co., 742 Market St., San Francisco 2, Calif.
- Ⓢ Wilson Co., H. A., The, 105 Chestnut St., Newark 5, N. J.

Phosphor Bronze

- Ⓢ AMERICAN BRASS CO., 25 Broadway, New York 4, N. Y. ADV. PG. 330.
- Ⓢ Bridgeport Brass Co., 30 Grand St., Bridgeport, Conn.
- Ⓢ Chase Brass & Copper Co., Inc., 236 Grand St., Waterbury 20, Conn.
- Ⓢ KEYSTONE CARBON CO., INC., Saint Marys, Pa. ADV. PG. 308.
- Ⓢ Phosphor Bronze Corp., 20 Franklin St., Seymour, Conn.
- Ⓢ Plume & Atwood Mfg. Co., 220 Broadway, New York, N. Y.
- Ⓢ Revere Copper & Brass, Inc., 230 Park Ave., New York 17, N. Y.
- Ⓢ Standard Metals Corp., 262 Broad St., North Attleboro, Mass.

Platinum

- Ⓢ AMERICAN PLATINUM WORKS, N. J. R. R. Ave. at Oliver St., Newark 5, N. J. ADV. PG. 76.
- Ⓢ Baker Co., Inc., 113 Astor St., Newark 5, N. J.
- Ⓢ BRAININ CO., C. S., 320 Washington St., Mount Vernon, N. Y. ADV. PG. 142.
- Ⓢ COHN CORP., SIGMUND, 44 Gold St., New York 7, N. Y. ADV. PG. 278.
- Ⓢ Eastern Smelting & Refining Corp., 107-109 W. Brookline St., Boston 18, Mass.
- Ⓢ GENERAL PLATE DIVISION, Metals & Controls Corp., Attleboro, Mass. ADV. PG. 300.
- Ⓢ Goldsmith Bros. Smelting & Refining Co., 111 N. Wabash Ave., Chicago 2, Ill.
- Ⓢ Mallory & Co., Inc., P. R., 3029 E. Washington St., Indianapolis 6, Ind.
- Ⓢ NEY CO., J. M., 179 Elm St., Hartford, Conn. ADV. PG. 246.
- Ⓢ SAMUEL & CO., INC., J. A., 220 Broadway, New York 7, N. Y. ADV. PG. 413.
- Ⓢ Secon Metals Corp., 228 E. 45th St., New York 17, N. Y.
- Ⓢ Western Gold & Platinum Works, 589 Bryant St., San Francisco, Calif.
- Ⓢ Wildberg Bros. Smelting & Refining Co., 742 Market St., San Francisco 2, Calif.
- Ⓢ Wilson Co., H. A., The, 105 Chestnut St., Newark 5, N. J.

Polonium

- Ⓢ Canadian Radium & Uranium Corp., 630 Fifth Ave., New York 20, N. Y.
- Ⓢ U. S. Radium Corp., 535 Pearl St., New York 7, N. Y.

Powdered

- Ⓢ Amplex Div., Chrysler Corp., Detroit 31, Mich.
- Ⓢ ANCHOR METAL CO., 87 Walker St., New York 13, N. Y. ADV. PG. 270.
- Ⓢ ANTARA PRODUCTS, Div., General Dyestuff Corp., 435 Hudson St., New York 14, N. Y. ADV. PG. 268.
- Ⓢ CROWLEY CO., INC., HENRY L., 1 Central Ave., West Orange, N. J. ADV. PG. 231.
- Ⓢ KING LABORATORIES, INC., 127 Solar St., Syracuse 4, N. Y. ADV. PG. 395.
- Ⓢ Mallory & Co., Inc., P. R., 3029 E. Washington St., Indianapolis 6, Ind.
- Ⓢ New Jersey Zinc Co., 160 Front St., New York 7, N. Y.
- Ⓢ Plastic Metals Division, National Radiator Co., 169 Bridge St., Johnstown, Pa.
- Ⓢ Standard Telephones & Cables, Ltd., Connaught House, Aldwych, London, W. C. 2, England.
- Ⓢ Williams & Co., C. K., 2001 Lynch Ave., East St. Louis, Ill.
- Ⓢ Wilson Co., H. A., The, 105 Chestnut St., Newark 5, N. J.

Silicon

- Ⓢ Electro Metallurgical Division, Union Carbide and Carbon Corp., 30 E. 42nd St., New York 17, N. Y.
- Ⓢ Mallory & Co., Inc., P. R., 3029 E. Washington St., Indianapolis 6, Ind.

Silver

- Ⓢ AMERICAN PLATINUM WORKS, N. J. R. R. Ave. at Oliver St., Newark 5, N. J. ADV. PG. 76.
- Ⓢ Baker & Co., Inc., 113 Astor St., Newark 5, N. J.
- Ⓢ BRAININ CO., C. S., 320 Washington St., Mount Vernon, N. Y. ADV. PG. 142.
- Ⓢ Eastern Smelting & Refining Corp., 107-109 Brookline St., Boston 18, Mass.
- Ⓢ GENERAL PLATE DIVISION, Metals & Controls Corp., Attleboro, Mass. ADV. PG. 300.
- Ⓢ Goldsmith Bros. Smelting & Refining Co., 111 N. Wabash Ave., Chicago 2, Ill.
- Ⓢ Handy & Harman, 82 Fulton St., New York 38, N. Y.
- Ⓢ MAKEPEACE CO., D. E., Attleboro, Mass. ADV. PG. 72.
- Ⓢ Mallory & Co., Inc., P. R., 3029 E. Washington St., Indianapolis 6, Ind.
- Ⓢ Merck & Co., Inc., Rahway, N. J.
- Ⓢ NEY CO., J. M., 179 Elm St., Hartford, Conn. ADV. PG. 246.
- Ⓢ Secon Metals Corp., 228 E. 45th St., New York 17, N. Y.
- Ⓢ Standard Metals Corp., 262 Broad St., North Attleboro, Mass.
- Ⓢ Western Gold & Platinum Works, 589 Bryant St., San Francisco, Calif.
- Ⓢ Wildberg Bros. Smelting & Refining Co., 742 Market St., San Francisco 2, Calif.
- Ⓢ Wilson Co., H. A., The, 105 Chestnut St., Newark 5, N. J.

Silver Alloys and Compounds

- Ⓢ AMERICAN PLATINUM WORKS, N. J. R. R. Ave. at Oliver St., Newark 5, N. J. ADV. PG. 76.

Ⓢ indicates . . . IN PRODUCTION • AVAILABILITY • UNRESTRICTED FOR GENERAL USE

- Ⓢ ANCHOR METAL CO., 87 Walker St., New York 13, N. Y. ADV. PG. 270.
- Ⓢ BRAININ CO., C. S., 320 Washington St., Mount Vernon, N. Y. ADV. PG. 142.
- Ⓢ Eastern Smelting & Refining Corp., 107-109 W. Brookline St., Boston 18, Mass.
- Ⓢ GENERAL PLATE DIVISION, Metals & Controls Corp., Attleboro, Mass. ADV. PG. 300.
- Ⓢ Goldsmith Bros. Smelting & Refining Co., 111 N. Wabash Ave., Chicago 2, Ill.
- Ⓢ Handy & Harman, 82 Fulton St., New York 38, N. Y.
- Ⓢ MAKEPEACE CO., D. E., Attleboro, Mass. ADV. PG. 72.
- Ⓢ Mallinckrodt Chemical Works, Second and Mallinckrodt Sts., St. Louis 7, Mo.
- Ⓢ Mallory & Co., Inc., P. R., 3029 E. Washington St., Indianapolis 6, Ind.
- Ⓢ NEFY CO., J. M., 179 Elm St., Hartford, Conn. ADV. PG. 246.
- Ⓢ North American Philips Co., Inc., 100 E. 42nd St., New York 17, N. Y.
- Ⓢ Secon Metals Corp., 228 E. 45th St., New York 17, N. Y.
- Ⓢ Standard Metals Corp., 262 Broad St., North Attleboro, Mass.
- Ⓢ Western Gold & Platinum Works, 589 Bryant St., San Francisco, Calif.
- Ⓢ Wildberg Bros. Smelting & Refining Co., 742 Market St., San Francisco 2, Calif.

Steel

- Ⓢ Armco Steel Corp., 703 Curtis St., Middletown, Ohio.
- Ⓢ CRUCIBLE STEEL CO. OF AMERICA, 405 Lexington Ave., New York 17, N. Y. ADV. PG. 225.
- Ⓢ Lukens Steel Co. and Division, By-Products Steel Co. & Lukens, 447 Lukens Bldg., Coatesville, Pa.
- Ⓢ Republic Steel Corp., Republic Bldg., Cleveland 1, Ohio.
- Ⓢ Summerill Tubing Co., Div., Columbia Steel & Shafting Co., P. O. Box 1557, Pittsburgh 30, Pa.
- Ⓢ U. S. Steel Co. (U. S. Steel Corp. Sub.), 525 Wm. Penn Place Bldg., Pittsburgh 30, Pa.

Steel, Electric

- Ⓢ Allegheny Ludlum Steel Corp., H. W. Oliver Bldg., Pittsburgh 22, Pa.
- Ⓢ Armco Steel Corp., 703 Curtis St., Middletown, Ohio.
- Ⓢ Mallory & Co., Inc., P. R., 3029 E. Washington St., Indianapolis 6, Ind.
- Ⓢ Republic Steel Corp., Republic Bldg., Cleveland 1, Ohio.
- Ⓢ U. S. Steel Co. (U. S. Steel Corp. Sub.) 525 Wm. Penn Place Bldg., Pittsburgh 30, Pa.

Steel, Stainless

- Ⓢ Allegheny Ludlum Steel Corp., H. W. Oliver Bldg., Pittsburgh 22, Pa.
- Ⓢ Alloy Metal Wire Co., 13th and Pennsylvania Ave., Prospect Park, Pa.
- Ⓢ Armco Steel Corp., 703 Curtis St., Middletown, Ohio.
- Ⓢ Carpenter Steel Co., The, 142 W. Bern St., Reading, Pa.
- Ⓢ CRUCIBLE STEEL CO. OF AMERICA, 405 Lexington Ave., New York 17, N. Y. ADV. PG. 225.
- Ⓢ DRIVER CO., WILBUR B., 150 Riverside Ave., Newark 4, N. J. ADV. PG. 189.
- Ⓢ DRIVER-HARRIS CO., 201 Middlesex St., Harrison, N. J. ADV. PG. 131.
- Ⓢ Republic Steel Corp., Republic Bldg., Cleveland 1, Ohio.
- Ⓢ Summerill Tubing Co., Div., Columbia Steel & Shafting Co., P. O. Box 1557, Pittsburgh 30, Pa.
- Ⓢ U. S. Steel Co. (U. S. Steel Corp. Sub.), 525 Wm. Penn Place Bldg., Pittsburgh 30, Pa.

Strontium

- Ⓢ KING LABORATORIES INC., 127 Solar St., Syracuse 4, N. Y. ADV. PG. 395.

Tantalum

- Ⓢ CROSS CO., H., 15 Beekman St., New York, N. Y. ADV. PG. 384.
- Ⓢ Fansteel Metallurgical Corp., 2200 Sheridan Rd., North Chicago, Ill.
- Ⓢ Metal Hydrides, Inc., Beverly, Mass.
- Ⓢ Murex, Ltd., Rainham, Essex, England.

Thermostratic Bi-Metals

- Ⓢ Baker Co., Inc., 113 Astor St., Newark 5, N. J.
- Ⓢ BRAININ CO., C. S., 320 Washington St., Mount Vernon, N. Y. ADV. PG. 142.
- Ⓢ Eastern Smelting & Refining Corp., 107-109 W. Brookline St., Boston 18, Mass.
- Ⓢ GENERAL PLATE DIVISION, Metals & Controls Corp., Attleboro, Mass. ADV. PG. 300.
- Ⓢ Wilson Co., H. A., The, 105 Chestnut St., Newark 5, N. J.

Tin

- Ⓢ Alpha Metals, Inc., 365 Hudson Ave., Brooklyn 1, N. Y.
- Ⓢ ANCHOR METAL CO., 87 Walker St., New York 13, N. Y. ADV. PG. 270.
- Ⓢ Division Lead Co., 836 W. Kinzie St., Chicago 22, Ill.
- Ⓢ Federated Metals Div., American Smelting & Refining Co., 120 Broadway, New York 5, N. Y.
- Ⓢ GLASER LEAD CO., INC., 31 Wyckoff Ave., Brooklyn, N. Y. ADV. PG. 416.
- Ⓢ Merck & Co., Inc., Rahway, N. J.

Tungsten

- Ⓢ Electro Metallurgical Division, Union Carbide & Carbon Corp., 30 E. 42nd St., New York 17, N. Y.
- Ⓢ Fansteel Metallurgical Corp., 2200 Sheridan Rd., North Chicago, Ill.
- Ⓢ Mallory & Co., Inc., P. R., 3029 E. Washington St., Indianapolis 6, Ind.
- Ⓢ Murex, Ltd., Rainham, Essex, England.
- Ⓢ North American Philips Co., Inc., 100 E. 42nd St., New York 17, N. Y.
- Ⓢ SYLVANIA ELECTRIC PRODUCTS, INC., 1740 Broadway, New York 19, N. Y. ADV. PG. 432-436.
- Ⓢ Wilson Co., H. A., The, 105 Chestnut St., Newark 5, N. J.

Tungsten Ribbon

- Ⓢ CROSS CO., H., 15 Beekman St., New York, N. Y. ADV. PG. 384.
- Ⓢ Murex, Ltd., Rainham, Essex, England.
- Ⓢ North American Philips Co., Inc., 100 E. 42nd St., New York 17, N. Y.
- Ⓢ WESTINGHOUSE ELECTRIC CORP., 511 Wood St., P. O. Box 868, Pittsburgh 30, Pa. ADV. PG. 107-113.

Uranium

- Ⓢ ATOMIC INSTRUMENT CO., 84 Massachusetts Ave., Cambridge 39, Mass. ADV. PG. 410.
- Ⓢ Mallinckrodt Chemical Works, Second & Mallinckrodt Sts., St. Louis 7, Mo.
- Ⓢ Precision Radiation Instruments Inc., 4113 W. Jefferson Blvd., Los Angeles 16, Calif.

Zinc

- Ⓢ Division Lead Co., 836 W. Kinzie St., Chicago 22, Ill.
- Ⓢ Federated Metals Div., American Smelting & Refining Co., 120 Broadway, New York 5, N. Y.
- Ⓢ GLASER LEAD CO., INC., 31 Wyckoff Ave., Brooklyn, N. Y. ADV. PG. 416.
- Ⓢ Merck & Co., Inc., Rahway, N. J.
- Ⓢ New Jersey Zinc Co., 160 Front St., New York 7, N. Y.

Zirconium

- Ⓢ ANCHOR METAL CO., 87 Walker St., New York 13, N. Y. ADV. PG. 270.
- Ⓢ Electro Metallurgical Division, Union Carbide & Carbon Corp., 30 E. 42nd St., New York 17, N. Y.
- Ⓢ Foote Mineral Co., 18 W. Chelton Ave., Philadelphia 44, Pa.
- Ⓢ Mallory & Co., Inc., P. R., 3029 E. Washington St., Indianapolis 6, Ind.
- Ⓢ Metal Hydrides, Inc., Beverly, Mass.
- Ⓢ Murex, Ltd., Rainham, Essex, England

METEOROLOGICAL EQUIPMENT—Electronic

- Ⓢ Aeronautical Communications Equipment, Inc., 3090 Douglas Rd., Miami 33, Fla.
- Ⓢ BARKER & WILLIAMSON, 235 Fairfield Ave., Upper Darby, Pa. ADV. PG. 292.
- Ⓢ Friez Instrument Div., Bendix Aviation Corp., Baltimore 4, Md.
- Ⓢ McElroy Mfg. Corp., Littleton, Mass.
- Ⓢ Network Mfg. Corp., Bayonne, N. J.
- Ⓢ Northeastern Engineering, Inc., Manchester, N. H.
- Ⓢ Nuclear Research Corp., 2707 Federal St., Philadelphia 46, Pa.

METERS, Acceleration See Accelerometers

METERS—Attenuation

- Ⓢ AIRMEC LABORATORIES LTD., 366 Madison Ave., New York 17, N. Y. ADV. PG. 336.
- Ⓢ DAVEN CO., 191 Central Ave., Newark 4, N. J. ADV. PG. 157.
- Ⓢ KINGS MICROWAVE CO., INC., 50 Marbledale Rd., Tuckahoe 7, N. Y. ADV. PG. 178, 179.

- Ⓢ SHALLCROSS MFG. CO., 10 Jackson Ave., Collingdale, Pa. ADV. PG. 261.
- Ⓢ SPERRY GYROSCOPE CO., Div. of The Sperry Corp., Great Neck, N. Y. ADV. PG. 103, 104.
- Ⓢ WESTINGHOUSE ELECTRIC CORP., 511 Wood St., P. O. Box 868, Pittsburgh 30, Pa. ADV. PG. 107-113.

METERS—Cable Testing

- Ⓢ AIRMEC LABORATORIES LTD., 366 Madison Ave., New York 17, N. Y. ADV. PG. 336.
- Ⓢ Biddle Co., James G., 1316 Arch St., Philadelphia 7, Pa.
- Ⓢ DAVEN CO., 191 Central Ave., Newark 4, N. J. ADV. PG. 157.
- Ⓢ Electronic Brazing Co., 140 Glenridge Ave., Montclair, N. J.
- Ⓢ Leeds & Northrup Co., 4970 Stenton Ave., Philadelphia 44, Pa.
- Ⓢ Network Mfg. Corp., Bayonne, N. J.
- Ⓢ SHALLCROSS MFG. CO., 10 Jackson Ave., Collingdale, Pa. ADV. PG. 261.
- Ⓢ WESTINGHOUSE ELECTRIC CORP., 511 Wood St., P. O. Box 868, Pittsburgh 30, Pa. ADV. PG. 107-113.

METERS—Counting Rate

- Ⓢ AIRMEC LABORATORIES LTD., 366 Madison Ave., New York 17, N. Y. ADV. PG. 336.
- Ⓢ Anton Electronic Laboratories, Inc., 1226-1238 Flushing Ave., Brooklyn 6, N. Y.
- Ⓢ ATOMIC INSTRUMENT CO., 84 Massachusetts Ave., Cambridge 39, Mass. ADV. PG. 410.
- Ⓢ Bassett, Inc., Rex, 307-311 N. W. First Ave., Fort Lauderdale, Fla.
- Ⓢ Douglas Radio Labs., 176 Norfolk Ave., Boston 19, Mass.
- Ⓢ Electronic Products Co., 111 E. Third St., Mt. Vernon, N. Y.
- Ⓢ EL-TRONICS, INC., 2649 N. Howard St., Philadelphia 33, Pa. ADV. PG. 299.
- Ⓢ GENERAL RADIO CO., 275 Massachusetts Ave., Cambridge 39, Mass. ADV. PG. 48, 49.
- Ⓢ Georator Corp., 1820 N. Nash St., Arlington, Va.
- Ⓢ HEWLETT-PACKARD CO., 395 Page Mill Rd., Palo Alto, Calif. ADV. PG. 33-36.
- Ⓢ Kelley-Koett Instrument Co., 962 York St., Cincinnati 14, Ohio.
- Ⓢ Macdonald & Co., Inc., W. S., 33 University Rd., Cambridge 38, Mass.
- Ⓢ Measurement Engineering, Ltd., Arnprior, Ontario, Canada.
- Ⓢ Nuclear Instrument & Chemical Co., 223 W. Erie St., Chicago 10, Ill.
- Ⓢ Nuclear Measurements Corp., 3339 Central Ave., Indianapolis 5, Ind.
- Ⓢ Nuclear Research Corp., 2707 Federal St., Philadelphia 46, Pa.
- Ⓢ Nuclonic Corp. of America, The, 497 Union St., Brooklyn 31, N. Y.
- Ⓢ R-C Scientific Instrument Co., 335 Culver Blvd., Playa Del Rey, Calif.
- Ⓢ Radiation Counter Laboratories, Inc., 1844 W. 21st St., Chicago 8, Ill.
- Ⓢ Radioactive Products, Inc., 443 W. Congress St., Detroit 26, Mich.
- Ⓢ Technical Associates, 3730 San Fernando Rd., Glendale 4, Calif.
- Ⓢ Tracerlab Inc., 130 High St., Boston 10, Mass.
- Ⓢ Walkert Co., 5808 Marilyn Ave., Culver City, Calif.
- Ⓢ WESTINGHOUSE ELECTRIC CORP., 511 Wood St., P. O. Box 868, Pittsburgh 30, Pa. ADV. PG. 107-113.

METERS—d'Arsonval See Also Galvanometers

- Ⓢ Assembly Products, Inc., Chagrin Falls 6, Ohio.
- Ⓢ Beede Electrical Instrument Co., Inc., Penacook, N. H.
- Ⓢ Burlington Instrument Co., Burlington, Iowa.
- Ⓢ Central Scientific Co., 1700 Irving Park Rd., Chicago 13, Ill.
- Ⓢ Cole Instrument Co., 1320 S. Grand Ave., Los Angeles 15, Calif.
- Ⓢ DEJUR-AMSCO CORP., Northern Blvd. at 45th St., Long Island City 1, N. Y. ADV. PG. 377.
- Ⓢ Electric Design & Mfg. Corp., Burlington, Iowa.
- Ⓢ G-M LABORATORIES, 4313 N. Knox Ave., Chicago, Ill. ADV. PG. 392.
- Ⓢ GENERAL ELECTRIC CO., Schenectady 5, N. Y. ADV. PG. 1 to 22.
- Ⓢ HICKOK ELECTRICAL INSTRUMENT CO., 10514 Dupont Ave., Cleveland 8, Ohio. ADV. PG. 333.
- Ⓢ INTERNATIONAL INSTRUMENTS, INC., 331 East St., New Haven 11, Conn. ADV. PG. 322.
- Ⓢ MARION ELECTRICAL INSTRUMENT CO., Manchester, N. H. ADV. PG. 200.
- Ⓢ Meters, Inc., 915 Westfield Blvd., Indianapolis 20, Ind.
- Ⓢ Oak Ridge Products Mfg. Div., of Video Television, Inc., 37-01 Vernon Blvd., Long Island City 1, N. Y.
- Ⓢ Pyramid Instrument Corp., 49 Howard St., New York, N. Y.
- Ⓢ Rawson Electrical Instrument Co., 111 Potter St., Cambridge 42, Mass.
- Ⓢ Reliance Instrument Co., 3027 W. Van Buren St., Chicago 12, Ill.

Ⓟ indicates . . . IN PRODUCTION • AVAILABILITY • UNRESTRICTED FOR GENERAL USE

- Ⓟ Sensitive Research Instrument Corp., 9 Elm Ave., Mt. Vernon, N. Y.
- Ⓟ Simpson Electric Co., Div. of American Gage & Machine Co., 5218 W. Kinzie St., Chicago 44, Ill.
- Ⓟ Thwing-Albert Instrument Co., 5351 Pulaski Ave., Philadelphia 44, Pa.
- Ⓟ Triplett Electrical Instrument Co., Harmon Rd., Bluffton, Ohio.
- Ⓟ Welch Scientific Co., W. M., 1515 Sedgwick St., Chicago 10, Ill.
- Ⓟ WESTINGHOUSE ELECTRIC CORP., 511 Wood St., P. O. Box 868, Pittsburgh 30, Pa. ADV. PG. 107-113.

METERS—Decibel

- Ⓟ AIRMEC LABORATORIES LTD., 366 Madison Ave., New York 17, N. Y. ADV. PG. 336.
- Ⓟ Assembly Products, Inc., Chagrin Falls 6, Ohio.
- Ⓟ BALLANTINE LABORATORIES, INC., Boonton, N. J. ADV. PG. 125.
- Ⓟ Burlington Instrument Co., Burlington, Iowa.
- Ⓟ CINEMA ENGINEERING CO., 1510 W. Verdugo Ave., Burbank, Calif. ADV. PG. 204.
- Ⓟ Clough Bregle Co., 6014 N. Broadway, Chicago, Ill.
- Ⓟ DAVEN CO., 191 Central Ave., Newark 4, N. J. ADV. PG. 157.
- Ⓟ DEJUR-AMSCO CORP., Northern Blvd. at 45th St., Long Island City 1, N. Y. ADV. PG. 377.
- Ⓟ GENERAL ELECTRIC CO., Schenectady 5, N. Y. ADV. PG. 1 to 22.
- Ⓟ GENERAL RADIO CO., 275 Massachusetts Ave., Cambridge 39, Mass. ADV. PG. 48, 49.
- Ⓟ HICKOK ELECTRICAL INSTRUMENT CO., 10514 Dupont Ave., Cleveland 8, Ohio. ADV. PG. 333.
- Ⓟ MARION ELECTRICAL INSTRUMENT CO., Manchester, N. H. ADV. PG. 200.
- Ⓟ Meters, Inc., 915 Westfield Blvd., Indianapolis 20, Ind.
- Ⓟ Scott, Inc., Hermon Hosmer, 385 Putnam Ave., Cambridge 39, Mass.
- Ⓟ SHALLCROSS MFG. CO., 10 Jackson Ave., Collingdale, Pa. ADV. PG. 261.
- Ⓟ Simpson Electric Co., Div. of American Gage & Machine Co., 5218 W. Kinzie St., Chicago 44, Ill.
- Ⓟ Standard Telephones & Cables Ltd., Connaught House, Aldwych, London, W. C. 2, England.
- Ⓟ Triplett Electrical Instrument Co., Harmon Rd., Bluffton, Ohio.
- Ⓟ Welch Scientific Co., W. M., 1515 Sedgwick St., Chicago 10, Ill.
- Ⓟ WESTINGHOUSE ELECTRIC CORP., 511 Wood St., P. O. Box 868, Pittsburgh 30, Pa. ADV. PG. 107-113.
- Ⓟ WESTON ELECTRICAL INSTRUMENT CORP., 595 Frelinghuysen Ave., Newark 5, N. J. ADV. PG. 243.

METERS—Distortion and Noise

- Ⓟ AIRMEC LABORATORIES LTD., 366 Madison Ave., New York 17, N. Y. ADV. PG. 336.
- Ⓟ Audio Instrument Co., 133 W. 14th St., New York 11, N. Y.
- Ⓟ BARKER & WILLIAMSON, 235 Fairfield Ave., Upper Darby, Pa. ADV. PG. 292.
- Ⓟ DAVEN CO., 191 Central Ave., Newark 4, N. J. ADV. PG. 157.
- Ⓟ Doolittle Radio, Inc., 7421 S. Loomis Blvd., Chicago 36, Ill.
- Ⓟ Ferris Instrument Co., 110 Cornelia St., Boonton, N. J.
- Ⓟ FREED TRANSFORMER CO., INC., 1736 Weirfield St., Brooklyn 27, N. Y. ADV. PG. 149.
- Ⓟ GENERAL ELECTRIC CO., Schenectady 5, N. Y. ADV. PG. 1 to 22.
- Ⓟ GENERAL RADIO CO., 275 Massachusetts Ave., Cambridge 39, Mass. ADV. PG. 48, 49.
- Ⓟ HEWLETT-PACKARD CO., 395 Page Mill Rd., Palo Alto, Calif. ADV. PG. 33-36.
- Ⓟ KAY ELECTRIC CO., 14 Maple Ave., Pine Brook, N. J. ADV. PG. 340.
- Ⓟ MARCONI INSTRUMENTS LTD., 23 Beaver St., New York 4, N. Y. ADV. PG. 270.
- Ⓟ PICKERING & CO., 309 Woods Ave., Oceanside, N. Y. ADV. PG. 284.
- Ⓟ RADIO CORP. OF AMERICA, RCA Victor Div., General Offices, Camden, N. J. ADV. PG. 177, Inside Back & Back Covers.
- Ⓟ Scott, Inc., Hermon Hosmer, 385 Putnam Ave., Cambridge 39, Mass.
- Ⓟ Standard Telephones & Cables Ltd., Connaught House, Aldwych, London, W. C. 2, England.
- Ⓟ Waveforms, Inc., 333 Sixth Ave., New York 14, N. Y.

METERS—Elapsed Time

- Ⓟ Aero Instrument Co., 11423 Vanowen St., North Hollywood, Calif.
- Ⓟ AIRMEC LABORATORIES LTD., 366 Madison Ave., New York 17, N. Y. ADV. PG. 336.
- Ⓟ ATOMIC INSTRUMENT CO., 84 Massachusetts Ave., Cambridge 39, Mass. ADV. PG. 410.
- Ⓟ Bristol Co., The, Waterbury 20, Conn.

- Ⓟ Burlington Instrument Co., Burlington, Iowa.
- Ⓟ CRAMER CO., INC., R. W., Box 13, Centerbrook, Conn. ADV. PG. 202.
- Ⓟ EL-TRONICS, INC., 2649 N. Howard St., Philadelphia 33, Pa. ADV. PG. 299.
- Ⓟ Foxboro Co., The, Foxboro, Mass.
- Ⓟ GENERAL ELECTRIC CO., Schenectady 5, N. Y. ADV. PG. 1 to 22.
- Ⓟ HAYDON CO., A. W., 232 N. Elm St., Waterbury 20, Conn. ADV. PG. 402.
- Ⓟ HAYDON MFG. CO., INC., 584 E. Elm St., Torrington, Conn. ADV. PG. 216, 217.
- Ⓟ Industrial Timer Corp., 115 Edison Pl., Newark 5, N. J.
- Ⓟ J B T INSTRUMENTS, INC., 431-B Chapel St., New Haven 8, Conn. ADV. PG. 351.
- Ⓟ MARION ELECTRICAL INSTRUMENT CO., Manchester, N. H. ADV. PG. 200.
- Ⓟ WESTINGHOUSE ELECTRIC CORP., 511 Wood St., P. O. Box 868, Pittsburgh 30, Pa. ADV. PG. 107-113.
- Ⓟ WESTON ELECTRICAL INSTRUMENT CORP., 595 Frelinghuysen Ave., Newark 5, N. J. ADV. PG. 243.

METERS—Electronic Capacitance

- Ⓟ BOONTON RADIO CORP., Boonton, N. J. ADV. PG. 96.
- Ⓟ Clippard Instrument Laboratory, Inc., 1125 Bank St., Cincinnati 14, Ohio.
- Ⓟ GENERAL RADIO CO., 275 Massachusetts Ave., Cambridge 39, Mass. ADV. PG. 48, 49.
- Ⓟ HICKOK ELECTRICAL INSTRUMENT CO., 10514 Dupont Ave., Cleveland 8, Ohio. ADV. PG. 333.
- Ⓟ Jackson Electrical Instrument Co., 16 S. Patterson Blvd., Dayton 1, Ohio.
- Ⓟ Kalbfell Labs., Inc., 1076 Morena Blvd., San Diego 10, Calif.
- Ⓟ Leeds & Northrup Co., 4970 Stenton Ave., Philadelphia 44, Pa.
- Ⓟ MacLeod & Hanopol Inc., 10 Joiner St., Charleston 29, Mass.
- Ⓟ McMurdo Silver Co., Inc., 417 Lafayette St., New York, N. Y.
- Ⓟ PENNSYLVANIA TESTING LABORATORY, Doylestown, Pa. ADV. PG. 350.
- Ⓟ WESTON ELECTRICAL INSTRUMENT CORP., 595 Frelinghuysen Ave., Newark 5, N. J. ADV. PG. 243.
- Ⓟ Wheeler Laboratories, Inc., Great Neck, N. Y.

METERS—f-m Deviation

See Also Monitors.

- Ⓟ AIR ASSOCIATES, INC., Teterboro, N. J. ADV. PG. 211.
- Ⓟ BROWNING LABORATORIES, INC., 750 Main St., Winchester, Mass. ADV. PG. 257.
- Ⓟ GENERAL RADIO CO., 275 Massachusetts Ave., Cambridge 39, Mass. ADV. PG. 48, 49.
- Ⓟ HEWLETT-PACKARD CO., 395 Page Mill Rd., Palo Alto, Calif. ADV. PG. 33-36.
- Ⓟ LAMPKIN LABORATORIES, INC., Bradenton, Fla. ADV. PG. 418.
- Ⓟ MARCONI INSTRUMENTS, LTD., 23 Beaver St., New York 4, N. Y. ADV. PG. 270.
- Ⓟ Monitor Products Co., 915 Fremont Ave., South Pasadena, Calif.
- Ⓟ RADIO CORP. OF AMERICA, RCA Victor Div., General Offices, Camden, N. J. ADV. PG. 177, Inside Back & Back Covers.
- Ⓟ West Coast Electronics Co., 1601 S. Burlington St., Los Angeles 6, Calif.

METERS—Field Strength

- Ⓟ Approved Electronic Instrument Corp., 142 Liberty St., New York 6, N. Y.
- Ⓟ Bassett, Inc., Rex, 307-311 N. W. First Ave., Fort Lauderdale, Fla.
- Ⓟ Clarke Instrument Div., National Electrical Machine Shops, Inc., 919 Jesup-Blair Drive, Silver Spring, Md.
- Ⓟ FEDERAL TELEPHONE & RADIO CORP., 88 Kingsland Rd., Clifton, N. J. ADV. PG. 161-163.
- Ⓟ Ferris Instrument Co., 110 Cornelia St., Boonton, N. J.
- Ⓟ Flader, Inc., Fredric, 1330 Laskey Rd., Toledo 12, Ohio.
- Ⓟ GENERAL ELECTRIC CO., Schenectady 5, N. Y. ADV. PG. 1 to 22.
- Ⓟ KAY ELECTRIC CO., 14 Maple Ave., Pine Brook, N. J. ADV. PG. 340.
- Ⓟ Lynnmar Engineers Inc., 1721 Delancey St., Philadelphia 3, Pa.
- Ⓟ MARCONI INSTRUMENTS, LTD., 23 Beaver St., New York 4, N. Y. ADV. PG. 270.
- Ⓟ MEASUREMENTS CORP., Boonton, N. J. ADV. PG. 99.
- Ⓟ POLARAD ELECTRONICS CORP., 100 Metropolitan Ave., Brooklyn 11, N. Y. ADV. PG. 184, 185.
- Ⓟ Radio Transceiver Labs., 116-23 Jamaica Ave., Richmond Hill 18, N. Y.
- Ⓟ Simpson Electric Co. Div., American Gage & Machine Co., 5218 W. Kinzie St., Chicago 44, Ill.
- Ⓟ Standard Telephones & Cables Ltd., Connaught House, Aldwych, London, W. C. 2, England.
- Ⓟ Stoddard Aircraft Radio Co., 6644 Santa Monica Blvd., Hollywood 38, Calif.
- Ⓟ Transvision, Inc., 460 North Ave., New Rochelle, N. Y.

METERS—Flow

- Ⓟ Bailey Meter Co., 1044 Ivanhoe Rd., Cleveland 10, Ohio.
- Ⓟ Bristol Co., The, Waterbury 20, Conn.
- Ⓟ Coral Designs Div. of Henry G. Dietz Co., 12-16 Astoria Blvd., Long Island City 2, N. Y.
- Ⓟ Fischer & Porter Co., Hatboro, Pa.
- Ⓟ Foxboro Co., The, Foxboro, Mass.
- Ⓟ Leeds & Northrup Co., 4970 Stenton Ave., Philadelphia 44, Pa.
- Ⓟ MINNEAPOLIS-HONEYWELL REGULATOR CO., INDUSTRIAL DIV., Wayne & Roberts Aves., Philadelphia 44, Pa. ADV. PG. 208, 209.
- Ⓟ Technitrol Engineering Co., 3211 Woodland Ave., Philadelphia 4, Pa.
- Ⓟ U. S. Gauge Div., American Machine & Metals, Inc., Sellersville, Pa.

METERS—Flutter

See Meters, Wow and Flutter

METERS—Footcandle

- Ⓟ GENERAL ELECTRIC CO., Schenectady 5, N. Y. ADV. PG. 1 to 22.
- Ⓟ Welch Scientific Co., W. M., 1515 Sedgwick St., Chicago 10, Ill.
- Ⓟ WESTON ELECTRICAL INSTRUMENT CORP., 595 Frelinghuysen Ave., Newark 5, N. J. ADV. PG. 243.

METERS—Frequency

- Ⓟ Aero Instrument Co., 11423 Vanowen St., North Hollywood, Calif.
- Ⓟ AIRMEC LABORATORIES LTD., 366 Madison Ave., New York 17, N. Y. ADV. PG. 336.
- Ⓟ ATOMIC INSTRUMENT CO., 84 Massachusetts Ave., Cambridge 39, Mass. ADV. PG. 410.
- Ⓟ BARKER & WILLIAMSON, 235 Fairfield Ave., Upper Darby, Pa. ADV. PG. 292.
- Ⓟ Bassett, Inc., Rex, 307-311 N. W. First Ave., Fort Lauderdale, Fla.
- Ⓟ Berkeley Scientific Corp., 2200 Wright Ave., Richmond, Calif.
- Ⓟ Biddle Co., James G., 1316 Arch St., Philadelphia 7, Pa.
- Ⓟ BROWNING LABORATORIES, INC., 750 Main St., Winchester, Mass. ADV. PG. 257.
- Ⓟ Caltron Co., 1406 S. Hobart Blvd., Los Angeles 6, Calif.
- Ⓟ CONN, C. G., Electronics Div., 1001 Beardsley Ave., Elkhart, Ind. ADV. PG. 302.
- Ⓟ DAVEN CO., 191 Central Ave., Newark 4, N. J. ADV. PG. 157.
- Ⓟ Diamond Mfg. Co., Wakefield, Mass.
- Ⓟ Espey Mfg. Co., Inc., 528 E. 72nd St., New York, N. Y.
- Ⓟ Esterline-Angus Co., Inc., P. O. Box 596, Indianapolis, Ind.
- Ⓟ FEDERAL MFG. & ENGRG CORP., 211 Steuben St., Brooklyn 5, N. Y. ADV. PG. 344.
- Ⓟ FREED TRANSFORMER CO., INC., 1736 Weirfield St., Brooklyn 27, N. Y. ADV. PG. 149.
- Ⓟ Frequency Standards Corp., Box 66, Eatontown, N. J.
- Ⓟ Gaveco Labs, Inc., 2 E. End Ave., New York 21, N. Y.
- Ⓟ GENERAL ELECTRIC CO., Schenectady 5, N. Y. ADV. PG. 1 to 22.
- Ⓟ GENERAL RADIO CO., 275 Massachusetts Ave., Cambridge 39, Mass. ADV. PG. 48, 49.
- Ⓟ Gertsch Products, Inc., 11846 Mississippi Ave., Los Angeles 25, Calif.
- Ⓟ HEWLETT-PACKARD CO., 395 Page Mill Rd., Palo Alto, Calif. ADV. PG. 33-36.
- Ⓟ J B T INSTRUMENTS, INC., 431-B Chapel St., New Haven 8, Conn. ADV. PG. 351.
- Ⓟ KAY ELECTRIC CO., 14 Maple Ave., Pine Brook, N. J. ADV. PG. 340.
- Ⓟ KINGS MICROWAVE CO., INC., 50 Marbledale, Rd., Tuckahoe 7, N. Y. ADV. PG. 178, 179.
- Ⓟ LAMPKIN LABORATORIES, INC., Bradenton, Fla. ADV. PG. 418.
- Ⓟ LAVOIE LABORATORIES, Morganville, N. J. ADV. PG. 206.
- Ⓟ Leeds & Northrup Co., 4970 Stenton Ave., Philadelphia 44, Pa.
- Ⓟ Measurement Engineering, Ltd., Arnprior, Ontario, Canada.
- Ⓟ MICO INSTRUMENT CO., 76 Trowbridge St., Cambridge 38, Mass. ADV. PG. 381.
- Ⓟ Millen Mfg. Co., James, 150 Exchange St., Malden, Mass.
- Ⓟ Monitor Products Co., 915 Fremont Ave., South Pasadena, Calif.
- Ⓟ NORTHERN RADIO CO., INC., 143-145 W. 22nd St., New York 11, N. Y. ADV. PG. 262, 263.
- Ⓟ Nucleonic Corp. of America, 497 Union St., Brooklyn 31, N. Y.
- Ⓟ POLYTECHNIC RESEARCH & DEVELOPMENT CO., INC., 202 Tillary St., Brooklyn 1, N. Y. ADV. PG. 172, 173.
- Ⓟ Roller-Smith, Bethlehem, Pa.
- Ⓟ SPERRY GYROSCOPE CO., Div. of The Sperry Corp., Great Neck, N. Y. ADV. PG. 103, 104.
- Ⓟ STANDARD CRYSTAL CO., 400 Armstrong Ave., Kansas City 1, Kans. ADV. PG. 156.

Ⓢ indicates . . . IN PRODUCTION • AVAILABILITY • UNRESTRICTED FOR GENERAL USE

- Ⓢ Triplett Electrical Instrument Co., Harmon Rd., Bluffton, Ohio.
- Ⓢ Varo Mfg. Co., Inc., Box 638, Garland, Texas.
- Ⓢ VECTRON, INC., 235 High St., Waltham, Mass. ADV. PG. 214.
- Ⓢ Walkirt Co., 5808 Marilyn Ave., Culver City, Calif.
- Ⓢ West Coast Electronics Co., 1601 S. Burlington St., Los Angeles 6, Calif.
- Ⓢ WESTINGHOUSE ELECTRIC CORP., 511 Wood St., P. O. Box 868, Pittsburgh 30, Pa. ADV. PG. 107-113.
- Ⓢ WESTON ELECTRICAL INSTRUMENT CORP., 595 Frelinghuysen Ave., Newark 5, N. J. ADV. PG. 243.

METERS—Impedance

- Ⓢ ADVANCE ELECTRONICS CO., 451 Highland Ave., Passaic, N. J. ADV. PG. 224.
- Ⓢ AIRMEC LABORATORIES LTD., 366 Madison Ave., New York 17, N. Y. ADV. PG. 336.
- Ⓢ BOONTON RADIO CORP., Boonton, N. J. ADV. PG. 96.
- Ⓢ Electrodyne Company, 32 Oliver St., Boston, Mass.
- Ⓢ FEDERAL TELECOMMUNICATION LABS., INC., 500 Washington Ave., Nutley, N. J. ADV. PG. 164.
- Ⓢ FREED TRANSFORMER CO., INC., 1736 Weirfield St., Brooklyn 27, N. Y. ADV. PG. 149.
- Ⓢ JONES ELECTRONICS CO., M. C., Bristol, Conn. ADV. PG. 384.
- Ⓢ LAVOIE LABORATORIES, Morganville, N. J. ADV. PG. 206.
- Ⓢ Leeds & Northrup Co., 4970 Stenton Ave., Philadelphia 44, Pa.
- Ⓢ POLYTECHNIC RESEARCH & DEVELOPMENT CO., INC., 202 Tillary St., Brooklyn 1, N. Y. ADV. PG. 172, 173.
- Ⓢ Special Instruments Laboratories, Inc., 1003 Highland Ave., Knoxville, Tenn.
- Ⓢ SPERRY GYROSCOPE CO., Div. of The Sperry Corp., Great Neck, N. Y. ADV. PG. 103, 104.
- Ⓢ Technology Instrument Corp., 531 Main St., Acton, Mass.

METERS—Impedance & Phase Angle Audio

- Ⓢ ADVANCE ELECTRONICS CO., 451 Highland Ave., Passaic, N. J. ADV. PG. 224.
- Ⓢ AIRMEC LABORATORIES LTD., 366 Madison Ave., New York 17, N. Y. ADV. PG. 336.
- Ⓢ Hastings Instrument Co., Inc., Hampton 9, Va.
- Ⓢ Technology Instrument Corp., 531 Main St., Acton, Mass.

METERS—Light

- Ⓢ Federal Instrument Corp., 14-02 Broadway, Long Island City 6, N. Y.
- Ⓢ G-M LABORATORIES, 4313 N. Knox Ave., Chicago, Ill. ADV. PG. 392.
- Ⓢ GENERAL ELECTRIC CO., Schenectady 5 N. Y. ADV. PG. 1 to 22.
- Ⓢ GENERAL RADIO CO., 275 Massachusetts Ave., Cambridge 39, Mass. ADV. PG. 48, 49.
- Ⓢ MARION ELECTRICAL INSTRUMENT CO., Manchester, N. H. ADV. PG. 200.
- Ⓢ WESTON ELECTRICAL INSTRUMENT CORP., 595 Frelinghuysen Ave., Newark 5, N. J. ADV. PG. 243.

METERS—Microwave

- Ⓢ Decimeter, Inc., 1430 Market St., Denver 2, Colo.
- Ⓢ KINGS MICROWAVE CO., INC., 50 Marbledale Rd., Tuckahee 7, N. Y. ADV. PG. 178, 179.
- Ⓢ MARCONI INSTRUMENTS, LTD., 23 Beaver St., New York 4, N. Y. ADV. PG. 270.
- Ⓢ Microwave Equipment Co., Inc., North Caldwell, N. J.
- Ⓢ POLYTECHNIC RESEARCH & DEVELOPMENT CO., INC., 202 Tillary St., Brooklyn 1, N. Y. ADV. PG. 172, 173.
- Ⓢ SPERRY GYROSCOPE CO., Div. of The Sperry Corp., Great Neck, N. Y. ADV. PG. 103, 104.
- Ⓢ WESTON ELECTRICAL INSTRUMENT CORP., 595 Frelinghuysen Ave., Newark 5, N. J. ADV. PG. 243.
- Ⓢ Weymouth Instrument Co., 1440 Commercial St., East Weymouth 89, Mass.
- Ⓢ Wheeler Laboratories, Inc., Great Neck, N. Y.

METERS—Modulation

See Also Monitors, Modulation.

- Ⓢ GENERAL RADIO CO., 275 Massachusetts Ave., Cambridge 39, Mass. ADV. PG. 48, 49.
- Ⓢ HEWLETT-PACKARD CO., 395 Page Mill Rd., Palo Alto, Calif. ADV. PG. 33-36.
- Ⓢ LAMPKIN LABORATORIES, INC., Bradenton, Fla. ADV. PG. 418.
- Ⓢ MARCONI INSTRUMENTS, LTD., 23 Beaver St., New York 4, N. Y. ADV. PG. 270.
- Ⓢ RADIO CORP. OF AMERICA, RCA Victor Div., General Offices, Camden, N. J. ADV. PG. 177, Inside Back & Back Covers.
- Ⓢ SYLVANIA ELECTRIC PRODUCTS, INC., 1740 Broadway, New York 19, N. Y. ADV. PG. 432-436.
- Ⓢ TRAD TELEVISION CORP., 1001 First Ave., Asbury Park, N. J. ADV. PG. 355.

METERS—Moisture

- American Instrument Co., 8030 Georgia Ave., Silver Spring, Md.
- Ⓢ Berkeley Scientific Corp., 2200 Wright Ave., Richmond, Calif.
- Ⓢ COMMUNICATION MEASUREMENTS LABORATORY, INC., 120 Greenwich St., New York 6, N. Y. ADV. PG. 290.
- Ⓢ Delmhorst Instrument Co., 601 Cedar St., Boonton, N. J.
- Ⓢ Fielden Instrument Corp., 2920 N. 4th St., Philadelphia 33, Pa.
- Ⓢ Foxboro Co., The, Foxboro, Mass.
- Ⓢ Industrial Instruments, Inc., 17 Pollack Ave., Jersey City 5, N. J.
- Ⓢ MARCONI INSTRUMENTS, LTD., 23 Beaver St., New York 4, N. Y. ADV. PG. 270.
- Ⓢ MEASUREMENTS CORP., Boonton, N. J. ADV. PG. 99.
- Ⓢ Tagliabue Div., Weston Electrical Instrument Corp., 614 Frelinghuysen Ave., Newark 5, N. J.
- Ⓢ Tech Laboratories, Inc., Bergen & Edsall Blvd., Palisades Park, N. J.
- Ⓢ Thwing-Albert Instrument Co., 5351 Pulaski Ave., Philadelphia 44, Pa.

METERS—Null

- Ⓢ AIRMEC LABORATORIES, LTD., 366 Madison Ave., New York 17, N. Y. ADV. PG. 336.
- Ⓢ BALLANTINE LABORATORIES, INC., Boonton, N. J. ADV. PG. 125.
- Ⓢ BARKER & WILLIAMSON, 235 Fairfield Ave., Upper Darby, Pa. ADV. PG. 292.
- Ⓢ FREED TRANSFORMER CO., INC., 1736 Weirfield St., Brooklyn 27, N. Y. ADV. PG. 149.
- Ⓢ GENERAL RADIO CO., 275 Massachusetts Ave., Cambridge 39, Mass. ADV. PG. 48, 49.
- Ⓢ Leeds & Northrup Co., 4970 Stenton Ave., Philadelphia 44, Pa.
- Ⓢ MARION ELECTRICAL INSTRUMENT CO., Manchester, N. H. ADV. PG. 200.
- Ⓢ SHALLCROSS MFG. CO., 10 Jackson Ave., Collingdale, Pa. ADV. PG. 261.
- Ⓢ Welch Scientific Co., W. M., 1515 Sedgwick St., Chicago 10, Ill.
- Ⓢ Winslow Co., Inc., 9 Liberty St., Newark 5, N. J.

METERS—Output

- Ⓢ AIRMEC LABORATORIES, LTD., 366 Madison Ave., New York 17, N. Y. ADV. PG. 336.
- Ⓢ BIRD ELECTRONIC CORP., 1800 E. 38th St., Cleveland 14, Ohio. ADV. PG. 331.
- Ⓢ DAVEN CO., 291 Central Ave., Newark 4, N. J. ADV. PG. 157.
- Ⓢ Feiler Engineering Co., 8026 Monticello Ave., Skokie, Ill.
- Ⓢ GENERAL ELECTRIC CO., Schenectady 5, N. Y. ADV. PG. 1 to 22.
- Ⓢ GENERAL RADIO CO., 275 Massachusetts Ave., Cambridge 39, Mass. ADV. PG. 48, 49.
- Ⓢ JONES ELECTRONICS CO., M. C., Bristol, Conn. ADV. PG. 384.
- Ⓢ MARCONI INSTRUMENTS, LTD., 32 Beaver St., New York 4, N. Y. ADV. PG. 270.
- Ⓢ MARION ELECTRICAL INSTRUMENT CO., Manchester, N. H. ADV. PG. 200.
- Ⓢ Oak Ridge Products Mfg. Div. of Video Television, Inc., 37-01 Vernon Blvd., Long Island City 1, N. Y.
- Ⓢ SHALLCROSS MFG. CO., 10 Jackson Ave., Collingdale, Pa. ADV. PG. 261.
- Ⓢ WESTINGHOUSE ELECTRIC CORP., 511 Wood St., P. O. Box 868, Pittsburgh 30, Pa. ADV. PG. 107-113.
- Ⓢ WESTON ELECTRICAL INSTRUMENT CORP., 595 Frelinghuysen Ave., Newark 5, N. J. ADV. PG. 243.

METERS—Panel

- Ⓢ ART-LLOYD METAL PRODUCTS CORP., 2973 Cropsey Ave., Brooklyn 14, N. Y. ADV. PG. 364.
- Ⓢ Assembly Products, Inc., Chagrin Falls 6, Ohio.
- Ⓢ Bailey Meter Co., 1044 Ivanhoe Rd., Cleveland 10, Ohio.
- Ⓢ Beede Electrical Instrument Co., Inc., Penacook, N. H.
- Ⓢ Burlington Instrument Co., Burlington, Iowa.
- Ⓢ Cole Instrument Co., 1320 S. Grand Ave., Los Angeles 15, Calif.
- Ⓢ DEJUR-AMSCO CORP., Northern Blvd., at 45th St., Long Island City 1, N. Y. ADV. PG. 377.
- Ⓢ Electric Design & Mfg. Corp., Burlington, Iowa.
- Ⓢ GENERAL ELECTRIC CO., Schenectady 5, N. Y. ADV. PG. 1 to 22.
- Ⓢ HICKOK ELECTRICAL INSTRUMENT CO., 10514 Dupont Ave., Cleveland 8, Ohio. ADV. PG. 333.
- Ⓢ INTERNATIONAL INSTRUMENTS, INC., 331 East St., New Haven 11, Conn. ADV. PG. 322.
- Ⓢ MARION ELECTRICAL INSTRUMENT CO., Manchester, N. H. ADV. PG. 200.
- Ⓢ Meters, Inc., 915 Westfield Blvd., Indianapolis 20, Ind.
- Ⓢ Oak Ridge Products Mfg. Div. of Video Television, Inc., 37-01 Vernon Blvd., Long Island City 1, N. Y.

- Ⓢ Reliance Instrument Co., 3027 W. Van Buren St., Chicago 12, Ill.
- Ⓢ Roller-Smith, Bethlehem, Pa.
- Ⓢ Sensitive Research Instrument Corp., 9 Elm Ave., Mt. Vernon, N. Y.
- Ⓢ Simpson Electric Co., Div. of American Gage & Machine Co., 5218 W. Kinzie St., Chicago 44, Ill.
- Ⓢ Sterling Mfg. Co., 9205 Detroit Ave., Cleveland 2, Ohio.
- Ⓢ Supreme, Inc., Greenwood, Miss.
- Ⓢ Triplett Electrical Instrument Co., Harmon Rd., Bluffton, Ohio.
- Ⓢ Welch Scientific Co., W. M., 1515 Sedgwick St., Chicago 10, Ill.
- Ⓢ WESTINGHOUSE ELECTRIC CORP., 511 Wood St., P. O. Box 868, Pittsburgh 30, Pa. ADV. PG. 107-113.
- Ⓢ WESTON ELECTRICAL INSTRUMENT CORP., 595 Frelinghuysen Ave., Newark 5, N. J. ADV. PG. 243.

METERS—pH Meters, Recorders & Comparators

- Ⓢ AIRMEC LABORATORIES, LTD., 366 Madison Ave., New York 17, N. Y. ADV. PG. 336.
- Ⓢ Beckman Instruments, Inc., 820 Mission St., South Pasadena, Calif.
- Ⓢ Bristol Co., The, Waterbury 20, Conn.
- Ⓢ Central Scientific Co., 1700 Irving Park Rd., Chicago 13, Ill.
- Ⓢ Coleman Instruments, Inc., 318 Madison St., Maywood, Ill.
- Ⓢ Fisher Scientific Co., 717 Forbes St., Pittsburgh 19, Pa.
- Ⓢ Foxboro Co., The, Foxboro, Mass.
- Ⓢ LaMotte Chemical Products Co., Towson 4, Baltimore, Md.
- Ⓢ Leeds & Northrup Co., 4970 Stenton Ave., Philadelphia 44, Pa.
- Ⓢ MARCONI INSTRUMENTS, LTD., 23 Beaver St., New York 4, N. Y. ADV. PG. 270.
- Ⓢ MINNEAPOLIS-HONEYWELL REGULATOR CO., INDUSTRIAL DIV., Wayne & Roberts Aves., Philadelphia 44, Pa. ADV. PG. 208, 209.
- Ⓢ North American Philips Co., Inc., 100 E. 42nd St., New York 17, N. Y.
- Ⓢ Photovolt Corp., 95 Madison Ave., New York 16, N. Y.
- Ⓢ Thwing-Albert Instrument Co., 5351 Pulaski Ave., Philadelphia 44, Pa.
- Ⓢ Tagliabue Div., Weston Electrical Instrument Corp., 614 Frelinghuysen Ave., Newark 5, N. J.
- Ⓢ Wallace & Tiernan Products, Inc., Belleville 9, N. J.
- Ⓢ Welch Scientific Co., W. M., 1515 Sedgwick St., Chicago 10, Ill.

METERS—Phase Angle

- Ⓢ ADVANCE ELECTRONICS CO., 451 Highland Ave., Passaic, N. J. ADV. PG. 224.
- Ⓢ Aeronautical Electronics, Inc., Raleigh-Durham Airport, P. O. Box 6043m, Raleigh, N. C.
- Ⓢ BOONTON RADIO CORP., Boonton, N. J. ADV. PG. 96.
- Ⓢ Clarke Instrument Div., National Electrical Machine Shops, Inc., 919 Jesup-Blair Drive, Silver Spring, Md.
- Ⓢ GENERAL ELECTRIC CO., Schenectady 5, N. Y. ADV. PG. 1 to 22.
- Ⓢ Hastings Instrument Co., Hampton 9, Va.
- Ⓢ Industrial Devices, Inc., 22 State Rd., Edgewater, N. J.
- Ⓢ Technology Instrument Corp., 531 Main St., Acton, Mass.
- Ⓢ WESTINGHOUSE ELECTRIC CORP., 511 Wood St., P. O. Box 868, Pittsburgh 30, Pa. ADV. PG. 107-113.
- Ⓢ WESTON ELECTRICAL INSTRUMENT CORP., 595 Frelinghuysen Ave., Newark 5, N. J. ADV. PG. 243.

METERS—Photoelectric Reflection

- Ⓢ AIRMEC LABORATORIES, LTD., 366 Madison Ave., New York 17, N. Y. ADV. PG. 336.
- Ⓢ DEJUR-AMSCO CORP., Northern Blvd., at 45th St., Long Island City 1, N. Y. ADV. PG. 377.
- Ⓢ G-M LABORATORIES, INC., 4313 N. Knox Ave., Chicago, Ill. ADV. PG. 392.
- Ⓢ Huggins Laboratories, 734 Hamilton Ave., Menlo Park, Calif.
- Ⓢ Photovolt Corp., 95 Madison Ave., New York 16, N. Y.
- Ⓢ Rubicon Co., 3761 Ridge Ave., Philadelphia 42, Pa.
- Ⓢ WESTON ELECTRICAL INSTRUMENT CORP., 595 Frelinghuysen Ave., Newark 5, N. J. ADV. PG. 243.

METERS—Power Factor

- Ⓢ BOONTON RADIO CORP., Boonton, N. J. ADV. PG. 96.
- Ⓢ Esterline-Angus Co., Inc., P. O. Box 596, Indianapolis, Ind.
- Ⓢ Fluke Engineering Co., John, Box 755 Springdale, Conn.
- Ⓢ GENERAL ELECTRIC CO., Schenectady 5, N. Y. ADV. PG. 1 to 22.
- Ⓢ HICKOK ELECTRICAL INSTRUMENT CO., 10514 Dupont Ave., Cleveland 8, Ohio. ADV. PG. 333.

V indicates . . . IN PRODUCTION • AVAILABILITY • UNRESTRICTED FOR GENERAL USE

- Leeds & Northrup Co., 4970 Stenton Ave., Philadelphia 44, Pa.
- MARCONI INSTRUMENTS, LTD., 23 Beaver St., New York 4, N. Y. ADV. PG. 270.
- Roller-Smith, Bethlehem, Pa.
- Welch Scientific Co., W. M., 1515 Sedgwick St., Chicago 10, Ill.
- WESTINGHOUSE ELECTRIC CORP., 511 Wood St., P. O. Box 868, Pittsburgh 30, Pa. ADV. PG. 107-113.
- WESTON ELECTRICAL INSTRUMENT CORP., 595 Frelinghuysen Ave., Newark 5, N. J. ADV. PG. 243.

METERS—Q

- 300NTON RADIO CORP., Boonton, N. J. ADV. PG. 96.
- Clough Brengle Co., 6014 N. Broadway, Chicago, Ill.
- ELECTRONIC MEASUREMENTS COMPANY, Red Bank, N. J. ADV. PG. 312.
- FREED TRANSFORMER CO., INC., 1736 Weirfield St., Brooklyn 27, N. Y. ADV. PG. 149.
- MARCONI INSTRUMENTS LTD., 23 Beaver St., New York 4, N. Y. ADV. PG. 270.

METERS—RF Power

- BIRD ELECTRONIC CORP., 1800 E. 38th St., Cleveland 14, Ohio. ADV. PG. 331.
- Communications Co., Inc., 300 Greco Ave., Coral Gables 34, Fla.
- Fluke Engineering Co., John, Box 755, Springdale, Conn.
- GENERAL ELECTRIC CO., Schenectady 5, N. Y. ADV. PG. 1 to 22.
- HEWLETT-PACKARD CO., 395 Page Mill Rd., Palo Alto, Calif. ADV. PG. 33-36.
- JONES ELECTRONICS CO., M. C., Bristol, Conn. ADV. PG. 384.
- KINGS MICROWAVE CO., INC., 50 Marbledale Rd., Tuckahoe 7, N. Y. ADV. PG. 178, 179.
- McMurdo Silver Co., Inc., 417 Lafayette St., New York, N. Y.
- MARCONI INSTRUMENTS LTD., 23 Beaver St., New York 4, N. Y. ADV. PG. 270.
- POLYTECHNIC RESEARCH & DEVELOPMENT CO., INC., 202 Tillary St., Brooklyn 1, N. Y. ADV. PG. 172, 173.
- Rollin Co., 2070 N. Fair Oak Ave., Pasadena 3, Calif.
- Simpson Electric Co., Div., American Gage & Machine Co., 5218 W. Kinzie St., Chicago 44, Ill.
- SPERRY GYROSCOPE CO., Div. of The Sperry Corp., Great Neck, N. Y. ADV. PG. 103, 104.
- TRAD TELEVISION CORP., 1001 First Ave., Asbury Park, N. J. ADV. PG. 355.
- Welch Scientific Co., W. M., 1515 Sedgwick St., Chicago 10, Ill.
- WESTON ELECTRICAL INSTRUMENT CORP., 595 Frelinghuysen Ave., Newark 5, N. J. ADV. PG. 243.

METERS—Sound Level

- AIRMEC LABORATORIES, LTD., 366 Madison Ave., New York 17, N. Y. ADV. PG. 336.
- DAVEN CO., 191 Central Ave., Newark 4, N. J. ADV. PG. 157.
- GENERAL ELECTRIC CO., Schenectady 5, N. Y. ADV. PG. 1 to 22.
- GENERAL RADIO CO., 275 Massachusetts Ave., Cambridge 39, Mass. ADV. PG. 48, 49.
- KAY ELECTRIC CO., 14 Maple Ave., Pine Brook, N. J. ADV. PG. 340.
- Scott, Inc., Hermon Hosmer, 385 Putnam Ave., Cambridge 39, Mass.
- Simpson Electric Co., Div. American Gage & Machine Co., 5218 W. Kinzie St., Chicago 44, Ill.
- Triplett Electrical Instrument Co., Harmon Rd., Bluffton, Ohio.
- Welch Scientific Co., W. M., 1515 Sedgwick St., Chicago 10, Ill.
- Western Electro-Acoustic Labs., 204 S. Beverly Drive, Beverly Hills, Calif.
- WESTON ELECTRICAL INSTRUMENT CORP., 595 Frelinghuysen Ave., Newark 5, N. J. ADV. PG. 243.

METERS—Standing Wave Ratio

- BIRD ELECTRONICS CORP., 1800 E. 38th St., Cleveland 14, Ohio. ADV. PG. 331.
- FEDERAL TELECOMMUNICATION LABS., INC., 500 Washington Ave., Nutley, N. J. ADV. PG. 164.
- HEWLETT-PACKARD CO., 395 Page Mill Rd., Palo Alto, Calif. ADV. PG. 33-36.
- JONES ELECTRONICS CO., M. C., Bristol, Conn. ADV. PG. 384.
- KINGS MICROWAVE CO., INC., 50 Marbledale Rd., Tuckahoe 7, N. Y. ADV. PG. 178, 179.
- McMurdo Silver Co., Inc., 417 Lafayette St., New York, N. Y.
- MARCONI INSTRUMENTS, LTD., 23 Beaver St., New York 4, N. Y. ADV. PG. 270.
- Millen Mfg. Co., James, 150 Exchange St., Malden, Mass.

- POLYTECHNIC RESEARCH & DEVELOPMENT CO., INC., 202 Tillary St., Brooklyn 1, N. Y. ADV. PG. 172, 173.
- Rollin Co., 2070 N. Fair Oaks Ave., Pasadena 3, Calif.
- SPERRY GYROSCOPE CO., Div. of The Sperry Corp., Great Neck, N. Y. ADV. PG. 103, 104.

METERS—Thermocouple

- Assembly Products, Inc., Chagrin Falls 6, Ohio.
- Bristol Co., The, Waterbury 20, Conn.
- Cole Instrument Co., 1320 S. Grand Ave., Los Angeles 15, Calif.
- GENERAL ELECTRIC CO., Schenectady 5, N. Y. ADV. PG. 1 to 22.
- Gordon Co., Claud S., 3000 S. Wallace St., Chicago 16, Ill.
- HICKOK ELECTRICAL INSTRUMENT CO., 10514 Dupont Ave., Cleveland 8, Ohio. ADV. PG. 333.
- Leeds & Northrup Co., 4970 Stenton Ave., Philadelphia 44, Pa.
- MARION ELECTRICAL INSTRUMENT CO., Manchester, N. H. ADV. PG. 200.
- Meters, Inc., 915 Westfield Blvd., Indianapolis 20, Ind.
- MINNEAPOLIS-HONEYWELL REGULATOR CO., INDUSTRIAL DIV., Wayne & Roberts Aves., Philadelphia 44, Pa. ADV. PG. 208, 209.
- Rawson Electrical Instrument Co., 111 Potter St., Cambridge 42, Mass.
- Sensitive Research Instrument Corp., 9 Elm Ave., Mt. Vernon, N. Y.
- Simpson Electric Co. Div., American Gage & Machine Co., 5218 Kinzie St., Chicago 44, Ill.
- Welch Scientific Co., W. M., 1515 Sedgwick St., Chicago 10, Ill.
- WESTINGHOUSE ELECTRIC CORP., 511 Wood St., P. O. Box 868, Pittsburgh 30, Pa. ADV. PG. 107-113.
- WESTON ELECTRICAL INSTRUMENT CORP., 595 Frelinghuysen Ave., Newark 5, N. J. ADV. PG. 243.
- Wheelock Instruments Co., 847 W. Harrison St., Chicago 7, Ill.
- Winslow Co., Inc., 9 Liberty St., Newark 5, N. J.

METERS—Vibration

- Biddle Co., James G., 1316 Arch St., Philadelphia 7, Pa.
- CALIDYNE CO., THE, 751 Main St., Winchester, Mass. ADV. PG. 239.
- Consolidated Engineering Corp., 300 N. Sierra Madre Villa, Pasadena 8, Calif.
- Davies Laboratories, Inc., The, 4705 Queensbury Rd., Riverdale, Md.
- ELECTRO PRODUCTS LABS., 4501 N. Ravenswood Ave., Chicago 40, Ill. ADV. PG. 199.
- GENERAL ELECTRIC CO., Schenectady 5, N. Y. ADV. PG. 1 to 22.
- GENERAL RADIO CO., 275 Massachusetts Ave., Cambridge 39, Mass. ADV. PG. 48, 49.
- INDUSTRIAL ELECTRONICS, INC., 8080 Wheeler St., Detroit 10, Mich. ADV. PG. 234, 235.
- M B MFG. CO., 1060 State St., New Haven 11, Conn. ADV. PG. 365.
- Scott, Inc., Hermon Hosmer, 385 Putnam Ave., Cambridge 39, Mass.
- SPERRY GYROSCOPE CO., Div. of The Sperry Corp., Great Neck, N. Y. ADV. PG. 103, 104.
- VICTOREEN INSTRUMENT CO., 5806 Hough Ave., Cleveland 3, Ohio. ADV. PG. 272, 273.

METERS—Viscosity

- Fischer & Porter Co., Hatboro, Pa.
- Fisher Scientific Co., 717 Forbes St., Pittsburgh 19, Pa.
- GENERAL ELECTRIC CO., Schenectady 5, N. Y. ADV. PG. 1 to 22.
- Tech Laboratories, Inc., Bergen & Edsall Bldvs., Palisades Park, N. J.

METERS—Wave

- Decimeter, Inc., 1430 Market St., Denver 2, Colorado.
- Diamond Mfg. Co., Wakefield, Mass.
- Frequency Standards Corp., Box 66, Eatontown, N. J.
- General R-F Fittings Co., 702 Beacon St., Boston 15, Mass.
- GENERAL RADIO CO., 275 Massachusetts Ave., Cambridge 39, Mass. ADV. PG. 48, 49.
- KINGS MICROWAVE CO., INC., 50 Marbledale Rd., Tuckahoe 7, N. Y. ADV. PG. 178, 179.
- MARCONI INSTRUMENTS, LTD., 23 Beaver St., New York 4, N. Y. ADV. PG. 270.
- MICO INSTRUMENT CO., 76 Trowbridge St., Cambridge 38, Mass. ADV. PG. 381.
- Millen Mfg. Co., James, 150 Exchange St., Malden, Mass.
- POLYTECHNIC RESEARCH & DEVELOPMENT CO., INC., 202 Tillary St., Brooklyn 1, N. Y. ADV. PG. 172, 173.
- SPERRY GYROSCOPE CO., Div. of The Sperry Corp., Great Neck, N. Y. ADV. PG. 103, 104.

METERS, WOW AND FLUTTER

- Furst Electronics, 10 S. Jefferson St., Chicago 6, Ill.

METERS—X-Ray Intensity

- Anton Electronic Laboratories, Inc., 1226-1238 Flushing Ave., Brooklyn 6, N. Y.
- Douglas Radio Labs., 176 Norfolk Ave., Boston 19, Mass.
- Farrand Optical Co., Inc., Bronx Blvd. at 238th St., New York 70, N. Y.
- General Electric X-Ray Corp., 4855 Electric Ave., Milwaukee, Wis.
- Georator Corp., 1820 N. Nash St., Arlington, Va.
- Kelley-Koett Instrument Co., 962 York St., Cincinnati 14, Ohio.
- MARCONI INSTRUMENTS, LTD., 23 Beaver St., New York 4, N. Y. ADV. PG. 270.
- North American Philips Co., Inc., 100 E. 42nd St., New York 17, N. Y.
- Nuclear Research Corp., 2707 Federal St., Philadelphia 46, Pa.
- Nuclidean Corp. of America, The, 497 Union St., Brooklyn 31, N. Y.
- Process & Instruments, 60 Greenpoint Ave., Brooklyn 22, N. Y.
- R-C Scientific Instrument Co., 335 Culver Blvd., Playa Del Rey, Calif.
- VICTOREEN INSTRUMENT CO., 5806 Hough Ave., Cleveland 3, Ohio. ADV. PG. 272, 273.
- WESTINGHOUSE ELECTRIC CORP., 511 Wood St., P. O. Box 868, Pittsburgh 30, Pa. ADV. PG. 107-113.

MICA**See Insulation Materials****MICROAMMETERS**

- AIRMEC LABORATORIES, LTD., 366 Madison Ave., New York 17, N. Y. ADV. PG. 336.
- Assembly Products, Inc., Chagrin Falls 6, Ohio.
- Associated Research, Inc., 3758 W. Belmont, Chicago 18, Ill.
- Beede Electrical Instrument Co., Inc., Penacook, N. H.
- Burlington Instrument Co., Burlington, Iowa.
- Cole Instrument Co., 1320 S. Grand Ave., Los Angeles 15, Calif.
- DEJUR-AMSCO CORP., Northern Blvd. at 45th St., Long Island City 1, N. Y. ADV. PG. 377.
- Electric Design & Mfg. Corp., Burlington, Iowa.
- G-M LABORATORIES, 4313 N. Knox Ave., Chicago, Ill. ADV. PG. 392.
- GENERAL ELECTRIC CO., Schenectady 5, N. Y. ADV. PG. 1 to 22.
- HICKOK ELECTRICAL INSTRUMENT CO., 10514 Dupont Ave., Cleveland 8, Ohio. ADV. PG. 333.
- INTERNATIONAL INSTRUMENTS, INC., 331 East St., New Haven 11, Conn. ADV. PG. 322.
- Macdonald Co., Inc., W. S., 33 University Rd., Cambridge 38, Mass.
- MARION ELECTRICAL INSTRUMENT CO., Manchester, N. H. ADV. PG. 200.
- Meters, Inc., 915 Westfield Blvd., Indianapolis 20, Ind.
- Oak Ridge Products Mfg. Div., of Video Television, Inc., 37-01 Vernon Blvd., Long Island 1, N. Y.
- Philco Corp., Tioga & C Sts., Philadelphia 34, Pa.
- RADIO CORP. OF AMERICA, Tube Dept., Harrison, N. J. ADV. PG. 177, Inside Back & Back Covers.
- Rawson Electrical Instrument Co., 111 Potter St., Cambridge 42, Mass.
- Roller-Smith, Bethlehem, Pa.
- Sensitive Research Instrument Corp., 9 Elm Ave., Mt. Vernon, N. Y.
- Simpson Electric Co. Div., American Gage & Machine Co., 5218 W. Kinzie St., Chicago 44, Ill.
- Supreme Inc., Greenwood, Miss.
- Triplett Electrical Instrument Co., Harmon Road, Bluffton, Ohio.
- Welch Scientific Co., W. M., 1515 Sedgwick St., Chicago 10, Ill.
- WESTINGHOUSE ELECTRIC CORP., 511 Wood St., P. O. Box 868, Pittsburgh 30, Pa. ADV. PG. 107-113.
- WESTON ELECTRICAL INSTRUMENT CORP., 595 Frelinghuysen Ave., Newark 5, N. J. ADV. PG. 243.

MICRO-MICROAMMETERS

- AIRMEC LABORATORIES, LTD., 366 Madison Ave., New York 17, N. Y. ADV. PG. 336.
- Beckman Instruments, Inc., 820 Mission St., South Pasadena, Calif.
- BETA ELECTRIC CORP., 1762 3rd Ave., New York 29, N. Y. ADV. PG. 399.
- Brujak Electronic Corp., 103 Lafayette St., New York 13, N. Y.
- INDUSTRIAL CONTROL CO., Straight Path & Arlington Ave., Wyandanch, N. Y. ADV. PG. 130.
- KEITHLEY INSTRUMENTS, 1507 Warrensville Center Rd., Cleveland 21, Ohio. ADV. PG. 337.
- MILLIVAC INSTRUMENT CORP., Box 3027, New Haven, Conn. ADV. PG. 402.

Ⓢ indicates . . . IN PRODUCTION • AVAILABILITY • UNRESTRICTED FOR GENERAL USE

Process & Instruments, 60 Greenpoint Ave., Brooklyn 22, N. Y.

- Ⓢ Rawson Electrical Instrument Co., 111 Potter St., Cambridge 42, Mass.
- Ⓢ Varo Mfg. Co., Inc., Box 638, Garland, Texas.
- Ⓢ WESTON ELECTRICAL INSTRUMENT CORP., 595 Frelinghuysen Ave., Newark 5, N. J. ADV. PG. 243.

MICROFARADAMETERS

- Ⓢ HICKOK ELECTRICAL INSTRUMENT CO., 10514 Dupont Ave., Cleveland 8, Ohio. ADV. PG. 333.
- Ⓢ McMurdo Silver Co., Inc., 417 Lafayette St., New York, N. Y.
- Ⓢ WESTON ELECTRICAL INSTRUMENT CORP., 595 Frelinghuysen Ave., Newark 5, N. J. ADV. PG. 243.

MICROMETERS—Electronic

- Ⓢ Carson Microameter Corp., 2 E. Main St., Little Falls, N. J.
- Ⓢ GENERAL ELECTRIC CO., Schenectady 5, N. Y. ADV. PG. 1 to 22.
- Ⓢ INDUSTRIAL ELECTRONICS, INC., 8080 Wheeler St., Detroit 10, Mich. ADV. PG. 234, 235.
- Ⓢ Wilmotte Inc., Raymond M., 1469 Church St., N. W., Washington 5, D. C.

MICROPHONES—Aircraft Type

- Ⓢ American Microphone Co., 370 S. Fair Oaks Ave., Pasadena 1, Calif.
- Ⓢ Connecticut Telephone & Electric Corp., 70 Britannia St., Meriden, Conn.
- Ⓢ GLASER-STEERS CORP., 2 Main St., Belleville 9, N. J. ADV. PG. 359.
- Ⓢ ROANWELL CORP., 662 Pacific St., Brooklyn 17, N. Y. ADV. PG. 403.

MICROPHONES—Carbon

- Ⓢ American Microphone Co., 370 S. Fair Oaks Ave., Pasadena 1, Calif.
- Ⓢ Astatic Corp., The, Conneaut, Ohio.
- Ⓢ Automatic Electric Sales Corp., 1033 W. Van Buren St., Chicago 7, Ill.
- Ⓢ Bunnell & Co., J. H., 81 Prospect St., Brooklyn, N. Y.
- Ⓢ Connecticut Telephone & Electric Corp., 70 Britannia St., Meriden, Conn.
- Ⓢ ELECTRO-VOICE, INC., Buchanan, Mich. ADV. PG. 345.
- Ⓢ Kaar Engineering Co., 2995 Middlefield Rd., P.O. Box 1320, Palo Alto, Calif.
- Ⓢ KELLOGG SWITCHBOARD & SUPPLY CO., 6650 S. Cicero Ave., Chicago 38, Ill. ADV. PG. 294.
- Ⓢ LaMagna Mfg. Co., Inc., East Rutherford, N. J.
- Ⓢ MARCONI INSTRUMENTS, LTD., 23 Beaver St., New York 4, N. Y. ADV. PG. 270.
- Ⓢ Philmore Mfg. Co., 113 University Place, New York 3, N. Y.
- Ⓢ ROANWELL CORP., 662 Pacific St., Brooklyn 17, N. Y. ADV. PG. 403.
- Ⓢ SHURE BROTHERS, INC., 225 W. Huron St., Chicago 10, Ill. ADV. PG. 230.
- Ⓢ Soundscribe Corp., 146 Munson St., New Haven, Conn.
- Ⓢ TANNNOY, 350 Fifth Ave., New York 1, N. Y. ADV. PG. 412.
- Ⓢ Telephonics Corp., Park Ave., Huntington, N. Y.
- Ⓢ TRIX ELECTRICAL MFG. CO., LTD., 366 Madison Ave., New York 17, N. Y. ADV. PG. 336.
- Ⓢ TURNER CO., THE, 909 17th St., N. E., Cedar Rapids, Iowa. ADV. PG. 73.
- Ⓢ UNIVERSITY LOUDSPEAKERS INC., 80 S. Kenisco Ave., White Plains, N. Y. ADV. PG. 38.

MICROPHONES—Condenser

- Ⓢ Altec-Lansing Corp., 9356 Santa Monica Blvd., Beverly Hills, Calif.
- Ⓢ Glenco Corp., Metuchen, N. J.
- Ⓢ Gulton Mfg. Corp., Metuchen, N. J.
- Ⓢ KELLOGG SWITCHBOARD & SUPPLY CO., 6650 S. Cicero Ave., Chicago 38, Ill. ADV. PG. 294.
- Ⓢ MARCONI INSTRUMENTS, LTD., 23 Beaver St., New York 4, N. Y. ADV. PG. 270.
- Ⓢ Stephens Mfg. Corp., 8538 Warner Drive, Culver City, Calif.
- Ⓢ TANNNOY, 350 Fifth Ave., New York 1, N. Y. ADV. PG. 412.

MICROPHONES—Contact

- Ⓢ American Microphone Co., 370 So. Fair Oaks Ave., Pasadena 1, Calif.
- Ⓢ AMPERITE CO., 561 Broadway, New York 12, N. Y. ADV. PG. 323.
- Ⓢ Astatic Corp., The, Conneaut, Ohio.
- Ⓢ BEAD CHAIN MFG. CO., 110 Mountain Grove St., Bridgeport 5, Conn. ADV. PG. 136.
- Ⓢ BRUSH DEVELOPMENT CO., 3405 Perkins Ave., Cleveland 14, Ohio. ADV. PG. 228, 229.
- Ⓢ ELECTRO-VOICE, INC., Buchanan, Mich. ADV. PG. 345.
- Ⓢ TANNNOY, 350 Fifth Ave., New York 1, N. Y. ADV. PG. 412.

Ⓢ TURNER CO., THE, 909 17th St., N. E., Cedar Rapids, Iowa. ADV. PG. 73.

MICROPHONES—Crystal

- Ⓢ American Microphone Co., 370 So. Fair Oaks Ave., Pasadena 1, Calif.
- Ⓢ Astatic Corp., The, Conneaut, Ohio.
- Ⓢ BRUSH DEVELOPMENT CO., 3405 Perkins Ave., Cleveland 14, Ohio. ADV. PG. 228, 229.
- Ⓢ Daystrom Electric Corp., 837 Main St., Poughkeepsie, N. Y.
- Ⓢ ELECTRO-VOICE, INC., Buchanan, Mich. ADV. PG. 345.
- Ⓢ Glenco Corp., Metuchen, N. J.
- Ⓢ Gulton Mfg. Corp., Metuchen, N. J.
- Ⓢ MARCONI INSTRUMENTS, LTD., 23 Beaver St., New York 4, N. Y. ADV. PG. 270.
- Ⓢ Massa Laboratories, 3868 Carnegie St., Cleveland, Ohio.
- Ⓢ SHURE BROTHERS, INC., 225 W. Huron St., Chicago 10, Ill. ADV. PG. 230.
- Ⓢ Sonotone Corp., P.O. Box 200, Saw Mill Rd., Elmsford, N. Y.
- Ⓢ TANNNOY, 350 Fifth Ave., New York 1, N. Y. ADV. PG. 412.
- Ⓢ Tibbetts Industries, Inc., Camden, Maine.
- Ⓢ TURNER CO., THE, 909 17th St., N. E., Cedar Rapids, Iowa. ADV. PG. 73.

MICROPHONES—Dynamic

- Ⓢ Altec Lansing Corp., 9356 Santa Monica Blvd., Beverly Hills, Calif.
- Ⓢ American Microphone Co., 370 So. Fair Oaks Ave., Pasadena 1, Calif.
- Ⓢ AMPERITE CO., 561 Broadway, New York 12, N. Y. ADV. PG. 323.
- Ⓢ Astatic Corp., The, Conneaut, Ohio.
- Ⓢ Daystrom Electric Corp., 837 Main St., Poughkeepsie, N. Y.
- Ⓢ ELECTRO-VOICE, INC., Buchanan, Mich. ADV. PG. 345.
- Ⓢ GLASER-STEERS CORP., 2 Main St., Belleville 9, N. J. ADV. PG. 359.
- Ⓢ PERMOFLUX CORP., 4900 W. Grand Ave., Chicago 39, Ill. ADV. PG. 321.
- Ⓢ RADIO CORP. OF AMERICA, RCA Victor Div., General Offices, Camden, N. J. ADV. PG. 177, Inside Back & Back Covers.
- Ⓢ ROANWELL CORP., 662 Pacific St., Brooklyn 17, N. Y. ADV. PG. 403.
- Ⓢ SHURE BROTHERS, INC., 225 W. Huron St., Chicago 10, Ill. ADV. PG. 230.
- Ⓢ Soundscribe Corp., 146 Munson St., New Haven 4, Conn.
- Ⓢ Standard Telephones & Cables Ltd., Connaught House, Aldwych, London, W. C. 2, England.
- Ⓢ TANNNOY, 350 Fifth Ave., New York 1, N. Y. ADV. PG. 412.
- Ⓢ Telephonics Corp., Park Ave., Huntington, N. Y.
- Ⓢ TRIX ELECTRICAL MFG. CO., LTD., 366 Madison Ave., New York 17, N. Y. ADV. PG. 336.
- Ⓢ TURNER CO., THE, 909 17th St., N. E., Cedar Rapids, Iowa. ADV. PG. 73.

MICROPHONES—Noise Cancelling

- Ⓢ Astatic Corp., The, Conneaut, Ohio.
- Ⓢ ELECTRO-VOICE, INC., Buchanan, Mich. ADV. PG. 345.
- Ⓢ GLASER-STEERS CORP., 2 Main St., Belleville 9, N. J. ADV. PG. 359.
- Ⓢ Glenco Corp., Metuchen, N. J.
- Ⓢ Gulton Mfg. Corp., Metuchen, N. J.
- Ⓢ RADIO CORP. OF AMERICA, RCA Victor Div., General Offices, Camden, N. J. ADV. PG. 177, Inside Back & Back Covers.
- Ⓢ ROANWELL CORP., 662 Pacific St., Brooklyn 17, N. Y. ADV. PG. 403.
- Ⓢ TANNNOY, 350 Fifth Ave., New York 1, N. Y. ADV. PG. 412.
- Ⓢ TRIX ELECTRICAL MFG. CO., LTD., 366 Madison Ave., New York 17, N. Y. ADV. PG. 336.
- Ⓢ TURNER CO., THE, 909 17th St., N. E., Cedar Rapids, Iowa. ADV. PG. 73.

MICROPHONES—Velocity

- Ⓢ Altec Lansing Corp., 9356 Santa Monica Blvd., Beverly Hills, Calif.
- Ⓢ AMPERITE CO., 561 Broadway, New York 12, N. Y. ADV. PG. 323.
- Ⓢ ELECTRO-VOICE, INC., Buchanan, Mich. ADV. PG. 345.
- Ⓢ MARCONI INSTRUMENTS, LTD., 23 Beaver St., New York 4, N. Y. ADV. PG. 270.
- Ⓢ RADIO CORP. OF AMERICA, RCA Victor Div., General Offices, Camden, N. J. ADV. PG. 177, Inside Back & Back Covers.
- Ⓢ TANNNOY, 350 Fifth Ave., New York 1, N. Y. ADV. PG. 412.
- Ⓢ TRIX ELECTRICAL MFG. CO., LTD., 366 Madison Ave., New York 17, N. Y. ADV. PG. 336.
- Ⓢ TURNER CO., THE, 909 17th St., N. E., Cedar Rapids, Iowa. ADV. PG. 73.

MICROSCOPES—Electron

- Ⓢ North American Phillips Co., Inc., 100 E. 42nd St., New York 17, N. Y.
- Ⓢ RADIO CORP. OF AMERICA, RCA Victor Div., General Offices, Camden, N. J. ADV. PG. 177, Inside Back & Back Covers.

MICROWAVE TRANSMISSION LINES & MICRO-WAVE ACCESSORIES

- Ⓢ AIRTRON, INC., 101 E. Elizabeth Ave., Linden, N. J. ADV. PG. 317.
- Ⓢ Diamond Mfg. Co., Wakefield, Mass.
- Ⓢ Elecdar Co., Portsmouth, N. H.
- Ⓢ Electro Precision Products Inc., 119-01 22nd Ave., College Point, N. Y.
- Ⓢ FEDERAL TELEPHONE & RADIO CORP., 88 Kingsland Rd., Clifton, N. J. ADV. PG. 161-163.
- Ⓢ General R-F Fittings Co., 702 Beacon St., Boston 15, Mass.
- Ⓢ GENERAL RADIO CO., 275 Massachusetts Ave., Cambridge 39, Mass. ADV. PG. 48, 49.
- Ⓢ KINGS MICROWAVE CO., INC., 50 Marbledale Rd., Tuckahoe 7, N. Y. ADV. PG. 178, 179.
- Ⓢ Microwave Equipment Co., Inc., North Caldwell, N. J.
- Ⓢ POLYTECHNIC RESEARCH & DEVELOPMENT CO., INC., 202 Tillary St., Brooklyn 1, N. Y. ADV. PG. 172, 173.
- Ⓢ PRODUCT DEVELOPMENT CO., INC., Arlington, N. J. ADV. PG. 362.
- Ⓢ Radio Engineering Laboratories, Inc., 36-40 37th St., Long Island City 1, N. Y.
- Ⓢ Selector Industries, Inc., 401 E. 138th St., New York 54, N. Y.
- Ⓢ Schutter, Carl W., Rockville Centre, N. Y.
- Ⓢ SPERRY GYROSCOPE CO., Div. of The Sperry Corp., Great Neck, N. Y. ADV. PG. 103, 104.
- Ⓢ Standard Metals Corp., 262 Broad St., North Attleboro, Mass.
- Ⓢ TECHNICRAFT LABORATORIES, INC., Thomaston-Waterbury Rd., Thomaston, Conn. ADV. PG. 342.
- Ⓢ Weymouth Instrument Co., 1440 Commercial St., East Weymouth 89, Mass.
- Ⓢ Wheeler Laboratories, Inc., Great Neck, N. Y.

MILLIAMMETERS

- Ⓢ Assembly Products, Inc., Chagrin Falls 6, Ohio.
- Ⓢ Associated Research, Inc., 3758 W. Belmont, Chicago 18, Ill.
- Ⓢ Beede Electrical Instrument Co., Inc., Penacook, N. H.
- Ⓢ Burlington Instrument Co., Burlington, Iowa.
- Ⓢ Cole Instrument Co., 1320 S. Grand Ave., Los Angeles 15, Calif.
- Ⓢ DEJUR-AMSCO CORP., Northern Blvd., at 45th St., Long Island City 1, N. Y. ADV. PG. 377.
- Ⓢ Electric Design & Mfg. Corp., Burlington, Iowa.
- Ⓢ Electro-Mechanical Instrument Co., 812 Chestnut St., Parkside, Pa.
- Ⓢ ELECTRONIC INSTRUMENT CO., INC., 276 Newport St., Brooklyn 12, N. Y. ADV. PG. 129.
- Ⓢ Esterline-Angus Co., Inc., P. O. Box 596, Indianapolis, Ind.
- Ⓢ Feller Engineering Co., 8026 Monticello Ave., Skokie, Ill.
- Ⓢ GENERAL ELECTRIC CO., Schenectady 5, N. Y. ADV. PG. 1 to 22.
- Ⓢ HICKOK ELECTRICAL INSTRUMENT CO., 10514 Dupont Ave., Cleveland 8, Ohio. ADV. PG. 333.
- Ⓢ INTERNATIONAL INSTRUMENTS, INC., 331 East St., New Haven 11, Conn. ADV. PG. 322.
- Ⓢ MARION ELECTRICAL INSTRUMENT CO., Manchester, N. H. ADV. PG. 200.
- Ⓢ McMurdo Silver Co., Inc., 417 Lafayette St., New York, N. Y.
- Ⓢ Metropolitan Electronics & Instruments Co., 106 Fifth Ave., New York 11, N. Y.
- Ⓢ Oak Ridge Products Mfg. Div. of Video Television, Inc., 37-01 Vernon Blvd., Long Island City 1, N. Y.
- Ⓢ Philco Corp., Tioga & C Sts., Philadelphia 34, Pa.
- Ⓢ Rawson Electrical Instrument Co., 111 Potter St., Cambridge 42, Mass.
- Ⓢ Reliance Instrument Co., 3027 W. Van Buren St., Chicago 12, Ill.
- Ⓢ Roller-Smith, Bethlehem, Pa.
- Ⓢ Sensitive Research Instrument Corp., 9 Elm Ave., Mt. Vernon, N. Y.
- Ⓢ SHURITE METERS, 35-B Hamilton St., New Haven 8, Conn. ADV. PG. 390.
- Ⓢ Simpson Electric Co. Div., American Gage & Machine Co., 5218 W. Kinzie St., Chicago 44, Ill.
- Ⓢ Sterling Mfg. Co., 9205 Detroit Ave., Cleveland 2, Ohio.
- Ⓢ Supreme, Inc., Greenwood, Miss.
- Ⓢ SYLVANIA ELECTRIC PRODUCTS, INC., 1740 Broadway, New York 19, N. Y. ADV. PG. 432-436.
- Ⓢ Triplett Electrical Instrument Co., Harmon Rd., Bluffton, Ohio.
- Ⓢ Welch Scientific Co., W. M., 1515 Sedgwick St., Chicago 10, Ill.
- Ⓢ WESTINGHOUSE ELECTRIC CORP., 511 Wood St., P. O. Box 868, Pittsburgh 30, Pa. ADV. PG. 107, 113.
- Ⓢ WESTON ELECTRICAL INSTRUMENT CORP., 595 Frelinghuysen Ave., Newark 5, N. J. ADV. PG. 243.

Ⓜ indicates . . . IN PRODUCTION • AVAILABILITY • UNRESTRICTED FOR GENERAL USE

MILLIVOLTMETERS

- Ⓜ AIRMEC LABORATORIES, LTD., 366 Madison Ave., New York 17, N. Y. ADV. PG. 336.
- Ⓜ Assembly Products, Inc., Chagrin Falls 6, Ohio.
- Ⓜ Associated Research, Inc., 3758 W. Belmont, Chicago 18, Ill.
- Ⓜ BALLANTINE LABORATORIES, Boonton, N. J. ADV. PG. 125.
- Ⓜ Beede Electrical Instrument Co., Inc., Penacook, N. H.
- Ⓜ Burlington Instrument Co., Burlington, Iowa.
- Ⓜ Cole Instrument Co., 1320 S. Grand Ave., Los Angeles 15, Calif.
- Ⓜ DEJUR-AMSCO CORP., Northern Blvd. at 45th St., Long Island City 1, N. Y. ADV. PG. 377.
- Ⓜ EDIN CO., INC., 207 Main St., Worcester, Mass. ADV. PG. 285.
- Ⓜ Electric Design & Mfg. Corp., Burlington, Iowa.
- Ⓜ Electro-Mechanical Instrument Co., 812 Chestnut St., Perkasie, Pa.
- Ⓜ ELECTRONIC INSTRUMENT CO., INC., 276 Newport St., Brooklyn 12, N. Y. ADV. PG. 129.
- Ⓜ Esterline-Angus Co., Inc., P. O. Box 596, Indianapolis, Ind.
- Ⓜ G-M LABORATORIES, 4313 N. Knox Ave., Chicago, Ill. ADV. PG. 392.
- Ⓜ GENERAL ELECTRIC CO., Schenectady 5, N. Y. ADV. PG. 1 to 22.
- Ⓜ INDUSTRIAL CONTROL CO., Straight Path & Arlington Ave., Wyandanch, N. Y. ADV. PG. 130.
- Ⓜ INTERNATIONAL INSTRUMENTS, INC., 331 East St., New Haven 11, Conn. ADV. PG. 322.
- Ⓜ McMurdo Silver Co., Inc., 417 Lafayette St., New York, N. Y.
- Ⓜ MARCONI INSTRUMENTS, LTD., 23 Beaver St., New York 4, N. Y. ADV. PG. 270.
- Ⓜ MARION ELECTRICAL INSTRUMENT CO., Manchester, N. H. ADV. PG. 200.
- Ⓜ Meters, Inc., 915 Westfield Blvd., Indianapolis 20, Ind.
- Ⓜ Metropolitan Electronics & Instruments Co., 106 Fifth Ave., New York 11, N. Y.
- Ⓜ Oak Ridge Products Mfg. Div. of Video Television, Inc., 37-01 Vernon Blvd., Long Island City 1, N. Y.
- Ⓜ Rawson Electrical Instruments Co., 111 Potter St., Cambridge 42, Mass.
- Ⓜ Reliance Instrument Co., 3027 W. Van Buren St., Chicago 12, Ill.
- Ⓜ Roller-Smith, Bethlehem, Pa.
- Ⓜ Sensitive Research Instrument Corp., 9 Elm Ave., Mt. Vernon, N. Y.
- Ⓜ Simpson Electric Co., Div., American Gage & Machine Co., 5218 W. Kinzie St., Chicago 44, Ill.
- Ⓜ Supreme, Inc., Greenwood, Miss.
- Ⓜ SYLVANIA ELECTRIC PRODUCTS, INC., 1740 Broadway, New York 19, N. Y. ADV. PG. 432-436.
- Ⓜ Thwing-Albert Instrument Co., 5351 Pulaski Ave., Philadelphia 44, Pa.
- Ⓜ Triplett Electrical Instrument Co., Harmon Rd., Bluffton, Ohio.
- Ⓜ Waveforms, Inc., 333 Sixth Ave., New York 14, N. Y.
- Ⓜ Welch Scientific Co., W. M., 1515 Sedgwick St., Chicago 10, Ill.
- Ⓜ WESTINGHOUSE ELECTRIC CORP., 511 Wood St., P. O. Box 868, Pittsburgh 30, Pa. ADV. PG. 107-113.
- Ⓜ WESTON ELECTRICAL INSTRUMENT CORP., 595 Frelinghuysen Ave., Newark 5, N. J. ADV. PG. 243.
- Ⓜ Wheelco Instruments Co., 847 W. Harrison St., Chicago 7, Ill.

MIRRORS—Special Purpose

- Ⓜ Liberty Mirror Div., Libbey-Owens-Ford Glass Co., Tarentum, Pa.

MIRRORS—Television

- Ⓜ Bache & Co., Semon, 636 Greenwich St., New York 14, N. Y.
- Ⓜ General Cement Mfg. Co., 919 Taylor Ave., Rockford, Ill.
- Ⓜ Optical Film Engineering Co., 2125 Cherry St., Philadelphia 3, Pa.
- Ⓜ Pancro Mirrors Inc., 2958 Los Feliz Blvd., Los Angeles 39, Calif.
- Ⓜ Pittsburgh Plate Glass Co., 2000 Grant Bldg., Pittsburgh 19, Pa.
- Ⓜ TRAD TELEVISION CORP., 1001 First Ave., Asbury Park, N. J. ADV. PG. 355.
- Ⓜ Zenith Optical Lab., 1940 Great Neck Rd., Copiague L. I., N. Y.

MODULATORS—Magnetic

- Ⓜ Allis Chalmers Mfg. Co., 935 S. 70th St., Milwaukee, Wis.
- Ⓜ ALDEN PRODUCTS CO., 117 N. Main St., Brockton 64, Mass. ADV. PG. 327.
- Ⓜ BOGUE ELECTRIC MFG. CO., 52 Iowa Ave., Paterson 3, N. J. ADV. PG. 155.
- Ⓜ Cook Research Labs., 1457 Diversey Parkway, Chicago 14, Ill.
- Ⓜ ECLIPSE-PIONEER DIV., Bendix Aviation Corp., Teterboro, N. J. ADV. PG. 198, 199.

- Ⓜ FEDERAL TELEPHONE & RADIO CORP., 88 Kingsland Rd., Clifton, N. J. ADV. PG. 161-163.
- Ⓜ Kearfott Mfg. Corp., 75 Hudson St., Newark, N. J.
- Ⓜ MAGNETIC AMPLIFIERS INC., 1154 44th Drive, Long Island City 1, N. Y. ADV. PG. 346.
- Ⓜ Magnetics, Inc., 135 Bloomfield Ave., Bloomfield, N. J.
- Ⓜ SORENSEN & CO., INC., 375 Fairfield Ave., Stamford, Conn. ADV. PG. 66, 67.
- Ⓜ Standard Electrical Products Co., 400 Linden Ave., Dayton, Ohio.
- Ⓜ Transducer Corp., 1085 Commonwealth Ave., Boston 15, Mass.
- Ⓜ Varo Mfg. Co., Inc., Box 638, Garland, Texas.
- Ⓜ WARD-LEONARD ELECTRIC CO., 31 South St., Mt. Vernon, N. Y. ADV. PG. 69, 70.

MONITORS—Frequency

- Ⓜ AIRMEC LABORATORIES, LTD., 366 Madison Ave., New York 17, N. Y. ADV. PG. 336.
- Ⓜ BARKER & WILLIAMSON, 235 Fairfield Ave., Upper Darby, Pa. ADV. PG. 292.
- Ⓜ Bassett, Inc., Rex, 307-311 N.W. First Ave., Fort Lauderdale, Fla.
- Ⓜ Biddle Co., James G., 1316 Arch St., Philadelphia 7, Pa.
- Ⓜ BROWNING LABORATORIES, INC., 750 Main St., Winchester, Mass. ADV. PG. 257.
- Ⓜ Doolittle Radio, Inc., 7421 S. Loomis Blvd., Chicago 36, Ill.
- Ⓜ FEDERAL TELECOMMUNICATION LABS., INC., 500 Washington Ave., Nutley, N. J. ADV. PG. 164.
- Ⓜ Gates Radio Co., Quincy, Ill.
- Ⓜ HEWLETT-PACKARD CO., 395 Page Mill Rd., Palo Alto, Calif. ADV. PG. 33-36.
- Ⓜ LAMPKIN LABORATORIES, INC., Bradenton, Fla. ADV. PG. 418.
- Ⓜ MARCONI INSTRUMENTS, LTD., 23 Beaver St., New York 4, N. Y. ADV. PG. 270.
- Ⓜ Monitor Products Co., 815 Fremont Ave., South Pasadena, Calif.
- Ⓜ Motorola, Inc., 4545 Augusta Blvd., Chicago 51, Ill.
- Ⓜ NORTHERN RADIO CO., INC., 143-145 W. 22nd St., New York 11, N. Y. ADV. PG. 262, 263.
- Ⓜ Neucleonic Corp. of America, 497 Union St., Brooklyn 31, N. Y.
- Ⓜ PANORAMIC RADIO PRODUCTS, INC., 10 S. Second Ave., Mt. Vernon, N. Y. ADV. PG. 383.
- Ⓜ POTTER INSTRUMENT CO., INC., 115 Cutter Mill Rd., Great Neck, N. Y. ADV. PG. 318.
- Ⓜ RADIO CORP. OF AMERICA, RCA Victor Div., General Offices, Camden, N. J. ADV. PG. 177, Inside Back & Back Covers.
- Ⓜ SPERRY GYROSCOPE CO., Div. of The Sperry Corp., Great Neck, N. Y. ADV. PG. 109, 104.
- Ⓜ West Coast Electronics Co., 1601 S. Burlington St., Los Angeles 6, Calif.

MONITORS—(FS) Transmitter

- Ⓜ AIRMEC LABORATORIES, LTD., 366 Madison Ave., New York 17, N. Y. ADV. PG. 336.
- Ⓜ BARKER & WILLIAMSON, 235 Fairfield Ave., Upper Darby, Pa. ADV. PG. 292.
- Ⓜ Erco Radio Labs., Inc., E. Stewart Ave., Garden City, N. Y.
- Ⓜ NORTHERN RADIO CO., INC., 143-145 W. 22nd St., New York 11, N. Y. ADV. PG. 262, 263.
- Ⓜ Press Wireless Mfg. Co., Inc., Cantiague Rd., Hicksville, L. I., N. Y.
- Ⓜ RADIO CORP. OF AMERICA, RCA Victor Div., General Offices, Camden, N. J. ADV. PG. 177, Inside Back & Back Covers.
- Ⓜ Robbins & Myers, Inc., 1345 Lagonda Ave., Springfield 99, Ohio.
- Ⓜ Technical Materiel Corp., The, P. O. Box 1422, 121 Spencer Pl., Mamaroneck, N. Y.

MONITORS—Modulation

- Ⓜ BARKER & WILLIAMSON, 235 Fairfield Ave., Upper Darby, Pa. ADV. PG. 292.
- Ⓜ BROWNING LABORATORIES, INC., 750 Main St., Winchester, Mass. ADV. PG. 257.
- Ⓜ Collins Radio Co., Cedar Rapids, Iowa.
- Ⓜ Doolittle Radio, Inc., 7421 S. Loomis Blvd., Chicago 36, Ill.
- Ⓜ Gates Radio Co., Quincy, Ill.
- Ⓜ GENERAL RADIO CO., 275 Massachusetts Ave., Cambridge 39, Mass. ADV. PG. 48, 49.
- Ⓜ HEWLETT-PACKARD CO., 395 Page Mill Rd., Palo Alto, Calif. ADV. PG. 33-36.
- Ⓜ LAMPKIN LABORATORIES, INC., Bradenton, Fla. ADV. PG. 418.
- Ⓜ MARCONI INSTRUMENTS, LTD., 23 Beaver St., New York 4, N. Y. ADV. PG. 270.
- Ⓜ Monitor Products Co., 815 Fremont Ave., So. Pasadena, Calif.
- Ⓜ Motorola, Inc., 4545 Augusta Blvd., Chicago 51, Ill.
- Ⓜ PANORAMIC RADIO PRODUCTS, INC., 10 South Second Ave., Mt. Vernon, N. Y. ADV. PG. 383.
- Ⓜ RADIO CORP. OF AMERICA, RCA Victor Div., General Offices, Camden, N. J. ADV. PG. 177, Inside Back & Back Covers.
- Ⓜ West Coast Electronics Co., 1601 S. Burlington St., Los Angeles 6, Calif.

MONITORS—Television

- Ⓜ Diamond Power Specialty Corp., Lancaster, Ohio.
- Ⓜ FEDERAL TELECOMMUNICATION LABS., INC., 500 Washington Ave., Nutley, N. J. ADV. PG. 164.
- Ⓜ FEDERAL TELEPHONE & RADIO CORP., 88 Kingsland Rd., Clifton, N. J. ADV. PG. 161-163.
- Ⓜ GENERAL PRECISION LABORATORY, INC., Pleasantville, N. Y. ADV. PG. 58, 59.
- Ⓜ GRAY RESEARCH & DEVELOPMENT CO. INC., 16 Arbor St., Hartford, Conn. ADV. PG. 163.
- Ⓜ HEWLETT-PACKARD CO., 395 Page Mill Rd., Palo Alto, Calif. ADV. PG. 33-36.
- Ⓜ Jamaica Electronic Products Co., 95-26 Sutphin Blvd., Jamaica 4, N. Y.
- Ⓜ MARCONI INSTRUMENTS, LTD., 23 Beaver St., New York 4, N. Y. ADV. PG. 270.
- Ⓜ Monarch Radio & Television Corp., 2430 Atlantic Ave., Brooklyn 33, N. Y.
- Ⓜ Multiple Television Mfg. Co., 987 Hegeman Ave., Brooklyn 8, N. Y.
- Ⓜ POLARAD ELECTRONICS CORP., 100 Metropolitan Ave., Brooklyn 11, N. Y. ADV. PG. 184, 185.
- Ⓜ RADIO CORP. OF AMERICA, RCA Victor Div., General Offices, Camden, N. J. ADV. PG. 177, Inside Back & Back Covers.
- Ⓜ Standard Telephones & Cables Ltd., Connaught House, Aldwych, London, W. C. 2, England.
- Ⓜ Telechrome, Inc., 88 Merrick Rd., Amityville, N. Y.
- Ⓜ Tequip Radio Co., 2559 W. 21st St., Chicago 8, Ill.
- Ⓜ Television Utilities Corp., 1261 Broadway, New York 1, N. Y.

MOTORS—Fractional hp

- Ⓜ Acro Mfg. Co., 2040 E. Main St., Columbus, Ohio.
- Ⓜ AIR ASSOCIATES INC., Teterboro, N. J. ADV. PG. 211.
- Ⓜ AIR-MARINE MOTORS, INC., 2183 Jackson Ave., Seaford, N. Y. ADV. PG. 376.
- Ⓜ Alliance Mfg. Co., Lake Park Blvd., Alliance, Ohio.
- Ⓜ Arma Corp., 254 36th St., Brooklyn, N. Y.
- Ⓜ Barber-Colman Co., Rockford, Ill.
- Ⓜ Bodine Electric Co., Ohio St. & Oakley Blvd., Chicago 12, Ill.
- Ⓜ Burke Electric Co., 12th & Cranberry Sts., Erie, Pa.
- Ⓜ Century Electric Co., 1806 Pine St., St. Louis 3, Mo.
- Ⓜ Cyclohm Motor Corp., Div., Howard Industries, Inc., Racine, Wis.
- Ⓜ Dalmator Co., 1375 Clay St., Santa Clara, Calif.
- Ⓜ Delco Appliance Div., General Motors Corp., 391 Lyell Ave., Rochester, N. Y.
- Ⓜ Diehl Mfg. Co., 1129 Finderne Ave., Somerville, N. J.
- Ⓜ Eastern Air Devices, Inc., 585 Dean St., Brooklyn 17, N. Y.
- Ⓜ Eicor, Inc., 1501 W. Congress St., Chicago 7, Ill.
- Ⓜ ELECTRIC INDICATOR CO., 21 Parker Ave., Stamford, Conn. ADV. PG. 338.
- Ⓜ Electric Motor Corp. Div., Howard Industries, Inc., Racine, Wis.
- Ⓜ Fasco Industries, Inc., Rochester 2, N. Y.
- Ⓜ Ford Instrument Co., Inc., 31-10 Thomson Ave., Long Island City, N. Y.
- Ⓜ G-M LABORATORIES, 4313 N. Knox Ave., Chicago, Ill. ADV. PG. 392.
- Ⓜ Gale Dorothea Mechanisms, 37-61 85th St., Jackson Heights, N. Y.
- Ⓜ GENERAL ELECTRIC CO., Schenectady 5, N. Y. ADV. PG. 1 to 22.
- Ⓜ General Industries Co., Taylor & Olive Sts., Elyria, Ohio.
- Ⓜ HAYDON CO., A. W., 232 N. Elm St., Waterbury 20, Conn. ADV. PG. 402.
- Ⓜ HEINZE ELECTRIC CO., 685 Lawrence St., Lowell, Mass. ADV. PG. 314.
- Ⓜ Hertner Electric Co., 12690 Elmwood Ave., Cleveland 11, Ohio.
- Ⓜ Holtzer-Cabot Div. of National Pneumatic Co., Inc., 125 Amory St., Boston 19, Mass.
- Ⓜ Kato Engineering Co., 1415 First Ave., Mankato, Minn.
- Ⓜ KOLLSMAN INSTRUMENT CORP., 80-08 45th St., Elmhurst, N. Y. ADV. PG. 304.
- Ⓜ L & R Mfg. Co., 577 Elm St., Arlington, N. J.
- Ⓜ Lear, Inc., 110 Ionia Ave., N.W., Grand Rapids 2, Mich.
- Ⓜ Leland Electric Co., The, 1501 Webster St., Dayton 1, Ohio.
- Ⓜ Marathon Electric Mfg. Corp., Randolph & Cherry Sts., Wasau, Wis.
- Ⓜ Marco Industries, Inc., 788 Terrace Blvd., Depew, N. Y.
- Ⓜ Master Appliance Mfg. Co., Fourth & Ontario Sts., Racine, Wis.
- Ⓜ Mission Electric Mfg. Co., 132 W. Colorado Blvd., Pasadena, Calif.
- Ⓜ OSTER MFG. CO., JOHN, 1 Main St., Racine, Wis. ADV. PG. 90.
- Ⓜ Rae Motor Corp., Box 291, Racine, Wis.
- Ⓜ RED BANK DIVISION, Bendix Aviation Corp., Red Bank, N. J. ADV. PG. 197.
- Ⓜ Redmond Co., Inc., Owosso, Mich.
- Ⓜ Robbins & Myers, Inc., 1345 Lagonda Ave., Springfield 99, Ohio.
- Ⓜ ROTRON MFG. CO., 7-9 Schoonmaker Lane, Woodstock, N. Y. ADV. PG. 410.
- Ⓜ Russell Electric Co., 4501 South Western Blvd., Chicago 9, Ill.

V indicates . . . IN PRODUCTION • AVAILABILITY • UNRESTRICTED FOR GENERAL USE

- ⊙SERVO-TEK PRODUCTS CO., 4 Godwin Ave., Paterson, N. J. ADV. PG. 356.
- ⊙Small Motors Inc., 2076 Elston Ave., Chicago 14, Ill.
- ⊙Speedway Mfg. Co., 1834 S. 52nd Ave., Cicero 50, Ill.
- ⊙SPERRY GYROSCOPE CO., Div. of The Sperry Corp., Great Neck, N. Y. ADV. PG. 103, 104.
- ⊙U. S. Electrical Motors, Inc., 200 E. Slauson Ave., Los Angeles 64, Calif.
- ⊙Universal Electric Co., 300 E. Main St., Owosso, Mich.
- ⊙Victor Electric Products, Inc., 2950 Robertson Ave., Cincinnati 9, Ohio.
- ⊙Wagner Electric Corp., 6400 Plymouth Ave., St. Louis, Mo.
- ⊙WESTINGHOUSE ELECTRIC CORP., 511 Wood St., P. O. Box 868, Pittsburgh 30, Pa. ADV. PG. 107-113.
- ⊙Wincharger Corp., E. 7th & Division Sts., Sioux City, Iowa.

MOTORS—Phonograph

- ⊙Alliance Mfg. Co., Lake Park Blvd., Alliance, Ohio.
- ⊙Bodine Electric Co., Ohio St. & Oakley Blvd., Chicago 12, Ill.
- ⊙Garrard Sales Corp., 164 Duane St., New York 13, N. Y.
- ⊙General Industries Co., Taylor & Olive Sts., Elyria, Ohio.
- ⊙Hartley Co., Ltd., H. A., 152 Hammersmith Rd., London W. 6, England.
- ⊙HEINZE ELECTRIC CO., 685 Lawrence St., Lowell, Mass. ADV. PG. 314.
- ⊙Lear, Inc., 110 Ionia Ave., N.W., Grand Rapids 2, Mich.
- ⊙Russell Electric Co., 4501 South Western Blvd., Chicago 9, Ill.
- ⊙Soundscriber Corp., 146 Munson St., New Haven 4, Conn.
- ⊙United Pressed Products Co., 741 W. Harrison St., Chicago 7, Ill.
- ⊙Webster-Chicago Corp., 5622 Bloomingdale Ave., Chicago 39, Ill.
- ⊙Wincharger Corp., E. 7th & Division Sts., Sioux City, Iowa.

MOTORS—Remote Control

- ⊙AIR ASSOCIATES INC., Teterboro, N. J. ADV. PG. 211.
- ⊙AIR-MARINE MOTORS, INC., 2183 Jackson Ave., Seaford, N. Y. ADV. PG. 376.
- American Electric Motors, Inc., Los Angeles, Calif.
- ⊙Arma Corp., 254 36th St., Brooklyn 32, N. Y.
- ⊙Barber-Colman Co., Rockford, Ill.
- ⊙Diehl Mfg. Co., 1129 Finnerne Ave., Somerville, N. J.
- ⊙Doelcam Corp., 56 Elmwood St., Newton 58, Mass.
- ⊙ELECTRIC INDICATOR CO., 21 Parker Ave., Stamford, Conn. ADV. PG. 338.
- ⊙GENERAL ELECTRIC CO., Schenectady 5, N. Y. ADV. PG. 1 to 22.
- ⊙General Industries Co., Taylor & Olive Sts., Elyria, Ohio.
- ⊙Hertner Electric Co., 12690 Elmwood Ave., Cleveland 11, Ohio.
- ⊙Lear, Inc., 110 Ionia Ave., N. W., Grand Rapids 2, Mich.
- ⊙Minneapolis-Honeywell Regulator Co., 2753 Fourth Ave., S., Minneapolis, Minn.
- ⊙Robinette Co., W. C., 802 Fair Oaks Ave., South Pasadena, Calif.
- ⊙Russell Electric Co., 4501 South Western Blvd., Chicago 9, Ill.
- ⊙SERVO-TEK PRODUCTS CO., 4 Godwin Ave., Paterson, N. J. ADV. PG. 356.

MOTORS—Servo

- ⊙AIR ASSOCIATES INC., Teterboro, N. J. ADV. PG. 211.
- American Electric Motors, Inc., Los Angeles, Calif.
- ⊙Arma Corp., 254 36th St., Brooklyn 32, N. Y.
- ⊙Avion Instrument Corp., Paramus, N. J.
- ⊙Barber-Colman Co., Rockford, Ill.
- ⊙Diehl Manufacturing Co., 1129 Finnerne Ave., Somerville, N. J.
- ⊙Doelcam Corp., 56 Elmwood St., Newton 58, Mass.
- ⊙Eastern Air Devices Inc., 585 Dean St., Brooklyn 17, N. Y.
- ⊙ECLIPSE-PIONEER DIV., Bendix Aviation Corp., Teterboro, N. J. ADV. PG. 198, 199.
- ⊙ELECTRIC INDICATOR CO., 21 Parker Ave., Stamford, Conn. ADV. PG. 338.
- ⊙Ford Instrument Co., Inc., 31-10 Thomson Ave., Long Island City, N. Y.
- ⊙GENERAL ELECTRIC CO., Schenectady 5, N. Y. ADV. PG. 1 to 22.
- ⊙Hansen Mfg. Co., Inc., Princeton 10, Indiana.
- ⊙Hertner Electric Co., 12690 Elmwood Ave., Cleveland 11, Ohio.
- ⊙Holtzer-Cabot Div. of National Pneumatic Co., Inc., 125 Amory St., Boston 19, Mass.
- ⊙Hydraulic Press Mfg. Co., Mt. Gilead, Ohio.
- ⊙Ketay Mfg. Corp., 555 Broadway, New York, N. Y.

- ⊙KOLLSMAN INSTRUMENT CORP., 80-08 45th Ave., Elmhurst, N. Y. ADV. PG. 304.
- ⊙Lear, Inc., 110 Ionia Ave., N.W., Grand Rapids 2, Mich.
- ⊙MINNEAPOLIS-HONEYWELL REGULATOR CO., INDUSTRIAL DIV., Wayne & Roberts Aves., Philadelphia 44, Pa. ADV. PG. 208, 209.
- ⊙OSTER MFG. CO., JOHN, 1 Main St., Racine, Wis. ADV. PG. 90.
- ⊙REEVES INSTRUMENT CORP., 215 E. 91st St., New York, N. Y. ADV. PG. 315.
- ⊙Russell Electric Co., 4501 South Western Blvd., Chicago 9, Ill.
- ⊙SERVO-TEK PRODUCTS CO., 4 Godwin Ave., Paterson 1, N. J. ADV. PG. 356.
- ⊙Small Motors, Inc., 2076 Elston Ave., Chicago 14, Ill.
- ⊙SPERRY GYROSCOPE CO., Div. of The Sperry Corp., Great Neck, N. Y. ADV. PG. 103, 104.
- ⊙TRANSICOIL CORP., 107 Grand St., New York, N. Y. ADV. PG. 116.
- ⊙Triumph Mfg. Co., 913 W. Van Buren St., Chicago 7, Ill.
- ⊙WESTINGHOUSE ELECTRIC CORP., 511 Wood St., P. O. Box 868, Pittsburgh 30, Pa. ADV. PG. 107-113.

MOTORS—Synchronous

- ⊙AIR-MARINE MOTORS, INC., 2183 Jackson Ave., Seaford, N. Y. ADV. PG. 376.
- ⊙Barber-Colman Co., Rockford, Ill.
- ⊙Bodine Electric Co., Ohio St. & Oakley Blvd., Chicago 12, Ill.
- ⊙Bristol Motor Co., Old Saybrook, Conn.
- ⊙Burke Electric Co., 12th & Cranberry Sts., Erie, Pa.
- ⊙Century Electric Co., 1806 Pine St., St. Louis 3, Mo.
- ⊙Continental Electric Co., Inc., 334 Ferry St., Newark 5, N. J.
- ⊙Cyclohm Motor Corp., Div., Howard Industries, Inc., Racine, Wis.
- ⊙Eastern Air Devices Inc., 585 Dean St., Brooklyn 17, N. Y.
- ⊙ELECTRIC INDICATOR CO., 21 Parker Ave., Stamford, Conn. ADV. PG. 338.
- ⊙Electric Machinery Mfg. Co., 1331 N.E. Tyler St., Minneapolis 13, Minn.
- ⊙Electric Motor Corp. Div., Howard Industries, Inc., Racine, Wis.
- ⊙Electyme Motor Products Corp., 565 W. Washington Blvd., Chicago 6, Ill.
- ⊙Ford Instrument Co., Inc., 31-10 Thomson Ave., Long Island City, N. Y.
- ⊙Gale Dorothea Mechanisms, 37-61 85th St., Jackson Heights, N. Y.
- ⊙GENERAL ELECTRIC CO., Schenectady 5, N. Y. ADV. PG. 1 to 22.
- ⊙Gorrell & Gorrell, Haworth, N. J.
- ⊙Hagen Mfg. Co., Inc., Baraboo, Wis.
- ⊙Hansen Mfg. Co., Inc., Princeton 10, Indiana.
- ⊙Hertner Electric Co., 12690 Elmwood Ave., Cleveland 11, Ohio.
- ⊙Holtzer-Cabot Div. of National Pneumatic Co., Inc., 125 Amory St., Boston 19, Mass.
- ⊙Ingraham Co., E., Bristol, Conn.
- ⊙Kato Engineering Co., 1415 First Ave., Mankato, Minn.
- ⊙KOLLSMAN INSTRUMENT CORP., 80-08 45th Ave., Elmhurst, N. Y. ADV. PG. 304.
- ⊙Lear, Inc., 110 Ionia Ave., N.W., Grand Rapids 2, Mich.
- Mission Electric Mfg. Co., 132 W. Colorado Blvd., Pasadena, Calif.
- ⊙OSTER MFG. CO., JOHN, 1 Main St., Racine, Wis. ADV. PG. 90.
- ⊙Robbins & Myers, Inc., 1345 Lagonda Ave., Springfield 99, Ohio.
- ⊙Russell Electric Co., 4501 South Western Blvd., Chicago 9, Ill.
- ⊙Small Motors, Inc., 2076 Elston Ave., Chicago 14, Ill.
- ⊙TELECHRON INC., Homer Ave., Ashland, Mass. ADV. PG. 24.
- ⊙WESTINGHOUSE ELECTRIC CORP., 511 Wood St., P. O. Box 868, Pittsburgh 30, Pa. ADV. PG. 107-113.
- ⊙AIR-MARINE MOTORS, INC., 2183 Jackson Ave., Seaford, N. Y. ADV. PG. 376.
- ⊙Amglo Corp., 4234 Lincoln Ave., Chicago 18, Ill.
- ⊙Barber-Colman Co., Rockford, Ill.
- ⊙Bodine Electric Co., Ohio St. & Oakley Blvd., Chicago 12, Ill.
- ⊙Bristol Motor Co., Old Saybrook, Conn.
- ⊙CRAMER CO., INC., R. W., Box 13, Centerbrook Conn. ADV. PG. 202.
- ⊙Electyme Motor Products Corp., 565 W. Washington Blvd., Chicago 6, Ill.
- ⊙Gale Dorothea Mechanisms, 37-61 85th St., Jackson Heights, N. Y.
- ⊙General Industries Co., Taylor & Olive Sts., Elyria, Ohio.
- ⊙Gorrell & Gorrell, Haworth, N. J.
- ⊙Hagen Mfg. Co., Inc., Baraboo, Wis.

MOTORS—Timing

- ⊙Hansen Mfg. Co., Inc., Princeton 10, Ind.
- ⊙HAYDON CO., A. W., THE, 232 N. Elm St., Waterbury, Conn. ADV. PG. 402.
- ⊙HAYDON MFG. CO., INC., 584 E. Elm St., Torrington, Conn. ADV. PG. 216, 217.
- ⊙Holtzer-Cabot Div. of National Pneumatic Co., Inc., 125 Amory St., Boston 19, Mass.
- ⊙OSTER MFG. CO., JOHN, 1 Main St., Racine, Wis. ADV. PG. 90.
- ⊙Russell Electric Co., 4501 South Western Blvd., Chicago 9, Ill.
- ⊙TELECHRON, INC., Homer Ave., Ashland, Mass. ADV. PG. 24.

MOUNTINGS—Meter Back

- ⊙LITTELFUSE, INC., 4757 Ravenswood Ave., Chicago 40, Ill. ADV. PG. 285.
- ⊙MARION ELECTRICAL INSTRUMENT CO., Manchester, N. H. ADV. PG. 200.
- ⊙RICHARDSON CO., THE, 2767 Lake St., Melrose Park, Ill. ADV. PG. 310.
- ⊙Spaulding Fibre Co., Inc., 310 Wheeler St., Tona-wanda, N. Y.

MOUNTINGS—Vibration and Shock

- ⊙BARRY CORP., THE, 700 Pleasant St., Watertown, Mass. ADV. PG. 240, 241.
- Finn & Company, Inc., T. R., 333 Jackson Avenue, New York 54, N. Y.
- ⊙General Tire & Rubber Co., Silentbloc Div., Wabash, Ind.
- ⊙Hamilton Kent Mfg. Co., Kent, Ohio.
- ⊙HEPPNER MFG. CO., P. O. Box 612, Round Lake, Ill. ADV. PG. 413.
- ⊙Industrial Precision Products Co., 315-325 N. Hoyne Ave., Chicago 12, Ill.
- ⊙JFD MFG. CO., 6101-23 Sixteenth Ave., Brooklyn, N. Y. ADV. PG. 407.
- ⊙KARP METAL PRODUCTS CO., INC., 215 63rd St., Brooklyn 20, N. Y. ADV. PG. 105.
- ⊙LORD MFG. CO., 1635 W. 12th St., Erie, Pa. ADV. PG. 51.
- ⊙Mayfair Molded Products Corp., 4440 N. Elston Ave., Chicago 30, Ill.
- ⊙Racon Electric Co., 52 E. 19th St., New York 3, N. Y.
- ⊙ROBINSON AVIATION INC., Teterboro, N. J. ADV. PG. 267.
- ⊙Ucinite Co., Division, United-Carr Fastener Corp., 459 Watertown St., Newtonville, Mass.
- ⊙United-Carr Fastener Corp., Cambridge 42, Mass.
- ⊙United States Rubber Co., 1230 Avenue of the Americas, New York 20, N. Y.

MOUNTS—Antenna

- ⊙Bassett, Inc., Rex, 307-311 N. W. First Ave., Fort Lauderdale, Fla.
- ⊙Communications Co., Inc., 300 Greco Ave., Coral Gables 34, Fla.
- ⊙Industrial Precision Products Co., 315-325 N. Hoyne Ave., Chicago 12, Ill.
- ⊙J F D MFG. CO., 6101-23 Sixteenth Ave., Brooklyn, N. Y. ADV. PG. 407.
- ⊙LAPOINTE-PLASCOMOLD CORP., Windsor Locks, Conn. ADV. PG. 297.
- ⊙Lear, Inc., 110 Ionia Ave., N.W., Grand Rapids 2, Mich.
- ⊙Network Mfg. Corp., Bayonne, N. J.
- ⊙Philco Corp., Tioga & C Sts., Philadelphia 34, Pa.
- ⊙Premax Products Div., Chisholm-Ryder Co., Inc., Niagara Falls 2, N. Y.
- ⊙Radio Merchandise Sales, Inc., 1165 Southern Blvd., New York 59, N. Y.
- Rollins Corp., Moore Bldg., Rehoboth, Del.
- ⊙Telrex, Inc., Rutherford & Neptune Highway, Asbury Park, N. J.
- ⊙Wind Turbine Co., Tower & Antenna Div., E. Market St. & Penna. R. R., West Chester, Pa.
- ⊙WORKSHOP ASSOCIATES, INC., THE, 66 Needham St., Newton Highlands 61, Mass. ADV. PG. 233.

MOUNTS—Thermistor

- ⊙HEWLETT-PACKARD CO., 395 Page Mill Rd., Palo Alto, Calif. ADV. PG. 33-36.
- ⊙KINGS MICROWAVE CO., INC., 50 Marbledale Rd., Tuckahoe 7, N. Y. ADV. PG. 178, 179.
- ⊙MARCONI INSTRUMENTS, LTD., 23 Beaver St., New York 4, N. Y. ADV. PG. 270.

MULTIPLIERS—Crystal

- ⊙Bassett, Inc., Rex, 307-311 N.W. First Ave., Fort Lauderdale, Fla.
- ⊙KAY ELECTRIC CO., 14 Maple Ave., Pine Brook, N. J. ADV. PG. 340.
- ⊙McMurdo Silver Co., Inc., 417 Lafayette St., New York, N. Y.
- ⊙MARCONI INSTRUMENTS, LTD., 23 Beaver St., New York 4, N. Y. ADV. PG. 270.

Ⓢ indicates . . . IN PRODUCTION • AVAILABILITY • UNRESTRICTED FOR GENERAL USE

ⓈSPERRY GYROSCOPE CO., Div. of The Sperry Corp., Great Neck, N. Y. ADV. PG. 103, 104.
VECTRON, INC., 235 High St., Waltham, Mass. ADV. PG. 214.

MULTIPLIERS—Frequency

ⓈBARKER & WILLIAMSON, 235 Fairfield Ave., Upper Darby, Pa. ADV. PG. 292.
ⓈBassett, Inc., Rex, 307-311 N.W. First Ave., Fort Lauderdale, Fla.
ⓈELECTRONIC MEASUREMENTS COMPANY, Red Bank, N. J. ADV. PG. 312.
ⓈKAY ELECTRIC CO., 14 Maple Ave., Pine Brook, N. J. ADV. PG. 340.
ⓈMcMurdo Silver Co., Inc., 417 Lafayette St., New York, N. Y.
ⓈMARCONI INSTRUMENTS, LTD., 23 Beaver St., New York 4, N. Y. ADV. PG. 270.
ⓈNORMAN LABORATORIES, ERNST, Williams Bay, Wis. ADV. PG. 346.
ⓈPOLYTECHNIC RESEARCH & DEVELOPMENT CO., INC., 202 Tillary St., Brooklyn 1, N. Y. ADV. PG. 390.
ⓈSPERRY GYROSCOPE CO., Div. of The Sperry Corp., Great Neck, N. Y. ADV. PG. 103, 104.

MULTIPLIERS—Meter

ⓈBALLANTINE LABORATORIES, INC., Boonton, N. J. ADV. PG. 125.
ⓈBurlington Instrument Co., Burlington, Iowa.
ⓈDAVEN CO., 191 Central Ave., Newark 4, N. J. ADV. PG. 157.
ⓈELECTRONIC INSTRUMENT CO., INC., 276 Newport St., Brooklyn 12, N. Y. ADV. PG. 120.
ⓈEsterline-Angus Co., Inc., P. O. Box 596, Indianapolis, Ind.
ⓈFarrand Optical Co., Inc., Bronx Blvd. at 238th St., New York 70, N. Y.
ⓈFeiler Engineering Co., 8026 Monticello Ave., Skokie, Ill.
ⓈFluke Engineering Co., John, Box 755, Springdale, Conn.
ⓈHycor Co., Inc., 11423 Vanowen St., North Hollywood, Calif.
ⓈINSTRUMENT RESISTORS CO., 1036 Commerce Ave., Union, N. J. ADV. PG. 392, 393.
ⓈINTERNATIONAL RESISTANCE CO., 401 N. Broad St., Philadelphia 8, Pa. ADV. PG. 134, 135.
ⓈMARION ELECTRICAL INSTRUMENT CO., Manchester, N. H. ADV. PG. 200.
ⓈMEPCO, INC., 35-37 Abbott Ave., Morristown, N. J. ADV. PG. 138.
ⓈPrecision Resistor Co., 334 Badger Ave., Newark 8, N. J.
ⓈReliance Instrument Co., 3027 W. Van Buren St., Chicago 12, Ill.
ⓈSensitive Research Instrument Corp., 9 Elm Ave., Mt. Vernon, N. Y.
ⓈSHALLCROSS MFG. CO., 10 Jackson Ave., Collingdale, Pa. ADV. PG. 261.
ⓈSupreme, Inc., Greenwood, Miss.
ⓈWESTINGHOUSE ELECTRIC CORP., 511 Wood St., P. O. Box 868, Pittsburgh 30, Pa. ADV. PG. 107-113.
ⓈWESTON ELECTRICAL INSTRUMENT CORP., 595 Freylinghuysen Ave., Newark 5, N. J. ADV. PG. 243.

MULTITESTERS

ⓈChicago Industrial Instrument Co., 536 W. Elm St., Chicago 10, Ill.
ⓈDouglas Radio Labs., 176 Norfolk Ave., Boston 19, Mass.
ⓈELECTRONIC INSTRUMENT CO., INC., 276 Newport St., Brooklyn 12, N. Y. ADV. PG. 129.
ⓈFeiler Engineering Co., 8026 Monticello Ave., Skokie, Ill.
ⓈINTERNATIONAL INSTRUMENTS, INC., 331 East St., New Haven 11, Conn. ADV. PG. 322.
ⓈJackson Electrical Instrument Co., 16 S. Patterson Blvd., Dayton 1, Ohio.
ⓈMcMurdo Silver Co., Inc., 417 Lafayette St., New York, N. Y.
ⓈMeters, Inc., 915 Westfield Blvd., Indianapolis 20, Ind.
ⓈOak Ridge Products Mfg. Div. of Video Television, Inc., 37-01 Vernon Blvd., Long Island City 1, N. Y.
ⓈPRECISE MEASUREMENTS CO., 942 Kings Highway, Brooklyn 23, N. Y. ADV. PG. 401.
Precision Apparatus Co., Inc., 92-27 Horace Harding Blvd., Elmhurst, N. Y.
ⓈRadio City Products Co., Inc., 152 W. 25th St., New York 1, N. Y.
ⓈRadio Design Co., 1353 Sterling Pl., Brooklyn, N. Y.
ⓈReiner Electronics Co., 152 W. 25th St., New York, N. Y.
ⓈSHALLCROSS MFG. CO., 10 Jackson Ave., Collingdale, Pa. ADV. PG. 261.
Star Measurements Co., 442 East 166th St., New York 56, N. Y.
ⓈSupreme, Inc., Greenwood, Miss.
ⓈSYLVANIA ELECTRIC PRODUCTS, INC., 1740 Broadway, New York 19, N. Y. ADV. PG. 432-436.
ⓈTriplett Electrical Instrument Co., Harmon Rd., Bluffton, Ohio.

ⓈWESTON ELECTRICAL INSTRUMENT CORP., 595 Freylinghuysen Ave., Newark 5, N. J. ADV. PG. 243.

MULTIVIBRATORS

ⓈBendix Aviation Corp., Pacific Div., 11600 Sherman Way, North Hollywood, Calif.
ⓈCLARK CRYSTAL CO., 2 Farm Rd., Marlboro, Mass. ADV. PG. 366.
ⓈELECTRONIC MEASUREMENTS COMPANY, Red Bank, N. J. ADV. PG. 312.
ⓈHart Associates, 8430 Grand River, Detroit 4, Mich.
ⓈIonic Electronic Equipment Co., 1705 N. Kenmore, Los Angeles 27, Calif.
ⓈMelpar, Inc., 552 Swann Ave., Alexandria, Va.
ⓈNortheastern Engineering, Inc., Manchester, N. H.
ⓈPOTTER INSTRUMENT CO., INC., 115 Cutter Mill Rd., Great Neck, N. Y. ADV. PG. 318.
ⓈSPERRY GYROSCOPE CO., Div. of The Sperry Corp., Great Neck, N. Y. ADV. PG. 103, 104.
ⓈStandard Electronics Research Corp., 2 East End Ave., New York 21, N. Y.
ⓈTEL-RAD MFG. CO., INC., 7th & Madison St., Fennimore, Wis. ADV. PG. 412.

MUSIC SYSTEMS—Industrial and Commercial

ⓈAltec Lansing Corp., 9356 Santa Monica Blvd., Beverly Hills, Calif.
ⓈBrelco Electronics Corp., 55 Vandam St., New York 13, N. Y.
ⓈElectronic Development Lab., 43-07 23rd Ave., Long Island City 5, N. Y.
ⓈExecutone, Inc., 415 Lexington Ave., New York 17, N. Y.
ⓈLear, Inc., 110 Ionia Ave., N.W., Grand Rapids 2, Mich.
ⓈMagna Electronics Co., 3707-11 W. Jefferson, Los Angeles 16, Calif.
ⓈMonarch Radio & Television Corp., 2430 Atlantic Ave., Brooklyn 33, N. Y.
ⓈNewcomb Audio Products Co., 6824 Lexington Ave., Hollywood 38, Calif.
ⓈOperadio Mfg. Co., 135th & Indiana Sts., St. Charles, Ill.
ⓈRADIO CORP. OF AMERICA, RCA Victor Div., General Offices, Camden, N. J. ADV. PG. 177, Inside Back and Back Covers.
ⓈRauland-Borg Corp., 3523 W. Addison St., Chicago 18, Ill.
Schulmerich Electronics, Inc., Sellersville, Pa.
ⓈTANNOY, 350 Fifth Ave., New York 1, N. Y. ADV. PG. 412.
ⓈWaveforms, Inc., 333 Sixth Ave., New York 14, N. Y.
ⓈWestern Sound & Electric Labs., Inc., 805 S. Fifth St., Milwaukee 4, Wis.
ⓈWurlitzer Co., Rudolph, The, N. Tonawanda, N. Y.

NAILS—Special

ⓈAllmetal Screw Products Co., Inc., 33 Greene St., New York 13, N. Y.
ⓈAluminum Co. of America, Gulf Bldg., Pittsburgh 30, Pa.
ⓈAtlas Tack Corp., Pleasant St., Fairhaven, Mass.
ⓈChase Brass & Copper Co., Inc., 236 Grand St., Waterbury 20, Conn.
ⓈCopperweld Steel Co., Glassport, Pa.
ⓈEagle Electric Mfg. Co., Inc., 23-10 Bridge Plaza, S., Long Island City, N. Y.
ⓈGeneral Cement Mfg. Co., 919 Taylor Ave., Rockford, Ill.
ⓈGreene Mfg. Corp., G. G., Warren, Pa.
ⓈHarper Co., H. M., 8200 Lehigh Ave., Morton Grove, Ill.
ⓈHassall, Inc., John, Clay & Oakland Sts., Brooklyn 22, N. Y.
ⓈJFD MFG. CO., 6101-23 Sixteenth Ave., Brooklyn, N. Y. ADV. PG. 407.
ⓈStar Expansion Bolt Co., 147-149 Cedar St., New York 6, N. Y.

NAME PLATES

See Plates, Name

NEEDLES—Cutting

ⓈActon Co., Inc., H. W., 370 7th Ave., New York 1, N. Y.
ⓈAmerican Laubscher Corp., 333 W. 52nd St., New York 19, N. Y.
ⓈCapps Co., Inc., Frank L., 244 W. 49th St., New York 19, N. Y.
ⓈCaltron Co., 1406 S. Hobart Blvd., Los Angeles 6, Calif.
ⓈDUOTONE CO., INC., Keyport, N. J. ADV. PG. 307.
Electrovox Co., Inc., 60 Franklin St., East Orange, N. J.
ⓈGeneral Cement Mfg. Co., 919 Taylor Ave., Rockford, Ill.
ⓈJ F D MFG. CO., 6101-23 Sixteenth Ave., Brooklyn, N. Y. ADV. PG. 407.

ⓈJensen Industries, Inc., 329 S. Wood St., Chicago, Ill.
Miller Mfg. Co., M. A., 1169 E. 43rd St., Chicago 15, Ill.
ⓈMirror Record Corp., 4025 206 St., Bayside, N. Y.
ⓈPermo, Inc., 6415 Ravenswood Ave., Chicago 26, Ill.
ⓈRecordisc Corp., 395 Broadway, New York, N. Y.
Recoton Corp., 251 Fourth Ave., New York 10, N. Y.
ⓈREEVES SOUNDCRAFT CORP., 10 E. 52nd St., New York 22, N. Y. ADV. PG. 372.
ⓈVallorbs Jewel Co., Lancaster, Pa.

NEEDLES—Playback

ⓈActon Co., Inc., H. W., 370 7th Ave., New York 1, N. Y.
Aero Needle Co., 619 N. Michigan Ave., Chicago 11, Ill.
ⓈAmerican Laubscher Corp., 333 W. 52nd St., New York 19, N. Y.
ⓈCaltron Co., 1406 S. Hobart Blvd., Los Angeles 6, Calif.
ⓈCapps & Co., Inc., Frank L., 244 W. 49th St., New York 19, N. Y.
ⓈClarkstan Corp., 11921 SW. Pico Blvd., Los Angeles 64, Calif.
ⓈDUOTONE CO., INC., Keyport, N. J. ADV. PG. 307.
Electrovox Co., Inc., 60 Franklin St., East Orange, N. J.
ⓈGeneral Cement Mfg. Co., 919 Taylor Ave., Rockford, Ill.
Gerett Corp., M. A., 724 W. Winnebago St., Milwaukee 5, Wis.
ⓈJ F D MFG. CO., 6101-23 Sixteenth Ave., Brooklyn, N. Y. ADV. PG. 407.
ⓈJensen Industries Inc., 329 S. Wood St., Chicago, Ill.
Miller Mfg. Co., M. A., 1169 E. 43rd St., Chicago 15, Ill.
ⓈMirror Record Corp., 4025 206 St., Bayside, N. Y.
ⓈPermo, Inc., 6415 Ravenswood Ave., Chicago 26, Ill.
ⓈPfanstielh Chemical Co., Metallurgical Div., 104 Lake View Ave., Waukegan, Ill.
ⓈPICKERING & CO., 309 Woods Ave., Oceanside, N. Y. ADV. PG. 284.
ⓈRADIO CORP. OF AMERICA, RCA Victor Div., Home Instrument Dept., Camden, N. J. ADV. PG. 177, Inside Back & Back Covers.
ⓈRecordisc Corp., 395 Broadway, New York, N. Y.
Recoton Corp., 251 Fourth Ave., New York 10, N. Y.
ⓈREEVES SOUNDCRAFT CORP., 10 E. 52nd St., New York 22, N. Y. ADV. PG. 372.
ⓈTetrad Corp., 62 St. Mary St., Yonkers, N. Y.
ⓈWebster-Chicago Corp., 5622 Bloomingdale Ave., Chicago 39, Ill.

NETWORKS—Directional Antenna Phasing

ⓈBARKER & WILLIAMSON, 235 Fairfield Ave., Upper Darby, Pa. ADV. PG. 292.
ⓈELECTRONIC MEASUREMENTS COMPANY, Red Bank, N. J. ADV. PG. 312.
ⓈGates Radio Co., Quincy, Ill.
ⓈGENERAL ELECTRIC CO., Schenectady 5, N. Y. ADV. PG. 1 to 22.
ⓈJOHNSON CO., E. F., Waseca, Minn. ADV. PG. 118, 121.
ⓈKINGS MICROWAVE CO., INC., 50 Marbledale Rd., Tuckahoe 7, N. Y. ADV. PG. 178, 179.
ⓈNetwork Mfg. Corp., Bayonne, N. J.
ⓈRADIO CORP. OF AMERICA, RCA Victor Div., General Offices, Camden, N. J. ADV. PG. 177, Inside Back and Back Covers.

NETWORKS—Matching

ⓈAero Coil Inc., 507 26th St., Union City, N. J.
ⓈAltec Lansing Corp., 9356 Santa Monica Blvd., Beverly Hills, Calif.
ⓈBARKER & WILLIAMSON, 235 Fairfield Ave., Upper Darby, Pa. ADV. PG. 292.
ⓈCINEMA ENGINEERING CO., 1510 W. Verdugo Ave., Burbank, Calif. ADV. PG. 204.
ⓈDAVEN CO., 191 Central Ave., Newark 4, N. J. ADV. PG. 157.
ⓈELECTRONIC MEASUREMENTS COMPANY, Red Bank, N. J. ADV. PG. 312.
ⓈGates Radio Co., Quincy, Ill.
ⓈKINGS MICROWAVE CO., INC., 50 Marbledale Rd., Tuckahoe 7, N. Y. ADV. PG. 178, 179.
ⓈMillen Mfg. Co., James, 150 Exchange St., Malden, Mass.
ⓈMiller Co., J. W., 5917 S. Main St., Los Angeles 3, Calif.
ⓈNetwork Mfg. Corp., Bayonne, N. J.
ⓈORTHON CORP., THE, 196 Albion Ave., Paterson 2, N. J. ADV. PG. 156.
ⓈPAINTON & CO., LTD., 366 Madison Ave., New York 17, N. Y. ADV. PG. 336.
ⓈPeerless Electrical Products Co., Div. of Altec-Lansing Corp., 6920 McKinley Ave., Los Angeles 1, Calif.
ⓈRacor Electric Co., 52 E. 19th St., New York 3, N. Y.
ⓈStandard Telephones & Cables Ltd., Connaught House, Aldwych, London, W. C. 2, England.

V indicates . . . IN PRODUCTION • AVAILABILITY • UNRESTRICTED FOR GENERAL USE

- ⓧThordarson-Meissner Mfg. Divisions, 500 W. Huron St., Chicago 10, Ill.
- ⓧUNITED TRANSFORMER CO., 150 Varick St., New York 13, N. Y. ADV. PG. Inside Front Cover.

NETWORKS—Pulse Forming

- ⓧAIRCRAFT-MARINE PRODUCTS, INC., 2100 Paxton St., Harrisburg 10, Pa. ADV. PG. 367.
- ⓧBARKER & WILLIAMSON, 235 Fairfield Ave., Upper Darby, Pa. ADV. PG. 292.
- ⓧCorson Electric Mfg. Corp., 540 39th St., Union City, N. J.
- ⓧDAVEN CO., 191 Central Ave., Newark 4, N. J. ADV. PG. 157.
- ⓧDeutschmann Corp., Tobe, 921 Providence Highway, Norwood, Mass.
- ⓧMillen Mfg. Co., James, 150 Exchange St., Malden, Mass.
- ⓧMiller Co., J. W., 5917 S. Main St., Los Angeles 3, Calif.
- ⓧNetwork Mfg. Corp., Bayonne, N. J.
- ⓧThordarson-Meissner Mfg. Divisions, 500 W. Huron St., Chicago 10, Ill.
- ⓧWESTINGHOUSE ELECTRIC CORP., 511 Wood St., P. O. Box 868, Pittsburgh 30, Pa. ADV. PG. 107-113.

NUTS

- ⓧALDEN PRODUCTS CO., 117 N. Main St., Brockton 64, Mass. ADV. PG. 327.
- ⓧAllmetal Screw Products Co., Inc., 33 Greene St., New York 13, N. Y.
- ⓧAluminum Co. of America, Gulf Bldg., Pittsburgh 30, Pa.
- ⓧAmerican Laubscher Corp., 333 W. 52nd St., New York 19, N. Y.
- ⓧAmerican Screw Co., Willimantic, Conn.
- ⓧAutoscrew Co., 216-222 W. 18th St., New York, N. Y.
- ⓧCentral Screw Co., 3501 Shields Ave., Chicago 9, Ill.
- ⓧChase Brass & Copper Co., Inc., 236 Grand St., Waterbury 20, Conn.
- ⓧContinental Screw Co., New Bedford, Mass.
- ⓧFEDERAL SCREW PRODUCTS INC., 224 W. Huron St., Chicago 10, Ill. ADV. PG. 76.
- ⓧGeneral Cement Mfg. Co., 919 Taylor Ave., Rockford, Ill.
- ⓧGries Reproducer Corp., 100 Willow Ave., New York 54, N. Y.
- ⓧHarper Co., H. M., 8200 Lehigh Ave., Morton Grove, Ill.
- ⓧLamson & Sessions Co., 1971 W. 85th St., Cleveland, Ohio.
- ⓧLocke Incorporated, P. O. Box 57, Baltimore 3, Md.
- ⓧPheoil Mfg. Co., 5700 Roosevelt Rd., Chicago 50, Ill.
- ⓧProgressive Mfg. Co., 50 Norwood St., Torrington, Conn.
- ⓧRepublic Steel Corp., Republic Bldg., Cleveland 1, Ohio.
- ⓧSchott Co., Walter L., 3225 Exposition Pl., Los Angeles 18, Calif.
- ⓧShakeproof, Inc. Div. of Illinois Tool Works, 2501 N. Keeler Ave., Chicago 39, Ill.
- ⓧSmith, Inc., Herman H., 436 18th St., Brooklyn 15, N. Y.
- ⓧStandard Locknut & Lockwasher, Inc., 501 N. Capitol Ave., Indianapolis 4, Ind.
- ⓧStar Expansion Products Co., 147-149 Cedar St., New York 6, N. Y.
- ⓧStover Lock Nut & Machinery Corp., Hilton & Holly Sts., Easton, Pa.
- ⓧStronghold Screw Products, Inc., 216-222 West Hubbard St., Chicago 10, Ill.
- ⓧTinnerman Products Inc., P. O. Box 6688, Dept. No. 16, Cleveland 1, Ohio.
- ⓧUnited Screw & Bolt Corp., 2513 W. Cullerton St., Chicago 8, Ill.

NUTS—Self-Locking

- ⓧALDEN PRODUCTS CO., 117 N. Main St., Brockton 64, Mass. ADV. PG. 327.
- ⓧBoots Aircraft Nut Corp., 50 John St., Stamford, Conn.
- ⓧElastic Stop Nut Corp., 2330 Vauxhall Road, Union, N. J.
- ⓧFafnir Bearing Co., The., New Britain, Conn.
- ⓧFEDERAL SCREW PRODUCTS INC., 224 W. Huron St., Chicago 10, Ill. ADV. PG. 76.
- ⓧLaminated Shim Co., Inc., 56 Union St., Glenbrook, Conn.
- ⓧLamson & Sessions Co., 1971 W. 85th St., Cleveland, Ohio.
- ⓧPalnut Co., Inc., 77 Cordier St., Irvington 11, N. J.
- ⓧRadio Frequency Labs., Inc., Boonton 2, N. J.
- ⓧShakeproof, Inc., Div. of Illinois Tool Wks., 2501 N. Keeler Ave., Chicago 39, Ill.
- ⓧStandard Pressed Steel Co., Jenkintown 10, Pa.
- ⓧStover Lock Nut & Machinery Corp., Hilton & Holly Sts., Easton, Pa.
- ⓧStronghold Screw Products, Inc., 216-222 West Hubbard St., Chicago 10, Ill.
- ⓧUnited-Carr Fastener Corp., Cambridge 42, Mass.

NUTS—Self-Sealing

- ⓧElastic Stop Nut Corp., 2330 Vauxhall Rd., Union, N. J.
- ⓧPhilco Corp., Tioga & C Sts., Philadelphia 34, Pa.
- ⓧStar Expansion Products Co., 147-149 Cedar St., New York 6, N. Y.

OHMMETERS

- ⓧAssociated Research Inc., 3758 W. Belmont, Chicago 18, Ill.
- ⓧBidle Co., James G., 1316 Arch St., Philadelphia 7, Pa.
- ⓧDouglas Radio Labs., 176 Norfolk Ave., Boston 19, Mass.
- ⓧELECTRONIC INSTRUMENT CO., INC., 276 Newport St., Brooklyn 12, N. Y. ADV. PG. 129.
- ⓧElectronic Measurements Corp., 280 Lafayette St., New York 12, N. Y.
- ⓧEsterline-Angus Co., Inc., P. O. Box 586, Indianapolis, Ind.
- ⓧFeiler Engineering Co., 8026 Monticello Ave., Skokie, Ill.
- ⓧGENERAL ELECTRIC CO., Schenectady 5, N. Y. ADV. PG. 1 to 22.
- ⓧHICKOK ELECTRICAL INSTRUMENT CO., 10514 Dupont Ave., Cleveland 8, Ohio. ADV. PG. 333.
- ⓧINTERNATIONAL INSTRUMENTS, INC., 331 East St., New Haven 11, Conn. ADV. PG. 322.
- ⓧJackson Electrical Instrument Co., 16 S. Patterson Blvd., Dayton 1, Ohio.
- ⓧLeeds & Northrup Co., 4970 Stenton Ave., Philadelphia 44, Pa.
- ⓧMcMurdo Silver Co., Inc., 417 Lafayette St., New York, N. Y.
- ⓧMARION ELECTRICAL INSTRUMENT CO., Manchester, N. H. ADV. PG. 200.
- ⓧOak Ridge Products Mfg. Div. of Video Television, Inc., 37-01 Vernon Blvd., Long Island City 1, N. Y.
- ⓧPRECISE MEASUREMENTS CO., 942 Kings Highway, Brooklyn 23, N. Y. ADV. PG. 401.
- ⓧRoller-Smith, Bethlehem, Pa.
- ⓧSensitive Research Instrument Corp., 9 Elm Ave., Mt. Vernon, N. Y.
- ⓧSHALLGROSS MFG. CO., 10 Jackson Ave., Collingdale, Pa. ADV. PG. 261.
- ⓧSHURITE METERS, 35-B Hamilton St., New Haven 8, Conn. ADV. PG. 390.
- ⓧSimpson Electric Co. Div., American Gage & Machine Co., 5218 W. Kinzie St., Chicago 44, Ill.
- ⓧSouthwestern Industrial Electronics Co., 2831 Post Oak Rd., P. O. Box 13058, Houston 19, Texas.
- ⓧStar Measurements Co., 442 East 166th St., New York 56, N. Y.
- ⓧSticht Co., Inc., Herman H., 27 Park Place, New York 7, N. Y.
- ⓧSupreme, Inc., Greenwood, Miss.
- ⓧSYLVANIA ELECTRIC PRODUCTS, INC., 1740 Broadway New York 19, N. Y. ADV. PG. 432-436.
- ⓧTRAD TELEVISION CORP., 1001 First Ave., Asbury Park, N. J. ADV. PG. 355.
- ⓧWelch Scientific Co., W. M., 1515 Sedgwick St., Chicago 10, Ill.
- ⓧWESTINGHOUSE ELECTRIC CORP., 511 Wood St., P. O. Box 868, Pittsburgh 30, Pa. ADV. PG. 107-113.
- ⓧWESTON ELECTRICAL INSTRUMENT CORP., 595 Frelinghuysen Ave., Newark 5, N. J. ADV. PG. 243.
- ⓧWinslow Co., Inc., 9 Liberty St., Newark 5, N. J.

OPTICAL EQUIPMENT AND SPECIALTIES

- ⓧAmerican Optical Co., Box A, Buffalo 15, N. Y.
- ⓧART WIRE & STAMPING CO., 227 High St., Newark 2, N. J. ADV. PG. 38.
- ⓧBache & Co., Semon, 636 Greenwich St., New York 14, N. Y.
- ⓧBaird Associates, 33 University Rd., Cambridge 35, Mass.
- ⓧBausch & Lomb Optical Co., 635 St. Paul St., Rochester 2, N. Y.
- ⓧBerndt-Bach, Inc., 7373 Beverly Blvd., Los Angeles 36, Calif.
- ⓧBuhl Optical Co., 1009 Beech Ave., Pittsburgh 12, Pa.
- ⓧCLARK CRYSTAL CO., 2 Farm Rd., Marlboro, Mass. ADV. PG. 366.
- ⓧClarkstan Corp., 11921 S.W. Pico Blvd., Los Angeles 64, Calif.
- ⓧEastman Kodak Co., Industrial Photographic Div., 343 State St., Rochester 4, N. Y.
- ⓧFarrand Optical Co., Inc., Bronx Blvd., at 238th St., New York 70, N. Y.
- ⓧGaertner Scientific Corp., 1201 Wrightwood Ave., Chicago 14, Ill.
- ⓧJarrell-Ash Co., 165 Newbury St., Boston 16, Mass.
- ⓧJones Optical Works, A. D., Cambridge, Mass.
- ⓧL & R Mfg. Co., 577 Elm St., Arlington, N. J.
- ⓧMenlo Research Laboratory, Menlo Park, Calif.
- ⓧNorth American Philips Co., Inc., 100 E. 42nd St., New York 17, N. Y.
- ⓧPRECISE MEASUREMENTS CO., 942 Kings Highway, Brooklyn 23, N. Y. ADV. PG. 401.
- ⓧOptical Film Engineering Co., 2125 Cherry St., Philadelphia 3, Pa.
- ⓧProcess & Instruments, 60 Greenpoint Ave., Brooklyn 22, N. Y.

- ⓧStancil-Hoffman Corp., 1016 N. Highland Ave., Hollywood 38, Calif.
- ⓧZenith Optical Co. Div. Polan Industries, Huntington 19, W. Va.
- ⓧZenith Optical Lab., 1940 Great Neck Rd., Copiague, L. I., N. Y.

OSCILLATORS—Audio Fork Controlled

- ⓧAMERICAN TIME PRODUCTS, INC., 580 Fifth Ave., New York 19, N. Y. ADV. PG. 226.
- ⓧGENERAL RADIO CO., 275 Massachusetts Ave., Cambridge 39, Mass. ADV. PG. 48, 49.
- ⓧHathaway Instrument Co., 1315 S. Clarkson St., Denver 10, Colo.
- ⓧPHILAMON LABORATORIES, 5717 Third Ave., Brooklyn 20, N. Y. ADV. PG. 302.
- ⓧRiverbank Laboratories, Dept. of Engineering, Geneva, Ill.
- ⓧTIMES FACSIMILE CORP., 540 W. 58th St., New York 19, N. Y. ADV. PG. 288.

OSCILLATORS—Audio Frequency

- ⓧAIRMEC LABORATORIES, LTD., 366 Madison Ave., New York 17, N. Y. ADV. PG. 336.
- ⓧAltec Lansing Corp., 9356 Santa Monica Blvd., Beverly Hills, Calif.
- ⓧAMERICAN ELECTROENGINEERING CO., 5025-29 W. Jefferson Blvd., Los Angeles 16, Calif. ADV. PG. 136.
- ⓧAmplifier Corp. of America, 398 Broadway, New York 13, N. Y.
- ⓧBARKER & WILLIAMSON, 235 Fairfield Ave., Upper Darby, Pa. ADV. PG. 292.
- ⓧBassett, Inc., Rex, 307-311 N.W. First Ave., Fort Lauderdale, Fla.
- ⓧBendix Aviation Corp., Pacific Div., 1160 Sherman Way, North Hollywood, Calif.
- ⓧBOONTON RADIO CORP., Boonton, N. J. ADV. PG. 96.
- ⓧBrelco Electronics Corp., 55 Vandam St., New York 13, N. Y.
- ⓧBrown Electro-Measurement Corp., 4637 Southeast Hawthorne Blvd., Portland 15, Oreg.
- ⓧBRUSH DEVELOPMENT CO., 3405 Perkins Ave., Cleveland 14, Ohio. ADV. PG. 228, 229.
- ⓧClough Brengle Co., 6014 N. Broadway, Chicago, Ill.
- ⓧCOMMUNICATION ACCESSORIES CO., Box 345, 110th St. & Hillcrest Rd., Hickman Hills, Mo. ADV. PG. 168.
- ⓧDAVEN CO., 191 Central Ave., Newark 4, N. J. ADV. PG. 157.
- ⓧELECTRONIC MEASUREMENTS COMPANY, Red Bank, N. J. ADV. PG. 312.
- ⓧEL-TRONICS, INC., 2649 N. Howard St., Philadelphia 33, Pa. ADV. PG. 299.
- ⓧErco Radio Labs., Inc., E. Stewart Ave., Garden City, N. Y.
- ⓧFerrari Radio & Television Corp., 55 W. 26th St., New York 10, N. Y.
- ⓧFREED TRANSFORMER CO., INC., 1736 Weirfield St., Brooklyn 27, N. Y. ADV. PG. 149.
- ⓧGalbraith & Son Electric Corp., C. C., 450 Sixth Ave., New York 11, N. Y.
- ⓧGENERAL RADIO CO., 275 Massachusetts Ave., Cambridge 39, Mass. ADV. PG. 48, 49.
- ⓧGuthman, Inc., Edwin I., 15 S. Throop St., Chicago, Ill.
- ⓧHEWLETT-PACKARD CO., 395 Page Mill Rd., Palo Alto, Calif. ADV. PG. 33-36.
- ⓧJackson Electrical Instrument Co., 16 S. Patterson Blvd., Dayton 1, Ohio.
- ⓧKELLOGG SWITCHBOARD & SUPPLY CO., 6650 S. Cicero Ave., Chicago 38, Ill. ADV. PG. 294.
- ⓧKROHN-HITE INSTRUMENT CO., 580 Massachusetts Ave., Cambridge 39, Mass. ADV. PG. 43.
- ⓧMARCONI INSTRUMENTS, LTD., 23 Beaver St., New York 4, N. Y. ADV. PG. 270.
- ⓧMcMurdo Silver Co., Inc., 417 Lafayette St., New York, N. Y.
- ⓧMeasurement Engineering, Ltd., Arnprior, Ontario, Canada.
- ⓧMEASUREMENTS CORP., Boonton, N. J. ADV. PG. 99.
- ⓧMelpar, Inc., 552 Swann Ave., Alexandria, Va.
- ⓧMonarch Radio & Television Corp., 2430 Atlantic Ave., Brooklyn 33, N. Y.
- ⓧMuirhead & Co., Inc., Beckenham-Kent-England.
- ⓧNORMAN LABORATORIES, ERNST, Williams Bay, Wis. ADV. PG. 346.
- ⓧOak Ridge Products Mfg. Div. of Video Television, Inc., 37-01 Vernon Blvd., Long Island City 1, N. Y.
- ⓧPHILAMON LABORATORIES, 5717 Third Ave., Brooklyn 20, N. Y. ADV. PG. 302.
- ⓧPhillips Petroleum Co., Market Development Div., Bartlesville, Okla.
- ⓧRadex Corp., 2076 N. Elston Ave., Chicago 14, Ill.
- ⓧRadio City Products Co., Inc., 152 W. 25th St., New York 1, N. Y.
- ⓧRADIO CORP. OF AMERICA, Tube Dept., Harrison, N. J. ADV. PG. 177, Inside Back and Back Covers.
- ⓧRAHM INSTRUMENTS, INC., 12 W. Broadway, New York 7, N. Y. ADV. PG. 354.
- ⓧShevers, Inc., Harold, 123 W. 64th St., New York 23, N. Y.
- ⓧSouthwestern Industrial Electronics Co., 2831 Post Oak Rd., P. O. Box 13058, Houston 19, Texas.

V indicates . . . **IN PRODUCTION • AVAILABILITY • UNRESTRICTED FOR GENERAL USE**

- Standard Telephones & Cables Ltd., Connaught House, Aldwych, London, W.C. 2, England.
- Supreme, Inc., Greenwood, Miss.
- SYLVANIA ELECTRIC PRODUCTS, INC.**, 1740 Broadway, New York 19, N. Y. ADV. PG. 432-436.
- Tech Laboratories, Inc., Bergen & Edsall Bldvs., Palisades Park, N. J.
- TELETRONICS LABORATORY, INC.**, 352 Maple Ave., Westbury, N. Y. ADV. PG. 418.
- Thordarson-Meissner Mfg. Divisions, 500 W. Huron St., Chicago 10, Ill.
- TRAD TELEVISION CORP.**, 1001 First Ave., Asbury Park, N. J. ADV. PG. 355.
- Triumph Mfg. Co., 913 W. Van Buren St., Chicago 7, Ill.
- Waveforms, Inc., 333 Sixth Ave., New York 14, N. Y.
- Weinschel Engineering Co., 123 William St., New York 7, N. Y.

OSCILLATORS—Cavity

- Bunnell & Co., J. H., 81 Prospect St., Brooklyn, N. Y.
- C.G.S. LABORATORIES, INC.**, 391 Ludlow St., Stamford, Conn. ADV. PG. 389.
- Decimeter, Inc., 1430 Market St., Denver 2, Colo.
- KAY ELECTRIC CO.**, 14 Maple Ave., Pine Brook, N. J. ADV. PG. 340.
- KINGS MICROWAVE CO., INC.**, 50 Marbledale Rd., Tuckahoe 7, N. Y. ADV. PG. 178, 179.
- MARCONI INSTRUMENTS, LTD.**, 23 Beaver St., New York 4, N. Y. ADV. PG. 270.
- Network Mfg. Corp., Bayonne, N. J.
- POLARAD ELECTRONICS CORP.**, 100 Metropolitan Ave., Brooklyn 11, N. Y. ADV. PG. 184, 185.
- POLYTECHNIC RESEARCH & DEVELOPMENT CO., INC.**, 202 Tillary St., Brooklyn 1, N. Y. ADV. PG. 172, 173.
- Radio Engineering Laboratories, Inc., 36-40 37th St., Long Island City 1, N. Y.
- Short Wave Plastic Forming Co., 2921 W. Alameda St., Burbank, Calif.
- SPERRY GYROSCOPE CO.**, Div. of The Sperry Corp., Great Neck, N. Y. ADV. PG. 103-104.
- VECTRON, INC.**, 235 High St., Waltham, Mass. ADV. PG. 214.
- Weymouth Instrument Co., 1440 Commercial St., East Weymouth 89, Mass.

OSCILLATORS—Crystal

- AMERICAN ELECTRONEERING CO.**, 5025-29 W. Jackson Blvd., Los Angeles 16, Calif. ADV. PG. 136.
- BARKER & WILLIAMSON**, 235 Fairfield Ave., Upper Darby, Pa. ADV. PG. 292.
- Bassett Inc., Rex, 307-311 N. W. First Ave., Fort Lauderdale, Fla.
- BLILEY ELECTRIC CO.**, Union Station Bldg., Erie, Pa. ADV. PG. 311, 407.
- CLARK CRYSTAL CO.**, 2 Farm Rd., Marlboro, Mass. ADV. PG. 366.
- Eidson Electronic Co., 1802 N. Third St., Temple, Texas.
- GENERAL RADIO CO.**, 275 Massachusetts Ave., Cambridge 39, Mass. ADV. PG. 48, 49.
- MARCONI INSTRUMENTS, LTD.**, 23 Beaver St., New York 4, N. Y. ADV. PG. 270.
- McMurdo Silver Co., Inc., 417 Lafayette St., New York, N. Y.
- Monarch Radio & Television Corp., 2430 Atlantic Ave., Brooklyn 33, N. Y.
- Nebel Lab., R. E., 1104 Lincoln Pl., Brooklyn 13, N. Y.
- NORRMAN LABORATORIES, ERNST, Williams Bay, Wis.** ADV. PG. 346.
- Piezo Products Co., Whitney St., Framingham, Mass.
- Schuttig & Co., Inc., 9th & Kearney Sts., N. E., Washington 17, D. C.
- SPERRY GYROSCOPE CO.**, Div. of The Sperry Corp., Great Neck, N. Y. ADV. PG. 103, 104.
- STANDARD CRYSTAL CO.**, 400 Armstrong Ave., Kansas City 1, Kans. ADV. PG. 156.
- Standard Telephones & Cables Ltd., Connaught House, Aldwych, London, W. C. 2, England.
- Tel-Instrument Co., Inc., 50 Patterson Ave., East Rutherford, N. J.
- VECTRON, INC.**, 235 High St., Waltham, Mass. ADV. PG. 214.
- Walkirt Co., 5808 Marilyn Ave., Culver City, Calif.
- WESTINGHOUSE ELECTRIC CORP.**, 511 Wood St., P. O. Box 868, Pittsburgh 30, Pa. ADV. PG. 107-113.

OSCILLATORS, GRID DIP—High Frequency & vhf

- BARKER & WILLIAMSON**, 235 Fairfield Ave., Upper Darby, Pa. ADV. PG. 292.
- Bassett, Inc., Rex, 307-311 N. W. First Ave., Fort Lauderdale, Fla.
- Manufacturers Thread Grinding, Inc., P. O. Box 66, Eatontown, N. J.
- MEASUREMENTS CORP.**, Boonton, N. J. ADV. PG. 99.

- Millen Mfg. Co., James, 150 Exchange St., Malden, Mass.
- New London Instrument Co., Box 189, New London, Conn.
- Tech Laboratories, Inc., Bergen & Edsall Bldvs., Palisades Park, N. J.

OSCILLATORS—Microwave Power

- C. G. S. LABORATORIES, INC.**, 391 Ludlow St., Stamford, Conn. ADV. PG. 389.
- Decimeter, Inc., 1430 Market St., Denver 2, Colo.
- KINGS MICROWAVE CO., INC.**, 50 Marbledale Rd., Tuckahoe 7, N. Y. ADV. PG. 178, 179.
- McMurdo Silver Co., Inc., 417 Lafayette St., New York, N. Y.
- MARCONI INSTRUMENTS, LTD.**, 23 Beaver St., New York 4, N. Y. ADV. PG. 270.
- Microwave Equipment Co. Inc., North Caldwell, N. J.
- Network Mfg. Corp., Bayonne, N. J.
- POLARAD ELECTRONICS CORP.**, 100 Metropolitan Ave., Brooklyn 11, N. Y. ADV. PG. 184, 185.
- POLYTECHNIC RESEARCH & DEVELOPMENT CO., INC.**, 202 Tillary St., Brooklyn 1, N. Y. ADV. PG. 172, 173.
- Press Wireless Mfg. Co., Inc., Cantiague Rd., Hicksville, N. Y.
- Short Wave Plastic Forming Co., 2921 W. Alameda St., Burbank, Calif.
- VECTRON, INC.**, 235 High St., Waltham, Mass. ADV. PG. 214.
- SPERRY GYROSCOPE CO.**, Div. of The Sperry Corp., Great Neck, N. Y. ADV. PG. 103, 104.
- Weymouth Instrument Co., 1440 Commercial St., East Weymouth 89, Mass.
- Wheeler Laboratories, Inc., Great Neck, N. Y.

OSCILLATORS—Oven Crystal Control

- Bassett Inc., Rex, 307-311 N. W. First Ave., Fort Lauderdale, Fla.
- BLILEY ELECTRIC CO.**, Union Station Bldg., Erie, Pa. ADV. PG. 311, 407.
- CLARK CRYSTAL CO.**, 2 Farm Rd., Marlboro, Mass. ADV. PG. 366.
- Gates Radio Co., Quincy, Ill.
- MARCONI INSTRUMENTS, LTD.**, 23 Beaver St., New York 4, N. Y. ADV. PG. 270.
- Nebel Lab., R. E., 1104 Lincoln Pl., Brooklyn 13, N. Y.
- Piezo Products Co., Whitney St., Framingham, Mass.
- Press Wireless Mfg. Co., Inc., Cantiague Rd., Hicksville, L. I., N. Y.
- STANDARD CRYSTAL CO.**, 400 Armstrong Ave., Kansas City 1, Kans. ADV. PG. 156.

OSCILLATORS—Radio Frequency

- AIRMEC LABORATORIES, LTD.**, 366 Madison Ave., New York 17, N. Y. ADV. PG. 336.
- AMERICAN ELECTRONEERING CO.**, 5025-29 W. Jefferson Blvd., Los Angeles 16, Calif. ADV. PG. 136.
- BARKER & WILLIAMSON**, 235 Fairfield Ave., Upper Darby, Pa. ADV. PG. 292.
- Bassett Inc., Rex, 307-311 N. W. First Ave., Fort Lauderdale, Fla.
- Bendix Aviation Corp., Pacific Div., 11600 Sherman Way, North Hollywood, Calif.
- BLILEY ELECTRIC CO.**, Union Station Bldg., Erie, Pa. ADV. PG. 311, 407.
- Clough Brengle Co., 6014 N. Broadway, Chicago, Ill.
- ELECTRONIC INSTRUMENT CO., INC.**, 276 Newport St., Brooklyn 12, N. Y. ADV. PG. 129.
- ELECTRONIC MEASUREMENTS COMPANY**, Red Bank, N. J. ADV. PG. 312.
- Electronic Measurements Corp., 280 Lafayette St., New York 12, N. Y.
- Ferrari Radio & Television Corp., 55 W. 26th St., New York 10, N. Y.
- Gates Radio Co., Quincy, Ill.
- GENERAL ELECTRIC CO.**, Electronics Dept., Electronics Park, Syracuse, N. Y. ADV. PG. 1 to 22.
- GENERAL RADIO CO.**, 275 Massachusetts Ave., Cambridge 39, Mass. ADV. PG. 48, 49.
- Guthman, Inc., Edwin I., 15 S. Throop St., Chicago, Ill.
- HEWLETT-PACKARD CO.**, 395 Page Mill Rd., Palo Alto, Calif. ADV. PG. 33-36.
- HICKOK ELECTRICAL INSTRUMENT CO.**, 10514 Dupont Ave., Cleveland 8, Ohio. ADV. PG. 333.
- Jackson Electrical Instrument Co., 16 S. Patterson Blvd., Dayton 1, Ohio.
- KAY ELECTRIC CO.**, 14 Maple Ave., Pine Brook, N. J. ADV. PG. 340.
- KINGS MICROWAVE CO., INC.**, 50 Marbledale Rd., Tuckahoe 7, N. Y. ADV. PG. 178, 179.
- McMurdo Silver Co., Inc., 417 Lafayette St., New York, N. Y.
- MARCONI INSTRUMENTS, LTD.**, 23 Beaver St., New York 4, N. Y. ADV. PG. 270.
- MEASUREMENTS CORP.**, Boonton, N. J. ADV. PG. 99.
- Monarch Radio & Television Corp., 2430 Atlantic Ave., Brooklyn 33, N. Y.
- Northeastern Engineering, Inc., Manchester, N. H.

- Oak Ridge Products Mfg. Div. of Video Television, Inc., 37-01 Vernon Blvd., Long Island City 1, N. Y.
- POLYTECHNIC RESEARCH & DEVELOPMENT CO., INC.**, 202 Tillary St., Brooklyn 1, N. Y. ADV. PG. 172, 173.
- Precision Apparatus Co., Inc., 92-27 Horace Harding Blvd., Elmhurst, N. Y.
- Press Wireless Mfg. Co., Inc., Cantiague Rd., Hicksville, L. I., N. Y.
- Ross Mfg. Co., 860 Washington St., Burlington, Iowa.
- Sherman Industrial Electronics Co., Inc., 505 Washington Ave., Belleville 9, N. J.
- Short Wave Plastic Forming Co., 2921 W. Alameda St., Burbank, Calif.
- Sierra Electronics Corp., San Carlos, Calif.
- STANDARD CRYSTAL CO.**, 400 Armstrong Ave., Kansas City 1, Kans. ADV. PG. 156.
- Stanwyck Winding Co., 137 Walsh Ave., Newburgh, N. Y.
- Supreme, Inc., Greenwood, Miss.
- Tech Laboratories, Inc., Bergen & Edsall Bldvs., Palisades Park, N. J.
- Technical Materiel Corp., The, P. O. Box 142, 121 Spencer Pl., Mamaroneck, N. Y.
- Technology Instrument Corp., 531 Main St., Acton, Mass.
- Tel-Instrument Co., Inc., 50 Patterson Ave., East Rutherford, N. J.
- Thordarson-Meissner Mfg. Divisions, 500 W. Huron St., Chicago 10, Ill.
- Tocco Division, Ohio Crankshaft Co., 3800 Harvard Ave., Cleveland 1, Ohio.
- TRAD TELEVISION CORP.**, 1001 First Ave., Asbury Park, N. J. ADV. PG. 355.
- Triplet Electrical Instrument Co., Harmon Road, Bluffton, Ohio.
- Weltronic Co., 19500 West 8 Mile Rd., Detroit 19, Mich.
- WESTINGHOUSE ELECTRIC CORP.**, 511 Wood St., P. O. Box 868, Pittsburgh 30, Pa. ADV. PG. 107-113.
- Woodwelding, Inc., 3000 W. Olive Ave., Burbank, Calif.

OSCILLATORS—Ultra-Low Frequency

- AIRMEC LABORATORIES, LTD.**, 366 Madison Ave., New York 17, N. Y. ADV. PG. 336.
- AMERICAN ELECTRONEERING CORP.**, 5025-29 W. Jefferson Blvd., Los Angeles 16, Calif. ADV. PG. 136.
- BLILEY ELECTRIC CO.**, Union Station Bldg., Erie, Pa. ADV. PG. 311, 407.
- Coulter Electronics, 3123 W. Fulton St., Chicago 12, Ill.
- Davies Laboratories, Inc., The, 4705 Queensbury Rd., Riverdale, Md.
- Guthman, Inc., Edwin I., 15 S. Throop St., Chicago, Ill.
- HEWLETT-PACKARD CO.**, 395 Page Mill Rd., Palo Alto, Calif. ADV. PG. 33-36.
- INDUSTRIAL CONTROL CO.**, Straight Path & Arlington Ave., Wyandanch, N. Y. ADV. PG. 130.
- KROHN-HITE INSTRUMENT CO.**, 580 Massachusetts Ave., Cambridge 39, Mass. ADV. PG. 43.
- SERVO CORP., OF AMERICA**, 20-20 Jericho Turnpike, New Hyde Park, N. Y. ADV. PG. 150, 151.
- Southwestern Industrial Electronics Co., 2831 Post Oak Rd., P. O. Box 13058, Houston 19, Texas.

OSCILLATORS—Ultrasonic

- AIRMEC LABORATORIES, LTD.**, 366 Madison Ave., New York 17, N. Y. ADV. PG. 336.
- AMERICAN ELECTRONEERING CORP.**, 5025-29 W. Jefferson Blvd., Los Angeles 16, Calif. ADV. PG. 136.
- BARKER & WILLIAMSON**, 235 Fairfield Ave., Upper Darby, Pa. ADV. PG. 292.
- BLILEY ELECTRIC CO.**, Union Station Bldg., Erie, Pa. ADV. PG. 311, 407.
- Bludworth Marine Div., National-Simplex-Bludworth, Inc., 92 Gold St., New York 38, N. Y.
- BRUSH DEVELOPMENT CO.**, 3405 Perkins Ave., Cleveland 14, Ohio. ADV. PG. 228, 229.
- CLARK CRYSTAL CO.**, 2 Farm Rd., Marlboro, Mass. ADV. PG. 366.
- COMMUNICATION ACCESSORIES CO.**, Box 345, 110th St. & Hillcrest Rd., Hickman Hills, Mo. ADV. PG. 168.
- Edo Corp., College Point, N. Y.
- Fisher Scientific Co., 717 Forbes St., Pittsburgh 19, Pa.
- GENERAL ELECTRIC CO.**, Schenectady 5, N. Y. ADV. PG. 1 to 22.
- GENERAL RADIO CO.**, 275 Massachusetts Ave., Cambridge 39, Mass. ADV. PG. 48, 49.
- Piezo Products Co., Whitney St., Framingham, Mass.
- RAYTHEON MFG. CO.**, Equipment Sales Div., Waltham 54, Mass. ADV. PG. 80, 81.
- Southwestern Industrial Electronics Co., 2831 Post Oak Rd., P. O. Box 13058, Houston 19, Tex.
- Standard Telephones & Cables Ltd., Connaught House, Aldwych, London, W. C. 2, England.

**OSCILLOGRAPHS
See Oscilloscopes**

V indicates . . . IN PRODUCTION • AVAILABILITY • UNRESTRICTED FOR GENERAL USE

OSCILLOGRAPH—Direct Writing

See Oscillographs, Recording

OSCILLOGRAPH—Cathode Ray Camera

- ①AIRMEC LABORATORIES LTD., 366 Madison Ave., New York 17, N. Y. ADV. PG. 336.
- ①Baldwin-Lima-Hamilton Corp., Paschall P. O. Station, Philadelphia 42, Pa.
- ①COSSOR LTD., A. C., 350 Fifth Ave., New York 1, N. Y. ADV. PG. 412.
- ①Cossor (Canada) Ltd., 301-303 Windsor St., Halifax, N. S., Canada.
- ①Du Mont Laboratories, Inc., Allen B., Instrument Div., 1000 Main Ave., Clifton, N. J.
- ①Edgerton, Germeshausen & Grier, Inc., 160 Brookline Ave., Boston, Mass.
- ①Electro-Medical Lab., Inc., South Woodstock, Vt.
- ①Electrodyne Company, 32 Oliver St., Boston, Mass.
- ①FAIRCHILD CAMERA & INSTRUMENT CORP., 88-06 Van Wyck Blvd., Jamaica 1, N. Y. ADV. PG. 244, 245.
- ①Flight Research Engineering Corp., P. O. Box 1-F, Richmond 1, Va.
- ①GENERAL ELECTRIC CO., Schenectady 5, N. Y. ADV. PG. 1 to 22.
- ①GENERAL PRECISION LAB., INC., Pleasantville, N. Y. ADV. PG. 58, 59.
- ①GENERAL RADIO CO., 275 Massachusetts Ave., Cambridge 39, Mass. ADV. PG. 48, 49.
- ①Grass Instrument Co., 101 Old Colony Ave., Quincy, Mass.
- ①HEILAND RESEARCH CORP., 130 E. 5th Ave., Denver 9, Colo. ADV. PG. 401.
- ①Midwestern Geophysical Laboratory, 3400 S. Harvard, Tulsa, Okla.
- ①Peerless Instrument Co., 90-15 Corona Ave., Elmhurst, N. Y.
- ①Photographic Products, Inc., 6916 Romaine St., Hollywood 38, Calif.
- ①Process & Instruments, 60 Greenpoint Ave., Brooklyn 22, N. Y.
- ①Southwestern Industrial Electronics Co., 2831 Post Oak Rd., P. O. Box 13058, Houston 19, Texas.
- ①Standard Telephones & Cables Ltd., Connaught House, Aldwych, London, W. C. 2, England.
- ①Warrick, Frederick P., 1960 Graefield Rd., Birmingham, Mich.

OSCILLOGRAPH — Cathode Ray Recording, Multichannel

- ①COSSOR, LTD., A. C., 350 Fifth Ave., New York 1, N. Y. ADV. PG. 412.
- ①Cossor (Canada) Ltd., 301-303 Windsor St., Halifax, N. S., Canada.
- ①Du Mont Laboratories, Inc., Allen B., Instrument Div., 1000 Main Ave., Clifton, N. J.
- ①Electro-Medical Lab., Inc., South Woodstock, Vt.
- ①Electrodyne Co., 32 Oliver St., Boston, Mass.
- ①ELECTRONIC TUBE CORP., 1200 E. Mermaid Ave., Philadelphia 18, Pa. ADV. PG. 335.
- ①FEDERAL TELEPHONE & RADIO CORP., 88 Kingsland Rd., Clifton, N. J. ADV. PG. 161-163.
- ①Hathaway Instrument Co., 1315 S. Clarkson St., Denver 10, Colo.
- ①HEILAND RESEARCH CORP., 130 E. Fifth Ave., Denver 9, Colo. ADV. PG. 401.
- ①Ionic Electronic Equipment Co., 1705 N. Kenmore, Los Angeles 27, Calif.
- ①Maryland Electronic Mfg. Corp., 5009 Calvert Rd., College Park, Md.
- ①Midwestern Geophysical Laboratory, 3400 S. Harvard, Tulsa, Okla.
- ①Miller Corp., William, 325 N. Halstead St., Pasadena 8, Calif.
- ①Photon Instrument Co., 6516 Detroit Ave., Cleveland 2, Ohio.
- ①Southwestern Industrial Electronics Co., 2831 Post Oak Rd., P. O. Box 13058, Houston 19, Texas.
- ①Tech Laboratories, Inc., Bergen & Edsall Bldvs., Palisades Park, N. J.
- ①Television Equipment Corp., 238 William St., New York, N. Y.
- ①TEL-O-TUBE CORP. OF AMERICA, Paterson, N. J. ADV. PG. 142.
- ①Z & W Machine Products, Inc., 5151 St. Clair Ave., Cleveland 3, Ohio.

OSCILLOGRAPH—Multi-Element

- ①Baldwin-Lima-Hamilton Corp., Paschall P. O. Station, Philadelphia 42, Pa.
- ①BRUSH DEVELOPMENT CO., THE, 3405 Perkins Ave., Cleveland 14, Ohio. ADV. PG. 228, 229.
- ①Century Geophysical Corp., 1333 N. Utica, Tulsa 3, Oklahoma.
- ①Consolidated Engineering Corp., 300 N. Sierra Madre Villa, Pasadena 8, Calif.
- ①COSSOR, LTD., A. C., 350 Fifth Ave., New York 1, N. Y. ADV. PG. 412.
- ①Electrofax Corp., 30 Burtis Ave., New Canaan, Conn.
- ①GENERAL ELECTRIC CO., Schenectady 5, N. Y. ADV. PG. 1 to 22.

- ①Grass Instrument Co., 101 Old Colony Ave., Quincy, Mass.
- ①Hathaway Instrument Co., 1315 S. Clarkson St., Denver 10, Colo.
- ①HEILAND RESEARCH CORP., 130 E. 5th Ave., Denver 9, Colo. ADV. PG. 401.
- ①Midwestern Geophysical Laboratory, 3400 S. Harvard, Tulsa, Okla.
- ①Miller Corp., William, 325 N. Halstead St., Pasadena 8, Calif.
- ①Offner Electronics, Inc., 5320 N. Kedzie Ave., Chicago 25, Ill.
- ①RAHM INSTRUMENTS INC., 12 West Broadway, New York 7, N. Y. ADV. PG. 354.
- ①SANBORN CO., 39 Osborn St., Cambridge 39, Mass. ADV. PG. 391.
- ①Southwestern Industrial Electronics Co., 2831 Post Oak Rd., P. O. Box 13058, Houston 19, Texas.
- ①Tech Laboratories, Inc., Bergen & Edsall Bldvs., Palisades Park, N. J.
- ①WESTINGHOUSE ELECTRIC CORP., 511 Wood St., P. O. Box 868, Pittsburgh 30, Pa. ADV. PG. 107-113.

OSCILLOGRAPH—Recording

- ①Baldwin-Lima-Hamilton Corp., Paschall P. O. Station, Philadelphia 42, Pa.
- ①BRUSH DEVELOPMENT CO., THE, 3405 Perkins Ave., Cleveland 14, Ohio. ADV. PG. 228, 229.
- ①Century Geophysical Corp., 1333 N. Utica, Tulsa 3, Oklahoma.
- ①Consolidated Engineering Corp., 300 N. Sierra Madre Villa, Pasadena 8, Calif.
- ①Edgerton Germeshausen & Grier, Inc., 160 Brookline Ave., Boston, Mass.
- ①Electro-Medical Lab., Inc., South Woodstock, Vt.
- ①Electrofax Corp., 30 Burtis Ave., New Canaan, Conn.
- ①ELECTRONIC TUBE CORP., 1200 E. Mermaid Lane, Philadelphia 18, Pa. ADV. PG. 335.
- ①Engineering Lab., Inc., 602 E. 4th St., Tulsa 3, Okla.
- ①GENERAL ELECTRIC CO., Schenectady 5, N. Y. ADV. PG. 1 to 22.
- ①Grass Instrument Co., 101 Old Colony Ave., Quincy, Mass.
- ①Hathaway Instrument Co., 1315 S. Clarkson St., Denver 10, Colo.
- ①HEILAND RESEARCH CORP., 130 E. 5th Ave., Denver 9, Colo. ADV. PG. 401.
- ①KAY ELECTRIC CO., 14 Maple Ave., Pine Brook, N. J. ADV. PG. 340.
- ①Maryland Electronic Mfg. Corp., 5009 Calvert Rd., College Park, Md.
- ①Midwestern Geophysical Laboratory, 3400 S. Harvard, Tulsa, Okla.
- ①Miller Corp., William, 325 N. Halstead St., Pasadena 8, Calif.
- ①Offner Electronics, Inc., 5320 N. Kedzie Ave., Chicago 25, Ill.
- ①Photon Instrument Co., 6516 Detroit Ave., Cleveland 2, Ohio.
- ①RAHM INSTRUMENTS, INC., 12 West Broadway, New York 7, N. Y. ADV. PG. 354.
- ①SANBORN CO., 39 Osborn St., Cambridge 39, Mass. ADV. PG. 391.
- ①Sound Apparatus Co., Stirling, N. J.
- ①Southwestern Industrial Electronics Co., 2831 Post Oak Rd., P. O. Box 13058, Houston 19, Texas.
- ①Tech Laboratories, Inc., Bergen & Edsall Bldvs., Palisades Park, N. J.
- ①WESTINGHOUSE ELECTRIC CORP., 511 Wood St., P. O. Box 868, Pittsburgh 30, Pa. ADV. PG. 107-113.
- ①Z & W Machine Products Inc., 5151 St. Clair Ave., Cleveland 3, Ohio.

OSCILLOGRAPH—Transient Study

See Oscilloscopes—Cathode Ray

OSCILLOSCOPES

See Oscillographs Accessories

See Tracers—Manual, for Oscilloscopes

OSCILLOSCOPES—Cathode Ray

- ①AIRMEC LABORATORIES, LTD., 366 Madison Ave., New York 17, N. Y. ADV. PG. 336.
- ①Approved Electronic Instrument Corp., 142 Liberty St., New York 6, N. Y.
- ①Baldwin-Lima-Hamilton Corp., Paschall P. O. Station, Philadelphia 42, Pa.
- ①BROWNING LABORATORIES, INC., 750 Main St., Winchester, Mass. ADV. PG. 257.
- ①Brujac Electronic Corp., 103 Lafayette St., New York 13, N. Y.
- ①Central Scientific Co., 1700 Irving Park Rd., Chicago 13, Ill.
- ①COSSOR, LTD., A. C., 350 Fifth Ave., New York 1, N. Y. ADV. PG. 412.
- ①Cossor (Canada) Ltd., 301-303 Windsor St., Halifax, N. S., Canada.
- ①Du Mont Laboratories, Inc., Allen B., Instrument Div., 1000 Main Ave., Clifton, N. J.
- ①Edgerton, Germeshausen & Grier, Inc., 160 Brookline Ave., Boston, Mass.

- ①ELECTRONIC INSTRUMENT CO., INC., 276 Newport St., Brooklyn 12, N. Y. ADV. PG. 129.
- ①ELECTRONIC TUBE CORP., 1200 E. Mermaid Ave., Philadelphia 18, Pa. ADV. PG. 335.
- ①Eltron, Inc., 407 N. Jackson St., Jackson, Mich.
- ①EL-TRONICS, INC., 2649 N. Howard St., Philadelphia 33, Pa. ADV. PG. 299.
- ①FEDERAL TELECOMMUNICATION LABS., INC., 500 Washington Ave., Nutley, N. J. ADV. PG. 164.
- ①FEDERAL TELEPHONE & RADIO CORP., 88 Kingsland Rd., Clifton, N. J. ADV. PG. 161-163.
- ①Feiler Engineering Co., 8026 Monticello Ave., Skokie, Ill.
- ①GENERAL ELECTRIC CO., Electronics Dept., Electronics Park, Syracuse, N. Y. ADV. PG. 1 to 22.
- ①HEATH CO., Benton Harbor, Mich. ADV. PG. 264...
- ①HICKOK ELECTRICAL INSTRUMENT CO., 10514 Dupont Ave., Cleveland 8, Ohio. ADV. PG. 333.
- ①HYCON MFG. CO., 2961 E. Colorado St., Pasadena, Calif. ADV. PG. 404.
- ①Ionic Electronic Equipment Co., 1705 N. Kenmore, Los Angeles 27, Calif.
- ①Jackson Electrical Instrument Co., 16 S. Patterson Blvd., Dayton 1, Ohio.
- ①LAVOIE LABORATORIES, Morganville, N. J. ADV. PG. 206.
- ①McMurdo Silver Co., Inc., 417 Lafayette St., New York, N. Y.
- ①Millen Mfg. Co., James, 150 Exchange St., Malden, Mass.
- ①Monarch Radio & Television Corp., 2430 Atlantic Ave., Brooklyn 39, N. Y.
- ①Peerless Instrument Co., 90-15 Corona Ave., Elmhurst, N. Y.
- ①POLARAD ELECTRONICS CORP., 100 Metropolitan Ave., Brooklyn 11, N. Y. ADV. PG. 184, 185.
- ①Precision Apparatus Co., Inc., 92-27 Horace Harding Blvd., Elmhurst, N. Y.
- ①Radio City Products Co., Inc., 152 W. 25th St., New York 1, N. Y.
- ①RADIO CORP. OF AMERICA, Tube Dept., Harrison, N. J. ADV. PG. 177, Inside Back & Back Covers.
- ①Reiner Electronics Co., 152 W. 25th St., New York, N. Y.
- ①Shevers, Inc., Harold, 123 W. 64th St., New York 23, N. Y.
- ①Simpson Electric Co. Div., American Gage & Machine Co., 5218 W. Kinzie St., Chicago 44, Ill.
- ①Supreme, Inc., Greenwood, Miss.
- ①SYLVANIA ELECTRIC PRODUCTS, INC., 1740 Broadway, New York 19, N. Y. ADV. PG. 432-436.
- ①Tektronix, Inc., 712 S. E. Hawthorne Blvd., Portland 14, Ore.
- ①Television Equipment Corp., 238 William St., New York 7, N. Y.
- ①TEL-O-TUBE CORP. OF AMERICA, Paterson, N. J. ADV. PG. 142.
- ①Triplet Electrical Instrument Co., Harmon Rd., Bluffton, Ohio.
- ①Triumph Mfg. Co., 913 W. Van Buren St., Chicago 7, Ill.
- ①WATERMAN PRODUCTS, 2445-63 Emerald St., Philadelphia 25, Pa. ADV. PG. 254, 255.

OSCILLOSCOPES, Cathode Ray — Multiple Channel

- ①COSSOR, LTD., A. C., 350 Fifth Ave., New York 1, N. Y. ADV. PG. 412.
- ①Cossor (Canada) Ltd., 301-303 Windsor St., Halifax, N. S., Canada.
- ①Du Mont Laboratories, Inc., Allen B., Instrument Div., 1000 Main Ave., Clifton, N. J.
- ①ELECTRONIC TUBE CORP., 1200 E. Mermaid Ave., Philadelphia 18, Pa. ADV. PG. 335.
- ①McMurdo Silver Co., Inc., 417 Lafayette St., New York, N. Y.
- ①Maryland Electronic Mfg. Corp., 5009 Calvert Rd., College Park, Md.
- ①Ionic Electronic Equipment Co., 1705 N. Kenmore, Los Angeles 27, Calif.
- ①Telegup Radio Co., 2559 W. 21st St., Chicago 8, Ill.
- ①TEL-O-TUBE CORP. OF AMERICA, Paterson, N. J. ADV. PG. 142.
- ①WATERMAN PRODUCTS, 2445-63 Emerald St., Philadelphia 25, Pa. ADV. PG. 254, 255.

OSCILLOSCOPES—Portable

- ①BROWNING LABORATORIES, INC., 750 Main St., Winchester, Mass. ADV. PG. 257.
- ①Brujac Electronic Corp., 103 Lafayette St., New York 13, N. Y.
- ①COSSOR, LTD., A. C., 350 Fifth Ave., New York 1, N. Y. ADV. PG. 412.
- ①Cossor (Canada) Ltd., 301-303 Windsor St., Halifax, N. S., Canada.
- ①Du Mont Laboratories, Inc., Allen B., Instrument Div., 1000 Main Ave., Clifton, N. J.
- ①ELECTRONIC INSTRUMENT CO., INC., 276 Newport St., Brooklyn 12, N. Y. ADV. PG. 129.
- ①Feiler Engineering Co., 8026 Monticello Ave., Skokie, Ill.
- ①GENERAL ELECTRIC CO., Electronics Dept., Electronics Park, Syracuse, N. Y. ADV. PG. 1 to 22.
- ①Glenco Corp., Metuchen, N. J.

V indicates . . . **IN PRODUCTION • AVAILABILITY • UNRESTRICTED FOR GENERAL USE**

- ⊙ **HICKOK ELECTRICAL INSTRUMENT CO.**, 10514 Dupont Ave., Cleveland 8, Ohio. ADV. PG. 333.
- ⊙ **LAVOIE LABORATORIES**, Morganville, N. J. ADV. PG. 206.
- ⊙ **Millen Mfg. Co.**, James, 150 Exchange St., Malden, Mass.
- ⊙ **Monarch Radio & Television Corp.**, 2430 Atlantic Ave., Brooklyn 33, N. Y.
- ⊙ **Peerless Instrument Co.**, 90-15 Corona Ave., Elmhurst, N. Y.
- ⊙ **Philco Corp.**, Tioga & C Sts., Philadelphia 34, Pa.
- ⊙ **Plastics & Electronics Co., Inc.**, P. O. Box 38, Station J, Buffalo 8, N. Y.
- ⊙ **POLARAD ELECTRONICS CORP.**, 100 Metropolitan Ave., Brooklyn 11, N. Y. ADV. PG. 184, 185.
- ⊙ **RADIO CORP. OF AMERICA**, Tube Dept., Harrison, N. J. ADV. PG. 177, Inside Back & Back Covers.
- ⊙ **Simpson Electric Co. Div.**, American Gage & Machine Co., 5218 W. Kinzie St., Chicago 44, Ill.
- ⊙ **Supreme, Inc.**, Greenwood, Miss.
- ⊙ **SYLVANIA ELECTRIC PRODUCTS, INC.**, 1740 Broadway, New York 19, N. Y. ADV. PG. 432-436.
- ⊙ **Tektronix, Inc.**, 712 Southeast Hawthorne Blvd., Portland 14, Ore.
- ⊙ **Triplet Electrical Instrument Co.**, Harmon Rd., Bluffton, Ohio.
- ⊙ **Triumph Mfg. Co.**, 913 W. Van Buren St., Chicago 7, Ill.
- ⊙ **WATERMAN PRODUCTS**, 2445-63 Emerald St., Philadelphia 25, Pa. ADV. PG. 254, 255.

OSCILLOSCOPES—Portable Projection

- ⊙ **BETA ELECTRIC CORP.**, 1762 Third Ave., New York 29, N. Y. ADV. PG. 399.
- ⊙ **Bruic Electronic Corp.**, 103 Lafayette St., New York 13, N. Y.
- ⊙ **Monarch Radio & Television Corp.**, 2430 Atlantic Ave., Brooklyn 33, N. Y.
- ⊙ **Simpson Electric Co. Div.**, American Gage & Machine Co., 5218 W. Kinzie St., Chicago 44, Ill.
- ⊙ **TELETRONICS LABORATORY, INC.**, 352 Maple Ave., Westbury, N. Y. ADV. PG. 418.
- ⊙ **Television Equipment Corp.**, 238 William St., New York 7, N. Y.

OVENS—Crystal

- ⊙ **Bassett, Inc.**, Rex, 307-311 N. W. First Ave., Fort Lauderdale, Fla.
- ⊙ **CLARK CRYSTAL CO.**, 2 Farm Rd., Marlboro, Mass. ADV. PG. 366.
- ⊙ **MARCONI INSTRUMENTS, LTD.**, 23 Beaver St., New York 4, N. Y. ADV. PG. 270.
- ⊙ **Miller, August E.**, 9226 Hudson Blvd., North Bergen, N. J.
- ⊙ **Monitor Products Co.**, 815 Fremont Ave., South Pasadena, Calif.
- ⊙ **Nebel Lab.**, R. E., 1104 Lincoln Pl., Brooklyn 13, N. Y.
- ⊙ **OHMWEVE CO.**, Darcy St., West Hartford 6, Conn. ADV. PG. 380.
- ⊙ **Polytech Devices, Inc.**, 180 E. Grand St., Elizabeth, N. J.
- ⊙ **Press Wireless Mfg. Co., Inc.**, Cantigue Rd., Hicksville, N. Y.
- ⊙ **STANDARD CRYSTAL CO.**, 400 Armstrong Ave., Kansas City 1, Kans. ADV. PG. 156.

OVENS—Electric

- ⊙ **Acme Electric Heating Co.**, 1217 Washington St., Boston, Mass.
- ⊙ **Ajax Electrothermic Corp.**, Ajax Park, Trenton 5, N. J.
- ⊙ **American Instrument Co.**, 8030 Georgia Ave., Silver Spring, Md.
- ⊙ **Central Scientific Co.**, 1700 Irving Park Rd., Chicago 13, Ill.
- ⊙ **EISLER ENGINEERING CO., INC.**, 740 S. 13th St., Newark 3, N. J. ADV. PG. 378.
- ⊙ **GENERAL ELECTRIC CO.**, Schenectady 5, N. Y. ADV. PG. 1 to 22.
- ⊙ **Gordon Co., Claud S.**, 3000 S. Wallace St., Chicago 16, Ill.
- ⊙ **GRIEVE-HENDRY CO.**, 1101 N. Paulina St., Chicago 22, Ill. ADV. PG. 346.
- ⊙ **Huppert Co.**, K. H., 6830 Cottage Grove Ave., Chicago 37, Ill.
- ⊙ **STEINER-IVES CO.**, 16 Avenue L, Newark 5, N. J. ADV. PG. 136.
- ⊙ **Sherman Industrial Electronics Co., Inc.**, 505 Washington Ave., Belleville 9, N. J.
- ⊙ **Western Gold & Platinum Works**, 589 Bryant St., San Francisco, Calif.
- ⊙ **Young Brothers Co.**, 1829 Columbus Rd., Cleveland, Ohio.

OVENS—Infra-Red Drying

- ⊙ **Burdett Mfg. Co.**, 3420 W. Madison St., Chicago 24, Ill.

- ⊙ **Fostoria Pressed Steel Corp.**, Fostoria, Ohio.
- ⊙ **Miskella Infra-Red Co.**, The, E. 73rd & Grand Ave., Cleveland 4, Ohio.

PAINTS—Conductive (For Printed Circuit)

- ⊙ **Acheson Colloids Corp.**, Port Huron, Mich.
- ⊙ **Du Pont de Nemours & Co., Inc.**, E. 1., Wilmington, Delaware.
- ⊙ **Egyptian Lacquer Mfg. Co.**, Lafayette, Ind.
- ⊙ **General Cement Mfg. Co.**, 919 Taylor Ave., Rockford, Ill.
- ⊙ **Hanovia Chemical & Mfg. Co.**, 233 NJ RR Ave., Newark, N. J.
- ⊙ **Horn Co., Inc.**, A. C., 10th St. & 44th Ave., Long Island City 1, N. Y.
- ⊙ **INSL-X CO., INC.**, Water St., Ossining, N. Y. ADV. PG. 386.
- ⊙ **Metaplast Process, Inc.**, 9-17 37th Ave., Long Island City 1, N. Y.
- ⊙ **MICRO-CIRCUITS CO.**, New Buffalo, Mich. ADV. PG. 50.
- ⊙ **Sauereisen Cements Co.**, Sauereisen Bldg., Pittsburgh 15, Pa.

PANELS—Instrument

- ⊙ **ABALON PRECISION MFG. CORP.**, 540 Casanova St., Bronx 59, N. Y. ADV. PG. 348.
- ⊙ **Acromark Co.**, The, 442 Morrell St., Elizabeth 4, N. J.
- ⊙ **Aeronautical Electronics, Inc.**, Raleigh-Durham Airport, P. O. Box 6043, Raleigh, N. C.
- ⊙ **AIRMEC LABORATORIES, LTD.**, 366 Madison Ave., New York 17, N. Y. ADV. PG. 336.
- ⊙ **ART-LLOYD METAL PRODUCTS CORP.**, 2973 Cropsey Ave., Brooklyn 14, N. Y. ADV. PG. 364.
- ⊙ **Baer Co.**, N. S., 9 Montgomery St., Hillside, N. J.
- ⊙ **Bailey Meter Co.**, 1044 Ivanhoe Rd., Cleveland 10, Ohio.
- ⊙ **Bristol Co.**, The, Waterbury 20, Conn.
- ⊙ **Colgate Mfg. Corp.**, Lindenhurst, N. Y.
- ⊙ **Columbia Metal Box Co.**, 260 E. 143rd St., New York, N. Y.
- ⊙ **Corry Jamestown Mfg. Co.**, Corry, Pa.
- ⊙ **Cortland Industries, Inc.**, 4545 Cortland St., Chicago 39, Ill.
- ⊙ **Cossor (Canada), Ltd.**, 301-303 Windsor St., Halifax, N. S., Canada.
- ⊙ **Croname, Inc.**, 3701 Ravenswood Ave., Chicago, Ill.
- ⊙ **Cutler Metal Products Co.**, 1025 Line St., Camden, N. J.
- ⊙ **DEJUR-AMSCO CORP.**, Northern Blvd. at 45th St., Long Island City 1, N. Y. ADV. PG. 377.
- ⊙ **Eastern Specialty Co.**, Philadelphia 40, Pa.
- ⊙ **Edwards Co., Inc.**, 86 Boston Post Rd., Norwalk, Conn.
- ⊙ **EMELOID CO., INC.**, 1239 Central Ave., Hillside 5, N. J. ADV. PG. 102.
- ⊙ **Etched Products Corp.**, 39-01 Queens Blvd., Long Island City, N. Y.
- ⊙ **FALSTROM CO.**, 44 Falstrom Court, Passaic, N. J. ADV. PG. 196.
- ⊙ **GENERAL ELECTRIC CO.**, Schenectady 5, N. Y. ADV. PG. 1 to 22.
- ⊙ **Gordon Co., Claud S.**, 3000 S. Wallace St., Chicago 16, Ill.
- ⊙ **Insulating Fabricators of New England, Inc.**, 69 Grove St., Watertown 72, Mass.
- ⊙ **Insulation Mfg. Co.**, 11 New York Ave., Brooklyn, N. Y.
- ⊙ **Johns-Manville**, 22 East 40th St., New York 16, N. Y.
- ⊙ **KARP METAL PRODUCTS CO., INC.**, 215 63rd St., Brooklyn 20, N. Y. ADV. PG. 105.
- ⊙ **LOJACK PRECISION CORP.**, 32-60 62 St., Woodside, N. Y. ADV. PG. 415.
- ⊙ **Magna Electronics Co.**, 3701-11 W. Jefferson Blvd., Los Angeles 16, Calif.
- ⊙ **Masonite Corp.**, 111 W. Washington St., Chicago 2, Ill.
- ⊙ **Mica Insulator Co.**, Schenectady 1, N. Y.
- ⊙ **Minneapolis-Honeywell Regulator Co.**, 2753 Fourth Ave. S., Minneapolis, Minn.
- ⊙ **MULTI-METAL CO.**, 1350 Garrison Ave., New York 59, N. Y. ADV. PG. 221.
- ⊙ **Plastic Accessories, Inc.**, 93 Mercer St., New York 12, N. Y.
- ⊙ **Ports Mfg. Co.**, 3265 E. Belmont Ave., Fresno 2, Calif.
- ⊙ **Premier Metal Etching Co.**, 21-03 44th Ave., Long Island City, N. Y.
- ⊙ **Printlinc Inc.**, 95 Mercer St., New York 12, N. Y.
- ⊙ **REF Mfg. Corp.**, Jericho Turnpike, Mineola, N. Y.
- ⊙ **RICHARDSON CO., THE**, 2767 Lake St., Melrose Park, Ill. ADV. PG. 310.
- ⊙ **Roller-Smith, Bethlehem, Pa.**
- ⊙ **Spaulding Fibre Co., Inc.**, 310 Wheeler St., Tonawanda, N. Y.
- ⊙ **Stamford Metal Specialty Co., Inc.**, 429 W. Broadway, New York 12, N. Y.
- ⊙ **STANDARD ELECTRIC TIME CO.**, 89 Logan St., Springfield, Mass. ADV. PG. 40.
- ⊙ **Tagliabue Div.**, Weston Electrical Instrument Corp., 614 Frelinghuysen Ave., Newark 5, N. J.
- ⊙ **Walter Co., Inc.**, S., 1400 Atlantic Ave., Brooklyn 16, N. Y.
- ⊙ **WESTINGHOUSE ELECTRIC CORP.**, 511 Wood St., P. O. Box 868, Pittsburgh 30, Pa. ADV. PG. 107-113.
- ⊙ **Wheelco Instruments Co.**, 847 W. Harrison St., Chicago 7, Ill.

PANELS—Receiver & Transmitter

- ⊙ **ABALON PRECISION MFG. CORP.**, 540 Casanova St., Bronx 59, N. Y. ADV. PG. 348.
- ⊙ **ART-LLOYD METAL PRODUCTS CORP.**, 2973 Cropsey Ave., Brooklyn 14, N. Y. ADV. PG. 364.
- ⊙ **Bristol Co.**, The, Waterbury 20, Conn.
- ⊙ **Bud Radio, Inc.**, 2118 E. 55th St., Cleveland 3, Ohio.
- ⊙ **Colgate Mfg. Corp.**, Lindenhurst, N. Y.
- ⊙ **Columbia Metal Box Co.**, 260 E. 143rd St., New York, N. Y.
- ⊙ **Corry Jamestown Mfg. Co.**, Corry, Pa.
- ⊙ **Cossor (Canada), Ltd.**, 301-303 Windsor St., Halifax, N. S., Canada.
- ⊙ **Croname, Inc.**, 3701 Ravenswood Ave., Chicago, Ill.
- ⊙ **Cutler Metal Products Co.**, 1025 Line St., Camden, N. J.
- ⊙ **Donnelly Electric & Mfg. Co.**, 3050 Washington St., Boston, Mass.
- ⊙ **Etched Products Corp.**, 39-01 Queens Blvd., Long Island City, N. Y.
- ⊙ **Insuline Corp. of America**, 36-02 35th Ave., Long Island City, N. Y.
- ⊙ **KARP METAL PRODUCTS CO., INC.**, 215 63rd St., Brooklyn 20, N. Y. ADV. PG. 105.
- ⊙ **LOJACK PRECISION CORP.**, 32-60162 St., Woodside, N. Y. ADV. PG. 415.
- ⊙ **Magna Electronics Co.**, 3701-11 W. Jefferson Blvd., Los Angeles 16, Calif.
- ⊙ **Masonite Corp.**, 111 W. Washington St., Chicago 2, Ill.
- ⊙ **Measurement Engineering, Ltd.**, Arnprior, Ontario, Canada.
- ⊙ **Plastic Accessories, Inc.**, 93 Mercer St., New York 12, N. Y.
- ⊙ **Ports Mfg. Co.**, 3265 E. Belmont Ave., Fresno 2, Calif.
- ⊙ **Printlinc Inc.**, 95 Mercer St., New York 12, N. Y.
- ⊙ **Radio Engineering Laboratories, Inc.**, 36-40 37th St., Long Island City 1, N. Y.
- ⊙ **Walter Co., Inc.**, S., 1400 Atlantic Ave., Brooklyn 16, N. Y.
- ⊙ **WESTINGHOUSE ELECTRIC CORP.**, 511 Wood St., P. O. Box 868, Pittsburgh 30, Pa. ADV. PG. 107-113.

PANELS—Relay Rack

- ⊙ **ABALON PRECISION MFG. CORP.**, 540 Casanova St., Bronx 59, N. Y. ADV. PG. 348.
- ⊙ **ALDEN PRODUCTS CO.**, 117 N. Main St., Brockton 64, Mass. ADV. PG. 327.
- ⊙ **ART-LLOYD METAL PRODUCTS CORP.**, 2973 Cropsey Ave., Brooklyn 14, N. Y. ADV. PG. 364.
- ⊙ **Autocal Co.**, The, Shelby, Ohio.
- ⊙ **Bud Radio Inc.**, 2118 E. 55th St., Cleveland 3, Ohio.
- ⊙ **Colgate Mfg. Corp.**, Lindenhurst, N. Y.
- ⊙ **Connecticut Telephone & Electric Corp.**, 70 Britannia St., Meriden, Conn.
- ⊙ **Cossor (Canada), Ltd.**, 301-303 Windsor St., Halifax, N. S., Canada.
- ⊙ **Cutler Metal Products Co.**, 1025 Line St., Camden, N. J.
- ⊙ **Donnelly Electric & Mfg. Co.**, 3050 Washington St., Boston, Mass.
- ⊙ **Edwards Co., Inc.**, 86 Boston Post Rd., Norwalk, Conn.
- ⊙ **Etched Products Corp.**, 39-01 Queens Blvd., Long Island City, N. Y.
- ⊙ **Insuline Corp. of America**, 36-02 35th Ave., Long Island City, N. Y.
- ⊙ **JOHNSON CO.**, E. F., Waseca, Minn. ADV. PG. 118, 121.
- ⊙ **KARP METAL PRODUCTS CO., INC.**, 215 63rd St., Brooklyn 20, N. Y. ADV. PG. 105.
- ⊙ **LOJACK PRECISION CORP.**, 32-60 62 St., Woodside, N. Y. ADV. PG. 415.
- ⊙ **Masonite Corp.**, 111 W. Washington St., Chicago 2, Ill.
- ⊙ **Measurement Engineering, Ltd.**, Arnprior, Ontario, Canada.
- ⊙ **Par-Metal Products Corp.**, 32-62 49th St., Long Island City 3, N. Y.
- ⊙ **Radio Engineering Laboratories, Inc.**, 36-40 37th St., Long Island City 1, N. Y.
- ⊙ **SIGNAL ENGINEERING & MFG. CO.**, 154-6 W. 14th St., New York, N. Y. ADV. PG. 256.
- ⊙ **Walter Co., Inc.**, S., 1400 Atlantic Ave., Brooklyn 16, N. Y.
- ⊙ **WESTINGHOUSE ELECTRIC CORP.**, 511 Wood St., P. O. Box 868, Pittsburgh 30, Pa. ADV. PG. 107-113.

PAPER
See **Insulation Materials**

PAPER—Facsimile Recording

- ⊙ **ALDEN PRODUCTS CO.**, 117 N. Main St., Brockton 64, Mass. ADV. PG. 327.
- ⊙ **Alfax Paper & Engrg. Co.**, Washington St., P. O. Box 125, Westboro, Mass.
- ⊙ **Bruning Co., Inc.**, Charles, 102 Reade St., New York, N. Y.
- ⊙ **Eastman Kodak Co.**, Industrial Photographic Div., 343 State St., Rochester 4, N. Y.
- ⊙ **General Photo Products Co.**, 15 Summit Ave., Chatham, N. J.

V indicates . . . IN PRODUCTION • AVAILABILITY • UNRESTRICTED FOR GENERAL USE

- Ⓞ Gorrell & Gorrell, Haworth, N. J.
- Ⓞ Hogan Laboratories, Inc., 155 Perry St., New York 14, N. Y.
- Ⓞ Press Wireless Mfg. Co., Inc., Cantiague Rd., Hicksville, N. Y.
- Ⓞ Standard Telephones & Cables Ltd., Connaught House, Aldwych, London, W. C. 2, England.
- Ⓞ TIMES FACSIMILE CORP., 540 W. 58th St., New York 19, N. Y. ADV. PG. 288.
- Ⓞ Western Union Telegraph Co., 60 Hudson St., New York 13, N. Y.

PERMEAMETERS—High H

- Ⓞ Rubicon Co., 3761 Ridge Ave., Philadelphia 42, Pa.

PHENOLIC MOLDING COMPOUNDS See Insulating Compounds

PHONOGRAPHS—Electric Phonographs & Record Players

- Ⓞ Admiral Corp., 3800 Cortland St., Chicago 47, Ill.
- Ⓞ Ansley Mfg. Co., Arthur, Doylestown, Pa.
- Ⓞ Audio Industries, Michigan City, Ind.
- Ⓞ Autocrat Radio Co., 5024 Elm St., Skokie, Ill.
- Ⓞ Bell Sound Systems, Inc., 555 Marion Rd., Columbus 7, Ohio.
- Ⓞ Bogen Co., Inc., David, 663 Broadway, New York 12, N. Y.
- Ⓞ Califfone Corp., 1041 N. Sycamore Ave., Hollywood 38, Calif.
- Ⓞ Carron Mfg. Co., 415 S. Aberdeen St., Chicago, Ill.
- Ⓞ Coronet Radio & Television Corp., 500 W. 52nd St., New York 19, N. Y.
- Ⓞ Electro Engineering & Mfg. Co., 627 W. Alexandrine Ave., Detroit 1, Mich.
- Ⓞ Emerson Radio & Phonograph Corp., 111 Eighth Ave., New York, N. Y.
- Ⓞ Espey Mfg. Co., Inc., 528 E. 72nd St., New York, N. Y.
- Ⓞ Fairchild Recording Equipment Co., 154th St. and 7th Ave., Whitestone, N. Y.
- Ⓞ Ferrar Radio & Television Corp., 55 W. 26th St., New York 10, N. Y.
- Ⓞ Fidelity Amplifier Co., 703 Willow St., Chicago 14, Ill.
- Ⓞ Gale Dorothea Mechanisms, 37-61 85th St., Jackson Heights, N. Y.
- Ⓞ Gates Radio Co., Quincy, Ill.
- Ⓞ Hartley Co., Ltd., H. A., 152 Hammersmith Rd., London W. 6, England.
- M. P. Concert Installations, Fairfield 10, Conn.
- Ⓞ Majestic Radio & Television Div. of The Wilcox-Gay Corp., 70 Washington St., Brooklyn 1, N. Y.
- Ⓞ McMurdo Silver Co., Inc., 417 Lafayette St., New York, N. Y.
- Ⓞ Meck Industries, John, Liberty at Pennsylvania, Plymouth, Ind.
- Ⓞ Newcomb Audio Products Co., 6824 Lexington Ave., Hollywood 38, Calif.
- Ⓞ Philco Corp., Tioga & C Sts., Philadelphia 34, Pa.
- Ⓞ RADIO CORP. OF AMERICA, RCA Victor Div., Home Instrument Dept., Camden, N. J. ADV. PG. 177, Inside Back & Back Covers.
- Ⓞ Rek-O-Kut Co., Inc., 38-01 Queens Blvd., Long Island City, N. Y.
- Ⓞ Scott, Inc., Hermon Hosmer, 385 Putnam Ave., Cambridge 39, Mass.
- Ⓞ Simpson Mfg. Co., Inc., Mark, 32-28 49th St., Long Island City 3, N. Y.
- Ⓞ Sonic Industries, Inc., 221 W. 17th St., New York 11, N. Y.
- Symphony Radio & Television Corp., 721 N. Martel Ave., Los Angeles 15, Calif.
- Ⓞ V-M Corp., Benton Harbor, Mich.
- Ⓞ Western Sound & Electric Labs., Inc., 805 S. Fifth St., Milwaukee 4, Wis.
- Ⓞ Wurlitzer Co., Rudolph, The, N. Tonawanda, N. Y.

PHOTOFLASH EQUIPMENT—Electronic

- Ⓞ Amglo Corp., 4234 Lincoln Ave., Chicago 18, Ill.
- Ⓞ Dormitzer Electric Co., Inc., 89 Brighton Ave., Boston 34, Mass.
- Ⓞ Eastman Kodak Co., Industrial Photographic Div., 343 State St., Rochester 4, N. Y.
- Ⓞ Edgerton, Gernsmaier & Grier, Inc., 160 Brookline Ave., Boston, Mass.
- Electronic Products Div., Epco Products, Inc., 2430 Atlantic Ave., Brooklyn 33, N. Y.
- Ⓞ GENERAL ELECTRIC CO., Schenectady 5, N. Y. ADV. PG. 1 to 22.
- Ⓞ HEILAND RESEARCH CORP., 130 E. 5th Ave., Denver 9, Colo. ADV. PG. 401.
- Ionic Electronic Equipment Co., 1705 N. Kenmore, Los Angeles 27, Calif.
- Ⓞ Kemlite Labs., 1819 W. Grand Ave., Chicago 22, Ill.
- Ⓞ Lectronic Research Labs., 1021 Callowhill St., Philadelphia 23, Pa.
- Ⓞ Mallory & Co., Inc., P. R., 3029 E. Washington St., Indianapolis 6, Ind.
- Ⓞ MOELECTRIC PRODUCTS CORP., 1500 Bangs Ave., Asbury Park, N. J. ADV. PG. 204.
- Ⓞ Reeve Electronics, Inc., 609 W. Lake St., Chicago 6, Ill.

- Ⓞ SYLVANIA ELECTRIC PRODUCTS, INC., 1740 Broadway, New York 19, N. Y. ADV. PG. 432-436.
- Ⓞ Triumph Mfg. Co., 913 W. Van Buren St., Chicago 7, Ill.

PHOTOGRAPHIC MATERIALS—Films and Papers for Recording Instruments

- Ⓞ Berndt-Bach, Inc., 7373 Beverly Blvd., Los Angeles 36, Calif.
- Ⓞ Bruning Co., Inc., Charles, 102 Reade St., New York, N. Y.
- Ⓞ du Pont de Nemours & Co., Inc., E. I., Wilmington, Delaware.
- Ⓞ Eastman Kodak Co., Industrial Photographic Div., 343 State St., Rochester 4, N. Y.
- Ⓞ General Photo Products Co., 15 Summit Ave., Chatham, N. J.
- Ⓞ Haloid Co., The, 6 Haloid St., Rochester, N. Y.
- Ⓞ Peerless Photo Products, Shoreham, L. I., N. Y.
- Ⓞ Schweitzer, Inc., Peter J., 405 Lexington Ave., New York 17, N. Y.

PHOTOGRAPHIC MATERIALS — Spectrographic Instruments

- Ⓞ Eastman Kodak Co., Industrial Photographic Div., 343 State St., Rochester 4, N. Y.
- Ⓞ Jarrell-Ash Co., 165 Newberry St., Boston 16, Mass.

PHOTOGRAPHIC MATERIALS—X-Ray Films

- Ⓞ du Pont de Nemours & Co., Inc., E. I., Wilmington, Delaware.
- Ⓞ Eastman Kodak Co., Industrial Photographic Div., 343 State St., Rochester 4, N. Y.

PHOTOMETERS

- Ⓞ Baird Associates, 33 University Rd., Cambridge 35, Mass.
- Ⓞ Barclay Instruments Div., The Patent Button Co., Waterbury 88, Conn.
- Ⓞ Beckman Instruments, Inc., 820 Mission St., South Pasadena, Calif.
- Ⓞ Farrand Optical Co., Inc., Bronx Blvd. at 238th St., New York 70, N. Y.
- Ⓞ GENERAL ELECTRIC CO., Schenectady 5, N. Y. ADV. PG. 1 to 22.
- Ⓞ ORTHON CORP., THE, 196 Albion Ave., Paterson 2, N. J. ADV. PG. 156.
- Ⓞ Photovolt Corp., 95 Madison Ave., New York 16, N. Y.
- Process & Instruments, 60 Greenpoint Ave., Brooklyn 22, N. Y.
- Ⓞ Rubicon Co., 3761 Ridge Ave., Philadelphia 42, Pa.
- Ⓞ WESTON ELECTRICAL INSTRUMENT CORP., 595 Frelinghuysen Ave., Newark 5, N. J. ADV. PG. 243.

PH METERS, RECORDERS AND COMPARATORS See Meters

PHOTOCOPIERS See Machines

PHOTOTUBES AND PHOTOCELLS See Tubes

PICKUPS—Crystal See Crystal Cartridges

PICKUPS—Industrial

- Doelcam Corp., 56 Elmwood St., Newton 58, Mass.
- Ⓞ ELECTRO PRODUCTS LABS., 4501 N. Ravenswood Ave., Chicago 40, Ill. ADV. PG. 199.
- Ⓞ Flader, Inc., Fredric, 1330 Laskey Rd., Toledo 12, Ohio.
- Ⓞ Hart Associates, 8430 Grand River, Detroit 4, Mich.
- Ⓞ MB MFG CO., 1060 State St., New Haven 11, Conn. ADV. PG. 365.
- Ⓞ Monarch Radio & Television Corp., 2430 Atlantic Ave., Brooklyn 33, N. Y.
- Ⓞ RAHM INSTRUMENTS, INC., 12 West Broadway, New York 7, N. Y. ADV. PG. 354.

PICKUPS—Magnetic

- Ⓞ A. P. W. Co., 72 W. Main St., Rockaway, N. J.
- Ⓞ Altec Lansing Corp., 9356 Santa Monica Blvd., Beverly Hills, Calif.
- Ⓞ Astatic Corp., The, Conneaut, Ohio.
- Ⓞ Audak Co., 500 Fifth Ave., New York, N. Y.
- Ⓞ Caltron Co., 1406 Hobart Blvd., Los Angeles 6, Calif.
- Ⓞ Clarkstan Corp., 11921 S. W. Pico Blvd., Los Angeles 64, Calif.
- Doelcam Corp., 56 Elmwood St., Newton 58, Mass.
- Ⓞ ELECTRO PRODUCTS LABS., 4501 N. Ravenswood Ave., Chicago 40, Ill. ADV. PG. 199.

- Ⓞ ELECTRO-VOICE, INC., Buchanan, Mich. ADV. PG. 345.
- Ⓞ Garrard Sales Corp., 134 Duane St., New York 13, N. Y.
- Ⓞ Hartley Co., Ltd., H. A., 152 Hammersmith Rd., London W. 6, England.
- Ⓞ Monarch Radio & Television Corp., 2430 Atlantic Ave., Brooklyn 33, N. Y.
- Ⓞ Philco Corp., Tioga & C Sts., Philadelphia 34, Pa.
- Ⓞ PICKERING & CO., 309 Woods Ave., Oceanside, L. I., N. Y. ADV. PG. 284.
- Ⓞ RADIO CORP. OF AMERICA, RCA Victor Div., General Offices, Camden, N. J. ADV. PG. 177, Inside Cover & Back Covers.
- Ⓞ Standard Telephones & Cables Ltd., Connaught House, Aldwych, London, W.C. 2, England.
- Ⓞ Valco Mfg. Co., 4700 W. Walton St., Chicago 51, Ill.

PICKUPS—Photoelectric

- Ⓞ AIRMEC LABORATORIES, LTD., 366 Madison Ave., New York 17, N. Y. ADV. PG. 336.
- Ⓞ Hart Associates, 8430 Grand River, Detroit 4, Mich.
- Ⓞ Industrial Electronics Co., Hanover, Mass.
- Ⓞ Photobell Company, 116 Nassau St., New York 7, N. Y.
- Ⓞ Standard Electronics Research Corp., 2 East End Ave., New York 21, N. Y.

PICKUPS—Quartz Crystal

- Ⓞ Bassett, Inc., Rex, 307-311 N.W. First Ave., Fort Lauderdale, Fla.
- Ⓞ Polytech Devices, Inc., 1180 E. Grand St., Elizabeth, N. J.
- Ⓞ Sonotone Corp., P.O. Box 200, Saw Mill River Rd., Elmsford, N. Y.
- Ⓞ Sperry Products, Inc., Danbury, Conn.

PICKUPS—Transcription and Phonograph

- Ⓞ Altec Lansing Corp., 9356 Santa Monica Blvd., Beverly Hills, Calif.
- Ⓞ American Microphone Co., 370 S. Fair Oaks Ave., Pasadena 1, Calif.
- Ⓞ Astatic Corp., The, Conneaut, Ohio.
- Ⓞ Audak Co., 500 Fifth Ave., New York, N. Y.
- Ⓞ Clarkstan Corp., 11921 S. W. Pico Blvd., Los Angeles 64, Calif.
- Ⓞ ELECTRO-VOICE, INC., Buchanan, Mich. ADV. PG. 345.
- Ⓞ Lear, Inc., 110 Ionia Ave., N. W., Grand Rapids 2, Mich.
- Ⓞ Pfanstiel Chemical Co., Metallurgical Div., 104 Lake View Ave., Waukegan, Ill.
- Ⓞ PICKERING & CO., 309 Woods Ave., Oceanside, N. Y. ADV. PG. 284.
- Ⓞ Proctor Soundex Corp., 133 N. 6th Ave., Mt. Vernon, N. Y.
- Ⓞ RADIO CORP. OF AMERICA, Tube Dept., Harrison, N. J. ADV. PG. 177, Inside Back & Back Covers.
- Ⓞ Sonotone Corp., P.O. Box 200, Saw Mill River Rd., Elmsford, N. Y.
- Ⓞ Webster Electric Co., 1900 Clark St., Racine, Wis.

PILOT LIGHT ASSEMBLIES

- Ⓞ AEROLITE ELECTRONIC HARDWARE CORP., 507 26th St., Union City, N. Y. ADV. PG. 355.
- Ⓞ ALDEN PRODUCTS CO., 117 N. Main St., Brockton 64, Mass. ADV. PG. 327.
- Ⓞ AMERICAN ELECTRONICS CORP., 157 Marconi Blvd., Columbus, Ohio. ADV. PG. 418.
- Ⓞ Drake Mfg. Co., 1713 Hubbard St., Chicago 22, Ill.
- Ⓞ Edwards Co., Inc., 86 Boston Post Rd., Norwalk, Conn.
- Ⓞ FEDERAL SCREW PRODUCTS INC., 224 W. Huron St., Chicago 10, Ill. ADV. PG. 76.
- Ⓞ FRANKLIN AIRLOOP CORP., 43-20 34th St., Long Island City, N. Y. ADV. PG. 45.
- Ⓞ FRANKLIN MFG. CORP., A. W., 43-20 34th St., Long Island City 1, N. Y. ADV. PG. 44.
- Ⓞ GENERAL ACCESSORIES CO., LTD., 366 Madison Ave., New York 17, N. Y. ADV. PG. 336.
- Ⓞ GENERAL ELECTRIC CO., Schenectady 5, N. Y. ADV. PG. 1 to 22.
- Ⓞ Industrial Devices, Inc., 22 State Rd., Edgewater, N. J.
- Ⓞ JOHNSON CO., E. F., Waseca, Minn. ADV. PG. 118, 121.
- Ⓞ Kirkland Co., H. R., 8 King St., Morristown, N. J.
- Ⓞ Marco Industries Co., 210 S. Clementine, Anaheim, Calif.
- Micarta Fabrications, Inc., 5324 Ravenswood Ave., Chicago 40, Ill.
- Ⓞ National Tel-Tronics Corp., 35 St. Casparys Ave., Yonkers, N. Y.
- Ⓞ Pass & Seymour, Inc., Solvay Station, Syracuse, N. Y.
- Ⓞ Philco Corp., Tioga & C Sts., Philadelphia 34, Pa.
- Ⓞ RUSSELL & STOLL CO., INC., 125 Barclay St., New York 7, N. Y. ADV. PG. 337.
- Ⓞ Smith, Inc., Herman H., 436 18th St., Brooklyn 15, N. Y.
- Ⓞ Ucinite Co., Division, United-Carr Fastener Corp., 459 Watertown St., Newtonville, Mass.
- Ⓞ United-Carr Fastener Corp., Cambridge 42, Mass.
- Vokar Corp., 7300 Huron River Drive., Dexter, Mich.

V indicates . . . IN PRODUCTION • AVAILABILITY • UNRESTRICTED FOR GENERAL USE

PILOTS—Automatic

- Ⓢ ECLIPSE-PIONEER DIV., Bendix Aviation Corp., Teterboro, N. J. ADV. PG. 198, 199.
- Ⓢ GENERAL ELECTRIC CO., Schenectady 5, N. Y. ADV. PG. 1 to 22.
- Ⓢ Lear, Inc., 110 Ionia Ave., N. W., Grand Rapids 2, Mich.
- Ⓢ Minneapolis-Honeywell Regulator Co., 2753 Fourth Ave., S., Minneapolis, Minn.
- Ⓢ SPERRY GYROSCOPE CO., Div. of The Sperry Corp., Great Neck, N. Y. ADV. PG. 103, 104.

PITCH

See Insulating Compounds

PIVOTS—Instrumental Jewel

- Electrovox Co., Inc., 60 Franklin St., East Orange, N. J.
- Ⓢ Miller Mfg. Co., M. A., 1169 E. 43rd St., Chicago 15, Ill.
- Ⓢ Permo, Inc., 6415 Ravenswood Ave., Chicago 26, Ill.
- Ⓢ Steel Co., Herman D., Lafayette Bldg., Philadelphia 6, Pa.
- Ⓢ Swiss Jewel Co., Lafayette Bldg., Philadelphia 6, Pa.
- Ⓢ Vallorbs Jewel Co., Lancaster, Pa.

PLASTIC EMBEDDED ASSEMBLIES

- Ⓢ EMERSON & CUMING CO., 126 Massachusetts Ave., Boston 15, Mass. ADV. PG. 389.
- Ⓢ Melpar, Inc., 552 Swann Ave., Alexandria, Va.

PLASTIC EMBEDDED COMPONENTS

- Ⓢ EMERSON & CUMING CO., 126 Massachusetts Ave., Boston 15, Mass. ADV. PG. 389.

PLASTIC MATERIALS

Allyls

- Ⓢ American Cyanamid Co., 38 Rockefeller Plaza, New York 20, N. Y.

Cellulose Acetate

- Ⓢ Celanese Corp. of America, 180 Madison Ave., New York 16, N. Y.
- Ⓢ du Pont de Nemours & Co., Inc., E. I., Wilmington, Delaware.
- Ⓢ Eastman Kodak Co., Industrial Photographic Div., 343 State St., Rochester 4, N. Y.
- Ⓢ Hercules Powder Co., Inc., 900 Market St., Wilmington 99, Del.
- Ⓢ Monsanto Chemical Co., Plastics Div., Springfield 2, Mass.
- Ⓢ Polymer Corp., The Reading, Pa.
- Ⓢ Spaulding Fibre Co., Inc., 310 Wheeler St., Tonawanda, N. Y.
- Ⓢ Tennessee Eastman Co., Kingsport, Tenn.

Cellulose Acetate Butyrate

- Ⓢ Eastman Kodak Co., Industrial Photographic Div., 343 State St., Rochester 4, N. Y.
- Ⓢ Polymer Corp., The Reading, Pa.
- Ⓢ Tennessee Eastman Co., Kingsport, Tenn.

Cellulose Nitrate

- Ⓢ du Pont de Nemours & Co., Inc., E. I., Wilmington, Del.
- Ⓢ Hercules Powder Co., Inc., 900 Market St., Wilmington 99, Delaware.
- Ⓢ Monsanto Chemical Co., Plastics Div., Springfield 2, Mass.

Ethyl Cellulose

- Ⓢ Dow Chemical Co., Midland, Mich.
- Ⓢ Hercules Powder Co., Inc., 900 Market St., Wilmington 99, Del.
- Ⓢ Polymer Corp., The Reading, Pa.

Melamine Formaldehyde

- Ⓢ American Cyanamid Co., 38 Rockefeller Plaza, New York 20, N. Y.
- Ⓢ Baer Co., N. S., 9 Montgomery St., Hillside, N. J.
- Ⓢ Monsanto Chemical Co., Plastics Div., Springfield 2, Mass.
- Ⓢ NATIONAL VULCANIZED FIBRE CO., Wilmington, Del. ADV. PG. 251.
- Ⓢ Panelyte Div., St. Regis Paper Co., 230 Park Ave., New York, N. Y.
- Ⓢ Plaskon Division, Libbey-Owens-Ford Glass Co., 2112-24 Sylvan Ave., Toledo 6, Ohio.

- Ⓢ Spaulding Fibre Co., Inc., 310 Wheeler St., Tonawanda, N. Y.
- Ⓢ Synthane Corp., Oaks, Pa.
- Ⓢ Taylor Fibre Co., Norristown, Pa.
- Ⓢ WESTINGHOUSE ELECTRIC CORP., 511 Wood St., P. O. Box 868, Pittsburgh 30, Pa. ADV. PG. 107-113.

Methyl Methacrylate

- Ⓢ du Pont de Nemours & Co., Inc., E. I., Wilmington, Delaware.
- Ⓢ Plax Corp., P. O. Box 1019, Hartford, Conn.
- Ⓢ Rohm & Haas Co., Washington Square, Philadelphia 5, Pa.

Phenol Formaldehyde—(Phenolics)

- Ⓢ Baer Co., N. S., 9 Montgomery St., Hillside, N. J.
- Ⓢ Bakelite Co., A Div. of Union Carbide & Carbon Corp., 30 E. 42nd St., New York 17, N. Y.
- Ⓢ Borden Co., The, Chemical Div., 350 Madison Ave., New York 17, N. Y.
- Ⓢ Catalin Corp. of America, 1 Park Ave., New York 16, N. Y.
- Ⓢ Durez Plastics & Chemicals, Inc., 1921 Walck Rd., N. Tonawanda, N. Y.
- Ⓢ Electro Chemical Engineering Co., 750 Broad St., Emmaus, Pa.
- Ⓢ GENERAL ELECTRIC CO., Chemical Dept., Pittsfield, Mass. ADV. PG. 1 to 22.
- Ⓢ Monsanto Chemical Co., Plastics Div., Springfield 2, Mass.
- Ⓢ NATIONAL VULCANIZED FIBRE CO., Wilmington, Del. ADV. PG. 251.
- Ⓢ Panelyte Div., St. Regis Paper Co., 230 Park Ave., New York, N. Y.
- Ⓢ Reichhold Chemicals, Inc., 601-707 Woodward Heights Blvd., Detroit 20, Mich.
- Ⓢ Reilly Tar & Chemical Corp., 1615 Merchants Bank Bldg., 11 S. Meridian St., Indianapolis 4, Ind.
- Ⓢ Rogers Corp., Manchester, Conn.
- Ⓢ Spaulding Fibre Co., Inc., 310 Wheeler St., Tonawanda, N. Y.
- Ⓢ Synthane Corp., Oaks, Pa.
- Ⓢ Synvar Corp., 415 E. Front St., Wilmington, Del.
- Ⓢ Taylor Fibre Co., Norristown, Pa.
- Ⓢ WESTINGHOUSE ELECTRIC CORP., 511 Wood St., P. O. Box 868, Pittsburgh 30, Pa. ADV. PG. 107-113.

Polyethylene

- Ⓢ Bakelite Co., A Div. of Union Carbide & Carbon Corp., 30 E. 42nd St., New York 17, N. Y.
- Ⓢ IRVINGTON VARNISH & INSULATOR CO., 6 Argyle Terrace, Irvington 11, N. J. ADV. PG. 92, 93.
- Ⓢ Plax Corp., P. O. Box 1019, Hartford, Conn.
- Ⓢ Polymer Corp., The, Reading, Pa.

Polystyrene

- Ⓢ Bakelite Co., A Div. of Union Carbide & Carbon Corp., 30 E. 42nd St., New York 17, N. Y.
- Ⓢ Catalin Corp. of America, 1 Park Ave., New York 16, N. Y.
- Ⓢ Dow Chemical Co., Midland, Mich.
- Ⓢ du Pont de Nemours & Co., Inc., E. I., Wilmington 98, Delaware.
- Ⓢ Koppers Co., Inc., Chemical Div., Koppers Bldg., Pittsburgh 19, Pa.
- Ⓢ Monsanto Chemical Co., Plastics Div., Springfield 2, Mass.
- Ⓢ Panelyte Div., St. Regis Sales Corp., 230 Park Ave., New York 17, N. Y.
- Ⓢ Plax Corp., P. O. Box 1019, Hartford, Conn.
- Ⓢ United States Rubber Co., 1230 Avenue of the Americas, New York 20, N. Y.

Polytetrafluoroethylene

- Ⓢ du Pont de Nemours & Co., Inc., E. I., Wilmington, Delaware.
- Ⓢ ELECTRONIC MECHANICS, INC., 70 Clifton Blvd., Clifton, N. J. ADV. PG. 309.
- Ⓢ TEFLON PRODUCTS DIVISION, U. S. GASKET CO., P. O. Box 93, Camden, N. J. ADV. PG. 176.

Polytrifluoroethylene

- Ⓢ ELECTRONIC MECHANICS, INC., 70 Clifton Blvd., Clifton, N. J. ADV. PG. 309.
- Ⓢ Plax Corp., P. O. Box 1019, Hartford 5, Conn.
- Ⓢ TEFLON PRODUCTS DIVISION, U. S. GASKET CO., P. O. Box 93, Camden, N. J. ADV. PG. 176.

Resins

- Ⓢ Bakelite Co., A Div. of Union Carbide & Carbon Corp., 30 E. 42nd St., New York 17, N. Y.
- Ⓢ Borden Co., The, Chemical Div., 350 Madison Ave., New York 17, N. Y.

- Ⓢ Catalin Corp. of America, 1 Park Ave., New York 16, N. Y.
- Ⓢ CIBA COMPANY, INC., 627 Greenwich St., New York 14, N. Y. ADV. PG. 276.
- Ⓢ Dow Chemical Co., Midland, Mich.
- Ⓢ Electro Chemical Engineering Co., 750 Broad St., Emmaus, Pa.
- Ⓢ Goodrich Chemical Co., B. F., Rose Bldg., Cleveland 15, Ohio.
- Ⓢ Goodyear Tire & Rubber Co., Inc., Chemical Div., 1144 E. Market St., Akron 16, Ohio.
- Ⓢ Halowax Products Division, Union Carbide & Carbon Corp., 30 E. 42nd St., New York 17, N. Y.
- Ⓢ Hercules Powder Co., Inc., 900 Market St., Wilmington 99, Del.
- Ⓢ IRVINGTON VARNISH & INSULATOR CO., 6 Argyle Terrace, Irvington 11, N. J. ADV. PG. 92, 93.
- Ⓢ Marbon Corp., Gary, Ind.
- Ⓢ Monsanto Chemical Co., Plastics Div., Springfield 2, Mass.
- Ⓢ Plaskon Division, Libbey-Owens-Ford Glass Co., 2112-24 Sylvan Ave., Toledo 6, Ohio.
- Ⓢ Reichhold Chemicals, Inc., 601-707 Woodward Heights Blvd., Detroit 20, Mich.
- Ⓢ Synvar Corp., 415 E. Front St., Wilmington, Del.
- Ⓢ United States Rubber Co., 1230 Avenue of the Americas, New York 20, N. Y.

Urea Formaldehyde

- Ⓢ American Cyanamid Co., 38 Rockefeller Plaza, New York 20, N. Y.
- Ⓢ Bakelite Co., A Div. of Union Carbide & Carbon Corp., 30 E. 42nd St., New York 17, N. Y.
- Ⓢ Borden Co., The, Chemical Div., 350 Madison Ave., New York 17, N. Y.
- Ⓢ Monsanto Chemical Co., Plastics Div., Springfield, Mass.
- Ⓢ Plaskon Division, Libbey-Owens-Ford Glass Co., 2112-24 Sylvan Ave., Toledo 6, Ohio.
- Ⓢ Reichhold Chemicals, Inc., 601-707 Woodward Heights Blvd., Detroit 20, Mich.

Vinyl Compounds

- Ⓢ Bakelite Co., A Div. of Union Carbide & Carbon Corp., 30 E. 42nd St., New York 17, N. Y.
- Ⓢ Borden Co., The, Chemical Div., 350 Madison Ave., New York 17, N. Y.
- Ⓢ Electro Chemical Engineering Co., 750 Broad St., Emmaus, Pa.
- Ⓢ Goodrich Chemical Co., B. F., Rose Bldg., Cleveland 15, Ohio.
- Ⓢ Industrial Synthetics Corp., 225 North Ave., Garwood, N. J.
- Ⓢ Marbon Corp., Gary, Indiana.
- Ⓢ Monsanto Chemical Co., Plastics Div., Springfield 2, Mass.
- Ⓢ United States Rubber Co., 1230 Avenue of the Americas, New York 20, N. Y.
- Ⓢ U. S. Stoneware Co., The, Akron 9, Ohio.

PLATES—Instruction

- Ⓢ Acromark Co., The, 442 Morrell St., Elizabeth 4, N. J.
- Ⓢ Art Roll Leaf Stamping Co., 3610 Palisade Ave., Union City, N. J.
- Ⓢ Cortland Industries, Inc., 4545 Cortland St., Chicago 39, Ill.
- Ⓢ Croname, Inc., 3701 Ravenswood Ave., Chicago, Ill.
- Ⓢ EMELOID CO., INC., THE, 1239 Central Ave., Hillside 5, N. J. ADV. PG. 102.
- Ⓢ Etched Products Corp., 39-01 Queens Blvd., Long Island City, N. Y.
- Ⓢ Insulating Fabricators, Inc., 150 Union Ave., East Rutherford, N. J.
- Ⓢ Insulating Fabricators of New England, Inc., 69 Grove St., Watertown 72, Mass.
- Ⓢ Mica Insulator Co., Schenectady 1, N. Y.
- Ⓢ Plastic Accessories, Inc., 93 Mercer St., New York 12, N. Y.
- Ⓢ Plastic Fabricators Co., 440 Sansome Street, San Francisco 11, Calif.
- Ⓢ Ports Mfg. Co., 3265 E. Belmont Ave., Fresno 2, Calif.
- Ⓢ Premier Metal Etching Co., 21-03 44th Ave., Long Island City, N. Y.
- Ⓢ Printloid, Inc., 95 Mercer St., New York 12, N. Y.
- Ⓢ Topflight Tape Co., 116 E. Market St., York, Pa.
- Ⓢ U. S. Radium Corp., 535 Pearl St., New York 7, N. Y.

PLATES—Name

- Ⓢ Acromark Co., The, 442 Morrell St., Elizabeth 4, N. J.
- Ⓢ American Laubscher Corp., 333 W. 52nd St., New York 19, N. Y.
- Ⓢ Art Roll Leaf Stamping Co., 3610 Palisade Ave., Union City, N. J.
- Ⓢ Audio Equipment Sales, 153 W 33rd St., New York 1, N. Y.
- Ⓢ Cortland Industries, Inc., 4545 Cortland St., Chicago 39, Ill.
- Ⓢ Croname, Inc., 3701 Ravenswood Ave., Chicago, Ill.

Ⓥ indicates . . . IN PRODUCTION • AVAILABILITY • UNRESTRICTED FOR GENERAL USE

- Ⓥ Eagle Electric Mfg. Co., Inc., 23-10 Bridge Plaza, S., Long Island City, N. Y.
- Elm Laboratories, 18 South Broadway, Dobbs Ferry, N. Y.
- Ⓥ EMELOID CO., INC., THE, 1239 Central Ave., Hillside 5, N. J. ADV. PG. 102.
- Ⓥ ERIE RESISTOR CORP., 644 W. 12th St., Erie, Pa. ADV. PG. 91.
- Ⓥ Etched Products Corp., 39-01 Queens Blvd., Long Island City, N. Y.
- Ⓥ FRANKLIN AIRLOOP CORP., 43-20 34th St., Long Island City, N. Y. ADV. PG. 45.
- Ⓥ FRANKLIN MFG. CORP., A. W., 43-20 34th St., Long Island City 1, N. Y. ADV. PG. 44.
- Ⓥ Gits Molding Corp., 4600 W. Huron St., Chicago 44, Ill.
- Insulating Fabricators, Inc., 150 Union Ave., East Rutherford, N. J.
- Ⓥ Insulating Fabricators of New England, Inc., 69 Grove St., Watertown 72, Mass.
- Ⓥ Matthews & Co., J. H., 470 Atlantic Ave., Boston 10, Mass.
- Ⓥ Mica Insulator Co., Schenectady 1, N. Y.
- Ⓥ NEW HERMES, INC., 13-19 University Place, New York 3, N. Y. ADV. PG. 411.
- Ⓥ Panelyte Div., St. Regis Paper Co., 230 Park Ave., New York, N. Y.
- Ⓥ Parisian Novelty Co., 3510 S. Western Ave., Chicago 9, Ill.
- Plastic Accessories, Inc., 93 Mercer St., New York 12, N. Y.
- Plastic Fabricators Co., 440 Sansome Street, San Francisco 11, Calif.
- Ⓥ Plasticraft Products Co., 20 Hudson St., New York 13, N. Y.
- Ⓥ Ports Mfg. Co., 3265 E. Belmont Ave., Fresno 2, Calif.
- Ⓥ Premier Metal Etching Co., 21-03 44th Ave., Long Island City, N. Y.
- Printloid Inc., 95 Mercer St., New York, N. Y.
- Ⓥ Radiocrafters, 1156 Commonwealth Ave., Boston 34, Mass.
- Ⓥ Sillocks-Miller Co., 10 Parker Ave., W., So. Orange, N. J.
- Ⓥ Topflight Tape Co., 116 E. Market St., York, Pa.
- Ⓥ U. S. Radium Corp., 535 Pearl St., New York 7, N. Y.

PLATING—Metal on Plastic

- Ⓥ BART LABS., CO., INC., 227 Main St., Belleville 9, N. J. ADV. PG. 148.
- Ⓥ Bart-Messing Corp., 227 Main St., Belleville 9, N. J.
- Ⓥ ELECTRO TEC CORP., South Hackensack, N. J. ADV. PG. 399.
- Ⓥ Electrochemical Industries, Inc., Jacques St., Worcester, Mass.
- Ⓥ EMELOID CO., INC., THE, 1239 Central Ave., Hillside 5, N. J. ADV. PG. 102.
- Ⓥ Gits Molding Corp., 4600 W. Huron St., Chicago 44, Ill.
- Ⓥ Metaplast Process, Inc., 9-17 37th Ave., Long Island City 1, N. Y.
- Ⓥ Molded Insulation Co., 335 E. Price St., Philadelphia 44, Pa.
- Ⓥ National Research Corp., 70 Memorial Dr., Cambridge 42, Mass.
- Ⓥ Poinsettia Co., Inc., 95 Cedar Ave., Pitman, N. J.
- Ⓥ Sears Co., M. J., 52 Clark St., Brooklyn 2, N. Y.

PLATING—Precision Metal

- Ⓥ BART LABS., CO., INC., 227 Main St., Belleville 9, N. J. ADV. PG. 148.
- Ⓥ Bart-Messing Corp., 227 Main St., Belleville 9, N. J.
- Ⓥ COHAN-EPNER CO., INC., 142 W. 14th St., New York 11, N. Y. ADV. PG. 406.
- Ⓥ Cossor (Canada) Ltd., 301-303 Windsor St., Halifax, N. S., Canada.
- Ⓥ ELECTRO-TEC CORP., South Hackensack, N. J. ADV. PG. 399.
- Ⓥ Electrochemical Industries, Inc., Jacques St., Worcester, Mass.
- Ⓥ Goldsmith Bros., Smelting & Refining Co., 111 N. Wabash Ave., Chicago 2, Ill.
- Ⓥ Handy & Harman, 82 Fulton St., New York 38, N. Y.
- Ⓥ Sears Co., M. J., 52 Clark St., Brooklyn 2, N. Y.
- Ⓥ Standard Metals Corp., 262 Broad St., North Attleboro, Mass.
- Ⓥ WARD LEONARD ELECTRIC CO., 31 South St., Mt. Vernon, N. Y. ADV. PG. 69, 70.

PLUGS—Terminal

- Ⓥ AEROLITE ELECTRONIC HARDWARE CORP., 507 26th St., Union City, N. J. ADV. PG. 355.
- Ⓥ BEAD CHAIN MFG. CO., 110 Mountain Grove St., Bridgeport 5, Conn. ADV. PG. 136.
- Ⓥ BELLING & LEE LTD., 366 Madison Ave., New York 17, N. Y. ADV. PG. 336.
- Ⓥ Birnbach Radio Co., Inc., 145 Hudson St., New York, N. Y.
- Ⓥ Burndy Engineering Co., Inc., 107 Bruckner Blvd., New York 54, N. Y.
- Ⓥ CINCH MFG. CORP., 1026 S. Homan Ave., Chicago 24, Ill. ADV. PG. 186, 187.

- Ⓥ CITATION PRODUCTS CO., 233 E. 146th St., New York 51, N. Y. ADV. PG. 388.
- Ⓥ EBV, INC., HUGH H., 4700 Stenton Ave., Philadelphia 44, Pa. ADV. PG. 214.
- Ⓥ Elco Corp., 190 W. Glenwood Ave., Philadelphia 40, Pa.
- FRANKLIN AIRLOOP CORP., 43-20 34th St., Long Island City, N. Y. ADV. PG. 45.
- Ⓥ FRANKLIN MFG. CORP., A. W., 43-20 34th St., Long Island City, N. Y. ADV. PG. 44.
- Ⓥ GENERAL ACCESSORIES CO., LTD., 366 Madison Ave., New York 17, N. Y. ADV. PG. 336.
- Ⓥ HERMETIC SEAL PRODUCTS CO., 29-37 S. 6th St., Newark 7, N. J. ADV. PG. 175.
- Ⓥ Hubbell, Inc., Harvey, Bridgeport 2, Conn.
- Ⓥ Insuline Corp. of America, 36-02 35th Ave., Long Island City, N. Y.
- Ⓥ JOHNSON CO., E. F., Waseca, Minn. ADV. PG. 118, 121.
- Ⓥ Keystone Electronics Corp., 423 Broome St., New York 12, N. Y.
- Ⓥ KINGS ELECTRONICS, 40 Marbledale Road, Tuckahoe, N. Y. ADV. PG. 180, 181.
- Ⓥ Millen Mfg. Co., James, 150 Exchange St., Malden, Mass.
- Ⓥ NATIONAL CO., INC., 61 Sherman St., Malden 48, Mass. ADV. PG. 280, 281.
- Ⓥ National Tel-Tronics Corp., 35 St. Casmirs Ave., Yonkers, N. Y.
- Ⓥ Pacific Electricord Co., 3217 Exposition Place, Los Angeles 18, Calif.
- Ⓥ PAINTON & CO., LTD., Madison Ave., New York 17, N. Y. ADV. PG. 336.
- Ⓥ Philco Corp., Tioga & C Sts., Philadelphia 34, Pa.
- Ⓥ Plastic Wire & Cable Corp., Jewett City, Conn.
- Ⓥ RUSSELL & STOLL CO., INC., 125 Barclay St., New York 7, N. Y. ADV. PG. 337.
- Ⓥ Smith, Inc., Herman H., 436 18th St., Brooklyn 15, N. Y.
- Ⓥ States Co., 19 New Park Ave., Hartford 6, Conn.
- Ⓥ Ucinite Co. Division, United-Carr Fastener Corp., 459 Watertown St., Newtonville, Mass.
- Ⓥ VECTOR ELECTRONIC CO., 1101 Riverside Drive, Los Angeles 31, Calif. ADV. PG. 283.
- Ⓥ WALTHAM HOROLOGICAL CORP., Waltham, Mass. ADV. PG. 409.

PLUGS AND JACKS

- Ⓥ AEROLITE ELECTRONIC HARDWARE CORP., 507 26th St., Union City, N. J. ADV. PG. 355.
- Ⓥ ALDEN PRODUCTS CO., 117 No. Main St., Brockton 64, Mass. ADV. PG. 327.
- Ⓥ AMERICAN PHENOLIC CORP., 1830 S. 54th Ave., Chicago 50, Ill. ADV. PG. 61.
- Ⓥ Audio Development Co., 2833 13th Ave., Minneapolis 7, Minn.
- Ⓥ Audio Equipment Sales, 153 W. 33rd St., New York 1, N. Y.
- Ⓥ Automatic Electric Sales Corp., 1033 W. Van Buren St., Chicago 7, Ill.
- Ⓥ BEAD CHAIN MFG. CO., 110 Mountain Grove St., Bridgeport 5, Conn. ADV. PG. 136.
- Ⓥ BELLING & LEE LTD., 366 Madison Ave., New York 17, N. Y. ADV. PG. 336.
- Ⓥ Birnbach Radio Co., Inc., 145 Hudson St., New York, N. Y.
- Ⓥ Breloco Electronics Corp., 55 Vandam St., New York 13, N. Y.
- Ⓥ Bud Radio Inc., 2118 E. 55th St., Cleveland 3, Ohio.
- Ⓥ Cannon Electric Development Co., 3209 Humboldt St., Los Angeles 31, Calif.
- Ⓥ Carter Parts Co., 213 Institute Pl., Chicago 10, Ill.
- Ⓥ CINCH MFG. CORP., 1026 S. Homan Ave., Chicago 24, Ill. ADV. PG. 186, 187.
- Ⓥ CINEMA ENGINEERING CO., 1510 W. Verdugo Ave., Burbank, Calif. ADV. PG. 204.
- Ⓥ CITATION PRODUCTS CO., 233 E. 146th St., New York 51, N. Y. ADV. PG. 388.
- Ⓥ Connecticut Telephone & Electric Corp., 70 Britannia St., Meriden, Conn.
- Ⓥ EBV, INC., HUGH H., 4700 Stenton Ave., Philadelphia 44, Pa. ADV. PG. 214.
- Ⓥ Elco Corp., 190 W. Glenwood Ave., Philadelphia 40, Pa.
- Ⓥ FEDERAL SCREW PRODUCTS, INC., 224 W. Huron St., Chicago 10, Ill. ADV. PG. 76.
- Ⓥ FRANKLIN AIRLOOP CORP., 43-20 34th St., Long Island City, N. Y. ADV. PG. 45.
- Ⓥ FRANKLIN MFG. CORP., A. W., 43-20 34th St., Long Island City 1, N. Y. ADV. PG. 44.
- Ⓥ GENERAL ACCESSORIES CO., LTD., 366 Madison Ave., New York 17, N. Y. ADV. PG. 336.
- Ⓥ General Cement Mfg. Co., 919 Taylor Ave., Rockford, Ill.
- Ⓥ GENERAL RADIO CO., 275 Massachusetts Ave., Cambridge 39, Mass. ADV. PG. 48, 49.
- Ⓥ Gombos Co., Inc., John, 103 Montgomery St., Irvington 11, N. J.
- Ⓥ HEINZE ELECTRIC CO., 685 Lawrence St., Lowell, Mass. ADV. PG. 314.
- Ⓥ Hubbell, Inc., Harvey, Bridgeport 2, Conn.
- Ⓥ Insuline Corp. of America, 36-02 35th Ave., Long Island City, N. Y.
- Ⓥ JOHNSON CO., E. F., Waseca, Minn. ADV. PG. 118, 121.

- Ⓥ JONES DIV., HOWARD B., Cinch Mfg. Corp., 1026 S. Homan Ave., Chicago 24, Ill. ADV. PG. 186, 187.
- Ⓥ KELLOGG SWITCHBOARD & SUPPLY CO., 6650 S. Cicero Ave., Chicago 38, Ill. ADV. PG. 294.
- Ⓥ Keystone Electronics Corp., 423 Broome St., New York 12, N. Y.
- Ⓥ KINGS ELECTRONICS, 40 Marbledale Road, Tuckahoe, N. Y. ADV. PG. 180, 181.
- Ⓥ Mallory & Co., Inc., P. R., 3029 E. Washington St., Indianapolis 6, Ind.
- Ⓥ METHODE MFG. CORP., 2265 W. St. Paul Ave., Chicago 47, Ill. ADV. PG. 347.
- Ⓥ Millen Mfg. Co., James, 150 Exchange St., Malden, Mass.
- Ⓥ Molded Insulation Co., 335 E. Price St., Philadelphia 44, Pa.
- Ⓥ Morse Co., Frank W., 1300 Soldiers Field Rd., Boston 35, Mass.
- Ⓥ NATIONAL CO., INC., 61 Sherman St., Malden 48, Mass. ADV. PG. 280, 281.
- Ⓥ National Tel-Tronics Corp., 35 St. Casmirs Ave., Yonkers, N. Y.
- Ⓥ NEO-SHLE CORP., 26 Cornelison Ave., Jersey City 4, N. J. ADV. PG. 253.
- Ⓥ Pacific Electricord Co., 3217 Exposition Place, Los Angeles 18, Calif.
- Ⓥ PAINTON & CO., LTD., 366 Madison Ave., New York 17, N. Y. ADV. PG. 336.
- Ⓥ Philco Corp., Tioga & C Sts., Philadelphia 34, Pa.
- Ⓥ Plastimold Corp., Attleboro, Mass.
- Ⓥ RADIO CORP. OF AMERICA, RCA Victor Div., General Offices, Camden, N. J. ADV. PG. 177, Inside Back and Back Covers.
- Ⓥ Remler Co., Ltd., 2101 Bryant St., San Francisco 10, Calif.
- Ⓥ Schott Co., Walter L., 3225 Exposition Pl., Los Angeles 18, Calif.
- Ⓥ Selectar Industries, Inc., 401 E. 138th St., New York 54, N. Y.
- Ⓥ Smith, Inc., Herman H., 436 18th St., Brooklyn 15, N. Y.
- Ⓥ States Co., 19 New Park Ave., Hartford 6, Conn.
- Ⓥ SWITCHCRAFT, INC., 1328-30 N. Halsted St., Chicago 22, Ill. ADV. PG. 354.
- Ⓥ Telephonics Corp., Park Ave., Huntington, N. Y.
- Ⓥ Trimm, Inc., 400 W. Lake St., Libertyville, Ill.
- Ⓥ Ucinite Co. Division, United-Carr Fastener Corp., 459 Watertown St., Newtonville, Mass.
- Ⓥ WALTHAM HOROLOGICAL CORP., Waltham, Mass. ADV. PG. 409.
- Ⓥ WINCHESTER ELECTRONICS, INCORPORATED, Greenbrook, Conn. ADV. PG. 201.

POINTERS—Dial

- Ⓥ Baldwin-Lima-Hamilton Corp., Paschall P. O. Station, Philadelphia 42, Pa.
- Ⓥ ERIE RESISTOR CORP., 644 W. 12th St., Erie, Pa. ADV. PG. 91.
- Ⓥ Felsenthal & Sons, Inc., G., 4100 W. Grand Ave., Chicago 51, Ill.
- Ⓥ Gemloid Corp., 79-10 Albion Ave., Elmhurst, N. Y.
- Ⓥ General Cement Mfg. Co., 919 Taylor Ave., Rockford, Ill.
- Ⓥ Insuline Corp. of America, 36-02 35th Ave., Long Island City, N. Y.
- Ⓥ NATIONAL CO., INC., 61 Sherman St., Malden 48, Mass. ADV. PG. 280, 281.
- Ⓥ PAINTON & CO., LTD., 366 Madison Ave., New York 17, N. Y. ADV. PG. 336.
- Ⓥ Parisian Novelty Co., 3510 South Western Ave., Chicago 9, Ill.
- Ⓥ Philco Corp., Tioga & C Sts., Philadelphia 34, Pa.
- Ⓥ Plastimold Corp., Attleboro, Mass.
- Ⓥ REEVES INSTRUMENT CORP., 215 E. 91st St., New York, N. Y. ADV. PG. 315.
- Ⓥ SHALLCROSS MFG. CO., 10 Jackson Ave., Collingdale, Pa. ADV. PG. 261.
- Ⓥ Smith, Inc., Herman H., 436 18th St., Brooklyn 15, N. Y.
- Ⓥ Ucinite Co. Division, United-Carr Fastener Corp., 459 Watertown St., Newtonville, Mass.
- Ⓥ Uniform Tubes, Shurs Lane & Larviston St., Roxborough, Philadelphia, Pa.
- Ⓥ United-Carr Fastener Corp., Cambridge 42, Mass.
- Ⓥ U. S. Radium Corp., 535 Pearl St., New York 7, N. Y.

POSTS—Binding

- Ⓥ AEROLITE ELECTRONIC HARDWARE CORP., 507 26th St., Union City, N. J. ADV. PG. 355.
- Ⓥ ALDEN PRODUCTS CO., 117 N. Main St., Brockton 64, Mass. ADV. PG. 327.
- Ⓥ BEAD CHAIN MFG. CO., 110 Mountain Grove St., Bridgeport 5, Conn. ADV. PG. 136.
- Ⓥ BELLING & LEE LTD., 366 Madison Ave., New York 17, N. Y. ADV. PG. 336.
- Ⓥ Berkshire Laboratories, 580 Lexington Rd., Concord, Mass.
- Ⓥ CAMBRIDGE THERMIONIC CORP., 445 Concord Ave., Cambridge 38, Mass. ADV. PG. 37.
- Ⓥ CINCH MFG. CORP., 1026 S. Homan Ave., Chicago 24, Ill. ADV. PG. 186, 187.
- Ⓥ CITATION PRODUCTS CO., 233 E. 146th St., New York 51, N. Y. ADV. PG. 388.
- Ⓥ Eastern Specialty Co., Philadelphia 40, Pa.

V indicates . . . IN PRODUCTION • AVAILABILITY • UNRESTRICTED FOR GENERAL USE

- EBY, INC., HUGH H., 4700 Stenton Ave., Philadelphia 44, Pa. ADV. PG. 214.
- FEDERAL SCREW PRODUCTS INC., 224 W. Huron St., Chicago 10, Ill. ADV. PG. 76.
- GENERAL ACCESSORIES CO., LTD., 366 Madison Ave., New York 17, N. Y. ADV. PG. 336.
- GENERAL RADIO CO., 275 Massachusetts Ave., Cambridge 39, Mass. ADV. PG. 48, 49.
- Insulation Mfg. Co., 11 New York Ave., Brooklyn, N. Y.
- Insuline Corp. of America, 36-02 35th Ave., Long Island City, N. Y.
- MALCO TOOL & MFG. CO., 4025 W. Lake St., Chicago 24, Ill. ADV. PG. 385.
- Millen Mfg. Co., James, 150 Exchange St., Malden, Mass.
- Molded Insulation Co., 335 E. Price St., Philadelphia 44, Pa.
- NATIONAL CO., INC., 61 Sherman St., Malden 48, Mass. ADV. PG. 280, 281.
- PAINTON & CO., LTD., 366 Madison Ave., New York 17, N. Y. ADV. PG. 336.
- Philco Corp., Tioga & C Sts., Philadelphia 34, Pa.
- Smith, Inc., Herman H., 436 18th St., Brooklyn 15, N. Y.
- States Co., 19 New Park Ave., Hartford 6, Conn.
- SUPERIOR ELECTRIC CO., THE, 4000 Church St., Bristol, Conn. ADV. PG. 190, 191.
- THOR CERAMICS, INC., 225 Belleville Ave., Bloomfield, N. J. ADV. PG. 378.
- U. S. Engineering Co., 521 Commercial St., Glendale 3, Calif.
- WESTINGHOUSE ELECTRIC CORP., 511 Wood St., P. O. Box 868, Pittsburgh 30, Pa. ADV. PG. 107-113.

POTENTIOMETERS

- Allen-Bradley Co., 136 W. Greenfield Ave., Milwaukee 4, Wis.
- BORG EQUIPMENT DIVISION, THE GEORGE W. BORG CORP., Delavan Wis., ADV. PG. 396, 397.
- Brown Electro-Measurement Corp., 4637 S. E. Hawthorne Blvd., Portland 15, Oregon.
- Carter Parts Co., 213 Institute Pl., Chicago 10, Ill.
- CENTRALAB DIV. OF GLOBE-UNION, INC., 900 E. Keefe Ave., Milwaukee 1, Wis. ADV. PG. 85-88.
- CINEMA ENGINEERING CO., 1510 W. Verdugo Ave., Burbank, Calif. ADV. PG. 204.
- CLAROSTAT MFG. CO., INC., Dover, N. H. ADV. PG. 100, 101.
- DAVEN CO., 191 Central Ave., Newark 4, N. J. ADV. PG. 157.
- DEJUR-AMSCO CORP., Northern Blvd. at 45th St., Long Island City 1, N. Y. ADV. PG. 377.
- Foxboro Co., The, Foxboro, Mass.
- GAMEWELL CO., THE, Newton Upper Falls 64, Mass. ADV. PG. 306.
- GENERAL RADIO CO., 275 Massachusetts Ave., Cambridge 39, Mass. ADV. PG. 48, 49.
- Gordon Co., Claud S., 3000 S. Wallace St., Chicago 16, Ill.
- HELIPOT CORP., 916 Meridian Ave., South Pasadena, Calif. ADV. PG. 153.
- INTERNATIONAL RESISTANCE CO., 401 N. Broad St., Philadelphia 8, Pa. ADV. PG. 134, 135.
- Leeds & Northrup Co., 4970 Stenton Ave., Philadelphia 44, Pa.
- Mallory & Co., Inc., P. R. 3029 E. Washington St., Indianapolis 6, Ind.
- Minneapolis-Honeywell Regulator Co., 2753 Fourth Ave., S., Minneapolis, Minn.
- MINNEAPOLIS-HONEYWELL REGULATOR CO., INDUSTRIAL DIV., Wayne & Roberts Aves., Philadelphia 44, Pa. ADV. PG. 208, 209.
- Muirhead & Co., INC., Beckenham-Kent-England.
- OHMITE MFG. CO., 4835 W. Flournoy St., Chicago 44, Ill. ADV. PG. 41.
- PAINTON & CO., LTD., 366 Madison Ave., New York 17, N. Y. ADV. PG. 336.
- Philco Corp., Tioga & C Sts., Philadelphia 34, Pa.
- Precision Electronic Components, Ltd., P. O. Box 264, Granby, Quebec, Canada.
- Rubicon Co., 3761 Ridge Ave., Philadelphia 42, Pa.
- SHALLCROSS MFG. CO., 10 Jackson Ave., Collingdale, Pa. ADV. PG. 261.
- STACKPOLE CARBON CO., St. Marys, Pa. ADV. PG. 170, 171.
- Tech Laboratories, Inc., Bergen & Edsall Blvds., Palisades Park, N. J.
- Trimm, Inc., 400 W. Lake St., Libertyville, Ill.
- Welch Scientific Co., W. M., 1515 Sedgwick St., Chicago 10, Ill.
- WESTON ELECTRICAL INSTRUMENT CORP., 595 Frelinghuysen Ave., Newark 5, N. J. ADV. PG. 243.
- Wheelco Instruments Co., 847 W. Harrison St., Chicago 7, Ill.

POTENTIOMETERS—Induction

- Arma Corp., 254 36th St., Brooklyn, N. Y.
- REEVES INSTRUMENT CORP., 215 E. 91st St., New York, N. Y. ADV. PG. 315.
- WESTON ELECTRICAL INSTRUMENT CORP., 595 Frelinghuysen Ave., Newark 5, N. J. ADV. PG. 243.

POTENTIOMETERS—Linear & Non Linear Precision Wire Wound

- Brown Electro-Measurement Corp., 4637 S. E. Hawthorne Blvd., Portland 15, Ore.
- Carter Parts Co., 213 Institute Pl., Chicago 10, Ill.
- CENTRALAB DIV. OF GLOBE-UNION, INC., 900 E. Keefe Ave., Milwaukee, Wis. ADV. PG. 85-88.
- Chicago Industrial Instrument Co., 536 W. Elm St., Chicago 10, Ill.
- CINEMA ENGINEERING CO., 1510 W. Verdugo Ave., Burbank, Calif. ADV. PG. 204.
- CLAROSTAT MFG. CO., INC., Dover, N. H. ADV. PG. 100, 101.
- DAVEN CO., 191 Central Ave., Newark 4, N. J. ADV. PG. 157.
- DE JUR-AMSCO CORP., Northern Blvd., at 45th St., Long Island City 1, N. Y. ADV. PG. 377.
- Electro-Mec Laboratory 225 Broadway, New York 7, N. Y.
- Electronic Associates, Inc., Long Branch, N. J.
- FAIRCHILD CAMERA & INSTRUMENT CORP., 88-06 Van Wyck Blvd., Jamaica 1, N. Y. ADV. PG. 244, 245.
- Ford Engineering Co. 134 N. Second Ave., Upland, Calif.
- GAMEWELL CO., THE, Newton Upper Falls 64, Mass. ADV. PG. 306.
- GENERAL RADIO CO., 275 Massachusetts Ave., Cambridge 39, Mass. ADV. PG. 48, 49.
- HELIPOT CORP., 916 Meridian Ave., S. Pasadena, Calif. ADV. PG. 153.
- INTERNATIONAL RESISTANCE CO., 401 N. Broad St., Philadelphia 8, Pa. ADV. PG. 134, 135.
- Jarvis Electronics Corp., 6058 W. Fullerton Ave., Chicago 39, Ill.
- Leeds & Northrup Co., 4970 Stenton Ave., Philadelphia 44, Pa.
- Muter Co., 1255 S. Michigan Ave., Chicago, Ill.
- PAINTON & CO., LTD., 366 Madison Ave., New York 17, N. Y. ADV. PG. 336.
- Ratray & Co., Inc., George, 92-32 Union Hall St., Jamaica 5, N. Y.
- Rawson Electrical Instrument Co., 111 Potter St., Cambridge 42, Mass.
- Technology Instrument Corp., 531 Main St., Acton, Mass.

POTENTIOMETERS—Portable Instrument

- Associated Research, Inc., 3758 W. Belmont, Chicago 18, Ill.
- Bristol Co., The, Waterbury 20, Conn.
- CENTRALAB DIV. OF GLOBE-UNION, INC., 900 E. Keefe Ave., Milwaukee 1, Wis. ADV. PG. 85-88.
- DAVEN CO., 191 Central Ave., Newark 4, N. J. ADV. PG. 157.
- Fisher Scientific Co., 717 Forbes St., Pittsburgh 19, Pa.
- Foxboro Co., The, Foxboro, Mass.
- GENERAL ELECTRIC CO., Schenectady 5, N. Y. ADV. PG. 1 to 22.
- Geator Corp., 1820 N. Nash St., Arlington, Va.
- Gordon Co., Claud S., 3000 S. Wallace St., Chicago 16, Ill.
- Leeds & Northrup Co., 4970 Stenton Ave., Philadelphia 44, Pa.
- MITCHELL INDUSTRIES, INC., Camp Wolters, Mineral Wells, Texas. ADV. PG. 298.
- PAINTON & CO., I.T.D., 366 Madison Ave., New York 17, N. Y. ADV. PG. 336.
- Pubicon Co., 3761 Ridge Ave., Philadelphia 42, Pa.
- Sensitive Research Instrument Corp., 9 Elm Ave., Mt. Vernon, N. Y.
- Southwestern Industrial Electronics Co., 2831 Post Oak Rd., P. O. Box 13058, Houston 19, Texas.
- Tech Laboratories, Inc., Bergen & Edsall Blvds, Palisades Park, N. J.
- WESTON ELECTRICAL INSTRUMENT CORP., 595 Frelinghuysen Ave., Newark 5, N. J. ADV. PG. 243.
- Wheelco Instruments Corp., 847 W. Harrison St., Chicago 7, Ill.

POTS—Soldering

- Acme Electric Heating Co., 1217 Washington St., Boston, Mass.
- DEE ELECTRIC CO., 1101 N. Paulina St., Chicago 22, Ill. ADV. PG. 384.
- ELECTRIC SOLDERING IRON CO., W. Elm St., Deep River, Conn. ADV. PG. 68.
- GENERAL ELECTRIC CO., Schenectady 5, N. Y. ADV. PG. 1 to 22.
- Lectrohm, Inc., 5939 Archer Ave., Chicago 38, Ill.
- Tech Laboratories, Inc., Bergen & Edsall Blvds., Palisades Park, N. J.
- VULCAN ELECTRIC CO., 88 Holten St., Danvers, Mass. ADV. PG. 50.
- Waage Electric Inc., 54 Park Place, New York 7, N. Y.
- WESTINGHOUSE ELECTRIC CORP., 511 Wood St., P. O. Box 868, Pittsburgh 30, Pa. ADV. PG. 107-113.

POTS AND TANKS—Heating

- Acme Electric Heating Co., 1217 Washington St., Boston, Mass.
- GENERAL ELECTRIC CO., Schenectady 5, N. Y. ADV. PG. 1 to 22.
- Lukens Steel Co. and Divisions, By-Products Steel Co. & Lukenwald, 447 Lukens Bldg., Coatesville, Pa.
- Sta-Warm Electric Co., Ravenna, Ohio.
- VULCAN ELECTRIC CO., 88 Holten St., Danvers, Mass. ADV. PG. 50.

POWDERS—Magnetic

- ANTARA PRODUCTS DIV., GENERAL DYESTUFF CORP., 435 Hudson St., New York 14, N. Y. ADV. PG. 268.
- Ferroxcube Corp., of America, 50 E. 41st St., New York, N. Y.
- MAGNETIC CORE CORP., 142-144 S. Highland Ave., Ossining, N. Y. ADV. PG. 414.
- Plastic Metals Division, The National Radiator Co., 169 Bridge St., Johnstown, Pa.
- Standard Telephones & Cables Ltd., Connaught House, Aldwych, London, W. C. 2, England.
- Williams & Co., C. K., 2001 Lynch Ave., East St. Louis, Mo.

POWER SUPPLIES

- AIR ASSOCIATES, INC., Teterboro, N. J. ADV. PG. 211.
- AIRPAX PRODUCTS CO., Middle River, Baltimore 20, Md. ADV. PG. 289.
- Altac-Lansing Corp., 9356 Santa Monica Blvd., Beverly Hills, Calif.
- AMERICAN ELECTRONEERING CO., 5025-29 W. Jefferson Blvd., Los Angeles 16, Calif. ADV. PG. 136.
- AMERICAN TELEVISION & RADIO CO., 300 E. Fourth St., St. Paul 1, Minn. ADV. PG. 266.
- Amplifier Corp., of America, 398 Broadway, New York 13, N. Y.
- Approved Electronic Instrument Corp., 142 Liberty St., New York 6, N. Y.
- ATOMIC INSTRUMENT CO., 84 Massachusetts Ave., Cambridge 39, Mass. ADV. PG. 410.
- Audio Equipment Sales, 153 W. 33rd St., New York 1, N. Y.
- BARKER & WILLIAMSON, 235 Fairfield Ave., Upper Darby, Pa. ADV. PG. 292.
- Bassett, Inc., Rex, 307-311 N. W. First Ave., Fort Lauderdale, Fla.
- Booth Co., Arthur E., 4124 Beverly Blvd., Los Angeles 4, Calif.
- BRACKE-SEIB X-RAY CO., INC., 293 Third Ave., New York, N. Y. ADV. PG. 390.
- Brujac Electronic Corp., 103 Lafayette St., New York 13, N. Y.
- Bunnell & Co., J. H., 81 Prospect St., Brooklyn, N. Y.
- CHATHAM ELECTRONICS CORP., 475 Washington St., Newark 2, N. J. ADV. PG. 46.
- CORNELL-DUBILIER ELECTRIC CORP., South Plainfield, N. J. ADV. PG. 146.
- Cossor (Canada), Ltd., 301-303 Windsor St., Halifax, N. S., Canada.
- Deelcam Corp., 56 Elmwood St., Newton 58, Mass.
- Douglas Radio Labs., 176 Norfolk Ave., Boston 19, Mass.
- ELECTRO PRODUCTS LABS., INC., 4501 N. Ravenswood Ave., Chicago 40, Ill. ADV. PG. 199.
- Electronic Control Co., 3124 Avenue L, Brooklyn 10, N. Y.
- ELECTRONIC MEASUREMENTS COMPANY, Red Bank, N. J. ADV. PG. 312.
- EL-TRONICS INC., 2649 N. Howard St., Philadelphia 33, Pa. ADV. PG. 299.
- FEDERAL TELEPHONE AND RADIO CORP., 88 Kingsland Rd., Clifton, N. J. ADV. PG. 161-163.
- FERRANTI ELECTRIC, INC., 30 Rockefeller Plaza, New York 20, N. Y. ADV. PG. 159.
- FREED TRANSFORMER CO., INC., 1736 Weirfield St., Brooklyn 27, N. Y. ADV. PG. 149.
- Furst Electronics, 10 S. Jefferson St., Chicago 6, Ill.
- Galbraith & Son Electric Corp., C. C., 450 Sixth Ave., New York 11, N. Y.
- Gates Radio Co., Quincy, Ill.
- GENERAL ELECTRIC CO., Schenectady 5, N. Y. ADV. PG. 1 to 22.
- GENERAL RADIO CO., 275 Massachusetts Ave., Cambridge 39, Mass. ADV. PG. 48, 49.
- General Transformer Co., 18240 Harwood Ave., Homewood, Ill.
- Green Electric Co., W., 130 Cedar St., New York, N. Y.
- Hastings Instruments Co., Hampton 9, Va.
- HIGHLAND ENGINEERING CO., Main St. & Urban Ave., Westbury, N. Y. ADV. PG. 360.
- INDUCTOGRAPH PRODUCTS, 236 W. 55th St., New York, N. Y. ADV. PG. 326.
- Industrial Electronics Co., Hanover, Mass.
- INDUSTRIAL ELECTRONICS, INC., 8080 Wheeler St., Detroit 10, Mich. ADV. PG. 234, 235.
- Inet, Inc., 8655 S. Main St., Los Angeles 3, Calif.

Ⓜ indicates . . . IN PRODUCTION • AVAILABILITY • UNRESTRICTED FOR GENERAL USE

- ⓂKaar Engineering Co., 2995 Middlefield Rd., P. O. Box 1320, Palo Alto, Calif.
- ⓂKEPCO LABS., INC., 149-14 41st Ave., Flushing, N. Y. ADV. PG. 54.
- ⓂLAMBDA ELECTRONICS CORP., 103-02 Northern Blvd., Corona, N. Y. ADV. PG. 374.
- ⓂLANGEVIN MFG. CORP., 37 W. 65th St., New York 23, N. Y. ADV. PG. 348.
- ⓂLectronic Research Labs., 1021 Callowhill St., Philadelphia 23, Pa.
- ⓂLynmar Engineers, Inc., 1721 Delancey St., Philadelphia 3, Pa.
- ⓂMillen Mfg. Co., James, 150 Exchange St., Malden, Mass.
- ⓂNewcomb Audio Products Co., 6824 Lexington Ave., Hollywood 38, Calif.
- ⓂNortheastern Engineering, Inc., Manchester, N. H.
- ⓂOregon Electronic Mfg. Co., 206 S. W. Washington St., Portland 4, Ore.
- ⓂORTHON CORP., The, 196 Albion Ave., Paterson 2, N. J. ADV. PG. 156.
- ⓂPeerless Instrument Co., 90-15 Corona Ave., Elmhurst, N. Y.
- ⓂPENNSYLVANIA TESTING LABORATORY, Doylestown, Pa. ADV. PG. 350.
- ⓂPeschel Electronics, Inc., 13 Garden St., New Rochelle, N. Y.
- ⓂPOLARAD ELECTRONICS CORP., 100 Metropolitan Ave., Brooklyn 11, N. Y. ADV. PG. 184, 185.
- ⓂPOLYTECHNIC RESEARCH & DEVELOPMENT CO., INC., 202 Tillary St., Brooklyn 1, N. Y. ADV. PG. 172, 173.
- ⓂPower Equipment Co., 55 Antoinette St., Detroit 2, Mich.
- ⓂRadiart Corp., The, 3571 W. 62nd St., Cleveland 2, Ohio.
- ⓂRADIO CORP. OF AMERICA, RCA VICTOR DIV., General Offices, Camden, N. J. ADV. PG. 177, Inside Back and Back Covers.
- ⓂRadioactive Products, Inc., 443 W. Congress St., Detroit 26, Mich.
- ⓂRICHARDSON-ALLEN CORP., 116-15 15th Ave., College Point, N. Y. ADV. PG. 414.
- Ⓜ"S" CORRUGATED QUENCHED GAP CO., SCIENTIFIC ELECTRIC DIV., 105-119 Monroe St., Garfield, N. J. ADV. PG. 95.
- ⓂSchauer Mfg. Corp., 2119 Reading Rd., Cincinnati 2, Ohio.
- ⓂScott, Inc., Hermon Hosmer, 385 Putnam Ave., Cambridge 39, Mass.
- ⓂSherman Industrial Electronics Co., Inc., 505 Washington Ave., Belleville 9, N. J.
- ⓂSHERRON ELECTRONICS CO., 1201 Flushing Ave., Brooklyn 6, N. Y. ADV. PG. 145.
- ⓂShevers, Inc., Harold, 123 W. 64th St., New York 23, N. Y.
- ⓂSORENSEN & CO., INC., 375 Fairfield Ave., Stamford, Conn. ADV. PG. 66, 67.
- ⓂSPELLMAN TELEVISION CO., INC., 3029 Webster Ave., New York 67, N. Y. ADV. PG. 277.
- ⓂSPERRY GYROSCOPE CO., Div. of The Sperry Corp., Great Neck, N. Y. ADV. PG. 103, 104.
- ⓂStandard Telephones & Cables Ltd., Connaught House, Aldwych, London, W. C. 2, England.
- ⓂSTANDARD TRANSFORMER CORP., Elston, Kedzie and Addison, Chicago 18, Ill. ADV. PG. 144.
- ⓂStephens Mfg. Corp., 8538 Warner Drive, Culver City, Calif.
- ⓂSUPERIOR ELECTRIC CO., THE, 4000 Church St., Bristol, Conn. ADV. PG. 190, 191.
- ⓂTel-Instrument Co., Inc., 50 Patterson Ave., East Rutherford, N. J.
- ⓂThe Electric & Machine Works, 15 S. Jefferson St., Chicago 10, Ill.
- ⓂThordarson-Meissner Mfg. Divisions, 500 W. Huron St., Chicago 10, Ill.
- ⓂTransmitter Equipment Mfg. Co., Inc., 345 Hudson St., New York 14, N. Y.
- ⓂVaro Mfg. Co., Inc., Box 638, Garland, Tex. Vokar Corp., 7300 Huron River Drive, Dexter, Mich.
- ⓂWilcox Electric Co., 1400 Chestnut St., Kansas City, Mo.
- ⓂCHATHAM ELECTRONICS CORP., 475 Washington St., Newark 2, N. J. ADV. PG. 46.
- ⓂCondenser Products Co., 7517 N. Clark St., Chicago 26, Ill.
- ⓂDouglas Radio Labs., 176 Norfolk Ave., Boston 19, Mass.
- ⓂElectronic Brazing Co., 146 Glenridge Ave., Montclair, N. J.
- ⓂELECTRONIC MEASUREMENTS COMPANY, Red Bank, N. J. ADV. PG. 312.
- ⓂEltron, Inc., 407 N. Jackson St., Jackson, Mich.
- ⓂEL-TRONICS, INC., 2649 N. Howard St., Philadelphia 33, Pa. ADV. PG. 299.
- ⓂEmbassy Engineering Corp., 224 E. 204th St., New York 58, N. Y.
- ⓂFEDERAL TELEPHONE & RADIO CORP., 88 Kingsland Rd., Clifton, N. J. ADV. PG. 161-163.
- ⓂFREED TRANSFORMER CO., INC., 1736 Weirfield St., Brooklyn 27, N. Y. ADV. PG. 149.
- ⓂFurst Electronics, 10 S. Jefferson St., Chicago 6, Ill.
- ⓂGates Radio Co., Quincy, Ill.
- ⓂGENERAL ELECTRIC CO., Schenectady 5, N. Y. ADV. PG. 1 to 22.
- ⓂGertsch Products, Inc., 11846 Mississippi Ave., Los Angeles 25, Calif.
- ⓂGreen Electric Co., W., 130 Cedar St., New York, N. Y.
- ⓂHuggins Laboratories, 734 Hamilton Ave., Menlo Park, Calif.
- ⓂINDUCTOGRAPH PRODUCTS, 236 W. 55th St., New York, N. Y. ADV. PG. 326.
- ⓂInet, Inc., 8655 S. Main St., Los Angeles 3, Calif.
- ⓂKEPCO LABS., INC., 149-14 41st Ave., Flushing, N. Y. ADV. PG. 54.
- ⓂLAMBDA ELECTRONICS CORP., 103-02 Northern Blvd., Corona, N. Y. ADV. PG. 374.
- ⓂLANGEVIN MFG. CORP., 37 W. 65th St., New York 23, N. Y. ADV. PG. 348.
- ⓂMillen Mfg. Co., James, 150 Exchange St., Malden, Mass.
- ⓂMODELECTRIC PRODUCTS CORP., 1500 Bangs Ave., Asbury Park, N. J. ADV. PG. 204.
- ⓂNew London Instrument Co., Box 189, New London, Conn.
- ⓂNewcomb Audio Products Co., 6824 Lexington Ave., Hollywood 38, Calif.
- ⓂNorth American Philips Co., Inc., 100 E. 42nd St., New York 17, N. Y.
- ⓂNortheastern Engineering, Inc., Manchester, N. H.
- ⓂNuclear Research Corp., 2707 Federal St., Philadelphia 46, Pa.
- ⓂNucleonic Corp. of America, The, 497 Union St., Brooklyn 31, N. Y.
- ⓂORTHON CORP., THE, 196 Albion Ave., Paterson 2, N. J. ADV. PG. 156.
- ⓂPeerless Instrument Co., 90-15 Corona Ave., Elmhurst, N. Y.
- ⓂPeschel Electronics, Inc., 13 Garden St., New Rochelle, N. Y.
- ⓂPOLYTECHNIC RESEARCH & DEVELOPMENT CO., INC., 202 Tillary St., Brooklyn 1, N. Y. ADV. PG. 172, 173.
- ⓂPRECISE MEASUREMENTS CO., 942 Kings Highway, Brooklyn 23, N. Y. ADV. PG. 401.
- ⓂPress Wireless Mfg. Co., Inc., Cantiague Rd., Hicksville, N. Y.
- ⓂRadiart Corp., The, 3571 W. 62nd St., Cleveland, Ohio.
- ⓂRadiation Counter Laboratories, Inc., 1844 W. 21st St., Chicago 8, Ill.
- ⓂRADIO CORP. OF AMERICA, RCA VICTOR DIV., General Offices, Camden, N. J. ADV. PG. 177, Inside Back & Back Covers.
- ⓂRadio Engineering Laboratories, Inc., 36-40 37th St., Long Island City 1, N. Y.
- ⓂRICHARDSON-ALLEN CORP., 116-15 15th Ave., College Point, N. Y. ADV. PG. 414.
- ⓂSherman Industrial Electronics Co., Inc., 505 Washington Ave., Belleville 9, N. J.
- ⓂSHERRON ELECTRONICS CO., 1201 Flushing Ave., Brooklyn 6, N. Y. ADV. PG. 145.
- ⓂShevers, Inc., Harold, 123 W. 64th St., New York 23, N. Y.
- ⓂSORENSEN & CO., INC., 375 Fairfield Ave., Stamford, Conn. ADV. PG. 66, 67.
- ⓂSPELLMAN TELEVISION CO., INC., 3029 Webster Ave., New York 67, N. Y. ADV. PG. 277.
- ⓂSPERRY GYROSCOPE CO., Div. of The Sperry Corp., Great Neck, N. Y. ADV. PG. 103, 104.
- ⓂTakk Corp., Newark, Ohio.
- ⓂTektronix, Inc., 712 Southeast Hawthorne Blvd., Portland 14, Ore.
- ⓂThordarson-Meissner Mfg. Divisions, 500 W. Huron St., Chicago 10, Ill.
- ⓂTransmitter Equipment Mfg. Co., Inc., 345 Hudson St., New York 14, N. Y.
- ⓂVokar Corp., 7300 Huron River Drive, Dexter, Mich.
- ⓂAMERICAN TELEVISION & RADIO CO., 300 E. Fourth St., St. Paul 1, Minn. ADV. PG. 266.
- ⓂAmplifier Corp. of America, 398 Broadway, New York 13, N. Y.
- ⓂAtlantic Electronics, 4 Manhasset Ave., Manorhaven, N. Y.
- ⓂATOMIC INSTRUMENT CO., 84 Massachusetts Ave., Cambridge 39, Mass. ADV. PG. 410.
- ⓂAudio Equipment Sales, 153 W. 33rd St., New York 1, N. Y.
- ⓂAutomatic Electric Sales Corp., 1033 W. Van Buren St., Chicago 7, Ill.
- ⓂBARKER & WILLIAMSON, 235 Fairfield Ave., Upper Darby, Pa. ADV. PG. 292.
- ⓂBassett, Inc., Rex, 307-311 N. W. First Ave., Fort Lauderdale, Fla.
- ⓂBETA ELECTRIC CORP., 1762 3rd Ave., New York 29, N. Y. ADV. PG. 399.
- ⓂBooth Co., Arthur E., 4124 Beverly Blvd., Los Angeles, Calif.
- ⓂBrujac Electronic Corp., 103 Lafayette St., New York 13, N. Y.
- ⓂCHATHAM ELECTRONICS CORP., 475 Washington St., Newark 2, N. J. ADV. PG. 46.
- ⓂCOMMUNICATION MEASUREMENTS LAB., INC., 120 Greenwich St., New York, N. Y. ADV. PG. 290.
- ⓂComputer Corp. of America, 149 Church St., New York, N. Y.
- ⓂConnor Radio Mfg. Co., 631 Whipple, Prescott, Ariz.
- ⓂCossor (Canada) Ltd., 301-303 Windsor St., Halifax, N. S., Canada.
- ⓂDoelcam Corp., 56 Elmwood St., Newton 58, Mass.
- ⓂDouglas Radio Labs., 176 Norfolk Ave., Boston 19, Mass.
- ⓂElectron Equipment Corp., 917 Meridian Ave., South Pasadena, Calif.
- ⓂELECTRONIC MEASUREMENTS COMPANY, Red Bank, N. J. ADV. PG. 312.
- ⓂEL-TRONICS, INC., 2649 N. Howard St., Philadelphia 33, Pa. ADV. PG. 299.
- ⓂEmbassy Engineering Corp., 224 E. 204th St., New York 58, N. Y.
- ⓂFansteel Metallurgical Corp., 2200 Sheridan Rd., North Chicago, Ill.
- ⓂFEDERAL TELEPHONE AND RADIO CORP., 88 Kingsland Rd., Clifton, N. J. ADV. PG. 161-163.
- ⓂFederal Tool Engineering Co., 532 Mulberry St., Newark 5, N. J.
- ⓂFluke Engineering Co., John, Box 755, Springdale, Conn.
- ⓂFurst Electronics 10 S. Jefferson St., Chicago 6, Ill.
- ⓂGalbraith & Son Electric Corp., C. C., 450 Sixth Ave., New York 11, N. Y.
- ⓂGates Radio Co., Quincy, Ill.
- ⓂGENERAL ELECTRIC CO., Schenectady 5, N. Y. ADV. PG. 1 to 22.
- ⓂGreen Electric Co., W., 130 Cedar St., New York, N. Y.
- ⓂHart Associates, 8430 Grand River, Detroit 4, Mich.
- ⓂHastings Instrument Co., Hampton 9, Va.
- ⓂINDUCTOGRAPH PRODUCTS, 236 W. 55th St., New York, N. Y. ADV. PG. 326.
- ⓂIndustrial Electronics Co., Hanover, Mass.
- ⓂINDUSTRIAL ELECTRONICS, INC., 8080 Wheeler St., Detroit 10, Mich. ADV. PG. 234, 235.
- ⓂInet, Inc., 8655 S. Main St., Los Angeles 3, Calif.
- ⓂKEPCO LABS., INC., 149-14 41st Ave., Flushing, N. Y. ADV. PG. 54.
- ⓂLAMBDA ELECTRONICS CORP., 103-02 Northern Blvd., Corona, N. Y. ADV. PG. 374.
- ⓂLANGEVIN MFG. CORP., 37 W. 65th St., New York 23, N. Y. ADV. PG. 348.
- ⓂMacLeod & Hanopol Inc., 10 Joiner St., Charlestown 29, Mass.
- ⓂMillen Mfg. Co., James, 150 Exchange St., Malden, Mass.
- ⓂMoulic Specialties Co., 1005-1007 W. Washington St., Bloomington, Ill.
- ⓂNewcomb Audio Products Co., 6824 Lexington Ave., Hollywood 38, Calif.
- ⓂNortheastern Engineering, Inc., Manchester, N. H.
- ⓂNuclear Research Corp., 2707 Federal St., Philadelphia 46, Pa.
- ⓂOregon Electronic Mfg. Co., 206 S. W. Washington St., Portland 4, Ore.
- ⓂORTHON CORP., THE, 196 Albion Ave., Paterson 2, N. J. ADV. PG. 156.
- ⓂPeerless Instrument Co., 90-15 Corona Ave., Elmhurst, N. Y.
- ⓂPENNSYLVANIA TESTING LABORATORY, Doylestown, Pa. ADV. PG. 350.
- ⓂPeschel Electronics, Inc., 13 Garden St., New Rochelle, N. Y.
- ⓂPhilbrick Researches, Inc., George A., 230 Congress St., Boston 10, Mass.
- ⓂPOLARAD ELECTRONICS CORP., 100 Metropolitan Ave., Brooklyn 11, N. Y. ADV. PG. 184, 185.
- ⓂPOLYTECHNIC RESEARCH & DEVELOPMENT CO., INC., 202 Tillary St., Brooklyn 1, N. Y. ADV. PG. 172, 173.
- ⓂPower Equipment Co., 55 Antoinette St., Detroit 2, Mich.
- ⓂPress Wireless Mfg. Co., Inc., Cantiague Rd., Hicksville, N. Y.
- ⓂProcess & Instruments, 60 Greenpoint Ave., Brooklyn 22, N. Y.
- ⓂRadar Engineers, 110 University St., Seattle 1, Wash.

POWER SUPPLIES—High Voltage

POWER SUPPLIES—Regulated

V indicates . . . IN PRODUCTION • AVAILABILITY • UNRESTRICTED FOR GENERAL USE

- Ⓞ Radio Engineering Laboratories, Inc., 36-40 37th St., Long Island City 1, N. Y.
- Ⓞ REEVES INSTRUMENT CORP., 215 E. 91st St., New York, N. Y. ADV. PG. 315.
- Ⓞ RICHARDSON-ALLEN CORP., 116-15 15th Ave., College Point, N. Y. ADV. PG. 414.
- Ⓞ Rutherford Electronics Corp., 3724½ S. Robertson Blvd., Culver City, Calif.
- Ⓞ SERVO CORP., OF AMERICA, 20-20 Jericho Turnpike, New Hyde Park, N. Y. ADV. PG. 150, 151.
- Ⓞ SERVOMECHANISMS, INC., Whaleneck Rd. & Stewart Ave., Westbury, N. Y. ADV. PG. 188.
- Ⓞ Sherman Industrial Electronics Co., Inc., 505 Washington Ave., Belleville 9, N. J.
- Ⓞ SHERRON ELECTRONICS CO., 1201 Flushing Ave., Brooklyn 6, N. Y. ADV. PG. 145.
- Ⓞ Shevers, Inc., Harold, 123 W. 64th St., New York 23, N. Y.
- Ⓞ SOLA ELECTRIC CO., 4633 W. 16th St., Chicago 50, Ill. ADV. PG. 312.
- Ⓞ SORENSEN & CO., INC., 375 Fairfield Ave., Stamford, Conn. ADV. PG. 66, 67.
- Ⓞ SPELLMAN TELEVISION CO., INC., 3029 Webster Ave., New York 67, N. Y. ADV. PG. 277.
- Ⓞ SPENCER-KENNEDY LABS., INC., 186 Massachusetts Ave., Cambridge 39, Mass. ADV. PG. 166.
- Ⓞ SPERRY GYROSCOPE CO., DIV. OF THE SPERRY CORP., Great Neck, N. Y. ADV. PG. 103, 104.
- Ⓞ Standard Telephones & Cables Ltd., Connaught House, Aldwych, London, W. C. 2, England.
- Ⓞ SUPERIOR ELECTRIC CO., 4000 Church St., Bristol, Conn. ADV. PG. 190, 191.
- Ⓞ Tektronix, Inc., 712 Southeast Hawthorne Blvd., Portland 14, Ore.
- Ⓞ Tel-Instrument Co., Inc., 50 Paterson Ave., East Rutherford, N. J.
- Ⓞ Ther Electric & Machine Works, 15 S. Jefferson St., Chicago, Ill.
- Ⓞ Thordarson-Meissner Mfg. Divisions, 500 W. Huron St., Chicago 10, Ill.
- Ⓞ Transmitter Equipment Mfg. Co., Inc., 345 Hudson St., New York 14, N. Y.
- Ⓞ Varo Mfg. Co., Inc., Box 638, Garland, Texas.
- Ⓞ Vokar Corp., 7300 Huron River Drive, Dexter, Mich.
- Ⓞ West Coast Electronics Co., 1601 S. Burlington St., Los Angeles 6, Calif.

- Ⓞ Shevers, Inc., Harold, 123 W. 64th St., New York 23, N. Y.
- Ⓞ SPENCER-KENNEDY LABS., INC., 186 Massachusetts Ave., Cambridge 39, Mass. ADV. PG. 166.
- Ⓞ Tel-Instrument Co., Inc., 50 Paterson Ave., East Rutherford, N. J.

PRE-SELECTORS

- Ⓞ BARKER & WILLIAMSON, 235 Fairfield Ave., Upper Darby, Pa. ADV. PG. 292.
- Ⓞ Bassett, Inc., Rex, 307-311 N.W. First Ave., Fort Lauderdale, Fla.
- Ⓞ Gonset Co., 72 E. Tujunga Ave., Burbank, Calif.

PRESES—Metal Forming

- Ⓞ Whitney Metal Tool Co., 150 Forbes St., Rockford, Ill.

PRINTED OR STAMPED CIRCUITS
See Circuits

PROBES

- Ⓞ AEROLITE ELECTRONIC HARDWARE CORP., 507 26th St., Union City, N. J. ADV. PG. 355.
- Ⓞ ALDEN PRODUCTS CO., 117 N. Main St., Brockton 64, Mass. ADV. PG. 327.
- Ⓞ ATOMIC INSTRUMENT CO., 84 Massachusetts Ave., Cambridge 39, Mass. ADV. PG. 410.
- Ⓞ BELLING & LEE LTD., 366 Madison Ave., New York 17, N. Y. ADV. PG. 336.
- Ⓞ Diamond Mfg. Co., Wakefield, Mass.
- Ⓞ Jackson Electrical Instrument Co., 16 S. Patterson Blvd., Dayton 1, Ohio.
- Ⓞ Nuclear Instrument & Chemical Corp., 223 W. Erie St., Chicago 10, Ill.
- Ⓞ Racon Electric Co., 52 East 19th St., New York 3, N. Y.
- Ⓞ Radio City Products Co., Inc., 152 W. 25th St., New York 1, N. Y.
- Ⓞ Radioactive Products, Inc., 443 W. Congress St., Detroit 26, Mich.
- Ⓞ Smith, Inc., Herman H., 436 18th St., Brooklyn 15, N. Y.
- Ⓞ Technical Associates, 3730 San Fernando Rd., Glendale 4, Calif.
- Ⓞ United Technical Labs., Box 425-W., Morristown, N. J.

PROBES—High Frequency

- Ⓞ ADVANCE ELECTRONICS CO., 451 Highland Ave., Passaic, N. J. ADV. PG. 224.
- Ⓞ AIRMEC LABORATORIES, LTD., 366 Madison Ave., New York 17, N. Y. ADV. PG. 336.
- Ⓞ ELECTRONIC INSTRUMENT CO., INC., 276 Newport St., Brooklyn 12, N. Y. ADV. PG. 129.
- Ⓞ Feiler Engineering Co., 8026 Monticello Ave., Skokie, Ill.
- Ⓞ General R-F Fittings Co., 702 Beacon St., Boston 15, Mass.
- Ⓞ HEATH CO., Benton Harbor, Mich. ADV. PG. 264.
- Ⓞ Insuline Corp. of America, 36-02 35th Ave., Long Island City, N. Y.
- Ⓞ Jackson Electrical Instrument Co., 16 S. Patterson Blvd., Dayton 1, Ohio.
- Ⓞ Javex, 921 State, Garland, Texas.
- Ⓞ Keystone Electronics Corp., 423 Broome St., New York 12, N. Y.
- Ⓞ LAVOIE LABORATORIES, Morganville, N. J. ADV. PG. 206.
- Ⓞ McMurdo Silver Co., Inc., 417 Lafayette St., New York, N. Y.
- Ⓞ MEASUREMENTS CORP., Boonton, N. J. ADV. PG. 99.
- Ⓞ Network Mfg. Corp., Bayonne, N. J.
- Ⓞ New London Instrument Co., Box 189, New London, Conn.
- Ⓞ Racon Electric Co., 52 E. 19th St., New York 3, N. Y.
- Ⓞ Radio City Products Co., Inc., 152 W. 25th St., New York 1, N. Y.
- Ⓞ RADIO CORP. OF AMERICA, Tube Dept., Harrison, N. J. ADV. PG. 177, Inside Back and Back Covers.
- Ⓞ Reiner Electronics Co., 152 W. 25th St., New York, N. Y.
- Ⓞ TRAD TELEVISION CORP., 1001 First Ave., Asbury Park, N. J. ADV. PG. 355.
- Ⓞ Triumph Mfg. Co., 913 W. Van Buren St., Chicago 7, Ill.
- Ⓞ United Technical Labs., Box 425-W., Morristown, N. J.

PROBES—High Voltage

- Ⓞ CITATION PRODUCTS CO., 233 E. 146th St., New York 53, N. Y. ADV. PG. 388.
- Ⓞ ELECTRONIC INSTRUMENT CO., INC., 276 Newport St., Brooklyn 12, N. Y. ADV. PG. 312.
- Ⓞ Feiler Engineering Co. 8026 Monticello Ave., Skokie, Ill.
- Ⓞ HEATH CO., Benton Harbor, Mich. ADV. PG. 264.

- Ⓞ HEWLETT-PACKARD CO., 395 Page Mill Rd., Palo Alto, Calif. ADV. PG. 33-36.
- Ⓞ Insuline Corp. of America, 36-02 35th Ave., Long Island City, N. Y.
- Ⓞ Jackson Electrical Instrument Co., 16 S. Patterson Blvd., Dayton 1, Ohio.
- Ⓞ Javex, 921 State, Garland, Texas.
- Ⓞ Keystone Electronics Corp., 423 Broome St., New York 12, N. Y.
- Ⓞ McMurdo Silver Co., Inc., 417 Lafayette St., New York, N. Y.
- Ⓞ Network Mfg. Corp., Bayonne, N. J.
- Ⓞ Oak Ridge Products Mfg. Div. of Video Television, Inc., 37-01 Vernon Blvd., Long Island City 1, N. Y.
- Ⓞ Philco Corp., Tloga & C Sts., Philadelphia 34, Pa.
- Ⓞ PRECISE MEASUREMENTS CO., 942 Kings Highway, Brooklyn 23, N. Y. ADV. PG. 401.
- Ⓞ Radio City Products Co., Inc., 152 W. 25th St., New York 1, N. Y.
- Ⓞ RADIO CORP. OF AMERICA, Tube Dept., Harrison, N. J. ADV. PG. 177, Inside Back and Back Covers.
- Ⓞ Reiner Electronics Co., 152 W. 25th St., New York, N. Y.
- Ⓞ Sensitive Research Instrument Corp., 9 Elm Ave., Mt. Vernon, N. Y.
- Ⓞ SPERRY GYROSCOPE CO., DIV. OF THE SPERRY CORP., Great Neck, N. Y. ADV. PG. 103, 104.
- Ⓞ SYLVANIA ELECTRIC PRODUCTS, INC., 1740 Broadway, New York 19, N. Y. ADV. PG. 432-436.
- Ⓞ TRAD TELEVISION CORP., 1001 First Ave., Asbury Park, N. J. ADV. PG. 355.

PROBES—Microwave

- Ⓞ Diamond Mfg. Co., Wakefield, Mass.
- Ⓞ General R-F Fittings Co., 702 Beacon St., Boston 15, Mass.
- Ⓞ KINGS MICROWAVE CO., INC., 50 Marbledale Rd., Tuckahee 7, N. Y. ADV. PG. 178, 179.
- Ⓞ Microwave Equipment Co., Inc., North Caldwell, N. J.
- Ⓞ POLYTECHNIC RESEARCH & DEVELOPMENT CO., INC., 202 Tillary St., Brooklyn 1, N. Y. ADV. PG. 172, 173.

PROJECTION TUBES
See Tubes, Television Projection

PROTECTIVE SEALERS
See Insulating Compounds

PSYCHOGALVANOMETERS

- Ⓞ Associated Research, Inc., 3758 W. Belmont, Chicago 18, Ill.
- Ⓞ EDIN CO., INC., 207 Main St., Worcester, Mass. ADV. PG. 285.
- Ⓞ Electro-Medical Lab., Inc., South Woodstock, Vt.
- Ⓞ Maico Co., Inc., 21 N. 3rd St., Minneapolis, Minn.

PUBLIC ADDRESS SYSTEMS
See Sound Systems, Complete

PULLEYS—Dial

- Ⓞ AMERICAN MOLDED PRODUCTS CO., 1644 N. Honore St., Chicago 22, Ill. ADV. PG. 382.
- Ⓞ Brandywine Fibre Co., 15th & Poplar Sts., Wilmington, Del.
- Ⓞ CITATION PRODUCTS CO., 233 E. 146th St., New York 51, N. Y. ADV. PG. 388.
- Ⓞ Cortland Industries, Inc., 4545 Cortland St., Chicago 39, Ill.
- Ⓞ General Cement Mfg. Co., 919 Taylor Ave., Rockford, Ill.
- Ⓞ Insuline Corp. of America, 36-02 35th Ave., Long Island City, N. Y.
- Ⓞ LaMagna Mfg. Co., Inc., East Rutherford, N. J.
- Ⓞ Ucinite Co. Division, United-Carr Fastener Corp., 459 Watertown St., Newtonville, Mass.
- Ⓞ United-Carr Fastener Corp., Cambridge 42, Mass.

PUMPS—Metering

- Ⓞ ROBINSON INC., EDWARD E., 95 Park Ave., Nutley 10, N. J. ADV. PG. 398.

PUMPS—Vacuum
See Vacuum Pumps

PUNCHES—Metal

- Ⓞ CITATION PRODUCTS CO., 233 E. 146th St., New York 51, N. Y. ADV. PG. 388.
- Ⓞ Eyelet Tool Co., 188 Dorchester Ave., Boston, Mass.
- Ⓞ Green Mfg. Corp., G. G., Warren, Pa.
- Ⓞ Greenlee Tool Co., 2136 12th St., Rockford, Ill.
- Ⓞ Hovis Screwlock Co., 8100 East Nine Mile Rd., Van Dyke, Mich.
- Ⓞ Insuline Corp. of America, 36-02 35th Ave., Long Island City, N. Y.
- Ⓞ O'Neil-Irwin Mfg. Co., 316 8th Ave., Lake City, Minn.
- Ⓞ Parker-Kalon Corp., 200 Varick St., New York 14, N. Y.

PRE-AMPLIFIERS for COMMUNICATION RECEIVERS

- Ⓞ BARKER & WILLIAMSON, 235 Fairfield Ave., Upper Darby, Pa. ADV. PG. 292.
- Ⓞ Bassett, Inc., Rex, 307-311 N.W. First Ave., Fort Lauderdale, Fla.
- Ⓞ Gonset Co., 72 E. Tujunga Ave., Burbank, Calif.
- Ⓞ Industrial Television, Inc., 359 Lexington Ave., Clifton, N. J.
- Ⓞ Kaar Engineering Co., 2995 Middlefield Rd., P. O. Box 1320, Palo Alto, Calif.
- Ⓞ Lyngmar Engineers, Inc., 1721 Delancey St., Philadelphia 3, Pa.
- Ⓞ Magna Electronics Co., 3707-11 W. Jefferson Blvd., Los Angeles 16, Calif.
- Ⓞ Millen Mfg. Co., James, 150 Exchange St., Malden, Mass.
- Ⓞ Monarch Radio & Television Corp., 2430 Atlantic Ave., Brooklyn 33, N. Y.
- Ⓞ POLARAD ELECTRONICS CORP., 100 Metropolitan Ave., Brooklyn 11, N. Y. ADV. PG. 184, 185.
- Ⓞ Radio Mfg. Engineers Inc., 300-302 First Ave., Peoria 6, Ill.
- Ⓞ Rollins Corp., Moore Bldg., Rehoboth, Del.
- Ⓞ Scott, Inc., Hermon Hosmer, 385 Putnam Ave., Cambridge, Mass.
- Ⓞ Shevers, Inc., Harold, 123 W. 64th St., New York 23, N. Y.
- Ⓞ Thordarson-Meissner Mfg. Divisions, 500 W. Huron St., Chicago 10, Ill.

PRE-AMPLIFIERS for OSCILLOSCOPES

- Ⓞ AIR ASSOCIATES, INC., Teterboro, N. J. ADV. PG. 211.
- Ⓞ AIRMEC LABORATORIES, LTD., 366 Madison Ave., New York 17, N. Y. ADV. PG. 336.
- Ⓞ Baldwin-Lima-Hamilton Corp., Paschal P. O. Station, Philadelphia 42, Pa.
- Ⓞ Brujac Electronic Corp., 103 Lafayette St., New York 13, N. Y.
- Ⓞ COSSOR, LTD., A. C., 350 Fifth Ave., New York 1, N. Y. ADV. PG. 412.
- Ⓞ Cossor (Canada), Ltd., 301-303 Windsor St., Halifax, N. S., Canada.
- Ⓞ Electro-Medical Lab., Inc., South Woodstock, Vt.
- Ⓞ Furst Electronics, 10 S. Jefferson St., Chicago 6, Ill.
- Ⓞ Hart Associates, 8430 Grand River, Detroit 4, Mich.
- Ⓞ Kalbfell Labs., Inc., 1076 Morena Blvd., San Diego 10, Calif.
- Ⓞ KEITHLEY INSTRUMENTS, 1507 Warrenville Center Rd., Cleveland 21, Ohio. ADV. PG. 337.
- Ⓞ POLARAD ELECTRONICS CORP., 100 Metropolitan Ave., Brooklyn 11, N. Y. ADV. PG. 184, 185.
- Ⓞ Process & Instruments, 60 Greenpoint Ave., Brooklyn 22, N. Y.
- Ⓞ RAHM INSTRUMENTS, INC., 12 West Broadway, New York 7, N. Y. ADV. PG. 354.

Ⓥ indicates . . . IN PRODUCTION • AVAILABILITY • UNRESTRICTED FOR GENERAL USE

- Ⓥ PIX MFG. CO., INC., 24 Bedford St., Newark, N. J. ADV. PG. 136.
- Ⓥ Pratt & Whitney Div., Niles-Bement-Pond Co., West Hartford 1, Conn.
- Ⓥ Wiedemann Machine Co., 4272 Wissahickon Ave., Philadelphia 32, Pa.

PUSHBUTTONS

- Ⓥ Catalin Corp. of America, 1 Park Ave., New York 16, N. Y.
- Ⓥ CINEMA ENGINEERING CO., 1510 W. Verdugo Ave., Burbank, Calif. ADV. PG. 204.
- Ⓥ Clark Controller Co., 1146 E. 152nd St., Cleveland 10, Ohio.
- Ⓥ Connecticut Telephone & Electric Corp., 70 Britania St., Meriden, Conn.
- Ⓥ Delco Radio Div., General Motors Corp., Kokomo, Ind.
- Ⓥ Edwards Co., Inc., 86 Boston Post Rd., Norwalk, Conn.
- Ⓥ EMELOID CO., INC., THE, 1239 Central Ave., Hillside 5, N. J. ADV. PG. 102.
- Ⓥ ERIE RESISTOR CORP., 644 W. 12th St., Erie, Pa. ADV. PG. 91.
- Ⓥ GENERAL ELECTRIC CO., Schenectady 5, N. Y. ADV. PG. 1 to 22.
- Ⓥ Gits Molding Corp., 4600 W. Huron St., Chicago 44, Ill.
- Ⓥ Philco Corp., Tioga & C Sts., Philadelphia 34, Pa.
- Ⓥ RHODEN MANUFACTURING CO., 4739 Montrose Ave., Chicago 43, Ill. ADV. PG. 406.
- Ⓥ RUSSELL & STOLL CO., INC., 125 Barclay St., New York 7, N. Y. ADV. PG. 337.
- Ⓥ WARD LEONARD ELECTRIC CO., 31 South St., Mt. Vernon, N. Y. ADV. PG. 69, 70.
- Ⓥ WESTINGHOUSE ELECTRIC CORP., 511 Wood St., P. O. Box 868, Pittsburgh 30, Pa. ADV. PG. 107-113.

QUARTZ—Raw

- Ⓥ Bassett, Inc., Rex, 307-311 N. W. First Ave., Fort Lauderdale, Fla.
- Ⓥ Diamond Drill Carbon Co., 53-63 Park Row, New York 7, N. Y.
- Ⓥ KNIGHTS CO., JAMES, 131 S. Wells St., Sandwich, Ill. ADV. PG. 328.
- Ⓥ Murray American Corp., 95 Summit Ave., Summit, N. J.
- Ⓥ Nebel Lab., R. E., 1104 Lincoln Pl., Brooklyn 13, N. Y.
- Ⓥ PAN AMERICAN TRADE DEVELOPMENT CORP., 40 Wall St., New York 5, N. Y. ADV. PG. 266.

QUARTZ—Unfinished Crystals

- Ⓥ Bassett, Inc., Rex, 307-311 N. W. First Ave., Fort Lauderdale, Fla.
- Ⓥ BLILEY ELECTRIC CO., Union Station Bldg., Erie, Pa. ADV. PG. 311, 407.
- Ⓥ CLARK CRYSTAL CO., 2 Farm Rd., Marlboro, Mass. ADV. PG. 366.
- Ⓥ HUNT CORP., 455 Lincoln St., Carlisle Pa. ADV. PG. 413.
- Ⓥ Nebel Lab., R. E., 1104 Lincoln Pl., Brooklyn 13, N. Y.
- Ⓥ PAN AMERICAN TRADE DEVELOPMENT CORP., 40 Wall St., New York 5, N. Y. ADV. PG. 266.
- Ⓥ Precision Piezo Service, 427 Mayflower St., Baton Rouge, La.
- Ⓥ Polytech Devices, Inc., 1180 E. Grand St., Elizabeth, N. J.
- Ⓥ Westline Electronics Co., 11656 Olympic Blvd., Los Angeles 25, Calif.

RACKS—Relay

- Ⓥ ABALON PRECISION MFG. CORP., 540 Casanova St., Bronx 59, N. Y. ADV. PG. 348.
- Ⓥ Altec Lansing Corp., 9356 Santa Monica Blvd., Beverly Hills, Calif.
- Ⓥ ART-LOYD METAL PRODUCTS CORP., 2973 Cropsey Ave., Brooklyn 14, N. Y. ADV. PG. 364.
- Ⓥ Autocall Co., The, Shelby, Ohio.
- Ⓥ Bud Radio Inc., 2118 E. 55th St., Cleveland 3, Ohio.
- Ⓥ CINEMA ENGINEERING CO., 1510 W. Verdugo Ave., Burbank, Calif. ADV. PG. 204.
- Ⓥ Colgate Mfg. Corp., Lindenhurst, N. Y.
- Ⓥ Corry Jamestown Mfg. Co., Corry, Pa.
- Ⓥ Cutler Metal Products Co., 1025 Line St., Camden, N. J.
- Ⓥ Edwards Co., Inc., 86 Boston Post Rd., Norwalk, Conn.
- Ⓥ FEDERAL TELEPHONE & RADIO CORP., 88 Kingsland Rd., Clifton, N. J. ADV. PG. 161-163.
- Ⓥ Insuline Corp. of America, 36-02 35th Ave., Long Island City, N. Y.
- Ⓥ JOHNSON CO., E. F., Waseca, Minn. ADV. PG. 118, 121.
- Ⓥ KARP METAL PRODUCTS CO., INC., 215 63rd St., Brooklyn 20, N. Y. ADV. PG. 105.
- Ⓥ KELLOGG SWITCHBOARD & SUPPLY CO., 6650 S. Cicero Ave., Chicago 38, Ill. ADV. PG. 294.
- Ⓥ Lorentzen Inc., Levolver, 391 W. Broadway, New York, N. Y.

- Ⓥ Measurement Engineering, Ltd., Arnprior, Ontario, Canada.
- Ⓥ Newcomb Audio Products Co., 6824 Lexington Ave., Hollywood 38, Calif.
- Ⓥ Par-Metal Products Corp., 32-62 49th St., Long Island City 3, N. Y.
- Ⓥ REF Mfg. Corp., Jericho Turnpike, Mineola, N. Y.
- Ⓥ Radio Engineering Laboratories, Inc., 36-40 37th St., Long Island City 1, N. Y.
- Ⓥ SIGNAL ENGINEERING & MFG. CO., 154-6 W. 14th St., New York, N. Y. ADV. PG. 256.
- Ⓥ RADIO CORP. OF AMERICA, RCA Victor Div., General Offices, Camden, N. J. ADV. PG. 177, Inside Back & Back Covers.
- Ⓥ Walter Co., Inc., S., 1400 Atlantic Ave., Brooklyn 16, N. Y.

RADAR NAVIGATIONAL DEVICES

- Ⓥ ALLISON RADAR CORP., 11 W. 42nd St., New York 18, N. Y. ADV. PG. 411.
- Ⓥ Avion Instrument Corp., Paramus, N. J.
- Ⓥ Bludworth Marine Div., National-Simplex-Bludworth, Inc., 92 Gold St., New York 38, N. Y.
- Ⓥ Bunnell & Co., J. H., 81 Prospect St., Brooklyn, N. Y.
- Ⓥ Cossor (Canada) Ltd., 301-303 Windsor St., Halifax, N. S., Canada.
- Ⓥ Elm Laboratories, 18 South Broadway, Dobbs Ferry, N. Y.
- Ⓥ Farrand Optical Co., Inc., Bronx Blvd. at 238th St., New York 70, N. Y.
- Ⓥ FEDERAL TELEPHONE & RADIO CORP., 88 Kingsland Rd., Clifton, N. J. ADV. PG. 161-163.
- Ⓥ General Communication Co., 530 Commonwealth Ave., Boston 15, Mass.
- Ⓥ Gilfillan Bros., Inc., 1815 Venice Blvd., Los Angeles 6, Calif.
- Ⓥ H. M. R. Electronics, Inc., Grove St., New Canaan, Conn.
- Ⓥ Hastings Instrument Co., Inc., Hampton 9, Va.
- Ⓥ MARCONI INSTRUMENTS, LTD., 23 Beaver St., New York 4, N. Y. ADV. PG. 270.
- Ⓥ Network Mfg. Corp., Bayonne, N. J.
- Ⓥ Press Wireless Mfg. Co., Inc., Cantiague Rd., Hicksville, N. Y.
- Ⓥ Radiomarine Corp. of America, 75 Varick St., New York 13, N. Y.
- Ⓥ RAYTHEON MFG. CO., Equipment Sales Div., Waltham 54, Mass. ADV. PG. 80, 81.
- Ⓥ SPERRY GYROSCOPE CO., Div. of The Sperry Corp., Great Neck, N. Y. ADV. PG. 103, 104.
- Ⓥ WESTINGHOUSE ELECTRIC CORP., 511 Wood St., P. O. Box 868, Pittsburgh 30, Pa. ADV. PG. 107-113.

RADAR SYSTEMS AND EQUIPMENT—Aircraft Landing

- Ⓥ AIR ASSOCIATES, INC., Teterboro, N. J. ADV. PG. 211.
- Ⓥ Avion Instrument Corp., Paramus, N. J.
- Ⓥ Bendix Radio Division, Bendix Aviation Corp., Baltimore 4, Md.
- Ⓥ Bunnell & Co., J. H., 81 Prospect St., Brooklyn, N. Y.
- Ⓥ Gaveco Labs., Inc., 2 East End Ave., New York 21, N. Y.
- Ⓥ Hastings Instrument Co., Inc., Hampton 9, Va.
- Ⓥ Gilfillan Bros., Inc., 1815 Venice Blvd., Los Angeles 6, Calif.
- Ⓥ Kennedy & Co., D. S., Cohasset, Mass.
- Ⓥ Network Mfg. Corp., Bayonne, N. J.
- Ⓥ SPERRY GYROSCOPE CO., Div. of The Sperry Corp., Great Neck, N. Y. ADV. PG. 103, 104.
- Ⓥ Standard Telephones & Cables Ltd., Connaught House, Aldwych, London, W. C. 2, England.

RADAR SYSTEMS AND EQUIPMENT—Altimeters

- Ⓥ Automatic Signal Div., Eastern Industries, Inc., 100 Regent St., East Norwalk, Conn.
- Ⓥ Avion Instrument Corp., Paramus, N. J.
- Ⓥ Hastings Instrument Co., Inc., Hampton 9, Va.
- Ⓥ Network Mfg. Corp., Bayonne, N. J.
- Ⓥ Standard Telephones & Cables Ltd., Connaught House, Aldwych, London, W. C. 2, England.

RADAR SYSTEMS AND EQUIPMENT—Receivers

- Ⓥ AIR ASSOCIATES, INC., Teterboro, N. J. ADV. PG. 211.
- Ⓥ AMERICAN ELECTRONEERING CORP., 5025-29 W. Jefferson Blvd., Los Angeles 16, Calif. ADV. PG. 136.
- Ⓥ Avion Instrument Corp., Paramus, N. J.
- Ⓥ Bunnell & Co., J. H., 81 Prospect St., Brooklyn, N. Y.
- Ⓥ Cossor (Canada) Ltd., 301-303 Windsor St., Halifax, N. S., Canada.
- Ⓥ Gaveco Labs., Inc., 2 East End Ave., New York 21, N. Y.
- Ⓥ Gilfillan Bros., Inc., 1815 Venice Blvd., Los Angeles 6, Calif.
- Ⓥ Hastings Instrument Co., Inc., Hampton 9, Va.
- Ⓥ MARCONI INSTRUMENTS, LTD., 23 Beaver St., New York 4, N. Y. ADV. PG. 270.
- Ⓥ Motorola, Inc., 4545 Augusta Blvd., Chicago 51, Ill.

- Ⓥ Network Mfg. Corp., Bayonne, N. J.
- Ⓥ Press Wireless Mfg. Co., Inc., Cantiague Rd., Hicksville, N. Y.
- Ⓥ Radiomarine Corp. of America, 75 Varick St., New York 13, N. Y.
- Ⓥ RAYTHEON MFG. CO., Equipment Sales Div., Waltham 54, Mass. ADV. PG. 80, 81.
- Ⓥ REEVES INSTRUMENT CORP., 215 E. 91st St., New York, N. Y. ADV. PG. 315.
- Ⓥ SPERRY GYROSCOPE CO., Div. of The Sperry Corp., Great Neck, N. Y. ADV. PG. 103, 104.
- Ⓥ Telemark, Inc., 100 Greyrock Pl., Stamford, Conn.
- Ⓥ Transmitter Equipment Mfg. Co., Inc., 345 Hudson St., New York 14, N. Y.

RADAR SYSTEMS AND EQUIPMENT—Trainers

- Ⓥ Atlantic Electronics, 4 Manhasset Ave., Manhasset, N. Y.
- Ⓥ Avion Instrument Corp., Paramus, N. J.
- Ⓥ Bunnell & Co., J. H., 81 Prospect St., Brooklyn, N. Y.
- Ⓥ Cossor (Canada) Ltd., 301-303 Windsor St., Halifax, N. S., Canada.
- Ⓥ Elm Laboratories, 18 South Broadway, Dobbs Ferry, N. Y.
- Ⓥ Gilfillan Bros., Inc., 1815 Venice Blvd., Los Angeles 6, Calif.
- Ⓥ Hastings Instrument Co., Inc., Hampton 9, Va.
- Ⓥ Microwave Equipment Co., Inc., Nerth Caldwell, N. J.
- Ⓥ Network Mfg. Corp., Bayonne, N. J.
- Ⓥ Peerless Instrument Co., 90-15 Corona Ave., Elmhurst, N. Y.
- Ⓥ Press Wireless Mfg. Co., Inc., Cantiague Rd., Hicksville, N. Y.
- Ⓥ Transmitter Equipment Mfg. Co., Inc., 345 Hudson St., New York 14, N. Y.

RADAR SYSTEMS AND EQUIPMENT—Transmitters

- Ⓥ AMERICAN ELECTRONEERING CORP., 5025-29 W. Jefferson Blvd., Los Angeles 16, Calif. ADV. PG. 136.
- Ⓥ AIR ASSOCIATES, INC., Teterboro, N. J. ADV. PG. 211.
- Ⓥ Avion Instrument Corp., Paramus, N. J.
- Ⓥ Bludworth Marine Div., National-Simplex-Bludworth, Inc., 92 Gold St., New York 38, N. Y.
- Ⓥ Bunnell & Co., J. H., 81 Prospect St., Brooklyn, N. Y.
- Ⓥ Cossor (Canada) Ltd., 301-303 Windsor St., Halifax, N. S., Canada.
- Ⓥ Gaveco Labs., Inc., 2 East End Ave., New York 21, N. Y.
- Ⓥ Gilfillan Bros., Inc., 1815 Venice Blvd., Los Angeles 6, Calif.
- Ⓥ Hastings Instrument Co., Inc., Hampton 9, Va.
- Ⓥ MARCONI INSTRUMENTS, LTD., 23 Beaver St., New York 4, N. Y. ADV. PG. 270.
- Ⓥ Microwave Equipment Co., Inc., North Caldwell, N. J.
- Ⓥ Motorola, Inc., 4545 Augusta Blvd., Chicago 51, Ill.
- Ⓥ Press Wireless Mfg. Co., Inc., Cantiague Rd., Hicksville, N. Y.
- Ⓥ PRODUCT DEVELOPMENT CO., INC., Arlington, N. J. ADV. PG. 362.
- Ⓥ Radiomarine Corp. of America, 75 Varick St., New York 13, N. Y.
- Ⓥ RAYTHEON MFG. CO., Equipment Sales Div., Waltham 54, Mass. ADV. PG. 80, 81.
- Ⓥ REEVES INSTRUMENT CORP., 215 E. 91st St., New York, N. Y. ADV. PG. 315.
- Ⓥ SPERRY GYROSCOPE CO., Div. of The Sperry Corp., Great Neck, N. Y. ADV. PG. 103, 104.
- Ⓥ Transmitter Equipment Mfg. Co., Inc., 345 Hudson St., New York 14, N. Y.
- Ⓥ WESTINGHOUSE ELECTRIC CORP., 511 Wood St., P. O. Box 868, Pittsburgh 30, Pa. ADV. PG. 107-113.

RADIO ISOTOPES See Isotopes, Radioactive

RADIOSONDES

- Ⓥ AIR ASSOCIATES, INC., Teterboro, N. J. ADV. PG. 211.
- Ⓥ BARKER & WILLIAMSON, 235 Fairfield Ave., Upper Darby, Pa. ADV. PG. 292.
- Ⓥ Friez Instrument Div., Bendix Aviation Corp., Baltimore 4, Md.
- Ⓥ Gaveco Labs., Inc., 2 East End Ave., New York 21, N. Y.
- Ⓥ Network Mfg. Corp., Bayonne, N. J.
- Ⓥ Northeastern Engineering, Inc., Manchester, N. H.
- Ⓥ Selector Industries, Inc., 401 E. 138th St., New York 54, N. Y.

RADIUM

- Ⓥ ATOMIC INSTRUMENT CO., 84 Massachusetts Ave., Cambridge 39, Mass. ADV. PG. 410.
- Ⓥ Canadian Radium & Uranium Corp., 630 Fifth Ave., New York 20, N. Y.
- Ⓥ St. John X-Ray Laboratory, Caliform, N. J.
- Ⓥ Tracerlab, Inc., 130 High St., Boston 10, Mass.
- Ⓥ U. S. Radium Corp., 535 Pearl St., New York 7, N. Y.

V indicates . . . **IN PRODUCTION • AVAILABILITY • UNRESTRICTED FOR GENERAL USE**

RATIOMETERS

- Ⓞ Leeds & Northrup Co., 4970 Stenton Ave., Philadelphia 44, Pa.
- Ⓞ Sensitive Research Instrument Corp., 9 Elm Ave., Mt. Vernon, N. Y.
- Ⓞ SERVOMECHANISMS, INC., Whaleneck Rd. & Stewart Ave., Westbury, N. Y. ADV. PG. 188.
- Ⓞ WESTON ELECTRICAL INSTRUMENT CORP., 595 Frelinghuysen Ave., Newark 5, N. J. ADV. PG. 243.

REACTORS—Saturable

- Ⓞ ACME ELECTRONICS, INC., 300 N. Lake Ave., Pasadena 4, Calif. ADV. PG. 182.
- Ⓞ Acro Products Co., 215 Arch St., Philadelphia 6, Pa.
- Ⓞ Acro Transformer Mfg. Corp., 26-02 4th St., Astoria 2, N. Y.
- Ⓞ AIRDESIGN, INC., 241 Fairfield Ave., Upper Darby, Pa. ADV. PG. 368.
- Ⓞ Aitec-Lansing Corp., 9356 Santa Monica Blvd., Beverly Hills, Calif.
- Ⓞ Electran Mfg. Co., 1901 N. Clybourn, Chicago, Ill.
- Ⓞ FERRANTI ELECTRIC, INC., 30 Rockefeller Plaza, New York 20, N. Y. ADV. PG. 159.
- Ⓞ FREED TRANSFORMER CO., INC., 1736 Weirfield St., Brooklyn 27, N. Y. ADV. PG. 149.
- Ⓞ Gaveco Labs., Inc., 2 East End Ave., New York 21, N. Y.
- Ⓞ GENERAL ELECTRIC CO., Schenectady 5, N. Y. ADV. PG. 1 to 22.
- Ⓞ HIGHLAND ENGINEERING CO., Main St. & Urban Ave., Westbury, N. Y. ADV. PG. 360.
- Ⓞ Inet, Inc., 8655 S. Main St., Los Angeles 3, Calif.
- Ⓞ Lear, Inc., 110 Ionia Ave., N. W., Grand Rapids 2, Mich.
- Ⓞ Light Electric Corp., 214 Lacakawanna Ave., Newark 4, N. J.
- Ⓞ MAGNETIC AMPLIFIERS, INC., 1154 44th Drive, Long Island City 1, N. Y. ADV. PG. 346.
- Ⓞ Melpar, Inc., 552 Swann Ave., Alexandria, Va.
- Ⓞ PARMEKO, LTD., 366 Madison Ave., New York 17, N. Y. ADV. PG. 336.
- Ⓞ Richmond Engineering Co., Inc., 48 Water St., South Norwalk, Conn.
- Ⓞ SORENSEN & CO., INC., 375 Fairfield Ave., Stamford, Conn. ADV. PG. 66, 67.
- Ⓞ Ther Electric & Machine Works, 15 S. Jefferson St., Chicago, Ill.
- Ⓞ Thordarson-Meissner Mfg. Divisions, 500 W. Huron St., Chicago 10, Ill.
- Ⓞ Transformer Engineers, 389 S. Arroyo Parkway, Pasadena, Calif.
- Ⓞ UNITED TRANSFORMER CO., 150 Varick St., New York 13, N. Y. ADV. PG. Inside Front Cover.
- Ⓞ Varo Mfg. Co., Inc., Box 638, Garland, Texas.

REACTORS

See also Chokes and Coils, Choke

RECEIVERS—Aircraft

- Ⓞ Aeronautical Communications Equipment, Inc., 3090 Douglas Rd., Miami 33, Fla.
- Ⓞ AIR ASSOCIATES, INC., Teterboro, N. J. ADV. PG. 211.
- Ⓞ AIRCRAFT RADIO CORP., Boonton, N. J. ADV. PG. 400, 401.
- Ⓞ Avion Instrument Corp., Paramus, N. J.
- Ⓞ Bassett, Inc., Rex, 307-311 N. W. First Ave., Fort Lauderdale, Fla.
- Ⓞ Belmont Radio Corp., Div. Raytheon Mfg. Co., 5921 W. Dickens Ave., Chicago 39, Ill.
- Ⓞ Bunnell & Co., J. H., 81 Prospect St., Brooklyn, N. Y.
- Ⓞ Collins Radio Co., Cedar Rapids, Iowa.
- Ⓞ Communications Co., Inc., 300 Greco Ave., Coral Gables 34, Fla.
- Ⓞ Cossor (Canada) Ltd., 301-303 Windsor St., Halifax, N. S. (Canada).
- Ⓞ Electro Engineering & Mfg. Co., 627 W. Alexandrine Ave., Detroit 1, Mich.
- Ⓞ Electronic Specialty Co., 3456 Glendale Blvd., Los Angeles 39, Calif.
- Ⓞ Erco Radio Labs, Inc., E. Stewart Ave., Garden City, N. Y.
- Ⓞ Espy Mfg. Co., Inc., 528 E. 72nd St., New York, N. Y.
- Ⓞ FEDERAL TELEPHONE AND RADIO CORP., 88 Kingsland Rd., Clifton, N. J. ADV. PG. 161-163.
- Ⓞ Gaveco Labs., Inc., 2 East End Ave., New York 21, N. Y.
- Ⓞ GENERAL ELECTRIC CO., Electronics Dept., Electronics Park, Syracuse, N. Y. ADV. PG. 1 to 22.
- Ⓞ Gertsch Products, Inc., 11846 Mississippi Ave., Los Angeles 25, Calif.
- Ⓞ Jarvis Electronics Corp., 6058 W. Fullerton Ave., Chicago 39, Ill.
- Ⓞ Lear, Inc., 110 Ionia Ave., N. W., Grand Rapids 2, Mich.
- Ⓞ MARCONI INSTRUMENTS, LTD., 23 Beaver St., New York 4, N. Y. ADV. PG. 270.
- Ⓞ MITCHELL INDUSTRIES, INC., Camp Wolters, Mineral Wells, Texas. ADV. PG. 298.
- Ⓞ Monarch Radio & Television Corp., 2430 Atlantic Ave., Brooklyn 33, N. Y.

- Ⓞ Standard Telephones & Cables Ltd., Connaught House, Aldwych, London, W. C. 2, England.
- Ⓞ Telemark, Inc., 100 Greyrock Pl., Stamford, Conn.
- Ⓞ TRAD TELEVISION CORP., 1001 First Ave., Asbury Park, N. J. ADV. PG. 355.

RECEIVERS—a-m Fixed Frequency

- Ⓞ AIR ASSOCIATES, INC., Teterboro, N. J. ADV. PG. 211.
- Ⓞ AMERICAN ELECTRONEERING CO., 5025-29 W. Jefferson Blvd., Los Angeles 16, Calif. ADV. PG. 136.
- Ⓞ Automatic Radio Mfg. Co., 112 Brookline Ave., Boston, Mass.
- Ⓞ BARKER & WILLIAMSON, 235 Fairfield Ave., Upper Darby, Pa. ADV. PG. 292.
- Ⓞ Bassett, Inc., Rex, 307-311 N. W. First Ave., Fort Lauderdale, Fla.
- Ⓞ Belmont Radio Co., Div. Raytheon Mfg. Co., 5921 W. Dickens Ave., Chicago 39, Ill.
- Ⓞ Bendix Radio Division, Bendix Aviation Corp., Baltimore 4, Md.
- Ⓞ Breco Electronics Corp., 55 Vandam St., New York 13, N. Y.
- Ⓞ Bunnell & Co., J. H., 81 Prospect St., Brooklyn, N. Y.
- Ⓞ Clarke Instrument Div., National Electrical Machine Shops, Inc., 919 Jesup-Blair Drive, Silver Spring, Md.
- Ⓞ Collins Radio Co., Cedar Rapids, Iowa.
- Ⓞ Communications Co., Inc., 300 Greco Ave., Coral Gables 34, Fla.
- Ⓞ EL-TRONICS, INC., 2649 N. Howard St., Philadelphia 33, Pa. ADV. PG. 299.
- Ⓞ Erco Radio Labs, Inc., E. Stewart Ave., Garden City, N. Y.
- Ⓞ FEDERAL TELEPHONE & RADIO CORP., 88 Kingsland Rd., Clifton, N. J. ADV. PG. 161-163.
- Ⓞ Gates Radio Co., Quincy, Ill.
- Ⓞ Hammarlund Mfg. Co., 460 W. 34th St., New York 6, N. Y.
- Ⓞ HEINITZ & KAUFMAN EQUIPMENT DIV. OF THE ROBERT DOLLAR CO., 50 Drumm St., San Francisco 11, Calif. ADV. PG. 301.
- Ⓞ Kaar Engineering Co., 2995 Middlefield Rd., P. O. Box 1320, Palo Alto, Calif.
- Ⓞ Lear, Inc., 110 Ionia Ave., N. W., Grand Rapids 2, Mich.
- Ⓞ Link Radio Corp., 125 W. 17th St., New York, N. Y.
- Ⓞ McMurdo Silver Co., Inc., 417 Lafayette St., New York, N. Y.
- Ⓞ Majestic Radio & Television Div. of The Wilcox-Gay Corp., 70 Washington St., Brooklyn 1, N. Y.
- Ⓞ MARCONI INSTRUMENTS, LTD., 23 Beaver St., New York 4, N. Y. ADV. PG. 270.
- Ⓞ Measurement Engineering, Ltd., Arnprior, Ontario, Canada.
- Ⓞ Monarch Radio & Television Corp., 2430 Atlantic Ave., Brooklyn 33, N. Y.
- Ⓞ Motorola, Inc., 4545 Augusta Blvd., Chicago 51, Ill.
- Ⓞ NATIONAL CO., INC., 61 Sherman St., Malden 48, Mass. ADV. PG. 280, 281.
- Ⓞ Press Wireless Mfg. Co., Inc., Cantiague Rd., Hicksville, N. Y.
- Ⓞ Shevers, Inc., Harold, 123 W. 64th St., New York 23, N. Y.
- Ⓞ TRAD TELEVISION CORP., 1001 First Ave., Asbury Park, N. J. ADV. PG. 355.
- Ⓞ Transmitter Equipment Mfg. Co., Inc., 345 Hudson St., New York 14, N. Y.
- Ⓞ Wilcox Electric Co., 1400 Chestnut St., Kansas City, Mo.

RECEIVERS—a-m/f-m Communication

- Ⓞ AIR ASSOCIATES, INC., Teterboro, N. J. ADV. PG. 211.
- Ⓞ Aitec Lansing Corp., 9356 Santa Monica Blvd., Beverly Hills, Calif.
- Ⓞ AMERICAN ELECTRONEERING CO., 5025-29 W. Jefferson Blvd., Los Angeles 16, Calif. ADV. PG. 136.
- Ⓞ BARKER & WILLIAMSON, 235 Fairfield Ave., Upper Darby, Pa. ADV. PG. 292.
- Ⓞ Bassett, Inc., Rex, 307-311 N. W. First Ave., Fort Lauderdale, Fla.
- Ⓞ Bunnell & Co., J. H., 81 Prospect St., Brooklyn, N. Y.
- Ⓞ Collins Radio Co., Cedar Rapids, Iowa.
- Ⓞ Communications Co., Inc., 300 Greco Ave., Coral Gables 34, Fla.
- Ⓞ Coronet Radio & Television Corp., 500 West 52nd St., New York 19, N. Y.
- Ⓞ Doolittle Radio, Inc., 7421 S. Loomis Blvd., Chicago 36, Ill.
- Ⓞ Elm Laboratories, 18 South Broadway, Dobbs Ferry, N. Y.
- Ⓞ Espy Mfg. Co., Inc., 528 E. 72nd St., New York, N. Y.
- Ⓞ Gaveco Labs., Inc., 2 East End Ave., New York 21, N. Y.
- Ⓞ GENERAL ELECTRIC CO., Electronics Dept., Electronics Park, Syracuse, N. Y. ADV. PG. 1 to 22.
- Ⓞ HEINITZ & KAUFMAN EQUIPMENT DIV. OF THE ROBERT DOLLAR CO., 50 Drumm St., San Francisco 11, Calif. ADV. PG. 301.
- Ⓞ Kaar Engineering Co., 2995 Middlefield Rd., P. O. Box 1320, Palo Alto, Calif.

- Ⓞ Lear, Inc., 110 Ionia Ave., N. W., Grand Rapids 2, Mich.
- Ⓞ Link Radio Corp., 125 W. 17th St., New York, N. Y.
- Ⓞ McMurdo Silver Co., Inc., 417 Lafayette St., New York, N. Y.
- Ⓞ Magna Electronics Co., 3707-11 W. Jefferson Blvd., Los Angeles 16, Calif.
- Ⓞ MARCONI INSTRUMENTS, LTD., 23 Beaver St., New York 4, N. Y. ADV. PG. 270.
- Ⓞ Monarch Radio & Television Corp., 2430 Atlantic Ave., Brooklyn 33, N. Y.
- Ⓞ NATIONAL CO., INC., 61 Sherman St., Malden 48, Mass. ADV. PG. 280, 281.
- Ⓞ Radio Mfg. Engineers, Inc., 300-302 First Ave., Peoria 6, Ill.
- Ⓞ Shevers, Inc., Harold, 123 W. 64th St., New York 23, N. Y.
- Ⓞ Sonic Industries, Inc., 221 W. 17th St., New York 11, N. Y.
- Ⓞ Standard Telephones & Cables Ltd., Connaught House, Aldwych, London, W. C. 2, England.
- Ⓞ Technical Materiel Corp., The, P. O. Box 142, 121 Spencer Pl., Mamaroneck, N. Y.
- Ⓞ Thordarson-Meissner Mfg. Divisions, 500 W. Huron St., Chicago 10, Ill.
- Ⓞ WESTINGHOUSE ELECTRIC CORP., 511 Wood St., P. O. Box 868, Pittsburgh 30, Pa. ADV. PG. 107-113.
- Ⓞ Wilcox Electric Co., 1400 Chestnut St., Kansas City, Mo.

RECEIVERS—Automatic Radio Alarm

- Ⓞ AIR ASSOCIATES, INC., Teterboro, N. J. ADV. PG. 211.
- Ⓞ AMERICAN ELECTRONEERING CORP., 5025-29 W. Jefferson Blvd., Los Angeles 16, Calif. ADV. PG. 136.
- Ⓞ Bassett, Inc., Rex, 307-311 N. W. First Ave., Fort Lauderdale, Fla.
- Ⓞ Breco Electronics Corp., 55 Vandam St., New York 13, N. Y.
- Ⓞ Communications Co., Inc., 300 Greco Ave., Coral Gables 34, Fla.
- Ⓞ Link Radio Corp., 125 W. 17th St., New York, N. Y.
- Ⓞ MARCONI INSTRUMENTS, LTD., 23 Beaver St., New York 4, N. Y. ADV. PG. 270.
- Ⓞ Monarch Radio & Television Corp., 2430 Atlantic Ave., Brooklyn 33, N. Y.
- Ⓞ Radio Engineering Laboratories, Inc., 36-40 37th St., Long Island City 1, N. Y.
- Ⓞ Radiomarine Corp. of America, 75 Varick St., New York 13, N. Y.

RECEIVERS—Automobile

- Ⓞ AMERICAN ELECTRONEERING CORP., 5025-29 W. Jefferson Blvd., Los Angeles 16, Calif. ADV. PG. 136.
- Ⓞ Automatic Radio Mfg. Co., 112 Brookline Ave., Boston, Mass.
- Ⓞ Bassett, Inc., Rex, 307-311 N. W. First Ave., Fort Lauderdale, Fla.
- Ⓞ Bendix Radio Division, Bendix Aviation Corp., Baltimore 4, Md.
- Ⓞ Delco Radio Div., General Motors Corp., Kokomo, Ind.
- Ⓞ Eckstein Radio & Television Co., 3400 E. 42nd St., Minneapolis 6, Minn.
- Ⓞ Motorola, Inc., 4545 Augusta Blvd., Chicago 51, Ill.
- Ⓞ Philco Corp., Tioga & C Sts., Philadelphia 34, Pa.
- Ⓞ SYLVANIA ELECTRIC PRODUCTS, INC., 1740 Broadway, New York 19, N. Y. ADV. PG. 432-436.

RECEIVERS—Coin Operated

- Ⓞ Coronet Radio & Television Corp., 500 W. 52nd St., New York 19, N. Y.
- Ⓞ Magna Electronics Co., 3707-11 W. Jefferson, Los Angeles 16, Calif.
- Ⓞ Monarch Radio & Television Corp., 2430 Atlantic Ave., Brooklyn 33, N. Y.
- Ⓞ Northeastern Engineering, Inc., Manchester, N. H.
- Ⓞ ORTHON CORP., THE, 196 Albion Ave., Paterson 2, N. J. ADV. PG. 156.
- Ⓞ TRAD TELEVISION CORP., 1001 First Ave., Asbury Park, N. J. ADV. PG. 355.

RECEIVERS—Communication and Amateur

- Ⓞ Bassett, Inc., Rex, 307-311 N. W. First Ave., Fort Lauderdale, Fla.
- Ⓞ Bunnell & Co., J. H., 81 Prospect St., Brooklyn, N. Y.
- Ⓞ Collins Radio Co., Cedar Rapids, Iowa.
- Ⓞ Communications Co., Inc., 300 Greco Ave., Coral Gables 34, Fla.
- Ⓞ Espy Mfg. Co., Inc., 528 E. 72nd St., New York, N. Y.
- Ⓞ FEDERAL MFG. & ENGRG. CORP., 211 Steuben St., Brooklyn 5, N. Y. ADV. PG. 344.
- Ⓞ GENERAL ELECTRIC CO., Electronics Dept., Electronics Park, Syracuse, N. Y. ADV. PG. 1 to 22.
- Ⓞ Hammarlund Mfg. Co., 460 W. 34th St., New York 6, N. Y.
- Ⓞ HEATH CO., Benton Harbor, Mich. ADV. PG. 264.
- Ⓞ Lear, Inc., 110 Ionia Ave., N. W., Grand Rapids 2, Mich.
- Ⓞ Link Radio Corp., 125 W. 17th St., New York, N. Y.
- Ⓞ McMurdo Silver Co., Inc., 417 Lafayette St., New York, N. Y.

Ⓥ indicates . . . IN PRODUCTION • AVAILABILITY • UNRESTRICTED FOR GENERAL USE

- Ⓥ Monarch Radio & Television Corp., 2430 Atlantic Ave., Brooklyn 33, N. Y.
- Ⓥ Motorola, Inc., 4545 Augusta Blvd., Chicago 51, Ill.
- Ⓥ NATIONAL CO., INC., 61 Sherman St., Malden 48, Mass. ADV. PG. 280, 281.
- Ⓥ NORTHERN RADIO CO., INC., 143-145 W. 22nd St., New York 11, N. Y. ADV. PG. 262, 263.
- Ⓥ Press Wireless Mfg. Co., Inc., Cantiague Rd., Hicksville, N. Y.
- Ⓥ RADIO CORP. OF AMERICA, RCA Victor Div., General Offices, Camden, N. J. ADV. PG. 177, Inside Back & Back Covers.
- Radio Mfg. Engineers, Inc., 300-302 First Ave., Peoria 6, Ill.
- Ⓥ Radiomarine Corp. of America, 75 Varick St., New York 13, N. Y.
- Ⓥ Standard Telephones & Cables Ltd., Connaught House, Aldwych, London, W. C. 2, England.
- Ⓥ Thordarson-Meissner Mfg. Divisions, 500 W. Huron St., Chicago 10, Ill.
- Ⓥ Wilcox Electric Co., 1400 Chestnut St., Kansas City, Mo.

RECEIVERS—Diversity Reception

- Ⓥ BARKER & WILLIAMSON, 235 Fairfield Ave., Upper Darby, Pa. ADV. PG. 292.
- Ⓥ Bassett, Inc., Rex, 307-311 N. W. First Ave., Fort Lauderdale, Fla.
- Ⓥ Collins Radio Co., Cedar Rapids, Iowa.
- Ⓥ CROSBY LABS., INC., 126 Herricks Rd., Mineola, N. Y. ADV. PG. 196.
- Erco Radio Labs., Inc., E. Stewart Ave., Garden City, N. Y.
- Ⓥ Hammarlund Mfg. Co., 460 W. 34th St., New York 1, N. Y.
- Ⓥ HEINTZ & KAUFMAN EQUIPMENT DIV. OF THE ROBERT DOLLAR CO., 50 Drumm St., San Francisco 11, Calif. ADV. PG. 301.
- Ⓥ MARCONI INSTRUMENTS, LTD., 23 Beaver St., New York 4, N. Y. ADV. PG. 270.
- Ⓥ NATIONAL CO., INC., 61 Sherman St., Malden 48, Mass. ADV. PG. 280, 281.
- Ⓥ NORTHERN RADIO CO., INC., 143-145 W. 22nd St., New York 11, N. Y. ADV. PG. 262, 263.
- Ⓥ Press Wireless Mfg. Co., Inc., Cantiague Rd., Hicksville, N. Y.
- Ⓥ Schuttig & Co., Inc., 9th & Kearney Sts. N. E., Washington 17, D. C.
- Ⓥ Standard Telephones & Cables Ltd., Connaught House, Aldwych, London, W. C. 2, England.
- Ⓥ Technical Materiel Corp., The, P. O. Box 142, 121 Spencer Pl., Mamaroneck, N. Y.
- Ⓥ TRAD TELEVISION CORP., 1001 First Ave., Asbury Park, N. J. ADV. PG. 355.

RECEIVERS—Fixed Frequency

- Ⓥ AIR ASSOCIATES, INC., Teterboro, N. J. ADV. PG. 211.
- Ⓥ Approved Electronic Instrument Corp., 142 Liberty St., New York 6, N. Y.
- Ⓥ BARKER & WILLIAMSON, 235 Fairfield Ave., Upper Darby, Pa. ADV. PG. 292.
- Ⓥ Bassett, Inc., Rex, 307-311 N. W. First Ave., Fort Lauderdale, Fla.
- Ⓥ Bendix Radio Division, Bendix Aviation Corp., Baltimore 4, Md.
- Bunnell & Co., J. H., 81 Prospect St., Brooklyn, N. Y.
- Ⓥ Clarke Instrument Div., National Electrical Machine Shops, Inc., 919 Jesup-Blair Dr., Silver Spring, Md.
- Ⓥ Collins Audio Products Co., P. O. Box 368, Westfield, N. J.
- Ⓥ Collins Radio Co., Cedar Rapids, Iowa.
- Ⓥ Communications Co., Inc., 300 Greco Ave., Coral Gables 34, Fla.
- Ⓥ Doolittle Radio, Inc., 7421 S. Loomis Blvd., Chicago 36, Ill.
- Ⓥ EL-TRONICS, INC., 2649 N. Howard St., Philadelphia 33, Pa. ADV. PG. 299.
- Erco Radio Labs., Inc., E. Stewart Ave., Garden City, N. Y.
- Ⓥ FEDERAL TELEPHONE & RADIO CORP., 88 Kingsland Rd., Clifton, N. J. ADV. PG. 161-163.
- Ⓥ Gates Radio Co., Quincy, Ill.
- Ⓥ GENERAL ELECTRIC CO., Electronics Dept., Electronics Park, Syracuse, N. Y. ADV. PG. 1 to 22.
- Ⓥ HEINTZ & KAUFMAN EQUIPMENT DIV. OF THE ROBERT DOLLAR CO., 50 Drumm St., San Francisco 11, Calif. ADV. PG. 301.
- Ⓥ Kaar Engineering Co., 2995 Middlefield Rd., P. O. Box 1320, Palo Alto, Calif.
- Ⓥ Link Radio Corp., 125 W. 17th St., New York, N. Y.
- Ⓥ McMurdo Silver Co., Inc., 417 Lafayette St., New York, N. Y.
- Ⓥ Magna Electronics Co., 3707-11 W. Jefferson Blvd., Los Angeles 16, Calif.
- Ⓥ Majestic Radio & Television Div. of The Wilcox-Gay Corp., 70 Washington St., Brooklyn 1, N. Y.
- Ⓥ MARCONI INSTRUMENTS, LTD., 23 Beaver St., New York 4, N. Y. ADV. PG. 270.
- Ⓥ Measurement Engineering, Ltd., Arnprior, Ontario, Canada.
- Ⓥ Monarch Radio & Television Corp., 2430 Atlantic Ave., Brooklyn 33, N. Y.
- Monroe Coil Co., 2839 N. Narragansett Ave., Chicago 34, Ill.

- Ⓥ Motorola, Inc., 4545 Augusta Blvd., Chicago 51, Ill.
- Ⓥ NATIONAL CO., INC., 61 Sherman St., Malden 48, Mass. ADV. PG. 280, 281.
- Ⓥ Press Wireless Mfg. Co., Inc., Cantiague Rd., Hicksville, N. Y.
- Ⓥ Radio Engineering Laboratories, Inc., 36-40 37th St., Long Island City 1, N. Y.
- Ⓥ Shevers, Inc., Harold, 123 W. 64th St., New York 23, N. Y.
- Ⓥ SPERRY GYROSCOPE CO., Div. of The Sperry Corp., Great Neck, N. Y. ADV. PG. 103, 104.
- Ⓥ Stephens Mfg. Corp., 8538 Warner Drive, Culver City, Calif.
- Ⓥ Technical Materiel Corp., The, P. O. Box 142, 121 Spencer Pl., Mamaroneck, N. Y.
- Ⓥ Thordarson-Meissner Mfg. Divisions, 500 W. Huron St., Chicago 10, Ill.
- Transmitter Equipment Mfg. Co., Inc., 345 Hudson St., New York 14, N. Y.
- Ⓥ Wilcox Electric Co., 1400 Chestnut St., Kansas City, Mo.

RECEIVERS—f-m

- Ⓥ Altec Lansing Corp., 9356 Santa Monica Blvd., Beverly Hills, Calif.
- Ⓥ Approved Electronic Instrument Corp., 142 Liberty St., New York 6, N. Y.
- Ⓥ BARKER & WILLIAMSON, 235 Fairfield Ave., Upper Darby, Pa. ADV. PG. 292.
- Ⓥ Bassett, Inc., Rex, 307-311 N. W. First Ave., Fort Lauderdale, Fla.
- Ⓥ Bendix Radio Division, Bendix Aviation Corp., Baltimore 4, Md.
- Ⓥ Capehart-Farnsworth Corp., Fort Wayne, Indiana.
- Ⓥ Clarke Instrument Div., National Electrical Machine Shops, Inc., 919 Jesup-Blair Drive, Silver Spring, Md.
- Ⓥ Collins Audio Products Co., P. O. Box 368, Westfield, N. J.
- Ⓥ Communications Co., Inc., 300 Greco Ave., Coral Gables 34, Fla.
- Ⓥ Doolittle Radio, Inc., 7421 S. Loomis Blvd., Chicago 36, Ill.
- Espey Mfg. Co., Inc., 528 E. 72nd St., New York 19, N. Y.
- Ⓥ GENERAL ELECTRIC CO., Electronics Dept., Electronics Park, Syracuse, N. Y. ADV. PG. 1 to 22.
- Ⓥ Kaar Engineering Co., 2995 Middlefield Rd., P. O. Box 1320, Palo Alto, Calif.
- Ⓥ McMurdo Silver Co., Inc., 417 Lafayette St., New York, N. Y.
- Ⓥ Magna Electronics Co., 3707-11 W. Jefferson Blvd., Los Angeles 16, Calif.
- Ⓥ Majestic Radio & Television Div. of The Wilcox-Gay Corp., 70 Washington St., Brooklyn 1, N. Y.
- Ⓥ Measurement Engineering, Ltd., Arnprior, Ontario, Canada.
- Ⓥ Monarch Radio & Television Corp., 2430 Atlantic Ave., Brooklyn 33, N. Y.
- Ⓥ Motorola, Inc., 4545 Augusta Blvd., Chicago 51, Ill.
- Ⓥ Radio Engineering Laboratories, Inc., 36-40 37th St., Long Island City 1, N. Y.
- Ⓥ Shevers, Inc., Harold, 123 W. 64th St., New York 23, N. Y.
- Ⓥ SPERRY GYROSCOPE CO., Div. of The Sperry Corp., Great Neck, N. Y. ADV. PG. 103, 104.
- Ⓥ SYLVANIA ELECTRIC PRODUCTS, INC., 1740 Broadway, New York 19, N. Y. ADV. PG. 434-436.
- Ⓥ Thordarson-Meissner Mfg. Divisions, 500 W. Huron St., Chicago 10, Ill.
- Transmitter Equipment Mfg. Co., Inc., 345 Hudson St., New York 14, N. Y.
- Ⓥ West Coast Electronics Co., 1601 S. Burlington St., Los Angeles 6, Calif.
- Ⓥ WESTINGHOUSE ELECTRIC CORP., 511 Wood St., P. O. Box 868, Pittsburgh 30, Pa. ADV. PG. 107-113.

RECEIVERS—Loran

- Ⓥ Blutworth Marine Div., National-Simplex-Blutworth, Inc., 92 Gold St., New York 38, N. Y.
- Ⓥ Gaveco Labs., Inc., 2 East End Ave., New York 21, N. Y.
- Ⓥ RADIO CORP. OF AMERICA, RCA Victor Div., General Offices, Camden, N. J. ADV. PG. 177, Inside Back & Back Covers.
- Ⓥ Radiomarine Corp. of America, 75 Varick St., New York 13, N. Y.
- Ⓥ SPERRY GYROSCOPE CO., Div. of The Sperry Corp., Great Neck, N. Y. ADV. PG. 103, 104.

RECEIVERS—Marine

- Ⓥ AIR ASSOCIATES, INC., Teterboro, N. J. ADV. PG. 211.
- Ⓥ Applied Electronics Co., 1246 Folsom St., San Francisco 3, Calif.
- Ⓥ Bassett, Inc., Rex, 307-311 N. W. First Ave., Fort Lauderdale, Fla.
- Ⓥ Blutworth Marine Div., National-Simplex-Blutworth, Inc., 92 Gold St., New York 38, N. Y.
- Ⓥ Communications Co., Inc., 300 Greco Ave., Coral Gables 34, Fla.
- Erco Radio Labs., Inc., E. Stewart Ave., Garden City, N. Y.

- Ⓥ GENERAL ELECTRIC CO., Electronics Dept., Electronics Park, Syracuse, N. Y. ADV. PG. 1 to 22.
- Ⓥ Gray Radio Co., 501 Forest Hill Blvd., West Palm Beach, Fla.
- Ⓥ Harvey-Wells Electronics Inc., North St., Southbridge, Mass.
- Ⓥ Intervox Corp., 2701 California Ave., Seattle 6, Wash.
- Ⓥ Jefferson, Inc., Ray, 40 E. Merrick Rd., Freeport, L. I., N. Y.
- Ⓥ Kaar Engineering Co., 2995 Middlefield Rd., P. O. Box 1320, Palo Alto, Calif.
- Ⓥ MARCONI INSTRUMENTS, LTD., 23 Beaver St., New York 4, N. Y. ADV. PG. 270.
- Ⓥ Measurement Engineering, Ltd., Arnprior, Ontario, Canada.
- Ⓥ Radiomarine Corp. of America, 75 Varick St., New York 13, N. Y.
- Ⓥ RAYTHEON MFG. CO., Equipment Sales Div., Waltham 54, Mass. ADV. PG. 80, 81.
- Ⓥ SPERRY GYROSCOPE CO., Div. of The Sperry Corp., Great Neck, N. Y. ADV. PG. 103, 104.
- Ⓥ Standard Electronics Corp., 25 W. 43rd St., New York 18, N. Y.
- Ⓥ WESTINGHOUSE ELECTRIC CORP., 511 Wood St., P. O. Box 868, Pittsburgh 30, Pa. ADV. PG. 107-113.

RECEIVERS—Microwave

- Ⓥ AMERICAN ELECTRONEERING CORP., 5025-29 W. Jefferson Blvd., Los Angeles 16, Calif. ADV. PG. 136.
- Bunnell & Co., J. H., 81 Prospect St., Brooklyn, N. Y.
- Ⓥ Clarke Instrument Div., National Electrical Machine Shops, Inc., 919 Jesup-Blair Drive, Silver Spring, Md.
- Ⓥ Cossor (Canada) Ltd., 301-303 Windsor St., Halifax, N. S., Canada.
- Ⓥ FEDERAL TELEPHONE & RADIO CORP., 88 Kingsland Rd., Clifton, N. J. ADV. PG. 161-163.
- Ⓥ Gaveco Labs., Inc., 2 East End Ave., New York 21, N. Y.
- Ⓥ GENERAL ELECTRIC CO., Electronics Dept., Electronics Park, Syracuse, N. Y. ADV. PG. 1-22.
- Ⓥ Link Radio Corp., 125 W. 17th St., New York, N. Y.
- Ⓥ McMurdo Silver Co., Inc., 417 Lafayette St., New York, N. Y.
- Ⓥ Motorola, Inc., 4545 Augusta Blvd., Chicago 51, Ill.
- Ⓥ POLARAD ELECTRONICS CORP., 100 Metropolitan Ave., Brooklyn 11, N. Y. ADV. PG. 184, 185.
- Ⓥ POLYTECHNIC RESEARCH & DEVELOPMENT CO., INC., 202 Tillary St., Brooklyn 1, N. Y. ADV. PG. 172, 173.
- Ⓥ Press Wireless Mfg. Co., Inc., Cantiague Rd., Hicksville, N. Y.
- Ⓥ Radio Engineering Laboratories, Inc., 36-40 37th St., Long Island City 1, N. Y.
- Ⓥ SPERRY GYROSCOPE CO., Div. of The Sperry Corp., Great Neck, N. Y. ADV. PG. 103, 104.
- Transmitter Equipment Mfg. Co., Inc., 345 Hudson St., New York 14, N. Y.
- Ⓥ VECTRON, INC., 235 High St., Waltham, Mass. ADV. PG. 214.
- Ⓥ WESTINGHOUSE ELECTRIC CORP., 511 Wood St., P. O. Box 868, Pittsburgh 30, Pa. ADV. PG. 107-113.
- Ⓥ Weymouth Instrument Co., 1440 Commercial St., East Weymouth 89, Mass.

RECEIVERS—Panoramic

- Ⓥ Avion Instrument Corp., Paramus, N. J.
- Ⓥ Gaveco Labs., Inc., 2 East End Ave., New York 21, N. Y.
- Ⓥ PANORAMIC RADIO PRODUCTS, INC., 10 South Second Ave., Mt. Vernon, N. Y. ADV. PG. 383.
- Ⓥ POLARAD ELECTRONICS CORP., 100 Metropolitan Ave., Brooklyn 11, N. Y. ADV. PG. 184, 185.
- Ⓥ Telemark, Inc., 100 Greyrock Pl., Stamford, Conn.

RECEIVERS—Portable & Mobile

- Ⓥ AMERICAN ELECTRONEERING CORP., 5025-29 W. Jefferson Blvd., Los Angeles 16, Calif. ADV. PG. 136.
- Ⓥ Automatic Radio Mfg. Co., 112 Brookline Ave., Boston, Mass.
- Ⓥ BARKER & WILLIAMSON, 235 Fairfield Ave., Upper Darby, Pa. ADV. PG. 292.
- Ⓥ Bassett, Inc., Rex, 307-311 N. W. First Ave., Fort Lauderdale, Fla.
- Ⓥ Belmont Radio Co., Div. Raytheon Mfg. Co., 5921 W. Dickens Ave., Chicago 39, Ill.
- Ⓥ Communications Co., Inc., 300 Greco Ave., Coral Gables 34, Fla.
- Espey Mfg. Co., Inc., 528 E. 72nd St., New York, N. Y.
- Ⓥ FEDERAL MFG. & ENGRG. CORP., 211 Steuben St., Brooklyn 5, N. Y. ADV. PG. 344.
- Ⓥ GENERAL ELECTRIC CO., Electronics Dept., Electronics Park, Syracuse, N. Y. ADV. PG. 1 to 22.
- Ⓥ Kaar Engineering Co., 2995 Middlefield Rd., P. O. Box 1320, Palo Alto, Calif.
- Ⓥ Lear, Inc., 110 Ionia Ave., N. W., Grand Rapids 2, Mich.
- Ⓥ Link Radio Corp., 125 W. 17th St., New York, N. Y.
- Ⓥ Majestic Radio & Television Div. of The Wilcox-Gay Corp., 70 Washington St., Brooklyn 1, N. Y.

V indicates . . . IN PRODUCTION • AVAILABILITY • UNRESTRICTED FOR GENERAL USE

- ◉MARCONI INSTRUMENTS, LTD., 23 Beaver St., New York 4, N. Y. ADV. PG. 270.
- ◉McMurdo Silver Co., Inc., 417 Lafayette St., New York, N. Y.
- ◉Measurement Engineering, Ltd., Arnprior, Ontario Canada.
- ◉MITCHELL INDUSTRIES, INC., Camp Wolters, Mineral Wells, Texas. ADV. PG. 298.
- ◉Monarch Radio & Television Corp., 2430 Atlantic Ave., Brooklyn 33, N. Y.
- ◉Motorola, Inc., 4545 Augusta Blvd., Chicago 51, Ill.
- ◉RADIO CORP. OF AMERICA, RCA Victor Div., General Offices, Camden, N. J. ADV. PG. 177, Inside Back & Back Covers.
- ◉Radio Engineering Laboratories, Inc., 36-40 37th St., Long Island City 1, N. Y.
- ◉Radiomarine Corp. of America, 75 Varick St., New York 13, N. Y.
- ◉Rosen Engineering Products, Inc., Raymond, 32nd & Walnut Sts., Philadelphia 4, Pa.
- ◉Schuttig & Co., Inc., 9th & Kearny Sts. N. E., Washington 17, D. C.
- ◉Transmitter Equipment Mfg. Co., Inc., 345 Hudson St., New York 14, N. Y.

RECEIVERS—Radio Direction Finder

- ◉Aeronautical Electronics, Inc., Raleigh-Durham Airport, P. O. Box 6043, Raleigh, N. C.
- ◉AMERICAN ELECTROENGINEERING CORP., 5025-29 W. Jefferson Blvd., Los Angeles 16, Calif. ADV. PG. 136.
- ◉Applied Electronics Co., 1246 Folsom St., San Francisco 3, Calif.
- ◉BARKER & WILLIAMSON, 235 Fairfield Ave., Upper Darby, Pa. ADV. PG. 292.
- ◉Bassett, Inc., Rex, 307-311 N. W. First Ave., Fort Lauderdale, Fla.
- ◉Bendix Radio Division, Bendix Aviation Corp., Baltimore 4, Md.
- ◉Bludworth Marine Div., National-Simplex-Bludworth, Inc., 92 Gold St., New York 38, N. Y.
- ◉FAIRCHILD CAMERA & INSTRUMENT CORP., 88-06 Van Wyck Blvd., Jamaica 1, N. Y. ADV. PG. 244, 245.
- ◉FEDERAL TELEPHONE AND RADIO CORP., 88 Kingsland Rd., Clifton, N. J. ADV. PG. 161-163.
- ◉Gaveco Labs., Inc., 2 East End Ave., New York 21, N. Y.
- ◉Intervox Corp., 2701 California Ave., Seattle 6, Wash.
- ◉Jarvis Electronics Corp., 6058 W. Fullerton Ave., Chicago 39, Ill.
- ◉Jefferson, Inc., Ray, 40 E. Merrick Rd., Freeport, L. I., N. Y.
- ◉Kaar Engineering Co., 2995 Middlefield Rd., P. O. Box 1320, Palo Alto, Calif.
- ◉Lear, Inc., 110 Ionia Ave., N.W., Grand Rapids 2, Mich.
- ◉MARCONI INSTRUMENTS, LTD., 23 Beaver St., New York 4, N. Y. ADV. PG. 270.
- ◉Melpar, Inc., 552 Swamp Ave., Alexandria, Va.
- ◉Munston Mfg. & Service, Inc., Beech St., Islip, N. Y.
- ◉POLARAD ELECTRONICS CORP., 100 Metropolitan Ave., Brooklyn 11, N. Y. ADV. PG. 184, 185.
- ◉Radiomarine Corp. of America, 75 Varick St., New York 13, N. Y.
- ◉RAYTHEON MFG. CO., Equipment Sales Div., Waltham 54, Mass. ADV. PG. 80, 81.

RECEIVERS—Railroad

- ◉Bendix Radio Division, Bendix Aviation Corp., Baltimore 4, Md.
- ◉Communications Co., Inc., 300 Greco Ave., Coral Gables 34, Fla.
- ◉FEDERAL TELEPHONE & RADIO CORP., 88 Kingsland Rd., Clifton, N. J. ADV. PG. 161-163.
- ◉Gaveco Labs., Inc., 2 East End Ave., New York 21, N. Y.
- ◉Motorola, Inc., 4545 Augusta Blvd., Chicago 51, Ill.
- ◉Radio Engineering Laboratories, Inc., 36-40 37th St., Long Island City 1, N. Y.
- ◉Railway Communications, Inc., P. O. Box 1783, Lincoln, Neb.
- ◉WESTINGHOUSE ELECTRIC CORP., 511 Wood St., P. O. Box 868, Pittsburgh 39, Pa. ADV. PG. 107-113.

RECEIVERS—uhf

- ◉AIR ASSOCIATES, INC., Teterboro, N. J. ADV. PG. 211.
- ◉AMERICAN ELECTROENGINEERING CORP., 5025-29 W. Jefferson Blvd., Los Angeles 16, Calif. ADV. PG. 136.
- ◉Bassett, Inc., Rex, 307-311 N.W. First Ave., Fort Lauderdale, Fla.
- ◉Bunnell & Co., J. H., 81 Prospect St., Brooklyn, N. Y.
- ◉Clarke Instrument Div., National Electrical Machine Shops, Inc., 919 Jesup-Blair Drive, Silver Spring, Md.
- ◉FEDERAL TELEPHONE & RADIO CORP., 88 Kingsland Rd., Clifton, N. J. ADV. PG. 161-163.
- ◉Gaveco Labs., Inc., 2 East End Ave., New York 21, N. Y.
- ◉GENERAL ELECTRIC CO., Electronics Dept., Electronics Park, Syracuse, N. Y. ADV. PG. 1 to 22.
- ◉Hammarlund Mfg. Co., 460 West 34th St., New York 1, N. Y.

- ◉Link Radio Corp., 125 W. 17th St., New York, N. Y.
- ◉MARCONI INSTRUMENTS, LTD., 23 Beaver St., New York 4, N. Y. ADV. PG. 270.
- ◉McMurdo Silver Co., Inc., 417 Lafayette St., New York, N. Y.
- ◉Molded Insulation Co., 335 E. Price St., Philadelphia 44, Pa.
- ◉Monarch Radio & Television Corp., 2430 Atlantic Ave., Brooklyn 33, N. Y.
- ◉Motorola, Inc., 4545 Augusta Blvd., Chicago 51, Ill.
- ◉NATIONAL CO., INC., 61 Sherman St., Malden 48, Mass. ADV. PG. 280, 281.
- ◉POLARAD ELECTRONICS CORP., 100 Metropolitan Ave., Brooklyn 11, N. Y. ADV. PG. 184, 185.
- ◉Radio Engineering Laboratories, Inc., 36-40 37th St., Long Island City 1, N. Y.
- ◉SPERRY GYROSCOPE CO. Div. of The Sperry Corp., Great Neck, N. Y. ADV. PG. 103, 104.
- ◉Telemark, Inc., 900 Greyrock Pl., Stamford, Conn.
- ◉Thordarson-Meissner Mfg. Divisions, 500 W. Huron St., Chicago 10, Ill.
- ◉TRAD TELEVISION CORP., 1001 First Ave., Asbury Park, N. J. ADV. PG. 355.
- ◉Transmitter Equipment Mfg. Co., Inc., 345 Hudson St., New York 14, N. Y.
- ◉West Coast Electronics Co., 1601 S. Burlington St., Los Angeles 6, Calif.
- ◉Wilcox Electric Co., 1400 Chestnut St., Kansas City, Mo.

RECEIVERS—vhf

- ◉AIR ASSOCIATES, INC., Teterboro, N. J. ADV. PG. 211.
- ◉AIRCRAFT RADIO CORP., Boonton, N. J. ADV. PG. 400, 401.
- ◉AMERICAN ELECTROENGINEERING CORP., 5025-29 W. Jefferson Blvd., Los Angeles 16, Calif. ADV. PG. 136.
- ◉Automatic Radio Mfg. Co., 112 Brookline Ave., Boston, Mass.
- ◉Bassett, Inc., Rex, 307-311 N.W. First Ave., Fort Lauderdale, Fla.
- ◉Belmont Radio Co., Div. Raytheon Mfg. Co., 5921 W. Dickens Ave., Chicago 39, Ill.
- ◉Bendix Radio Division, Bendix Aviation Corp., Baltimore 4, Md.
- ◉Bunnell & Co., J. H., 81 Prospect St., Brooklyn, N. Y.
- ◉Clarke Instrument Div., National Electrical Machine Shops, Inc., 919 Jesup-Blair Drive, Silver Spring, Md.
- ◉Communications Co., Inc., 300 Greco Ave., Coral Gables 34, Fla.
- ◉FEDERAL TELEPHONE & RADIO CORP., 88 Kingsland Rd., Clifton, N. J. ADV. PG. 161-163.
- ◉GENERAL ELECTRIC CO., Electronics Dept., Electronics Park, Syracuse, N. Y. ADV. PG. 1 to 22.
- ◉Kaar Engineering Co., 2995 Middlefield Rd., P.O. Box 1320, Palo Alto, Calif.
- ◉Lear, Inc., 110 Ionia Ave., N.W., Grand Rapids 2, Mich.
- ◉Link Radio Corp., 125 W. 17th St., New York, N. Y.
- ◉MARCONI INSTRUMENTS, LTD., 23 Beaver St., New York 4, N. Y. ADV. PG. 270.
- ◉McMurdo Silver Co., Inc., 417 Lafayette St., New York, N. Y.
- ◉Measurement Engineering, Ltd., Arnprior, Ontario, Canada.
- ◉MEASUREMENTS CORP., Boonton, N. J. ADV. PG. 99.
- ◉Monarch Radio & Television Corp., 2430 Atlantic Ave., Brooklyn 33, N. Y.
- ◉Motorola, Inc., 4545 Augusta Blvd., Chicago 51, Ill.
- ◉NATIONAL CO., INC., 61 Sherman St., Malden 48, Mass. ADV. PG. 280, 281.
- ◉POLARAD ELECTRONICS CORP., 100 Metropolitan Ave., Brooklyn 11, N. Y. ADV. PG. 184, 185.
- ◉Radio Engineering Laboratories, Inc., 36-40 37th St., Long Island City 1, N. Y.
- ◉Radiomarine Corp. of America, 75 Varick St., New York 13, N. Y.
- ◉Railway Communications, Inc., P.O. Box 1783, Lincoln, Neb.
- ◉Telemark, Inc., 900 Greyrock Pl., Stamford, Conn.
- ◉TRAD TELEVISION CORP., 1001 First Ave., Asbury Park, N. J. ADV. PG. 355.
- ◉Transmitter Equipment Mfg. Co., Inc., 345 Hudson St., New York 14, N. Y.
- ◉West Coast Electronics Co., 1601 S. Burlington St., Los Angeles 6, Calif.
- ◉Wilcox Electric Co., 1400 Chestnut St., Kansas City, Mo.

- 15. t-v Console
- 16. t-v Portable
- 17. t-v Table
- 18. f-m/f-v Console
- 19. f-m/f-v Table
- 20. a-m/f-m/t-v Console
- 21. a-m/f-m/t-v Table
- 22. a-m/f-m/t-v phono, Console
- 23. Recorder and Phonograph combination
- 24. Built-in wall type

- ◉Admiral Corp., 3800 Cortland St., Chicago 47, Ill. 1-2-4-5-7-15-17-20-22.
- ◉Air-King Products Co., Inc., 170-53rd St., Brooklyn, N. Y. 1-2-3-4-5-6-7-8-11-15-17-18-19-20-21-22-23.
- ◉Altec Lansing Corp., 9356 Santa Monica Blvd., Beverly Hills, Calif. 15-17-24.
- ◉Andrea Radio Corp., 27-01 Bridge Plaza North, Long Island City 1, N. Y. 4-18-19-20-22.
- ◉Ansley Mfg. Co., Arthur, Doylestown, Pa. 7.
- ◉Approved Electronic Instrument Corp., 142 Liberty St., New York 6, N. Y. 11.
- ◉Arvin Industries, Inc., Radio & Television Div., Columbus, Ind. 1-4-5-7-11-15-17-22.
- ◉Audio Industries, Michigan City, Ind. 23.
- ◉Automatic Radio Mfg. Co., Inc., 122 Brookline Ave., Boston, Mass. 4-5-15-16.
- ◉Belmont Radio Co., Div., Raytheon Mfg. Co., 5921 W. Dickens Ave., Chicago 39, Ill. 4-5-6-7-11-15-16-17-22.
- ◉Bendix Radio Division, Bendix Aviation Corp., Baltimore 4, Md. 7-15-17.
- ◉Calbest Engineering & Electronics Co., 828 N. Highland Ave., Hollywood 38, Calif. 2-5-17-18-19-22.
- ◉Capehart-Farnsworth Corp., Fort Wayne, Indiana. 7-15-17-20-22.
- ◉Carron Mfg. Co., 415 South Aberdeen St., Chicago, Ill. 23.
- ◉Commercial Equipment Co., Inc., Box 168, Lawrence, Kansas. 6.
- ◉Conrac, Inc., Glendora, Calif. 15-24.
- ◉Coronet Radio & Television Corp., 500 W. 52nd St., New York 19, N. Y. 1-2.
- ◉Crosley Div., Avco Mfg. Corp., Cincinnati 25, Ohio. 1-4-5-7-13-15-17-22.
- ◉DeWald Radio Mfg. Corp., 35-15 37th Ave., Long Island City, N. Y. 2-4-5-14-23.
- ◉Du Mont Laboratories, Inc., Allen B., Television Receiver Sales Div., 35 Market St., East Paterson, N. J. 15-17-18-19-20-22.
- ◉Eckstein Radio & Television Co., 3400 E. 42nd St., Minneapolis 6, Minn. 5-11.
- ◉Emerson Radio & Phonograph Corp., 111 8th Ave., New York, N. Y. 1-2-3-4-5-6-7-8-9-10-11-12-13-14-15-16-17-20-21-22.
- ◉Espy Mfg. Co., Inc., 528 E. 72nd St., New York, N. Y. 1-2-3-4-5-7-8-9-10-24.
- ◉Fada Radio & Electric Co., Inc., 525 Main St., Belleville, N. J. 4-5-11-15-17-20-22.
- ◉Ferrari Radio & Television Corp., 55 W. 26th St., New York 10, N. Y. 1-3-5.
- ◉Fisher Radio Corp., 41 E. 47th St., New York, N. Y. 7-20-22.
- ◉Flush Wall Radio Co., 31 Clinton St., Newark 2, N. J. 24.
- ◉Freed Radio Corp., 200 Hudson St., New York, N. Y. 7-11-12-15-20-22.
- ◉GENERAL ELECTRIC CO., Electronics Dept., Electronics Park, Syracuse, N. Y. 1-4-5-7-11-14-18-19-20-22. ADV. PG. 1 to 22.
- ◉Hallcrafters Co., The, 4401 W. Fifth Ave., Chicago 24, Ill. 15-17-22.
- ◉HEATH CO., Benton Harbor, Mich. 5. ADV. PG. 264
- ◉Hoffman Radio Corp., 3716 S. Hill St., Los Angeles 7, Calif. 5-7-15-17-21-22.
- ◉Industrial Television, Inc., 359 Lexington Ave., Clifton, N. J. 15-17.
- ◉Jackson Industries, Inc., 58 E. Cullerton St., Chicago 16, Ill. 1-7-15-17-22.
- ◉Kaye-Halbert Corp., 3555 Hayden Ave., Culver City, Calif. 15-17.
- ◉Laurehk Radio Mfg. Co., 3931 Monroe Ave., Wayne Michigan. 5-6.
- ◉McMurdo Silver Co., Inc., 417 Lafayette St., New York, N. Y. 2-4-5-8-9-11.
- ◉M. P. Concert Installations, Fairfield 10, Conn. 7-15-17-23.
- ◉Magna Electronics Co., 3707-11 W. Jefferson Blvd., Los Angeles 16, Calif. 2-5-14.
- ◉Magnavox Co., The, Components Div., Fort Wayne 4, Indiana. 1-7-17-22.
- ◉Majestic Radio & Television Div. of The Wilcox-Gay Corp., 70 Washington St., Brooklyn 1, N. Y. 4-5-6-7-15-17-22.
- ◉Mattison Television & Radio Corp., 893 Broadway New York 3, N. Y. 5-11-15-17-20-22.
- ◉Meck Industries, John, Liberty at Pennsylvania, Plymouth, Ind. 4-5-15-17.
- ◉Midwest Radio & Television Corp., 909 Broadway, Cincinnati 2, Ohio. 7-15-20-22.
- ◉Molded Insulation Co., 335 E. Price St., Philadelphia 44, Pa. 5.
- ◉Monarch Radio & Television Corp., 2430 Atlantic Ave., Brooklyn 33, N. Y. 4-5-7-11-14-15-17-18-19-20-21-22.
- ◉Motorola, Inc., 4545 Augusta Blvd., Chicago 51, Ill. 1-2-3-4-5-7-8-9-10-11-22.

RECEIVERS, HOME

1. a-m phono, Console
2. a-m phono, Table
3. a-m Console
4. a-m Portable
5. a-m Table
6. a-m Vest Pocket
7. a-m/f-m phono, Console
8. a-m/f-m phono, Table
9. a-m/f-m Console
10. a-m/f-m Portable
11. a-m/f-m Table
12. f-m Console
13. f-m Portable
14. f-m Table

V indicates . . . IN PRODUCTION • AVAILABILITY • UNRESTRICTED FOR GENERAL USE

- Multiple Television Mfg. Co., 987 Hegeman Ave., Brooklyn 8, N. Y. 15-17.
- NATIONAL COMPANY, INC.**, 61 Sherman St., Malden 48, Mass. 5-15-17. ADV. PG. 280, 281.
- Newcomb Audio Products Co., 6824 Lexington Ave., Hollywood 38, Calif. 4.
- North American Philips Co., Inc., 100 E. 42nd St., New York 17, N. Y. 15.
- Northeastern Engineering, Inc., Manchester, N. H. 5.
- Olympic Radio & Television, Inc., 34-01 38th Ave., Long Island City, N. Y. 4-5-6-7-15-17-20-22.
- ORTHON CORP., THE**, 196 Albion Ave., Paterson 2, N. J. 1-2-3-4-5-24. ADV. PG. 156.
- Pentron Corp., The, 221 E. Cullerton St., Chicago 16, Ill. 23.
- Philco Corp., Tioga & C Sts., Philadelphia 34, Pa. 1-2-3-4-5-7-11-15-17-22.
- Pilot Radio Corp., 37-06 36th St., Long Island City, N. Y. 15-17-18-19-20-21-22.
- Plastics & Electronics Co., Inc., P.O. Box 38, Station J, Buffalo 8, N. Y. 4.
- RADIO CORP. OF AMERICA**, RCA Victor Div., Home Instrument Dept., Camden, N. J. 1-2-4-5-6-7-11-15-17-22. ADV. PG. 177, Inside Back & Back Covers.
- Radio Engineering Laboratories, Inc., 36-40 37th St., Long Island City 1, N. Y. 14-24.
- Rixtron Co., The, 1501 County Rd., Box 262, Belmont, Calif. 24.
- S. M. A. Co., 4721 N. Kedzie, Chicago, Ill. 15-17-18-19-22.
- Scott Radio Labs., Inc., 4451 N. Ravenswood Ave., Chicago 40, Ill. 7-9-15-17-20-22.
- Sentinel Radio Corp., 2100 Dempster St., Evanston, Ill. 4-5-6-7-8-9-11-15-16-17-20-21-22.
- Shevers Inc., Harold, 123 W. 64th St., New York 23, N. Y. 1-2-3-4-5-7-8-9-10-11-12-13-14-15-16-17-18-19-20-21-22.
- Speak-O-Phone Recording & Equipment Co., 23 W. 60th St., New York, N. Y. 23.
- Starrett Television Mfg. Corp., 601 W. 26th St., New York, N. Y. 15-17.
- Stewart-Warner Electric Div., Stewart-Warner Corp., 1826 Diversey P'kwy., Chicago 14, Ill. 1-4-5-7-11-15-17-20-22.
- Stromberg-Carlson Co., Rochester 3, N. Y. 1-5-17-22.
- SYLVANIA ELECTRIC PRODUCTS, INC.**, Radio & Television Div., 254 Rano St., Buffalo 7, N. Y. 1-2-3-4-5-6-7-8-9-10-11-12-13-14-15-16-17-18-19-20-21-22. ADV. PG. 432-436.
- Symphonic Radio & Electronic Corp., 292-298 Main St., Cambridge 42, Mass. 2-23.
- Symphony Radio & Television Corp., 721 N. Martel Ave., Los Angeles 15, Calif. 1-2-4-5-15-17-18-19-20-21-22-23.
- Tech-Master Products Co., 443-445 Broadway, New York 13, N. Y. 5-15-17-18-19.
- Tele King Corp., 601 W. 26th St., New York 1, N. Y. 22-23.
- Telequip Radio Co., 2559 W. 21st St., Chicago 8, Ill. 15-17.
- Tele-Tone Radio Co., 540 W. 58th St., New York 19, N. Y. 2-4-5-8-15-16-17.
- Thordarson-Meissner Mfg. Divisions, 500 W. Huron St., Chicago 10, Ill. 1-2-3-4-5-7-8-9-10-11-12-17-23.
- TRAD TELEVISION CORP.**, 1001 First Ave., Asbury Park, N. J. 15-16-17-18-19-20-21-22. ADV. PG. 355.
- Transvision, Inc., 460 North Ave., New Rochelle, N. Y. 15-17-18-19.
- Trav-Ler Radio Corp., 571 W. Jackson Blvd., Chicago, Ill. 2-4-5-15-17-22.
- U. S. Television Mfg. Corp., 3 W. 61st St., New York 23, N. Y. 15-17-18-20.
- Video Corp. of America, 229 W. 28th St., New York 1, N. Y. 5-11-15-17-18-19-20-21-22-23.
- Waveforms, Inc., 333 Sixth Ave., New York 14, N. Y. 7-12-23-24.
- Wells-Gardner & Co., 2701 N. Kildare Ave., Chicago 39, Ill. 1-2-3-4-5-7-8-9-11-15-17-20-22.
- WESTINGHOUSE ELECTRIC CORP.**, 511 Wood St., P.O. Box 868, Pittsburgh 30, Pa. 2-3-4-5-7-8-9-10-11-15-17-22. ADV. PG. 107-113.
- Zenith Radio Corp., 6001 Dickens Ave., Chicago 39, Ill. 3-4-5-7-11-13-14-15-17-20-22.

RECEIVING EQUIPMENT—vhf Omni-Range

- AIRCRAFT RADIO CORP.**, Boonton, N. J. ADV. PG. 400, 401.
- Bendix Radio Division, Bendix Aviation Corp., Baltimore 4, Md.
- Collins Radio Co., Cedar Rapids, Iowa.
- MITCHELL INDUSTRIES, INC.**, Camp Wolters, Mineral Wells, Texas. ADV. PG. 298.
- RADIO CORP. OF AMERICA**, RCA Victor Div., General Offices Camden, N. J. ADV. PG. 177, Inside Back & Back Covers.

RECORDERS—Blood Pressure

- Baldwin-Lima-Hamilton Corp., Paschall P.O. Station, Philadelphia 42, Pa.
- BRUSH DEVELOPMENT CO.**, 3405 Perkins Ave., Cleveland 14, Ohio. ADV. PG. 228, 229.
- EDIN CO., INC.**, 207 Main St., Worcester, Mass. ADV. PG. 285.

- Farrand Optical Co., Inc., Bronx Blvd. at 238th St., New York 70, N. Y.
- Hathaway Instrument Co., 1315 S. Clarkson St., Denver 10, Colo.
- Midwestern Geophysical Laboratory, 3400 S. Harvard, Tulsa, Okla.
- RAHM INSTRUMENTS INC.**, 12 West Broadway, New York 7, N. Y. ADV. PG. 354.
- SANBORN CO.**, 39 Osborn St., Cambridge 39, Mass. ADV. PG. 391.
- Southwestern Industrial Electronics Co., 2831 Post Oak Rd., P.O. Box 13058, Houston 19, Texas.
- Statham Laboratories, Inc., 12401 W. Olympic Blvd., Los Angeles 64, Calif.

RECORDERS—Density See Recorders, Specific Gravity

RECORDERS—Dielectric Constant

- Fielden Instrument Corp., 2920 N. 4th St., Philadelphia 33, Pa.
- Thompson & Associates, John E., 7210 S. Yates Ave., Chicago 49, Ill.

RECORDERS—Electronic Office Recorders & Playbacks

- Ampro Corp., 2835 N. Western Ave., Chicago 18, Ill.
- Dictaphone Corp., 420 Lexington Ave., New York 17, N. Y.
- Edison Inc., Thomas A., 51 Lakeside Ave., West Orange, N. J.
- Gray Mfg. Co., The, 16 Arbor St., Hartford, Conn.
- MAGNEGORD, INC.**, 360 N. Michigan Ave., Chicago 1, Ill. ADV. PG. 40.
- MILES REPRODUCER CO., INC.**, 812 Broadway, New York 3, N. Y. ADV. PG. 322.
- MINNEAPOLIS-HONEYWELL REGULATOR CO., INDUSTRIAL DIV.**, Wayne & Roberts Aves., Philadelphia 44, Pa. ADV. PG. 208, 209.
- Molded Insulation Co., 335 E. Price St., Philadelphia 44, Pa.
- Peirce Wire Recorder Corp., 1328 Sherman Ave., Evanston, Ill.
- Pentron Corp., The, 221 E. Cullerton St., Chicago 16, Ill.
- PERMOFLUX CORP.**, 4900 W. Grand Ave., Chicago 39, Ill. ADV. PG. 321.
- REEVES INSTRUMENT CORP.**, 215 E. 91st St., New York, N. Y. ADV. PG. 315.
- Soundscribe Corp., 146 Munson St., New Haven 4, Conn.
- Symphonic Radio & Electronic Corp., 292-298 Main St., Cambridge 42, Mass.
- TIMES FACSIMILE CO.**, 540 W. 58th St., New York 19, N. Y. ADV. PG. 288.

RECORDER—Electronic Rotary Stylus

- Bludworth Marine Div., National-Simplex-Bludworth, Inc., 92 Gold St., New York 38, N. Y.
- Telemark, Inc., 100 Greyrock Pl., Stamford, Conn.

RECORDERS—Electronic Self-Balancing Recorders and Indicators

- Baldwin-Lima-Hamilton Corp., Paschall P.O. Station, Philadelphia 42, Pa.
- Bristol Co., The, Waterbury 20, Conn.
- BRUSH DEVELOPMENT CO.**, 3405 Perkins Ave., Cleveland 14, Ohio. ADV. PG. 228, 229.
- Ess Specialty Corp., 96 So. Washington Ave., Bergenfield, N. J.
- Flader, Inc., Fredric, 1330 Laskey Rd., Toledo 12, Ohio.
- GENERAL ELECTRIC CO.**, Schenectady 5, N. Y. ADV. PG. 1 to 22.
- GENERAL ELECTRIC CO.**, Electronics Dept., Electronics Park, Syracuse, N. Y. ADV. PG. 1 to 22.
- Leeds & Northrup Co., 4970 Stenton Ave., Philadelphia 44, Pa.
- Loudon Instruments, Inc., 5644 Lake Park Ave., Chicago 37, Ill.
- Schaevitz Engineering, Crescent Blvd. at Drexel Ave., Pennsauken Township, Camden 11, N. J.
- Tagliabue Div., Weston Electrical Instrument Corp., 614 Frelinghuysen Ave., Newark 5, N. J.

RECORDERS—Facsimile

- Acme Electronix Div. of NEA Service, Inc., West Third & Lakeside, Cleveland 13, Ohio.
- ALDEN PRODUCTS CO.**, 117 No. Main St., Brockton 64, Mass. ADV. PG. 327.
- Ampex Electric Corp., 1155 Howard Ave., San Carlos, Calif.
- Bunnell & Co., J. H., 81 Prospect St., Brooklyn, N. Y.
- Espey Mfg. Co., Inc., 528 E. 72nd St., New York, N. Y.
- General Photo Products Co., 15 Summit Ave., Chatham, N. J.

- GRAY RESEARCH & DEVELOPMENT CO., INC.**, 16 Arbor St., Hartford, Conn. ADV. PG. 363.
- Hogan Laboratories, Inc., 155 Perry St., New York 14, N. Y.
- McElroy Mfg. Corp., Littleton, Mass.
- Muirhead & Co., Ltd., Beckenham-Kent-England.
- Press Wireless Mfg. Co., Inc., Cantigue Rd., Hicksville.
- TIMES FACSIMILE CORP.**, 540 W. 58th St., New York 19, N. Y. ADV. PG. 288.

RECORDERS—Film

- Daystrom Electric Corp., 837 Main St., Poughkeepsie, N. Y.
- Maurer Inc., J. A., 37-01 31st St., Long Island City, N. Y.
- MILES REPRODUCER CO., INC.**, 812 Broadway, New York 3, N. Y. ADV. PG. 322.
- SOS Cinema Supply Corp., 602 W. 52nd St., New York 19, N. Y.
- Stancil-Hoffman Corp., 1016 N. Highland Ave., Hollywood 38, Calif.
- WESTINGHOUSE ELECTRIC CORP.**, 511 Wood St., P. O. Box 868, Pittsburgh 30, Pa. ADV. PG. 107-113.

RECORDERS—Film Thickness

- Tracerlab, Inc., 130 High St., Boston 10, Mass.

RECORDERS—Fluid Conductivity

- Bailey Meter Co., 1044 Ivanhoe Rd., Cleveland 10, Ohio.
- Esterline-Angus Co., Inc., P. O. Box 596, Indianapolis, Ind.
- Fielden Instrument Corp., 2920 N. 4th St., Philadelphia 33, Pa.
- Foxboro Co., The, Foxboro, Mass.
- Industrial Instruments Inc., 17 Pollack Ave., Jersey City 5, N. J.
- Leeds & Northrup Co., 4970 Stenton Ave., Philadelphia 44, Pa.
- MINNEAPOLIS-HONEYWELL REGULATOR CO., INDUSTRIAL DIV.**, Wayne & Roberts Aves., Philadelphia 44, Pa. ADV. PG. 208, 209.
- Network Mfg. Corp., Bayonne, N. J.
- Thompson & Associates, John E., 7210 S. Yates Ave., Chicago 49, Ill.

RECORDERS—Fluid Flow

- Bailey Meter Co., 1044 Ivanhoe Rd., Cleveland 10, Ohio.
- Bristol Co., The, Waterbury 20, Conn.
- Bunnell & Co., J. H., 81 Prospect St., Brooklyn, N. Y.
- Fielden Instrument Corp., 2920 N. 4th St., Philadelphia 33, Pa.
- Fischer & Porter Co., Hattboro, Pa.
- Manning, Maxwell & Moore, Inc., Stratford, Conn.
- MINNEAPOLIS-HONEYWELL REGULATOR CO., INDUSTRIAL DIV.**, Wayne & Roberts Aves., Philadelphia 44, Pa. ADV. PG. 208, 209.

RECORDERS—Frequency

- Esterline-Angus Co., Inc., P. O. Box 596, Indianapolis, Ind.
- Hathaway Instrument Co., 1315 S. Clarkson St., Denver 10, Colo.
- Leeds & Northrup Co., 4970 Stenton Ave., Philadelphia 44, Pa.
- Nucleonic Corp. of America, 497 Union St., Brooklyn 31, N. Y.
- POLARAD ELECTRONICS CORP.**, 100 Metropolitan Ave., Brooklyn 11, N. Y. ADV. PG. 184, 185.
- POTTER INSTRUMENT CO., INC.**, 115 Cutter Mill Rd., Great Neck, N. Y. ADV. PG. 318.
- RAHM INSTRUMENTS, INC.**, 12 West Broadway, New York 7, N. Y. ADV. PG. 354.
- Sound Apparatus Co., Stirling, N. J.
- Telemark, Inc., 100 Greyrock Pl., Stamford, Conn.
- WESTINGHOUSE ELECTRIC CORP.**, 511 Wood St., P. O. Box 868, Pittsburgh 30, Pa. ADV. PG. 107-113.

RECORDERS—Humidity

- American Instrument Co., 8030 Georgia Ave., Silver Spring, Md.
- Bristol Co., The, Waterbury 20, Conn.
- Fielden Instrument Corp., 2920 N. 4th St., Philadelphia 33, Pa.
- Foxboro Co., The, Foxboro, Mass.
- Friez Instrument Div., Bendix Aviation Corp., Baltimore 4, Md.
- Leeds & Northrup Co., 4970 Stenton Ave., Philadelphia 44, Pa.
- Manning, Maxwell & Moore, Inc., Stratford, Conn.
- MINNEAPOLIS-HONEYWELL REGULATOR CO., INDUSTRIAL DIV.**, Wayne & Roberts Aves., Philadelphia 44, Pa. ADV. PG. 208, 209.

(V) indicates . . . **IN PRODUCTION • AVAILABILITY • UNRESTRICTED FOR GENERAL USE**

- ⓈSerdex Inc., 91 Cambridge St., Boston, Mass.
- ⓈTagliabue Div., Weston Electrical Instrument Corp., 614 Frelinghuysen Ave., Newark 5, N. J.

RECORDERS—Liquid Level

- ⓈBailey Meter Co., 1044 Ivanhoe Rd., Cleveland 10, Ohio.
- ⓈBristol Co., The, Waterbury 20, Conn.
- ⓈBunnell & Co., J. H., 81 Prospect St., Brooklyn, N. Y.
- ⓈEsterline-Angus Co., Inc., P. O. Box 596, Indianapolis 6, Ind.
- ⓈFischer & Porter Co., Hatboro, Pa.
- ⓈFoxboro Co., The, Foxboro, Mass.
- ⓈManning, Maxwell & Moore, Inc., Stratford, Conn.
- ⓈMINNEAPOLIS-HONEYWELL REGULATOR CO., INDUSTRIAL DIV., Wayne & Roberts Aves., Philadelphia 44, Pa. ADV. PG. 208, 209.
- ⓈSERVO-TEK PRODUCTS CO., 4 Godwin Ave., Paterson, N. J. ADV. PG. 356.
- ⓈTagliabue Div., Weston Electrical Instrument Corp., 614 Frelinghuysen Ave., Newark 5, N. J.

RECORDERS—Magnetic Tape

- ⓈAmpex Electric Corp., 1155 Howard Ave., San Carlos, Calif.
- ⓈAmplifier Corp. of America, 398 Broadway, New York 13, N. Y.
- ⓈAmpro Corp., 2835 N. Western Ave., Chicago 18, Ill.
- ⓈArlington Electric Products, Inc., 500 W. 52nd St., New York 19, N. Y.
- ⓈAudio-Master Corp., 341 Madison Ave., New York 17, N. Y.
- ⓈBell Sound Systems, Inc., 555 Marion Rd., Columbus 7, Ohio.
- ⓈBerlant Associates, 4917 W. Jefferson Blvd., Los Angeles 16, Calif.
- ⓈBRUSH DEVELOPMENT CORP., 3405 Perkins Ave., Cleveland 14, Ohio. ADV. PG. 228, 229.
- ⓈCaltron Co., 1406 S. Hobart Blvd., Los Angeles 6, Calif.
- ⓈCook Electric Co., 2700 Southport Ave., Chicago 14, Ill.
- ⓈDavies Laboratories, Inc., The, 4705 Queensbury Rd., Riverdale, Md.
- ⓈDaystrom Electric Corp., 837 Main St., Poughkeepsie, N. Y.
- ⓈEicor, Inc., 1501 W. Congress St., Chicago 7, Ill.
- ⓈFairchild Recording Equipment Co., 154th St. & 7th Ave., Whitestone, N. Y.
- ⓈGeneral Industries Co., Taylor & Olive Sts., Elyria, Ohio.
- ⓈINDIANA STEEL PRODUCTS CO., Valparaiso, Ind. ADV. PG. 154.
- ⓈMAGNECORD, INC., 360 N. Michigan Ave., Chicago 1, Ill. ADV. PG. 40.
- ⓈMaurer, Inc., J. A., 37-01 31st St., Long Island City, N. Y.
- ⓈMILES REPRODUCER CO., INC., 812 Broadway, New York 3, N. Y. ADV. PG. 322.
- ⓈOperadio Mfg. Co., 135th & Indiana Sts., St. Charles, Ill.
- ⓈPERMOFLUX CORP., 4900 W. Grand Ave., Chicago 39, Ill. ADV. PG. 321.
- ⓈPress Wireless Mfg. Co., Inc., Canteiga Rd., Hicksville, N. Y.
- ⓈPRESTO RECORDING CORP., Paramus, N. J. ADV. PG. 52, 53.
- ⓈProctor Soundex Corp., 133 N. 6th Ave., Mt. Vernon, N. Y.
- ⓈRADIO CORP. OF AMERICA, RCA Victor Div., General Offices, Camden, N. J. ADV. PG. 177, Inside Back & Back Covers.
- ⓈRangertone, Inc., 73 Winthrop St., Newark 4, N. J.
- ⓈSimpson Mfg. Co., Inc., Mark, 32-28 49th St., Long Island City 3, N. Y.
- ⓈSoundscriber Corp., 146 Munson St., New Haven 4, Conn.
- ⓈStancil-Hoffman Corp., 1016 N. Highland Ave., Hollywood 38, Calif.
- ⓈWaveforms, Inc., 333 Sixth Ave., New York 14, N. Y.
- ⓈWebster Electric Co., 1900 Clark St., Racine, Wis.
- ⓈWest Coast Electronics Co., 1601 S. Burlington St., Los Angeles 6, Calif.

RECORDERS—Materials Thickness

- ⓈElectric Eye Equipment Co., 16 W. Fairchild St., Danville, Ill.
- ⓈFielden Instrument Corp., 2920 N. 4th St., Philadelphia 33, Pa.
- ⓈGENERAL ELECTRIC CO., Schenectady 5, N. Y. ADV. PG. 1 to 22.
- ⓈKelley-Koett Instrument Co., 962 York St., Cincinnati 14, Ohio.
- ⓈSchaevitz Engineering, Crescent Blvd. at Drexel Ave., Pennsauken Township, Camden 11, N. J.
- ⓈTracerlab, Inc., 130 High St., Boston 10, Mass.

RECORDERS—Mechanical

- ⓈAIR ASSOCIATES, INC., Teterboro, N. J. ADV. PG. 211.
- ⓈAntenna Research Laboratory, Inc., 797 Thomas Lane, Columbus 14, Ohio.

- ⓈBristol Co., The, Waterbury 20, Conn.
- ⓈBunnell & Co., J. H., 81 Prospect St., Brooklyn, N. Y.
- ⓈControl Engineering Corp., 863 Washington St., Canton, Mass.
- ⓈCyclotron Specialties Co., Moraga 8, Calif.
- ⓈFlader, Inc., Frederic, 1330 Laskey Rd., Toledo 12, Ohio.
- ⓈLeeds & Northrup Co., 4970 Stenton Ave., Philadelphia 44, Pa.
- ⓈMILES REPRODUCER CO., INC., 812 Broadway, New York 3, N. Y. ADV. PG. 322.
- ⓈPeerless Instrument Co., 90-15 Corona Ave., Elmhurst, N. Y.
- ⓈSERVO-TEK PRODUCTS CO., 4 Godwin Ave., Paterson, N. J. ADV. PG. 356.
- ⓈStreeter-Ames Corp., 4101 N. Ravenswood Ave., Chicago 13, Ill.

RECORDERS—Moisture

- ⓈFielden Instrument Corp., 2920 N. 4th St., Philadelphia 33, Pa.
- ⓈFoxboro Co., The, Foxboro, Mass.
- ⓈGENERAL ELECTRIC CO., Schenectady 5, N. Y. ADV. PG. 1 to 22.
- ⓈGordon Co., Claud S., 3000 S. Wallace St., Chicago 16, Ill.
- ⓈMARCONI INSTRUMENTS, LTD., 23 Beaver St., New York 4, N. Y. ADV. PG. 270.
- ⓈMINNEAPOLIS-HONEYWELL REGULATOR CO., INDUSTRIAL DIV., Wayne & Roberts Aves., Philadelphia 44, Pa. ADV. PG. 208, 209.
- ⓈTagliabue Div., Weston Electrical Instrument Corp., 614 Frelinghuysen Ave., Newark 5, N. J.

RECORDERS—Nuclear Radiation

- ⓈAlfax Paper & Engrg. Co., Washington St., P. O. Box 125, Westboro, Mass.
- ⓈAnton Electronic Laboratories, Inc., 1226-1238 Flushing Ave., Brooklyn 6, N. Y.
- ⓈATOMIC INSTRUMENT CO., 84 Massachusetts Ave., Cambridge 39, Mass. ADV. PG. 410.
- ⓈBerkeley Scientific Corp., 2200 Wright Ave., Richmond, Calif.
- ⓈCyclotron Specialties Co., Moraga 8, Calif.
- ⓈDouglas Radio Labs., 176 Norfolk Ave., Boston 19, Mass.
- ⓈElectronic Products Co., 111 E. Third St., Mt. Vernon, N. Y.
- ⓈEL-TRONICS, INC., 2649 N. Howard St., Philadelphia 33, Pa. ADV. PG. 299.
- ⓈKelley-Koett Instrument Co., 962 York St., Cincinnati 14, Ohio.
- ⓈLoudon Instruments, Inc., 5644 Lake Park Ave., Chicago 37, Ill.
- ⓈMacdonald & Co., Inc., W. S., 33 University Rd., Cambridge 38, Mass.
- ⓈNuclear Instrument & Chemical Corp., 223 W. Erie St., Chicago 10, Ill.
- ⓈNuclear Measurements Corp., 3339 Central Ave., Indianapolis 5, Ind.
- ⓈNuclear Research Corp., 2707 Federal St., Philadelphia 46, Pa.
- ⓈNucleonic Corp. of America, The, 497 Union St., Brooklyn 31, N. Y.
- ⓈPOTTER INSTRUMENT CO, INC., 115 Cutter Mill Rd., Great Neck, N. Y. ADV. PG. 318.
- ⓈR-C Scientific Instrument Co., 335 Culver Blvd., Playa Del Rey, Calif.
- ⓈRadiation Counter Laboratories, Inc., 1844 W. 21st St., Chicago 8, Ill.
- ⓈSpecial Instruments Laboratories, Inc., 1003 Highland Ave., Knoxville, Tenn.
- ⓈTechnical Associates, 3730 San Fernando Rd., Glendale 4, Calif.
- ⓈTracerlab, Inc., 130 High St., Boston 10, Mass.

RECORDERS—Oxygen

- ⓈBailey Meter Co., 1044 Ivanhoe Rd., Cleveland 10, Ohio.
- ⓈLeeds & Northrup Co., 4970 Stenton Ave., Philadelphia 44, Pa.
- ⓈPhotocon Research Products, 1062 N. Allen Ave., Pasadena 7, Calif.

RECORDERS—pH

- ⓈBailey Meter Co., 1044 Ivanhoe Road, Cleveland 10, Ohio.
- ⓈBeckman Instruments, Inc., 820 Mission St., South Pasadena, Calif.
- ⓈBristol Co., The, Waterbury 20, Conn.
- ⓈFoxboro Co., The, Foxboro, Mass.
- ⓈHEILAND RESEARCH CORP., 130 E. Fifth Ave., Denver 9, Colo. ADV. PG. 401.
- ⓈLeeds & Northrup Co., 4970 Stenton Ave., Philadelphia 44, Pa.
- ⓈMARCONI INSTRUMENTS LTD., 23 Beaver St., New York 4, N. Y. ADV. PG. 270.
- ⓈMINNEAPOLIS-HONEYWELL REGULATOR CO., INDUSTRIAL DIV., Wayne & Roberts Aves., Philadelphia 44, Pa. ADV. PG. 208, 209.

RECORDERS—Potentiometer

- ⓈBailey Meter Co., 1044 Ivanhoe Rd., Cleveland 10, Ohio.
- ⓈBeckman Instruments, Inc., 820 Mission St., South Pasadena, Calif.
- ⓈBristol Co., The, Waterbury 20, Conn.
- ⓈEDIN CO., INC., 207 Main St., Worcester, Mass. ADV. PG. 285.
- ⓈElectronic Associates, Inc., Long Branch, N. J.
- ⓈFoxboro Co., The, Foxboro, Mass.
- ⓈGENERAL ELECTRIC CO., Schenectady 5, N. Y. ADV. PG. 1 to 22.
- ⓈLeeds & Northrup Co., 4970 Stenton Ave., Philadelphia 44, Pa.
- ⓈManning, Maxwell & Moore, Inc., Stratford, Conn.
- ⓈMINNEAPOLIS-HONEYWELL REGULATOR CO., INDUSTRIAL DIV., Wayne & Roberts Aves., Philadelphia 44, Pa. ADV. PG. 208, 209.
- ⓈSound Apparatus Co., Stirling, N. J.
- ⓈTagliabue Div., Weston Electrical Instrument Corp., 614 Frelinghuysen Ave., Newark 5, N. J.
- ⓈThwing-Albert Instrument Co., 5351 Pulaski Ave., Philadelphia 44, Pa.

RECORDERS—Power Level

- ⓈLeeds & Northrup Co., 4970 Stenton Ave., Philadelphia 44, Pa.
- ⓈSound Apparatus Co., Stirling, N. J.

RECORDERS—Pressure

- ⓈBailey Meter Co., 1044 Ivanhoe Road, Cleveland 10, Ohio.
- ⓈBristol Co., The, Waterbury 20, Conn.
- ⓈEsterline-Angus Co., Inc., P.O. Box 596, Indianapolis, Ind.
- ⓈFielden Instrument Corp., 2920 N. 4th St., Philadelphia 33, Pa.
- ⓈFischer & Porter Co., Hatboro, Pa.
- ⓈFlader, Inc., Fredric, 1330 Laskey Rd., Toledo 12, Ohio.
- ⓈGorrell & Gorrell, Haworth, N. J.
- ⓈHathaway Instrument Co., 1315 S. Clarkson St., Denver 10, Colo.
- ⓈLeeds & Northrup Co., 4970 Stenton Ave., Philadelphia 44, Pa.
- ⓈManning, Maxwell & Moore, Inc., Stratford, Conn.
- ⓈMINNEAPOLIS-HONEYWELL REGULATOR CO., INDUSTRIAL DIV., Wayne & Roberts Aves., Philadelphia 44, Pa. ADV. PG. 208, 209.
- ⓈPhotocon Research Products, 1062 N. Allen Ave., Pasadena 7, Calif.
- ⓈSANBORN CO., 39 Osborn St., Cambridge 39, Mass. ADV. PG. 391.
- ⓈTagliabue Div., Weston Electrical Instrument Corp., 614 Frelinghuysen Ave., Newark 5, N. J.
- ⓈTechnitrol Engineering Co., 3211 Woodland Ave., Philadelphia 4, Pa.
- ⓈWeksler Thermometer Corp., 52 W. Houston St., New York 12, N. Y.

RECORDERS—Smoke and Combustion

- ⓈBailey Meter Co., 1044 Ivanhoe Rd., Cleveland 10, Ohio.
- ⓈElectronic Control Corp., 1573 E. Forest St., Detroit, Mich.
- ⓈEss Specialty Corp., 96 So. Washington Ave., Bergenfield, N. J.
- ⓈLeeds & Northrup Co., 4970 Stenton Ave., Philadelphia 44, Pa.

RECORDERS—Sound Level

- ⓈAudio Instrument Co., 133 W. 14th St., New York 11, N. Y.
- ⓈBRUSH DEVELOPMENT CO., 3405 Perkins Ave., Cleveland 14, Ohio. ADV. PG. 228, 229.
- ⓈEDIN CO., INC., 207 Main St., Worcester, Mass. ADV. PG. 285.
- ⓈKAY ELECTRIC CO., 14 Maple Ave., Pine Brook, N. J. ADV. PG. 340.
- ⓈMILES REPRODUCER CO., INC., 812 Broadway, New York 3, N. Y. ADV. PG. 322.
- ⓈSound Apparatus Co., Stirling, N. J.
- ⓈStandard Telephones & Cables Ltd., Connaught House, Aldwych, London, W. C. 2, England.
- ⓈWestern Sound & Electric Labs., Inc., 805 S. Fifth St., Milwaukee 4, Wis.

RECORDERS—Sound and Phonograph

- ⓈAudak Co., 500 Fifth Ave., New York, N. Y.
- ⓈAudio Industries, Michigan City, Ind.
- ⓈAudio-Master Corp., 341 Madison Ave., New York 17, N. Y.
- ⓈBell Sound Systems, Inc., 555 Marion Rd., Columbus 7, Ohio.
- ⓈBerndt-Bach, Inc., 7373 Beverly Blvd., Los Angeles 36, Calif.
- ⓈCook Laboratories, 139 Gordon Blvd., Floral Park, N. Y.
- ⓈFairchild Recording Equipment Co., 154th St. & 7th Ave., Whitestone, N. Y.
- ⓈGates Radio Co., Quincy, Ill.

Ⓢ indicates . . . IN PRODUCTION • AVAILABILITY • UNRESTRICTED FOR GENERAL USE

- Ⓢ General Industries Co., Taylor & Olive Sts., Elyria, Ohio.
- Ⓢ KAY ELECTRIC CO., 14 Maple Ave., Pine Brook, N. J. ADV. PG. 340.
- Ⓢ Lipps, Edwin A., 1781 Rimpau Blvd., Los Angeles 6, Calif.
- Ⓢ MILES REPRODUCER CO., INC., 812 Broadway, New York 3, N. Y. ADV. PG. 322.
- Ⓢ Rek-O-Kut Co., Inc., 38-01 Queens Blvd., Long Island City, N. Y.
- Ⓢ Scully Machine Co., 62 Walter St., Bridgeport, Conn.
- Ⓢ Simpson Mfg. Co., Inc., Mark, 32-28 49th St., Long Island City 3, N. Y.
- Ⓢ Soundscriber Corp., 146 Munson St., New Haven 4, Conn.
- Ⓢ Webster-Chicago Corp., 5622 Bloomingdale Ave., Chicago 39, Ill.

RECORDERS—Specific Gravity

- Ⓢ Fielden Instrument Corp., 2920 N. 4th St., Philadelphia 33, Pa.
- Ⓢ Fischer & Porter Co., Hatboro, Pa.
- Ⓢ Leeds & Northrup Co., 4970 Stenton Ave., Philadelphia 44, Pa.
- Ⓢ MINNEAPOLIS-HONEYWELL REGULATOR CO., INDUSTRIAL DIV., Wayne & Roberts Aves., Philadelphia 44, Pa. ADV. PG. 208, 209.

RECORDERS—Strain

- Ⓢ Baldwin-Lima-Hamilton Corp., Paschall P.O. Station, Philadelphia 42, Pa.
- Ⓢ BRUSH DEVELOPMENT CO., 3405 Perkins Ave., Cleveland 14, Ohio. ADV. PG. 228, 229.
- Ⓢ Century Geophysical Corp., 133 N. Utica, Tulsa 3, Okla.
- Ⓢ EDIN CO., INC., 207 Main St., Worcester, Mass. ADV. PG. 285.
- Ⓢ ELECTRONIC TUBE CORP., 1200 E. Mermaid Ave., Philadelphia 18, Pa. ADV. PG. 335.
- Ⓢ Hathaway Instrument Co., 1315 S. Clarkson St., Denver 10, Colo.
- Ⓢ HEILAND RESEARCH CORP., 130 E. 5th Ave., Denver 9, Colo. ADV. PG. 401.
- Ⓢ Leeds & Northrup Co., 4970 Stenton Ave., Philadelphia 44, Pa.
- Ⓢ Midwestern Geophysical Laboratory, 3400 S. Harvard, Tulsa, Okla.
- Ⓢ Offner Electronics, Inc., 5320 N. Kedzie Ave., Chicago 25, Ill.
- Ⓢ Photon Instrument Co., 6516 Detroit Ave., Cleveland 2, Ohio.
- Ⓢ SANBORN CO., 39 Osborn St., Cambridge 39, Mass. ADV. PG. 391.
- Ⓢ Sound Apparatus Co., Stirling, N. J.

RECORDERS—Tape

- Ⓢ Ampex Electric Corp., 1155 Howard Ave., San Carlos, Calif.
- Ⓢ Ampro Corp., 2835 North Western Ave., Chicago 18, Ill.
- Ⓢ ATOMIC INSTRUMENT CO., 84 Massachusetts Ave., Cambridge 39, Mass. ADV. PG. 410.
- Ⓢ Bell Sound Systems, Inc., 555 Marion Rd., Columbus 7, Ohio.
- Ⓢ Berlant Associates, 4917 W. Jefferson Blvd., Los Angeles 16, Calif.
- Ⓢ BRUSH DEVELOPMENT CO., 3405 Perkins Ave., Cleveland 14, Ohio. ADV. PG. 228, 229.
- Ⓢ Bunnell & Co., J. H., 81 Prospect St., Brooklyn, N. Y.
- Ⓢ Califone Corp., 1041 N. Sycamore Ave., Hollywood 38, Calif.
- Ⓢ Cook Electric Co., 2700 Southport Ave., Chicago 14, Ill.
- Ⓢ Crestwood Recorder Corp., 221 N. La Salle, Chicago 1, Ill.
- Ⓢ Dalmo Victor Co., 1414 El Camino Real, San Carlos, Calif.
- Ⓢ Davies Laboratories, Inc., The, 4705 Queensbury Rd., Riverdale, Md.
- Ⓢ Daystrom Electric Corp., 837 Main St., Poughkeepsie, N. Y.
- Ⓢ Fairchild Recording Equipment Co., 154th St. & 7th Avenue, Whitestone, N. Y.
- Ⓢ Fisher Radio Corp., 41 E. 47th St., New York, N. Y.
- Ⓢ General Cement Mfg. Co., 919 Taylor Ave., Rockford, Ill.
- Ⓢ General Industries Co., Taylor & Olive Sts., Elyria, Ohio.
- Ⓢ McElroy Mfg. Corp., Littleton, Mass.
- Ⓢ MAGNECORD, INC., 360 N. Michigan Ave., Chicago 1, Ill. ADV. PG. 40.
- Ⓢ Magnetic Recorders Co., 7120 Melrose St., Los Angeles, Calif.
- Ⓢ Maurer, Inc., J. A., 37-01 31st St., Long Island City, N. Y.
- Ⓢ MILES REPRODUCER CO., INC., 812 Broadway, New York 3, N. Y. ADV. PG. 322.
- Ⓢ Operadio Mfg. Co., 135th & Indiana Sts., St. Charles, Ill.
- Ⓢ Pentron Corp., The, 221 E. Cullerton St., Chicago 16, Ill.
- Ⓢ PERMOFLUX CORP., 4900 W. Grand Ave., Chicago 39, Ill. ADV. PG. 321.

- Ⓢ Press Wireless Mfg. Co., Inc., Cantiague Rd., Hicksville, N. Y.
- Ⓢ Proctor Soundex Corp., 133 N. 6th Ave., Mt. Vernon, N. Y.
- Ⓢ Revere Camera Co., 320 E. 21st St., Chicago 16, Ill.
- Ⓢ Simpson Mfg. Co., Inc., Mark, 32-28 49th St., Long Island City 3, N. Y.
- Ⓢ Sonar Radio Corp., 59 Myrtle Ave., Brooklyn 1, N. Y.
- Ⓢ Stancil-Hoffman Corp., 1016 N. Highland Ave., Hollywood, Calif.
- Ⓢ Webster Electric Co., 1900 Racine, Wis.

RECORDERS—Telemetering

- Ⓢ AIR ASSOCIATES, INC., Teterboro, N. J. ADV. PG. 211.
- Ⓢ Ampex Electric Corp., 1155 Howard Ave., San Carlos, Calif.
- Ⓢ ATOMIC INSTRUMENT CO., 84 Massachusetts Ave., Cambridge 39, Mass. ADV. PG. 410.
- Ⓢ Bailey Meter Co., 1044 Ivanhoe Road, Cleveland 10, Ohio.
- Ⓢ Bristol Co., The, Waterbury 20, Conn.
- Ⓢ Davies Laboratories, Inc., The, 4705 Queensbury Rd., Riverdale, Md.
- Ⓢ Esterline-Angus Co., Inc., P.O. Box 596, Indianapolis, Ind.
- Ⓢ Fairchild Recording Equipment Co., 154th St. & Seventh Ave., Whitestone, N. Y.
- Ⓢ Friez Instrument Div., Bendix Aviation Corp., Baltimore 4, Md.
- Ⓢ Leeds & Northrup Co., 4970 Stenton Ave., Philadelphia 44, Pa.
- Ⓢ Miller Corp., William, 325 N. Halstead St., Pasadena 8, Calif.
- Ⓢ MINNEAPOLIS-HONEYWELL REGULATOR CO., INDUSTRIAL DIV., Wayne & Roberts Aves., Philadelphia 44, Pa. ADV. PG. 208, 209.
- Ⓢ POTTER INSTRUMENT CO., INC., 115 Cutter Mill Rd., Great Neck, N. Y. ADV. PG. 318.
- Ⓢ Stancil-Hoffman Corp., 1016 N. Highland Ave., Hollywood, Calif.
- Ⓢ Thompson & Associates, John E., 7210 Yates Ave., Chicago 49, Ill.

RECORDERS—Telephone Recording Equipment

- Ⓢ Amplifier Corp. of America, 398 Broadway, New York 13, N. Y.
- Ⓢ Connecticut Telephone & Electric Corp., 70 Brittanis St., Meriden, Conn.
- Ⓢ Daystrom Electric Corp., 837 Main St., Poughkeepsie, N. Y.
- Ⓢ Dictaphone Corp., 420 Lexington Ave., New York 17, N. Y.
- Ⓢ Edison Inc., Thomas A., 51 Lakeside Ave., West Orange, N. J.
- Ⓢ MILES REPRODUCER CO., INC., 812 Broadway, New York 3, N. Y. ADV. PG. 322.
- Ⓢ Peirce Wire Recorder Corp., 1328 Sherman Ave., Evanston, Ill.
- Ⓢ Rangertone, Inc., 73 Winthrop St., Newark 4, N. J.
- Ⓢ Soundscriber Corp., 146 Munson St., New Haven 4, Conn.
- Ⓢ Stancil-Hoffman Corp., 1016 N. Highland Ave., Hollywood 38, Calif.

RECORDERS—Temperature

- Ⓢ Bailey Meter Co., 1044 Ivanhoe Road, Cleveland 10, Ohio.
- Ⓢ Bristol Co., The, Waterbury 20, Conn.
- Ⓢ EDIN CO., INC., 207 Main St., Worcester, Mass. ADV. PG. 285.
- Ⓢ Electronic Control Corp., 1573 E. Forest St., Detroit, Mich.
- Ⓢ Fischer & Porter Co., Hatboro, Pa.
- Ⓢ Foxboro Co., The, Foxboro, Mass.
- Ⓢ GENERAL ELECTRIC CO., Schenectady 5, N. Y. ADV. PG. 1 to 22.
- Ⓢ Gordon Co., Claud S., 3000 S. Wallace St., Chicago 16, Ill.
- Ⓢ Hathaway Instrument Co., 1315 S. Clarkson St., Denver 10, Colo.
- Ⓢ Leeds & Northrup Co., 4970 Stenton Ave., Philadelphia 44, Pa.
- Ⓢ Manning, Maxwell & Moore, Inc., Stratford, Conn.
- Ⓢ Midwestern Geophysical Laboratory, 3400 S. Harvard, Tulsa, Okla.
- Ⓢ MINNEAPOLIS-HONEYWELL REGULATOR CO., INDUSTRIAL DIV., Wayne & Roberts Aves., Philadelphia 44, Pa. ADV. PG. 208, 209.
- Ⓢ SANBORN CO., 39 Osborn St., Cambridge 39, Mass. ADV. PG. 391.
- Ⓢ Serdex, Inc., 91 Cambridge St., Boston, Mass.
- Ⓢ Tagliabue Div., Weston Electrical Instrument Corp., 614 Frelinghuysen Ave., Newark 5, N. J.
- Ⓢ Thwing-Albert Instrument Co., 5351 Pulaski Ave., Philadelphia 44, Pa.
- Ⓢ Weksler Thermometer Corp., 52 W. Houston St., New York 12, N. Y.

RECORDERS—Timing

- Ⓢ Bludworth Marine Div., National-Simplex-Bludworth, Inc., 92 Gold St., New York 38, N. Y.
- Ⓢ Bristol Co., The, Waterbury 20, Conn.

- Ⓢ Cyclotron Specialties Co., Moraga 8, Calif.
- Ⓢ Engineering Lab., Inc., 602 E. 4th St., Tulsa 3, Okla.
- Ⓢ Foxboro Co., The, Foxboro, Mass.
- Ⓢ Hathaway Instrument Co., 1315 S. Clarkson St., Denver 10, Colo.
- Ⓢ HAYDON CO., A. W., 232 N. Elm St., Waterbury 20, Conn. ADV. PG. 402.
- Ⓢ POTTER INSTRUMENT CO., INC., 115 Cutter Mill Rd., Great Neck, N. Y. ADV. PG. 318.
- Ⓢ Special Instruments Laboratories, Inc., 1003 Highland Ave., Knoxville, Tenn.
- Ⓢ Streeter-Amet Corp., 4101 N. Ravenswood Ave., Chicago 13, Ill.
- Ⓢ Tagliabue Div., Weston Electrical Instrument Corp., 614 Frelinghuysen Ave., Newark 5, N. J.

RECORDERS—Torque

- Ⓢ Baldwin-Lima-Hamilton Corp., Paschall P. O. Station, Philadelphia 42, Pa.
- Ⓢ EDIN CO., INC., 207 Main St., Worcester, Mass. ADV. PG. 285.
- Ⓢ Hathaway Instrument Co., 1315 S. Clarkson St., Denver 10, Colo.
- Ⓢ Midwestern Geophysical Laboratory, 3400 S. Harvard, Tulsa, Okla.
- Ⓢ SANBORN CO., 39 Osborn St., Cambridge 39, Mass. ADV. PG. 391.

RECORDERS—Vacuum

- Ⓢ Bailey Meter Co., 1044 Ivanhoe Rd., Cleveland 10, Ohio.
- Ⓢ Bristol Co., The, Waterbury 20, Conn.
- Ⓢ Distillation Products Industries Div. of Eastman Kodak Co., 755 Ridge Rd., W., Rochester 3, N. Y.
- Ⓢ Esterline-Angus Co., Inc., P. O. Box 596, Indianapolis, Ind.
- Ⓢ Fredericks Co., Geo. E., Bethayres, Pa.
- Ⓢ Hastings Instrument Co., Inc., Hampton 9, Va.
- Ⓢ Hathaway Instrument Co., 1315 S. Clarkson St., Denver 10, Colo.
- Ⓢ Manning, Maxwell & Moore, Inc., Stratford, Conn.
- Ⓢ MINNEAPOLIS-HONEYWELL REGULATOR CO., INDUSTRIAL DIV., Wayne & Roberts Aves., Philadelphia 44, Pa. ADV. PG. 208, 209.
- Ⓢ Stokes Machine Co., F. J., 5850 Tabor Rd., Olney P. O., Philadelphia 20, Pa.
- Ⓢ Tagliabue Div., Weston Electrical Instrument Corp., 614 Frelinghuysen Ave., Newark 5, N. J.
- Ⓢ Technitrol Engineering Co., 3211 Woodland Ave., Philadelphia 4, Pa.
- Ⓢ Weksler Thermometer Corp., 52 W. Houston St., New York 12, N. Y.
- Ⓢ Winslow Co., Inc., 9 Liberty St., Newark 5, N. J.

RECORDERS—Weight

- Ⓢ Baldwin-Lima-Hamilton Corp., Paschall P. O. Station, Philadelphia 42, Pa.
- Ⓢ BRUSH DEVELOPMENT CO., 3405 Perkins Ave., Cleveland 14, Ohio. ADV. PG. 228, 229.
- Ⓢ Hathaway Instrument Co., 1315 S. Clarkson St., Denver 10, Colo.
- Ⓢ Leeds & Northrup Co., 4970 Stenton Ave., Philadelphia 44, Pa.
- Ⓢ SANBORN CO., 39 Osborn St., Cambridge 39, Mass. ADV. PG. 391.

RECORDERS—Wire

- Ⓢ Crescent Industries, Inc., 4140 Belmont Ave., Chicago 41, Ill.
- Ⓢ Daystrom Electric Corp., 837 Main St., Poughkeepsie, N. Y.
- Ⓢ Electro Engineering & Mfg. Co., 627 W. Alexandrine Ave., Detroit 1, Mich.
- Ⓢ General Cement Mfg. Co., 919 Taylor Ave., Rockford, Ill.
- Ⓢ Lear, Inc., 110 Ionia Ave., N. W., Grand Rapids 2, Mich.
- Ⓢ MAGNECORD, INC., 360 N. Michigan Ave., Chicago 1, Ill. ADV. PG. 40.
- Ⓢ Molded Insulation Co., 335 E. Price St., Philadelphia, Pa.
- Ⓢ Monarch Radio & Television Corp., 2430 Atlantic Ave., Brooklyn 33, N. Y.
- Ⓢ Peirce Wire Recorder Corp., 1328 Sherman Ave., Evanston, Ill.
- Ⓢ Webster-Chicago Corp., 5622 Bloomingdale Ave., Chicago 39, Ill.

RECORDING HEADS See Heads, Recording

RECORDS—Phonograph

- Ⓢ Audak Co., 500 Fifth Ave., New York, N. Y.
- Ⓢ Audio-Master Corp., 341 Madison Ave., New York 17, N. Y.
- Ⓢ Commodore Record Co., 289 Nepperhan Ave., Yonkers 2, N. Y.
- Ⓢ Cook Laboratories, 139 Gordon Blvd., Floral Park, N. Y.

V indicates . . . IN PRODUCTION • AVAILABILITY • UNRESTRICTED FOR GENERAL USE

- Decca Records, Inc., 50 West 57th St., New York 19, N. Y.
- Insuline Corp. of America, 36-02 35th Ave., Long Island City, N. Y.
- Poinsettia Co., Inc., 95 Cedar Ave., Pitman, N. J.
- RADIO CORP. OF AMERICA**, RCA Victor Div., Home Instrument Dept., Camden, N. J. ADV. PG. 177, Inside Back & Back Covers.
- Tempo Record Co. of America, 8540 Sunset Blvd., Hollywood 46, Calif.

RECTIFIERS—Crystal

- Berkshire Laboratories, 580 Lexington Rd., Concord, Mass.
- Philco Corp., Tioga & C Sts., Philadelphia 34, Pa.
- Standard Telephones & Cables Ltd., Connaught House, Aldwych, London, W. C. 2, England.
- SYLVANIA ELECTRIC PRODUCTS, INC.**, 1740 Broadway, New York 19, N. Y. ADV. PG. 432-436.

RECTIFIERS—Copper Oxide, Copper Sulphide or Selenium

See Rectifiers—Metallic

RECTIFIERS—Metallic

- AMERICAN TELEVISION & RADIO CO.**, 300 E. Fourth St., St. Paul 1, Minn. ADV. PG. 266.
- Bart-Messing Corp., 227 Main St., Belleville 9, N. J.
- BRADLEY LABS, INC.**, 82 Meadow St., New Haven 10, Conn. ADV. PG. 349.
- Clark Electronic Labs., Box 165, Palm Springs, Calif.
- Conant Labs., 6500 O St., Lincoln 5, Nebr.
- Electron Equipment Corp., 917 Meridian Ave., South Pasadena, Calif.
- Electronic Control Co., 3124 Avenue L, Brooklyn 10, N. Y.
- Fansteel Metallurgical Corp., 2200 Sheridan Rd., North Chicago, Ill.
- FEDERAL TELEPHONE AND RADIO CORP.**, 88 Kingsland Rd., Clifton, N. J. ADV. PG. 161-163.
- GENERAL ELECTRIC CO.**, Schenectady 5, N. Y. ADV. PG. 1 to 22.
- Good-All Electric Mfg. Co., 112 W. First St., Ogallala, Neb.
- Green Electric Co., W., 130 Cedar St., New York, N. Y.
- Inet, Inc., 8655 S. Main St., Los Angeles 3, Calif.
- International Rectifier Corp., 6809 S. Victoria Ave., Los Angeles 43, Calif.
- Kctron Rectifier Corp., A Standard Arcturus Affiliate, 54 Clark St., Newark 4, N. J.
- LAMBDA ELECTRONICS CORP.**, 103-02 Northern Blvd., Corona, N. Y. ADV. PG. 374.
- Mallory & Co., Inc., P. R., 3029 E. Washington St., Indianapolis 6, Ind.
- McColpin-Christie Corp., 3410 W. 67th St., Los Angeles 43, Calif.
- Melco Products, Inc., 22 E. Hennepin Ave., Minneapolis 1, Minn.
- Mellaphone Corp., Rochester 2, N. Y.
- OPAD-GREEN CO.**, 71-5 Warren St., New York 7, N. Y. ADV. PG. 314.
- Peschel Electronics, Inc., 13 Garden St., New Rochelle, N. Y.
- Philco Corp., Tioga & C Sts., Philadelphia 34, Pa.
- PRECISION RECTIFIER CORP.**, 193 Grand St., Brooklyn 11, N. Y. ADV. PG. 370.
- RADIO RECEPTOR CO.**, 251 W. 19th St., New York 11, N. Y. ADV. PG. 250.
- RICHARDSON-ALLEN CORP.**, 116-15 15th Ave., College Point, N. Y. ADV. PG. 414.
- Sarkes Tarzian Tube Div., 214 Central Ave., Hawthorne, N. J.
- Schauer Mfg. Corp., 2119 Reading Rd., Cincinnati 2, Ohio.
- Standard Telephones & Cables Ltd., Connaught House, Aldwych, London, W. C. 2, England.
- STANDARD TRANSFORMER CORP.**, Elston, Kedzie & Addison, Chicago 18, Ill. ADV. PG. 144.
- SYLVANIA ELECTRIC PRODUCTS, INC.**, 1740 Broadway, New York 19, N. Y. ADV. PG. 432-436.
- Syntro Co., 243 Lexington, Homer City, Pa.
- Ther Electric & Machine Works, 15 S. Jefferson St., Chicago 11, Ill.
- Vickers Electric Div., Vickers, Inc., 1815 Locust St., St. Louis 3, Mo.
- WESTINGHOUSE ELECTRIC CORP.**, 511 Wood St., P. O. Box 868, Pittsburgh 30, Pa. ADV. PG. 107-113.

RECTIFIERS—Tube Rectifying Units

- AMERICAN ELECTRONIC CORP.**, 5025-29 W. Jefferson Blvd., Los Angeles 16, Calif. ADV. PG. 136.
- Bart-Messing Corp., 227 Main St., Belleville 9, N. J.
- Clark Electronic Labs., Box 165, Palm Springs, Calif.
- COMMUNICATION MEASUREMENTS LAB, INC.**, 120 Greenwich St., New York 6, N. Y. ADV. PG. 290.

- Coronet Radio & Television Corp., 500 West 52nd St., New York 19, N. Y.
- ECLIPSE-PIONEER DIV.**, Bendix Aviation Corp., Teterboro, N. J. ADV. PG. 198, 199.
- Electricoil Transformer Co., Westerly Rd., Ossining, N. Y.
- Electron Equipment Corp., 917 Meridian Ave., South Pasadena, Calif.
- Electronic Engineering Corp.**, 469 Elm St., Arlington, N. J.
- Gates Radio Co., Quincy, Ill.
- Gaveco Labs., Inc., 2 East End Ave., New York 21, N. Y.
- GENERAL ELECTRIC CO.**, Schenectady 5, N. Y. ADV. PG. 1 to 22.
- Green Electric Co., W., 130 Cedar St., New York, N. Y.
- Heller Co., Gerald K., 1542 Ridgely St., Baltimore 30, Md.
- KEPCO LABS, INC.**, 149-14 41st Ave., Flushing, N. Y. ADV. PG. 54.
- LAMBDA ELECTRONICS CORP.**, 103-02 Northern Blvd., Corona, N. Y. ADV. PG. 374.
- McColpin-Christie Corp., 3410 W. 67th St., Los Angeles 43, Calif.
- Mellaphone Corp., Rochester 2, N. Y.
- Radiomarine Corp. of America, 75 Varick St., New York 13, N. Y.
- RICHARDSON-ALLEN CORP.**, 116-15 15th Ave., College Point, N. Y. ADV. PG. 414.
- SORENSEN & CO, INC.**, 375 Fairfield Ave., Stamford, Conn. ADV. PG. 66, 67.
- SYLVANIA ELECTRIC PRODUCTS, INC.**, 1740 Broadway, New York 19, N. Y. ADV. PG. 432-436.
- Ther Electric & Machine Works, 15 S. Jefferson St., Chicago 11, Ill.
- WESTINGHOUSE ELECTRIC CORP.**, 511 Wood St., P. O. Box 868, Pittsburgh 30, Pa. ADV. PG. 107-113.
- Z & W Machine Products, Inc., 5151 St. Clair Ave., Cleveland 3, Ohio.

REGULATORS—Current

- AMPERITE CO., INC.**, 561 Broadway, New York 12, N. Y. ADV. PG. 323.
- Clark Electronic Labs., Box 165, Palm Springs, Calif.
- Electric Regulator Corp., 1938 Park Ave., New York 35, N. Y.
- Gaveco Labs., Inc., 2 East End Ave., New York 21, N. Y.
- GENERAL ELECTRIC CO.**, Schenectady 5, N. Y. ADV. PG. 1 to 22.
- Inet, Inc., 8655 S. Main St., Los Angeles 3, Calif.
- KEPCO LABS, INC.**, 149-14 41st Ave., Flushing, N. Y. ADV. PG. 54.
- LAMBDA ELECTRONICS CORP.**, 103-02 Northern Blvd., Corona, N. Y. ADV. PG. 374.
- MAGNETIC AMPLIFIERS, INC.**, 1154 44th Drive, Long Island City 1, N. Y. ADV. PG. 346.
- SORENSEN & CO, INC.**, 375 Fairfield Ave., Stamford, Conn. ADV. PG. 66, 67.
- Thordarson-Meissner Mfg. Divisions, 500 W. Huron St., Chicago 10, Ill.
- Weltronic Co., 19500 West 8 Mile Rd., Detroit 19, Mich.
- WESTINGHOUSE ELECTRIC CORP.**, 511 Wood St., P. O. Box 868, Pittsburgh 30, Pa. ADV. PG. 107-113.

REGULATORS—Frequency

- AMERICAN TIME PRODUCTS, INC.**, 580 Fifth Ave., New York 19, N. Y. ADV. PG. 226.
- Burlington Instrument Co., Burlington, Iowa.
- Electric Regulator Corp., 1938 Park Ave., New York 35, N. Y.
- Gaveco Labs., Inc., 2 East End Ave., New York 21, N. Y.
- GENERAL ELECTRIC CO.**, Schenectady 5, N. Y. ADV. PG. 1 to 22.
- Inet, Inc., 8655 S. Main St., Los Angeles 3, Calif.
- MAGNETIC AMPLIFIERS, INC.**, 1154 44th Drive, Long Island City 1, N. Y. ADV. PG. 346.
- Robinette Co., W. C. 802 Fair Oaks Ave., S. Pasadena, Calif.
- Weltronic Co., 19500 W. Eight Mile Rd., Detroit 19, Mich.
- WESTINGHOUSE ELECTRIC CORP.**, 511 Wood St., P. O. Box 868, Pittsburgh 30, Pa. ADV. PG. 107-113.

REGULATORS—Voltage Regulators and Stabilizers

- ACME ELECTRIC CORP.**, 31 Water St., Cuba, N. Y. ADV. PG. 90.
- Aerolux Light Corp., 653 11th Ave., New York 19, N. Y.
- AIRMEC LABORATORIES, LTD.**, 366 Madison Ave., New York 17, N. Y. ADV. PG. 336.
- AMERICAN ELECTRONIC CORP.**, 5025-29 W. Jefferson Blvd., Los Angeles 16, Calif. ADV. PG. 136.
- Anton Electronic Labs., Inc., 1226-1238 Flushing Ave., Brooklyn 6, N. Y.
- BOONTON RADIO CORP.**, Boonton, N. J. ADV. PG. 96.

- Burlington Instrument Co., Burlington, Iowa.
- Clark Electronic Labs., Box 165, Palm Springs, Calif.
- Crest Transformer Corp., 1834-36 W. North Ave., Chicago 22, Ill.
- Doelcam Corp., 56 Elmwood St., Newton 58, Mass.
- ECLIPSE-PIONEER DIV.**, Bendix Aviation Corp., Teterboro, N. J. ADV. PG. 198, 199.
- Electric Machinery Mfg. Co., 1331 N. E. Tyler St., Minneapolis 13, Minn.
- Electric Regulator Corp., 1938 Park Ave., New York 35, N. Y.
- Electro Engineering Works, 6021 College Ave., Oakland 18, Calif.
- Electronic Products Co., 111 E. Third St., Mt. Vernon, N. Y.
- FEDERAL TELEPHONE & RADIO CORP.**, 88 Kingsland Rd., Clifton, N. J. ADV. PG. 161-163.
- FERRANTI ELECTRIC, INC.**, 30 Rockefeller Plaza, New York 20, N. Y. ADV. PG. 159.
- Gaveco Labs., Inc., 2 East End Ave., New York 21, N. Y.
- GENERAL ELECTRIC CO.**, Schenectady 5, N. Y. ADV. PG. 1 to 22.
- HIGHLAND ENGINEERING CO.**, Main St. & Urban Ave., Westbury, N. Y. ADV. PG. 360.
- Inet, Inc., 8655 S. Main St., Los Angeles 3, Calif.
- JFD MFG. CO.**, 6101-23 Sixteenth Ave., Brooklyn, N. Y. ADV. PG. 407.
- KEPCO LABS, INC.**, 149-14 41st Ave., Flushing, N. Y. ADV. PG. 54.
- LAMBDA ELECTRONICS CORP.**, 103-02 Northern Blvd., Corona, N. Y. ADV. PG. 374.
- MAGNETIC AMPLIFIERS, INC.**, 1154 44th Drive, Long Island City 1, N. Y. ADV. PG. 346.
- Oregon Electric Mfg. Co., 206 S. W. Washington St., Portland, Ore.
- RAYTHEON MFG. CO.**, Equipment Sales Div., Waltham 54, Mass. ADV. PG. 80, 81.
- SHERRON ELECTRONICS CO.**, 1201 Flushing Ave., Brooklyn 6, N. Y. ADV. PG. 145.
- SOLA ELECTRIC CO.**, 4633 W. 16th St., Chicago 50, Ill. ADV. PG. 312.
- SORENSEN & CO, INC.**, 375 Fairfield Ave., Stamford, Conn. ADV. PG. 66, 67.
- Standard Telephones & Cables Ltd., Connaught House, Aldwych, London, W. C. 2, England.
- STANDARD TRANSFORMER CORP.**, Elston, Kedzie & Addison, Chicago 18, Ill. ADV. PG. 144.
- SUPERIOR ELECTRIC CO., THE**, 4000 Church St., Bristol, Conn. ADV. PG. 190, 191.
- Thordarson-Meissner Mfg. Divisions, 500 W. Huron St., Chicago 10, Ill.
- UNITED TRANSFORMER CO.**, 150 Varick St., New York 13, N. Y. ADV. PG. Inside Front Cover.
- Varo Mfg. Co., Inc., Box 638, Garland, Texas.
- West Coast Electronics Co., 1601 S. Burlington St., Los Angeles 6, Calif.
- WESTINGHOUSE ELECTRIC CORP.**, 511 Wood St., P. O. Box 868, Pittsburgh 30, Pa. ADV. PG. 107-113.

RELAYS

1. Coaxial
2. d'Arsonval
3. Differential
4. Frequency Selective
5. High Voltage
6. Impulse
7. Keying and Break-in
8. Latching
9. Mercury
10. Overload
11. Overvoltage & Undervoltage
12. Polarized
13. Power
14. Rotary
15. Sensitive
16. Sequence
17. Stepping
18. Telephone
19. Time Delay
20. Vacuum Contact
21. Vibrating Reed Type

Note: (h) indicates hermetically sealed types.

- Adams & Westlake Co., Michigan St., Elkhart, Ind. 9-10-13-15-18-19.
- ADVANCE ELECTRIC & RELAY CO.**, 2435 Naomi St., Burbank, Calif. 1-5-7-8-10-11-13-15-18-19. ADV. PG. 284. (h)
- AIRPAX PRODUCTS CO.**, Middle River, Baltimore 20, Md. 12. ADV. PG. 289.
- Allen-Bradley Co., 135 W. Greenfield Ave., Milwaukee 4 Wis. 10-13-19.
- ALLIED CONTROL CO., INC.**, 2 East End Ave., New York 21, N. Y. 1-3-5-6-7-8-10-11-13-14-15-19. ADV. PG. 62, 63. (h)
- AMERICAN ELECTRONIC CORP.**, 5025-29 W. Jefferson Blvd., Los Angeles 16, Calif. 4-11-19. ADV. PG. 136.
- AMERICAN GAS ACCUMULATOR CO.**, 1029 Newark Ave., Elizabeth 3, N. J. 19. ADV. PG. 76.
- American Relay & Control Inc., 4901 W. Flournoy St., Chicago 44, Ill. 5-8-10-11-13-15-18-19.

V indicates . . . IN PRODUCTION • AVAILABILITY • UNRESTRICTED FOR GENERAL USE

- Ⓞ AMERICAN TELEVISION & RADIO CO., 300 E. Fourth St., St. Paul 1, Minn. 21. ADV. PG. 266.
- Ⓞ AMPERITE CO., INC., 561 Broadway, New York 12, N. Y. 19. ADV. PG. 323.
- Ⓞ Andrew Corp., 363 E. 75th St., Chicago 19, Ill. 1.
- Ⓞ Arrow-Hart & Hegeman Electric Co., 100 Hawthorn St., Hartford 6, Conn. 10.
- Ⓞ Assembly Products, Inc., Chagrin Falls 6, Ohio. 2-8-10-11-15-19.
- Ⓞ Autocall Co., The, Shelby, Ohio. 8-14-17-18.
- Ⓞ Automatic Electric Sales Corp., 1033 W. Van Buren St., Chicago 7, Ill. 3-6-7-8-9-10-11-12-13-14-15-16-17-18-19-21.
- Ⓞ Automatic Signal Div., Eastern Industries, Inc., 100 Regent St., East Norwalk, Conn. 13.
- Ⓞ Automatic Switch Co., 391 Lakeside Ave., Orange, N. J. 8-13.
- Ⓞ Automatic Temperature Control Co., Inc., 5212 Pulaski Ave., Philadelphia 44, Pa. 3-6-8-10-12-15-16-19.
- Ⓞ Biddle Co., James G., 1316 Arch St., Philadelphia 7, Pa. 21.
- Ⓞ Boehme, Inc., H. O., 915 Broadway, New York 10, N. Y. 13.
- Ⓞ Bunnell & Co., J. H., 812 Prospect St., Brooklyn, N. Y. 7-10-18-21.
- Ⓞ Clare & Co., C. P., 4719 W. Sunnyside Ave., Chicago 30, Ill. 3-6-7-8-9-12-17-18-19.
- Ⓞ Clark Controller Co., 1146 E. 152nd St., Cleveland 10, Ohio. 10-19.
- Ⓞ Cole Radio Works, 86 Westville Ave., Caldwell, N. J. 18.
- Ⓞ COMAR ELECTRIC CO., 3349 W. Addison St., Chicago 18, Ill. 8-15-16-18-19. ADV. PG. 335. (h)
- Ⓞ Control Corp., 718 Central Ave., Minneapolis 14, Minn. 4-8-18-21.
- Ⓞ Cook Electric Co., 2700 Southport Ave., Chicago 14, Ill. 3-5-8-10-13-15-16-17-18-19.
- Ⓞ Corona Engineering Service, 94-52 Corona Ave., Elmhurst, N. Y. 9-15.
- Ⓞ CRAMER CO., INC., R. W., Box 13, Centerbrook, Conn. 19. ADV. PG. 202.
- Ⓞ DECOURSEY ENGINEERING LAB., P. O. Box 235, Los Angeles 25, Calif. 13. ADV. PG. 174.
- Ⓞ Deitz Co., S. J. Box 65, West Englewood, N. J. 19.
- Ⓞ Durakool, Inc., 1010 N. Main St., Elkhart, Ind. 9-19.
- Ⓞ EBERT ELECTRONICS CORP., 185-09 Jamaica Ave., Hollis 7, N. Y. 9. ADV. PG. 413.
- Ⓞ ECLIPSE-PIONEER DIV., BENDIX AVIATION CORP., Teterboro, N. Y. 11-13. ADV. PG. 198, 199.
- Ⓞ EDISON, INC., THOMAS A., INSTRUMENT DIV., West Orange, N. J. 11-15-19. ADV. PG. 212, 213.
- Ⓞ Edwards Company, Inc., 86 Boston Post Rd., Norwalk, Conn. 3-10-11-12-13-15-18.
- Ⓞ Electric Regulator Corp., 1938 Park Ave., New York 35, N. Y. 3.
- Ⓞ Electronic Apparatus Co., Elkhart, Ind. 9. (h)
- Ⓞ Farmer Electric Co., 21 Mossfield Rd., Waban 68, Mass. 19.
- Ⓞ FEDERAL TELEPHONE & RADIO CORP., 88 Kingsland Rd., Clifton, N. J. 17-18. ADV. PG. 161-163.
- Ⓞ G-V Controls, Inc., 28 Hollywood Plaza, East Orange, N. J. 19. (h)
- Ⓞ General Communication Co., 530 Commonwealth Ave., Boston 15, Mass. 1.
- Ⓞ GENERAL ELECTRIC CO., Schenectady 5, N. Y. 3-10-11-13-15-19. ADV. PG. 1 to 22.
- Ⓞ GUARDIAN ELECTRIC MFG. CO., 1621 W. Walnut St., Chicago 12, Ill. 1-7-8-10-13-17-18-19. ADV. PG. 147. (h)
- Ⓞ HAYDON CO., A. W., 232 N. Elm St., Waterbury 20, Conn. 19. ADV. PG. 402. (h)
- Ⓞ HAYDON MFG. CO., INC., 584 E. Elm St., Torrington, Conn. 19. ADV. PG. 216, 217.
- Ⓞ Hoffman Engineering Corp., Anoka, Minn. 8.
- Ⓞ Industrial Electronics Co., Hanover, Mass. 10.
- Ⓞ Industrial Timer Corp., 115 Edison Pl., Newark 5, N. J. 19.
- Ⓞ Ionic Electronic Equipment Co., 1705 N. Kenmore, Los Angeles 27, Calif. 19.
- Ⓞ Jarvis Electronics Corp., 6058 W. Fullerton Ave., Chicago 39, Ill. 19.
- Ⓞ JENNINGS RADIO MFG. CO., 1098 E. William St., San Jose 12, Calif. 20. ADV. PG. 194, 195. (h)
- Ⓞ KELLOGG SWITCHBOARD & SUPPLY CO., 6650 S. Cicero Ave., Chicago 38, Ill. 18. ADV. PG. 294.
- Ⓞ KURMAN ELECTRIC CO., INC., 35-18 37th St., Long Island City, N. Y. 7-8-10-11-15-18-19. ADV. PG. 196.
- Ⓞ Leach Relay Co., 5915 Avalon Blvd., Los Angeles 3, Calif. 5-6-7-8-10-13-15. (h)
- Ⓞ LELAND, INC., G. H., 123 Webster St., Dayton 2, Ohio. 14-16-17. ADV. PG. 394, 395.
- Ⓞ Lumenite Electric Co., 407 S. Dearborn St., Chicago 5, Ill. 15-19.
- Ⓞ Mack Electrical Devices, Inc., 43 Glenside Ave., Wyncote, Pa. 9-13-15.
- Ⓞ Magnetic Devices, Inc., 712 East St., Frederick, Md. 12-13-14.
- Ⓞ Mallory & Co., Inc., P. R., 3029 E. Washington St., Indianapolis 6, Ind. 2-3-10-14-15-17.
- Ⓞ MERCROID CORP., 4201 Belmont Ave., Chicago 41, Ill. 19. ADV. PG. 192.
- Ⓞ Minneapolis-Honeywell Regulator Co., 2753 Fourth Ave., S., Minneapolis, Minn. 15-16.
- Ⓞ Molded Insulation Co., 335 E. Price St., Philadelphia 44, Pa. 15.
- Ⓞ Neomatic Inc., 879 Wellesley Ave., Los Angeles 49, Calif. 3-6-8-11-13-15-19.

- Ⓞ North Electric Mfg. Co., 501 S. Market St., Galion, Ohio. 8-13-15-17-18-19-21.
- Ⓞ Philco Corp., Tioga & C Sts., Philadelphia 34, Pa. 10.
- Ⓞ PHILLIPS CONTROL CORP., 84 W. Jefferson St., Joliet, Ill. 6-8-13-18-19. ADV. PG. 387.
- Ⓞ PICKERING & CO., 309 Woods Ave., Oceanside, N. Y. 15. ADV. PG. 284. (h)
- Ⓞ POTTER & BRUMFIELD, Princeton, Ind. 5-6-7-8-9-10-11-13-15-18-19. ADV. PG. 220. (h)
- Ⓞ Price Electric Corp., Frederick, Md. 1-3-5-6-7-8-10-12-13-14-15-16-17-18-19. (h)
- Ⓞ PRODUCT DEVELOPMENT CO., INC., Arlington, N. J. 1-5. ADV. PG. 362.
- Ⓞ R. B. M. Div., Essex Wire Corp., Logansport, Ind. 8-13-18.
- Ⓞ Ripley Co., Inc., Middletown, Conn. 10.
- Ⓞ Roller-Smith, Bethlehem, Pa. 10-11-19.
- Ⓞ SERVO-TEK PRODUCTS CO., 4 Godwin Ave., Paterson, N. J. 15. ADV. PG. 356.
- Ⓞ Sheldon Electric Co. Div. of Allied Electric Products, Inc., 76 Coit St., Irvington 11, N. J. 19.
- Ⓞ SIGMA INSTRUMENTS, INC., 180 Pearl St., South Braintree 85, Mass. 3-6-7-8-10-11-12-15-19. ADV. PG. 319. (h)
- Ⓞ SIGNAL ENGINEERING & MFG. CO., 154-6 W. 14th St., New York, N. Y. 1-3-5-6-7-8-10-11-12-13-15-16-17-18-19. ADV. PG. 256.
- Ⓞ Simpson Electric Co. Div., American Gage & Machine Co., 5218 W. Kinzie St., Chicago 44, Ill. 2-19.
- Ⓞ Spencer Thermostat Div., Metals & Controls Corp., 34 Forest St., Attleboro, Mass. 10-19.
- Ⓞ Standard Telephones & Cables Ltd., Connaught House, Aldwych, London, W. C. 2, England. 7-18-20.
- Ⓞ STEVENS-ARNOLD, INC., 22 Elkins St., South Boston, Mass. 4-7-12-21. ADV. PG. 295. (h)
- Ⓞ STEVENS MFG. CO., INC., 69 S. Walnut St., Mansfield, Ohio. 19. ADV. PG. 334.
- Ⓞ Struthers-Dunn, Inc., 150 N. 13th St., Philadelphia 7, Pa. 8-9-10-13-15-16-17-19.
- Ⓞ Thermo Instruments Co., Box 336, Belmont, Calif. 13. (h)
- Ⓞ Triplett Electrical Instrument Co., Harmon Rd., Bluffton, Ohio. 2.
- Ⓞ U. S. Instrument Corp., 409 Broad St., Summit, N. J. 14.
- Ⓞ Ulanet Co., George, 413 Market St., Newark 5, N. J. 19. (h)
- Ⓞ Varo Mfg. Co., Inc., Box 638, Garland, Texas. 4-15-19. (h)
- Ⓞ Vokar Corp., 7300 Huron River Drive, Dexter, Mich. (h)
- Ⓞ 21.
- Ⓞ Wallace & Tiernan Products, Inc., Belleville 9, N. J. 4.
- Ⓞ WARD LEONARD ELECTRIC CO., 31 South St., Mt. Vernon, N. Y. 7-8-10-11-13-15-19. ADV. PG. 69, 70.
- Ⓞ WESTINGHOUSE ELECTRIC CORP., 511 Wood St., P. O. Box 868, Pittsburgh 30, Pa. 2-3-4-5-6-8-10-11-12-13-14-15-16-19. ADV. PG. 107-113.
- Ⓞ WESTON ELECTRICAL INSTRUMENT CORP., 595 Frelinghuysen Ave., Newark 5, N. J. 2-13-15-18-19. ADV. PG. 243.
- Ⓞ Wilson & Co., G. C., 2 N. Passaic Ave., Chatham, N. J. 10.
- Ⓞ Zenith Electric Co., 152 W. Walton St., Chicago 10, Ill. 6.

RESISTORS—Deposited Carbon

- Ⓞ Campbell Industries, Inc., Chattanooga, Tenn.
- Ⓞ Chicago Dial Co., Chicago, Ill.
- Ⓞ Dale Products, Inc., Columbus, Neb.
- Ⓞ ELECTRA MFG. CO., Resistor Div., 2537 Madison Ave., Kansas City, Mo. ADV. PG. 174.
- Ⓞ INTERNATIONAL RESISTANCE CO., 401 N. Broad St., Philadelphia 8, Pa. ADV. PG. 134, 135.
- Ⓞ KAY ELECTRIC CO., 14 Maple Ave., Pine Brook, N. J. ADV. PG. 340.
- Ⓞ Phaestron Co., South Pasadena, Calif.
- Ⓞ RESISTANCE PRODUCTS CO., 714 Race St., Harrisburg, Pa. ADV. PG. 379.
- Ⓞ Welwyn Electronic Components, Inc., 234 E. 46th St., New York 17, N. Y.
- Ⓞ WILKOR PRODUCTS INC., 3835 W. 150th St., Cleveland 11, Ohio. ADV. PG. 361.

RESISTORS

Fixed Composition

1. Low voltage
2. Temperature sensitive
3. High frequency
4. High megohm
5. High voltage
6. High wattage
7. Voltage sensitive
8. Resistor-suppressor

Variable Composition

9. Controls & potentiometers

Wire Wound

10. 2 Watts and under
11. 4 to 35 Watts
12. 4 to 500 Watts

13. 500 to 1500 Watts
 14. Precision low voltage
 15. Precision high voltage
 16. Rf non-inductive
- Variable Wire Wound**
17. 4 Watts and under
 18. 5 to 25 Watts
 19. 25 Watts and over
 20. 500 Watts and over
 21. Slide wire
 22. Adjustable
 23. Rheostat—potentiometer types

Note: (h) indicates hermetically sealed types.

- Ⓞ Acme Electric Heating Co., 1217 Washington St., Boston, Mass. 11-12-13.
- Ⓞ Aero Coil, Inc., 507 26th St., Union City, N. J. 14.
- Ⓞ Allen-Bradley Co., 136 W. Greenfield Ave., Milwaukee 4, Wis. 1-9.
- Ⓞ Amalgamated Electronics, Electronic Road, Clinton Corners, N. Y. 17-18.
- Ⓞ American Diathermy Products, Inc., 11858 Mississippi Ave., Los Angeles 25, Calif. 10-11.
- Ⓞ Associated Research Inc., 3788 W. Belmont Ave., Chicago 18, Ill. 10-14.
- Ⓞ Automatic Electric Sales Corp., 1033 W. Van Buren St., Chicago 7, Ill. 10-11.
- Ⓞ Barber-Colman Company, Rockford, Ill. 2-23.
- Ⓞ BOND ELECTRONICS CORP., 88 Franklin Place, Summit, N. J. 10-11-14-15-16. ADV. PG. 403.
- Ⓞ Brown Electro-Measurement Corp., 4637 S.E., Hawthorne Blvd., Portland 15, Ore. 17-18-21-23.
- Ⓞ Carter Parts Company, 213 Institute Place, Chicago 10, Ill. 10-17-22-23.
- Ⓞ CENTRALAB DIVISION OF GLOBE-UNION INC., 900 Keefe Ave., Milwaukee 1, Wis. 1-9-17. ADV. PG. 85-88.
- Ⓞ CHICAGO TELEPHONE SUPPLY CORP., 1142 W. Beardsley Ave., Elkhart, Ind. 9-17. ADV. PG. 78, 79.
- Ⓞ CINEMA ENGINEERING CO., 1510 W. Verdugo Ave., Burbank, Calif. 10-14-21-23. ADV. PG. 204.
- Ⓞ Clark Controller Co., 1146 E. 152nd St., Cleveland 10, Ohio. 12-13.
- Ⓞ CLAROSTAT MFG. CO., INC., Dover, N. H. 4-5-9-10-11-12-14-16-17-18-19-22-23. ADV. PG. 100, 101. (h)
- Ⓞ COILCRAFT, INC., 3716 N. Cicero Ave., Chicago 41, Ill. 11-12-14-16. ADV. PG. 360.
- Ⓞ Continental Carbon, Inc., 13900 Lorain Ave., Cleveland 11, Ohio. 8-10.
- Ⓞ Cutler-Hammer, Inc., 411 N. 12th St., Milwaukee 1, Wis. 12-19.
- Ⓞ DAVEN CO., 191 Central Ave., Newark 4, N. J. 10-14-16. ADV. PG. 157.
- Ⓞ Davis Electric Co., Cape Girardeau, Mo. 11-14-18-19.
- Ⓞ DEJUR-AMSCO CORP., Northern Blvd. at 45th St., Long Island City 1, N. Y. 17-18-19-23. ADV. PG. 377.
- Ⓞ Dynamic Resistor Corp., 6 Cutter Mill Rd., Great Neck, N. Y. 11-12-14-15-18-19-21-22-23.
- Ⓞ Ecco High Frequency Corp., 7020 Hudson Blvd., North Bergen, N. J. 3.
- Ⓞ EDIN CO., INC., 207 Main St., Worcester, Mass. 14. ADV. PG. 285.
- Ⓞ ELECTRICAL REACTANCE CORP., Seneca Ave., Olean, N. Y. 11-12. ADV. PG. 56, 57.
- Ⓞ Electronic Indicator Corp., 259 Green St., Brooklyn 22, N. Y. 10-14.
- Ⓞ ERIE RESISTOR CORP., 644 W. 12th St., Erie, Pa. 1-8. ADV. PG. 91.
- Ⓞ Ford Engineering Co., 134 N. Second Ave., Upland, Calif. 9-23.
- Ⓞ Friez Instrument Div., Bendix Aviation Corp., Baltimore 4, Md. 2.
- Ⓞ GAMEWELL CO., THE, Newton Upper Falls 64, Mass. 23. ADV. PG. 306.
- Ⓞ GENERAL ELECTRIC CO., Schenectady 5, N. Y. 11-12-13. ADV. PG. 1 to 22.
- Ⓞ GENERAL RADIO CO., 275 Massachusetts Ave., Cambridge 39, Mass. 10-14-16-17-18-23. ADV. PG. 48, 49.
- Ⓞ Giannini & Co., Inc., 285 W. Colorado St., Pasadena 1, Calif. 17-23.
- Ⓞ Global Div., Carborundum Co., Niagara Falls, N. Y. 1-2-5-6-7-8.
- Ⓞ Hardwick, Hindle Inc., 40 Hermon Street, Newark, N. J. 11-12-18-19-21-22-23.
- Ⓞ HELIPOT CORP., 916 Meridian Ave., South Pasadena, Calif. 23. ADV. PG. 153.
- Ⓞ HILLBURN ELECTRONIC PRODUCTS CO., 55 Nassau Ave., Brooklyn 22, N. Y. 14. ADV. PG. 362.
- Ⓞ HOULIHAN CO., T. J., 2508-14 W. Lawrence Ave., Chicago 25, Ill. 11. ADV. PG. 336.
- Ⓞ Hycor Co., Inc., 11423 Vanowen St., North Hollywood, Calif. 10-14-15.
- Ⓞ I-T-E Circuit Breaker Co., 19th and Hamilton Sts., Philadelphia 30, Pa. 10-11-12-18-19-22.
- Ⓞ INSTRUMENT RESISTORS CO., 1036 Commerce Ave., Union, N. J. 1-10-11-14-15-16. ADV. PG. 392, 393.
- Ⓞ INTERNATIONAL RESISTANCE CO., 401 N. Broad St., Philadelphia 8, Pa. 1-3-4-5-6-8-9-10-11-12-14-15-16-17-22-23. ADV. PG. 134, 135.
- Ⓞ KEYSTONE CARBON CO., INC., Saint Mary's, Pa. 2. ADV. PG. 308.
- Ⓞ Lectrohm Inc., 5939 Archer Ave., Chicago 38, Ill. 11-12-18-19-22.

V indicates . . . **IN PRODUCTION • AVAILABILITY • UNRESTRICTED FOR GENERAL USE**

- ⊙ Leeds & Northrup Co., 4970 Stenton Ave., Philadelphia 44, Pa. 10-14-16-21-22-23. (h)
- ⊙ Mallory & Co., Inc., P. R., 3029 E. Washington St., Indianapolis 6, Ind. 9-17-18-22-23.
- ⊙ MEPCO INC., 35-37 Abnett Ave., Morristown, N. J. 10-14-15. ADV. PG. 138.
- ⊙ MICAMOLD RADIO CORP., 1087 Flushing Ave., Brooklyn 6, N. Y. 1 ADV. PG. 275.
- ⊙ Milwaukee Resistor Co., 700 W. Virginia St., Milwaukee 4, Wis. 11-12-18-19-22.
- ⊙ Model Engineering & Mfg., Inc., Huntington, Ind. 12-22.
- ⊙ Muter Co., 1255 S. Michigan Ave., Chicago, Ill. 10-11-18-23.
- ⊙ Ohio Carbon Co., 12508 Berea Rd., Cleveland 11, Ohio. 1-4-8-10-11-22.
- ⊙ OHMITE MFG. CO., 4835 W. Flournoy St., Chicago 44, Ill. 1-3-9-10-11-12-13-14-15-16-18-19-20-21-22-23. ADV. PG. 41. (h)
- ⊙ OHMWEVE CO., 43 Darcy St., West Hartford 6, Conn. 3. ADV. PG. 380.
- ⊙ PAINTON & CO., LTD., 366 Madison Ave., New York 17, N. Y. 10-11-12-14-15-16-17-18-19-22-23. ADV. PG. 336.
- ⊙ Philco Corp., Tioga & C Sts., Philadelphia 34, Pa. 1-3-4-5-6-8-9-10-11-21.
- ⊙ Plastics & Electronics Co., Inc., P. O. Box 38, Station J, Buffalo 8, N. Y. 1-4.
- ⊙ Precision Electronic Components, Ltd., P. O. Box 264, Granby, Quebec, Canada. 9.
- ⊙ Precision Resistor Co., 334 Badger Ave., Newark 8, N. J. 10-11-14-15-16.
- ⊙ Presto Electric Co., Inc., 4513 New York Ave., Union City, N. J. 10-11-12-13-14.
- ⊙ Rattray & Co., Inc., George, 92-32 Union Hall St., Jamaica 5, N. Y. 17-23.
- ⊙ RESISTANCE PRODUCTS CO., 714 Race St., Harrisburg 2, Pa. 1-3-4-5-6-10-14-15. ADV. PG. 379.
- ⊙ Resistor Corp. of Nevada, Box 35, Verdi, Nev. 1-4.
- ⊙ Resistors, Inc., 5226 W. 26th St., Chicago 50, Ill. 10-11-12-13-17-18-19-22.
- ⊙ Rex Rheostat Co., 3 Foxhurst Rd., Baldwin, N. Y. 6-12-13-20-23.
- ⊙ Rubicon Co., 3761 Ridge Ave., Philadelphia 42, Pa. 14.
- ⊙ St. Mary's Carbon Co., State Rd., St Marys, Pa. 1-2-5-6-7-8.
- ⊙ Sensitive Research Instrument Corp., 9 Elm Ave., Mt. Vernon, N. Y. 1-4.
- ⊙ SHALLCROSS MFG. CO., 10 Jackson Ave., Collingdale, Pa. 5-6-10-14-15. ADV. PG. 261. (h)
- ⊙ SPEER RESISTOR CORP., St. Marys, Pa. 1-2-5-6-7-8. ADV. PG. 406.
- ⊙ Sprague Electric Co., North Adams, Mass. 5-11-12-14-15-16.
- ⊙ STACKPOLE CARBON CO., St. Mary's Pa. 1-8-9. ADV. PG. 170, 171.
- ⊙ STUPAKOFF CERAMIC & MFG. CO., Latrobe, Pa. 2. ADV. PG. 167.
- ⊙ Summit Coil Co., 67 Union Pl., Summit, N. J. 10-11-14.
- ⊙ Supreme, Inc., Greenwood, Miss. 14.
- ⊙ Technology Instrument Corp., 531 Main St., Acton, Mass. 17-18-21-23.
- ⊙ Trimm, Inc., 400 W. Lake St., Libertyville, Ill. 17.
- ⊙ Triumph Mfg. Co., 913 W. Van Buren St., Chicago 7, Ill. 1-4-6-11-18-22.
- ⊙ VICTOREEN INSTRUMENT CO., 5806 Hough Ave., Cleveland 3, Ohio. 4. ADV. PG. 272, 273.
- ⊙ VICTORY ENGINEERING CORP., 744 Broad St., Newark, N. J. 2. ADV. PG. 203.
- ⊙ Vokar Corp., 7300 Huron River Drive, Dexter, Mich. 10-11-12-13-14-15-16-17-18-19-20-21-22-23. (h)
- ⊙ WARD LEONARD ELECTRIC CO., 21 South St., Mt. Vernon, N. Y. 11-12-13-16-19-20-22-23. ADV. PG. 69, 70.
- ⊙ WESTINGHOUSE ELECTRIC CORP., 511 Wood St., P. O. Box 868, Pittsburgh 30, Pa. 1-9. ADV. PG. 291.
- ⊙ WHITE DENTAL MFG. CO., S. S., Industrial Div., 10 East 40th St., New York 16, N. Y. 1-4-5. ADV. PG. 291.
- ⊙ WILKOR PRODUCTS INC., 3835 W. 150th St., Cleveland 11, Ohio. 10. ADV. PG. 361.
- ⊙ Wirt Co., 5221 Green St., Philadelphia, Pa. 10-11-12-13-17-23.

RHEOSTATS

- ⊙ BETA ELECTRIC CORP., 333 E. 103rd St., New York 29, N. Y. ADV. PG. 399.
- ⊙ Brown Electro-Measurement Corp., 4637 S. E. Hawthorne Blvd., Portland 15, Ore.
- ⊙ Cartar Parts Co., 213 Institute Pl., Chicago 10, Ill.
- ⊙ Cutler-Hammer, Inc., 411 N. 12th St., Milwaukee 1, Wis.
- ⊙ DAVEN CO., 191 Central Ave., Newark 4, N. J. ADV. PG. 157.
- ⊙ DEJUR-AMSCO CORP., Northern Blvd. at 45th St., Long Island City 1, N. Y. ADV. PG. 377.
- ⊙ Dynamic Resistor Corp., 6 Cutter Mill Rd., Great Neck, N. Y.
- ⊙ Ford Engineering Co., 134 N. Second Ave., Upland, Calif.
- ⊙ GENERAL ELECTRIC CO., Schenectady 5, N. Y. ADV. PG. 1 to 22.

- ⊙ GENERAL RADIO CO., 275 Massachusetts Ave., Cambridge 39, Mass. ADV. PG. 48, 49.
- ⊙ Hardwick, Hindle Inc., 40 Hermon St., Newark 5, N. J.
- ⊙ Leeds & Northrup Co., 4970 Stenton Ave., Philadelphia 44, Pa.
- ⊙ Mallory & Co., Inc., P. R., 3029 E. Washington St., Indianapolis 6, Ind.
- ⊙ National Electric Controller Co., 5307 Ravenswood Ave., Chicago, Ill.
- ⊙ OHMITE MFG. CO., 4835 W. Flournoy St., Chicago 44, Ill. ADV. PG. 41.
- ⊙ PAINTON & CO., LTD., 366 Madison Ave., New York 17, N. Y. ADV. PG. 336.
- ⊙ Rex Rheostat Co., 3 Foxhurst Rd., Baldwin, N. Y.
- ⊙ Rubicon Co., 3761 Ridge Ave., Philadelphia 42, Pa.
- ⊙ STACKPOLE CARBON CO., St. Marys, Pa. ADV. PG. 170, 171.
- ⊙ WARD LEONARD ELECTRIC CO., 31 South St., Mount Vernon, N. Y. ADV. PG. 69, 70.
- ⊙ WESTINGHOUSE ELECTRIC CORP., 511 Wood St., P. O. Box 868, Pittsburgh 30, Pa. ADV. PG. 107, 113.

RHEOSTATS—Slide Wire

- ⊙ Brown Electro-Measurement Corp., 4637 S. E. Hawthorne Blvd., Portland 15, Ore.
- ⊙ Biddle Co., James G., 1316 Arch St., Philadelphia 7, Pa.
- ⊙ Central Scientific Co., 1700 Irving Park Rd., Chicago 13, Ill.
- ⊙ Dynamic Resistor Corp., 6 Cutter Mill Rd., Great Neck, N. Y.
- ⊙ Hardwick, Hindle Inc., 40 Hermon St., Newark 5, N. J.
- ⊙ Leeds & Northrup Co., 4970 Stenton Ave., Philadelphia 44, Pa.
- ⊙ OHMITE MFG. CO., 4835 W. Flournoy St., Chicago 44, Ill. ADV. PG. 41.
- ⊙ Rubicon Co., 3761 Ridge Ave., Philadelphia 42, Pa.
- ⊙ Welch Scientific Co., W. M. 1515 Sedgwick St., Chicago 10, Ill.

RINGS—Carbon Packing

- Electro-Nite Carbon Co., 1133 E. Columbia Ave., Phila. 25, Pa.
- ⊙ GRAPHITE METALIZING CORP., 1041 Nepperhan Ave., Yonkers 3, N. Y. ADV. PG. 192.
- ⊙ NATIONAL CARBON CO., Division of Union Carbide & Carbon Corp., 30 E. 42nd St., New York 17, N. Y. ADV. PG. 42.
- ⊙ Ohio Carbon Co., 12508 Berea Rd., Cleveland 11, Ohio.
- ⊙ Pure Carbon Co., St. Marys, Pa.
- ⊙ St. Mary's Carbon Co., State Rd., St. Marys, Pa.
- ⊙ STACKPOLE CARBON CO., St. Marys, Pa. ADV. PG. 170, 171.

RINGS—Collector

- ⊙ Baker & Co., Inc., 113 Astor St., Newark 5, N. J.
- ⊙ Baldwin-Lima-Hamilton Corp., Paschall P. O. Station, Philadelphia 42, Pa.
- ⊙ BRAININ CO., C. S., 320 Washington St., Mt. Vernon, N. Y. ADV. PG. 142.
- ⊙ GENERAL PLATE DIV., Metals & Controls Corp., Attleboro, Mass. ADV. PG. 300.
- ⊙ GRAPHITE METALIZING CORP., 1041 Nepperhan Ave., Yonkers 3, N. Y. ADV. PG. 192.
- ⊙ Industrial Electrical Works, 1509 Chicago St., Omaha 2, Nebr.

RINGS—Oil Sealing

- ⊙ Auburn Mfg. Co., Pease Ave. & Stack St., Middletown, Conn.
- ⊙ Crane Packing Co., 1800 Cuyler Ave., Chicago 13, Ill.
- ⊙ Felt Products Mfg. Co., 1504 West Carroll Ave., Chicago 7, Ill.
- ⊙ Garlock Packing Co., The, Palmyra, N. Y.
- ⊙ GRAPHITE METALIZING CORP., 1041 Nepperhan Ave., Yonkers 3, N. Y.
- ⊙ Johns-Manville, 22 E. 40th St., New York 16, N. Y.
- ⊙ Ohio Carbon Co., 12508 Berea Rd., Cleveland 11, Ohio.
- ⊙ Pure Carbon Co., St. Marys, Pa.
- ⊙ STACKPOLE CARBON CO., St. Marys, Pa. ADV. PG. 170, 171.
- ⊙ TEFLON PRODUCTS DIVISION, U. S. Gasket Co., P. O. Box 93, Camden, N. J. ADV. PG. 176.

RINGS—Retaining

- ⊙ Felt Products Mfg. Co., 1504 West Carroll Ave., Chicago 7, Ill.
- ⊙ General Cement Mfg. Co., 919 Taylor Ave., Rockford, Ill.
- ⊙ National Lock Washer Co., 40 Hermon St., Newark 5, N. J.
- ⊙ Ohio Carbon Co., 12508 Berea Rd., Cleveland 11, Ohio.
- ⊙ TEFLON PRODUCTS DIVISION, U. S. GASKET CO., P. O. Box 93, Camden, N. J. ADV. PG. 176.
- ⊙ Waldes Kohinor Inc., 47-16 Austel Place, Long Island City 1, N. Y.

RIVETS

- ⊙ ART WIRE & STAMPING CO., 227 High St., Newark 2, N. J. ADV. PG. 38.
- ⊙ Atlas Tack Corp., Pleasant St., Fairhaven, Mass.
- ⊙ Autoscrew Co., 216-222 W. 18th St., New York, N. Y.
- ⊙ BRAININ CO., C. S., 320 Washington St., Mount Vernon, N. Y. ADV. PG. 142.
- ⊙ Chase Brass & Copper Co., Inc., 236 Grand St., Waterbury 20, Conn.
- ⊙ Cherry Rivet Co., A Div. of Townsend Co., 231 Winston St., Los Angeles 13, Calif.
- ⊙ Chicago Rivet & Machine Co., 9600 W. Jackson Blvd., Chicago, Ill.
- ⊙ FEDERAL SCREW PRODUCTS INC., 224 Huron St., Chicago 10, Ill. ADV. PG. 76.
- ⊙ General Cement Mfg. Co., 919 Taylor Ave., Rockford, Ill.
- ⊙ Gries Reproducer Corp., 100 Willow Ave., New York 54, N. Y.
- ⊙ Harper Co., H. M., 8200 Lehigh Ave., Morton Grove, Ill.
- ⊙ Hassall Inc., John, Clay & Oakland Sts., Brooklyn 22, N. Y.
- ⊙ Milford Rivet & Machine Co., 1602 NBC Bldg., Cleveland 14, Ohio.
- ⊙ PIX MFG. CO., INC., 24 Bedford St., Newark, N. J. ADV. PG. 136.
- ⊙ Plume & Atwood Mfg. Co., 220 Broadway, New York, N. Y.
- ⊙ Stronghold Screw Products, Inc., 216-222 W. Hubbard St., Chicago 10, Ill.
- ⊙ Tubular Rivet & Stud Co., Linden St., Quincy, Mass.

RUBBER

See Insulation Materials

RUBBER—Conductive

See Insulation Materials

ROOMS—Screen

- ⊙ ACE ENGINEERING & MACHINE CO., INC., 3642 N. Lawrence St., Philadelphia 40, Pa. ADV. PG. 318.
- ⊙ BELLING & LEE LTD., 366 Madison Ave., New York 17, N. Y. ADV. PG. 336.

SCALERS

- ⊙ ATOMIC INSTRUMENT CO., 84 Massachusetts Ave., Cambridge 39, Mass. ADV. PG. 410.
- ⊙ Berkeley Scientific Corp., 2200 Wright Ave., Richmond, Calif.
- ⊙ Condon Radio Mfg. Co., 631 Whipple, Prescott, Ariz.
- ⊙ Douglas Radio Labs., 176 Norfolk Ave., Boston 19, Mass.
- ⊙ EL-TRONICS, INC., 2649 N. Howard St., Philadelphia 33, Pa. ADV. PG. 299.
- ⊙ HEWLETT-PACKARD CO., 395 Page Mill Rd., Palo Alto, Calif. ADV. PG. 33-36.
- ⊙ Ionic Electronic Equipment Co., 1705 N. Kenmore, Los Angeles 27, Calif.
- ⊙ Kelley-Koett Instrument Co., 962 York St., Cincinnati 14, Ohio.
- ⊙ North American Philips Co., Inc., 100 E. 42nd St., New York 17, N. Y.
- ⊙ Nuclear Development Lab., Box 7034, Kansas City, Mo.
- ⊙ Nuclear Instrument & Chemical Corp., 223 W. Erie St., Chicago 10, Ill.
- ⊙ Nuclear Measurements Corp., 3339 Central Ave., Indianapolis 5, Ind.
- ⊙ Nuclear Research Corp., 2707 Federal St., Philadelphia 46, Pa.
- ⊙ Nucleonic Corp. of America, 497 Union St., Brooklyn 31, N. Y.
- ⊙ POTTER INSTRUMENT CO., INC., 115 Cutter Mill Rd., Great Neck, N. Y. ADV. PG. 318.
- ⊙ R-C Scientific Instrument Co., 335 Culver Blvd., Playa Del Rey, Calif.
- ⊙ Radiation Counter Laboratories, Inc., 1844 W. 21st St., Chicago 8, Ill.
- ⊙ Radioactive Products, Inc., 443 W. Congress St., Detroit 26, Mich.
- ⊙ Technical Associates, 3730 San Fernando Rd., Glendale 4, Calif.
- ⊙ Tracerlab, Inc., 130 High St., Boston 10, Mass.
- ⊙ VICTOREEN INSTRUMENT CO., 5806 Hough Ave., Cleveland 3, Ohio. ADV. PG. 272, 273.
- ⊙ Walkirt Co., 5808 Marilyn Ave., Culver City, Calif.

SCALES—Oscilloscope

- ⊙ Cossor (Canada) Ltd., 301-303 Windsor St., Halifax, N. S., Canada.
- ⊙ Du Mont Laboratories, Inc., Allen B., Instrument Div., 1000 Main Ave., Clifton, N. J.

SCANNERS—Reflected & Transmitted Light

- ⊙ Deitz Co., S. J., Box 65, West Englewood, N. J.
- ⊙ FEDERAL TELECOMMUNICATION LABS., INC., 500 Washington Ave., Nutley, N. J. ADV. PG. 164.
- ⊙ McElroy Mfg. Corp., Littleton, Mass.

Ⓢ indicates . . . IN PRODUCTION • AVAILABILITY • UNRESTRICTED FOR GENERAL USE

- Ⓢ Photoswitch, Inc., 77 Broadway, Cambridge 42, Mass.
- Ⓢ Press Wireless Mfg. Co., Inc., Cantiague Rd., Hicksville, N. Y.
- Ⓢ Telechrome, Inc., 88 Merrick Rd., Amityville, N. Y.
- Ⓢ WESTINGHOUSE ELECTRIC CORP., 511 Wood St., P. O. Box 868, Pittsburgh 30, Pa. ADV. PG. 107-113.

SCRAMBLERS—Speech

- Ⓢ BARKER & WILLIAMSON, 235 Fairfield Ave., Upper Darby, Pa. ADV. PG. 292.
- Ⓢ KAY ELECTRIC CO., 14 Maple Ave., Pine Brook, N. J. ADV. PG. 340.
- Ⓢ Standard Telephones & Cables, Ltd., Connaught House, Aldwych, London, W. C. 2, England.

SCREENS—Television Projection

- Ⓢ Philco Corp., Tioga & C Sts., Philadelphia 34, Pa.
- Ⓢ SPELLMAN TELEVISION CO., INC., 3029 Webster Ave., New York 67, N. Y. ADV. PG. 277.
- Ⓢ TRAD TELEVISION CORP., 1001 First Ave., Asbury Park, N. J. ADV. PG. 355.
- Ⓢ Transmira Products Corp., 1650 Broadway, New York 19, N. Y.

SCREWS

- Ⓢ ALDEN PRODUCTS CO., 117 N. Main St., Brockton 64, Mass. ADV. PG. 327.
- Ⓢ Allmetal Screw Products Co., Inc., 33 Greene St., New York 13, N. Y.
- Ⓢ Aluminum Co. of America, Gulf Bldg., Pittsburg 30, Pa.
- Ⓢ American Laubscher Corp., 333 W. 52nd St., New York 19, N. Y.
- Ⓢ American Screw Co., Willimantic, Conn.
- Ⓢ Autoscrew Co., 216-222 W. 18th St., New York, N. Y.
- Ⓢ Birnbach Radio Co., Inc., 145 Hudson St., New York, N. Y.
- Ⓢ BLAKE & JOHNSON CO., Waterville 48, Conn. ADV. PG. 279.
- Ⓢ Bristol Co., The, Waterbury 20, Conn.
- Ⓢ Central Screw Co., 3501 Shields Ave., Chicago 9, Ill.
- Ⓢ Chandler Products Co., 1491 Chardon Rd., Cleveland, Ohio.
- Ⓢ Chase Brass & Copper Co., Inc., 236 Grand St., Waterbury 20, Conn.
- Ⓢ CITATION PRODUCTS CO., 233 E. 146th St., New York 51, N. Y. ADV. PG. 388.
- Ⓢ Continental Screw Co., New Bedford, Mass.
- Ⓢ FEDERAL SCREW PRODUCTS INC., 224 W. Huron St., Chicago 10, Ill. ADV. PG. 76.
- Ⓢ General Cement Mfg. Co., 919 Taylor Ave., Rockford, Ill.
- Ⓢ Harper Co., H. M., 8200 Lehigh Ave., Morton Grove, Ill.
- Ⓢ Hubbell, Inc., Harvey, Bridgeport 2, Conn.
- Ⓢ Insuline Corp. of America, 36-02 35th Ave., Long Island City, N. Y.
- Ⓢ Lamson & Sessions Co., 1971 W. 85th St., Cleveland, Ohio.
- Ⓢ Milford Rivet & Machine Co., 1602 NBC Bldg., Cleveland 14, Ohio.
- Ⓢ Morris Co., J. I., 394 Elm St., Southbridge, Mass.
- Ⓢ National Screw & Mfg. Co., The, Cleveland 4, Ohio.
- Ⓢ Parker-Kalon Corp., 200 Varick St., New York 14, N. Y.
- Ⓢ Pheoil Mfg. Co., 5700 Roosevelt Rd., Chicago 50, Ill.
- Ⓢ Pilgrim Mfg. Co., 259 Dexter St., Providence, R. I.
- Ⓢ Progressive Mfg. Co., 50 Norwood St., Torrington, Conn.
- Ⓢ Schott Co., Walter L., 3225 Exposition Pl., Los Angeles 18, Calif.
- Ⓢ Scovill Mfg. Co., Industrial Fastener Div., Waterbury, Conn.
- Ⓢ Smith, Inc., Herman H., 436 18th St., Brooklyn 15, N. Y.
- Ⓢ Spaulding Fibre Co., Inc., 310 Wheeler St., Tonawanda, N. Y.
- Ⓢ Standard Pressed Steel Co., Jenkintown 10, Pa.
- Ⓢ Stronghold Screw Products, Inc., 216-222 W. Hubbard St., Chicago 10, Ill.
- Ⓢ United Screw & Bolt Corp., 2513 W. Cullerton St., Chicago 8, Ill.
- Ⓢ Waltham Screw Co., 77 Rumford Ave., Waltham, Mass.

SCREWS—Self-Tapping

- Ⓢ Allmetal Screw Products Co., Inc., 33 Greene St., New York 13, N. Y.
- Ⓢ American Screw Co., Willimantic, Conn.
- Ⓢ Birnbach Radio Co., Inc., 145 Hudson St., New York, N. Y.
- Ⓢ BLAKE & JOHNSON CO., Waterville 48, Conn. ADV. PG. 279.
- Ⓢ Central Screw Co., 3501 Shields Ave., Chicago 9, Ill.
- Ⓢ Continental Screw Co., New Bedford, Mass.
- Ⓢ FEDERAL SCREW PRODUCTS INC., 224 W. Huron St., Chicago 10, Ill. ADV. PG. 76.
- Ⓢ General Cement Mfg. Co., 919 Taylor Ave., Rockford, Ill.

- Ⓢ Harper Co., H. M., 8200 Lehigh Ave., Morton Grove, Ill.
- Ⓢ Insuline Corp. of America, 36-02 35th Ave., Long Island City, N. Y.
- Ⓢ Lamson & Sessions Co., 1971 W. 85th St., Cleveland, Ohio.
- Ⓢ National Screw & Mfg. Co., The, Cleveland 4, Ohio.
- Ⓢ Parker-Kalon Corp., 200 Varick St., New York 14, N. Y.
- Ⓢ Pheoil Mfg. Co., 5700 Roosevelt Rd., Chicago 50, Ill.
- Ⓢ Schott Co., Walter L., 3225 Exposition Pl., Los Angeles 18, Calif.
- Ⓢ Scovill Mfg. Co., Industrial Fastener Div., Waterbury, Conn.
- Ⓢ Shakeproof Inc., Div. of Illinois Tool Wks., 2501 N. Keeler Ave., Chicago 39, Ill.
- Ⓢ Smith, Inc., Herman H., 436 18th St., Brooklyn 15, N. Y.
- Ⓢ Stronghold Screw Products, Inc., 216-222 W. Hubbard St., Chicago 10, Ill.
- Ⓢ United Screw & Bolt Corp., 2513 W. Cullerton St., Chicago 8, Ill.

SCREWS—Set

- Ⓢ ALLEN MFG. CO., Hartford 2, Conn. ADV. PG. 252.
- Ⓢ Allmetal Screw Products Co., Inc., 33 Greene St., New York 13, N. Y.
- Ⓢ American Laubscher Corp., 333 W. 52nd St., New York 19, N. Y.
- Ⓢ Autoscrew Co., 216-222 W. 18th St., New York 11, N. Y.
- Ⓢ Birnbach Radio Co., Inc., 145 Hudson St., New York, N. Y.
- Ⓢ Bristol Co., The, Waterbury 20, Conn.
- Ⓢ Chase Brass & Copper Co., Inc., 236 Grand St., Waterbury 20, Conn.
- Ⓢ FEDERAL SCREW PRODUCTS INC., 224 W. Huron St., Chicago 10, Ill. ADV. PG. 76.
- Ⓢ General Cement Mfg. Co., 919 Taylor Ave., Rockford, Ill.
- Ⓢ Harper Co., H. M., 8200 Lehigh Ave., Morton Grove, Ill.
- Ⓢ Insuline Corp. of America, 36-02 35th Ave., Long Island City, N. Y.
- Ⓢ Lamson & Sessions Co., 1971 W. 85th St., Cleveland, Ohio.
- Ⓢ Moore Inc., George W., 100 Beaver St., Waltham, Mass.
- Ⓢ National Screw & Mfg. Co., The, Cleveland 4, Ohio.
- Ⓢ Parker-Kalon Corp., 200 Varick St., New York 14, N. Y.
- Ⓢ Pheoil Mfg. Co., 5700 Roosevelt Rd., Chicago 50, Ill.
- Ⓢ Schott Co., Walter L., 3225 Exposition Pl., Los Angeles 18, Calif.
- Ⓢ Scovill Mfg. Co., Industrial Fastener Div., Waterbury, Conn.
- Ⓢ SET SCREW & MFG. CO., 470 Main St., Bartlett, Ill. ADV. PG. 406.
- Ⓢ Shakeproof, Inc. Div. of Illinois Tool Works, 2501 N. Keeler Ave., Chicago 39, Ill.
- Ⓢ Smith, Inc., Herman H., 436 18th St., Brooklyn 15, N. Y.
- Ⓢ Stronghold Screw Products, Inc., 216-222 W. Hubbard St., Chicago 10, Ill.
- Ⓢ United Screw & Bolt Corp., 2513 W. Cullerton St., Chicago 8, Ill.
- Ⓢ Waltham Screw Co., 77 Rumford Ave., Waltham, Mass.

SEALS—Carbon

- Ⓢ Crane Packing Co., 1800 Cuyler Ave., Chicago 13, Ill.
- Ⓢ Electro-Nite Carbon Co., 1133 E. Columbia Ave., Philadelphia 25, Pa.
- Ⓢ GRAPHITE METALLIZING CORP., 1041 Nepperhan Ave., Yonkers 3, N. Y. ADV. PG. 192.
- Ⓢ NATIONAL CARBON CO., Division of Union Carbide & Carbon Corp., 30 E. 42nd St., New York 17, N. Y. ADV. PG. 42.
- Ⓢ Pura Carbon Co., St. Marys, Pa.
- Ⓢ St. Mary's Carbon Co., State Road, St. Marys, Pa.
- Ⓢ STACKPOLE CARBON CO., St. Marys, Pa. ADV. PG. 170, 171.

SEALS—Hermetic

- Ⓢ BELLING & LEE, LTD., 366 Madison Ave., New York 17, N. Y. ADV. PG. 336.
- Ⓢ Durakool, Inc., 1010 N. Main St., Elkhart, Ind.
- Ⓢ ELECTRICAL INDUSTRIES, INC., 44 Summer Ave., Newark 4, N. J. ADV. PG. 94.
- Ⓢ ELECTRO-SEAL CORP., 946 Lee St., Des Plaines, Ill. ADV. PG. 222.
- Ⓢ Electronic Apparatus Co., Elkhart, Ind.
- Ⓢ Elm Laboratories, 18 South Broadway, Dobbs Ferry, N. Y.
- Ⓢ Fusite Corp., Carthage at Hannaford, Cincinnati 12, Ohio.
- Ⓢ GENERAL CERAMICS & STEATITE CORP., Keasbey, N. J. ADV. PG. 126, 127.
- Ⓢ HELDOR MFG. CO., Div. of Helder Bushing & Terminal Inc., 225 Belleville Ave., Bloomfield, N. J. ADV. PG. 242.
- Ⓢ HERMASEAL CO., INC., Riverside Drive, Elkhart, Ind. ADV. PG. 294.
- Ⓢ HERMETIC SEAL PRODUCTS CO., 29-37 South 6th St., Newark 7, N. J. ADV. PG. 175.

- Ⓢ NEO-SIL CORP., 26 Cornelison Ave., Jersey City 4, N. J. ADV. PG. 253.
- Ⓢ OLYMPIC METAL PRODUCTS CO., INC., Phillipsburg, N. J. ADV. PG. 358.
- Ⓢ STUPAKOFF CERAMIC & MFG. CO., Latrobe, Pa. ADV. PG. 167.
- Ⓢ Wheaton Co., T. C., Industrial Division, 220 G St., Millville, N. J.
- Ⓢ Wolfe Co., Inc., Franklin C., 11723 Mississippi Ave., Los Angeles 25, Calif.
- Ⓢ Zell Products Corp., 276-280 Main St., P. O. Box 590, Norwalk, Conn.

SEALS—Metal-to-Glass

- Ⓢ BELLING & LEE, LTD., 366 Madison Ave., New York 17, N. Y. ADV. PG. 336.
- Ⓢ Brew & Co., Inc., Richard D., 106 Concord Ave., Belmont, Mass.
- Ⓢ CORNING GLASS WORKS, Corning, N. Y. ADV. PG. 373.
- Ⓢ Dallons Labs., 5066 Santa Monica Blvd., Los Angeles, Calif.
- Ⓢ Durakool, Inc., 1010 N. Main St., Elkhart, Ind.
- Ⓢ ELECTRICAL INDUSTRIES, INC., 44 Summer Ave., Newark 4, N. J. ADV. PG. 94.
- Ⓢ Electronic Apparatus Co., Elkhart, Ind.
- Ⓢ Fusite Corp., Carthage at Hannaford, Cincinnati 12, Ohio.
- Ⓢ HERMASEAL CO., INC., Riverside Drive, Elkhart, Ind. ADV. PG. 294.
- Ⓢ HERMETIC SEAL PRODUCTS CO., 29-37 South 6th St., Newark, N. J. ADV. PG. 175.
- Ⓢ MARION ELECTRICAL INSTRUMENT CO., Manchester, N. H. ADV. PG. 200.
- Ⓢ STUPAKOFF CERAMIC & MFG. CO., Latrobe, Pa. ADV. PG. 167.
- Ⓢ WESTINGHOUSE ELECTRIC CORP., 511 Wood St., P. O. Box 868, Pittsburgh 30, Pa. ADV. PG. 107-113.
- Ⓢ Wheaton Co., T. C., Industrial Div., 220 G St., Millville, N. J.
- Ⓢ Zell Products Corp., 276-280 Main St., P. O. Box 590, Norwalk, Conn.
- Ⓢ ZOPHAR MILLS, INC., 112-130 26th St., Brooklyn 32, N. Y. ADV. PG. 397.

SEALS—Oil

- Ⓢ Crane Packing Co., 1800 Cuyler Ave., Chicago 13, Ill.
- Ⓢ Eastern Metals Industries, Inc., 250 W. 54th St., New York 19, N. Y.
- Ⓢ Felt Products Mfg. Co., 1504 W. Carroll Ave., Chicago 7, Ill.
- Ⓢ Garlock Packing Co., The, Palmyra, N. Y.
- Ⓢ GRAPHITE METALLIZING CORP., 1041 Nepperhan Ave., Yonkers 3, N. Y. ADV. PG. 192.
- Ⓢ HELDOR MFG. CO., Div. of Helder Bushing & Terminal Inc., 225 Belleville Ave., Bloomfield, N. J. ADV. PG. 242.
- Ⓢ Johns-Manville, 22 E. 40th St., New York 16, N. Y.
- Ⓢ Syntroon Co., 243 Lexington, Homer City, Pa.
- Ⓢ TEFLON PRODUCTS DIVISION, U. S. GASKET CO., P. O. Box 93, Camden, N. J. ADV. PG. 176.
- Ⓢ Wolfe Co., Inc., Franklin C., 11723 Mississippi Ave., Los Angeles 25, Calif.

SELECTIVE CALLING APPARATUS

- Ⓢ Autocall Co., The, Shelby, Ohio.
- Ⓢ Automatic Electric Sales Corp., 1033 W. Van Buren St., Chicago 7, Ill.
- Ⓢ Brco Electronics Corp., 55 Vandam St., New York 13, N. Y.
- Ⓢ Hammarlund Mfg. Co., 460 W. 34th St., New York 1, N. Y.
- Ⓢ Intevox Corp., 2701 California Ave., Seattle 6, Wash.
- Ⓢ KELLOGG SWITCHBOARD & SUPPLY CO., 6650 S. Cicero Ave., Chicago 38, Ill. ADV. PG. 294.
- Ⓢ STEVENS-ARNOLD, INC., 22 Elkins St., South Boston, Mass. ADV. PG. 295.

SERVOMECHANISMS See Controls, Servo

SHAFTS—Flexible

- Ⓢ AMERICAN MOLDED PRODUCTS CO., 1644 N. Honore St., Chicago 22, Ill. ADV. PG. 382.
- Ⓢ Birnbach Radio Co., Inc., 145 Hudson St., New York, N. Y.
- Ⓢ JFD MFG. CO., 6101-23 Sixteenth Ave., Brooklyn, N. Y. ADV. PG. 407.
- Ⓢ JOHNSON CO., E. F., Waseca, Minn. ADV. PG. 118, 121.
- Ⓢ Kupfrian Mfg. Co., 218 Prospect Ave., Binghamton, N. Y.
- Ⓢ Lear, Inc., 110 Ionia Ave., N. W., Grand Rapids 2, Mich.
- Ⓢ Philco Corp., Tioga & C Sts., Philadelphia 34, Pa.
- Ⓢ STEWART MFG. CORP., F. W., 4311 Ravenswood Ave., Chicago 13, Ill. ADV. PG. 176.
- Ⓢ Stow Mfg. Co., 445 State St., Binghamton, N. Y.

Ⓟ indicates . . . IN PRODUCTION • AVAILABILITY • UNRESTRICTED FOR GENERAL USE

- ⓅTEFLON PRODUCTS DIVISION, U. S. GASKET CO., P. O. Box 93, Camden, N. J. ADV. PG. 176.
 ⓅWHITE DENTAL MFG. CO., S. S., Industrial Div., 10 E. 40th St., New York, N. Y. ADV. PG. 291.

SHAPERS—Television Signal

- ⓅMonarch Radio & Television Corp., 2430 Atlantic Ave., Brooklyn 33, N. Y.
 ⓅPOLARAD ELECTRONICS CORP., 100 Metropolitan Ave., Brooklyn 11, N. Y. ADV. PG. 184, 185.

SHIELDING—Electrostatic

- ⓅBelden Mfg. Co., 4647 W. Van Buren St., Chicago 44, Ill.
 ⓅBELLING & LEE, LTD., 366 Madison Ave., New York 17, N. Y. ADV. PG. 336.
 ⓅBoston Insulated Wire & Cable Co., 63 Bay St., Boston 25, Mass.
 ⓅBREEZE CORPS., INC., 41 S. Sixth St., Newark 7, N. J. ADV. PG. 193.
 ⓅHallett Mfg. Co., 1601 Florence Ave., Inglewood, Calif.
 ⓅMETAL TEXTILE CORP., 647 E. First Ave., Roselle, N. J. ADV. PG. 40.
 ⓅMetaplast Process, Inc., 9-17 37th Ave., Long Island City 1, N. Y.
 ⓅMICRO-CIRCUITS CO., New Buffalo, Mich. ADV. PG. 50.
 ⓅMuter Co., 1255 S. Michigan Ave., Chicago, Ill.
 ⓅUniform Tubes, Shurs Lane & Laruiston St., Roxborough, Philadelphia, Pa.
 ⓅYORK CO., INC., OTTO H., 69 Glenwood Place, East Orange, N. J. ADV. PG. 174.

SHIELDING—Radio Ignition

- ⓅACE ENGINEERING & MACHINE CO., 3642 N. Lawrence St., Philadelphia 40, Pa. ADV. PG. 318.
 ⓅAMERICAN BRASS CO., 25 Broadway, New York 4, N. Y. ADV. PG. 330.
 ⓅBelden Mfg. Co., 4647 W. Van Buren St., Chicago 44, Ill.
 ⓅBELLING & LEE, LTD., 366 Madison Ave., New York 17, N. Y. ADV. PG. 336.
 ⓅBirnback Radio Co., Inc., 145 Hudson St., New York, N. Y.
 ⓅBoston Insulated Wire & Cable Co., 63 Bay St., Boston 25, Mass.
 ⓅBREEZE CORPS., INC., 41 S. Sixth St., Newark 7, N. J. ADV. PG. 193.
 ⓅFiltron Co., Inc., The, 131-05 Fowler Ave., Flushing, N. Y.
 ⓅHallett Mfg. Co., 1601 Florence Ave., Inglewood, Calif.
 ⓅKupfrian Mfg. Co., 218 Prospect Ave., Binghamton, N. Y.
 ⓅMETAL TEXTILE CORP., 647 E. First Ave., Roselle, N. J. ADV. PG. 40.
 ⓅPRODUCT DEVELOPMENT CO., INC., Arlington, N. J. ADV. PG. 362.
 ⓅRunzel Cord & Wire Co., 4723-31 W. Montrose Ave., Chicago 41, Ill.
 ⓅScintilla Magneto Div., Bendix Aviation Corp., Sidney, N. Y.
 ⓅTITEFLEX, INC., 500 Frelinghuysen Ave., Newark 5, N. J. ADV. PG. 68.
 ⓅUniform Tubes, Shurs Lane and Laruiston St., Roxborough, Philadelphia, Pa.
 ⓅYORK CO., INC., OTTO H., 69 Glenwood Place, East Orange, N. J. ADV. PG. 174.

SHIELDING—Sheet or Screen

- ⓅAmerican Cladmetals Co., P. O. Box 544, Carnegie, Pa.
 ⓅInsuline Corp. of America, 36-02 35th Ave., Long Island City, N. Y.
 ⓅMETAL TEXTILE CORP., 647 E. First Ave., Roselle, N. J. ADV. PG. 40.
 ⓅYORK CO., INC., OTTO H., 69 Glenwood Place, East Orange, N. J. ADV. PG. 174.

SHIELDS—Cathode Ray Tube

- ⓅCossor (Canada) Ltd., 301-303 Windsor St., Halifax, N. S., Canada.
 ⓅDu Mont Laboratories, Inc., Allen B., Instrument Div., 1000 Main Ave., Clifton, N. J.
 ⓅMAGNETICS, INC., P. O. Box 761, Butler, Pa. ADV. PG. 381.
 ⓅMICRO-CIRCUITS CO., New Buffalo, Mich. ADV. PG. 50.
 ⓅMillen Mfg. Co., James, 150 Exchange St., Malden, Mass.
 ⓅMULTI-METAL CO., 1350 Garrison Ave., New York 59, N. Y. ADV. PG. 221.

SHIELDS—Coil

- ⓅAMERICAN MOLDED PRODUCTS CO., 1644 N. Honore St., Chicago 22, Ill. ADV. PG. 382.
 ⓅBunnell & Co., J. H., 81 Prospect St., Brooklyn, N. Y.
 ⓅCoil Winders, Inc., 61 Bergen St., Brooklyn 2, N. Y.

- ⓅHallett Mfg. Co., 1601 Florence Ave., Inglewood, Calif.
 ⓅInsuline Corp. of America, 36-02 35th Ave., Long Island City, N. Y.
 ⓅKOBZY TOOL CO., 1535 N. Dayton Ave., Chicago 22, Ill. ADV. PG. 343.
 ⓅMillen Mfg. Co., James, 150 Exchange St., Malden, Mass.
 ⓅPaul & Beekman Inc., 1801 Cortland St., Philadelphia 40, Pa.

SHIELDS—Lead

- ⓅAlpha Metals, Inc., 365 Hudson Ave., Brooklyn 1, N. Y.
 ⓅANCHOR METAL CO., 87 Walker St., New York 13, N. Y. ADV. PG. 270.
 ⓅATOMIC INSTRUMENT CO., 84 Massachusetts Ave., Cambridge 39, Mass. ADV. PG. 410.
 ⓅChicago Expansion Bolt Co., 1338 Concord Pl., Chicago 22, Ill.
 ⓅHallett Mfg. Co., 1601 Florence Ave., Inglewood, Calif.
 ⓅKelley-Koett Instrument Co., 962 York St., Cincinnati 14, Ohio.
 ⓅMacdonald & Co., Inc., W. S., 33 University Rd., Cambridge 38, Mass.
 ⓅNuclear Instrument & Chemical Corp., 223 W. Erie St., Chicago 10, Ill.
 ⓅNuclear Research Corp., 2707 Federal St., Philadelphia 46, Pa.
 ⓅRadiation Counter Laboratories, Inc., 1844 W. 21st St., Chicago 8, Ill.
 ⓅRunzel Cord & Wire Co., 4723-31 W. Montrose Ave., Chicago 41, Ill.
 ⓅStar Expansion Bolt Co., 147-149 Cedar St., New York 6, N. Y.
 ⓅTechnical Associates, 3730 San Fernando Rd., Glendale 4, Calif.
 ⓅTENSOLITE INSULATED WIRE CO., 198 Main St., Tarrytown, N. Y. ADV. PG. 316.

SHIELDS—Transformer

- ⓅMagnetic Metals Co., Hayes Ave., & 21st St., Camden, N. J.
 ⓅMAGNETICS, INC., P. O. Box 761, Butler, Pa. ADV. PG. 381.
 ⓅOLYMPIC METAL PRODUCTS CO., INC., Phillipsburg, N. J. ADV. PG. 358.
 ⓅThordarson-Meissner Mfg. Divisions, 500 W. Huron St., Chicago 10, Ill.

SHIELDS—Tube

- ⓅBELLING & LEE, LTD., 366 Madison Ave., New York 17, N. Y. ADV. PG. 336.
 ⓅBunnell & Co., J. H., 81 Prospect St., Brooklyn, N. Y.
 ⓅCINCH MFG. CORP., 1026 S. Homan Ave., Chicago 24, Ill. ADV. PG. 186, 187.
 ⓅClarke Instrument Div., National Electrical Machine Shops, Inc., 919 Jesup-Blair Drive, Silver Spring, Md.
 ⓅEBY, INC., HUGH H., 4700 Stenton Ave., Philadelphia 44, Pa. ADV. PG. 214.
 ⓅElco Corp., 190 W. Glenwood Ave., Philadelphia 40, Pa.
 ⓅFerricore, Inc., 15 School St., Yonkers 2, N. Y.
 ⓅGENERAL ACCESSORIES CO., LTD., 366 Madison Ave., New York 17, N. Y. ADV. PG. 336.
 ⓅGoat Co., Inc., Fred, 314 Dean St., Brooklyn, N. Y.
 ⓅInsuline Corp. of America, 36-02 35th Ave., Long Island City, N. Y.
 ⓅJFD MFG. CO., 6101-23 Sixteenth Ave., Brooklyn, N. Y. ADV. PG. 407.
 ⓅJOHNSON CO., E. F., Waseca, Minn. ADV. PG. 118, 121.
 ⓅJOHNSON & HOFFMAN, INC., 65 Ongley St., Rockville Center, N. Y. ADV. PG. 353.
 ⓅMETHODE MFG. CORP., 2265 W. St. Paul Ave., Chicago 47, Ill. ADV. PG. 347.
 ⓅMillen Mfg. Co., James, 150 Exchange St., Malden, Mass.
 ⓅMULTI-METAL CO., 1350 Garrison Ave., New York 59, N. Y. ADV. PG. 221.
 ⓅPhilco Corp., Tioga & C Sts., Philadelphia 34, Pa.
 ⓅSTAVER CO., INC., Box 431, Bayshore, N. Y. ADV. PG. 232.

SHIFTERS—Signal

- ⓅBassett, Inc., Rex, 307-311 N. W. First Ave., Fort Lauderdale, Fla.
 ⓅThordarson-Meissner Mfg. Divisions, 500 W. Huron St., Chicago 10, Ill.
 ⓅTRAD TELEVISION CORP., 1001 First Ave., Asbury Park, N. J. ADV. PG. 355.

SHUNTS—Meter

- ⓅAssociated Research, Inc., 3758 W. Belmont, Chicago 18, Ill.
 ⓅBurlington Instrument Co., Burlington, Iowa.
 ⓅCITATION PRODUCTS CO., 233 E. 146th St., New York 51, N. Y. ADV. PG. 388.

- ⓅCole Instrument Co., 1320 S. Grand Ave., Los Angeles 15, Calif.
 ⓅEsterline-Angus Co., Inc., P. O. Box 596, Indianapolis, Ind.
 ⓅGENERAL ELECTRIC CO., Schenectady 5, N. Y. ADV. PG. 1 to 22.
 ⓅINTERNATIONAL RESISTANCE CO., 401 N. Broad St., Philadelphia 8, Pa. ADV. PG. 134, 135.
 ⓅMARION ELECTRICAL INSTRUMENT CO., Manchester, N. H. ADV. PG. 200.
 ⓅMeters, Inc., 915 Westfield Blvd., Indianapolis 20, Ind.
 ⓅPrecision Resistor Co., 334 Badger Ave., Newark 8, N. J.
 ⓅReliance Instrument Co., 3027 W. Van Buren St., Chicago 12, Ill.
 ⓅSensitive Research Instrument Corp., 9 Elm Ave., Mt. Vernon, N. Y.
 ⓅSimpson Electric Co. Div., American Gage & Machine Co., 5218 W. Kinzie Street, Chicago 44, Ill.
 ⓅWelch Scientific Co., W. M., 1515 Sedgwick St., Chicago 10, Ill.
 ⓅWESTINGHOUSE ELECTRIC CORP., 511 Wood St., P. O. Box 868, Pittsburgh 30, Pa. ADV. PG. 107-113.

SIGNAL SHIFTER

See Shifters, Signal

SILICON

See Metals

SILICONE—Compounds

See Insulating Compounds

SLEEVES—Antenna Copper Splicing

- ⓅAlpha Metals, Inc., 365 Hudson Ave., Brooklyn 1, N. Y.

SLIDES—Chassis

- ⓅGRANT PULLEY & HARDWARE CO., 31-85 White-stone Parkway, Flushing, N. Y. ADV. PG. 158.
 ⓅLorentzen Inc., Levolor, 391 W. Broadway, New York, N. Y.
 ⓅNATIONAL CO., INC., 61 Sherman St., Malden 48, Mass. ADV. PG. 280, 281.
 ⓅRemler Co., Ltd., 2101 Bryant St., San Francisco 10, Calif.

SLIP RING ASSEMBLIES—Precision

- ⓅELECTRO TEC CORP., South Hackensack, N. J. ADV. PG. 399.

SOCKETS—Battery

- ⓅBELLING & LEE, LTD., 366 Madison Ave., New York 17, N. Y. ADV. PG. 336.
 ⓅCINCH MFG. CORP., 1026 S. Homan Ave., Chicago 24, Ill. ADV. PG. 186, 187.
 ⓅEBY, INC., HUGH H., 4700 Stenton Ave., Philadelphia 44, Pa. ADV. PG. 214.
 ⓅElco Corp., 190 W. Glenwood Ave., Philadelphia 40, Pa.
 ⓅFRANKLIN AIRLOOP CORP., 43-20 34th St., Long Island City, N. Y. ADV. PG. 45.
 ⓅFRANKLIN MFG. CORP., A. W., 43-20 34th St., Long Island City 1, N. Y. ADV. PG. 44.
 ⓅGENERAL ACCESSORIES CO., LTD., 366 Madison Ave., New York 17, N. Y. ADV. PG. 336.
 ⓅINDUSTRIAL HARDWARE MFG. CO., INC., 109 Prince St., New York, N. Y. ADV. PG. 360.
 ⓅJFD MFG. CO., 6101-23 Sixteenth Ave., Brooklyn, N. Y. ADV. PG. 407.
 ⓅPhilco Corp., Tioga & C Sts., Philadelphia 34, Pa.
 ⓅRICHARDSON CO., THE, 2767 Lake St., Melrose Park, Ill. ADV. PG. 310.

SOCKETS—Crystal

- ⓅCINCH MFG. CORP., 1026 S. Homan Ave., Chicago 24, Ill. ADV. PG. 186, 187.
 ⓅEBY, INC., HUGH H., 4700 Stenton Ave., Philadelphia 44, Pa. ADV. PG. 214.
 ⓅElco Corp., 190 W. Glenwood Ave., Philadelphia 40, Pa.
 ⓅELECTRONIC MECHANICS, INC., 70 Clifton Blvd., Clifton, N. J. ADV. PG. 309.
 ⓅFRANKLIN AIRLOOP CORP., 43-20 34th St., Long Island City, N. Y. ADV. PG. 45.
 ⓅFRANKLIN MFG. CORP., A. W., 43-20 34th St., Long Island City 1, N. Y. ADV. PG. 44.
 ⓅGENERAL ACCESSORIES CO., LTD., 366 Madison Ave., New York 17, N. Y. ADV. PG. 336.
 ⓅJOHNSON CO., E. F., Waseca, Minn. ADV. PG. 118, 121.
 ⓅKeystone Electronics Co., 423 Broome St., New York 12, N. Y.

Ⓜ indicates . . . IN PRODUCTION • AVAILABILITY • UNRESTRICTED FOR GENERAL USE

- ⓂMETHODE MFG. CORP., 2265 W. St. Paul Ave., Chicago 47, Ill. ADV. PG. 347.
- ⓂMillen Mfg. Co., James, 150 Exchange St., Malden, Mass.
- ⓂMykroy, Inc., Arlington Heights Airport, Arlington Heights, Ill.
- ⓂNATIONAL CO., INC., 61 Sherman St., Malden 48, Mass. ADV. PG. 280, 281.
- ⓂTEFLON PRODUCTS DIVISION, U. S. GASKET CO., P. O. Box 93, Camden, N. J. ADV. PG. 176.
- Westline Electronics Co., 11656 Olympic Blvd., Los Angeles 25, Calif.

SOCKETS—Dial and Pilot Light

- ⓂAEROLITE ELECTRONIC HARDWARE CORP., 507 26th St., Union City, N. J. ADV. PG. 355.
- ⓂALDEN PRODUCTS CO., 117 No. Main St., Brockton 64, Mass. ADV. PG. 327.
- ⓂDIAL LIGHT COMPANY OF AMERICA, INC., 900 Broadway, New York 3, N. Y. ADV. PG. 60.
- ⓂDrake Mfg. Co., 1713 Hubbard St., Chicago, Ill.
- ⓂFRANKLIN AIRLOOP CORP., 43-20 34th St., Long Island City, N. Y. ADV. PG. 45.
- ⓂFRANKLIN MFG. CORP., A. W., 43-20 34th St., Long Island City 1, N. Y. ADV. PG. 44.
- ⓂGENERAL ACCESSORIES CO., LTD., 366 Madison Ave., New York 17, N. Y. ADV. PG. 336.
- ⓂGeneral Cement Mfg. Co., 919 Taylor Ave., Rockford, Ill.
- ⓂGombos Co., Inc., John, 103 Montgomery St., Irvington 11, N. J.
- ⓂKirkland Co., H. R., 8 King St., Morristown, N. J.
- ⓂJOHNSON CO., E. F., Waseca, Minn. ADV. PG. 118, 121.
- ⓂKULKA ELECTRIC MFG. CO., INC., 30 South St., Mount Vernon, N. Y. ADV. PG. 317.
- ⓂMicarta Fabricators, Inc., 5324 Ravenswood Ave., Chicago 40, Ill.
- ⓂPhilco Corp., Tioga & C Sts., Philadelphia 34, Pa.
- ⓂSmith, Inc., Herman H., 436 18th St., Brooklyn 15, N. Y.
- ⓂUcinite Co. Division, United-Carr Fastener Corp., 459 Watertown St., Newtonville, Mass.
- ⓂUnited-Carr Fastener Corp., Cambridge 42, Mass.
- ⓂWade Electric Products Co., 211 Jacob St., Sturgis, Mich.

SOCKETS—Microwave Tube

- ⓂAMERICAN PHENOLIC CORPORATION, 1830 S. 54th Ave., Chicago 50, Ill. ADV. PG. 61.
- ⓂCINCH MFG. CORP., 1026 S. Homan Ave., Chicago 24, Ill. ADV. PG. 186, 187.
- ⓂElco Corp., 190 W. Glenwood Ave., Philadelphia 40, Pa.
- ⓂGENERAL ACCESSORIES CO., LTD., 366 Madison Ave., New York 17, N. Y. ADV. PG. 336.
- ⓂSelectar Industries, Inc., 401 E. 138th St., New York 54, N. Y.
- ⓂTEFLON PRODUCTS DIVISION, U. S. GASKET CO., P. O. Box 93, Camden, N. J. ADV. PG. 176.

SOCKETS—Miniature Sockets & Connectors

- ⓂALDEN PRODUCTS CO., 117 No. Main St., Brockton 64, Mass. ADV. PG. 327.
- ⓂAMERICAN PHENOLIC CORP., 1830 S. 54th Ave., Chicago 50, Ill. ADV. PG. 61.
- ⓂBELLING & LEE, LTD., 366 Madison Ave., New York 17, N. Y. ADV. PG. 336.
- ⓂCINCH MFG. CORP., 1026 S. Homan Ave., Chicago 24, Ill. ADV. PG. 186, 187.
- ⓂDrake Mfg. Co., 1713 Hubbard St., Chicago 22, Ill.
- ⓂEBY, INC., HUGH H., 4700 Stenton Ave., Philadelphia 44, Pa. ADV. PG. 214.
- ⓂElco Corp., 190 W. Glenwood Ave., Philadelphia 40, Pa.
- ⓂFRANKLIN AIRLOOP CORP., 43-20 34th St., Long Island City, N. Y. ADV. PG. 45.
- ⓂFRANKLIN MFG. CORP., A. W., 43-20 34th St., Long Island City 1, N. Y. ADV. PG. 44.
- ⓂGENERAL ACCESSORIES CO., LTD., 366 Madison Ave., New York 17, N. Y. ADV. PG. 336.
- ⓂGeneral Cement Mfg. Co., 919 Taylor Ave., Rockford, Ill.
- ⓂINDUSTRIAL HARDWARE MFG. CO., INC., 109 Prince St., New York, N. Y. ADV. PG. 360.
- ⓂJavex, 921 State, Garland, Texas.
- ⓂJOHNSON CO., E. F., Waseca, Minn. ADV. PG. 118, 121.
- ⓂJONES DIV., HOWARD B., CINCH MFG. CORP., 1026 S. Homan Ave., Chicago 24, Ill. ADV. PG. 186, 187.
- ⓂKINGS ELECTRONICS, 40 Marbledale Road, Tuckahoe, N. Y. ADV. PG. 180, 181.
- ⓂKULKA ELECTRIC MFG. CO., INC., 30 South St., Mount Vernon, N. Y.
- ⓂMETHODE MFG. CORP., 2265 W. St. Paul Ave., Chicago 47, Ill. ADV. PG. 347.
- ⓂMillen Mfg. Co., James, 150 Exchange St., Malden, Mass.
- ⓂMorse Co., Frank W., 1300 Soldiers Field Rd., Boston 35, Mass.
- ⓂMYCALEX TUBE SOCKET CORP., 60 Clifton Blvd., Clifton, N. J. ADV. PG. 258, 259.

- ⓂNATIONAL CO., INC., 61 Sherman St., Malden 48, Mass. ADV. PG. 280, 281.
- ⓂNational Tel-Tronics Corp., 35 St. Casmirs Ave., Yonkers, N. Y.
- ⓂPAINTON & CO., LTD., 366 Madison Ave., New York 17, N. Y. ADV. PG. 336.
- ⓂPhilco Corp., Tioga & C Sts., Philadelphia 34, Pa. Selectar Industries, Inc., 401 E. 138th St., New York 54, N. Y.
- ⓂSmith, Inc., Herman H., 436 18th St., Brooklyn 15, N. Y.
- ⓂTEFLON PRODUCTS DIVISION, U. S. GASKET CO., P. O. Box 93, Camden, N. J. ADV. PG. 176.
- ⓂUcinite Co. Division, United-Carr Fastener Corp., 459 Watertown St., Newtonville, Mass.
- ⓂUnited-Carr Fastener Corp., Cambridge 42, Mass.
- ⓂVECTOR ELECTRONIC CO., 1101 Riverside Drive, Los Angeles 31, Calif. ADV. PG. 283.

SOCKETS—Tube

- ⓂALDEN PRODUCTS CO., 117 No. Main St., Brockton 64, Mass. ADV. PG. 327.
- ⓂAMERICAN PHENOLIC CORPORATION, 1830 S. 54th Ave., Chicago 50, Ill. ADV. PG. 61.
- ⓂBELLING & LEE, LTD., 366 Madison Ave., New York 17, N. Y. ADV. PG. 336.
- ⓂBunnell & Co., J. H., 81 Prospect St., Brooklyn, N. Y.
- ⓂCINCH MFG. CORP., 1026 S. Homan Ave., Chicago 24, Ill. ADV. PG. 186, 187.
- ⓂEBY, INC., HUGH H., 4700 Stenton Ave., Philadelphia 44, Pa. ADV. PG. 214.
- ⓂELECTRONIC MECHANICS, INC., 70 Clifton Blvd., Clifton, N. J. ADV. PG. 309.
- ⓂEitel-McCullough, Inc., San Bruno, California.
- ⓂFRANKLIN AIRLOOP CORP., 43-20 34th St., Long Island City, N. Y. ADV. PG. 45.
- ⓂFRANKLIN MFG. CORP., A. W., 43-20 34th St., Long Island City 1, N. Y. ADV. PG. 44.
- ⓂGENERAL ACCESSORIES CO., LTD., 366 Madison Ave., New York 17, N. Y. ADV. PG. 336.
- ⓂHoward Mfg. Corp., 1401 S. Main St., Council Bluffs, Iowa.
- ⓂINDUSTRIAL HARDWARE MFG. CO., INC., 109 Prince St., New York, N. Y. ADV. PG. 360.
- ⓂInsuline Corp. of America, 36-02 35th Ave., Long Island City, N. Y.
- ⓂIsolantite Mfg. Corp., Stirling, N. J.
- ⓂJOHNSON CO., E. F., Waseca, Minn. ADV. PG. 118, 121.
- ⓂMETHODE MFG. CORP., 2265 W. St. Paul Ave., Chicago 47, Ill. ADV. PG. 347.
- ⓂMillen Mfg. Co., James, 150 Exchange St., Malden, Mass.
- ⓂMYCALEX TUBE SOCKET CORP., 60 Clifton Blvd., Clifton, N. J. ADV. PG. 258, 259.
- ⓂMykroy, Inc., Arlington Heights Airport, Arlington Heights, Ill.
- ⓂNATIONAL CO., INC., 61 Sherman St., Malden 48, Mass. ADV. PG. 280, 281.
- ⓂNational Tel-Tronics Corp., 35 St. Casmirs Ave., Yonkers, N. Y.
- ⓂPhilco Corp., Tioga & C Sts., Philadelphia 34, Pa.
- ⓂRemier Co., Ltd., 2101 Bryant St., San Francisco 10, Calif.
- ⓂTEFLON PRODUCTS DIVISION, U. S. GASKET CO., P. O. Box 93, Camden, N. J. ADV. PG. 176.
- ⓂUcinite Co. Division, United-Carr Fastener Corp., 459 Watertown St., Newtonville, Mass.
- ⓂUnited-Carr Fastener Corp., Cambridge 42, Mass.
- ⓂVECTOR ELECTRONIC CO., 1101 Riverside Drive, Los Angeles 31, Calif. ADV. PG. 283.

SOLDER

- ⓂAluminum Co. of America, Gulf Bldg., Pittsburgh 30, Pa.
- ⓂAlpha Metals, Inc., 365 Hudson Ave., Brooklyn 1, N. Y.
- ⓂANCHOR METAL CO., 87 Walker St., New York 13, N. Y. ADV. PG. 270.
- ⓂBrach Mfg. Corp., 200 Central Ave., Newark 4, N. J.
- ⓂBurnley Battery & Mfg. Co., Clay St., North East, Pa.
- ⓂCerro de Pasco Copper Corp., 40 Wall St., New York 5, N. Y.
- ⓂChase Brass & Copper Co., Inc., 236 Grand St., Waterbury 20, Conn.
- ⓂDivision Lead Co., 836 W. Kinzie St., Chicago 22, Ill.
- ⓂDUBOIS CO., LTD., 366 Madison Ave., New York 17, N. Y. ADV. PG. 336.
- ⓂEagle Electric Mfg. Co., Inc., 23-10 Bridge Plaza, S. Long Island City, N. Y.
- ⓂEastern Metals Industries Inc., 250 W. 54th St., New York 19, N. Y.
- ⓂEnthoven & Sons Ltd., H. J., London, England-Sls. Agt. Maurice H. Esser, Dept. A, 113 N. Water St., Rochester 4, N. Y.
- ⓂEutectic Welding Alloys Corp., 40 Worth St., New York 13, N. Y.
- ⓂFarrelloy Co., 1245 N. 26th St., Philadelphia 21, Pa.
- ⓂFederated Metals Div., American Smelting & Refining Co., 120 Broadway, New York 5, N. Y.
- ⓂGLASER LEAD CO. INC., 31 Wycoff Ave., Brooklyn 27, N. Y. ADV. PG. 357.
- ⓂJoyal Products, Inc., 56 Belmont Ave., Newark, N. J.

- ⓂKESTER SOLDER CO., 4212 Wrightwood Ave., Chicago 39, Ill. ADV. PG. 416.
- ⓂLenk Mfg. Co., The, 30 Cummington St., Boston 15, Mass.
- ⓂMAKEPEACE CO., D. E., Attleboro, Mass. ADV. PG. 72.
- ⓂMULTICORE SALES CORP., 164 Duane St., New York 13, N. Y. ADV. PG. 39.
- ⓂNational Lead Co., 111 Broadway, New York 6, N. Y.
- ⓂNew York Solder Co., 684 E. 133rd St., New York 54, N. Y.
- ⓂSoldering Specialties Co., Summit, N. J.
- ⓂStandard Metals Corp., 262 Broad St., North Attleboro, Mass.
- ⓂSuper Flow Solder Co., Inc., 90 State St., Albany, N. Y.
- ⓂWestern Gold & Platinum Works, 589 Bryant St., San Francisco, Calif.

SOLDER—Aluminum

- ⓂAmerican Solder & Flux Co., 2152 E. Norris St., Philadelphia 25, Pa.
- ⓂANCHOR METAL CO., 87 Walker St., New York 13, N. Y. ADV. PG. 270.
- ⓂDivision Lead Co., 836 W. Kinzie St., Chicago 22, Ill.
- ⓂFarrelloy Co., 1245 N. 26th St., Philadelphia 21, Pa.
- ⓂFederated Metals Div., American Smelting & Refining Co., 120 Broadway, New York 5, N. Y.
- ⓂJohnson Mfg. Co., Inc., Mount Vernon, Iowa.
- ⓂKESTER SOLDER CO., 4212 Wrightwood Ave., Chicago 39, Ill. ADV. PG. 357.
- ⓂLenk Mfg. Co., The, 30 Cummington St., Boston 15, Mass.

SOLDER—Platinum

- ⓂBaker & Co., Inc., 113 Astor St., Newark 5, N. J.
- ⓂDivision Lead Co., 836 W. Kinzie St., Chicago 22, Ill.
- ⓂGENERAL PLATE DIVISION, Metals & Control Corp., Attleboro, Mass. ADV. PG. 300.
- ⓂGoldsmith Bros. Smelting & Refining Co., 111 N. Washburn Ave., Chicago 2, Ill.
- ⓂHandy & Harman, 82 Fulton St., New York 38, N. Y.
- ⓂNEY CO., J. M., 179 Elm St., Hartford, Conn. ADV. PG. 246.
- ⓂSecor Metals Corp., 228 E. 45th St., New York 17, N. Y.
- ⓂTricon Mfg. Co., 8318 S. Racine Ave., Chicago, Ill.
- ⓂWestern Gold & Platinum Works, 589 Bryant St., San Francisco, Calif.

SOLDER—Rings and Preforms

- ⓂAlpha Metals, Inc., 365 Hudson Ave., Brooklyn 1, N. Y.
- ⓂANCHOR METAL CO., 87 Walker St., New York 13, N. Y. ADV. PG. 270.
- ⓂDivision Lead Co., 836 W. Kinzie St., Chicago 22, Ill. Eutectic Welding Alloys Corp., 40 Worth St., New York 13, N. Y.
- ⓂGENERAL PLATE DIVISION, Metals & Controls Corp., Attleboro, Mass. ADV. PG. 300.
- ⓂGLASER LEAD CO., INC., 31 Wycoff Ave., Brooklyn 27, N. Y. ADV. PG. 416.
- ⓂHandy & Harman, 82 Fulton St., New York 38, N. Y.
- ⓂKESTER SOLDER CO., 4212 Wrightwood Ave., Chicago 39, Ill. ADV. PG. 357.
- ⓂKrieg & Co., Charles W., 52 Dickerson St., Newark, N. J.
- ⓂLenk Mfg. Co., The, 30 Cummington St., Boston 15, Mass.
- ⓂMAKEPEACE CO., D. E., Attleboro, Mass. ADV. PG. 72.
- ⓂNational Lead Co., 111 Broadway, New York 6, N. Y.
- ⓂNEY CO., J. M., 179 Elm St., Hartford, Conn. ADV. PG. 246.
- ⓂSoldering Specialties Co., Summit, N. J.
- ⓂTricon Mfg. Co., 8318 S. Racine Ave., Chicago, Ill.
- ⓂWestern Gold & Platinum Works, 589 Bryant St., San Francisco, Calif.

SOLDER—Silver

- ⓂANCHOR METAL CO., 87 Walker St., New York 13, N. Y. ADV. PG. 270.
- ⓂBaker & Co., Inc., 113 Astor St., Newark 5, N. J.
- ⓂChase Brass & Copper Co., Inc., 236 Grand St., Waterbury 20, Conn.
- ⓂDivision Lead Co., 836 W. Kinzie St., Chicago 22, Ill.
- ⓂEastern Smelting & Refining Corp., 107-109 W. Brookline St., Boston 18, Mass.
- ⓂEutectic Welding Alloys Corp., 40 Worth St., New York 13, N. Y.
- ⓂFarrelloy Co., 1245 N. 26th St., Philadelphia 21, Pa.
- ⓂFederated Metals Div., American Smelting & Refining Co., 120 Broadway, New York 5, N. Y.
- ⓂGENERAL PLATE DIVISION, Metals & Controls Corp., Attleboro, Mass. ADV. PG. 300.
- ⓂGoldsmith Bros. Smelting & Refining Co., 111 N. Washburn Ave., Chicago 2, Ill.
- ⓂHandy & Harman, 82 Fulton St., New York 38, N. Y.
- ⓂMAKEPEACE CO., D. E., Attleboro, Mass. ADV. PG. 72.

(V) indicates . . . **IN PRODUCTION • AVAILABILITY • UNRESTRICTED FOR GENERAL USE**

- Ⓥ National Lead Co., 111 Broadway, New York 6, N. Y.
- Ⓥ NEY CO., J. M., 179 Elm St., Hartford, Conn. ADV. PG. 246.
- Ⓥ Soldering Specialties Co., Summit, N. J.
- Ⓥ Standard Metals Corp., 262 Broad St., North Attleboro, Mass.
- Ⓥ Tricon Mfg. Co., 8318 S. Racine Ave., Chicago, Ill.

SOLDERING IRONS—Electric
See Irons, Electric Soldering

SOLENOIDS

- Ⓥ Automatic Electric Sales Corp., 1033 W. Van Buren St., Chicago 7, Ill.
- Ⓥ Caltron Co., 1406 S. Hobart Blvd., Los Angeles 6, Calif.
- Ⓥ Cannon Electric Development Co., 3209 Humboldt St., Los Angeles 31, Calif.
- Ⓥ COMAR ELECTRIC CO., 3349 W. Addison St., Chicago 18, Ill. ADV. PG. 335.
- Ⓥ Connecticut Telephone & Electric Corp., 70 Britannia St., Meriden, Conn.
- Ⓥ Davis & Co., Inc., Dean W., 3418 N. Milwaukee Ave., Chicago, Ill.
- Ⓥ DIETZ DESIGN & MFG. CO., Grandview 6, Mo. ADV. PG. 323.
- Ⓥ Eastern Air Devices, Inc., 585 Dean St., Brooklyn 17, N. Y.
- Ⓥ Edwards Company, Inc., 86 Boston Post Rd., Norwalk, Conn.
- Ⓥ GENERAL ELECTRIC CO., Schenectady 5, N. Y. ADV. PG. 1 to 22.
- Ⓥ GUARDIAN ELECTRIC MFG. CO., 1621 W. Walnut St., Chicago 12, Ill. ADV. PG. 147.
- Ⓥ HOULIHAN CO., T. J., 2508-14 W. Lawrence St., Chicago 25, Ill. ADV. PG. 336.
- Ⓥ McQuay-Norris Mfg. Co., 2320 Marconi Ave., St. Louis 10, Mo.
- Ⓥ Magnavox Co., The Components Div., Fort Wayne 4, Indiana.
- Ⓥ Monroe Coil Co., 2839 N. Narragansett Ave., Chicago 34, Ill.
- Ⓥ Neomatic Inc., 879 Wellesley Ave., Los Angeles 49, Calif.
- Ⓥ Peerless Electrical Products Co., Div. of Altec-Lansing Corp., 6920 McKinley Ave., Los Angeles 1, Calif.
- Ⓥ PHILLIPS CONTROL CORP., 84 W. Jefferson St., Joliet, Ill. ADV. PG. 387.
- Ⓥ PICKERING & CO., 309 Woods Ave., Oceanside, N. Y. ADV. PG. 284.
- Ⓥ R. B. M. Div., Essex Wire Corp., Logansport, Ind.
- Ⓥ RADIO CORES, INC., 9540 Tully Ave., Oak Lawn, Ill. ADV. PG. 396.
- Ⓥ STANDARD COIL PRODUCTS CO., 2329 N. Pulaski Rd., Chicago 39, Ill. ADV. PG. 97.

SOLENOIDS—Rotary

- Ⓥ Davis & Co., Inc., Dean W., 3418 N. Milwaukee Ave., Chicago, Ill.
- Ⓥ LELAND, INC., G. H., 125 Webster St., Dayton 2, Ohio. ADV. PG. 394, 395.

SONAR

- Ⓥ Bludworth Marine Div., National-Simplex-Bludworth, Inc., 92 Gold St., New York 38, N. Y.
- Ⓥ RAYTHEON MFG. CO., Equipment Sales Div., Waltham 54, Mass. ADV. PG. 80, 81.

SORTERS—Electronic

See Controls—Counting & Sorting

SOUND SYSTEMS—Complete

- Ⓥ ALLIED RADIO CORP., 833 W. Jackson Blvd., Chicago 7, Ill. ADV. PG. 238.
- Ⓥ Altec Lansing Corp., 9356 Santa Monica Blvd., Beverly Hills, Calif.
- Ⓥ BARKER & WILLIAMSON, 235 Fairfield Ave., Upper Darby, Pa. ADV. PG. 292.
- Ⓥ Arlington Electric Products, Inc., 500 W. 52nd St., New York 19, N. Y.
- Ⓥ Bell Sound Systems, Inc., 555 Marion Rd., Columbus 7, Ohio.
- Ⓥ Berndt-Bach, Inc., 7373 Beverly Blvd., Los Angeles 36, Calif.
- Ⓥ Boom Electric & Amplifier Co., 1227 W. Washington Blvd., Chicago 7, Ill.
- Ⓥ Breco Electronics Corp., 55 Vandam St., New York 13, N. Y.
- Ⓥ Califone Corp., 1041 N. Sycamore Ave., Hollywood 38, Calif.
- Ⓥ Cossor (Canada) Ltd., 301-303 Windsor St., Halifax, N. S., Canada.
- Ⓥ Dilks Co., The, Seymour, Conn.
- Ⓥ Executone, Inc., 415 Lexington Ave., New York 17, N. Y.
- Ⓥ Gai Tronics, 412 Washington St., Reading, Pa.
- Ⓥ Galbraith & Son Electric Corp., C. C., 450 Sixth Ave., New York 11, N. Y.

- Ⓥ Hold Audio Industries, 9215 Venice Blvd., Los Angeles 34, Calif.
- Ⓥ Magna Electronics Co., 3707-11 W. Jefferson Blvd., Los Angeles 16, Calif.
- Ⓥ Maurer, Inc., J. A., 37-01 31st St., Long Island City, N. Y.
- Ⓥ Newcomb Audio Products Co., 6824 Lexington Ave., Hollywood 38, Calif.
- Ⓥ Operadio Mfg. Co., 135th & Indiana Sts., St. Charles, Ill.
- Ⓥ Pentron Corp., The, 221 E. Cullerton St., Chicago 16, Ill.
- Ⓥ Precision Electronics, Inc., 643 Milwaukee Ave., Chicago 22, Ill.
- Ⓥ RADIO CORP. OF AMERICA, RCA Victor Div., General Offices, Camden, N. J. ADV. PG. 177, Inside Back & Back Covers.
- Ⓥ Rauland-Borg Corp., 3523 W. Addison St., Chicago 18, Ill.
- Ⓥ Schuimerich Electronics, Inc., Sellersville, Pa.
- Ⓥ Simpson Mfg. Co., Inc., Mark, 32-28 49th St., Long Island City 3, N. Y.
- Ⓥ Stromberg-Carlson Co., Rochester 13, N. Y.
- Ⓥ Topping Mfg. Co., 75 Pueblo St., San Francisco 24, Calif.
- Ⓥ Z & W Machine Products, Inc., 5151 St. Clair Ave., Cleveland 3, Ohio.

SOURCES—Alpha Ray

- Ⓥ ATOMIC INSTRUMENT CO., 84 Massachusetts Ave., Cambridge 39, Mass. ADV. PG. 410.
- Ⓥ Nuclear Measurements Corp., 3339 Central Ave., Indianapolis 5, Ind.
- Ⓥ Nuclear Research Corp., 2707 Federal St., Philadelphia 46, Pa.
- Ⓥ U. S. Radium Corp., 535 Pearl St., New York 7, N. Y.

SPEAKERS

See Loudspeakers

SPECTROMETERS—Mass

- Ⓥ Consolidated Engineering Corp., 300 N. Sierra Madre Villa, Pasadena 8, Calif.
- Ⓥ GENERAL ELECTRIC CO., Schenectady 5, N. Y. ADV. PG. 1 to 22.
- Ⓥ Measurement Engineering Ltd., Arnprior, Ontario, Canada.
- Ⓥ Process & Instruments, 60 Greenpoint Ave., Brooklyn 22, N. Y.
- Ⓥ Vacuum Electronic Engineering Co., 316 37th St., Brooklyn 2, N. Y.

SPECTROMETERS and SPECTROGRAPHS

- Ⓥ Applied Research Laboratories, 4336 San Fernando Rd., Glendale 4, Calif.
- Ⓥ Baird Associates, Inc., 33 University Rd., Cambridge 38, Mass.
- Ⓥ Bausch & Lomb Optical Co., 635 St. Paul St., Rochester 2, N. Y.
- Ⓥ Biddle Co., James G., 1316 Arch St., Philadelphia 7, Pa.
- Ⓥ Central Scientific Co., 1700 Irving Park Rd., Chicago 13, Ill.
- Ⓥ Farrand Optical Co., Inc., Bronx Blvd. at 238th St., New York 70, N. Y.
- Ⓥ Gaertner Scientific Corp., 1201 Wrightwood Ave., Chicago 14, Ill.
- Ⓥ GENERAL ELECTRIC CO., Schenectady 5, N. Y. ADV. PG. 1 to 22.
- Ⓥ Jarrell-Ash Co., 165 Newbury St., Boston 16, Mass.
- Ⓥ MARCONI INSTRUMENTS, LTD., 23 Beaver St., New York 4, N. Y. ADV. PG. 270.
- Ⓥ Perkin-Elmer Corp., The, Main Ave., Norwalk, Conn.
- Ⓥ PRECISE MEASUREMENTS CO., 942 Kings Highway, Brooklyn 23, N. Y. ADV. PG. 401.
- Ⓥ Standard Telephones & Cables Ltd., Connaught House, Aldwych, London, W. C. 2, England.
- Ⓥ Welch Scientific Co., W. M., 1515 Sedgwick St., Chicago 10, Ill.

SPECTROPHOTOMETERS

- Ⓥ American Optical Co., Box A, Buffalo 15, N. Y.
- Ⓥ Applied Physics Corp., 362 W. Colorado St., Pasadena 1, Calif.
- Ⓥ Baird Associates, Inc., 33 University Rd., Cambridge 38, Mass.
- Ⓥ Bausch & Lomb Optical Co., 635 St. Paul St., Rochester 2, N. Y.
- Ⓥ Beckman Instruments, Inc., 820 Mission St., South Pasadena, Calif.
- Ⓥ Biddle Co., James G., 1316 Arch St., Philadelphia 7, Pa.
- Ⓥ Central Scientific Co., 1700 Irving Park Rd., Chicago 13, Ill.
- Ⓥ Coleman Instruments, Inc., 318 Madison St., Maywood, Ill.
- Ⓥ Farrand Optical Co., Inc., Bronx Blvd. at 238th St., New York 70, N. Y.
- Ⓥ Gaertner Scientific Corp., 1201 Wrightwood Ave., Chicago 14, Ill.

- Ⓥ GENERAL ELECTRIC CO., Schenectady 5, N. Y. ADV. PG. 1 to 22.
- Ⓥ Jarrell-Ash Co., 165 Newbury St., Boston 16, Mass.
- Ⓥ Perkin-Elmer Corp., The, Main Ave., Norwalk, Conn.
- Ⓥ Photovolt Corp., 95 Madison Ave., New York 16, N. Y.
- Ⓥ Process & Instruments, 60 Greenpoint Ave., Brooklyn 22, N. Y.
- Ⓥ Thompson & Associates, John E., 7210 S. Yates Ave., Chicago 49, Ill.

SPECTROSCOPIC SOURCE UNITS

- Ⓥ Applied Research Labs., 4336 San Fernando Rd., Glendale 4, Calif.
- Ⓥ Baird Associates, Inc., 33 University Ave., Cambridge 38, Mass.
- Ⓥ Bausch & Lomb Optical Co., 635 St. Paul St., Rochester 2, N. Y.
- Ⓥ Jarrell-Ash Co., 165 Newbury St., Boston 16, Mass.
- Ⓥ Leeds & Northrup Co., 4970 Stenton Ave., Philadelphia 44, Pa.

SPRINGS

- Ⓥ Accurate Spring Mfg. Co., 3811 W. Lake St., Chicago, Ill.
- Ⓥ Ace Spring Mfg Co., 77 W. Houston St., New York 12, N. Y.
- Ⓥ American Steel & Wire Co., Rockefeller Bldg., Cleveland 13, Ohio.
- Ⓥ ART WIRE & STAMPING CO., 227 High St., Newark 2, N. J. ADV. PG. 38.
- Ⓥ Chatillon & Sons, John, 93 Cliff St., New York 38, N. Y.
- Ⓥ Dudek & Bock Spring & Mfg Co., 2100 W. Fulton, Chicago 12, Ill.
- Ⓥ General Cement Mfg. Co., 919 Taylor Ave., Rockford, Ill.
- Ⓥ Gorrell & Gorrell, Haworth, N. J.
- Ⓥ Hunter Spring Co., Lansdale, Pa.
- Ⓥ INSTRUMENT SPECIALTIES CO., INC., 254 Bergen Blvd., Little Falls, N. J. ADV. PG. 320.
- Ⓥ Jones Spring Co., W. B., 124 E. 7th St., Cincinnati, Ohio.
- Ⓥ LEE MECHANICAL LABS. Div. of Lee Spring Co., Inc., 30 Main St., Brooklyn 1, N. Y. 303
- Ⓥ PIX MFG. CO., INC., 24 Bedford St., Newark, N. J. ADV. PG. 136.
- Ⓥ Raymond Mfg. Co., Div. of Associated Spring Corp., 226 S. Center St., Corry, Pa.
- Ⓥ Reliable Spring & Wire Forms Co., Fulton Rd. & Paris Ave., Cleveland 9, Ohio.
- Ⓥ Schott Co., Walter L., 3225 Exposition Pl., Los Angeles 18, Calif.
- Ⓥ WEBSTER SPRING CORP., 176-182 Johnson St., Brooklyn 1, N. Y. ADV. PG. 394.

SPRINGS—Antenna Tension

- Ⓥ Chatillon & Sons, John, 93 Cliff St., New York 38, N. Y.
- Ⓥ Raymond Mfg Co., Div. of Associated Spring Corp., 226 S. Center St., Corry, Pa.
- Ⓥ Ward Products Corp., Div. of The Gabriel Corp., 1523 E. 45th St., Cleveland 3, Ohio.
- Ⓥ WEBSTER SPRING CORP., 176-182 Johnson St., Brooklyn 1, N. Y. ADV. PG. 394.

SPRINGS—Instrument Hairsprings

- Ⓥ Chatillon & Sons, John, 93 Cliff St., New York 38, N. Y.
- Ⓥ Dudek & Bock Spring & Mfg. Co., 2100 W. Fulton, Chicago 12, Ill.
- Ⓥ INSTRUMENT SPECIALTIES CO., INC., 254 Bergen Blvd., Little Falls, N. J. ADV. PG. 320.
- Ⓥ Manross & Sons, F. N. Division of Associated Spring Corp., Bristol, Conn.

SPRINGS—Precision

- Ⓥ Accurate Spring Mfg. Co., 3811 W. Lake St., Chicago, Ill.
- Ⓥ American Steel & Wire Co., Rockefeller Bldg., Cleveland 13, Ohio.
- Ⓥ Chatillon & Sons, John, 93 Cliff St., New York 7, N. Y.
- Ⓥ Dudek & Bock Spring & Mfg. Co., 2100 W. Fulton, Chicago 12, Ill.
- Ⓥ Hunter Spring Co., Lansdale, Pa.
- Ⓥ INSTRUMENT SPECIALTIES CO., INC., 254 Bergen Blvd., Little Falls, N. J. ADV. PG. 320.
- Ⓥ LEE MECHANICAL LABS. Div. of Lee Spring Co., Inc., 30 Main St., Brooklyn 1, N. Y. ADV. PG. 303.
- Ⓥ LEWIS SPRING & MFG. CORP., 2656 W. North Ave., Chicago 47, Ill. ADV. PG. 293.
- Ⓥ Manross & Sons, F. N., Div. of Associated Spring Corp., Bristol, Conn.
- Ⓥ PIX MFG. CO., INC., 24 Bedford St., Newark, N. J. ADV. PG. 136.
- Ⓥ Raymond Mfg. Co. Div. of Associated Spring Corp., 226 S. Center St., Corry, Pa.

V indicates . . . IN PRODUCTION • AVAILABILITY • UNRESTRICTED FOR GENERAL USE

- Ⓢ Reliable Spring & Wire Forms Co., Fulton Rd. & Paris Ave., Cleveland 9, Ohio.
- Ⓢ WEBSTER SPRING CORP., 176-182 Johnson St., Brooklyn 1, N. Y. ADV. PG. 394.

STANDARDS—Capacitance

- Ⓢ Brown Electro-Measurement Corp., 4637 S. E. Hawthorne Blvd., Portland 15, Ore.
- Ⓢ FREED TRANSFORMER CO., INC., 1736 Weirfield St., Brooklyn 27, N. Y. ADV. PG. 149.
- Ⓢ GENERAL RADIO CO., 275 Massachusetts Ave., Cambridge 39, Mass. ADV. PG. 48, 49.
- Ⓢ Leeds & Northrup Co., 4970 Stenton Ave., Philadelphia 44, Pa.
- Ⓢ MacLeod & Hanopol Inc., 10 Joiner St., Charlestown 29, Mass.
- Ⓢ Muirhead & Co., Inc., Beckenham-Kent-England.

STANDARDS—Frequency

- Ⓢ AIRMEC LABORATORIES, LTD., 366 Madison Ave., New York 17, N. Y. ADV. PG. 336.
- Ⓢ AMERICAN TIME PRODUCTS, INC., 580 Fifth Ave., New York 19, N. Y. ADV. PG. 226.
- Ⓢ BARKER & WILLIAMSON, 235 Fairfield Ave., Upper Darby, Pa. ADV. PG. 292.
- Ⓢ Bassett Inc., Rex, 307-311 N. W. First Ave., Fort Lauderdale, Fla.
- Ⓢ Berkeley Scientific Corp., 2200 Wright Ave., Richmond, Calif.
- Ⓢ BLILEY ELECTRIC CO., Union Station Bldg., Erie Pa. ADV. PG. 311, 407.
- Ⓢ BROWNING LABORATORIES, INC., 750 Main St., Winchester, Mass. ADV. PG. 257.
- Ⓢ CLARK CRYSTAL CO., 2 Farm Rd., Marlboro, Mass. ADV. PG. 366.
- Ⓢ Dallons Labs., 5066 Santa Monica Blvd., Los Angeles, Calif.
- Ⓢ FREED TRANSFORMER CO., INC., 1736 Weirfield St., Brooklyn 27, N. Y. ADV. PG. 149.
- Ⓢ GENERAL RADIO CO., 275 Massachusetts Ave., Cambridge 39, Mass. ADV. PG. 48, 49.
- Ⓢ Hathaway Instrument Co., 1315 S. Clarkson St., Denver 10, Colo.
- Ⓢ Jefferson, Inc., Ray, 40 E. Merrick Rd., Freeport, N. Y.
- Ⓢ KNIGHTS CO., JAMES, 131 S. Wells St., Sandwich, Ill. ADV. PG. 328.
- Ⓢ MEASUREMENTS CORP., Boonton, N. J. ADV. PG. 99.
- Ⓢ Millen Mfg. Co., James, 150 Exchange St., Malden, Mass.
- Ⓢ NORRMAN LABORATORIES, ERNST, Williams Bay, Wis. ADV. PG. 346.
- Ⓢ Piezo Products Co., Whitney St., Framingham, Mass.
- Ⓢ POLYTECHNIC RESEARCH & DEVELOPMENT CO., INC., 202 Tillary St., Brooklyn 1, N. Y. ADV. PG. 172, 173.
- Ⓢ POTTER INSTRUMENT CO., INC., 115 Cutter Mill Rd., Great Neck, N. Y. ADV. PG. 318.
- Ⓢ REEVES-HOFFMAN CORP., 321 Cherry St., Carlisle, Pa. ADV. PG. 286.
- Ⓢ Riverbank Laboratories, Dept. of Engineering, Geneva, Ill.
- Ⓢ SPERRY GYROSCOPE CO., Div. of Sperry Corp., Great Neck, N. Y. ADV. PG. 103, 104.
- Ⓢ Standard Telephones & Cables Ltd., Connaught House, Aldwych, London, W. S. 2, England.
- Ⓢ Valpey Crystals, Highland St., Holliston 11, Mass.
- Ⓢ Varo Mfg. Co., Inc., Box 638, Garland, Tex.
- Ⓢ Westline Electronics Co., 11656 Olympic Blvd., Los Angeles 25, Calif.

STANDARDS—Gamma Ray

- Ⓢ ATOMIC INSTRUMENT CO., 84 Massachusetts Ave., Cambridge 39, Mass. ADV. PG. 410.
- Ⓢ Nuclear Instrument & Chemical Corp., 223 W. Erie St., Chicago 10, Ill.
- Ⓢ Tracerlab, Inc., 130 High St., Boston 10, Mass.
- Ⓢ U. S. Radium Corp., 535 Pearl St., New York 7, N. Y.

STANDARDS—Inductance

- Ⓢ FREED TRANSFORMER CO., INC., 1736 Weirfield St., Brooklyn 27, N. Y. ADV. PG. 149.
- Ⓢ GENERAL RADIO CO., 275 Massachusetts Ave., Cambridge 39, Mass. ADV. PG. 48, 49.
- Ⓢ Leeds & Northrup Co., 4970 Stenton Ave., Philadelphia 44, Pa.
- Ⓢ MARCONI INSTRUMENTS, LTD., 23 Beaver St., New York 4, N. Y. ADV. PG. 270.
- Ⓢ U. S. ELECTRONICS CORP., 276 Warren St., Lyndhurst, N. J. ADV. PG. 76.
- Ⓢ Wheeler Laboratories, Inc., Great Neck, N. Y.

STANDARDS—Laboratory Time

- Ⓢ AIRMEC LABORATORIES, LTD., 366 Madison Ave., New York 17, N. Y. ADV. PG. 336.
- Ⓢ AMERICAN TIME PRODUCTS INC., 580 Fifth Ave., New York 19, N. Y. ADV. PG. 226.
- Ⓢ GENERAL RADIO CO., 275 Massachusetts Ave., Cambridge 39, Mass. ADV. PG. 48, 49.

- Ⓢ NORRMAN LABORATORIES, ERNST, Williams Bay, Wis. ADV. PG. 346.
- Ⓢ STANDARD ELECTRIC TIME CO., THE, Logan St., Springfield, Mass. ADV. PG. 40.
- Ⓢ Varo Mfg. Co., Inc., Box 638, Garland, Texas.

STANDARDS—Resistance

- Ⓢ Brown Electro-Measurement Corp., 4637 S. E. Hawthorne Blvd., Portland 15, Ore.
- Ⓢ GENERAL RADIO CO., 275 Massachusetts Ave., Cambridge 39, Mass. ADV. PG. 48, 49.
- Ⓢ Leeds & Northrup Co., 4970 Stenton Ave., Philadelphia 44, Pa.
- Ⓢ PAINTON & CO., LTD., 366 Madison Ave., New York 17, N. Y. ADV. PG. 336.
- Ⓢ Rubicon Co., 3761 Ridge Ave., Philadelphia 42, Pa.
- Ⓢ Sensitive Research Instrument Corporation, 9 Elm Avenue, Mount Vernon, N. Y.
- Ⓢ Special Instruments Laboratories, Inc., 1003 Highland Ave., Knoxville, Tenn.

STANDARDS EQUIPMENT—Calibration

- Ⓢ AIRMEC LABORATORIES, LTD., 366 Madison Ave., New York 17, N. Y. ADV. PG. 336.
- Ⓢ INDUSTRIAL ELECTRONICS, INC., 8080 Wheeler St., Detroit 10, Mich. ADV. PG. 234, 235.
- Ⓢ Leeds & Northrup Co., 4970 Stenton Ave., Philadelphia 44, Pa.
- Ⓢ MARCONI INSTRUMENTS, LTD., 23 Beaver St., New York 4, N. Y. ADV. PG. 270.
- Ⓢ MEASUREMENTS CORP., Boonton, N. J. ADV. PG. 99.
- Ⓢ Radio Frequency Labs., Inc., Boonton 2, N. J.
- Ⓢ Rubicon Co., 3761 Ridge Ave., Philadelphia 42, Pa.
- Ⓢ Sensitive Research Instrument Corp., 9 Elm Ave., Mt. Vernon, N. Y.

STANDS—Microphone

- Ⓢ American Microphone Co., 370 S. Fair Oaks Ave., Pasadena 1, Calif.
- Ⓢ Astatic Corp., The, Conneaut, Ohio.
- Ⓢ Atlas Sound Corp., 1443 39th St., Brooklyn 18, N. Y.
- Ⓢ Bogen Co., Inc., David, 663 Broadway, New York 12, N. Y.
- Ⓢ Eastern Mike-Stand Co., 56 Christopher Ave., Brooklyn 12, N. Y.
- Ⓢ ELECTRO-VOICE, INC., Buchanan, Mich. ADV. PG. 345.
- Ⓢ General Cement Mfg. Co., 919 Taylor Ave., Rockford, Ill.
- Ⓢ Olesen Co., Otto K., 1534 Cahuenga, Hollywood 28, Calif.
- Ⓢ Racon Electric Co., Inc., 52 East 19th St., New York 3, N. Y.
- Ⓢ RADIO CORP. OF AMERICA, RCA Victor Div., General Offices, Camden, N. J. ADV. PG. 177, Inside Back & Back Covers.
- Ⓢ Special Products Co., Silver Spring, Md.
- Ⓢ TRIX ELECTRICAL MFG. CO., LTD., 366 Madison Ave., New York 17, N. Y. ADV. PG. 336.
- Ⓢ TURNER CO., THE, 909 17th Street, N.E., Cedar Rapids, Iowa. ADV. PG. 73.

STANDS—Speaker

- Ⓢ Atlas Sound Corp., 1443 39th St., Brooklyn 18, N. Y.
- Ⓢ ELECTRO-VOICE, INC., Buchanan, Mich. ADV. PG. 345.
- Ⓢ Racon Electric Co., 52 E. 19th St., New York 3, N. Y.

STEATITE

See Insulation Materials

STETHOGRAPHS AND STETHOPHONES

- Ⓢ EDIN CO., INC., 207 Main St., Worcester, Mass. ADV. PG. 285.
- Ⓢ Maico Co., Inc., 21 N. 3rd St., Minneapolis, Minn.
- Ⓢ SANBORN CO., 39 Osborn St., Cambridge 39, Mass. ADV. PG. 391.

STETHOSCOPES—Amplifying

- Ⓢ EDIN CO., INC., 207 Main St., Worcester, Mass. ADV. PG. 285.
- Ⓢ Electro-Medical Lab., Inc., South Woodstock, Vt.
- Ⓢ Feiler Engineering Co., 8026 Monticello Ave., Skokie, Ill.
- Ⓢ Maico Co., Inc., 21 N. 3rd St., Minneapolis, Minn.
- Ⓢ SANBORN CO., 39 Osborn St., Cambridge 39, Mass. ADV. PG. 391.
- Ⓢ Western Sound & Electric Labs., Inc., 805 S. Fifth St., Milwaukee 4, Wis.

STIMULATORS

- Ⓢ Electrodyne Company, 32 Oliver St., Boston, Mass.
- Ⓢ Electro-Medical Lab., Inc., South Woodstock, Vt.
- Ⓢ Gorrell & Gorrell, Haworth, N. J.

- Ⓢ Grass Instrument Co., 101 Old Colony Ave., Quincy, Mass.
- Ⓢ SANBORN CO., 39 Osborn St., Cambridge 39, Mass. ADV. PG. 391.

STRAIN RELIEFS

- Ⓢ Brandywine Fibre Co., 15th & Poplar Sts., Wilmington, Del.
- Ⓢ Diamond Wire & Cable Co., Sycamore, Ill.
- Ⓢ HEYMAN MFG. CO., 300 Michigan Ave., Kenilworth, N. J. ADV. PG. 381.
- Ⓢ Industrial Devices, Inc., 22 State Rd., Edgewater, N. J.
- Ⓢ Philco Corp., Tioga & C Sts., Philadelphia 34, Pa.
- Ⓢ Steward Mfg. Co., D. M., 3600 Jerome Ave., Chattanooga 1, Tenn.
- Ⓢ Thomas & Betts Co., Inc., 40 Butler St., Elizabeth 1, N. J.
- Ⓢ WALKER CO., GEORGE, 118 Amsterdam Ave., Passaic, N. J. ADV. PG. 368.

STROBOSCOPES

- Ⓢ Aerolux Light Corp., 653 11th Ave., New York 19, N. Y.
- Ⓢ Berkshire Laboratories, 580 Lexington Rd., Concord, Mass.
- Ⓢ COMMUNICATION MEASUREMENTS LAB., INC., 120 Greenwich St., New York, N. Y. ADV. PG. 290.
- Ⓢ CONN LTD., C. G., ELECTRONICS DIV., 1001 Beardsley Ave., Elkhart, Ind. ADV. PG. 302.
- Ⓢ Edgerton, Gernsmausen & Grier, Inc., 160 Brookline Ave., Boston, Mass.
- Ⓢ GENERAL ELECTRIC CO., Schenectady 5, N. Y. ADV. PG. 1 to 22.
- Ⓢ GENERAL RADIO CO., 275 Massachusetts Ave., Cambridge 39, Mass. ADV. PG. 48, 49.
- Ⓢ Huggins Laboratories, 734 Hamilton Ave., Menlo Park, Calif.
- Ⓢ Ionic Electronic Equipment Co., 1705 N. Kenmore, Los Angeles 27, Calif.
- Ⓢ Philco Corp., Tioga & C Sts., Philadelphia 34, Pa.

STROBOTRONS

See Tubes

SUPPRESSORS—Auto Radio Ignition

- Ⓢ BELLING & LEE, LTD., 366 Madison Ave., New York 17, N. Y. ADV. PG. 336.
- Ⓢ Coil Winders, Inc., 61 Bergen St., Brooklyn 2, N. Y.
- Ⓢ Deutschmann Corp., Tobe, 921 Providence Highway, Norwood, Mass.
- Ⓢ ERIE RESISTOR CORP., 644 W. 12th St., Erie, Pa. ADV. PG. 91.
- Ⓢ General Cement Mfg. Co., 919 Taylor Ave., Rockford, Ill.
- Ⓢ Insuline Corp. of America, 36-02 35th Ave., Long Island City, N. Y.
- Ⓢ INTERNATIONAL RESISTANCE CO., 401 N. Broad St., Philadelphia 8, Pa. ADV. PG. 134, 135.
- Ⓢ JFD MFG. CO., 6101-23 Sixteenth Ave., Brooklyn, N. Y. ADV. PG. 407.
- Ⓢ Miller Co., J. W., 5917 S. Main St., Los Angeles 3, Calif.
- Ⓢ National Electronic Mfg. Co., 402 Vernon Blvd., Long Island City, N. Y.
- Ⓢ Ohio Carbon Co., 12508 Berea Rd., Cleveland 11, Ohio.
- Ⓢ Philco Corp., Tioga & C Sts., Philadelphia 34, Pa.
- Ⓢ Telegraph Condenser Co., Ltd., Wales Farm Rd., Acton London W 3, England.
- Ⓢ U. S. ELECTRONICS CORP., 276 Warren St., Lyndhurst, N. J. ADV. PG. 76.

SUPPRESSORS—Noise

- Ⓢ BARKER & WILLIAMSON, 235 Fairfield Ave., Upper Darby, Pa. ADV. PG. 292.
- Ⓢ BELLING & LEE, LTD., 366 Madison Ave., New York 17, N. Y. ADV. PG. 336.
- Ⓢ Camburn, Inc., 32-40 57th St., Woodside, N. Y.
- Ⓢ Coil Winders, Inc., 61 Bergen St., Brooklyn 2, N. Y.
- Ⓢ Deutschmann Corp., Tobe, 921 Providence Highway, Norwood, Mass.
- Ⓢ Filtron Co., Inc., The, 131-05 Fowler Ave., Flushing, N. Y.
- Ⓢ General Cement Mfg. Co., 919 Taylor Ave., Rockford, Ill.
- Ⓢ JFD MFG. CO., 6101-23 Sixteenth Ave., Brooklyn, N. Y. ADV. PG. 407.
- Ⓢ Miller Co., J. W., 5917 S. Main St., Los Angeles 3, Calif.
- Ⓢ National Electronic Mfg. Corp., 4202 Vernon Blvd., Long Island City, N. Y.
- Ⓢ Scott, Inc., Hermon Hosmer, 385 Putnam Ave., Cambridge 39, Mass.
- Ⓢ Telegraph Condenser Co., Ltd., Wales Farm Rd., Acton London W 3, England.
- Ⓢ U. S. ELECTRONICS CORP., 276 Warren St., Lyndhurst, N. J. ADV. PG. 76.

V indicates . . . **IN PRODUCTION • AVAILABILITY • UNRESTRICTED FOR GENERAL USE**

- Ⓞ **BARKER & WILLIAMSON**, 235 Fairfield Ave., Upper Darby, Pa. ADV. PG. 292.
- Ⓞ **Coil Winders, Inc.**, 61 Bergen St., Brooklyn 2, N. Y.
- Ⓞ **INTERNATIONAL RESISTANCE CO.**, 401 N. Broad St., Philadelphia 8, Pa. ADV. PG. 134, 135.
- Ⓞ **OHMITE MFG. CO.**, 4835 W. Flournoy St., Chicago 44, Ill. ADV. PG. 41.
- Ⓞ **U. S. ELECTRONICS CORP.**, 276 Warren St., Lyndhurst, N. J. ADV. PG. 76.

SURFACE ANALYZERS AND COMPARATORS
See Analyzers

SURPLUS NEW & USED EQUIPMENT
See Pages 418 to 431

SUSPENSIONS—Speaker

SWITCHES—Automatic

- Ⓞ **Hawley Products Co.**, St. Charles, Ill.
- Ⓞ **Automatic Electric Sales Corp.**, 1033 W. Van Buren St., Chicago 7, Ill.
- Ⓞ **Automatic Switch Co.**, 391 Lakeside Ave., Orange, N. J.
- Ⓞ **Cutler-Hammer, Inc.**, 411 N. 12th St., Milwaukee 1, Wis.
- Ⓞ **Fasco Industries, Inc.**, Rochester 2, N. Y.
- Ⓞ **Lumenite Electric Co.**, 407 S. Dearborn St., Chicago, Ill.
- Ⓞ **Mallory & Co., Inc.**, P. R., 3029 E. Washington St., Indianapolis 6, Ind.
- Ⓞ **Montgomery Mfg. Co.**, 204 S. Main St., Owensville, Ind.
- Ⓞ **RUSSELL & STOLL CO., INC.**, 125 Barclay St., New York 7, N. Y. ADV. PG. 337.
- Ⓞ **SESSIONS CLOCK CO., TIMER DIV.**, Forestville, Conn. ADV. PG. 123.
- Ⓞ **UNITED MFG. & SERVICE CO.**, 405 S. Sixth St., Milwaukee 4, Wis. ADV. PG. 324.
- Ⓞ **WARD LEONARD ELECTRIC CO.**, 31 South St., Mt. Vernon, N. Y. ADV. PG. 69, 70.

SWITCHES—Coaxial Cable

- Ⓞ **BIRD ELECTRONIC CORP.**, 1800 E. 38th St., Cleveland 14, Ohio. ADV. PG. 331.
- Ⓞ **Communication Products Co., Inc.**, Marlboro, N. J.
- Ⓞ **General Communication Co.**, 530 Commonwealth Ave., Boston 15, Mass.
- Ⓞ **KINGS MICROWAVE CO., INC.**, 50 Marbledale Rd., Tuckahoe 7, N. Y. ADV. 178, 179.
- Ⓞ **Leeds & Northrup Co.**, 4970 Stenton Ave., Philadelphia 44, Pa.
- Ⓞ **Press Wireless Mfg. Co., Inc.**, Cantiague Rd., Hicksville, N. Y.
- Ⓞ **PRODUCT DEVELOPMENT CO., INC.**, Arlington, N. J. ADV. PG. 362.
- Ⓞ **Selectar Industries, Inc.**, 401 E. 138th St., New York 54, N. Y.
- Ⓞ **THOMPSON PRODUCTS, INC.**, Electronics Div., 2196 Clarkwood Rd., Cleveland 3, Ohio ADV. PG. 82.
- Ⓞ **Weymouth Instrument Co.**, 1440 Commercial St., East Weymouth 89, Mass.
- Ⓞ **WORKSHOP ASSOCIATES, INC.**, 66 Needham St., Newton Highlands 61, Mass. ADV. PG. 233.

SWITCHES—Control

- Ⓞ **Allen-Bradley Co.**, 136 W. Greenfield Ave., Milwaukee 4, Wis.
- Ⓞ **American Relay & Controls, Inc.**, 4901 W. Flournoy St., Chicago 44, Ill.
- Ⓞ **Arrow-Hart & Hegeman Electric Co.**, 100 Hawthorn St., Hartford 6, Conn.
- Ⓞ **Carling Electric, Inc.**, 505 New Park Ave., West Hartford 10, Conn.
- Ⓞ **Carter Parts Co.**, 213 Institute Pl., Chicago 10, Ill.
- Ⓞ **COMAR ELECTRIC CO.**, 3349 W. Addison St., Chicago 18, Ill. ADV. PG. 335.
- Ⓞ **Communication Products Co., Inc.**, Marlboro, N. J.
- Ⓞ **Cutler-Hammer, Inc.**, 411 N. 12th St., Milwaukee 1, Wis.
- Ⓞ **DAVEN CO.**, 191 Central Ave., Newark 4, N. J. ADV. PG. 157.
- Ⓞ **GENERAL ACCESSORIES CO., LTD.**, 366 Madison Ave., New York 17, N. Y. ADV. PG. 336.
- Ⓞ **GENERAL ELECTRIC CO.**, Schenectady 5, N. Y. ADV. PG. 1 to 22.
- Ⓞ **GUARDIAN ELECTRIC MFG. CO.**, 1621 W. Walnut St., Chicago 21, Ill. ADV. PG. 147.
- Ⓞ **INDUSTRIAL ELECTRONICS, INC.**, 8080 Wheeler St., Detroit 10, Mich. ADV. PG. 234, 235.
- Ⓞ **INTERNATIONAL RESISTANCE CO.**, 401 N. Broad St., Philadelphia 8, Pa. ADV. 134, 135.
- Ⓞ **J-B-L Instrument Co.**, Sycamore & Mill Rds., Clifton Heights, Pa.
- Ⓞ **JFD MFG. CO.**, 6101-23 Sixteenth Ave., Brooklyn, N. Y. ADV. PG. 407.
- Ⓞ **Lumenite Electric Co.**, 407 S. Dearborn St., Chicago, Ill.
- Ⓞ **Micro Switch, Div. of Minneapolis-Honeywell Regulator Co.**, 7 W. Spring St., Freeport, Ill.
- Ⓞ **OHMITE MFG. CO.**, 4835 W. Flournoy St., Chicago 44, Ill. ADV. PG. 41.

- Ⓞ **PAINTON & CO., LTD.**, 366 Madison Ave., New York 17, N. Y. ADV. PG. 336.
- Ⓞ **Roller-Smith, Bethlehem, Pa.**
- Ⓞ **RUSSELL & STOLL CO., INC.**, 125 Barclay St., New York 7, N. Y. ADV. PG. 337.
- Ⓞ **Tech Laboratories, Inc.**, Bergen & Edsall Blvds., Pallsades Park, N. J.
- Ⓞ **Trumbull Electric Mfg. Co.**, Plainville, Conn.
- Ⓞ **WARD LEONARD ELECTRIC CO.**, 31 South St., Mt. Vernon, N. Y. ADV. PG. 69, 70.
- Ⓞ **Weltronic Co.**, 19500 W. Eight Mile Rd., Detroit 19, Mich.
- Ⓞ **WESTINGHOUSE ELECTRIC CORP.**, 511 Wood St., P. O. Box 868, Pittsburgh 30, Pa. ADV. PG. 107-113.

SWITCHES—Decade

- Ⓞ **DAVEN CO.**, 191 Central Ave., Newark 4, N. J. ADV. PG. 157.
- Ⓞ **ELECTRO DEVELOPMENT CORP.**, 6014 W. Washington Blvd. ADV. PG. 408.
- Ⓞ **GENERAL RADIO CO.**, 275 Massachusetts Ave., Cambridge 39, Mass. ADV. PG. 48, 49.
- Ⓞ **Grisby-Allison Co., Inc.**, 407 N. Salem Ave., Arlington Heights, Ill.
- Ⓞ **INDUSTRIAL ELECTRONICS, INC.**, 8080 Wheeler St., Detroit 10, Mich. ADV. PG. 234, 235.
- Ⓞ **J-B-L Instrument Co.**, Sycamore & Mill Rds., Clifton Heights, Pa.
- Ⓞ **Leeds & Northrup Co.**, 4970 Stenton Ave., Philadelphia 44, Pa.
- Ⓞ **PAINTON & CO., LTD.**, 366 Madison Ave., New York 17, N. Y. ADV. PG. 336.
- Ⓞ **Sensitive Research Instrument Corp.**, 9 Elm Ave., Mt. Vernon, N. Y.
- Ⓞ **SHALLCROSS MFG. CO.**, 10 Jackson Ave., Collingdale, Pa. ADV. PG. 267.
- Ⓞ **Tech Laboratories, Inc.**, Bergen & Edsall Blvds., Pallsades Park, N. J.
- Ⓞ **Winslow Co., Inc.**, 9 Liberty St., Newark 5, N. J.

SWITCHES—Duplex

- Ⓞ **Leeds & Northrup Co.**, 4970 Stenton Ave., Philadelphia 44, Pa.
- Ⓞ **PAINTON & CO., LTD.**, 366 Madison Ave., New York 17, N. Y. ADV. PG. 336.

SWITCHES—Electronic

- Ⓞ **Aeronautical Electronics, Inc.**, Raleigh-Durham Airport, P. O. Box 6043, Raleigh, N. C.
- Ⓞ **Airborne Electronics Co.**, Metropolitan Airport, Hangar No. 3, Van Nuys, Calif.
- Ⓞ **Birnbach Radio Co., Inc.**, 145 Hudson St., New York, N. Y.
- Ⓞ **Carling Electric, Inc.**, 505 New Park Ave., West Hartford 10, Conn.
- Ⓞ **Carter Parts Co.**, 213 Institute Pl., Chicago 10, Ill.
- Ⓞ **CENTRALAB DIV. OF GLOBE-UNION INC.**, 900 E. Keefe Ave., Milwaukee, Wis. ADV. PG. 85-88.
- Ⓞ **Cutler-Hammer, Inc.**, 411 N. 12th St., Milwaukee 1, Wis.
- Ⓞ **Electronic Control Corp.**, 1573 E. Forest St., Detroit, Mich.
- Ⓞ **Farmer Electric Co.**, 21 Mossfield Rd., Waban 68, Mass.
- Ⓞ **GENERAL ELECTRIC CO.**, Schenectady 5, N. Y. ADV. PG. 1 to 22.
- Ⓞ **HEATH CO.**, Benton Harbor, Mich. ADV. PG. 264.
- Ⓞ **Ionic Electronic Equipment Co.**, 1705 N. Kenmore, Los Angeles 27, Calif.
- Ⓞ **Lumenite Electric Co.**, 407 S. Dearborn St., Chicago 5, Ill.
- Ⓞ **Mallory & Co., Inc.**, P. R., 3029 E. Washington St., Indianapolis 6, Ind.
- Ⓞ **PAINTON & CO., LTD.**, 366 Madison Ave., New York 17, N. Y. ADV. PG. 336.
- Ⓞ **Philbrick Researches, Inc.**, George A., 230 Congress St., Boston 10, Mass.
- Ⓞ **Photoswitch, Inc.**, 77 Broadway, Cambridge 42, Mass.
- Ⓞ **Press Wireless Mfg. Co., Inc.**, Cantiague Rd., Hicksville, N. Y.
- Ⓞ **PRODUCT DEVELOPMENT CO., INC.**, Arlington, N. J. ADV. PG. 362.
- Ⓞ **Ripley Co., Inc.**, Middletown, Conn.
- Ⓞ **Robotron Corp.**, 5570 W. Chicago Blvd., Detroit 4, Mich.
- Ⓞ **Ucinite Co. Division, United-Carr Fastener Corp.**, 459 Watertown St., Newtonville, Mass.
- Ⓞ **Walkirt Co.**, 5808 Marilyn Ave., Culver City, Calif.
- Ⓞ **Weltronic Co.**, 19500 W. Eight Mile Rd., Detroit 19, Mich.
- Ⓞ **WESTINGHOUSE ELECTRIC CORP.**, 511 Wood St., P. O. Box 868, Pittsburgh 30, Pa. ADV. PG. 107-113.

SWITCH—Float Type

- Ⓞ **Allen-Bradley Co.**, 136 W. Greenfield Ave., Milwaukee 4, Wis.
- Ⓞ **Arrow-Hart & Hegeman Electric Co.**, 100 Hawthorn St., Hartford 6, Conn.
- Ⓞ **Carling Electric, Inc.**, 505 New Park Ave., West Hartford 10, Conn.

- Ⓞ **Clark Controller Co.**, 1146 E. 152nd St., Cleveland 10, Ohio.
- Ⓞ **Cutler-Hammer, Inc.**, 411 N. 12th St., Milwaukee 1, Wis.
- Ⓞ **GENERAL ELECTRIC CO.**, Schenectady 5, N. Y. ADV. PG. 1 to 22.
- Ⓞ **Trumbull Electric Mfg. Co.**, Plainville, Conn.
- Ⓞ **WESTINGHOUSE ELECTRIC CORP.**, 511 Wood St., P. O. Box 868, Pittsburgh 30, Pa. ADV. PG. 107-113.

SWITCHES—Key

- Ⓞ **Arrow-Hart & Hegeman Electric Co.**, 100 Hawthorn St., Hartford 6, Conn.
- Ⓞ **Automatic Electric Sales Corp.**, 1033 W. Van Buren St., Chicago 7, Ill.
- Ⓞ **Bunnell & Co., J. H.**, 81 Prospect St., Brooklyn, N. Y.
- Ⓞ **CINEMA ENGINEERING CO.**, 1510 W. Verdugo Ave., Burbank, Calif. ADV. PG. 204.
- Ⓞ **Clare & Co., C. P.**, 4719 Sunnyside Ave., Chicago 30, Ill.
- Ⓞ **Connecticut Telephone & Electric Corp.**, 70 Britannia St., Meriden, Conn.
- Ⓞ **KELLOGG SWITCHBOARD & SUPPLY CO.**, 6650 S. Cicero Ave., Chicago 38, Ill. ADV. PG. 294.
- Ⓞ **Molded Insulation Co.**, 335 E. Price St., Philadelphia 44, Pa.
- Ⓞ **Presto Electric Co., Inc.**, 4513 New York Ave., Union City, N. J.
- Ⓞ **SWITCHCRAFT, INC.**, 1328-30 N. Halsted St., Chicago 22, Ill. ADV. PG. 354.
- Ⓞ **WESTINGHOUSE ELECTRIC CORP.**, 511 Wood St., P. O. Box 868, Pittsburgh 30, Pa. ADV. PG. 107-113.
- Ⓞ **Winslow Co., Inc.**, 9 Liberty St., Newark 5, N. J.

SWITCHES—Limit

- Ⓞ **Acro Mfg. Co.**, 2040 E. Main St., Columbus, Ohio.
- Ⓞ **AIR ASSOCIATES, INC.**, Teterboro, N. J. ADV. PG. 211.
- Ⓞ **Allen-Bradley Co.**, 136 W. Greenfield Ave., Milwaukee 4, Wis.
- Ⓞ **Automatic Electric Sales Corp.**, 1033 W. Van Buren St., Chicago 7, Ill.
- Ⓞ **Cutler-Hammer, Inc.**, 411 N. 12th St., Milwaukee 1, Wis.
- Ⓞ **Edwards Co., Inc.**, 86 Boston Post Rd., Norwalk, Conn.
- Ⓞ **GENERAL ELECTRIC CO.**, Schenectady 5, N. Y. ADV. PG. 1 to 22.
- Ⓞ **GUARDIAN ELECTRIC MFG. CO.**, 1621 W. Walnut St., Chicago 12, Ill. ADV. PG. 147.
- Ⓞ **Hetherington Inc.**, Sharon Hill, Pa.
- Ⓞ **JENNINGS RADIO MFG. CO.**, 1098 E. William St., San Jose 12, Calif. ADV. PG. 194, 195.
- Ⓞ **MERCOD CORP.**, 4201 Belmont Ave., Chicago 41, Ill. ADV. PG. 192.
- Ⓞ **Micro Switch, Div. of Minneapolis-Honeywell Regulator Co.**, 7 W. Spring St., Freeport, Ill.
- Ⓞ **Minneapolis-Honeywell Regulator Co.**, 2753 Fourth Ave. S., Minneapolis, Minn.
- Ⓞ **Mu Switch Division, Acro Switch Co.**, 38 Pequit St., Canton 31, Mass.
- Ⓞ **TYNISWITCH DIVISION, SESSIONS CLOCK CO.**, Forrestville, Conn. ADV. PG. 122.
- Ⓞ **UNIMAX SWITCH DIV. OF W. L. MAXSON CORP.**, 460 W. 34th St., New York 1, N. Y. ADV. PG. 227.
- Ⓞ **WESTINGHOUSE ELECTRIC CORP.**, 511 Wood St., P. O. Box 868, Pittsburgh 30, Pa. ADV. PG. 107-113.

SWITCHES—Mercury

- Ⓞ **Durakool, Inc.**, 1010 N. Main St., Elkhart, Ind.
- Ⓞ **Electronic Apparatus Co.**, Elkhart, Ind.
- Ⓞ **GENERAL ELECTRIC CO.**, Construction Materials Dept., 1285 Boston Ave., Bridgeport 2, Conn. ADV. PG. 1 to 22.
- Ⓞ **GENERAL ELECTRIC CO.**, Electronics Dept., Tube Div., Schenectady 5, N. Y. ADV. PG. 1 to 22.
- Ⓞ **LITTELFUSE, INC.**, 4757 Ravenswood Ave., Chicago 40, Ill. ADV. PG. 285.
- Ⓞ **MERCOD CORP.**, 4201 Belmont Ave., Chicago 41, Ill. ADV. PG. 192.
- Ⓞ **Micro Switch Div. of Minneapolis-Honeywell Regulator Co.**, 7 W. Spring St., Freeport, Ill.
- Ⓞ **Minneapolis-Honeywell Regulator Co.**, 2753 Fourth Ave. S., Minneapolis, Minn.
- Ⓞ **Philco Corp.**, Tioga & C Sts., Philadelphia 34, Pa.

SWITCHES—Rotary and Band Change

- Ⓞ **Ark-Les Switch Corp.**, 55 Water St., Watertown 72, Mass.
- Ⓞ **BARKER & WILLIAMSON**, 235 Fairfield Ave., Upper Darby, Pa. ADV. PG. 292.
- Ⓞ **Birnbach Radio Co., Inc.**, 145 Hudson St., New York, N. Y.
- Ⓞ **Carling Electric, Inc.**, 505 New Park Ave., West Hartford 10, Conn.
- Ⓞ **CENTRALAB DIV. OF GLOBE-UNION, INC.**, 900 E. Keefe Ave., Milwaukee 1, Wis. ADV. PG. 85-88.

V indicates . . . IN PRODUCTION • AVAILABILITY • UNRESTRICTED FOR GENERAL USE

- **CINEMA ENGINEERING CO.**, 1510 W. Verdugo Ave., Burbank, Calif. ADV. PG. 204.
- **CLAROSTAT MFG. CO., INC.**, Dover, N. H. ADV. PG. 100, 101.
- **Communication Products Co., Inc.**, Marlboro, N. J.
- **DAVEN CO.**, 191 Central Ave., Newark 4, N. J. ADV. PG. 157.
- **Eastern Specialty Co.**, Philadelphia 40, Pa.
- **ELECTRO DEVELOPMENT CORP.**, 6014 W. Washington Blvd., Culver City, Calif. ADV. PG. 408.
- **General Cement Mfg. Co.**, 919 Taylor Ave., Rockford, Ill.
- **GRAYHILL**, 4524 W. Madison St., Chicago 24, Ill. ADV. PG. 380.
- **Grigsby-Allison Co., Inc.**, 407 N. Salem Ave., Arlington Heights, Ill.
- **J-B-L Instrument Co.**, Sycamore & Mill Rds., Clifton Heights, Pa.
- **JBT INSTRUMENTS INC.**, 431-B Chapel St., New Haven 8, Conn. ADV. PG. 351.
- **JFD MFG. CO.**, 6101-23 Sixteenth Ave., Brooklyn, N. Y. ADV. PG. 407.
- **Leeds & Northrup Co.**, 4970 Stenton Ave., Philadelphia 44, Pa.
- **Oak Mfg. Co.**, 1260 N. Clybourn Ave., Chicago 10, Ill.
- **OHMITE MFG. CO.**, 4835 W. Flournoy St., Chicago 44, Ill. ADV. PG. 41.
- **Philco Corp.**, Tioga & C Sts., Philadelphia 34, Pa. Press Wireless Mfg. Co., Inc., Cantigue Rd., Hicksville, N. Y.
- **PRODUCT DEVELOPMENT CO., INC.**, Arlington, N. J. ADV. PG. 362.
- **Roller-Smith, Bethlehem, Pa.**
- **Selector Industries, Inc.**, 401 E. 138th St., New York 54, N. Y.
- **SHALLCROSS MFG. CO.**, 10 Jackson Ave., Collingdale, Pa. ADV. PG. 261.
- **STACKPOLE CARBON CO.**, St. Marys, Pa. ADV. PG. 170, 171.
- **SWITCHCRAFT, INC.**, 1328-30 N. Halsted St., Chicago 22, Ill. ADV. PG. 354.
- **Tech Laboratories, Inc.**, Bergen & Edsall Blvds., Palisades Park, N. J.
- **Ucinite Co. Division, United-Carr Fastener Corp.**, 459 Watertown St., Newtonville, Mass.

SWITCHES—Safety

- **Arrow-Hart & Hegeman Electric Co.**, 100 Hawthorn St., Hartford 6, Conn.
- **Bunnell & Co., J. H.**, 81 Prospect St., Brooklyn, N. Y.
- **Coral Designs Div. of Henry G. Dietz Co.**, 12-16 Astoria Blvd., Long Island City 2, N. Y.
- **Cutler-Hammer, Inc.**, 411 No. 12th St., Milwaukee 1, Wis.
- **Federal Electric Products Company**, 50 Paris St., Newark, N. J.
- **General Cement Mfg. Co.**, 919 Taylor Ave., Rockford, Ill.
- **Hetherington, Inc.**, Sharon Hill, Pa.
- **Micro Switch Div. of Minneapolis-Honeywell Regulator Co.**, 7 W. Spring St., Freeport, Ill.
- **RUSSELL & STOLL CO., INC.**, 125 Barclay St., New York 7, N. Y. ADV. PG. 337.
- **Trumbull Electric Mfg. Co.**, Plainville, Conn.
- **TYNISWITCH DIVISION, SESSIONS CLOCK CO.**, Forestville, Conn. ADV. PG. 122.
- **WESTINGHOUSE ELECTRIC CORP.**, 511 Wood St., P. O. Box 868, Pittsburgh 30, Pa. ADV. PG. 107-113.

SWITCHES—Slide

- **Arrow-Hart & Hegeman Electric Co.**, 100 Hawthorn St., Hartford 6, Conn.
- **Birnbach Radio Co., Inc.**, 145 Hudson St., New York, N. Y.
- **Carling Electric, Inc.**, 505 New Park Ave., West Hartford 10, Conn.
- **CENTRALAB DIV. OF GLOBE-UNION INC.**, 900 E. Keefe Ave., Milwaukee 1, Wis. ADV. PG. 85-88.
- **Elpar Co.**, 539 Market St., Camden 2, N. J.
- **FEDERAL SCREW PRODUCTS INC.**, 224 W. Huron St., Chicago 10, Ill. ADV. PG. 76.
- **General Cement Mfg. Co.**, 919 Taylor Ave., Rockford, Ill.
- **Grigsby-Allison Co., Inc.**, 407 N. Salem Ave., Arlington Heights, Ill.
- **JFD MFG. CO.**, 6101-23 Sixteenth Ave., Brooklyn, N. Y. ADV. PG. 407.
- **Muter Co.**, 1255 S. Michigan Ave., Chicago, Ill.
- **Oak Mfg. Co.**, 1260 N. Clybourn Ave., Chicago 10, Ill.
- **PAINTON & CO., LTD.**, 366 Madison Ave., New York 17, N. Y. ADV. PG. 336.
- **Philco Corp.**, Tioga & C Sts., Philadelphia 34, Pa.
- **Smith, Inc.**, Herman H., 436 18th St., Brooklyn 15, N. Y.
- **STACKPOLE CARBON CO.**, St. Marys, Pa. ADV. PG. 170, 171.
- **Wirt Co.**, 5221 Greene Street, Philadelphia 44, Pa.

SWITCHES—Snap Action

- **Acro Mfg. Co.**, 2040 E. Main St., Columbus, Ohio.
- **AIR ASSOCIATES, INC.**, Teterboro, N. J. ADV. PG. 211.

- **Arrow-Hart & Hegeman Electric Co.**, 100 Hawthorn St., Hartford 6, Conn.
- **Carling Electric, Inc.**, 505 New Park Ave., West Hartford 10, Conn.
- **CHICAGO TELEPHONE SUPPLY CORP.**, 1142 W. Beardsley Ave., Elkhart, Ind. ADV. PG. 78, 79.
- **COMAR ELECTRIC CO.**, 3349 W. Addison St., Chicago 18, Ill. ADV. PG. 335.
- **Cutler-Hammer, Inc.**, 411 N. 12th St., Milwaukee 1, Wis.
- **Edwards Co., Inc.**, 86 Boston Post Rd., Norwalk, Conn.
- **Elpar Co.**, 539 Market St., Camden 2, N. J.
- **GENERAL ACCESSORIES CO., LTD.**, 366 Madison Ave., New York 17, N. Y. ADV. PG. 336.
- **General Cement Mfg. Co.**, 919 Taylor Ave., Rockford, Ill.
- **GENERAL ELECTRIC CO.**, Schenectady 5, N. Y. ADV. PG. 1 to 22.
- **GRAYHILL**, 4524 N. Madison St., Chicago 24, Ill. ADV. PG. 380.
- **Grigsby-Allison Co., Inc.**, 407 N. Salem Ave., Arlington Heights, Ill.
- **GUARDIAN ELECTRIC MFG. CO.**, 1621 W. Walnut St., Chicago 12, Ill. ADV. PG. 147.
- **Hetherington, Inc.**, Sharon Hill, Pa.
- **Hoffman Engineering Corp.**, Anoka, Minn.
- **JFD MFG. CO.**, 6101-23 Sixteenth Ave., Brooklyn, N. Y. ADV. PG. 407.
- **Master Appliance Mfg. Co.**, Fourth & Ontario Sts., Racine, Wis.
- **Micro Switch Div. of Minneapolis-Honeywell Regulator Co.**, 7 W. Spring St., Freeport, Ill.
- **Mu Switch Division, Acro Switch Co.**, 38 Pequit St., Canton, Mass.
- **PAINTON & CO., LTD.**, 366 Madison Ave., New York 17, N. Y. ADV. PG. 336.
- **ROANWELL CORP.**, 662 Pacific St., Brooklyn 17, N. Y. ADV. PG. 403.
- **SESSIONS CLOCK CO., TIMER DIV.**, Forestville, Conn. ADV. PG. 123.
- **STACKPOLE CARBON CO.**, St. Marys, Pa. ADV. PG. 170, 171.
- **TYNISWITCH DIVISION, SESSIONS CLOCK CO.**, Forestville, Conn. ADV. PG. 122.
- **Ucinite Co. Division, United-Carr Fastener Corp.**, 459 Watertown St., Newtonville, Mass.
- **UNIMAX SWITCH, DIV. OF W. L. MAXSON CORP.**, 460 West 34th St., New York 1, N. Y. ADV. PG. 227.

SWITCHES—Step Type

- **Autocall Co.**, The, Shelby, Ohio.
- **Automatic Electric Sales Corp.**, 1033 W. Van Buren St., Chicago 7, Ill.
- **CINEMA ENGINEERING CO.**, 1510 W. Verdugo Ave., Burbank, Calif. ADV. PG. 204.
- **DAVEN CO.**, 191 Central Ave., Newark 4, N. J. ADV. PG. 157.
- **Electronic Brazing Co.**, 140 Glenridge Ave., Montclair, N. J.
- **FEDERAL TELEPHONE AND RADIO CORP.**, 88 Kingsland Rd., Clifton, N. J. ADV. PG. 161-163.
- **Grigsby-Allison Co., Inc.**, 407 N. Salem Ave., Arlington Heights, Ill.
- **Industrial Timer Corp.**, 115 Edison Pl., Newark 5, N. J.
- **Leeds & Northrup Co.**, 4970 Stenton Ave., Philadelphia 44, Pa.
- **PAINTON & CO., LTD.**, 366 Madison Ave., New York 17, N. Y. ADV. PG. 336.
- **Tech Laboratories, Inc.**, Bergen & Edsall Blvds., Palisades Park, N. J.

SWITCHES—Tap

- **AMERICAN PHENOLIC CORPORATION**, 1830 S. 54th Ave., Chicago 50, Ill. ADV. PG. 61.
- **Ark-Les Switch Corp.**, 55 Water St., Watertown 72, Mass.
- **Carter Parts Co.**, 213 Institute Pl., Chicago 10, Ill.
- **CINEMA ENGINEERING CO.**, 1510 W. Verdugo Ave., Burbank, Calif. ADV. PG. 204.
- **Cole Instrument Co.**, 1320 S. Grand Ave., Los Angeles 15, Calif.
- **Communication Products Co., Inc.**, Marlboro, N. J.
- **DAVEN CO.**, 191 Central Ave., Newark 4, N. J. ADV. PG. 157.
- **Eastern Specialty Co.**, Philadelphia 40, Pa.
- **Edwards Co., Inc.**, 86 Boston Post Rd., Norwalk, Conn.
- **ELECTRO DEVELOPMENT CORP.**, 6014 W. Washington Blvd., Culver City, Calif. ADV. PG. 408.
- **GRAYHILL**, 4524 N. Madison St., Chicago 24, Ill. ADV. PG. 380.
- **Grigsby-Allison Co., Inc.**, 407 N. Salem Ave., Arlington Heights, Ill.
- **Leeds & Northrup Co.**, 4970 Stenton Ave., Philadelphia 44, Pa.
- **Oak Mfg. Co.**, 1260 N. Clybourn Ave., Chicago 10, Ill.
- **OHMITE MFG. CO.**, 4835 W. Flournoy St., Chicago 44, Ill. ADV. PG. 41.
- **PAINTON & CO., LTD.**, 366 Madison Ave., New York 17, N. Y. ADV. PG. 336.
- **Philco Corp.**, Tioga & C Sts., Philadelphia 34, Pa.
- **Tech Laboratories, Inc.**, Bergen & Edsall Blvds., Palisades Park, N. J.
- **Winslow Co., Inc.**, 9 Liberty St., Newark 5, N. J.

SWITCHES—Time

- **Allen-Bradley Co.**, 136 W. Greenfield Ave., Milwaukee 4, Wis.
- **CRAMER CO., INC.**, R. W., Box 13, Centerbrook, Conn. ADV. PG. 202.
- **Eagle Signal Corp.**, Moline, Ill.
- **Edwards Co., Inc.**, 86 Boston Post Rd., Norwalk, Conn.
- **GENERAL ELECTRIC CO.**, Schenectady 5, N. Y. ADV. PG. 1 to 22.
- **Hagen Mfg. Co., Inc.**, Baraboo, Wis.
- **HAYDON CO.**, A. W., 232 N. Elm St., Waterbury 20, Conn. ADV. PG. 402.
- **HAYDON MFG. CO., INC.**, 584 E. Elm St., Torrington, Conn. ADV. PG. 216, 217.
- **Industrial Timer Corp.**, 115 Edison Pl., Newark 5, N. J.
- **Ionic Electronic Equipment Co.**, 1705 N. Kenmore, Los Angeles 27, Calif.
- **Landis & Gyr, Inc.**, 104 Fifth Ave., New York 11, N. Y.
- **Lektra Laboratories**, 154-11th Ave., New York, N. Y.
- **Lumenite Electric Co.**, 407 S. Dearborn St., Chicago 5, Ill.
- **Mallory & Co., Inc.**, P. R., 3029 E. Washington St., Indianapolis 6, Ind.
- **Montgomery Mfg. Co.**, 204 S. Main St., Owensville, Ind.
- **Paragon Electric Co.**, Two Rivers, Wisconsin.
- **Reliance Automatic Lighting Co.**, 1919 Mead St., Racine, Wis.
- **Rhodes, Inc.**, M. H., 30 Bartholomew Ave., Hartford, Conn.
- **SESSIONS CLOCK CO., TIMER DIV.**, Forestville, Conn. ADV. PG. 123.
- **Tork Clock Co., Inc.**, 1 Grove St., Mt. Vernon, N. Y.
- **Walser Automatic Timer Corp.**, Graybar Bldg., New York, N. Y.
- **WARD LEONARD ELECTRIC CO.**, 31 South St., Mt. Vernon, N. Y. ADV. PG. 69, 70.
- **WESTINGHOUSE ELECTRIC CORP.**, 511 Wood St., P. O. Box 868, Pittsburgh 30, Pa. ADV. PG. 107-113.
- **Zenith Electric Co.**, 152 W. Walton St., Chicago 10, Ill.

SWITCHES—Toggle and Pushbutton

- **Acro Mfg. Co.**, 2040 E. Main St., Columbus, Ohio.
- **Allen-Bradley Co.**, 136 W. Greenfield Ave., Milwaukee 4, Wis.
- **Ark-Les Switch Corp.**, 55 Water St., Watertown 72, Mass.
- **Arrow-Hart & Hegeman Electric Co.**, 100 Hawthorn St., Hartford 6, Conn.
- **Birnbach Radio Co., Inc.**, 145 Hudson St., New York, N. Y.
- **Cable Electric Products Co.**, Providence, R. I.
- **Carling Electric, Inc.**, 505 New Park Ave., West Hartford 10, Conn.
- **Carter Parts Co.**, 213 Institute Pl., Chicago 10, Ill.
- **CINEMA ENGINEERING CO.**, 1510 W. Verdugo Ave., Burbank, Calif. ADV. PG. 204.
- **Connecticut Telephone & Electric Corp.**, 70 Brittainia St., Meriden, Conn.
- **Cutler-Hammer Inc.**, 411 N. 12th St., Milwaukee 1, Wis.
- **Eagle Electric Mfg. Co., Inc.**, 23-10 Bridge Plaza, S., Long Island City, N. Y.
- **Edwards Co., Inc.**, 86 Boston Post Rd., Norwalk, Conn.
- **FEDERAL SCREW PRODUCTS, INC.**, 224 W. Huron St., Chicago 10, Ill. ADV. PG. 76.
- **GENERAL ACCESSORIES CO., LTD.**, 366 Madison Ave., New York 17, N. Y. ADV. PG. 336.
- **General Cement Mfg. Co.**, 919 Taylor Ave., Rockford, Ill.
- **General Control Company**, 1200 Soldiers Field Rd., Boston 34, Mass.
- **GENERAL ELECTRIC CO.**, Schenectady 5, N. Y. ADV. PG. 1 to 22.
- **GENERAL ELECTRIC CO.**, Construction Materials Dept., 1285 Boston Ave., Bridgeport 2, Conn. ADV. PG. 1 to 22.
- **GRAYHILL**, 4524 N. Madison St., Chicago 24, Ill. ADV. PG. 380.
- **Grigsby-Allison Co., Inc.**, 407 N. Salem Ave., Arlington Heights, Ill.
- **Hetherington, Inc.**, Sharon Hill, Pa.
- **Hubbell, Inc.**, Harvey, Bridgeport 2, Conn.
- **Insuline Corp. of America**, 36-02 35th Ave., Long Island City, N. Y.
- **JFD MFG. CO.**, 6101-23 Sixteenth Ave., Brooklyn, N. Y. ADV. PG. 407.
- **KULKKA ELECTRIC MFG. CO.**, 30 South St., Mount Vernon, N. Y. ADV. PG. 317.
- **Mallory & Co., Inc.**, P. R., 3029 E. Washington St., Indianapolis 6, Ind.
- **Master Appliance Mfg. Co.**, Fourth & Ontario Sts., Racine, Wis.
- **Micro Switch Div. of Minneapolis-Honeywell Regulator Co.**, 7 W. Spring St., Freeport, Ill.
- **Morse Co.**, Frank W., 1300 Soldiers Field Rd., Boston 35, Mass.
- **Network Mfg. Corp.**, Bayonne, N. J.
- **Oak Mfg. Co.**, 1260 N. Clybourn Ave., Chicago 10, Ill.
- **PAINTON & CO., LTD.**, 366 Madison Ave., New York 17, N. Y. ADV. PG. 336.

V indicates . . . IN PRODUCTION • AVAILABILITY • UNRESTRICTED FOR GENERAL USE

- Pass & Seymour, Inc., Solway Station, Syracuse, N. Y.
- Philco Corp., Tioga & C Sts., Philadelphia 34, Pa.
- Power Equipment Co., 55 Antoinette St., Detroit 2, Mich.
- Presto Electric Co., Inc., 4513 New York Ave., Union City, N. J.
- R. B. M. Div., Essex Wire Corp., Logansport, Ind.
- RUSSELL & STOLL CO., INC., 125 Barclay St., New York 7, N. Y. ADV. PG. 337.
- Sensitive Research Instrument Corp., 9 Elm Ave., Mt. Vernon, N. Y.
- Smith, Inc., Herman H., 436 18th St., Brooklyn 15, N. Y.
- SWITCHCRAFT, INC., 1328-30 N. Halsted St., Chicago 22, Ill. ADV. PG. 354.
- TYNISWITCH DIVISION, SESSIONS CLOCK CO., Forestville, Conn. ADV. PG. 122.
- Ucinite Co. Division, United-Carr Fastener Corp., 459 Watertown St., Newtonville, Mass.
- WARD LEONARD ELECTRIC CO., 31 South St., Mt. Vernon, N. Y. ADV. PG. 69, 70.
- WESTINGHOUSE ELECTRIC CORP., 511 Wood St., P. O. Box 868, Pittsburgh 30, Pa. ADV. PG. 107-113.

SWITCHES—TR

- Carling Electric, Inc., 505 New Park Ave., West Hartford 10, Conn.
- KINGS MICROWAVE CO., INC., 50 Marbledale Rd., Tuckahoe 7, N. Y. ADV. PG. 178, 179.

SWITCHES—Vacuum

- CHATHAM ELECTRONICS CORP., 475 Washington St., Newark 2, N. J. ADV. PG. 46.
- Cook Electric Co., 2700 Southport Ave., Chicago 14, Ill.
- Cutler-Hammer, Inc., 411 N. 12th St., Milwaukee 1, Wis.
- Eitel-McCullough Inc., San Bruno, Calif.
- GENERAL ELECTRIC CO., Schenectady 5, N. Y. ADV. PG. 1 to 22.
- GENERAL ELECTRIC CO., Electronics Dept., Tube Div., Schenectady 5, N. Y. ADV. PG. 1 to 22.
- JENNINGS RADIO MFG. CO., 1098 E. William St., San Jose 12, Calif. ADV. PG. 194, 195.
- Optical Film Engineering Co., 2125 Cherry St., Philadelphia 3, Pa.
- Skaneateles Mfg. Co., Inc., 122 Dickerson St., Syracuse, N. Y.
- Wallace & Tiernan Products, Inc., Belleville 9, N. J.

SYNCHRONIZERS—Electronic

- Airlectron, Inc., P. O. Box 151, Caldwell, N. J.
- BROWNING LABORATORIES, INC., 750 Main St., Winchester, Mass. ADV. PG. 257.
- Burlington Instrument Co., Burlington, Iowa.
- Control Corp., 718 Central Ave., Minneapolis 14, Minn.
- Electronics Associates, Inc., Long Branch, N. J.
- ELECTRO PRODUCTS LABS., 4501 N. Ravenswood Ave., Chicago 40, Ill. ADV. PG. 199.
- Fairchild Recording Equipment Co., 154th St. & Seventh Ave., Whitestone, N. Y.
- Weitron Co., 19500 W. Eight Mile Rd., Detroit 19, Mich.

SYNCHRONIZERS—Electronic Aircraft Magneto

- Aircraft Electronics Association, Inc., 94 Silas Deane Highway, Rocky Hill, Conn.
- Ionic Electronic Equipment Co., 1705 N. Kenmore, Los Angeles 27, Calif.
- SPERRY GYROSCOPE CO., Div. of Sperry Corp., Great Neck, N. Y. ADV. PG. 103, 104.

SYNCHROS

- Arma Corp., 254 36th St., Brooklyn, N. Y.
- ECLIPSE-PIONEER DIV., BENDIX AVIATION CORP., Teterboro, N. J. ADV. PG. 198, 199.
- Ford Instrument Co., Inc., 31-10 Thomson Ave., Long Island City, N. Y.
- GENERAL ELECTRIC CO., Schenectady 5, N. Y. ADV. PG. 1 to 22.
- Ketay Mfg. Corp., 555 Broadway, New York, N. Y.
- Sig Trans, Inc., Amesbury, Mass.
- SPERRY GYROSCOPE CO., Div. of The Sperry Corp., Great Neck, N. Y. ADV. PG. 103, 104.

SYNCHROSCOPES

- AIRMEC LABORATORIES, LTD., 366 Madison Ave., New York 17, N. Y. ADV. PG. 336.
- BROWNING LABORATORIES, INC., 750 Main St., Winchester, Mass. ADV. PG. 257.
- Cossor (Canada) Ltd., 301-303 Windsor St., Halifax, N. S., Canada.
- GENERAL ELECTRIC CO., Schenectady 5, N. Y. ADV. PG. 1 to 22.

- Glenco Corp., Metuchen, N. J.
- Gulton Mfg. Corp., Metuchen, N. J.
- McMurdo Silver Co., Inc., 417 Lafayette St., New York, N. Y.
- Millen Mfg. Co., James, 150 Exchange St., Malden, Mass.
- POLARAD ELECTRONICS CORP., 100 Metropolitan Ave., Brooklyn 11, N. Y. ADV. PG. 184, 185.
- Radioactive Products, Inc., 443 W. Congress St., Detroit 26, Mich.
- SPENCER-KENNEDY LABS., INC., 186 Massachusetts Ave., Cambridge 39, Mass. ADV. PG. 166.
- SYLVANIA ELECTRIC PRODUCTS, INC., 1740 Broadway, New York 19, N. Y. ADV. PG. 432-436.
- WESTINGHOUSE ELECTRIC CORP., 511 Wood St., P. O. Box 868, Pittsburgh 30, Pa. ADV. PG. 107-113.
- WESTON ELECTRICAL INSTRUMENT CORP., 595 Frelinghuysen Ave., Newark 5, N. J. ADV. PG. 243.

TACHOMETERS—Electronic

- AIRMEC LABORATORIES, LTD., 366 Madison Ave., New York 17, N. Y. ADV. PG. 336.
- Associated Research, Inc., 3758 W. Belmont, Chicago 18, Ill.
- Bailey Meter Co., 1044 Ivanhoe Rd., Cleveland 10, Ohio.
- Berkeley Scientific Corp., 2200 Wright Ave., Richmond, Calif.
- Bristol Co., The, Waterbury 20, Conn.
- Cole Instrument Co., 1320 S. Grand Ave., Los Angeles 15, Calif.
- EDIN CO., INC., 207 Main St., Worcester, Mass. ADV. PG. 285.
- GENERAL ELECTRIC CO., Schenectady 5, N. Y. ADV. PG. 1 to 22.
- GENERAL RADIO CO., 275 Massachusetts Ave., Cambridge 39, Mass. ADV. PG. 48, 49.
- Ideal Industries, Inc., Park & Bordon Avenues, Sycamore, Ill.
- KAY ELECTRIC CO., 14 Maple Ave., Pine Brook, N. J. ADV. PG. 340.
- King Electric Equipment Co., 9123 Inman Ave., Cleveland 5, Ohio.
- Metron Instrument Co., 432 Lincoln St., Denver 9, Colo.
- Nucleonic Corp. of America, The, 497 Union St., Brooklyn 31, N. Y.
- Photocon Research Products, 1062 N. Allen Ave., Pasadena 6, Calif.
- POTTER INSTRUMENT CO., INC., 115 Cutter Mill Rd., Great Neck, N. Y. ADV. PG. 318.
- Sticht Co., Inc., Herman H., 27 Park Place, New York 7, N. Y.
- Tagliabue Div., Weston Electrical Instrument Corp., 614 Frelinghuysen Ave., Newark 5, N. J.
- Zernickow Co., O., 15 Park Row, New York 7, N. Y.

TAPE—Magnetic Recording

- Amplifier Corp. of America, 398 Broadway, New York 13, N. Y.
- AUDIO DEVICES INC., 444 Madison Ave., New York 22, N. Y. ADV. PG. 77.
- Audio-Master Corp., 241 Madison Ave., New York 17, N. Y.
- BRUSH DEVELOPMENT CO., 3405 Perkins Ave., Cleveland 14, Ohio. ADV. PG. 228, 229.
- DUOTONE CO., INC., Keyport, N. J. ADV. PG. 307.
- Fidelitone Corp., 1616 Devon Ave., Chicago 26, Ill.
- Jensen Industries, Inc., 329 S. Wood St., Chicago, Ill.
- Minnesota Mining & Mfg. Co., 900 Fauquier Ave., St. Paul 6, Minn.
- Permo, Inc., 6415 Ravenswood Ave., Chicago 26, Ill.
- Recordisc Corp., 395 Broadway, New York, N. Y.
- Recotone Corp., 251 Fourth Ave., New York 10, N. Y.
- REEVES SOUNDRAFT CORP., 10 E. 52nd St., New York 22, N. Y. ADV. PG. 372.
- Zephyr Products Co., 160 E. 116 St., New York 29, N. Y.

TAPES

See Insulation Parts

TECHNICAL BOOKS—Publishers

- The following listings do not carry the V identification as individual books are not listed.
- Academic Press Inc., 125 E. 23rd St., New York 10, N. Y.
 - American Institute of Electrical Engineers, 33 W. 39th St., New York, N. Y.
 - American Radio Relay League, West Hartford, Conn.
 - American Standards Association, 70 E. 45th St., New York, N. Y.
 - Audel & Co., Theodore, 49 W. 23rd St., New York, N. Y.
 - Bernards Publishers Ltd., The Gramplans, Western Gate, London W. 6, England.
 - Boyce-Roche Book Co., 460 Bloomfield Ave., Montclair, N. J.
 - Chapman & Hall Ltd., 37 Essex St., London, W. C. 2, England.

- Day Co. Inc., John, 62 W. 45th St., New York, N. Y.
- Dover Publications Inc., 1780 Broadway, New York, N. Y.
- Editors and Engineers Ltd., Santa Barbara, Calif.
- Electronics Research Publishing Co., Inc., 480 Canal St., New York 13, N. Y.
- Elsevier Publishing Co., Inc., 215 Fourth Ave., New York, N. Y.
- Engineers Council for Professional Development, 29 W. 39th St., New York, N. Y.
- Federal Telephone & Radio Corp., Publication Dept., 67 Broad St., New York 4, N. Y.
- Harper & Brothers, 49 E. 33rd St., New York, N. Y.
- Industrial Research Service, Dover, N. H.
- Institute of Radio Engineers, Inc., 1 E. 79th St., New York, N. Y.
- International Publishers Co., 381 Fourth Ave., New York, N. Y.
- Interscience Publishers Inc., 215 Fourth Ave., New York 3, N. Y.
- Irwin Inc., Richard D., 3201 S. Michigan Ave., Chicago 16, Ill.
- McGraw-Hill Book Company, Inc., 330 W. 42nd St., New York 18, N. Y.
- Macmillan Co., The, 60 Fifth Ave., New York 11, N. Y.
- Maedel Publishing House, 593 East 38th St., Brooklyn 3, N. Y.
- Murray Hill Books Inc., 232 Madison Ave., New York, N. Y.
- National Bureau of Standards, Washington, D. C.
- Nelson & Sons, Thomas, 385 Madison Ave., New York, N. Y.
- Oxford University Press, 114 Fifth Ave., New York, N. Y.
- Philips Gloeilampenfabrieken, N. V., Eindhoven, The Netherlands.
- Philosophical Library, Publishers, 15 E. 40th St., New York 16, N. Y.
- Pitman Publishing Corp., 2 W. 45th St., New York, N. Y.
- Prentice-Hall Inc., 70 Fifth Ave., New York, N. Y.
- Princeton University Press, Princeton, N. J.
- Radcraft Publications Inc., 25 W. Broadway, New York, N. Y.
- Radio Corporation of America, R C A Laboratories Div., Princeton, N. J.
- Radio Corporation of America, Tube Dept., Harrison, N. J.
- Rider Publications Inc., John F., 480 Canal St., New York 13, N. Y.
- Ronald Press Co., The, 15 E. 26th St., New York 10, N. Y.
- Sams Co. Inc., Howard W., 2201 E. 46th St., Indianapolis 5, Ind.
- Stechert-Hafner Inc., 31 East 10th St., New York, N. Y.
- United Catalog Publishers Inc., 110 Lafayette St., New York, N. Y.
- Universal Scientific Co. Inc., Vincennes, Ind.
- University of Chicago Press, The, Chicago, Ill.
- VanNostrand Co., Inc., D., 250 Fourth Ave., New York 3, N. Y.
- Wiley & Sons Inc., John, 440 Fourth Ave., New York, N. Y.

TELEMETERING SYSTEMS—Electronic

- AIR ASSOCIATES, INC., Teterboro, N. J. ADV. PG. 211.
- AIRMEC LABORATORIES, LTD., 366 Madison Ave., New York 17, N. Y. ADV. PG. 336.
- Applied Science Corp. of Princeton, The, P. O. Box 44, Princeton, N. J.
- Bailey Meter Co., 1044 Ivanhoe Rd., Cleveland 10, Ohio.
- Bendix Aviation Corp., Pacific Division, 11600 Sherman Way, North Hollywood, Calif.
- Bristol Co., The, Waterbury 20, Conn.
- Clarke Instrument Div., National Electrical Machine Shops, Inc., 919 Jesup-Blair Drive, Silver Spring, Md.
- Control Corp., 718 Central Ave., Minneapolis 14, Minn.
- EDIN CO., INC., 207 Main St., Worcester, Mass. ADV. PG. 285.
- Electro-Mechanical Research, Inc., Ridgefield, Conn.
- Esterline-Angus Co., Inc., P. O. Box 596, Indianapolis, Ind.
- Flader, Inc., Fredric, 1330 Laskey Rd., Toledo 12, Ohio.
- GENERAL ELECTRIC CO., Schenectady 5, N. Y. ADV. PG. 1 to 22.
- GENERAL ELECTRIC CO., Electronics Dept., Electronics Park, Syracuse, N. Y. ADV. PG. 1 to 22.
- Hastings Instrument Co., Inc., Hampton 9, Va.
- Lear, Inc., 110 Ionia Ave., NW., Grand Rapids 2, Mich.
- LENKURT ELECTRIC CO., INC., San Carlos, Calif. ADV. PG. 412.
- Lynch Co., F. W., 96 Jessie St., San Francisco, Calif.
- Manning, Maxwell & Moore, Inc., Stratford, Conn.
- Melpar, Inc., 552 Swann Ave., Alexandria, Va.
- Motorola, Inc., 4545 Augusta Blvd., Chicago 51, Ill.
- Northeastern Engineering, Inc., Manchester, N. H.
- POTTER INSTRUMENT CO., INC., 115 Cutter Mill Rd., Great Neck, N. Y. ADV. PG. 318.
- RAHM INSTRUMENTS, INC., 12 West Broadway, New York 7, N. Y. ADV. PG. 354.

Ⓜ indicates . . . IN PRODUCTION • AVAILABILITY • UNRESTRICTED FOR GENERAL USE

- Ⓜ Rosen Engineering Products, Inc., Raymond, 32nd & Walnut Sts., Philadelphia 4, Pa.
- Ⓜ SYLVANIA ELECTRIC PRODUCTS, INC., 1740 Broadway, New York 19, N. Y. ADV. PG. 432-436.
- Ⓜ Telemetering Associates, P. O. Box 6, Silver Spring, Md.
- Ⓜ Thompson & Associates, John E., 7210 S. Yates Ave., Chicago 49, Ill.
- Ⓜ WESTINGHOUSE ELECTRIC CORP., 511 Wood St., P. O. Box 868, Pittsburgh 30, Pa. ADV. PG. 107-113.

TELEPHONES—Handsets

- Ⓜ Automatic Electric Sales Corp., 1033 W. Van Buren St., Chicago 7, Ill.
- Ⓜ Bendix Radio Division, Bendix Aviation Corp., Baltimore 4, Md.
- Ⓜ Connecticut Telephone & Electric Corp., 70 Brittainia St., Meriden, Conn.
- Ⓜ Edwards Co., Inc., 86 Boston Post Rd., Norwalk, Conn.
- Ⓜ FEDERAL TELEPHONE & RADIO CORP., 88 Kingsland Rd., Clifton, N. J. ADV. PG. 161-163.
- Ⓜ Insuline Corp. of America, 36-02 35th Ave., Long Island City, N. Y.
- Ⓜ KELLOGG SWITCHBOARD & SUPPLY CO., 6650 S. Cicero Ave., Chicago 38, Ill. ADV. PG. 294.
- Ⓜ Philmore Mfg. Co., 113 University Pl., New York 13, N. Y.
- Ⓜ Stromberg-Carlson Co., Rochester 13, N. Y.
- Ⓜ Telephonics Corp., Park Ave., Huntington, N. Y.
- Ⓜ U. S. Instrument Corp., 409 Broad St., Summit, N. J.
- Ⓜ Wheeler Insulated Wire Co., Inc., 150 E. Aurora St., Waterbury 91, Conn.

TELEVISION MASKS

See Masks, Television

TELEVISION PROJECTION SCREENS

See Screens, Television Projection

TELEVISION SYSTEMS—Industrial

- Ⓜ Capehart-Farnsworth Corp., Fort Wayne, Indiana.
- Ⓜ Diamond Power Specialty Corp., Lancaster, Ohio.
- Ⓜ Douglas Radio Labs, 176 Norfolk Ave., Boston 19, Mass.
- Ⓜ DuMont Laboratories, Inc., Allen B., Television Transmitter Div., 1000 Main Ave., Clifton, N. J.
- Ⓜ GENERAL ELECTRIC CO., Electronics Dept., Electronics Park, Syracuse, N. Y. ADV. PG. 1 to 22.
- Ⓜ GRAY RESEARCH & DEVELOPMENT CO., 16 Arbor St., Hartford 1, Conn. ADV. PG. 363.
- Ⓜ Jamaica Electronics Products Co., 95-26 Sutphin Blvd., Jamaica 4, N. Y.
- Ⓜ MARCONI INSTRUMENTS, LTD., 23 Beaver St., New York 4, N. Y. ADV. PG. 270.
- Ⓜ Monarch Radio & Television Corp., 2430 Atlantic Ave., Brooklyn 33, N. Y.
- Ⓜ Multiple Television Mfg. Co., 987 Hegeman Ave., Brooklyn 8, N. Y.
- Ⓜ RADIO CORP. OF AMERICA, RCA Victor Div., General Offices, Camden, N. J. ADV. PG. 177, Inside Back and Back Covers.
- Ⓜ Remington Rand, Inc., Vericon Dept., 315 4th Ave., New York, N. Y.
- Ⓜ Telechrome, Inc., 88 Merrick Rd., Amityville, N. Y.
- Ⓜ Television Equipment Corp., 238 William St., New York 7, N. Y.
- Ⓜ TRAD TELEVISION CORP., 1001 First Ave., Asbury Park, N. J. ADV. PG. 355.

TENSIONS—Coil Winding

- Ⓜ Paper Machinery & Research Inc., 1014 Oak St., Roselle, N. J.

TERMINAL BLOCKS

- Ⓜ AIRCRAFT-MARINE PRODUCTS, INC., 2100 Paxton St., Harrisburg 10, Pa. ADV. PG. 367.
- Ⓜ AMERICAN PHENOLIC CORPORATION, 1830 S. 54th Ave., Chicago 50, Ill. ADV. PG. 61.
- Ⓜ Arrow-Hart & Hegeman Electric Co., 100 Hawthorn St., Hartford 6, Conn.
- Ⓜ Art Roll Leaf Stamping Co., 3610 Palisade Ave., Union City, N. J.
- Ⓜ Baer Co., N. S., 9 Montgomery St., Hillside, N. J.
- Ⓜ BELLING & LEE, LTD., 366 Madison Ave., New York 17, N. Y. ADV. PG. 336.
- Ⓜ Brach Mfg. Corp., 200 Central Ave., Newark 4, N. J.
- Ⓜ BUCHANAN ELECTRICAL PRODUCTS CORP., 223 Route 29, Hillside, N. J. ADV. PG. 332.
- Ⓜ Burke Electric Co., 12th & Cranberry Sts., Erie, Pa.
- Ⓜ Burndy Engineering Co., Inc., 107 Bruckner Blvd., New York 54, N. Y.
- Ⓜ CAMBRIDGE THERMIONIC CORP., 445 Concord Ave., Cambridge 38, Mass. ADV. PG. 37.
- Ⓜ CINCH MFG. CORP., 1026 S. Homan Ave., Chicago 24, Ill. ADV. PG. 186, 187.
- Ⓜ CINEMA ENGINEERING CO., 1510 W. Verdugo Ave., Burbank, Calif. ADV. PG. 204.

- Ⓜ Clarke Instrument Div., National Machine Shops, Inc., 919 Jesup-Blair Drive, Silver Spring, Md.
- Ⓜ Connecticut Telephone & Electric Corp., 70 Brittainia St., Meriden, Conn.
- Ⓜ Cook Electric Co., 2700 Southport Ave., Chicago 14, Ill.
- Ⓜ CURTIS DEVELOPMENT & MFG. CO., 4524 W. Madison St., Chicago 24, Ill. ADV. PG. 407.
- Ⓜ EBY INC., HUGH H., 4700 Stenton Ave., Philadelphia 44, Pa. ADV. PG. 214.
- Ⓜ Edwards Co., Inc., 86 Boston Post Rd., Norwalk, Conn.
- Ⓜ Electrical Refractories Co., 50 Clark St., East Palestine, Ohio.
- Ⓜ ELECTRONIC MECHANICS, INC., 70 Clifton Blvd., Clifton, N. J. ADV. PG. 309.
- Ⓜ FEDERAL SCREW PRODUCTS INC., 224 W. Huron St., Chicago 10, Ill. ADV. PG. 76.
- Ⓜ FEDERAL TELEPHONE AND RADIO CORP., 88 Kingsland Rd., Clifton, N. J. ADV. PG. 161-163.
- Ⓜ FRANKLIN AIRLOOP CORP., 43-20 34th St., Long Island City, N. Y. ADV. PG. 45.
- Ⓜ FRANKLIN MFG. CORP., A. W., 43-20 34th St., Long Island City 1, N. Y. ADV. PG. 44.
- Ⓜ GENERAL ELECTRIC CO., Schenectady 5, N. Y. ADV. PG. 1 to 22.
- Ⓜ Gits Molding Corp., 4600 W. Huron St., Chicago 44, Ill.
- Ⓜ Insulation Mfg. Co., 11 New York Ave., Brooklyn, N. Y.
- Ⓜ JONES DIV., HOWARD B., Cinch Mfg. Corp., 1026 S. Homan Ave., Chicago 24, Ill. ADV. PG. 186, 187.
- Ⓜ Keystone Electronics Co., 423 Broome St., New York 12, N. Y.
- Ⓜ Kolton Electric Mfg. Co., 123 New Jersey Railroad Ave., Newark 5, N. J.
- Ⓜ KULKA ELECTRIC MFG. CO., INC., 30 South St., Mt. Vernon, N. Y. ADV. PG. 317.
- Ⓜ LOUTHAN MFG. CO., East Liverpool, Ohio. ADV. PG. 284.
- Ⓜ Millen Mfg. Co., James, 150 Exchange St., Malden, Mass.
- Ⓜ Molded Insulation Co., 335 E. Price St., Philadelphia 44, Pa.
- Ⓜ MOLDING CORP. OF AMERICA, 30 Church St., Pawtucket, R. I. ADV. PG. 385.
- Ⓜ MYCALEX CORP., OF AMERICA, 60 Clifton Blvd., Clifton, N. J. ADV. PG. 258, 259.
- Ⓜ Northern Industrial Chemical Co., 7-11 Elkins St., South Boston 27, Mass.
- Ⓜ Penn Fibre & Specialty Co., 2020 E. Westmoreland St., Philadelphia 34, Pa.
- Ⓜ Pruden Radio & Sound Co., 5687 College Ave., Oakland 18, Calif.
- Ⓜ RICHARDSON CO., THE, 2767 Lake St., Melrose Park, Ill. ADV. PG. 310.
- Ⓜ ROHDEN MANUFACTURING CO., 4739 Montrose Ave., Chicago 41, Ill. ADV. PG. 406.
- Ⓜ Smith, Inc., Herman H., 436 18th St., Brooklyn 15, N. Y.
- Ⓜ Spaulding Fibre Co., Inc., 310 Wheeler St., Tonawanda, N. Y.
- Ⓜ States Co., 19 New Park Ave., Hartford 6, Conn.
- Ⓜ STUPAKOFF CERAMIC & MFG. CO., Latrobe, Pa. ADV. PG. 167.
- Ⓜ TEFLON PRODUCTS DIVISION, U. S. GASKET CO., P. O. Box 93, Camden, N. J. ADV. PG. 176.
- Ⓜ U. S. Instrument Corp., 409 Broad St., Summit, N. J.
- Ⓜ Wade Electric Products Co., 211 Jacob St., Sturgis, Mich.
- Ⓜ WESTINGHOUSE ELECTRIC CORP., 511 Wood St., P. O. Box 868, Pittsburgh 30, Pa. ADV. PG. 107-113.

TERMINAL BOARDS

- Ⓜ AEROLITE ELECTRONIC HARDWARE CORP., 507 26th St., Union City, N. J. ADV. PG. 355.
- Ⓜ ALDEN PRODUCTS CO., 117 N. Main St., Brockton 64, Mass. ADV. PG. 327.
- Ⓜ Art Roll Leaf Stamping Co., 3610 Palisade Ave., Union City, N. J.
- Ⓜ Baer Co., N. S., 9 Montgomery St., Hillside, N. J.
- Ⓜ BELLING & LEE, LTD., 366 Madison Ave., New York 17, N. Y. ADV. PG. 336.
- Ⓜ BUCHANAN ELECTRICAL PRODUCTS CORP., 223 Route 29, Hillside, N. J. ADV. PG. 332.
- Ⓜ Burndy Engineering Co., Inc., 107 Bruckner Blvd., New York 54, N. Y.
- Ⓜ CAMBRIDGE THERMIONIC CORP., 445 Concord Ave., Cambridge 38, Mass. ADV. PG. 37.
- Ⓜ CINCH MFG. CORP., 1026 S. Homan Ave., Chicago 24, Ill. ADV. PG. 186, 187.
- Ⓜ CITATION PRODUCTS CO., 233 E. 146th St., New York 51, N. Y. ADV. PG. 388.
- Ⓜ Connecticut Telephone & Electric Corp., 70 Brittainia St., Meriden, Conn.
- Ⓜ CURTIS DEVELOPMENT & MFG. CO., 4524 W. Madison St., Chicago 24, Ill. ADV. PG. 407.
- Ⓜ EBY, INC., HUGH H., 4700 Stenton Ave., Philadelphia 44, Pa. ADV. PG. 214.
- Ⓜ Edwards Co., Inc., 86 Boston Post Rd., Norwalk, Conn.
- Ⓜ ELECTRONIC MECHANICS, INC., 70 Clifton Blvd., Clifton, N. J. ADV. PG. 309.
- Ⓜ FEDERAL SCREW PRODUCTS INC., 224 W. Huron St., Chicago 10, Ill. ADV. PG. 76.
- Ⓜ FEDERAL TELEPHONE & RADIO CORP., 88 Kingsland Rd., Clifton, N. J. ADV. PG. 161-163.

- Ⓜ FRANKLIN AIRLOOP CORP., 43-20 34th St., Long Island City, N. Y. ADV. PG. 45.
- Ⓜ FRANKLIN MFG. CORP., A. W., 43-20 34th St., Long Island City 1, N. Y. ADV. PG. 44.
- Ⓜ GENERAL ACCESSORIES CO., LTD., 366 Madison Ave., New York 17, N. Y. ADV. PG. 336.
- Ⓜ GENERAL ELECTRIC CO., Schenectady 5, N. Y. ADV. PG. 1 to 22.
- Ⓜ INDUSTRIAL HARDWARE MFG. CO., INC., 109 Prince St., New York, N. Y. ADV. PG. 360.
- Ⓜ Insulation Mfg. Co., 11 New York Ave., Brooklyn, N. Y.
- Ⓜ Insuline Corp. of America, 36-02 35th Ave., Long Island City, N. Y.
- Ⓜ Isolantite Mfg. Corp., Stirling, N. J.
- Ⓜ JONES DIV., HOWARD B., Cinch Mfg. Corp., 1026 S. Homan Ave., Chicago 24, Ill. ADV. PG. 186, 187.
- Ⓜ Keystone Electronics Co., 423 Broome St., New York 12, N. Y.
- Ⓜ Kolton Electric Mfg. Co., 123 New Jersey Railroad Ave., Newark 5, N. J.
- Ⓜ KULKA ELECTRIC MFG. CO., INC., 30 South St., Mount Vernon, N. Y. ADV. PG. 317.
- Ⓜ Masonite Corp., 111 W. Washington St., Chicago 2, Ill.
- Ⓜ METHODE MFG. CORP., 2265 W. St. Paul Ave., Chicago 47, Ill. ADV. PG. 347.
- Ⓜ Micarta Fabricators, Inc., 5324 Ravenswood Ave., Chicago 40, Ill.
- Ⓜ Millen Mfg. Co., James, 150 Exchange St., Malden, Mass.
- Ⓜ Molded Insulation Co., 335 E. Price St., Philadelphia 44, Pa.
- Ⓜ MYCALEX CORP. OF AMERICA, 60 Clifton Blvd., Clifton, N. J. ADV. PG. 258, 259.
- Ⓜ National Tel-Tronics Corp., 35 Casmirs Ave., Yonkers, N. Y.
- Ⓜ Northern Industrial Chemical Co., 7-11 Elkins St., South Boston 27, Mass.
- Ⓜ Penn Fibre & Specialty Co., 2020 E. Westmoreland St., Philadelphia 34, Pa.
- Ⓜ Plasticraft Products Co., 20 Hudson St., New York 13, N. Y.
- Ⓜ PRECISION METAL PRODUCTS CO. OF MALDEN, 41 Elm St., Stoneham 80, Mass. ADV. PG. 341.
- Ⓜ Press Wireless Mfg. Co., Inc., Cantiague Rd., Hicksville, N. Y.
- Ⓜ RICHARDSON CO., THE, 2767 Lake St., Melrose Park, Ill. ADV. PG. 310.
- Ⓜ ROHDEN MANUFACTURING CO., 4739 Montrose Ave., Chicago 41, Ill. ADV. PG. 406.
- Ⓜ Smith, Inc., Herman H., 436 18th St., Brooklyn 15, N. Y.
- Ⓜ States Co., 19 New Park Ave., Hartford 6, Conn.
- Ⓜ TEFLON PRODUCTS DIVISION, U. S. GASKET CO., P. O. Box 93, Camden, N. J. ADV. PG. 176.
- Ⓜ Ucinite Co. Division, United-Carr Fastener Corp., 459 Watertown St., Newtonville, Mass.
- Ⓜ U. S. Engineering Co., 521 Commercial St., Glendale 3, Calif.
- Ⓜ Wade Electric Products Co., 211 Jacob St., Sturgis, Mich.
- Ⓜ WALTHAM HOROLOGICAL CORP., Waltham, Mass. ADV. PG. 409.

TERMINAL STRIPS

- Ⓜ AEROLITE ELECTRONIC HARDWARE CORP., 507 26th St., Union City, N. J. ADV. PG. 355.
- Ⓜ ALDEN PRODUCTS CO., 117 N. Main St., Brockton 64, Mass. ADV. PG. 327.
- Ⓜ Art Roll Leaf Stamping Co., 3610 Palisade Ave., Union City, N. J.
- Ⓜ Baer Co., N. S., 9 Montgomery St., Hillside, N. J.
- Ⓜ BELLING & LEE, LTD., 366 Madison Ave., New York 17, N. Y. ADV. PG. 336.
- Ⓜ Birnbach Radio Co., Inc., 145 Hudson St., New York, N. Y.
- Ⓜ BUCHANAN ELECTRICAL PRODUCTS CORP., 223 Route 29, Hillside, N. J. ADV. PG. 332.
- Ⓜ Burndy Engineering Co., Inc., 107 Bruckner Blvd., New York 54, N. Y.
- Ⓜ CAMBRIDGE THERMIONIC CORP., 445 Concord Ave., Cambridge 38, Mass. ADV. PG. 37.
- Ⓜ CINCH MFG. CORP., 1026 S. Homan Ave., Chicago 24, Ill. ADV. PG. 186, 187.
- Ⓜ CITATION PRODUCTS CO., 233 E. 146th St., New York 51, N. Y. ADV. PG. 388.
- Ⓜ Connecticut Telephone & Electric Corp., 70 Brittainia St., Meriden, Conn.
- Ⓜ Cook Electric Co., 2700 Southport Ave., Chicago 14, Ill.
- Ⓜ CURTIS DEVELOPMENT & MFG. CO., 4524 W. Madison St., Chicago 24, Ill. ADV. PG. 407.
- Ⓜ EBY, INC., HUGH H., 4700 Stenton Ave., Philadelphia 44, Pa. ADV. PG. 214.
- Ⓜ Edwards Co., Inc., 86 Boston Post Rd., Norwalk, Conn.
- Ⓜ ELECTRONIC MECHANICS, INC., 70 Clifton Blvd., Clifton, N. J. ADV. PG. 309.
- Ⓜ FEDERAL SCREW PRODUCTS INC., 224 W. Huron St., Chicago 10, Ill. ADV. PG. 76.
- Ⓜ FEDERAL TELEPHONE AND RADIO CORP., 88 Kingsland Rd., Clifton, N. J. ADV. PG. 161-163.
- Ⓜ FRANKLIN AIRLOOP CORP., 43-20 34th St., Long Island City, N. Y. ADV. PG. 45.
- Ⓜ FRANKLIN MFG. CORP., A. W., 43-20 34th St., Long Island City 1, N. Y. ADV. PG. 44.
- Ⓜ GENERAL ACCESSORIES CO., LTD., 366 Madison Ave., New York 17, N. Y. ADV. PG. 336.

V indicates . . . **IN PRODUCTION • AVAILABILITY • UNRESTRICTED FOR GENERAL USE**

- ⓄGeneral Cement Mfg. Co., 919 Taylor Ave., Rockford, Ill.
- ⓄGENERAL ELECTRIC CO., Schenectady 5, N. Y. ADV. PG. 1 to 22.
- ⓄGreene Mfg. Corp., G. G., Warren, Pa.
- ⓄHERMETIC SEAL PRODUCTS CO., 29-37 South 6th St., Newark 7, N. J. ADV. PG. 175.
- ⓄINDUSTRIAL HARDWARE MFG. CO., INC., 109 Prince St., New York, N. Y. ADV. PG. 360.
- ⓄInsulation Mfg. Co., 11 New York Ave., Brooklyn, N. Y.
- ⓄInsuline Corp. of America, 36-02 35th Ave., Long Island City, N. Y.
- ⓄIsolantite Mfg. Corp., Stirling, N. J.
- ⓄJFD MFG. CO., 6101-23 Sixteenth Ave., Brooklyn, N. Y. ADV. PG. 407.
- ⓄJONES DIV., HOWARD B., Cinch Mfg. Corp., 1026 S. Homan Ave., Chicago 24, Ill. ADV. PG. 186, 187.
- ⓄKeystone Electronics Co., 423 Broome St., New York 12, N. Y.
- ⓄKULKA ELECTRIC MFG. CO., INC., 30 South St., Mount Vernon, N. Y. ADV. PG. 317.
- ⓄMETHODE MFG. CORP., 2265 W. St. Paul Ave., Chicago 47, Ill. ADV. PG. 347.
- ⓄMicarta Fabricators, Inc., 5324 Ravenswood Ave., Chicago 40, Ill.
- ⓄMillen Mfg. Co., James, 150 Exchange St., Malden, Mass.
- ⓄMiller Co., J. W., 5917 S. Main St., Los Angeles 3, Calif.
- ⓄMolded Insulation Co., 335 S. Price St., Philadelphia 44, Pa.
- ⓄMOLDING CORP. OF AMERICA, 30 Church St., Pawtucket, R. I. ADV. PG. 385.
- ⓄMoore Co., Howard J., 108 Park Row, New York 7, N. Y.
- ⓄMYCALEX CORP. OF AMERICA, 60 Clifton Blvd., Clifton, N. J. ADV. PG. 258, 259.
- ⓄNational Tel-Tronics Corp., 35 Casmirs Ave., Yonkers, N. Y.
- ⓄNorthern Industrial Chemical Co., 7-11 Elkins St., South Boston 27, Mass.
- ⓄPenn Fibre & Specialty Co., 2020 E. Westmoreland St., Philadelphia 34, Pa.
- ⓄPIX MFG. CO., INC., 24 Bedford St., Newark, N. J. ADV. PG. 136.
- ⓄPRECISION METAL PRODUCTS CO. OF MALDEN, 41 Elm St., Stoneham 80, Mass. ADV. PG. 341.
- ⓄPress Wireless Mfg. Co., Inc., Cantigue Rd., Hicksville, N. Y.
- ⓄRICHARDSON CO., THE, 2767 Lake St., Melrose Park, Ill. ADV. PG. 310.
- ⓄROHDEN MANUFACTURING CO., 4739 Montrose Ave., Chicago 41, Ill. ADV. PG. 406.
- ⓄSERVOMECHANISMS, INC., Whaleneck Rd. & Stewart Ave., Westbury, L. I., N. Y. ADV. PG. 188.
- ⓄSmith, Inc., Herman H., 436 18th St., Brooklyn 15, N. Y.
- ⓄStates Co., 19 New Park Ave., Hartford 6, Conn.
- ⓄTEFLON PRODUCTS DIVISION, U. S. GASKET CO., P. O. Box 93, Camden, N. J. ADV. PG. 176.
- ⓄUcinite Co. Division, United-Carr Fastener Corp., 459 Watertown St., Newtonville, Mass.
- ⓄUNITED MFG. & SERVICE CO., 405 S. Sixth St., Milwaukee 4, Wis. ADV. PG. 324.
- ⓄU. S. Engineering Co., 521 Commercial St., Glendale 3, Calif.
- ⓄVECTOR ELECTRONIC CO., 1101 Riverside Drive, Los Angeles 31, Calif. ADV. PG. 283.
- ⓄWade Electric Products Co., 211 Jacob St., Sturgis, Mich.
- ⓄWALTHAM HOROLOGICAL CORP., Waltham, Mass. ADV. PG. 409.
- ⓄWheaton Co., T. G., Industrial Div., 220 G St., Millville, N. J.

TERMINALS

- ⓄAEROLITE ELECTRONIC HARDWARE CORP., 507 26th St., Union City, N. J. ADV. PG. 355.
- ⓄAIRCRAFT-MARINE PRODUCTS, INC., 2100 Paxton St., Harrisburg 10, Pa. ADV. PG. 367.
- ⓄALDEN PRODUCTS CO., 117 N. Main St., Brockton 64, Mass. ADV. PG. 327.
- ⓄAMERICAN BRASS CO., 25 Broadway, New York 4, N. Y. ADV. PG. 330.
- ⓄAutomatic Metal Products Co., 315 Berry St., Brooklyn 11, N. Y.
- ⓄBEAD CHAIN MANUFACTURING CO., 110 Mountain Grove St., Bridgeport 5, Conn. ADV. PG. 136.
- ⓄBELLING & LEE, LTD., 366 Madison Ave., New York 17, N. Y. ADV. PG. 336.
- ⓄBlrnbach Radio Co., Inc., 145 Hudson St., New York, N. Y.
- ⓄBUCHANAN ELECTRICAL PRODUCTS CORP., 223 Route 29, Hillside, N. J. ADV. PG. 332.
- ⓄBurdny Engineering Co., Inc., 107 Bruckner Blvd., New York 54, N. Y.
- ⓄCAMBRIDGE THERMIONIC CORP., 445 Concord Ave., Cambridge 38, Mass. ADV. PG. 37.
- ⓄCINCH MFG. CORP., 1026 S. Homan Ave., Chicago 24, Ill. ADV. PG. 186, 187.
- ⓄCITATION PRODUCTS CO., 233 E. 146th St., New York 51, N. Y. ADV. PG. 388.
- ⓄDante Electric Mfg. Co., Bantam, Conn.
- ⓄEastern Specialty Co., Philadelphia 40, Pa.
- ⓄFEDERAL SCREW PRODUCTS INC., 224 W. Huron St., Chicago 10, Ill. ADV. PG. 76.

- ⓄFrankel Connector Co., 177 Hudson St., New York, N. Y.
- ⓄFRANKLIN AIRLOOP CORP., 43-20 34th St., Long Island City, N. Y. ADV. PG. 45.
- ⓄFRANKLIN MFG. CORP., A. W., 43-20 34th St., Long Island City 1, N. Y. ADV. PG. 44.
- ⓄGrade Mfg. Co., Pawtucket, R. I.
- ⓄGENERAL ACCESSORIES CO., LTD., 366 Madison Ave., New York 17, N. Y. ADV. PG. 336.
- ⓄGeneral Cement Mfg. Co., 919 Taylor Ave., Rockford, Ill.
- ⓄHatheway Mfg. Co., 1500 Railroad Ave., Bridgeport, Conn.
- ⓄIlisco Copper Tube & Products Inc., Mariemont Ave., Mariemont, Cincinnati 27, Ohio.
- ⓄINDUSTRIAL HARDWARE MFG. CO., INC., 109 Prince St., New York, N. Y. ADV. PG. 360.
- ⓄInsuline Corp. of America, 36-02 35th Ave., Long Island City, N. Y.
- ⓄJOHNSON CO., E. F., Waseca, Minn. ADV. PG. 118, 121.
- ⓄKeystone Electronics Co., 423 Broome St., New York 12, N. Y.
- ⓄKoltan Electric Mfg. Co., 123 New Jersey Railroad Ave., Newark 5, N. J.
- ⓄKULKA ELECTRIC MFG. CO., INC., 30 South St., Mount Vernon, N. Y. ADV. PG. 317.
- ⓄMALCO TOOL & MFG. CO., 4025 W. Lake St., Chicago 24, Ill. ADV. PG. 385.
- ⓄMETHODE MFG. CORP., 2265 W. St. Paul Ave., Chicago 47, Ill. ADV. PG. 347.
- ⓄMicarta Fabricators, Inc., 5324 Ravenswood Ave., Chicago 40, Ill.
- ⓄMillen Mfg. Co., James, 150 Exchange St., Malden, Mass.
- ⓄMOLDING CORP. OF AMERICA, 30 Church St., Pawtucket, R. I. ADV. PG. 385.
- ⓄMorse Co., Frank W., 1300 Soldiers Field Rd., Boston 35, Mass.
- ⓄNATIONAL CO., INC., 61 Sherman St., Malden 48, Mass. ADV. PG. 280, 281.
- ⓄNational Tel-Tronics Corp., 35 Casmirs Ave., Yonkers, N. Y.
- ⓄPAINTON & CO., LTD., 366 Madison Ave., New York 17, N. Y. ADV. PG. 336.
- ⓄPATTON-MACGUYER CO., 17 Virginia Ave., Providence 5, R. I. ADV. PG. 390.
- ⓄPIX MFG. CO., INC., 24 Bedford St., Newark, N. J. ADV. PG. 136.
- ⓄPRECISION METAL PRODUCTS CO. OF MALDEN, 41 Elm St., Stoneham 80, Mass. ADV. PG. 341.
- ⓄROHDEN MANUFACTURING CO., 4739 Montrose Ave., Chicago 41, Ill. ADV. PG. 406.
- ⓄSt. Mary's Carbon Co., State Rd., St. Marys, Pa.
- ⓄSchott Co., Walter L., 3225 Exposition Pl., Los Angeles 18, Calif.
- ⓄShakeproof Inc., Div. of Illinois Tool Wks., 2501 N. Keeler Ave., Chicago 39, Ill.
- ⓄSHERMAN MFG. CO., H. B., 22 Barney St., Battle Creek, Mich. ADV. PG. 156.
- ⓄSmith, Inc., Herman H., 436 18th St., Brooklyn 15, N. Y.
- ⓄStimpson Co., Inc., Edwin B., 74 Franklin Ave., Brooklyn 5, N. Y.
- ⓄThomas & Betts Co., Inc., 40 Butler St., Elizabeth 1, N. J.
- ⓄUnited-Carr Fastener Corp., Cambridge 42, Mass.
- ⓄUnited Shoe Machinery Corp., 142 Federal St., Boston, Mass.
- ⓄU. S. Engineering Co., 521 Commercial St., Glendale 3, Calif.
- ⓄVaco Products Co., 317 E. Ontario St., Chicago 11, Ill.
- ⓄWade Electric Products Co., 211 Jacob St., Sturgis, Mich.
- ⓄWALTHAM HOROLOGICAL CORP., Waltham, Mass. ADV. PG. 409.
- ⓄWESTINGHOUSE ELECTRIC CORP., 511 Wood St., P.O. Box 868, Pittsburgh 30, Pa. ADV. PG. 107-113.
- ⓄWheaton Co., T. G., Industrial Div., 220 G St., Millville, N. J.
- ⓄWhitaker Cable Corp., Kansas City 16, Mo.
- ⓄWinslow Co., Inc., 9 Liberty St., Newark 5, N. J.
- ⓄZierick Mfg. Corp., Beechwood & Rockdale Aves., New Rochelle, N. Y.

TERMINALS—Hermetically Sealed

- ⓄBELLING & LEE, LTD., 366 Madison Ave., New York 17, N. Y. ADV. PG. 336.
- ⓄBurdny Engineering Co., Inc., 107 Bruckner Blvd., New York 54, N. Y.
- ⓄCINCH MFG. CORP., 1026 S. Homan Ave., Chicago 24, Ill. ADV. PG. 186, 187.
- ⓄELECTRICAL INDUSTRIES, INC., 44 Summer Ave., Newark 4, N. J. ADV. PG. 94.
- ⓄElectronic Apparatus Co., Elkhart, Ind.
- ⓄElectronic Mechanics, Inc., 70 Clifton Blvd., Clifton, N. J.
- ⓄFusite Corp., Carthage at Hannaford, Cincinnati 12, Ohio.
- ⓄGENERAL CERAMICS & STEATITE CORP., Keasbey, N. J. ADV. PG. 126, 127.
- ⓄHELDOR MFG. CO., Div. of Helder Bushing & Terminal Inc., 225 Belleville Ave., Bloomfield, N. J. ADV. PG. 242.
- ⓄHERMASEAL CO., INC., Riverside Drive, Elkhart, Ind., ADV. PG. 294.

- ⓄHERMETIC SEAL PRODUCTS CO., 29-37 S. 6th St., Newark 7, N. J. ADV. PG. 175.
- ⓄLUNDEY ASSOCIATES, 694 Main St., Waltham 54, Mass. ADV. PG. 410.
- ⓄMOLDING CORP. OF AMERICA, 30 Church St., Pawtucket, R. I. ADV. PG. 385.
- ⓄNEO-SIL CORP., 26 Cornelison Ave., Jersey City 4, N. J. ADV. PG. 253.
- ⓄSTUPAKOFF CERAMIC & MFG. CO., Latrobe, Pa. ADV. PG. 167.
- ⓄTriad Transformer Mfg. Co., 2254 Sepulveda Blvd., Los Angeles 64, Calif.
- ⓄWESTINGHOUSE ELECTRIC CORP., 511 Wood St., P.O. Box 868, Pittsburgh 30, Pa. ADV. PG. 107-113.
- ⓄWheaton Co., T. G., Industrial Division, 220 G Street, Millville, N. J.
- ⓄWolfe Co., Inc., Franklin C., 11723 Mississippi Ave., Los Angeles 25, Calif.

TEST CHAMBERS

See Chambers, Test

TESTERS—Automatic Tube

- ⓄMcMurdo Silver Co., Inc., 417 Lafayette St., New York, N. Y.
- ⓄMetropolitan Electronics & Instruments Co., 106 Fifth Ave., New York 11, N. Y.
- ⓄSimpson Electric Co., Div. American Gage & Machine Co., 5218 W. Kinzie St., Chicago, Ill.
- ⓄStar Measurements Co., 442 East 166th St., New York 56, N. Y.
- ⓄSupreme, Inc., Greenwood, Miss.

TESTERS—Battery

- ⓄBaldor Electric Co., 4353 Duncan Ave., St. Louis, Mo.
- ⓄBirnbach Radio Co., Inc., 145 Hudson St., New York, N. Y.
- ⓄElectro-Mechanical Instrument Co., 812 Chestnut St., Perkasie, Pa.
- ⓄHICKOK ELECTRICAL INSTRUMENT CO., 10514 Dupont Ave., Cleveland 8, Ohio. ADV. PG. 333.
- ⓄKing Electric Equipment Co., 9123 Inman Ave., Cleveland 5, Ohio.
- ⓄReliance Instrument Co., 3027 W. Van Buren St., Chicago 12, Ill.
- ⓄSHURITE METERS, 35-B Hamilton St., New Haven 8, Conn. ADV. PG. 390.
- ⓄSimpson Electric Co., Div. of American Gage & Machine Co., 5218 W. Kinzie St., Chicago 44, Ill.
- ⓄSupreme, Inc., Greenwood, Miss.
- ⓄTRAD TELEVISION CORP., 1001 First Ave., Asbury Park, N. J. ADV. PG. 355.
- ⓄTriplett Electrical Instrument Co., Harmon Rd., Bluffton, Ohio.
- ⓄWillard Storage Battery Co., 246 E. 131st St., Cleveland 1, Ohio.

TESTERS—Capacitor

- ⓄAEROVOX CORP., 740 Belleville Ave., New Bedford, Mass. ADV. PG. 352.
- ⓄClippard Instrument Laboratory, Inc., 1125 Bank St., Cincinnati 14, Ohio.
- ⓄClough Brengle Co., 6014 N. Broadway, Chicago, Ill.
- ⓄELECTRONIC INSTRUMENT CO., INC., 276 Newport St., Brooklyn 12, N. Y. ADV. PG. 129.
- ⓄFeller Engineering Co., 8026 Monticello Ave., Skokie, Ill.
- ⓄFREED TRANSFORMER CO., INC., 1736 Weirfield St., Brooklyn 27, N. Y. ADV. PG. 149.
- ⓄIndustrial Instruments Inc., 17 Pollack Ave., Jersey City 5, N. J.
- ⓄJackson Electrical Instrument Co., 16 S. Patterson Blvd., Dayton 1, Ohio.
- ⓄKing Electric Equipment Co., 9123 Inman Ave., Cleveland 5, Ohio.
- ⓄLeeds & Northrup Co., 4970 Stenton Ave., Philadelphia 44, Pa.
- ⓄMcMurdo Silver Co., Inc., 417 Lafayette St., New York, N. Y.
- ⓄNetwork Mfg. Corp., Bayonne, N. J.
- ⓄPENNSYLVANIA TESTING LABORATORY, Doylestown, Pa. ADV. PG. 350.
- ⓄSHALLCROSS MFG. CO., 10 Jackson Ave., Collingdale, Pa. ADV. PG. 261.
- ⓄSHERRON ELECTRONICS CO., 1201 Flushing Ave., Brooklyn 6, N. Y. ADV. PG. 145.
- ⓄSimpson Electric Co., Div. of American Gage & Machine Co., 5218 W. Kinzie St., Chicago 44, Ill.
- ⓄSPELLMAN TELEVISION CO., INC., 3029 Webster Ave., New York 67, N. Y. ADV. PG. 277.

TESTERS—Circuit

- ⓄBiddle Co., James G., 1316 Arch St., Philadelphia 7, Pa.
- ⓄBOGUE ELECTRIC MFG. CO., 52 Iowa Ave., Paterson 3, N. J. ADV. PG. 155.
- ⓄElectronic Measurements Corp., 280 Lafayette St., New York 12, N. Y.
- ⓄGeneral Cement Mfg. Co., 919 Taylor Ave., Rockford, Ill.

Ⓢ indicates . . . IN PRODUCTION • AVAILABILITY • UNRESTRICTED FOR GENERAL USE

- Ⓢ Gits Molding Corp., 4600 W. Huron St., Chicago 44, Ill.
- Ⓢ Jackson Electrical Instrument Co., 16 S. Patterson Blvd., Dayton 1, Ohio.
- Ⓢ King Electric Equipment Co., 9123 Inman Ave., Cleveland 5, Ohio.
- Ⓢ McMurdo Silver Co., Inc., 417 Lafayette St., New York, N. Y.
- Ⓢ Monarch Radio & Television Corp., 2430 Atlantic Ave., Brooklyn 33, N. Y.
- Ⓢ Peschel Electronics, Inc., 13 Garden St., New Rochelle, N. Y.
- Precision Apparatus Co., Inc., 92-27 Horace Harding Blvd., Elmhurst, N. Y.
- Ⓢ Radio City Products Co., Inc., 152 W. 25th St., New York 1, N. Y.
- Ⓢ Roller-Smith, Bethlehem, Pa.
- Ⓢ Simpson Electric Co., Div. of American Gage & Machine Co., 5218 W. Kinzie St., Chicago 44, Ill.
- Ⓢ Sittler Corp., 18 N. Ada St., Chicago 7, Ill.
- Ⓢ Star Measurements Co., 442 E. 166th St., New York 56, N. Y.
- Ⓢ Superior Instruments Co., 227 Fulton St., New York, N. Y.
- Ⓢ Supreme, Inc., Greenwood, Miss.
- Ⓢ TEL-RAD MFG. CO., INC., 7th & Madison St., Fennimore, Wis. ADV. PG. 412.
- Ⓢ TRAD TELEVISION CORP., 1001 First Ave., Asbury Park, N. J. ADV. PG. 355.
- Ⓢ Triplett Electrical Instrument Co., Harmon Rd., Bluffton, Ohio.
- Ⓢ WESTINGHOUSE ELECTRIC CORP., 511 Wood St., P.O. Box 868, Pittsburgh 30, Pa. ADV. PG. 107-113.
- Ⓢ WESTON ELECTRICAL INSTRUMENT CORP., 595 Frelinghuysen Ave., Newark 5, N. J. ADV. PG. 243.

TESTERS—Coating Thickness

- American Instrument Co., 8030 Georgia Ave., Silver Spring, Md.
- Ⓢ BRANSON INSTRUMENTS, INC., 438 Fairfield Ave., Stamford, Conn. ADV. PG. 90.
- Ⓢ Feiler Engineering Co., 8026 Monticello Ave., Skokie, Ill.
- Ⓢ GENERAL ELECTRIC CO., Schenectady 5, N. Y. ADV. PG. 1 to 22.
- Ⓢ MARCONI INSTRUMENTS, LTD., 23 Beaver St., New York 4, N. Y. ADV. PG. 270.

TESTERS—Coil

- Ⓢ AIRMEC LABORATORIES, LTD., 366 Madison Ave., New York 17, N. Y. ADV. PG. 336.
- Ⓢ Biddle Co., James G., 1316 Arch St., Philadelphia 7, Pa.
- Ⓢ Clough Brengle Co., 6014 N. Broadway, Chicago, Ill.
- Ⓢ FREED TRANSFORMER CO., INC., 1736 Weirfield St., Brooklyn 27, N. Y. ADV. PG. 149.
- Ⓢ GENERAL ELECTRIC CO., Schenectady 5, N. Y. ADV. PG. 1 to 22.
- Ⓢ Katron, Drawer 472, Huntington Beach, Calif.
- Ⓢ King Electric Equipment Co., 9123 Inman Ave., Cleveland 5, Ohio.
- Ⓢ McMurdo Silver Co., Inc., 417 Lafayette St., New York, N. Y.
- Ⓢ PENNSYLVANIA TESTING LABORATORY, Doylestown, Pa. ADV. PG. 350.
- Ⓢ Photobell Company, 116 Nassau St., New York 7, N. Y.
- Ⓢ Rubicon Co., 3761 Ridge Ave., Philadelphia 42, Pa.
- Ⓢ Thordarson-Meissner Mfg. Divisions, 500 W. Huron St., Chicago 10, Ill.
- Ⓢ WESTON ELECTRICAL INSTRUMENT CORP., 595 Frelinghuysen Ave., Newark 5, N. J. ADV. PG. 243.

TESTERS—Color Infra Red

- Ⓢ Farrand Optical Co., Inc., Bronx Blvd, at 238th St., New York 70, N. Y.
- Ⓢ PRECISE MEASUREMENTS CO., 942 Kings Highway, Brooklyn 23, N. Y. ADV. PG. 401.

TESTERS—Continuity

- Ⓢ ELECTRONIC DESIGNS INC., 28-30 School St., Yonkers, N. Y. ADV. PG. 332.
- Ⓢ Electronic Measurements Corp., 280 Lafayette St., New York 12, N. Y.
- Ⓢ Feiler Engineering Co., 8026 Monticello Ave., Skokie, Ill.
- Ⓢ Instrument Laboratories, 315 W. Walton Place, Chicago 10, Ill.
- Ⓢ McMurdo Silver Co., Inc., 417 Lafayette St., New York, N. Y.
- Ⓢ Monarch Radio & Television Corp., 2430 Atlantic Ave., Brooklyn 33, N. Y.
- Ⓢ Peschel Electronics, Inc., 13 Garden St., New Rochelle, N. Y.
- Ⓢ Philco Corp., Tioga & C Sts., Philadelphia 34, Pa.
- Ⓢ PRECISE MEASUREMENTS CO., 942 Kings Highway, Brooklyn 23, N. Y. ADV. PG. 401.
- Ⓢ Radio City Products Co., Inc., 152 W. 25th St., New York 1, N. Y.
- Ⓢ Sittler Corp., 18 N. Ada St., Chicago 7, Ill.
- Ⓢ Superior Instrument Co., 227 Fulton St., New York, N. Y.

TESTERS—Crystal Testing

- Ⓢ Bassett Inc., Rex, 307-311 N. W. First Ave., Fort Lauderdale, Fla.
- Ⓢ Berkshire Laboratories, 580 Lexington Rd., Concord, Mass.
- Ⓢ CLARK CRYSTAL CO., 2 Farm Rd., Marlboro, Mass. ADV. PG. 366.
- Ⓢ Jefferson, Inc., Ray, 40 E. Merrick Rd., Freeport, N. Y.
- Ⓢ PENNSYLVANIA TESTING LABORATORY, Doylestown, Pa. ADV. PG. 350.
- Ⓢ REEVES-HOFFMAN CORP., 321 Cherry St., Carlisle, Pa. ADV. PG. 286.

TESTERS—Distortion

- Ⓢ AIRMEC LABORATORIES, LTD., 366 Madison Ave., New York 17, N. Y. ADV. PG. 336.
- Ⓢ Audio Instrument Co., 133 W. 14th St., New York 11, N. Y.
- Ⓢ BARKER & WILLIAMSON, 235 Fairfield Ave., Upper Darby, Pa. ADV. PG. 292.
- Ⓢ DAVEN CO., 191 Central Ave., Newark 4, N. J. ADV. PG. 157.
- Ⓢ Feiler Engineering Co., 8026 Monticello Ave., Skokie, Ill.
- Ⓢ FREED TRANSFORMER CO., INC., 1736 Weirfield St., Brooklyn 27, N. Y. ADV. PG. 149.
- Ⓢ McMurdo Silver Co., Inc., 417 Lafayette St., New York, N. Y.
- Ⓢ PANORAMIC RADIO PRODUCTS, INC., 10 S. Second Ave., Mt. Vernon, N. Y. ADV. PG. 383.
- Ⓢ Waveforms, Inc., 333 Sixth Ave., New York 14, N. Y.

TESTERS—Insulation

- Ⓢ Aircraft Electronics Associates, Inc., 94 Silas Deane Highway, Rocky Hill, Conn.
- Ⓢ AIRMEC LABORATORIES, LTD., 366 Madison Ave., New York 17, N. Y. ADV. PG. 336.
- Ⓢ Associated Research, Inc., 3758 W. Belmont, Chicago 18, Ill.
- Ⓢ Biddle Co., James G., 1316 Arch St., Philadelphia 7, Pa.
- Ⓢ Cole Instrument Co., 1320 S. Grand Ave., Los Angeles 15, Calif.
- Ⓢ Electronic Brazing Co., 140 Glenridge Ave., Montclair, N. J.
- Ⓢ EL-TRONICS, INC., 2649 N. Howard St., Philadelphia 33, Pa. ADV. PG. 299.
- Ⓢ Flader, Inc., Fredric, 1330 Laskey Rd., Toledo 12, Ohio.
- Ⓢ FREED TRANSFORMER CO., INC., 1736 Weirfield St., Brooklyn 27, N. Y. ADV. PG. 149.
- Ⓢ GENERAL ELECTRIC CO., Schenectady 5, N. Y. ADV. PG. 1 to 22.
- Ⓢ GENERAL RADIO CO., 275 Massachusetts Ave., Cambridge 39, Mass. ADV. PG. 48, 49.
- Ⓢ Holtzer-Cabot Div. of National Pneumatic Co., Inc., 125 Amory St., Boston 19, Mass.
- Ⓢ Industrial Instruments Inc., 17 Pollack Ave., Jersey City 5, N. J.
- Ⓢ Kelley-Koett Instrument Co., 962 York St., Cincinnati 14, Ohio.
- Ⓢ Leeds & Northrup Co., 4970 Stenton Ave., Philadelphia 44, Pa.
- Ⓢ MEASUREMENTS CORP., Boonton, N. J. ADV. PG. 99.
- Ⓢ Peschel Electronics, Inc., 13 Garden St., New Rochelle, N. Y.
- Ⓢ PRECISE MEASUREMENTS CO., 942 Kings Highway, Brooklyn 23, N. Y. ADV. PG. 401.
- Ⓢ Radio Frequency Labs., Inc., Boonton 2, N. J.
- Ⓢ Rubicon Co., 3761 Ridge Ave., Philadelphia 42, Pa.
- Ⓢ SHALLCROSS MFG. CO., 10 Jackson Ave., Collingdale, Pa. ADV. PG. 261.
- Ⓢ Southwestern Industrial Electronics Co., 2831 Post Oak Rd., P. O. Box 13058, Houston 19, Texas.
- Ⓢ SPELLMAN TELEVISION CO., INC., 3029 Webster Ave., New York 67, N. Y. ADV. PG. 277.
- Ⓢ Sticht Co., Inc., Herman H., 27 Park Place, New York 7, N. Y.
- Ⓢ Takk Corp., Newark, Ohio.
- Ⓢ WESTINGHOUSE ELECTRIC CORP., 511 Wood St., P. O. Box 868, Pittsburgh 30, Pa. ADV. PG. 107-113.
- Ⓢ WESTON ELECTRICAL INSTRUMENT CORP., 595 Frelinghuysen Ave., Newark 5, N. J. ADV. PG. 243.
- Ⓢ Winslow Co., Inc., 9 Liberty St., Newark 5, N. J.

TESTERS—Meter

- Ⓢ Booth Co., Arthur B., 4124 Beverly Blvd., Los Angeles 4, Calif.
- Ⓢ Eastern Specialty Co., Philadelphia 40, Pa.
- Ⓢ ELECTRONIC INSTRUMENT CO., INC., 276 Newport St., Brooklyn 12, N. Y. ADV. PG. 129.
- Ⓢ Feiler Engineering Co., 8026 Monticello Ave., Skokie, Ill.
- Ⓢ GENERAL ELECTRIC CO., Schenectady 5, N. Y. ADV. PG. 1 to 22.
- Ⓢ HICKOK ELECTRICAL INSTRUMENT CO., 10514 Dupont Ave., Cleveland 8, Ohio. ADV. PG. 333.

- Ⓢ Instrument Laboratories, 315 W. Walton Place, Chicago 10, Ill.
- Ⓢ Leeds & Northrup Co., 4970 Stenton Ave., Philadelphia 44, Pa.
- Ⓢ McMurdo Silver Co., Inc., 417 Lafayette St., New York, N. Y.
- Ⓢ MARION ELECTRICAL INSTRUMENT CO., Manchester, N. H. ADV. PG. 200.
- Metropolitan Electronics & Instruments Co., 106 Fifth Ave., New York 11, N. Y.
- Ⓢ PRECISE MEASUREMENTS CO., 942 Kings Highway, Brooklyn 23, N. Y. ADV. PG. 401.
- Ⓢ Rubicon Co., 3761 Ridge Ave., Philadelphia 42, Pa.
- Ⓢ Simpson Electric Co., Div. of American Gage & Machine Co., 5218 W. Kinzie St., Chicago 44, Ill.
- Ⓢ States Co., 19 New Park Ave., Hartford 6, Conn.
- Ⓢ WESTON ELECTRICAL INSTRUMENT CORP., 595 Frelinghuysen Ave., Newark 5, N. J. ADV. PG. 243.

TESTERS—Microwave Radar Testing Equipment

- Ⓢ BROWNING LABORATORIES, INC., 750 Main St., Winchester, Mass. ADV. PG. 257.
- Ⓢ Bunnell & Co., J. H., 81 Prospect St., Brooklyn, N. Y.
- Ⓢ Davies Laboratories, Inc., 4705 Queensbury Rd., Riverdale, Md.
- Ⓢ General Communication Co., 530 Commonwealth Ave., Boston 15, Mass.
- Ⓢ Leru Laboratories, Inc., 360 Bleecker St., New York 14, N. Y.
- Ⓢ McMurdo Silver Co., Inc., 417 Lafayette St., New York, N. Y.
- Ⓢ MARCONI INSTRUMENTS, LTD., 23 Beaver St., New York 4, N. Y. ADV. PG. 270.
- Ⓢ Microwave Equipment Co., Inc., North Caldwell, N. J.
- Ⓢ Monarch Radio & Television Corp., 2430 Atlantic Ave., Brooklyn 33, N. Y.
- Ⓢ Network Mfg. Corp., Bayonne, N. J.
- Ⓢ PANORAMIC RADIO PRODUCTS, INC., 10 South Second Ave., Mt. Vernon, N. Y. ADV. PG. 383.
- Ⓢ POLARAD ELECTRONICS CORP., 100 Metropolitan Ave., Brooklyn 11, N. Y. ADV. PG. 184, 185.
- Ⓢ POLYTECHNIC RESEARCH & DEVELOPMENT CO., INC., 202 Tillary St., Brooklyn 1, N. Y. ADV. PG. 172, 173.
- Ⓢ Press Wireless Mfg. Co., Inc., Cantiague Rd., Hicksville, N. Y.
- Ⓢ Simpson Electric Co. Div., American Gage & Machine Co., 5218 W. Kinzie St., Chicago 44, Ill.
- Ⓢ SPERRY GYROSCOPE CO., Div. of Sperry Corp., Great Neck, N. Y. ADV. PG. 103, 104.
- Ⓢ VECTRON, INC., 235 High St., Waltham, Mass. ADV. PG. 214.
- Ⓢ WESTON ELECTRICAL INSTRUMENT CORP., 595 Frelinghuysen Ave., Newark 5, N. J. ADV. PG. 243.
- Ⓢ Wheeler Laboratories, Inc., Great Neck, N. Y.

TESTERS—Moisture Detection

- Ⓢ COMMUNICATION MEASUREMENTS LAB., INC., 120 Greenwich St., New York 6, N. Y. ADV. PG. 290.
- Ⓢ Gordon Co., Claud S., 3000 S. Wallace St., Chicago 16, Ill.
- Ⓢ MARCONI INSTRUMENTS, LTD., 23 Beaver St., New York 4, N. Y. ADV. PG. 270.
- Ⓢ MEASUREMENTS CORP., Boonton, N. J. ADV. PG. 99.
- Ⓢ Peschel Electronics, Inc., 13 Garden St., New Rochelle, N. Y.
- Ⓢ Tagliabue Div., Weston Electrical Instrument Corp., 614 Frelinghuysen Ave., Newark 5, N. J.

TESTERS—Radar Tube

- Ⓢ HICKOK ELECTRICAL INSTRUMENT CO., 10514 Dupont Ave., Cleveland 8, Ohio. ADV. PG. 333.
- Ⓢ Jackson Electrical Instrument Co., 16 S. Patterson Blvd., Dayton 1, Ohio.
- Ⓢ Microwave Equipment Co., Inc., North Caldwell, N. J.
- Ⓢ POLYTECHNIC RESEARCH & DEVELOPMENT CO., INC., 202 Tillary St., Brooklyn 1, N. Y. ADV. PG. 172, 173.
- Ⓢ Simpson Electric Co., Div. of American Gage & Machine Co., 5218 W. Kinzie St., Chicago 44, Ill.
- Ⓢ SPERRY GYROSCOPE CO., Div. of The Sperry Corp., Great Neck, N. Y. ADV. PG. 103, 104.
- Ⓢ Triplett Electrical Instrument Co., Harmon Rd., Bluffton, Ohio.

TESTERS—Transconductance Tube

- Ⓢ ELECTRONIC INSTRUMENT CO., INC., 276 Newport St., Brooklyn 12, N. Y. ADV. PG. 129.
- Ⓢ Electronic Measurements Corp., 280 Lafayette St., New York 12, N. Y.
- Ⓢ HICKOK ELECTRICAL INSTRUMENT CO., 10514 Dupont Ave., Cleveland 8, Ohio. ADV. PG. 333.
- Ⓢ Jackson Electrical Instrument Co., 16 S. Patterson Blvd., Dayton 1, Ohio.
- Ⓢ Kelley-Koett Instrument Co., 962 York St., Cincinnati 14, Ohio.
- Ⓢ McMurdo Silver Co., Inc., 417 Lafayette St., New York, N. Y.
- Ⓢ PENNSYLVANIA TESTING LABORATORY, Doylestown, Pa. ADV. PG. 350.

Ⓢ indicates . . . IN PRODUCTION • AVAILABILITY • UNRESTRICTED FOR GENERAL USE

Precision Apparatus Co., Inc., 92-27 Horace Harding Blvd., Elmhurst, N. Y.
 Ⓢ Sensitive Research Instrument Corp., 9 Elm Ave., Mt. Vernon, N. Y.
 Ⓢ Simpson Electric Co., Div., American Gage & Machine Co., 5218 W. Kinzie St., Chicago 44, Ill.
 Ⓢ Supreme, Inc., Greenwood, Miss.
 Ⓢ SYLVANIA ELECTRIC PRODUCTS, INC., 1740 Broadway, New York 19, N. Y. ADV. PG. 432-436.

THERMISTORS

Ⓢ Friez Instrument Div., Bendix Aviation Corp., Baltimore 4, Md.
 Ⓢ GENERAL RADIO CO., 275 Massachusetts Ave., Cambridge 39, Mass. ADV. PG. 48, 49.
 Ⓢ KEYSTONE CARBON CO., INC., St. Marys, Pa. ADV. PG. 308.
 Ⓢ SERVO CORP. OF AMERICA, 20-20 Jericho Turnpike, New Hyde Park, N. Y. ADV. PG. 150, 151.
 Ⓢ Standard Telephones & Cables Ltd., Connaught House, Aldwych, London, W. C. 2, England.
 Ⓢ STUPAKOFF CERAMIC & MFG. CO., Latrobe, Pa. ADV. PG. 167.

THERMOCOUPLES

Ⓢ AIRTRON, INC., 101 E. Elizabeth Ave., Linden, N. J. ADV. PG. 317.
 Ⓢ American Thermo Electric Co., 67 E. 8th St., New York 3, N. Y.
 Ⓢ BEST PRODUCTS CO., 350 Fifth Ave., New York 1, N. Y. ADV. PG. 412.
 Ⓢ Bristol Co., The, Waterbury 20, Conn.
 Ⓢ Cole Instrument Co., 1320 S. Grand Ave., Los Angeles 15, Calif.
 Ⓢ Coscor (Canada) Ltd., 301-303 Windsor St., Halifax, N. S., Canada.
 Ⓢ Dallons Labs., 5066 Santa Monica Blvd., Los Angeles, Calif.
 Ⓢ Farrand Optical Co., Inc., Bronx Blvd. at 238th St., New York 70, N. Y.
 Ⓢ Field Electrical Instrument Co., 8 N. Manheim Blvd., New Paltz, N. Y.
 Ⓢ Foxboro Co., The, Foxboro, Mass.
 Ⓢ General Controls Co., Glendale 1, Calif.
 Ⓢ GENERAL ELECTRIC CO., Schenectady 5, N. Y. ADV. PG. 1 to 22.
 Ⓢ Gordon Co., Claud S., 3000 S. Wallace St., Chicago 16, Ill.
 Ⓢ Hastings Instrument Co., Inc., Hampton 9, Va.
 Ⓢ Illinois Testing Labs., Inc., 420 N. LaSalle St., Chicago 10, Ill.
 Ⓢ Leeds & Northrup Co., 4970 Stenton Ave., Philadelphia 44, Pa.
 Ⓢ MINNEAPOLIS-HONEYWELL REGULATOR CO., INDUSTRIAL DIV., Wayne & Roberts Aves., Philadelphia 44, Pa. ADV. PG. 208, 209.
 Ⓢ Rawson Electrical Instrument Co., 111 Potter St., Cambridge 42, Mass.
 Ⓢ Reeder & Co., Charles M., 171 Victor Ave., Detroit 3, Mich.
 Ⓢ Richards Co., Inc., Arklay S., 78 Winchester St., Newton Highlands 61, Mass.
 Ⓢ Sensitive Research Instrument Corporation, 9 Elm Ave., Mt. Vernon, N. Y.
 Ⓢ Simpson Electric Co., Div. of American Gage & Machine Co., 5218 W. Kinzie St., Chicago 44, Ill.
 Ⓢ Tagliabue Div., Weston Electrical Instrument Corp., 614 Frelinghuysen Ave., Newark 5, N. J.
 Ⓢ Thwing-Albert Instrument Co., 5351 Pulaski Ave., Philadelphia 44, Pa.
 Ⓢ Uniform Tubes, Shurs Lane & Laruiston St., Roxborough, Philadelphia, Pa.
 Ⓢ Western Gold & Platinum Works, 589 Bryant St., San Francisco, Calif.
 Ⓢ WESTINGHOUSE ELECTRIC CORP., 511 Wood St., P. O. Box 868, Pittsburgh 30, Pa. ADV. PG. 107-113.
 Ⓢ Wheelco Instruments Co., 847 W. Harrison St., Chicago 7, Ill.
 Ⓢ Winslow Co., Inc., 9 Liberty St., Newark 5, N. J.

THERMOCOUPLES—Pyrometric

Ⓢ Bristol Co., The, Waterbury 20, Conn.
 Ⓢ Cole Instrument Co., 1320 S. Grand Ave., Los Angeles 15, Calif.
 Ⓢ Foxboro Co., The, Foxboro, Mass.
 Ⓢ GENERAL ELECTRIC CO., Schenectady 5, N. Y. ADV. PG. 1 to 22.
 Ⓢ Gordon Co., Claud S., 3000 S. Wallace St., Chicago 16, Ill.
 Ⓢ Illinois Testing Labs., Inc., 420 N. LaSalle St., Chicago 10, Ill.
 Ⓢ J B T INSTRUMENTS, INC., 431-B Chapel St., New Haven 8, Conn. ADV. PG. 351.
 Ⓢ Leeds & Northrup Co., 4970 Stenton Ave., Philadelphia 44, Pa.
 Ⓢ Loudon Instruments, Inc., 5644 Lake Park Ave., Chicago 37, Ill.
 Ⓢ Meters, Inc., 915 Westfield Blvd., Indianapolis 20, Ind.
 Ⓢ MINNEAPOLIS-HONEYWELL REGULATOR CO., INDUSTRIAL DIV., Wayne & Roberts Aves., Philadelphia 44, Pa. ADV. PG. 208, 209.
 Ⓢ Richards Co., Inc., Arklay S., 78 Winchester St., Newton Highlands 61, Mass.

Ⓢ Tagliabue Div., Weston Electrical Instrument Corp., 614 Frelinghuysen Ave., Newark 5, N. J.
 Ⓢ Uniform Tubes, Shurs Lane & Laruiston St., Roxborough, Philadelphia 28, Pa.
 Ⓢ Wheelco Instruments Co., 847 W. Harrison St., Chicago 7, Ill.
 Ⓢ Winslow Co., Inc., 9 Liberty St., Newark 5, N. J.

THERMOMETERS—Resistance

Ⓢ Bailey Meter Co., 1044 Ivanhoe Rd., Cleveland 10, Ohio.
 Ⓢ Bristol Co., The, Waterbury 20, Conn.
 Ⓢ Cole Instrument Co., 1320 S. Grand Ave., Los Angeles 15, Calif.
 Ⓢ EDISON, INC., THOMAS A., INSTRUMENT DIV., West Orange, N. J. ADV. PG. 212, 213.
 Ⓢ Foxboro Co., The, Foxboro, Mass.
 Ⓢ GENERAL ELECTRIC CO., Schenectady 5, N. Y. ADV. PG. 1 to 22.
 Ⓢ Gordon Co., Claud S., 3000 S. Wallace St., Chicago 16, Ill.
 Ⓢ Illinois Testing Labs., Inc., 420 N. LaSalle St., Chicago 10, Ill.
 Ⓢ J B T INSTRUMENTS, INC., 431-B Chapel St., New Haven 8, Conn. ADV. PG. 351.
 Ⓢ Leeds & Northrup Co., 4970 Stenton Ave., Philadelphia 44, Pa.
 Ⓢ Loudon Instruments, Inc., 5644 Lake Park Ave., Chicago 37, Ill.
 Ⓢ Macdonald & Co., Inc., W. B., 33 University Rd., Cambridge 38, Mass.
 Ⓢ MINNEAPOLIS-HONEYWELL REGULATOR CO., INDUSTRIAL DIV., Wayne & Roberts Aves., Philadelphia 44, Pa. ADV. PG. 208, 209.
 Ⓢ Ruge-de Forest, Inc., 84 Massachusetts Ave., Cambridge 39, Mass.
 Ⓢ Simpson Electric Co., Div. of American Gage & Machine Co., 5218 W. Kinzie St., Chicago 44, Ill.
 Ⓢ Tagliabue Div., Weston Electrical Instrument Corp., 614 Frelinghuysen Ave., Newark 5, N. J.
 Ⓢ Thwing-Albert Instrument Co., 5351 Pulaski Ave., Philadelphia 44, Pa.
 Ⓢ Trans-Sonic, Inc., Bedford Airport, Bedford, Mass.
 Ⓢ Wheelco Instruments Co., 847 W. Harrison St., Chicago 7, Ill.

THERMOPILES

Ⓢ Biddle Co., James G., 1316 Arch St., Philadelphia 7, Pa.
 Ⓢ Eppley Lab., Inc., The, Newport, R. I.
 Ⓢ Hastings Instrument Co., Inc., Hampton 9, Va.
 Ⓢ Leeds & Northrup Co., 4970 Stenton Ave., Philadelphia 44, Pa.
 Ⓢ MINNEAPOLIS-HONEYWELL REGULATOR CO., INDUSTRIAL DIV., Wayne & Roberts Aves., Philadelphia 44, Pa. ADV. PG. 208, 209.
 Ⓢ National Spectrographic Labs., Inc., 6300 Euclid Ave., Cleveland 3, Ohio.
 Ⓢ Reeder & Co., Charles M., 171 Victor Ave., Detroit 3, Mich.

THERMOSTATS

See also—Controls, Temperature

Ⓢ CURTIS DEVELOPMENT & MFG. CO., 4524 W. Madison St., Chicago 24, Ill. ADV. PG. 407.
 Ⓢ EDISON, INC., THOMAS A., INSTRUMENT DIV., West Orange, N. J. ADV. PG. 212, 213.
 Ⓢ Fenwal, Inc., 43 Pleasant St., Ashland, Mass.
 Ⓢ MERCURIO CORP., 4201 Belmont Ave., Chicago 41, Ill. ADV. PG. 192.
 Ⓢ STEVENS MFG. CO., INC., 69 S. Walnut St., Mansfield, Ohio. ADV. PG. 334.
 Ⓢ Ulanet Co., George, 413 Market St., Newark 5, N. J.

THYRATRONS

See Tubes

TIMERS—Automatic Cycle

Ⓢ Adams & Westlake Co., Michigan St., Elkhart, Ind.
 Ⓢ Airlectron, Inc., P. O. Box 151, Caldwell, N. J.
 Ⓢ ATOMIC INSTRUMENT CO., 84 Massachusetts Ave., Cambridge 39, Mass. ADV. PG. 410.
 Ⓢ Automatic Temperature Control Co., Inc., 5212 Pulaski Ave., Philadelphia 44, Pa.
 Ⓢ Bristol Co., The, Waterbury 20, Conn.
 Ⓢ CRAMER CO., INC., R. W., Box 13, Centerbrook, Conn. ADV. PG. 202.
 Ⓢ Deitz Co., S. J., Box 65, West Englewood, N. J.
 Ⓢ Eagle Signal Corp., Moline, Illinois.
 Ⓢ Electronic Brazing Co., 140 Glenridge Ave., Montclair, N. J.
 Ⓢ Foxboro Co., The, Foxboro, Mass.
 Ⓢ Gale Dorothea Mechanisms, 37-61 85th St., Jackson Heights, N. Y.
 Ⓢ GENERAL ELECTRIC CO., Schenectady 5, N. Y. ADV. PG. 1 to 22.
 Ⓢ Gorrell & Gorrell, Haworth, N. J.
 Ⓢ HAYDON CO., A. W., THE, 232 N. Elm St., Waterbury, Conn. ADV. PG. 402.
 Ⓢ HAYDON MFG. CO., INC., 584 E. Elm St., Torrington, Conn. ADV. PG. 216, 217.

Ⓢ Industrial Electronics Co., Inc., Hanover, Mass.
 Ⓢ Ingraham Co., E., Bristol, Conn.
 Ⓢ Ionic Electronic Equipment Co., 1705 N. Kenmore, Los Angeles 27, Calif.
 Ⓢ KURMAN ELECTRIC CO., INC., 35-18 37th St., Long Island City, N. Y. ADV. PG. 196.
 Ⓢ Lektra Laboratories, 154 11th Ave., New York, N. Y.
 Ⓢ Lumenite Electric Co., 407 S. Dearborn St., Chicago 5, Ill.
 Ⓢ Mallory & Co., Inc., P. R., 3029 E. Washington St., Indianapolis 6, Ind.
 Ⓢ Minnesota Electronics Corp., 47 W. Water St., St. Paul 1, Minn.
 Ⓢ Montgomery Mfg. Co., 204 S. Main St., Owensville, Ind.
 Ⓢ Paragon Electric Co., Two Rivers, Wis.
 Ⓢ Photoswitch, Inc., 77 Broadway, Cambridge 42, Mass.
 Ⓢ POTTED INSTRUMENT CO., INC., 115 Cutter Mill Rd., Great Neck, N. Y. ADV. PG. 318.
 Ⓢ Robotron Corp., 5570 W. Chicago Blvd., Detroit 4, Mich.
 Ⓢ Struthers-Dunn, Inc., 150 N. 13th St., Philadelphia 7, Pa.
 Ⓢ Tagliabue Div., Weston Electrical Instrument Corp., 614 Frelinghuysen Ave., Newark 5, N. J.
 Ⓢ Tork Clock Co., Inc., 1 Grove St., Mt. Vernon, N. Y.
 Ⓢ Wilson & Co., G. C., 2 N. Passaic Ave., Chatham, N. J.
 Ⓢ Zenith Electric Co., 152 W. Walton St., Chicago 10, Ill.

TIMERS—Automatic Interval

Ⓢ Adams & Westlake Co., Michigan St., Elkhart, Ind.
 Ⓢ Airbourne Electronics Co., Metropolitan Airport, Hangar No. 3, Van Nuys, Calif.
 Ⓢ AMERICAN CHRONOSCOPE CORP., 316 W. First St., Mt. Vernon, N. Y. ADV. PG. 316.
 Ⓢ ATOMIC INSTRUMENT CO., 84 Massachusetts Ave., Cambridge 39, Mass. ADV. PG. 410.
 Ⓢ Automatic Temperature Control Co., Inc., 5212 Pulaski Ave., Philadelphia 44, Pa.
 Ⓢ Berkeley Scientific Corp., 2200 Wright Ave., Richmond, Calif.
 Ⓢ Bristol Co., The, Waterbury 20, Conn.
 Ⓢ CRAMER CO., INC., R. W., Box 13, Centerbrook, Conn. ADV. PG. 202.
 Ⓢ Deitz Co., S. J., Box 65, West Englewood, N. J.
 Ⓢ Dimco-Gray Co., 207 E. Sixth St., Dayton, Ohio.
 Ⓢ Eagle Signal Corp., Moline, Ill.
 Ⓢ Gale Dorothea Mechanisms, 37-61 85th St., Jackson Heights, N. Y.
 Ⓢ GENERAL ELECTRIC CO., Schenectady 5, N. Y. ADV. PG. 1 to 22.
 Ⓢ General Electric X-Ray Corp., 4855 Electric Ave., Milwaukee, Wis.
 Ⓢ Gorrell & Gorrell, Haworth, N. J.
 Ⓢ HAYDON CO., A. W., THE, 232 N. Elm St., Waterbury, Conn. ADV. PG. 402.
 Ⓢ HAYDON MFG. CO., INC., 584 E. Elm St., Torrington, Conn. ADV. PG. 216, 217.
 Ⓢ Industrial Electronics Co., Inc., Hanover, Mass.
 Ⓢ Industrial Timer Corp., 115 Edison Pl., Newark 5, N. J.
 Ⓢ Ingraham Co., E., Bristol, Conn.
 Ⓢ Ionic Electronic Equipment Co., 1705 N. Kenmore, Los Angeles 27, Calif.
 Ⓢ Lektra Laboratories, 154 11th Ave., New York, N. Y.
 Ⓢ Liebel-Flarsheim Co., 303 W. Third St., Cincinnati 2, Ohio.
 Ⓢ Lumenite Electric Co., 407 S. Dearborn St., Chicago 5, Ill.
 Ⓢ Mallory & Co., Inc., P. R., 3029 E. Washington St., Indianapolis 6, Ind.
 Ⓢ Minnesota Electronics Corp., 47 W. Water St., St. Paul 1, Minn.
 Ⓢ Nuclear Instrument & Chemical Corp., 223 W. Erie St., Chicago 10, Ill.
 Ⓢ Paragon Electric Co., Two Rivers, Wis.
 Ⓢ Photoswitch, Inc., 77 Broadway, Cambridge 42, Mass.
 Ⓢ POTTER INSTRUMENT CO., INC., 115 Cutter Mill Rd., Great Neck, N. Y. ADV. PG. 410.
 Ⓢ Reliance Automatic Lighting Co., 1919 Mead St., Racine, Wis.
 Ⓢ Robotron Corp., 5570 W. Chicago Blvd., Detroit 4, Mich.
 Ⓢ SESSIONS CLOCK CO., TIMER DIV., Forestville, Conn. ADV. PG. 123.
 Ⓢ STANDARD ELECTRIC TIME CO., 89 Logan St., Springfield, Mass. ADV. PG. 40.
 Ⓢ Struthers-Dunn, Inc., 150 N. 13th St., Philadelphia 7, Pa.
 Ⓢ TELECHRON INC., Homer Ave., Ashland, Mass. ADV. PG. 24.
 Ⓢ Tork Clock Co., Inc., 1 Grove St., Mt. Vernon, N. Y.
 Ⓢ Tracerlab, Inc., 130 High St., Boston 10, Mass.
 Ⓢ WESTINGHOUSE ELECTRIC CORP., 511 Wood St., P. O. Box 868, Pittsburgh 30, Pa. ADV. PG. 107-113.
 Ⓢ Wilson & Co., G. C., 2 N. Passaic Ave., Chatham, N. J.
 Ⓢ Zenith Electric Co., 152 W. Walton St., Chicago 10, Ill.

TIMERS—Automatic Reset

Ⓢ AMERICAN GAS ACCUMULATOR CO., 1029 Newark Ave., Elizabeth 3, N. J. ADV. PG. 76.
 Ⓢ ATOMIC INSTRUMENT CO., 84 Massachusetts Ave., Cambridge 39, Mass. ADV. PG. 410.

V indicates . . . IN PRODUCTION • AVAILABILITY • UNRESTRICTED FOR GENERAL USE

- Ⓞ Automatic Temperature Control Co., Inc., 5212 Pulaski Ave., Philadelphia 44, Pa.
- Ⓞ Bristol Co., The, Waterbury 20, Conn.
- Ⓞ CRAMER CO., INC., R. W., Box 13, Centerbrook, Conn. ADV. PG. 202.
- Ⓞ Eagle Signal Corp., Moline, Illinois.
- Ⓞ Farmer Electric Co., 21 Mossfield Rd., Waban 68, Mass.
- Ⓞ Gale Dorothea Mechanisms, 37-61 85th St., Jackson Heights, N. Y.
- Ⓞ GENERAL ELECTRIC CO., Schenectady 5, N. Y. ADV. PG. 1 to 22.
- Ⓞ General Photo Products Co., 15 Summit Ave., Chatham, N. J.
- Ⓞ HAYDON CO., A. W., THE, 232 N. Elm St., Waterbury, Conn. ADV. PG. 402.
- Ⓞ HAYDON MFG. CO., INC., 584 E. Elm St., Torrington, Conn. ADV. PG. 216, 217.
- Ⓞ Industrial Electronics Co., Inc., Hanover, Mass.
- Ⓞ Industrial Timer Corp., 115 Edison Pl., Newark 5, N. J.
- Ⓞ Ionic Electronic Equipment Co., 1705 N. Kenmore, Los Angeles 27, Calif.
- Ⓞ Liebel-Flarsheim Co., 303 W. Third St., Cincinnati 2, Ohio.
- Ⓞ Lumenite Electric Co., 407 S. Dearborn St., Chicago 5, Ill.
- Ⓞ Minnesota Electronics Corp., 47 W. Water St., St. Paul 1, Minn.
- Ⓞ Paragon Electric Co., Two Rivers, Wisconsin.
- Ⓞ Photoswitch, Inc., 77 Broadway, Cambridge 42, Mass.
- Ⓞ POTTER INSTRUMENT CO., INC., 115 Cutter Mill Rd., Great Neck, N. Y. ADV. PG. 318.
- Ⓞ QUAKER CITY GEAR WORKS, 1908-32 N. Front St., Philadelphia 22, Pa. ADV. PG. 166.
- Ⓞ Robotron Corp., 5570 W. Chicago Blvd., Detroit 4, Mich.
- Ⓞ Sherman Industrial Electronics Co., Inc., 505 Washington Ave., Belleville 9, N. J.
- Ⓞ Special Instruments Laboratories, Inc., 1003 Highland Ave., Knoxville, Tenn.
- Ⓞ Struthers-Dunn, Inc., 150 N. 13th St., Philadelphia 7, Pa.
- Ⓞ Tagliabue Div., Weston Electrical Instrument Corp., 614 Frelinghysen Ave., Newark 5, N. J.
- Ⓞ WARD LEONARD ELECTRIC CO., 31 South St., Mt. Vernon, N. Y. ADV. PG. 69, 70.
- Ⓞ WESTINGHOUSE ELECTRIC CORP., 511 Wood St., P. O. Box 868, Pittsburgh 30, Pa. ADV. PG. 107-113.
- Ⓞ Wilson & Co., G. C., 2 N. Passaic Ave., Chatham, N. J.
- Ⓞ Zenith Electric Co., 152 W. Walton St., Chicago 10, Ill.

TIMERS—Hour Counting

- Ⓞ ATOMIC INSTRUMENT CO., 84 Massachusetts Ave., Cambridge 39, Mass. ADV. PG. 410.
- Ⓞ CRAMER CO., INC., R. W., Box 13, Centerbrook, Conn. ADV. PG. 202.
- Ⓞ Gale Dorothea Mechanisms, 37-61 85th St., Jackson Heights, N. Y.
- Ⓞ General Controls Co., Glendale 1, Calif.
- Ⓞ GENERAL ELECTRIC CO., Schenectady 5, N. Y. ADV. PG. 1 to 22.
- Ⓞ Gorrell & Gorrell, Haworth, N. J.
- Ⓞ HAYDON CO., A. W., THE, 232 N. Elm St., Waterbury, Conn. ADV. PG. 402.
- Ⓞ HAYDON MFG. CO., INC., 584 E. Elm St., Torrington, Conn. ADV. PG. 216, 217.
- Ⓞ Industrial Timer Corp., 115 Edison Pl., Newark 5, N. J.
- Ⓞ MARION ELECTRICAL INSTRUMENT CO., Manchester, N. H. ADV. PG. 200.
- Ⓞ Rhodes, Inc., M. H., 30 Bartholomew Ave., Hartford, Conn.
- Ⓞ WESTINGHOUSE ELECTRIC CORP., 511 Wood St., P. O. Box 868, Pittsburgh 30, Pa. ADV. PG. 107-113.
- Ⓞ Zenith Electric Co., 152 W. Walton St., Chicago 10, Ill.

TIMERS—Impulse

- Ⓞ ATOMIC INSTRUMENT CO., 84 Massachusetts Ave., Cambridge 39, Mass. ADV. PG. 410.
- Ⓞ Automatic Temperature Control Co., Inc., 5212 Pulaski Ave., Philadelphia 44, Pa.
- Ⓞ Bristol Co., The, Waterbury 20, Conn.
- Ⓞ CRAMER CO., INC., R. W., Box 13, Centerbrook, Conn. ADV. PG. 202.
- Ⓞ Deitz Co., S. J., Box 65, West Englewood, N. J.
- Ⓞ Eagle Signal Corp., Moline, Illinois.
- Ⓞ Gale Dorothea Mechanisms, 37-61 85th St., Jackson Heights, N. Y.
- Ⓞ General Electric X-Ray Corp., 4855 Electric Ave., Milwaukee, Wis.
- Ⓞ Gorrell & Gorrell, Haworth, N. J.
- Ⓞ HAYDON CO., A. W., THE, 232 N. Elm St., Waterbury, Conn. ADV. PG. 402.
- Ⓞ Industrial Electronics Co., Inc., Hanover, Mass.
- Ⓞ Industrial Timer Corp., 115 Edison Pl., Newark 5, N. J.
- Ⓞ Ionic Electronic Equipment Co., 1705 N. Kenmore, Los Angeles 27, Calif.
- Ⓞ Lumenite Electric Co., 407 S. Dearborn St., Chicago 5, Ill.
- Ⓞ Minnesota Electronics Corp., 47 W. Water St., St. Paul 1, Minn.

- Ⓞ Photoswitch, Inc., 77 Broadway, Cambridge 42, Mass.
- Ⓞ POTTER INSTRUMENT CO., INC., 115 Cutter Mill Rd., Great Neck, N. Y. ADV. PG. 318.
- Ⓞ Struthers-Dunn, Inc., 150 N. 13th St., Philadelphia 7, Pa.
- Ⓞ Zenith Electric Co., 152 W. Walton St., Chicago 10, Ill.

TIMERS—Inertia

- Ⓞ Struthers-Dunn, Inc., 150 N. 13th St., Philadelphia 7, Pa.

TIMERS—Motor Operated

- Ⓞ Allen-Bradley Co., 136 W. Greenfield Ave., Milwaukee 4, Wis.
- Ⓞ Amglo Corp., 4234 Lincoln Ave., Chicago 18, Ill.
- Ⓞ ATOMIC INSTRUMENT CO., 84 Massachusetts Ave., Cambridge 39, Mass. ADV. PG. 410.
- Ⓞ Automatic Temperature Control Co., Inc., 5212 Pulaski Ave., Philadelphia 44, Pa.
- Ⓞ Bristol Co., The, Waterbury 20, Conn.
- Ⓞ CRAMER CO., INC., R. W., Box 13, Centerbrook, Conn. ADV. PG. 202.
- Ⓞ Eagle Signal Corp., Moline, Illinois.
- Ⓞ Edwards Co., Inc., 86 Boston Post Rd., Norwalk, Conn.
- Ⓞ Electyrmotor Products Corp., 565 W. Washington Blvd., Chicago 6, Ill.
- Ⓞ Gale Dorothea Mechanisms, 37-61 85th St., Jackson Heights, N. Y.
- Ⓞ GENERAL ELECTRIC CO., Schenectady 5, N. Y. ADV. PG. 1 to 22.
- Ⓞ Gorrell & Gorrell, Haworth, N. J.
- Ⓞ Hagen Mfg. Co., Inc., Baraboo, Wis.
- Ⓞ HAYDON CO., A. W., THE, 232 N. Elm St., Waterbury, Conn. ADV. PG. 402.
- Ⓞ HAYDON MFG. CO., INC., 584 E. Elm St., Torrington, Conn. ADV. PG. 216, 217.
- Ⓞ Ingraham Co., E., Bristol, Conn.
- Ⓞ Industrial Timer Corp., 115 Edison Pl., Newark 5, N. J.
- Ⓞ Kelley-Koett Instrument Co., 962 York St., Cincinnati 14, Ohio.
- Ⓞ KURMAN ELECTRIC CO., INC., 35-18 37th St., Long Island City, N. Y. ADV. PG. 196.
- Ⓞ Lektra Laboratories, 154 11th Ave., New York, N. Y.
- Ⓞ Liebel-Flarsheim Co., 303 W. Third St., Cincinnati 2, Ohio.
- Ⓞ Lumenite Electric Co., 407 S. Dearborn St., Chicago 5, Ill.
- Ⓞ Mallory & Co., Inc., P. R., 3029 E. Washington St., Indianapolis 6, Ind.
- Ⓞ Montgomery Mfg. Co., 204 S. Main St., Owensville, Ind.
- Ⓞ Nucleonic Corp. of America, 497 Union St., Brookline 31, N. Y.
- Ⓞ Paragon Electric Co., Two Rivers, Wisconsin.
- Ⓞ SESSIONS CLOCK CO., TIMER DIV., Forestville, Conn. ADV. PG. 123.
- Ⓞ Sherman Industrial Electronics Co., Inc., 505 Washington Ave., Belleville 9, N. J.
- Ⓞ Special Instruments Laboratories, Inc., 1003 Highland Ave., Knoxville, Tenn.
- Ⓞ STANDARD ELECTRIC TIME CO., THE, 89 Logan St., Springfield, Mass. ADV. PG. 40.
- Ⓞ Struthers-Dunn, Inc., 150 N. 13th St., Philadelphia 7, Pa.
- Ⓞ Technical Associates, 3730 San Fernando Rd., Glendale 4, Calif.
- Ⓞ Tork Clock Co., Inc., 1 Grove St., Mt. Vernon, N. Y.
- Ⓞ WARD LEONARD ELECTRIC CO., 31 South St., Mt. Vernon, N. Y. ADV. PG. 69, 70.
- Ⓞ Western Gold & Platinum Works, 589 Bryant St., San Francisco, Calif.
- Ⓞ WESTINGHOUSE ELECTRIC CORP., 511 Wood St., P. O. Box 868, Pittsburgh 30, Pa. ADV. PG. 107-113.
- Ⓞ Zenith Electric Co., 152 W. Walton St., Chicago 10, Ill.

TIMERS—Multicontact

- Ⓞ Automatic Temperature Control Co., Inc., 5212 Pulaski Ave., Philadelphia 44, Pa.
- Ⓞ CRAMER CO., INC., R. W., Box 13, Centerbrook, Conn. ADV. PG. 202.
- Ⓞ Eagle Signal Corp., Moline, Illinois.
- Ⓞ Gale Dorothea Mechanisms, 37-61 85th St., Jackson Heights, N. Y.
- Ⓞ Gorrell & Gorrell, Haworth, N. J.
- Ⓞ HAYDON CO., A. W., THE, 232 N. Elm St., Waterbury, Conn. ADV. PG. 402.
- Ⓞ HAYDON MFG. CO., INC., 584 E. Elm St., Torrington, Conn. ADV. PG. 216, 217.
- Ⓞ Industrial Timer Corp., 115 Edison Pl., Newark 5, N. J.
- Ⓞ Ionic Electronic Equipment Co., 1705 N. Kenmore, Los Angeles 27, Calif.
- Ⓞ Lumenite Electric Co., 407 S. Dearborn St., Chicago 5, Ill.
- Ⓞ Paragon Electric Co., Two Rivers, Wis.
- Ⓞ Sherman Industrial Electronics Co., Inc., 505 Washington Ave., Belleville 9, N. J.

- Ⓞ Struthers-Dunn, Inc., 150 N. 13th St., Philadelphia 7, Pa.
- Ⓞ WESTINGHOUSE ELECTRIC CORP., 511 Wood St., P. O. Box 868, Pittsburgh 30, Pa. ADV. PG. 107-113.
- Ⓞ Zenith Electric Co., 152 W. Walton St., Chicago 10, Ill.

TIMERS—Percentage

- Ⓞ Automatic Temperature Control Co., Inc., 5212 Pulaski Ave., Philadelphia 44, Pa.
- Ⓞ CRAMER CO., INC., R. W., Box 13, Centerbrook, Conn. ADV. PG. 202.
- Ⓞ Eagle Signal Corp., Moline, Ill.
- Ⓞ Gale Dorothea Mechanisms, 37-61 85th St., Jackson Heights, N. Y.
- Ⓞ HAYDON CO., A. W., THE, 232 N. Elm St., Waterbury, Conn. ADV. PG. 402.
- Ⓞ Lumenite Electric Co., 407 S. Dearborn St., Chicago 5, Ill.
- Ⓞ Tuttle & Kift, 1823 N. Monitor St., Chicago 39, Ill.
- Ⓞ Wilson & Co., G. C., 2 N. Passaic Ave., Chatham, N. J.
- Ⓞ Zenith Electric Co., 152 W. Walton St., Chicago 10, Ill.

TIMERS—Photoelectric

- Ⓞ AMERICAN CHRONOSCOPE CORP., 316 W. First St., Mt. Vernon, N. Y. ADV. PG. 316.
- Ⓞ Autotron Co., The, Danville, Ill.
- Ⓞ Berkeley Scientific Corp., 2200 Wright Ave., Richmond, Calif.
- Ⓞ Deitz Co., S. J., Box 65, West Englewood, N. J.
- Ⓞ De-Tec-Tronic Laboratories, Inc., 1711 Terra Cotta Pl., Chicago 14, Ill.
- Ⓞ GENERAL ELECTRIC CO., Schenectady 5, N. Y. ADV. PG. 1 to 22.
- Ⓞ Hart Associates, 8430 Grand River, Detroit 4, Mich.
- Ⓞ Industrial Electronics Co., Inc., Hanover, Mass.
- Ⓞ Ionic Electronic Equipment Co., 1705 N. Kenmore, Los Angeles 27, Calif.
- Ⓞ Lektra Laboratories, 154 11th Ave., New York, N. Y.
- Ⓞ Lumenite Electric Co., 407 S. Dearborn St., Chicago, Ill.
- Ⓞ Photoswitch, Inc., 77 Broadway, Cambridge 42, Mass.
- Ⓞ Photovolt Corp., 95 Madison Ave., New York 16, N. Y.
- Ⓞ POTTER INSTRUMENT CO., INC., 115 Cutter Mill Rd., Great Neck, N. Y. ADV. PG. 318.
- Ⓞ Ripley Co., Inc., Middletown, Conn.
- Ⓞ Welch Scientific Co., W. M., 1515 Sedgwick St., Chicago 10, Ill.
- Ⓞ WESTINGHOUSE ELECTRIC CORP., 511 Wood St., P. O. Box 868, Pittsburgh 30, Pa. ADV. PG. 107-113.

TIMERS—Sequence

- Ⓞ Adams & Westlake Co., Michigan St., Elkhart, Ind.
- Ⓞ Arlington Electric Products, Inc., 500 W. 52nd St., New York 19, N. Y.
- Ⓞ ATOMIC INSTRUMENT CO., 84 Massachusetts Ave., Cambridge 39, Mass. ADV. PG. 410.
- Ⓞ Automatic Temperature Control Co., Inc., 5212 Pulaski Ave., Philadelphia 44, Pa.
- Ⓞ Bristol Co., The, Waterbury 20, Conn.
- Ⓞ CRAMER CO., INC., R. W., Box 13, Centerbrook, Conn. ADV. PG. 202.
- Ⓞ Eagle Signal Corp., Moline, Illinois.
- Ⓞ Esterline-Angus Co., Inc., P. O. Box 596, Indianapolis, Ind.
- Ⓞ Farmer Electric Co., 21 Mossfield Rd., Waban 68, Mass.
- Ⓞ Gale Dorothea Mechanisms, 37-61 85th St., Jackson Heights, N. Y.
- Ⓞ GENERAL ELECTRIC CO., Schenectady 5, N. Y. ADV. PG. 1 to 22.
- Ⓞ HAYDON CO., A. W., THE, 232 N. Elm St., Waterbury, Conn. ADV. PG. 402.
- Ⓞ HAYDON MFG. CO., INC., 584 E. Elm St., Torrington, Conn. ADV. PG. 216, 217.
- Ⓞ Industrial Electronics Co., Hanover, Mass.
- Ⓞ Industrial Timer Corp., 115 Edison Pl., Newark 5, N. J.
- Ⓞ Lumenite Electric Co., 407 S. Dearborn St., Chicago 5, Ill.
- Ⓞ Paragon Electric Co., Two Rivers, Wisconsin.
- Ⓞ Photoswitch, Inc., 77 Broadway, Cambridge 42, Mass.
- Ⓞ POTTER INSTRUMENT CO., INC., 115 Cutter Mill Rd., Great Neck, N. Y. ADV. PG. 318.
- Ⓞ Struthers-Dunn, Inc., 150 N. 13th St., Philadelphia 7, Pa.
- Ⓞ Tork Clock Co., Inc., 1 Grove St., Mt. Vernon, N. Y.
- Ⓞ Weltron Co., 19500 West Eight Mile Rd., Detroit 19, Mich.
- Ⓞ WESTINGHOUSE ELECTRIC CORP., 511 Wood St., P. O. Box 868, Pittsburgh 30, Pa. ADV. PG. 107-113.
- Ⓞ Wilson & Co., G. C., 2 N. Passaic Ave., Chatham, N. J.
- Ⓞ Zenith Electric Co., 152 W. Walton St., Chicago 10, Ill.

TIMERS—Thermal

- Ⓞ Cutler-Hammer, Inc., 411 N. 12th St., Milwaukee 1, Wis.
- Ⓞ G-V Controls, Inc., 28 Hollywood Plaza, East Orange, N. J.

V indicates . . . IN PRODUCTION • AVAILABILITY • UNRESTRICTED FOR GENERAL USE

- Ionic Electronic Equipment Co., 1705 N. Kenmore, Los Angeles 27, Calif.
- Struthers-Dunn, Inc., 150 N. 13th St., Philadelphia 7, Pa.
- Ulanet Co., George, 413 Market St., Newark 5, N. J.
- WARD LEONARD ELECTRIC CO., 31 South St., Mt. Vernon, N. Y. ADV. PG. 69, 70.
- WESTINGHOUSE ELECTRIC CORP., 511 Wood St., P. O. Box 868, Pittsburgh 30, Pa. ADV. PG. 107-113.

TIMERS—Welding

- Automatic Temperature Control Co., Inc., 5212 Pulaski Ave., Philadelphia 44, Pa.
- Clark Controller Co., 1146 E. 152nd St., Cleveland 10, Ohio.
- Farmer Electric Co., 21 Mossfield Rd., Waban 68, Mass.
- Federal Tool Engineering Co., 532 Mulberry St., Newark 5, N. J.
- GENERAL ELECTRIC CO., Schenectady 5, N. Y. ADV. PG. 1 to 22.
- Industrial Electronics Co., Inc., Hanover, Mass.
- Industrial Timer Corp., 115 Edison Pl., Newark 5, N. J.
- Photoswitch, Inc., 77 Broadway, Cambridge 42, Mass.
- Ripley Co., Inc., Middletown, Conn.
- Robotron Corp., 5570 W. Chicago Blvd., Detroit 4, Mich.
- Weltron Co., 19500 West Eight Mile Road, Detroit 19, Mich.
- WESTINGHOUSE ELECTRIC CORP., 511 Wood St., P. O. Box 868, Pittsburgh 30, Pa. ADV. PG. 107-113.

TITRATION APPARATUS

- Beckman Instruments, Inc., 820 Mission St., South Pasadena, Calif.
- Central Scientific Co., 1700 Irving Park Rd., Chicago 13, Ill.
- Fischer Scientific Co., 717 Forbes St., Pittsburgh 19, Pa.
- Leeds & Northrup Co., 4970 Stenton Ave., Philadelphia 44, Pa.

TOOLS—Acetylene Soldering

- Linde Air Products Co., Division of Union Carbide & Carbon Corp., 30 E. 42nd St., New York 17, N. Y.
- Torit Mfg. Co., Walnut & Exchange Sts., St. Paul 2, Minn.

TOOLS—Resistance Soldering

- Acme Electric Heating Co., 1217 Washnigton St., Boston, Mass.
- Cole Radio Works, 86 Westville Ave., Caldwell, N. J.
- EISLER ENGINEERING CO., INC., 740 S. 13th St., Newark 3, N. J. ADV. PG. 378.
- Luma Electric Equipment Co., P.O. Box 132, Toledo 1, Ohio.
- Ungar Electric Tool, Inc., 615 Ducommon St., Los Angeles 54, Calif.

TRACERS—Manual, for Oscilloscopes

- Waters, Inc., Robert A., 4 Gordon St., Waltham 54, Mass.

TRACERS—Signal

- ELECTRONIC INSTRUMENT CO., INC., 276 Newport St., Brooklyn 12, N. Y. ADV. PG. 129.
- Feiler Engineering Co., 8026 Monticello Ave., Skokie, Ill.
- McMurdo Silver Co., Inc., 417 Lafayette St., New York, N. Y.
- MEASUREMENTS CORPORATION, Boonton, N. J. ADV. PG. 99.
- Radio City Products Co., Inc., 152 W. 25th St., New York 1, N. Y.
- RADIO CORP. OF AMERICA, Tube Dept., Harrison, N. J. ADV. PG. 177, Inside Back & Back Covers.
- Special Products Co., Silver Spring, Maryland.

TRANSCEIVERS—Aviation

- Avion Instrument Corp., Paramus, N. J.
- Bassett, Inc., Rex, 307-311 N.W. First Ave., Fort Lauderdale, Fla.
- Collins Radio Co., Cedar Rapids, Iowa.
- Cossor (Canada) Ltd., 301-303 Windsor St., Halifax, N. S., Canada.
- Lear, Inc., 110 Ionia Ave., NW., Grand Rapids 2, Mich.
- McMurdo Silver Co., Inc., 417 Lafayette St., New York, N. Y.
- MITCHELL INDUSTRIES, INC., Camp Wolters, Mineral Wells, Texas. ADV. PG. 298.

TRANSCEIVERS—Lifeboat

- BARKER & WILLIAMSON, 235 Fairfield Ave., Upper Darby, Pa. ADV. PG. 292.
- Bassett, Inc., Rex, 307-311 N.W. First Ave., Fort Lauderdale, Fla.
- Radiomarine Corp. of America, 75 Varick St., New York 13, N. Y.

TRANSCEIVERS—Portable

- AIR ASSOCIATES, INC., Teterboro, N. J. ADV. PG. 211.
- BARKER & WILLIAMSON, 235 Fairfield Ave., Upper Darby, Pa. ADV. PG. 292.
- Bassett, Inc., Rex, 307-311 N.W. First Ave., Fort Lauderdale, Fla.
- Bendix Radio Division, Bendix Aviation Corp., Baltimore 4, Md.
- McMurdo Silver Co., Inc., 417 Lafayette St., New York, N. Y.
- Motorola, Inc., 4545 Augusta Blvd., Chicago 51, Ill.
- Plastics & Electronics Co., Inc., P.O. Box 38, Station J, Buffalo 8, N. Y.
- Press Wireless Mfg. Co., Inc., Cantiague Rd., Hicksville, N.Y.
- Radio Specialty Mfg. Co., 2023 S. E. Sixth Ave., Portland 14, Ore.
- Radio Transceiver Laboratories, 116-23 Jamaica Ave., Richmond Hill 18, N. Y.
- Stephens Mfg. Corp., 8538 Warner Drive, Culver City, Calif.

TRANSCEIVERS—uhf

- AIR ASSOCIATES, INC., Teterboro, N. J. ADV. PG. 211.
- BARKER & WILLIAMSON, 235 Fairfield Ave., Upper Darby, Pa. ADV. PG. 292.
- McMurdo Silver Co., Inc., 417 Lafayette St., New York, N. Y.
- Press Wireless Mfg. Co., Inc., Cantiague Rd., Hicksville, N. Y.
- SPERRY GYROSCOPE CO., Div. of The Sperry Corp., Great Neck, N. Y. ADV. PG. 103, 104.
- Stephens Mfg. Corp., 8538 Warner Drive, Culver City, Calif.

TRANSCEIVERS—vhf

- AIR ASSOCIATES, INC., Teterboro, N. J. ADV. PG. 211.
- AMERICAN ELECTROENGINEERING CORP., 5025-29 W. Jefferson Blvd., Los Angeles 16, Calif. ADV. PG. 136.
- BARKER & WILLIAMSON, 235 Fairfield Ave., Upper Darby, Pa. ADV. PG. 292.
- Bassett, Inc., Rex, 307-311 N.W. First Ave., Fort Lauderdale, Fla.
- Bendix Radio Division, Bendix Aviation Corp., Baltimore 4, Md.
- Communications Co., Inc., 300 Greco Ave., Coral Gables 34, Fla.
- Cossor (Canada) Ltd., 301-303 Windsor St., Halifax, N.S. Canada.
- Lear, Inc., 110 Ionia Ave., N.W., Grand Rapids 2, Mich.
- McMurdo Silver Co., Inc., 417 Lafayette St., New York, N. Y.
- Motorola, Inc., 4545 Augusta Blvd., Chicago 51, Ill.
- Press Wireless Mfg. Co., Inc., Cantiague Rd., Hicksville, N. Y.
- Radiomarine Corp. of America, 75 Varick St., New York 13, N. Y.
- Telephonics Corp., Park Ave., Huntington, N. Y.

TRANSUCERS

- Automatic Temperature Control Co., Inc., 5212 Pulaski Ave., Philadelphia 44, Pa.
- Bludworth Marine Div., National-Simplex-Bludworth, Inc., 92 Gold St., New York 38, N. Y.
- BRUSH DEVELOPMENT CO., 3405 Perkins Ave., Cleveland 14, Ohio. ADV. PG. 228, 229.
- Control Engineering Corp., 863 Washington St., Canton, Mass.
- Dallons Labs., 5066 Santa Monica Blvd., Los Angeles, Calif.
- ELECTRONIC ENGINEERING ASSOCIATES, LTD., 1048 Brittan Ave., San Carlos, Calif. ADV. PG. 393.
- Kelley-Koett Instrument Co., 962 York St., Cincinnati 14, Ohio.
- Midwestern Geophysical Laboratory, 3400 S. Harvard, Tulsa, Okla.
- Pfanstiel Chemical Co., Metallurgical Div., 104 Lake View Ave., Waukegan, Ill.
- PICKERING & CO., 309 Woods Ave., Oceanside, N. Y. ADV. PG. 284.
- POLYTECHNIC RESEARCH & DEVELOPMENT CO., INC., 202 Tillary St., Brooklyn 1, N. Y. ADV. PG. 172, 173.
- RAHM INSTRUMENTS, INC., 12 West Broadway, New York 7, N. Y. ADV. PG. 354.
- RAYTHEON MFG. CO., Equipment Sales Div., Waltham 54, Mass. ADV. PG. 80, 81.

- Rich-Roth Labs., East Hartford, Conn.
- ROANWELL CORP., 662 Pacific St., Brooklyn 17, N. Y. ADV. PG. 403.
- SANBORN CO., 39 Osborn St., Cambridge 39, Mass. ADV. PG. 391.
- SERVOMECHANISMS, INC., Whaleneck Rd. & Stewart Ave., Westbury, L. I., N. Y. ADV. PG. 188.
- Southwestern Industrial Electronics Co., 2831 Post Oak Rd., P.O. Box 13058, Houston 19, Texas.
- Sperry Products, Inc., Danbury, Conn.
- Valpey Crystals, Highland St., Holliston 11, Mass.
- Westline Electronics Co., 11656 Olympic Blvd., Los Angeles 25, Calif.

TRANSFORMERS

- Audio**
- 1. Input, Output or Interstage
- 2. Modulator
- Power**
- 3. Current Limiting
- 4. Isolation
- 5. Plate, Filament or Bias-Under 500 Watts
- 6. Plate, Filament or Bias-Over 500 Watts
- 7. Saturable
- 8. Variable
- 9. Vibrator
- 10. Voltage Regulating
- 11. Welding
- 12. X-Ray

NOTE: (h) includes hermetically sealed types.

- ACME ELECTRIC CORP., 31 Water St., Cuba, N. Y. 1-3-4-5-6-7-8-9-10-11. ADV. PG. 90. (h)
- ACME ELECTRONICS, INC., 300 N. Lake Ave., Pasadena 4, Calif. 7-10. ADV. PG. 182. (h)
- Acro Products Co., 215 Arch St., Philadelphia 6, Pa. 1-2-4-5-7. (h)
- Acro Transformer Mfg. Corp., 26-02 4th St., Astoria 2, N. Y. 1. (h)
- Arco Transformer & Electric Corp., 1602 S. Hanna St., Fort Wayne, Ind. 1-2-4-5-9. (h)
- AIRDESIGN, INC., 241 Fairfield Ave., Upper Darby, Pa. 1-4-5-7-9. ADV. PG. 368. (h)
- AIRPAX PRODUCTS CO., Middle River, Baltimore 20, Md. 1-2-3-4-5-6-7-9-10. ADV. PG. 289. (h)
- Altec-Lansing Corp., 9356 Santa Monica Blvd., Beverly Hills, Calif. 1. (h)
- AMERICAN TELEVISION & RADIO CO., 300 E. Fourth St., St. Paul 1, Minn. 8. ADV. PG. 266. (h)
- Amplifier Corp. of America, 398 Broadway, New York 13, N. Y. 1-5-10. (h)
- Atlas Coil Winders, Inc., Stamford, Conn. 3-4-5-7-8-10-12. (h)
- Audio Development Co., 2833 13th Ave., S., Minneapolis 7, Minn. 1-4-5. (h)
- Bogen Co., David, 663 Broadway Co., New York 12, N. Y. 1. (h)
- BOGUE ELECTRIC MFG. CO., 52 Iowa Ave., Paterson 3, N. J. 7-10. ADV. PG. 155. (h)
- BRACKE-SEIB X-RAY CO., INC., 293 Third Ave., New York, N. Y. 4-12. ADV. PG. 390. (h)
- CHICAGO TRANSFORMER DIV., Essex Wire Corp., 3501 W. Addison St., Chicago 18, Ill. 1-2-4-5-6-9. ADV. PG. 205. (h)
- Cinaudagraph Speakers, 7334 N. Clark St., Chicago 26, Ill. 1. (h)
- Cole Instrument Co., 1320 S. Grand Ave., Los Angeles 15, Calif. 3. (h)
- COMAR ELECTRIC CO., 3349 W. Addison St., Chicago 18, Ill. 1-3-4-5-9. ADV. PG. 335. (h)
- Consolidated Radio Products Co., 350 W. Erie St., Chicago 10, Ill. 1. (h)
- Crest Transformer Corp., 1834-36 W. North Ave., Chicago 22, Ill. 1-2-4-5-6-7-8-9-10. (h)
- DANO ELECTRIC CO., Main St., Winsted, Conn. 10. ADV. PG. 266. (h)
- Davis & Co., Inc., Dean W., 3418 N. Milwaukee Ave., Chicago, Ill. 1-2-3-4-5-6-7-8-9-10-11-12. (h)
- Delco Radio Div., General Motors Corp., Kokomo, Ind. 1-9. (h)
- Dormitzer Electric Co., Inc., 89 Brighton Ave., Boston 34, Mass. 1-5-6-9. (h)
- Douglas-Randall, Inc., 102 High St., Westerly, R. I. 1-2-3-4-5-6-7-8-9-10-11-12. (h)
- Dresser Electric Co., 942 E. Larned St., Detroit 7, Mich. 4-7-8-10. (h)
- Edwards Co., Inc., 86 Boston Post Rd., Norwalk, Conn. 3-4-5-6. (h)
- EISLER ENGINEERING CO., INC., 740 S. 13th St., Newark, N. J. 11. ADV. PG. 378. (h)
- Electran Mfg. Co., 1901 N. Clybourn, Chicago, Ill. 1-3. (h)
- Electrical Windings, Inc., 2015 N. Kolmar Ave., Chicago 39, Ill. 1-2-4-5-6-7-9-12. (h)
- Electricoil Transformer Co., Westerly Rd., Ossining, N. Y. 4-5-6-7-11-12. (h)
- ELECTRO ACOUSTIC INDUSTRIES LTD., 366 Madison Ave., New York 17, N. Y. ADV. PG. 336. (h)
- Electro Engineering Wks., 6021 College Ave., Oakland 18, Calif. 6-10. (h)
- ELECTRO-VOICE, INC., Buchanan, Mich. 1. ADV. PG. 345. (h)

Ⓜ indicates . . . IN PRODUCTION • AVAILABILITY • UNRESTRICTED FOR GENERAL USE

Electronic Products Div., Epco Products, Inc., 2430 Atlantic Ave., Brooklyn 33, N. Y. 1-2-4-5-6-7-8-9-11. (h)

Ⓜ **ELECTRONIC TRANSFORMER CO., INC.**, 215 W. 25th St., New York, N. Y. 1-2-3-4-5-6-7-8-9-10. ADV. PG. 278. (h)

Ⓜ **Empire Coil Co., Inc.**, Beechwood Ave. & Second St., New Rochelle, N. Y. 1-5.

Ⓜ **Ensign Coil Co.**, 2516 S. Pulaski Rd., Chicago, Ill. 1-2.

Ⓜ **Etraco Manufacturing Co., Inc.**, Woods Church Rd., Flemington, N. J. 3-4-5-6-7-10-11-12.

Ⓜ **FEDERAL TELEPHONE & RADIO CORP.**, 88 Kingsland Rd., Clifton, N. J. 4. ADV. PG. 161-163.

Ⓜ **Federal Tool Engineering Co.**, 532 Mulberry St., Newark 5, N. J. 11.

Ⓜ **FERRANTI ELECTRIC, INC.**, 30 Rockefeller Plaza, New York 20, N. Y. 1-2-3-4-5-6-7-8-9-11. ADV. PG. 159. (h)

Ⓜ **Foster Transformer Co., Inc.**, 3820 Colerain Ave., Cincinnati 23, Ohio. 1-2-3-5-9.

Ⓜ **FREED TRANSFORMER CO., INC.**, 1736 Weirfield St., Brooklyn 27, N. Y. 1-2-3-4-5-6-7-9-10-11-12. ADV. PG. 149. (h)

Ⓜ **Gardner Electric Mfg. Co.**, 4227 Hollis St., Emeryville 8, Calif. 4-5-6-11-12.

Ⓜ **Gaveco Labs., Inc.**, 2 East End Ave., New York 21, N. Y. 1-5-6-7-10. (h)

Ⓜ **GENERAL ELECTRIC CO.**, Schenectady 5, N. Y. 1-2-4-5-6-10-11. ADV. PG. 1 to 22. (h)

Ⓜ **GENERAL RADIO CO.**, 275 Massachusetts Ave., Cambridge 39, Mass. 1-8. ADV. PG. 48, 49.

Ⓜ **General Transformer Co.**, 18240 Harwood Ave., Homewood, Ill. 1-2-3-4-5-6-8-9-10. (h)

Ⓜ **Geotronic Labs., Inc.**, Dallas 8, Texas. 1.

Ⓜ **Goslin Electric & Mfg. Co.**, 2921 W. Olive St., Burbank, Calif. 1-2-4-5-6-7-8-9-10. (h)

Ⓜ **GRAMER TRANSFORMER CO.**, 2734 N. Pulaski Rd., Chicago 39, Ill. 1-2-4-5-7-8-9-10. ADV. PG. 383. (h)

Ⓜ **Guthman, Inc.**, Edwin I., 15 S. Throop St., Chicago, Ill. 1-2.

Ⓜ **Haldorson Co., The**, 4500 Ravenswood Ave., Chicago, Ill. 1-2-4-5-8-9-10.

Ⓜ **HIGHLAND ENGINEERING CO.**, Main St. & Urban Ave., Westbury, N. Y. 1-10-11-12. ADV. PG. 360. (h)

Ⓜ **Inductive Equipment Co.**, Gettysburg, Pa. 1.

Ⓜ **JFD MFG. CO.**, 6101-23 Sixteenth Ave., Brooklyn, N. Y. 10. ADV. PG. 407.

Ⓜ **Jefferson Electric Co.**, Bellwood, Ill. 1.

Ⓜ **Jensen Mfg. Co.**, 6601 S. Laramie Ave., Chicago 38, Ill. 1.

Ⓜ **K-V Transformer Corp.**, 4414 Park Ave., New York 57, N. Y. 1-2-3-4-5-6-7-8-9.

Ⓜ **KENYON TRANSFORMER CO., INC.**, 840 Barry St., New York 59, N. Y. 1-2-3-4-5-6. ADV. PG. 325. (h)

Ⓜ **LANGEVIN MFG. CORP.**, 37 W. 65th St., New York 23, N. Y. 1-4-5. ADV. PG. 348.

Ⓜ **LaRose & Associates, Inc.**, W.T., 646 Second Ave., Troy, N. Y. 5-6.

Ⓜ **Leonard Electric Products Co., Inc.**, 1562 61st St., Brooklyn 19, N. Y. 1-2-3-4-5-7.

Ⓜ **Light Electric Corp.**, 214 Lackawanna Ave., Newark 4, N. J. 4-5-6-7-8-10-11.

Ⓜ **Magnatran, Incorporated**, Kearny, N. J. 1-2-3-4-5-6-7-8-10-11. (h)

Ⓜ **MAGNETIC AMPLIFIERS, INC.**, 1154 44th Drive, Long Island City 1, N. Y. 7. ADV. PG. 346.

Ⓜ **Magnetic Windings Div., Essex Wire Corp.**, Freemansburg Ave. at Hobson Blvd., Easton, Pa. 1-2-4-5-7-8-9. (h)

Ⓜ **Melco Products, Inc.**, 22 E. Hennepen Ave., Minneapolis 1, Minn. 1.

Ⓜ **Melpar, Inc.**, 552 Swann Ave., Alexandria, Va. 1-2-3-5-7-9.

Ⓜ **Merit Transformer Corp.**, 4427 N. Clark St., Chicago 40, Ill. 1-2-4-5-9.

Ⓜ **MID-WEST COIL & TRANSFORMER CO.**, 1642 N. Halsted St., Chicago 14, Ill. 1-2-4-5-7-8-9-10-11. ADV. PG. 165. (h)

Ⓜ **Munston Mfg. & Service, Inc.**, Beech St., Islip, N. Y. 1-9. (h)

Ⓜ **NEW YORK TRANSFORMER CO., INC.**, Third Ave., Alpha, N. J. 1-2-4-5-6-9. ADV. PG. 288. (h)

Ⓜ **North American Philips Co., Inc.**, 100 E. 42nd St., New York 17, N. Y. 12.

Ⓜ **Nothelifer Winding Labs.**, 9 Albemarle Ave., Trenton 3, N. J. 3-4-6-11.

Ⓜ **OPAD-GREEN CO.**, 71-5 Warren St., New York 7, N. Y. 4-5-6. ADV. PG. 314.

Ⓜ **PARMEKO, LTD.**, 366 Madison Ave., New York 17, N. Y. 1-2-3-4-5-6-7-9-10-11-12. ADV. PG. 336. (h)

Ⓜ **Peerless Electrical Products Co., Div. of Altec-Lansing Corp.**, 6920 McKinley Ave., Los Angeles 1, Calif. 1-10-11-12.

Ⓜ **PERMOFLUX CORP.**, 4900 W. Grand Ave., Chicago 39, Ill. 1. ADV. PG. 321.

Ⓜ **Philco Corp.**, Tioga & C Sts., Philadelphia 34, Pa. 1-4-9.

Ⓜ **Presto Electric Co., Inc.**, 4513 New York Ave., Union City, N. J. 1-2-3-4-5. (h)

Ⓜ **Picker X-Ray Corp.**, 300 Fourth Ave., New York 10, N. Y. 12.

Ⓜ **RADIO CORP. OF AMERICA**, Tube Dept., Harrison, N. J. 4-5-6. ADV. PG. 177, Inside Back & Back Covers.

Ⓜ **Radionic Transformer Co.**, 411 S. Sangamon St., Chicago 7, Ill. 1-5-9-11-12.

Ⓜ **RAYTHEON MFG CO., Equipment Sales Div.**, Waltham 54, Mass. 1-2-4-6-7-10-11. ADV. PG. 80, 81. (h)

Ⓜ **Red Arrow Electric Corp.**, 100 Coit St., Irvington 11, N. J. 1-11-12. (h)

Ⓜ **Richmond Engineering Co., Inc.**, 48 Water St., South Norwalk, Conn. 1-2-4-5-7-9-10. (h)

Ⓜ **Rola Co., Inc.**, 2530 Superior Ave., Cleveland 14, Ohio. 1-2. (h)

Ⓜ **S N C Mfg Co., Inc.**, Box 277, Oshkosh, Wis. 1-2-4-5-6-7-9. (h)

Ⓜ **Sciaky Bros., Inc.**, 4915 W. 67th St., Chicago 38, Ill. 11.

Ⓜ **SOLA ELECTRIC CO.**, 4633 W. 16th St., Chicago 50, Ill. 10. ADV. PG. 312.

Ⓜ **SORENSEN & CO., INC.**, 375 Fairfield Ave., Stamford, Conn. 5-6-7. ADV. PG. 66, 67. (h)

Ⓜ **Sorgel Electric Co.**, 838 W. National Ave., Milwaukee 4, Wis. 11.

Ⓜ **Southwestern Industrial Electronics Co.**, 2831 Post Oak Rd., P.O. Box 13058, Houston 19, Texas. 1-2. (h)

Ⓜ **Standard Electronics Corp.**, 25 W. 43rd St., New York 18, N. Y. 2-5-6.

Ⓜ **Standard Telephones & Cables Ltd.**, Connaught House, Aldwych, London, W. C. 2, England. 1-2.

Ⓜ **STANDARD TRANSFORMER CORP.**, Elston, Kedzie & Addison, Chicago 18, Ill. 1-2-4-5-6-8-9-10-11. ADV. PG. 144.

Ⓜ **Super Electric Products Corp.**, 46 Oliver St., Newark, N. J. 1.

Ⓜ **SUPERIOR ELECTRIC CO., THE**, 4000 Church St., Bristol, Conn. 10. ADV. PG. 190, 191.

Ⓜ **Tartak-Stolle Electronics, Inc.**, 3970 S. Grand Ave., Los Angeles 37, Calif. 1-4-5-7-10.

Ⓜ **Television Laboratories, Inc.**, 5045 W. Lake St., Chicago 44, Ill. 1-5.

Ⓜ **Tetrad Co.**, 4921 Exposition Blvd., Los Angeles 16, Calif. 1-2-3-4-5-6-7-9. (h)

Ⓜ **Ther Electric & Machine Works**, 15 S. Jefferson St., Chicago, Ill. 4-6-7.

Ⓜ **Thermador Electric Mfg. Co.**, 5119 District Blvd., Los Angeles 22, Calif. 1-2-4-5-6. (h)

Ⓜ **Thordarson-Meissner Mfg. Divisions**, 500 W. Huron St., Chicago 10, Ill. 1-2-3-4-5-6-7-8-9-10-11-12. (h)

Ⓜ **Transformer Engineers**, 389 S. Arroyo Parkway, Pasadena, Calif. 1-2-4-5-9. (h)

Ⓜ **Trenton Transformer Corp.**, P.O. Box 568, Trenton, N. J. 1-2-3-4-10-11.

Ⓜ **Triad Transformer Mfg. Co.**, 2254 Sepulveda Blvd., Los Angeles 64, Calif. 1-2-4-5-6-9. (h)

Ⓜ **Triplet & Barton, Inc.**, 831 N. Lake St., Burbank, Calif. 12.

Ⓜ **UNION ELECTRIC PRODUCTS CO.**, 24 Edison Pl., Newark 2, N. J. 1-3-4-5-10. ADV. PG. 60. (h)

Ⓜ **UNITED TRANSFORMER CO.**, 150 Varick St., New York 13, N. Y. 1-2-3-4-5-6-7-8-9-10-11. ADV. PG. Inside Front Cover. (h)

Ⓜ **UNIVERSITY LOUDSPEAKERS, INC.**, 80 S. Kensico Ave., White Plains, N. Y. 1. ADV. PG. 38. (h)

Ⓜ **Utah Radio Products, Inc.**, E. Franklin St., Huntington, Ind. 1-5. (h)

Ⓜ **WESTINGHOUSE ELECTRIC CORP.**, 511 Wood St., P.O. Box 868, Pittsburgh 30, Pa. 1-2-3-4-5-6-11-12. ADV. PG. 107-113.

TRANSFORMERS—Microwave

Ⓜ **Bunnell & Co., J. H.**, 81 Prospect St., Brooklyn, N. Y.

Ⓜ **HIGHLAND ENGINEERING CO.**, Main St. & Urban Ave., Westbury, N. Y. ADV. PG. 360. (h)

Ⓜ **Inductive Equipment Co.**, Gettysburg, Pa.

Ⓜ **JENNINGS RADIO MFG. CO.**, 1098 E. William St., San Jose 12, Calif. ADV. PG. 194, 195.

Ⓜ **K-V Transformer Corp.**, 4414 Park Ave., New York 57, N. Y.

Ⓜ **KINGS MICROWAVE CO., INC.**, 50 Marbledale Rd., Tuckahoe 7, N. Y. ADV. PG. 178, 179.

Ⓜ **MARCONI INSTRUMENTS, LTD.**, 23 Beaver St., New York 4, N. Y. ADV. PG. 270.

Ⓜ **Microwave Equipment Co., Inc.**, North Caldwell, N. J.

Ⓜ **Peerless Electrical Products Co., Div. of Altec-Lansing Corp.**, 6920 McKinley Ave., Los Angeles 1, Calif.

Ⓜ **PRODUCT DEVELOPMENT CO., INC.**, Arlington, N. J. ADV. PG. 362.

Ⓜ **SPERRY GYROSCOPE CO.**, Div. of The Sperry Corp., Great Neck, N. Y. ADV. PG. 103, 104. (h)

Ⓜ **TECHNICRAFT LABORATORIES, INC.**, Thomaston-Waterbury Rd., Thomaston, Conn. ADV. PG. 342.

Ⓜ **Thordarson-Meissner Mfg. Divisions**, 500 W. Huron St., Chicago 10, Ill. (h)

Ⓜ **Varian Associates**, 99 Washington St., San Carlos, Calif.

Ⓜ **VECTRON, INC.**, 235 High St., Waltham, Mass. ADV. PG. 214.

Ⓜ **Wheeler Laboratories, Inc.**, Great Neck, N. Y.

TRANSFORMERS—Pulse

Ⓜ **ACME ELECTRIC CORP.**, 31 Water St., Cuba, N. Y. ADV. PG. 90.

Ⓜ **Acro Products Co.**, 215 Arch St., Philadelphia 6, Pa.

Ⓜ **AIRDESIGN INC.**, 241 Fairfield Ave., Upper Darby, Pa. ADV. PG. 368. (h)

Ⓜ **AIRPAX PRODUCTS CO.**, Middle River, Baltimore 20, Md. ADV. PG. 289. (h)

Ⓜ **Altec Lansing Corp.**, 9356 Santa Monica Blvd., Beverly Hills, Calif. (h)

Ⓜ **Arco Transformer & Electric Corp.**, 1602 S. Hanna St., Fort Wayne, Ind. (h)

Ⓜ **Arco Transformer Mfg. Corp.**, 21-20 33rd Ave., Long Island City, N. Y. (h)

Ⓜ **Atlas Coil Winders, Inc.**, Stamford, Conn.

Ⓜ **Audio Development Co.**, 2833 13th Ave., S., Minneapolis 7, Minn. (h)

Ⓜ **Berkshire Laboratories**, 580 Lexington Rd., Concord, Mass. (h)

Ⓜ **CHICAGO TRANSFORMER DIV.**, Essex Wire Corp., 3501 W. Addison St., Chicago 18, Ill. ADV. PG. 205. (h)

Ⓜ **COMMUNICATION ACCESSORIES CO.**, Box 345, 110th St. & Hillcrest Rd., Hickman Hills, Mo. ADV. PG. 168. (h)

Ⓜ **Davis & Co., Inc.**, Dean W., 3418 N. Milwaukee Ave., Chicago, Ill. (h)

Ⓜ **Dormitzer Electric Co., Inc.**, 89 Brighton Ave., Boston 34, Mass. (h)

Ⓜ **Douglas-Randall, Inc.**, 102 High St., Westerly, R. I. Electriccoil Transformer Co., Westerly Rd., Ossining, Ill. (h)

Ⓜ **Electrical Transformer Co.**, Westerly Rd., Ossining, N. Y. (h)

Ⓜ **Electronic Products Div., Epco Products, Inc.**, 2430 Atlantic Ave., Brooklyn 33, N. Y. (h)

Ⓜ **ELECTRONIC TRANSFORMER CO., INC.**, 215 W. 25th St., New York, N. Y. ADV. PG. 278. (h)

Ⓜ **Engineering Research Associates, Inc.**, 1902 W. Minnehaha Ave., St. Paul, Minn. (h)

Ⓜ **Essex Electronics**, Berkeley Heights, N. J.

Ⓜ **FERRANTI ELECTRIC, INC.**, 30 Rockefeller Plaza, New York 20, N. Y. ADV. PG. 159. (h)

Ⓜ **Foster Transformer Co., Inc.**, 3820 Colerain Ave., Cincinnati 23, Ohio. (h)

Ⓜ **FREED TRANSFORMER CO., INC.**, 1736 Weirfield St., Brooklyn 27, N. Y. ADV. PG. 149. (h)

Ⓜ **FUGLE-MILLER LABORATORIES, INC.**, 399 Main St., Metuchen, N. J. ADV. PG. 218. (h)

Ⓜ **GENERAL ELECTRIC CO.**, Schenectady 5, N. Y. ADV. PG. 1 to 22. (h)

Ⓜ **Goslin Electric & Mfg. Co.**, 2921 W. Olive St., Burbank, Calif. (h)

Ⓜ **HEPPNER MFG. CO.**, P.O. Box 612, Round Lake, Ill. ADV. PG. 413. (h)

Ⓜ **HIGHLAND ENGINEERING CO.**, Main St. & Urban Ave., Westbury, N. Y. ADV. PG. 360. (h)

Ⓜ **Inductive Equipment Co.**, Gettysburg, Pa.

Ⓜ **K-V Transformer Corp.**, 4414 Park Ave., New York 57, N. Y.

Ⓜ **KENYON TRANSFORMER CO., INC.**, 840 Barry St., New York 59, N. Y. ADV. PG. 325. (h)

Ⓜ **Magnatran, Incorporated**, Kearny, N. J. (h)

Ⓜ **Magnetic Windings Div., Essex Wire Corp.**, Freemansburg Ave. & Hobson Blvd., Easton, Pa. (h)

Ⓜ **Melco Products, Inc.**, 22 E. Hennepen Ave., Minneapolis 1, Minn. (h)

Ⓜ **Melpar, Inc.**, 552 Swann Ave., Alexandria, Va.

Ⓜ **PARMEKO, LTD.**, 366 Madison Ave., New York 17, N. Y. ADV. PG. 336. (h)

Ⓜ **Peerless Electrical Products Co., Div. of Altec-Lansing Corp.**, 6920 McKinley Ave., Los Angeles 1, Calif.

Ⓜ **PERMOFLUX CORP.**, 4900 W. Grand Ave., Chicago 39, Ill. ADV. PG. 321.

Ⓜ **RAYTHEON MFG. CO.**, Equipment Sales Div., Waltham 54, Mass. ADV. PG. 80, 81. (h)

Ⓜ **Red Arrow Electric Corp.**, 100 Coit St., Irvington 11, N. J. (h)

Ⓜ **SPERRY GYROSCOPE CO.**, Div. of The Sperry Corp., Great Neck, N. Y. ADV. PG. 103, 104. (h)

Ⓜ **STANDARD TRANSFORMER CORP.**, Elston, Kedzie & Addison, Chicago 18, Ill. ADV. PG. 144.

Ⓜ **Tartak-Stolle Electronics, Inc.**, 3970 S. Grand Ave., Los Angeles 37, Calif.

Ⓜ **Tetrad Co.**, 4921 Exposition Blvd., Los Angeles 16, Calif. (h)

Ⓜ **Thordarson-Meissner Mfg. Divisions**, 500 W. Huron St., Chicago 10, Ill. (h)

Ⓜ **Transformer Engineers**, 389 S. Arroyo Parkway, Pasadena, Calif. (h)

Ⓜ **Triad Transformer Mfg. Co.**, 2254 Sepulveda Blvd., Los Angeles 64, Calif. (h)

Ⓜ **U. S. ELECTRONICS CORP.**, 276 Warren St., Lyndhurst, N. J. ADV. PG. 76. (h)

Ⓜ **UNITED TRANSFORMER CO.**, 150 Varick St., New York 13, N. Y. ADV. PG. Inside Front Cover. (h)

Ⓜ **Utah Radio Products, Inc.**, E. Franklin St., Huntington, Ind. (h)

Ⓜ **WESTINGHOUSE ELECTRIC CORP.**, 511 Wood St., P.O. Box 868, Pittsburgh 30, Pa. ADV. PG. 107-113. (h)

TRANSFORMERS—r-f and i-f

Ⓜ **ACME ELECTRIC CORP.**, 31 Water St., Cuba, N. Y. ADV. PG. 90.

Ⓜ **ACME ELECTRONICS, INC.**, 300 N. Lake Ave., Pasadena 4, Calif. ADV. PG. 182. (h)

Ⓜ **Aero Coil Inc.**, 507 26th St., Union City, N. J.

Ⓜ **Atlas Coil Winders, Inc.**, Stamford, Conn.

Ⓜ **Automatic Mfg. Corp.**, 65 Gouverneur St., Newark 4, N. J.

V indicates . . . **IN PRODUCTION • AVAILABILITY • UNRESTRICTED FOR GENERAL USE**

- OBARKER & WILLIAMSON, 235 Fairfield Ave., Upper Darby, Pa. ADV. PG. 292.
- OCADDELL-BURNS MFG. CO., 480 Broome St., New York 13, N. Y. ADV. PG. 224.
- OClippard Instrument Laboratory Inc., 1125 Bank St., Cincinnati 14, Ohio.
- Coil Winders, Inc., 61 Bergen St., Brooklyn 2, N. Y.
- OCOILCRAFT, INC., 3716 N. Cicero Ave., Chicago 41, Ill. ADV. PG. 360.
- ODavis & Co., Inc., Dean W., 3418 N. Milwaukee Ave., Chicago, Ill. (h)
- ODIETZ DESIGN & MFG. CO., Grandview, Mo. ADV. PG. 323. (h)
- OEsxex Electronics, Berkeley Heights, N. J. (h)
- OFUGLE-MILLER LABORATORIES, INC., 398 Main St., Metuchen, N. J. ADV. PG. 218. (h)
- OGuthman, Inc., Edwin I. 15 S. Throop St., Chicago, Ill.
- OHARNETT ELECTRIC CORP., 138 Haven Ave., Port Washington, L. I., N. Y. ADV. PG. 399.
- OHILLBURN ELECTRONIC PRODUCTS CO., 55 Nassau Ave., Brooklyn 22, N. Y. ADV. PG. 362.
- Inductive Equipment Co., Gettysburg, Pa.
- OJOHNSON CO., E. F., Waseca, Minn. ADV. PG. 118, 121.
- Leonard Electric Products Co., Inc., 1562 61st St., Brooklyn 19, N. Y. (h)
- OLynnmar Engineers, Inc., 1721 Delancey St., Philadelphia 3, Pa.
- OMillen Mfg. Co., James, 150 Exchange St., Malden, Mass.
- OMiller Co., J. W., 5917 S. Main St., Los Angeles 3, Calif.
- OMuter Co., 1255 S. Michigan Ave., Chicago, Ill.
- ONATIONAL CO., INC., 61 Sherman St., Malden 48, Mass. ADV. PG. 280, 281.
- OPeerless Electrical Products Co. Div. of Altec-Lansing Corp., 6920 McKinley Ave., Los Angeles 1, Calif.
- OPhilco Corp., Tioga & C Sts., Philadelphia 34, Pa.
- OPress Wireless Mfg. Co., Inc., Cantiague Rd., Hicksville, N. Y.
- ORADIO CORP. OF AMERICA, Tube Dept., Harrison, N. J. ADV. PG. 177, Inside Back & Back Covers.
- ORadio Condenser Co., Camden, N. J.
- ORAYTHEON MFG. CO., Equipment Sales Div., Waltham 54, Mass. ADV. PG. 80, 81.
- Rollan Electrical Co., 8020 S. South Park, Chicago, Ill.
- Ross Mfg. Co., 860 Washington St., Burlington, Iowa.
- OSickles Co., F. W., 165 Front St., Chicopee, Mass.
- OSTANDARD COIL PRODUCTS CO., 2329 N. Pulaski Rd., Chicago 39, Ill. ADV. PG. 97.
- Stanwyck Winding Company, 137 Walsh Ave., Newburgh, N. Y.
- OSuper Electric Products Corp., 46 Oliver St., Newark, N. J. (h)
- OTeleradio Engineering Corp., 99 Wall St., New York 5, N. Y.
- OTetrad Co., 4921 Exposition Blvd., Los Angeles 16, Calif. (h)
- OTHordarson-Meissner Mfg. Divisions, 500 W. Huron St., Chicago 10, Ill. (h)
- OU. S. ELECTRONICS CORP., 276 Warren St., Lyndhurst, N. J. ADV. PG. 76. (h)

TRANSFORMERS—Subsonic

- Acro Products Co., 215 Arch St., Philadelphia 6, Pa. (h)
- ODouglas-Randall, Inc., 102 High St., Westerly, R. I. (h)
- OELECTRONIC TRANSFORMER CO., INC., 215 W. 25th St., New York, N. Y. ADV. PG. 278. (h)
- OFERRANTI ELECTRIC, INC., 30 Rockefeller Plaza, New York 20, N. Y. ADV. PG. 159. (h)
- OGeotronic Labs., Inc., Dallas 8, Texas. (h)
- OMagnatran, Incorporated, Kearny, N. J. (h)
- OMiller Co., J. W., 5917 S. Main St., Los Angeles 3, Calif. (h)
- OPARMEKO, LTD., 366 Madison Ave., New York 17, N. Y. ADV. PG. 336. (h)
- OSouthwestern Industrial Electronics Co., 2831 Post Oak Rd., P. O. Box 13058, Houston 19, Texas. (h)
- OThermador Electric Mfg. Co., 5119 District Blvd., Los Angeles 22, Calif. (h)
- OTHordarson-Meissner Mfg. Divisions, 500 W. Huron St., Chicago 10, Ill. (h)
- OTransformer Engineers, 389 S. Arroyo Parkway, Pasadena, Calif. (h)
- OU. S. ELECTRONICS CORP., 276 Warren St., Lyndhurst, N. J. ADV. PG. 76. (h)
- OUNITED TRANSFORMER CO., 150 Varick St., New York 13, N. Y. ADV. PG. Inside Front Cover. (h)

TRANSFORMERS—TV Horizontal Deflection

- OAero Coil, Inc., 507 26th St., Union City, N. J.
- OAIRDESIGN, INC., 241 Fairfield Ave., Upper Darby, Pa. ADV. PG. 368. (h)
- OAutomatic Mfg. Corp., 65 Gouverneur St., Newark, N. J.
- OCHICAGO TRANSFORMER DIV., Essex Wire Corp., 3501 W. Addison St., Chicago 18, Ill. ADV. PG. 205. (h)
- Coil Winders, Inc., 61 Bergen St., Brooklyn 2, N. Y.
- OCossor (Canada), Ltd., 301-303 Windsor St., Halifax, N. S., Canada.

- ODX Radio Products Co., INC., 2304 Armitage Ave., Chicago 47, Ill.
- ODavis & Co., Inc., Dean W., 3418 N. Milwaukee Ave., Chicago, Ill.
- OElectrical Windings, Inc., 2015 N. Kolmar Ave., Chicago 39, Ill.
- OELECTRONIC TRANSFORMER CO., INC., 215 W. 25th St., New York, N. Y. ADV. PG. 278. (h)
- OEmpire Coil Co., Inc., Beechwood Ave. & Second St., New Rochelle, N. Y.
- OEsxex Electronics, Berkeley Heights, N. J.
- OFREED TRANSFORMER CO., INC., 1736 Weirfield St., Brooklyn 27, N. Y. ADV. PG. 149. (h)
- OGeneral Transformer Co., 18240 Harwood Ave., Homewood, Ill. (h)
- OGuthman, Inc., Edwin I., 15 S. Throop St., Chicago, Ill.
- OHaldorson Co., The, 4500 Ravenswood Ave., Chicago, Ill.
- Leonard Electric Products Co., Inc., 1562 61st St., Brooklyn 19, N. Y. (h)
- OMagnetic Windings Div., Essex Wire Corp., Freemansburg Ave., at Hobson Blvd., Easton, Pa. (h)
- OMerit Transformer Corp., 4427 N. Clark St., Chicago 40, Ill.
- OPARMEKO, LTD., 366 Madison Ave., New York 17, N. Y. ADV. PG. 336 (h)
- OPhilco Corp., Tioga & C Sts., Philadelphia 34, Pa.
- ORADIO CORP. OF AMERICA, Tube Dept., Harrison, N. J. ADV. PG. 177, Inside Back & Back Covers.
- ORichmond Engineering Co., Inc., 48 Water St., South Norwalk, Conn. (h)
- ORola Co., Inc., 2530 Superior Ave., Cleveland 14, Ohio. (h)
- Ross Mfg. Co., 860 Washington St., Burlington, Iowa.
- OS N C Mfg. Co., Inc., Box 277, Oshkosh, Wis. (h)
- OSickles Co., F. W., 165 Front St., Chicopee, Mass.
- OSTANDARD TRANSFORMER CORP., Elston, Kedzie & Addison, Chicago 18, Ill. ADV. PG. 144.
- OTartak-Stolle Electronics, Inc., 3970 S. Grand Ave., Los Angeles 37, Calif.
- OTeleradio Engineering Corp., 99 Wall St., New York 5, N. Y.
- OTetrad Co., 4921 Exposition Blvd., Los Angeles 16, Calif. (h)
- OTHordarson-Meissner Mfg. Divisions, 500 W. Huron St., Chicago 10, Ill. (h)
- OTriad Transformer Mfg. Co., 2254 Sepulveda Blvd., Los Angeles 64, Calif. (h)
- OU. S. ELECTRONICS CORP., 276 Warren St., Lyndhurst, N. J. ADV. PG. 76. (h)
- OUNITED TRANSFORMER CO., 150 Varick St., New York 13, N. Y. ADV. PG. Inside Front Cover. (h)

TRANSFORMERS—TV Vertical Deflection

- OAIRDESIGN, INC., 241 Fairfield Ave., Upper Darby, Pa. ADV. PG. 368. (h)
- OArco Transformer & Electric Corp., 1602 S. Hanna St., Fort Wayne, Ind.
- OCHICAGO TRANSFORMER DIV., Essex Wire Corp., 3501 W. Addison St., Chicago 18, Ill. ADV. PG. 205. (h)
- OCossor (Canada), Ltd., 301-303 Windsor St., Halifax, N. S., Canada.
- OCrest Transformer Corp., 1834-36 W. North Ave., Chicago 22, Ill. (h)
- ODavis & Co., Inc., Dean W., 3418 N. Milwaukee Ave., Chicago, Ill. (h)
- OELECTRONIC TRANSFORMER CO., INC., 215 W. 25th St., New York, N. Y. ADV. PG. 278. (h)
- OEmpire Coil Co., Inc., Beechwood Ave. & Second St., New Rochelle, N. Y.
- OFREED TRANSFORMER CO., INC., 1736 Weirfield St., Brooklyn 27, N. Y. ADV. PG. 149. (h)
- OGeneral Transformer Co., 18240 Harwood Ave., Homewood, Ill. (h)
- OGRAMER TRANSFORMER CO., 2734 N. Pulaski Rd., Chicago 39, Ill. ADV. PG. 383. (h)
- OGuthman, Inc., Edwin I., 15 S. Throop St., Chicago, Ill.
- OHaldorson Co., The, 4500 Ravenswood Ave., Chicago, Ill.
- Leonard Electric Products Co., Inc., 1562 61st St., Brooklyn 19, N. Y. (h)
- OMagnetic Windings Div., Essex Wire Corp., Freemansburg Ave. at Hobson Blvd., Easton, Pa. (h)
- OMerit Transformer Corp., 4427 N. Clark St., Chicago 40, Ill.
- OMID-WEST COIL & TRANSFORMER CO., 1642 N. Halsted St., Chicago 14, Ill. ADV. PG. 165. (h)
- OPARMEKO, LTD., 366 Madison Ave., New York 17, N. Y. ADV. PG. 336. (h)
- OPhilco Corp., Tioga & C Sts., Philadelphia 34, Pa.
- ORADIO CORP. OF AMERICA, Tube Dept., Harrison, N. J. ADV. PG. 177, Inside Back & Back Covers.
- ORichmond Engineering Co., Inc., 48 Water St., South Norwalk, Conn. (h)
- ORola Co., Inc., 2530 Superior Ave., Cleveland 14, Ohio. (h)
- Ross Mfg. Co., 860 Washington St., Burlington, Iowa.
- OS N C Mfg. Co., Inc., Box 277, Oshkosh, Wis. (h)
- OSTANDARD TRANSFORMER CORP., Elston, Kedzie & Addison, Chicago 18, Ill. ADV. PG. 144.
- OTartak-Stolle Electronics, Inc., 3970 S. Grand Ave., Los Angeles 37, Calif.
- OTetrad Co., 4921 Exposition Blvd., Los Angeles 16, Calif. (h)

- OTHordarson-Meissner Mfg. Divisions, 500 W. Huron St., Chicago 10, Ill. (h)
- OTriad Transformer Mfg. Co., 2254 Sepulveda Blvd., Los Angeles 64, Calif. (h)
- OU. S. ELECTRONICS CORP., 276 Warren St., Lyndhurst, N. J. ADV. PG. 76.
- OUNITED TRANSFORMER CO., 150 Varick St., New York 13, N. Y. ADV. PG. Inside Front Cover. (h)

TRANSFORMERS—Toroidal

- OCACME ELECTRONICS, INC., 300 N. Lake Ave., Pasadena 4, Calif. ADV. PG. 182. (h)
- OCoil Winders, Inc., Stamford, Conn.
- OAero Coil Inc., 507 26th St., Union City, N. J.
- OBOGUE ELECTRIC MFG. CO., 52 Iowa Ave., Paterson 3, N. J. ADV. PG. 155. (h)
- OBOND ELECTRONICS CORP., 88 Franklin Place, Summit, N. J. ADV. PG. 403.
- OBURNELL & CO., 45 Warburton Ave., Yonkers 2, N. Y. ADV. PG. 75.
- OCHICAGO TRANSFORMER DIV., Essex Wire Corp., 3501 W. Addison St., Chicago 18, Ill. ADV. PG. 205. (h)
- Coil Winders, Inc., 61 Bergen St., Brooklyn 2, N. Y.
- OCOMMUNICATION ACCESSORIES CO., Box 345, 110th & Hillcrest Rd., Hickman Hills, Mo. ADV. PG. 168.
- ODX Radio Products Co., Inc., 2304 Armitage Ave., Chicago 47, Ill. (h)
- ODECOURSEY ENGINEERING LAB., P. O. Box 235, Los Angeles 25, Calif. ADV. PG. 174. (h)
- ODIETZ DESIGN & MFG. CO., Grandview, Mo. ADV. PG. 323. (h)
- ODouglas-Randall, Inc., 102 High St., Westerly, R. I. (h)
- OELECTRONIC TRANSFORMER CO., INC., 215 W. 25th St., New York, N. Y. ADV. PG. 278. (h)
- OFoster Transformer Co., Inc., 3820 Colerain Ave., Cincinnati 23, Ohio.
- OFREED TRANSFORMER CO., INC., 1736 Weirfield St., Brooklyn 27, N. Y. ADV. PG. 149. (h)
- OGENERAL RADIO CO., 275 Massachusetts Ave., Cambridge 39, Mass. ADV. PG. 48, 49.
- OGuthman, Inc., Edwin I. 15 S. Throop St., Chicago, Ill.
- OHIPPNER MFG. CO., P. O. Box 612, Round Lake, Ill. ADV. PG. 413.
- Hycor Co., Inc., 11423 Vanowen St., North Hollywood, Calif.
- Leonard Electric Products Co., Inc., 1562 61st St., Brooklyn 19, N. Y. (h)
- OMagnatran, Incorporated, Kearny, N. J. (h)
- OMAGNETIC AMPLIFIERS, INC., 1154 44th Drive, Long Island City 1, N. Y. ADV. PG. 346.
- OMAGNETICS, INC., Box 761, Butler, Pa. ADV. PG. 381.
- OPARMEKO, LTD., 366 Madison Ave., New York 17, N. Y. ADV. PG. 336. (h)
- OPERMOFLOX CORP., 4900 W. Grand Ave., Chicago 39, Ill. ADV. PG. 321.
- ORailway Communications, Inc., P. O. Box 1783, Lincoln, Neb.
- OSouthwestern Industrial Electronics Co., 2831 Post Oak Rd., P. O. Box 13058, Houston 19, Texas. (h)
- OSTandard Telephones & Cables Ltd., Connaught House, Aldwych, London, W. C. 2, England.
- OTartak-Stolle Electronics, Inc., 3970 S. Grand Ave., Los Angeles 37, Calif.
- OTelevision Laboratories, Inc., 5045 W. Lake St., Chicago 44, Ill. (h)
- OTetrad Co., 4921 Exposition Blvd., Los Angeles 16, Calif. (h)
- OTriad Transformer Mfg. Co., 2254 Sepulveda Blvd., Los Angeles 64, Calif. (h)
- OU. S. ELECTRONICS CORP., 276 Warren St., Lyndhurst, N. J. ADV. PG. 76.
- OUNITED TRANSFORMER CO., 150 Varick St., New York 13, N. Y. ADV. PG. Inside Front Cover. (h)

TRANSFORMERS—Ultrasonic

- Acro Products Co., 215 Arch St., Philadelphia 6, Pa. (h)
- OAero Transformer Mfg. Corp., 21-20 33rd Ave., Long Island City, N. Y.
- OCoil Winders, Inc., Stamford, Conn.
- OBUSH DEVELOPMENT CO., 3405 Perkins Ave., Cleveland 14, Ohio. ADV. PG. 228, 229.
- OCOMMUNICATION ACCESSORIES CO., Box 345, 110th St. & Hillcrest Rd., Hickman Hills, Missouri. ADV. PG. 168.
- ODouglas-Randall, Inc., 102 High St., Westerly, R. I. (h)
- OELECTRONIC TRANSFORMER CO., INC., 215 W. 25th St., New York 20, N. Y. ADV. PG. 159. (h)
- OFERRANTI ELECTRIC, INC., 30 Rockefeller Plaza, New York 20, N. Y. ADV. PG. 159.
- OFREED TRANSFORMER CO., INC., 1736 Weirfield St., Brooklyn 27, N. Y. ADV. PG. 149. (h)
- OGuthman, Inc., Edwin I., 15 S. Throop St., Chicago, Ill.
- Inductive Equipment Co., Gettysburg, Pa.
- OK-V Transformer Corp., 4414 Park Ave., New York 57, N. Y.
- Leonard Electric Products Co., Inc., 1562 61st St., Brooklyn 19, N. Y. (h)
- OMiller Co., J. W., 5917 S. Main St. Los Angeles 3, Calif.
- OPARMEKO, LTD., 366 Madison Ave., New York 17, N. Y. ADV. PG. 336. (h)

Ⓢ indicates . . . IN PRODUCTION • AVAILABILITY • UNRESTRICTED FOR GENERAL USE

- ⓈRAYTHEON MFG. CO., Equipment Sales Div., Waltham 54, Mass. ADV. PG. 80, 81.
- ⓈSouthwestern Industrial Electronics Co., 2831 Post Oak Rd., P. O. Box 13058, Houston 19, Texas. (h)
- ⓈStandard Telephones & Cables Ltd., Connaught House, Aldwych, London, W. C. 2, England.
- ⓈTetrad Co., 4921 Exposition Blvd., Los Angeles 16, Calif.
- ⓈThordarson-Meissner Mfg. Divisions, 500 W. Huron St., Chicago 10, Ill. (h)
- ⓈTriad Transformer Mfg. Co., 2254 Sepulveda Blvd., Los Angeles 64, Calif.
- ⓈUNITED TRANSFORMER CO., 150 Varick St., New York 13, N. Y. ADV. PG. Inside Front Cover. (h)

TRANSISTORS

- ⓈStandard Telephones & Cables Ltd., Connaught House, Aldwych, London, W. C. 2, England.

TRANSMISSION LINES

See Cable, Coaxial or Waveguides

TRANSMITTERS—Aircraft

- ⓈAeronautical Communications Equipment, Inc., 3090 Douglas Rd., Miami 33, Fla.
- ⓈAIR ASSOCIATES INC., Teterboro, N. J. ADV. PG. 211.
- ⓈAIRCRAFT RADIO CORP., Boonton, N. J. ADV. PG. 400, 401.
- ⓈAMERICAN ELECTROENGINEERING CORP., 5025-29 W. Jefferson Blvd., Los Angeles 16, Calif. ADV. PG. 136.
- ⓈBassett, Inc., Rex, 307-311 N. W. First Ave., Fort Lauderdale, Fla.
- ⓈBelmont Radio Co., Div. Raytheon Mfg. Co., 5921 W. Dickens Ave., Chicago 39, Ill.
- ⓈBendix Radio Division, Bendix Aviation Corp., Baltimore 4, Md.
- ⓈBunnell & Co., J. H., 81 Prospect St., Brooklyn, N. Y.
- ⓈCollins Radio Co., Cedar Rapids, Iowa.
- ⓈCommunications Co., Inc., 300 Greco Ave., Coral Gables 34, Fla.
- ⓈContinental Electronics Mfg. Co., 4212-20 S. Buckner Blvd., Dallas 10, Texas.
- ⓈCossor (Canada), Ltd., 301-303 Windsor St., Halifax, N. S., Canada.
- ⓈElectronic Specialty Co., 3456 Glendale Blvd., Los Angeles 39, Calif.
- ⓈElectronic Surgical Equipment Co., Inc., N. E. Cor. 23 & Arch Sts., Philadelphia 3, Pa.
- ⓈGENERAL ELECTRIC CO., Electronics Dept., Electronics Park, Syracuse, N. Y. ADV. PG. 1 to 22.
- ⓈJarvis Electronics Corp., 6058 W. Fullerton Ave., Chicago 39, Ill.
- ⓈMARCONI INSTRUMENTS, LTD., 23 Beaver St., New York 4, N. Y. ADV. PG. 270.
- ⓈMITCHELL INDUSTRIES, INC., Camp Wolters, Mineral Wells, Texas. ADV. PG. 298.
- ⓈRADIO CORP. OF AMERICA, RCA Victor Div., General Offices, Camden, N. J. ADV. PG. 177, Inside Back & Back Covers.
- ⓈStandard Telephones & Cables Ltd., Connaught House, Aldwych, London, W. C. 2, England.
- ⓈTRAD TELEVISION CORP., 1001 First Ave., Asbury Park, N. J. ADV. PG. 355.
- ⓈTransmitter Equipment Mfg. Co., Inc., 345 Hudson St., New York 14, N. Y.
- ⓈWilcox Electric Co., 1400 Chestnut St., Kansas City, Mo.

TRANSMITTERS—Amateur

- ⓈBARKER & WILLIAMSON, 235 Fairfield Ave., Upper Darby, Pa. ADV. PG. 292.
- ⓈBassett, Inc., Rex, 307-311 N. W. First Ave., Fort Lauderdale, Fla.
- ⓈCollins Radio Co., Cedar Rapids, Iowa.
- ⓈCommunications Co., Inc., 300 Greco Ave., Coral Gables 34, Fla.
- ⓈHarvey-Wells Electronics Inc., North St., Southbridge, Mass.
- ⓈHEINTZ & KAUFMAN EQUIPMENT DIV. OF THE ROBERT DOLLAR CO., 50 Drumm St., San Francisco 11, Calif. ADV. PG. 301.
- ⓈJOHNSON CO., E. F., Waseca, Minn. ADV. PG. 118, 121.
- ⓈMcMurdo Silver Co., Inc., 417 Lafayette St., New York, N. Y.
- ⓈMillen Mfg. Co., James, 150 Exchange St., Malden, Mass.
- ⓈMotorola, Inc., 4545 Augusta Blvd., Chicago 51, Ill.
- ⓈRadio Transceiver Labs., 116-23 Jamaica Ave., Richmond Hill 18, N. Y.
- ⓈSTANDARD TRANSFORMER CORP., Elston, Kedzie & Addison, Chicago 18, Ill. ADV. PG. 144.
- ⓈTransmitter Equipment Mfg. Co., Inc., 345 Hudson St., New York 14, N. Y.

TRANSMITTERS—Broadcast

- ⓈBARKER & WILLIAMSON, 235 Fairfield Ave., Upper Darby, Pa. ADV. PG. 292.
- ⓈBunnell & Co., J. H., 81 Prospect St., Brooklyn, N. Y.

- ⓈCollins Radio Co., Cedar Rapids, Iowa.
- ⓈElectronic Surgical Equipment Co., Inc., N. E. Cor. 23 & Arch Sts., Philadelphia 3, Pa.
- ⓈErco Radio Labs., Inc., East Stewart Ave., Garden City, N. Y.
- ⓈFEDERAL TELEPHONE AND RADIO CORP., 88 Kingsland Rd., Clifton, N. J. ADV. PG. 161-163.
- ⓈGates Radio Co., Quincy, Ill.
- ⓈGENERAL ELECTRIC CO., Electronics Dept., Electronics Park, Syracuse, N. Y. ADV. PG. 1 to 22.
- ⓈMARCONI INSTRUMENTS, LTD., 23 Beaver St., New York 4, N. Y. ADV. PG. 270.
- ⓈPress Wireless Mfg. Co., Inc., Cantiague Rd., Hicksville, N. Y.
- ⓈRADIO CORP. OF AMERICA, RCA Victor Div., General Offices, Camden, N. J. ADV. PG. 177, Inside Back & Back Covers.
- ⓈRadio Engineering Labs., Inc., 36-40 37th St., Long Island City, N. Y.
- ⓈStandard Electronics Corp., 25 W. 43rd St., New York 18, N. Y.
- ⓈStandard Telephones & Cables Ltd., Connaught House, Aldwych, London, W. C. 2, England.
- ⓈTransmitter Equipment Mfg. Co., Inc., 345 Hudson St., New York 14, N. Y.
- ⓈWESTINGHOUSE ELECTRIC CORP., 511 Wood St., P. O. Box 868, Pittsburgh 30, Pa. ADV. PG. 107-113.

TRANSMITTERS—Citizen's Radio

- ⓈMcMurdo Silver Co., Inc., 417 Lafayette St., New York, N. Y.

TRANSMITTERS—Color Television

- ⓈGENERAL ELECTRIC CO., Electronics Dept., Electronics Park, Syracuse, N. Y. ADV. PG. 1 to 22.
- ⓈTelectrome, Inc., 88 Merrick Rd., Amityville, N. Y.
- ⓈWESTINGHOUSE ELECTRIC CORP., 511 Wood St., P. O. Box 868, Pittsburgh 30, Pa. ADV. PG. 107-113.

TRANSMITTERS—Direction Finding

- ⓈAeronautical Communications Equipment, Inc., 3090 Douglas Rd., Miami 33, Fla.
- ⓈAMERICAN ELECTROENGINEERING CORP., 5025-29 W. Jefferson Blvd., Los Angeles 16, Calif. ADV. PG. 136.
- ⓈErco Radio Labs., Inc., East Stewart Ave., Garden City, N. Y.
- ⓈMARCONI INSTRUMENTS, LTD., 23 Beaver St., New York 4, N. Y. ADV. PG. 270.
- ⓈMeasurement Engineering, Ltd., Arnprior, Ontario, Canada.
- ⓈPress Wireless Mfg. Co., Inc., Cantiague Rd., Hicksville, N. Y.

TRANSMITTERS—f-m

- ⓈBARKER & WILLIAMSON, 235 Fairfield Ave., Upper Darby, Pa. ADV. PG. 292.
- ⓈCapehart-Farnsworth Corp., Fort Wayne, Indiana.
- ⓈCollins Radio Co., Cedar Rapids, Iowa.
- ⓈCommunications Co., Inc., 300 Greco Ave., Coral Gables 34, Fla.
- ⓈDoolittle Radio, Inc., 7421 S. Loomis Blvd., Chicago 36, Ill.
- ⓈElectronic Surgical Equipment Co., Inc., N. E. Cor. 23 & Arch Sts., Philadelphia 3, Pa.
- ⓈGates Radio Co., Quincy, Ill.
- ⓈGENERAL ELECTRIC CO., Electronics Dept., Electronics Park, Syracuse, N. Y. ADV. PG. 1 to 22.
- ⓈHEINTZ & KAUFMAN EQUIPMENT DIV. OF THE ROBERT DOLLAR CO., 50 Drumm St., San Francisco 11, Calif. ADV. PG. 301.
- ⓈKaar Engineering Co., 2995 Middlefield Rd., P. O. Box 1320, Palo Alto, Calif.
- ⓈLink Radio Corp., 125 W. 17th St., New York, N. Y.
- ⓈMARCONI INSTRUMENTS, LTD., 23 Beaver St., New York 4, N. Y. ADV. PG. 270.
- ⓈMeasurement Engineering, Ltd., Arnprior, Ontario, Canada.
- ⓈMelpar, Inc., 552 Swann Ave., Alexandria, Va.
- ⓈMotorola, Inc., 4545 Augusta Blvd., Chicago 51, Ill.
- ⓈPress Wireless Mfg. Co., Inc., Cantiague Rd., Hicksville, N. Y.
- ⓈRADIO CORP. OF AMERICA, RCA Victor Div., General Offices, Camden, N. J. ADV. PG. 177, Inside Back & Back Covers.
- ⓈRadio Engineering Labs., Inc., 36-40 37th St., Long Island City, N. Y.
- ⓈSPERRY GYROSCOPE CO., Div. of The Sperry Corp., Great Neck, N. Y. ADV. PG. 103, 104.
- ⓈStandard Telephones & Cables Ltd., Connaught House, Aldwych, London, W. C. 2, England.
- ⓈTelemetering Associates, P. O. Box 6, Silver Spring, Md.
- ⓈWest Coast Electronics Co., 1601 S. Burlington St., Los Angeles 6, Calif.
- ⓈWESTINGHOUSE ELECTRIC CORP., 511 Wood St., P. O. Box 868, Pittsburgh 30, Pa. ADV. PG. 107-113.

TRANSMITTERS—Facsimile

- ⓈAcme Electronix Div. of NEA Service, Inc., West Third & Lakeside, Cleveland 13, Ohio.
- ⓈBARKER & WILLIAMSON, 235 Fairfield Ave., Upper Darby, Pa. ADV. PG. 292.
- ⓈBunnell & Co., J. H., 81 Prospect St., Brooklyn, N. Y.
- ⓈElectronic Surgical Equipment Co., Inc., N.E. Cor. 23 & Arch Sts., Philadelphia 3, Pa.
- ⓈHogan Laboratories, Inc., 155 Perry St., New York 14, N. Y.
- ⓈMcElroy Mfg. Corp., Littleton, Mass.
- ⓈMuirhead & Co., Ltd., Beckenham-Kent-England.
- ⓈPress Wireless Mfg. Co., Inc., Cantiague Rd., Hicksville, N. Y.
- ⓈSHERRON ELECTRONICS CO., 1201 Flushing Ave., Brooklyn 6, N. Y. ADV. PG. 145.
- ⓈStandard Telephones & Cables Ltd., Connaught House, Aldwych, London, W. C. 2, England.
- ⓈTIMES FACSIMILE CORP., 540 W. 58th St., New York 19, N. Y. ADV. PG. 288.
- ⓈWESTINGHOUSE ELECTRIC CORP., 511 Wood St., P. O. Box 868, Pittsburgh 30, Pa. ADV. PG. 107-113.

TRANSMITTERS—Fixed Frequency

- ⓈAeronautical Communications Equipment, Inc., 3090 Douglas Rd., Miami 33, Fla.
- ⓈAMERICAN ELECTROENGINEERING CORP., 5025-29 W. Jefferson Blvd., Los Angeles 16, Calif. ADV. PG. 136.
- ⓈBARKER & WILLIAMSON, 235 Fairfield Ave., Upper Darby, Pa. ADV. PG. 292.
- ⓈBassett, Inc., Rex, 307-311 N. W. First Ave., Fort Lauderdale, Fla.
- ⓈBelmont Radio Co., Div. Raytheon Mfg. Co., 5921 W. Dickens Ave., Chicago 39, Ill.
- ⓈBendix Radio Division, Bendix Aviation Corp., Baltimore 4, Md.
- ⓈCommunications Co., Inc., 300 Greco Ave., Coral Gables 34, Fla.
- ⓈCossor (Canada), Ltd., 301-303 Windsor St., Halifax, N. S., Canada.
- ⓈDoolittle Radio, Inc., 7421 S. Loomis Blvd., Chicago 36, Ill.
- ⓈElectronic Surgical Equipment Co., Inc., N.E. Cor. 23 & Arch Sts., Philadelphia 3, Pa.
- ⓈEL-TRONICS INC., 2649 No. Howard St., Philadelphia 33, Pa. ADV. PG. 299.
- ⓈErco Radio Labs., Inc., East Stewart Ave., Garden City, N. Y.
- ⓈGates Radio Co., Quincy, Ill.
- ⓈGENERAL ELECTRIC CO., Electronics Dept., Electronics Park, Syracuse, N. Y. ADV. PG. 1 to 22.
- ⓈHastings Instrument Co., Hampton 9, Va.
- ⓈHEINTZ & KAUFMAN EQUIPMENT DIV. OF THE ROBERT DOLLAR CO., 50 Drumm St., San Francisco 11, Calif. ADV. PG. 301.
- ⓈHose-McCann Telephone Co., Inc., 25th St. & 3rd Ave., Brooklyn 32, N. Y.
- ⓈIntervox Corp., 2701 California Ave., Seattle 6, Wash.
- ⓈKaar Engineering Co., 2995 Middlefield Rd., P. O. Box 1320, Palo Alto, Calif.
- ⓈMcMurdo Silver Co., Inc., 417 Lafayette St., New York, N. Y.
- ⓈMARCONI INSTRUMENTS, LTD., 23 Beaver St., New York 4, N. Y. ADV. PG. 270.
- ⓈMeasurement Engineering, Ltd., Arnprior, Ontario, Canada.
- ⓈMonarch Radio & Television Corp., 2430 Atlantic Ave., Brooklyn 33, N. Y.
- ⓈMotorola, Inc., 4545 Augusta Blvd., Chicago 51, Ill.
- ⓈPress Wireless Mfg. Co., Inc., Cantiague Rd., Hicksville, N. Y.
- ⓈRadio Engineering Laboratories, Inc., 36-40 37th St., Long Island City 1, N. Y.
- ⓈSierra Electronic Corp., San Carlos, Calif.
- ⓈSPERRY GYROSCOPE CO., Div. of The Sperry Corp., Great Neck, N. Y. ADV. PG. 103, 104.
- ⓈStandard Telephones & Cables Ltd., Connaught House, Aldwych, London, W. C. 2, England.
- ⓈTRAD TELEVISION CORP., 1001 First Ave., Asbury Park, N. J. ADV. PG. 355.
- ⓈTransmitter Equipment Mfg. Co., Inc., 345 Hudson St., New York 14, N. Y.
- ⓈWest Coast Electronics Co., 1601 S. Burlington St., Los Angeles 6, Calif.
- ⓈWilcox Electric Co., 1400 Chestnut St., Kansas City, Mo.

TRANSMITTERS—Fixed Station Communication

- ⓈAeronautical Communications Equipment, Inc., 3090 Douglas Rd., Miami 33, Fla.
- ⓈAMERICAN ELECTROENGINEERING CORP., 5025-29 W. Jefferson Blvd., Los Angeles 16, Calif. ADV. PG. 136.
- ⓈBARKER & WILLIAMSON, 235 Fairfield Ave., Upper Darby, Pa. ADV. PG. 292.
- ⓈBassett, Inc., Rex, 307-311 N. W. First Ave., Fort Lauderdale, Fla.
- ⓈBelmont Radio Co., Div. Raytheon Mfg. Co., 5921 W. Dickens Ave., Chicago 39, Ill.
- ⓈBendix Radio Division, Bendix Aviation Corp., Baltimore 4, Md.
- ⓈBunnell & Co., J. H., 81 Prospect St., Brooklyn, N. Y.
- ⓈCollins Radio Co., Cedar Rapids, Iowa.

V indicates . . . **IN PRODUCTION • AVAILABILITY • UNRESTRICTED FOR GENERAL USE**

- ☐ Communications Co., Inc., 300 Greco Ave., Coral Gables 34, Fla.
- ☐ Cossor (Canada) Ltd., 301-303 Windsor St., Halifax, N. S., Canada.
- ☐ CROSBY LABS., INC., 126 Herricks Rd., Mineola, N. Y. ADV. PG. 196.
- ☐ Doolittle Radio, Inc., 7421 S. Loomis Blvd., Chicago 36, Ill.
- ☐ Electronic Surgical Equipment Co., Inc., N.E. Cor. 23 & Arch Sts., Philadelphia 3, Pa.
- ☐ EL-TRONICS INC., 2649 N. Howard St., Philadelphia 33, Pa. ADV. PG. 299.
- ☐ Erco Radio Labs, Inc., East Stewart Ave., Garden City, N. Y.
- ☐ FEDERAL TELEPHONE AND RADIO CORP., 88 Kingsland Rd., Clifton, N. J. ADV. PG. 161-163.
- ☐ Gates Radio Co., Quincy, Ill.
- ☐ GENERAL ELECTRIC CO., Electronics Dept., Electronics Park, Syracuse, N. Y. ADV. PG. 1 to 22.
- ☐ HEINTZ & KAUFMAN EQUIPMENT DIV. OF THE ROBERT DOLLAR CO., 50 Drumm St., San Francisco 11, Calif. ADV. PG. 301.
- ☐ Intervox Corp., 2701 California Ave., Seattle 6, Wash.
- ☐ Kaar Engineering Co., 2995 Middlefield Rd., P. O. Box 1320, Palo Alto, Calif.
- ☐ Link Radio Corp., 125 W. 17th St., New York, N. Y.
- ☐ MARCONI INSTRUMENTS, LTD., 23 Beaver St., New York 4, N. Y. ADV. PG. 270.
- ☐ McElroy Mfg. Corp., Littleton, Mass.
- ☐ Measurement Engineering, Ltd., Arnprior, Ontario, Canada.
- ☐ Motorola, Inc., 4545 Augusta Blvd., Chicago 51, Ill.
- ☐ Press Wireless Mfg. Co., Inc., Cantiague Rd., Hicksville, N. Y.
- ☐ RADIO CORP. OF AMERICA, RCA Victor Div., General Offices, Camden, N. J. ADV. PG. 177, Inside Back & Back Covers.
- ☐ Radio Engineering Laboratories, Inc., 36-40 37th St., Long Island City 1, N. Y.
- ☐ Schuttig & Co., Inc., 9th & Kearny St. N. E., Washington 17, D. C.
- ☐ Sierra Electronic Corp., San Carlos, Calif.
- ☐ Standard Telephones & Cables Ltd., Connaught House, Aldwych, London, W. C. 2, England.
- ☐ Technical Materiel Corporation, The, P. O. Box 142, 121 Spencer Pl., Mamaroneck, N. Y.
- ☐ TRAD TELEVISION CORP., 1001 First Ave., Asbury Park, N. J. ADV. PG. 355.
- ☐ Transmitter Equipment Mfg. Co., Inc., 345 Hudson St., New York 14, N. Y.
- ☐ West Coast Electronics Co., 1601 S. Burlington St., Los Angeles 6, Calif.
- ☐ WESTINGHOUSE ELECTRIC CORP., 511 Wood St., P. O. Box 868, Pittsburgh 30, Pa. ADV. PG. 107-113.
- ☐ Wilcox Electric Co., 1400 Chestnut St., Kansas City, Mo.

TRANSMITTERS—Loran

- ☐ FEDERAL TELEPHONE AND RADIO CORP., 88 Kingsland Rd., Clifton, N. J. ADV. PG. 161-163.
- ☐ Radiomarine Corp. of America, 75 Varick St., New York 13, N. Y.
- ☐ Sierra Electronic Corp., San Carlos, Calif.
- ☐ SPERRY GYROSCOPE CO., Div. of The Sperry Corp., Great Neck, N. Y. ADV. PG. 103, 104.

TRANSMITTERS—Marine

- ☐ AIR ASSOCIATES, INC., Teterboro, N. J. ADV. PG. 211.
- ☐ Applied Electronics Co., 1246 Folsom St., San Francisco 3, Calif.
- ☐ BARKER & WILLIAMSON, 235 Fairfield Ave., Upper Darby, Pa. ADV. PG. 292.
- ☐ Bassett Inc., Rex, 307-311 N. W. First Ave., Fort Lauderdale, Fla.
- ☐ Bloodworth Marine Div., National-Simplex-Bludworth, Inc., 92 Gold St., New York 38, N. Y.
- ☐ Breco Electronics Corp., 55 Vandam St., New York 13, N. Y.
- ☐ Communications Co., Inc., 300 Greco Ave., Coral Gables 34, Fla.
- ☐ Erco Radio Labs, Inc., East Stewart Ave., Garden City, N. Y.
- ☐ Fisher Research Lab, Inc., 1961 University Ave., Palo Alto, Calif.
- ☐ GENERAL ELECTRIC CO., Electronics Dept., Electronics Park, Syracuse, N. Y. ADV. PG. 1 to 22.
- ☐ Gray Radio Co., 501 Forest Hill Blvd., West Palm Beach, Fla.
- ☐ Harvey-Wells Electronics Inc., North St., Southbridge, Mass.
- ☐ HEINTZ & KAUFMAN EQUIPMENT DIV. OF THE DOLLAR CO., 50 Drumm St., San Francisco 11, Calif. ADV. PG. 301.
- ☐ Hose-McCann Telephone Co., Inc., 25th St. & 3rd Ave., Brooklyn 32, N. Y.
- ☐ Intervox Corp., 2701 California Ave., Seattle 6, Wash.
- ☐ Jefferson, Inc., Ray, 40 E. Merrick Road, Freeport, N. Y.
- ☐ Kaar Engineering Co., 2995 Middlefield Rd., P. O. Box 1320, Palo Alto, Calif.
- ☐ MARCONI INSTRUMENTS, LTD., 23 Beaver St., New York 4, N. Y. ADV. PG. 270.

- ☐ McMurdo Silver Co., Inc., 417 Lafayette St., New York, N. Y.
- ☐ Measurement Engineering, Ltd., Arnprior, Ontario, Canada.
- ☐ Munston Mfg. & Service Co., Inc., Beech St., Islip, N. Y.
- ☐ Press Wireless Mfg. Co., Inc., Cantiague Rd., Hicksville, N. Y.
- ☐ Radiomarine Corp. of America, 75 Varick St., New York 13, N. Y.
- ☐ Standard Electronics Corp., 25 W. 43rd St., New York 18, N. Y.
- ☐ Standard Telephones & Cables Ltd., Connaught House, Aldwych, London, W. C. 2, England.
- ☐ TRAD TELEVISION CORP., 1001 First Ave., Asbury Park, N. J. ADV. PG. 355.
- ☐ WESTINGHOUSE ELECTRIC CORP., 511 Wood St., P. O. Box 868, Pittsburgh 30, Pa. ADV. PG. 107-113.

TRANSMITTERS—Microwave

- ☐ AIR ASSOCIATES, INC., Teterboro, N. J. ADV. PG. 211.
- ☐ AMERICAN ELECTROENGINEERING CORP., 5025-29 W. Jefferson Blvd., Los Angeles 16, Calif. ADV. PG. 136.
- ☐ BOGUE ELECTRIC MFG. CO., 52 Iowa Ave., Paterson 3, N. J. ADV. PG. 155.
- ☐ Bunnell & Co., J. H., 81 Prospect St., Brooklyn, N. Y.
- ☐ FEDERAL TELEPHONE AND RADIO CORP., 88 Kingsland Rd., Clifton, N. J. ADV. PG. 161-163.
- ☐ GENERAL ELECTRIC CO., Electronics Dept., Electronics Park, Syracuse, N. Y. ADV. PG. 1 to 22.
- ☐ Link Radio Corp., 125 W. 17th St., New York, N. Y.
- ☐ McMurdo Silver Co., Inc., 417 Lafayette St., New York, N. Y.
- ☐ Microwave Equipment Co., Inc., North Caldwell, N. J.
- ☐ Motorola, Inc., 4545 Augusta Blvd., Chicago 51, Ill.
- ☐ POLYTECHNIC RESEARCH & DEVELOPMENT CO., INC., 202 Tillary St., Brooklyn 1, N. Y. ADV. PG. 172, 173.
- ☐ Press Wireless Mfg. Co., Inc., Cantiague Rd., Hicksville, N. Y.
- ☐ Radio Engineering Laboratories, Inc., 36-40 37th St., Long Island City 1, N. Y.
- ☐ SPERRY GYROSCOPE CO., Div. of The Sperry Corp., Great Neck, N. Y. ADV. PG. 103, 104.
- ☐ Standard Telephones & Cables Ltd., Connaught House, Aldwych, London, W. C. 2, England.
- ☐ Transmitter Equipment Mfg. Co., Inc., 345 Hudson St., New York 14, N. Y.
- ☐ WESTINGHOUSE ELECTRIC CORP., 511 Wood St., P. O. Box 868, Pittsburgh 30, Pa. ADV. PG. 107-113.

TRANSMITTERS—Portable and Mobile Radio-telephone

- ☐ AIR ASSOCIATES, INC., Teterboro, N. J. ADV. PG. 211.
- ☐ AMERICAN ELECTROENGINEERING CORP., 5025-29 W. Jefferson Blvd., Los Angeles 16, Calif. ADV. PG. 136.
- ☐ BARKER & WILLIAMSON, 235 Fairfield Ave., Upper Darby, Pa. ADV. PG. 292.
- ☐ Bassett Inc., Rex, 307-311 N. W. First Ave., Fort Lauderdale, Fla.
- ☐ Belmont Radio Co., Div. Raytheon Mfg. Co., 5921 Dickens Ave., Chicago 39, Ill.
- ☐ Bendix Radio Division, Bendix Aviation Corp., Baltimore 4, Md.
- ☐ Breco Electronics Corp., 55 Vandam St., New York 13, N. Y.
- ☐ Bunnell & Co., J. H., 81 Prospect St., Brooklyn, N. Y.
- ☐ Capehart-Farnsworth Corp., Fort Wayne, Indiana.
- ☐ Communications Co., Inc., 300 Greco Ave., Coral Gables 34, Fla.
- ☐ Doolittle Radio, Inc., 7421 S. Loomis Blvd., Chicago 36, Ill.
- ☐ Electro Craft, Inc., 52 Davenport St., Stamford, Conn.
- ☐ Electronic Surgical Equipment Co., Inc., N.E. Cor. 23 & Arch Sts., Philadelphia 3, Pa.
- ☐ EL-TRONICS INC., 2649 N. Howard St., Philadelphia 33, Pa. ADV. PG. 238, 299.
- ☐ GENERAL ELECTRIC CO., Electronics Dept., Electronics Park, Syracuse, N. Y. ADV. PG. 1 to 22.
- ☐ HEINTZ & KAUFMAN EQUIPMENT DIV. OF THE ROBERT DOLLAR CO., 50 Drumm St., San Francisco 11, Calif. ADV. PG. 301.
- ☐ Kaar Engineering Co., 2995 Middlefield Rd., P. O. Box 1320, Palo Alto, Calif.
- ☐ Link Radio Corp., 125 W. 17th St., New York, N. Y.
- ☐ McMurdo Silver Co., Inc., 417 Lafayette St., New York, N. Y.
- ☐ MARCONI INSTRUMENTS, LTD., 23 Beaver St., New York 4, N. Y. ADV. PG. 270.
- ☐ Measurement Engineering, Ltd., Arnprior, Ontario, Canada.
- ☐ Motorola, Inc., 4545 Augusta Blvd., Chicago 51, Ill.
- ☐ RADIO CORP. OF AMERICA, RCA Victor Div., General Offices, Camden, N. J. ADV. PG. 177, Inside Back & Back Covers.

- ☐ Radio Engineering Laboratories, Inc., 36-40 37th St., Long Island City 1, N. Y.
- ☐ Radiomarine Corp. of America, 75 Varick St., New York 13, N. Y.
- ☐ Schuttig & Co., Inc., 9th & Kearny Sts., N. E., Washington 17, D. C.
- ☐ Stephens Mfg. Corp., 8538 Warner Drive, Culver City, Calif.
- ☐ TRAD TELEVISION CORP., 1001 First Ave., Asbury Park, N. J. ADV. PG. 355.
- ☐ Transmitter Equipment Mfg. Co., Inc., 345 Hudson St., New York 14, N. Y.
- ☐ West Coast Electronics Co., 1601 S. Burlington Ave., Los Angeles 6, Calif.
- ☐ WESTINGHOUSE ELECTRIC CORP., 511 Wood St., P. O. Box 868, Pittsburgh 30, Pa. ADV. PG. 107-113.

TRANSMITTERS—Pulse Time Modulation

- ☐ AMERICAN ELECTROENGINEERING CORP., 5025-29 W. Jefferson Blvd., Los Angeles 16, Calif. ADV. PG. 136.
- ☐ FEDERAL TELECOMMUNICATION LABS., INC., 500 Washington Ave., Nutley, N. J. ADV. PG. 164.
- ☐ FEDERAL TELEPHONE AND RADIO CORP., 88 Kingsland Rd., Clifton, N. J. ADV. PG. 161-163.
- ☐ Sierra Electronic Corp., San Carlos, Calif.

TRANSMITTERS—Radar

- ☐ AIR ASSOCIATES, INC., Teterboro, N. J. ADV. PG. 211.
- ☐ Avion Instrument Corp., Paramus, N. J.
- ☐ Bendix Radio Division, Bendix Aviation Corp., Baltimore 4, Md.
- ☐ Bunnell & Co., J. H., 81 Prospect St., Brooklyn, N. Y.
- ☐ Cossor (Canada) Ltd., 301-303 Windsor St., Halifax, N. S., Canada.
- ☐ FEDERAL TELEPHONE AND RADIO CORP., 88 Kingsland Rd., Clifton, N. J. ADV. PG. 161-163.
- ☐ Gaveco Labs, Inc., 2 East End Ave., New York 21, N. Y.
- ☐ GENERAL ELECTRIC CO., Electronics Dept., Electronics Park, Syracuse, N. Y. ADV. PG. 1 to 22.
- ☐ MARCONI INSTRUMENTS, LTD., 23 Beaver St., New York 4, N. Y. ADV. PG. 270.
- ☐ Motorola, Inc., 4545 Augusta Blvd., Chicago 51, Ill.
- ☐ Press Wireless Mfg. Co., Inc., Cantiague Rd., Hicksville, N. Y.
- ☐ Radiomarine Corp. of America, 75 Varick St., New York 13, N. Y.
- ☐ SPERRY GYROSCOPE CO., Div. of The Sperry Corp., Great Neck, N. Y. ADV. PG. 103, 104.
- ☐ Transmitter Equipment Mfg. Co., Inc., 345 Hudson St., New York 14, N. Y.
- ☐ Varian Associates, 99 Washington St., San Carlos, Calif.
- ☐ WESTINGHOUSE ELECTRIC CORP., 511 Wood St., P. O. Box 868, Pittsburgh 30, Pa. ADV. PG. 107-113.

TRANSMITTERS—Radio Range

- ☐ AIR ASSOCIATES, INC., Teterboro, N. J. ADV. PG. 211.
- ☐ Bassett, Inc., Rex, 307-311 N.W. First Ave., Fort Lauderdale, Fla.
- ☐ Bunnell & Co., J. H., 81 Prospect St., Brooklyn, N. Y.
- ☐ FEDERAL TELEPHONE AND RADIO CORP., 88 Kingsland Rd., Clifton, N. J. ADV. PG. 161-163.
- ☐ H. M. R. Electronics, Inc., Grove St., New Canaan, Conn.
- ☐ LAVOIE LABORATORIES, Morganville, N. J. ADV. PG. 206.
- ☐ MARCONI INSTRUMENTS, LTD., 23 Beaver St., New York 4, N. Y. ADV. PG. 270.
- ☐ Maryland Electronic Mfg. Corp., 5009 Calvert Rd., College Park, Md.
- ☐ Transmitter Equipment Mfg. Co., Inc., 345 Hudson St., New York 14, N. Y.
- ☐ WESTINGHOUSE ELECTRIC CORP., 511 Wood St., P. O. Box 868, Pittsburgh 30, Pa. ADV. PG. 107-113.

TRANSMITTERS—Railroad

- ☐ Bassett, Inc., Rex, 307-311 N.W. First Ave., Fort Lauderdale, Fla.
- ☐ Bendix Radio Division, Bendix Aviation Corp., Baltimore 4, Md.
- ☐ Capehart-Farnsworth Corp., Fort Wayne, Indiana.
- ☐ Communications Co., Inc., 300 Greco Ave., Coral Gables 34, Fla.
- ☐ Doolittle Radio, Inc., 7421 S. Loomis Blvd., Chicago 36, Ill.
- ☐ FEDERAL TELEPHONE & RADIO CORP., 88 Kingsland Rd., Clifton, N. J. ADV. PG. 161-163.
- ☐ Motorola, Inc., 4545 Augusta Blvd., Chicago 51, Ill.
- ☐ Radio Engineering Laboratories, Inc., 36-40 37th St., Long Island City 1, N. Y.
- ☐ West Coast Electronics Co., 1601 S. Burlington St., Los Angeles 6, Calif.
- ☐ WESTINGHOUSE ELECTRIC CORP., 511 Wood St., P. O. Box 868, Pittsburgh 30, Pa. ADV. PG. 107-113.

V indicates . . . IN PRODUCTION • AVAILABILITY • UNRESTRICTED FOR GENERAL USE

TRANSMITTERS—Television

- Ⓞ DuMont Laboratories, Inc., Allen B., Television Transmitter Div., 1000 Main Ave., Clifton, N. J.
- Ⓞ FEDERAL TELECOMMUNICATION LABS., INC., 500 Washington Ave., Nutley 4, N. J. ADV. PG. 164.
- Ⓞ FEDERAL TELEPHONE & RADIO CORP., 88 Kingsland Rd., Clifton, N. J. ADV. PG. 161-163.
- Ⓞ Gates Radio Co., Quincy, Ill.
- Ⓞ GENERAL ELECTRIC CO., Electronics Dept., Electronics Park, Syracuse, N. Y. ADV. PG. 1 to 22.
- Ⓞ MARCONI INSTRUMENTS, LTD., 23 Beaver St., New York 4, N. Y. ADV. PG. 270.
- Ⓞ RADIO CORP. OF AMERICA, RCA Victor Div., General Offices, Camden, N. J. ADV. PG. 177, Inside Back & Back Covers.
- Ⓞ Standard Electronics Corp., 25 W. 43rd St., New York 18, N. Y.
- Ⓞ Standard Telephones & Cables Ltd., Connaught House, Aldwych, London, W. C. 2, England.
- Ⓞ Telchrome, Inc., 88 Merrick Rd., Amityville, N. Y.

TRANSMITTERS—uhf

- Ⓞ AIR ASSOCIATES, INC., Teterboro, N. J. ADV. PG. 211.
- Ⓞ AMERICAN ELECTRONEERING CORP., 5025-29 W. Jefferson Blvd., Los Angeles 16, Calif. ADV. PG. 136.
- Ⓞ BARKER & WILLIAMSON, 235 Fairfield Ave., Upper Darby, Pa. ADV. PG. 292.
- Ⓞ Bassett, Inc., Rex, 307-311 N. W. First Ave., Fort Lauderdale, Fla.
- Ⓞ Bunnell & Co., J. H., 81 Prospect St., Brooklyn, N. Y.
- Ⓞ Electro Craft, Inc., 52 Davenport St., Stamford, Conn.
- Ⓞ FEDERAL TELEPHONE & RADIO CORP., 88 Kingsland Rd., Clifton, N. J. ADV. PG. 161-163.
- Ⓞ Gates Radio Co., Quincy, Ill.
- Ⓞ GENERAL ELECTRIC CO., Electronics Dept., Electronics Park, Syracuse, N. Y. ADV. PG. 1 to 22.
- Ⓞ McMurdo Silver Co., Inc., 417 Lafayette St., New York, N. Y.
- Ⓞ MARCONI INSTRUMENTS, LTD., 23 Beaver St., New York 4, N. Y. ADV. PG. 270.
- Ⓞ Motorola, Inc., 4545 Augusta Blvd., Chicago 51, Ill.
- Ⓞ NATIONAL CO., INC., 61 Sherman St., Malden 49, Mass. ADV. PG. 280, 281.
- Ⓞ Press Wireless Mfg. Co., Inc., Cantiague Rd., Hicksville, N. Y.
- Ⓞ Radio Engineering Labs., Inc., 36-40 37th St., Long Island City 1, N. Y.
- Ⓞ Radiomarine Corp. of America, 75 Varick St., New York 13, N. Y.
- Ⓞ Rosen Engineering Products, Inc., Raymond, 32nd & Walnut Sts., Philadelphia 4, Pa.
- Ⓞ Sierra Electronic Corp., San Carlos, Calif.
- Ⓞ Standard Telephone & Cables Ltd., Connaught House, Aldwych, London, W. C. 2, England.
- Ⓞ Transmitter Equipment Mfg. Co., Inc., 345 Hudson St., New York 14, N. Y.
- Ⓞ West Coast Electronics Co., 1601 S. Burlington St., Los Angeles 6, Calif.
- Ⓞ WESTINGHOUSE ELECTRIC CORP., 511 Wood St., P. O. Box 868, Pittsburgh 30, Pa. ADV. PG. 107-113.
- Ⓞ Wilcox Electric Co., 1400 Chestnut St., Kansas City, Missouri.

TRANSMITTERS—vhf

- Ⓞ Aeronautical Communications Equipment, Inc., 3090 Douglas Rd., Miami 33, Fla.
- Ⓞ AIR ASSOCIATES, INC., Teterboro, N. J. ADV. PG. 211.
- Ⓞ AIRCRAFT RADIO CORP., Boonton, N. J. ADV. PG. 400, 401.
- Ⓞ AMERICAN ELECTRONEERING CORP., 5025-29 W. Jefferson Blvd., Los Angeles 16, Calif. ADV. PG. 136.
- Ⓞ Bassett, Inc., Rex, 307-311 N.W. First Ave., Fort Lauderdale, Fla.
- Ⓞ Bendix Radio Division, Bendix Aviation Corp., Baltimore 4, Md.
- Ⓞ Bunnell & Co., J. H., 81 Prospect St., Brooklyn, N. Y.
- Ⓞ Capehart-Farnsworth Corp., Fort Wayne, Indiana.
- Ⓞ Collins Radio Co., Cedar Rapids, Iowa.
- Ⓞ Communications Co., 300 Greco Ave., Coral Gables 34, Fla.
- Ⓞ Electronic Specialty Co., 3456 Glendale Blvd., Los Angeles 39, Calif.
- Ⓞ Erco Radio Labs., Inc., East Stewart Ave., Garden City, N. Y.
- Ⓞ FEDERAL TELEPHONE & RADIO CORP., 88 Kingsland Rd., Clifton, N. J. ADV. PG. 161-163.
- Ⓞ Gates Radio Co., Quincy, Ill.
- Ⓞ GENERAL ELECTRIC CO., Electronics Dept., Electronics Park, Syracuse, N. Y. ADV. PG. 1 to 22.
- Ⓞ HEINTZ & KAUFMAN EQUIPMENT DIV. OF THE ROBERT DOLLAR CO., 50 Drumm St., San Francisco 11, Calif. ADV. PG. 301.
- Ⓞ Kaer Engineering Co., 2995 Middlefield Rd., P. O. Box 1320, Palo Alto, Calif.
- Ⓞ Lear, Inc., 110 Ionia Ave., N.W., Grand Rapids 2, Mich.
- Ⓞ Link Radio Corp., 125 W. 17th St., New York, N. Y.
- Ⓞ McMurdo Silver Co., Inc., 417 Lafayette St., New York, N. Y.
- Ⓞ MARCONI INSTRUMENTS, LTD., 23 Beaver St., New York 4, N. Y. ADV. PG. 270.

- Ⓞ Measurement Engineering, Ltd., Arnprior, Ontario, Canada.
- Ⓞ Melpar, Inc., 552 Swann Ave., Alexandria, Va.
- Ⓞ MITCHELL INDUSTRIES, INC., Camp Wolters, Mineral Wells, Texas. ADV. PG. 298.
- Ⓞ Motorola, Inc., 4545 Augusta Blvd., Chicago 51, Ill.
- Ⓞ NATIONAL CO., INC., 61 Sherman St., Malden 49, Mass. ADV. PG. 280, 281.
- Ⓞ Press Wireless Mfg. Co., Inc., Cantiague Rd., Hicksville, N. Y.
- Ⓞ Radio Engineering Labs., Inc., 36-40 37th St., Long Island City 1, N. Y.
- Ⓞ Radiomarine Corp. of America, 75 Varick St., New York 13, N. Y.
- Ⓞ Rosen Engineering Products, Inc., Raymond, 32nd & Walnut Sts., Philadelphia 4, Pa.
- Ⓞ Sierra Electronic Corp., San Carlos, Calif.
- Ⓞ Standard Telephone & Cables Ltd., Connaught House, Aldwych, London, W. C. 2, England.
- Ⓞ Transmitter Equipment Mfg. Co., Inc., 345 Hudson St., New York 14, N. Y.
- Ⓞ West Coast Electronics Co., 1601 S. Burlington St., Los Angeles 6, Calif.
- Ⓞ WESTINGHOUSE ELECTRIC CORP., 511 Wood St., P. O. Box 868, Pittsburgh 30, Pa. ADV. PG. 107-113.
- Ⓞ Wilcox Electric Co., 1400 Chestnut St., Kansas City, Missouri.

TRAPS—Wave

- Ⓞ BARKER & WILLIAMSON, 235 Fairfield Ave., Upper Darby, Pa. ADV. PG. 292.
- Ⓞ Bud Radio, Inc., 2118 E. 55th St., Cleveland 3, Ohio.
- Ⓞ COILCRAFT, INC., 3716 N. Cicero Ave., Chicago 41, Ill. ADV. PG. 360.
- Ⓞ HILLBURN ELECTRONIC PRODUCTS CO., 55 Nassau Ave., Brooklyn 22, N. Y. ADV. PG. 362.
- Ⓞ KINGS MICROWAVE CO., INC., 50 Marbledale Rd., Tuckahoe 7, N. Y. ADV. PG. 178, 179.
- Ⓞ Lynmar Engineers, Inc., 1721 Delancey St., Philadelphia 13, Pa.
- Ⓞ Millen Mfg. Co., James, 150 Exchange St., Malden, Mass.
- Ⓞ Miller Co., J. W., 5917 S. Main St., Los Angeles 3, Calif.
- Ⓞ Philco Corp., Tioga & C Sts., Philadelphia 34, Pa.
- Ⓞ Sickles Co., F. W., 165 Front St., Chicopee, Mass.
- Ⓞ STANDARD COIL PRODUCTS CO., 2329 N. Pulaski Rd., Chicago 39, Ill. ADV. PG. 97.
- Ⓞ Teleradio Engineering Corp., 99 Wall St., New York, N. Y.
- Ⓞ U. S. ELECTRONICS CORP., 276 Warren St., Lyndhurst, N. J. ADV. PG. 76.
- Ⓞ WESTINGHOUSE ELECTRIC CORP., 511 Wood St., P. O. Box 868, Pittsburgh 30, Pa. ADV. PG. 107-113.

TRIMMERS—Capacitors

See Capacitors

TUBE PARTS

Anodes, Carbon

- Ⓞ NATIONAL CARBON CO., Division of Union Carbide & Carbon Corp., 30 E. 42nd St., New York 17, N. Y. ADV. PG. 42.
- Ⓞ Speer Carbon Co., Lincoln Ave., St. Marys, Pa.
- Ⓞ STACKPOLE CARBON CO., St. Marys, Pa. ADV. PG. 170, 171.
- Ⓞ SYLVANIA ELECTRIC PRODUCTS, INC., 1740 Broadway, New York 19, N. Y. ADV. PG. 432-436.
- Ⓞ WESTINGHOUSE ELECTRIC CORP., 511 Wood St., P. O. Box 868, Pittsburgh 30, Pa. ADV. PG. 107-113.

Anodes, Gold

- Ⓞ Eastern Smelting & Refining Corp., 107-109 W. Brookline St., Boston 18, Mass.
- Ⓞ GENERAL PLATE DIVISION, Metals & Controls Corp., Attleboro, Mass. ADV. PG. 300.
- Ⓞ Handy & Harman, 82 Fulton St., New York 38, N. Y.
- Ⓞ HAYDU BROTHERS, Plainfield, N. J. ADV. PG. 55.
- Ⓞ NEY CO., J. M., 179 Elm St., Hartford, Conn. ADV. PG. 246.
- Ⓞ Standard Metals Corp., 262 Broad St., North Attleboro, Mass.
- Ⓞ SYLVANIA ELECTRIC PRODUCTS, INC., 1740 Broadway, New York 19, N. Y. ADV. PG. 432-436.
- Ⓞ Western Gold & Platinum Works, 589 Bryant St., San Francisco, Calif.
- Ⓞ Wildberg Bros., Smelting & Refining Co., 742 Market St., San Francisco 2, Calif.

Anodes, Graphite

- Ⓞ NATIONAL CARBON CO., Division of Union Carbide & Carbon Corp., 30 E. 42nd St., New York 17, N. Y. ADV. PG. 42.
- Ⓞ Speer Carbon Co., Lincoln Ave., St. Marys, Pa.

- Ⓞ STACKPOLE CARBON CO., St. Marys, Pa. ADV. PG. 170, 171.
- Ⓞ SYLVANIA ELECTRIC PRODUCTS, INC., 1740 Broadway, New York 19, N. Y. ADV. PG. 432-436.

Anodes, Metal

- Ⓞ Aluminum Co. of America, Gulf Bldg., Pittsburgh 30, Pa.
- Ⓞ ART WIRE & STAMPING CO., 227 High St., Newark 2, N. J. ADV. PG. 38.
- Ⓞ Eitel-McCullough, Inc., San Bruno, Calif.
- Ⓞ Elm Laboratories, 18 South Broadway, Dobbs Ferry, N. Y.
- Ⓞ Fansteel Metallurgical Corp., 2200 Sheridan Road, North Chicago, Ill.
- Ⓞ FEDERAL TELEPHONE & RADIO CORP., 88 Kingsland Rd., Clifton, N. J. ADV. PG. 161-163.
- Ⓞ HAYDU BROTHERS, Plainfield, N. J. ADV. PG. 55.
- Ⓞ JOHNSON & HOFFMAN INC., 65 Ongley St., Rockville Center, L. I., N. Y. ADV. PG. 353.
- Ⓞ RADIO CORP. OF AMERICA, Tube Dept., Harrison, N. J. ADV. PG. 177, Inside Back and Back Covers.
- Ⓞ STAVER CO., INC., Box 431, Bayshore, N. Y. ADV. PG. 232.
- Ⓞ SUPERIOR TUBE CO., 2504 Germantown Pike, Norristown, Pa. ADV. PG. 64, 65.
- Ⓞ SYLVANIA ELECTRIC PRODUCTS, INC., 1740 Broadway, New York 19, N. Y. ADV. PG. 432-436.
- Ⓞ WESTINGHOUSE ELECTRIC CORP., 511 Wood St., P. O. Box 868, Pittsburgh 30, Pa. ADV. PG. 107-113.

Anodes, Metallized Graphite

- Ⓞ HAYDU BROTHERS, Plainfield, N. J. ADV. PG. 55.
- Ⓞ Speer Carbon Co., Lincoln Ave., St. Marys, Pa.
- Ⓞ STACKPOLE CARBON CO., St. Marys, Pa. ADV. PG. 170, 171.
- Ⓞ SYLVANIA ELECTRIC PRODUCTS, INC., 1740 Broadway, New York 19, N. Y. ADV. PG. 432-436.

Anodes, Silver

- Ⓞ Eastern Smelting & Refining Corp., 108-109 W. Brookline St., Boston 18, Mass.
- Ⓞ GENERAL PLATE DIVISION, Metals & Controls Corp., Attleboro, Mass. ADV. PG. 300.
- Ⓞ Handy & Harman, 82 Fulton St., New York 38, N. Y.
- Ⓞ HAYDU BROTHERS, Plainfield, N. J. ADV. PG. 55.
- Ⓞ IMPROVED SEAMLESS WIRE CO., 775 Eddy St., Providence, R. I. ADV. PG. 314.
- Ⓞ NEY CO., J. M., 179 Elm St., Hartford, Conn. ADV. PG. 246.
- Ⓞ SYLVANIA ELECTRIC PRODUCTS, INC., 1740 Broadway, New York 19, N. Y. ADV. PG. 432-436.
- Ⓞ Western Gold & Platinum Works, 589 Bryant St., San Francisco, Calif.
- Ⓞ Wildberg Bros. Smelting & Refining Co., 742 Market St., San Francisco 2, Calif.

Base Pins

- Ⓞ AMERICAN BRASS CO., 25 Broadway, New York 4, N. Y. ADV. PG. 330.
- Ⓞ ART WIRE AND STAMPING CO., 22 High Street, Newark 2, N. J. ADV. PG. 38.
- Ⓞ BEAD CHAIN MFG. CO., 110 Mountain Grove St., Bridgeport 5, Conn. ADV. PG. 136.
- Ⓞ GENERAL ACCESSORIES CO., LTD., 366 Madison Ave., New York 17, N. Y. ADV. PG. 336.
- Ⓞ Greene Mfg. Corp., G. G. Warren, Pa.
- Ⓞ HAYDU BROTHERS, Plainfield, N. J. ADV. PG. 55.
- Ⓞ Isolantite Mfg. Corp., Stirling, N. J.
- Ⓞ Javex, 921 State, Garland, Texas.
- Ⓞ RADIO CORP. OF AMERICA, Tube Dept., Harrison, N. J. ADV. PG. 177, Inside Back and Back Cover.
- Ⓞ SYLVANIA ELECTRIC PRODUCTS, INC., 1740 Broadway, New York 19, N. Y. ADV. PG. 432-436.
- Ⓞ Vekar Corp., 7300 Huron River Drive, Dexter, Mich.
- Ⓞ WESTINGHOUSE ELECTRIC CORP., 511 Wood St., P. O. Box 868, Pittsburgh 30, Pa. ADV. PG. 107-113.

Bases

- Ⓞ ALDEN PRODUCTS CO., 117 No. Main St., Brockton 64, Mass. ADV. PG. 327.
- Ⓞ AMERICAN LAVA CORP., Chattanooga, 5, Tenn. ADV. PG. 143.
- Ⓞ CROWLEY & CO., INC., HENRY L., 1 Central Ave., West Orange, N. J. ADV. PG. 231.
- Ⓞ Electronic Mfg. Co., 20 Orange St., Newark, N. J.
- Ⓞ ENGINEERING CO., 27 Wright St., Newark, N. J. ADV. PG. 370.
- Ⓞ GENERAL ACCESSORIES CO., LTD., 366 Madison Ave., New York 17, N. Y. ADV. PG. 336.
- Ⓞ Greene Mfg. Corp., G. G. Warren, Pa.
- Ⓞ Owens-Illinois Glass Co., Toledo, Ohio.
- Ⓞ RADIO CORP. OF AMERICA, Tube Dept., Harrison, N. J. ADV. PG. 177, Inside Back & Back Covers.

V indicates . . . IN PRODUCTION • AVAILABILITY • UNRESTRICTED FOR GENERAL USE

- Ⓞ SHAW INSULATOR CO., 160 Colt St., Irvington 11, N. J. ADV. PG. 358.
- Ⓞ Steward Mfg. Co., D. M. 3600 Jerrome Ave., Chattanooga 1, Tenn.
- Ⓞ SYLVANIA ELECTRIC PRODUCTS, INC., 1740 Broadway, New York 19, N. Y. ADV. PG. 432-436.
- Ⓞ TEFLON PRODUCTS DIVISION, U. S. GASKET CO., P. O. Box 93, Camden, N. J. ADV. PG. 176.
- Ⓞ THOR CERAMICS INC., 225 Belleville Ave., Bloomfield, N. J. ADV. PG. 378.
- Ⓞ WESTINGHOUSE ELECTRIC CORP., 511 Wood St., P. O. Box 868, Pittsburgh 30, Pa. ADV. PG. 107-113.

Bulbs & Envelopes

- Ⓞ CORNING GLASS WORKS, Corning, N. Y. ADV. PG. 373.

Caps

- Ⓞ ALDEN PRODUCTS CO., 117 No. Main St., Brockton 64, Mass. ADV. PG. 327.
- Ⓞ AMERICAN LAVA CORP., Chattanooga 5, Tenn. ADV. PG. 143.
- Ⓞ Electronic Mfg. Co., 20 Orange St., Newark, N. J.
- Ⓞ ENGINEERING CO., 27 Wright St., Newark, N. J. ADV. PG. 370.
- Ⓞ Goat Co., Inc., Fred, 314 Dean St., Brooklyn, New York.
- Ⓞ HAYDU BROTHERS, Plainfield, N. J. ADV. PG. 55.
- Ⓞ SYLVANIA ELECTRIC PRODUCTS, INC., 1740 Broadway, New York 19, N. Y. ADV. PG. 432-436.

Cathode Ray Tube Powders

- Ⓞ RADIO CORP. OF AMERICA, Tube Dept., Harrison, N. J. ADV. PG. 177, Inside Back & Back Covers.
- Ⓞ SYLVANIA ELECTRIC PRODUCTS, INC., 1740 Broadway, New York 19, N. Y. ADV. PG. 432-436.
- Ⓞ U. S. Radium Corp., 535 Pearl St., New York 7, N. Y.

Cathode Ray Tube Side Contacts

- Ⓞ RADIO CORP. OF AMERICA, Tube Dept., Harrison, N. J. ADV. PG. 177, Inside Back & Back Covers.
- Ⓞ TEL-O-TUBE CORP. OF AMERICA, Paterson, N. J. ADV. PG. 142.

Cathode Sleeves and Tubes

- Ⓞ AMERICAN LAVA CORP., Chattanooga 5, Tenn. ADV. PG. 143.
- Ⓞ CROWLEY & CO., INC., HENRY L., 1 Central Ave., West Orange, N. J. ADV. PG. 231.
- Ⓞ RADIO CORP. OF AMERICA, Tube Dept., Harrison, N. J. ADV. PG. 177, Inside Back & Back Covers.
- Ⓞ SUPERIOR TUBE CO., 2504 Germantown Pike, Norristown, Pa. ADV. PG. 64, 65.
- Ⓞ SYLVANIA ELECTRIC PRODUCTS, INC., 1740 Broadway, New York 19, N. Y. ADV. PG. 432-436.

Conductive Paints

See Paints, Conductive

Filament Wire

- Ⓞ Alloy Metal Wire Co., 13th & Penna. Ave., Prospect Park, Pa.
- Ⓞ Birnback Radio Co., Inc., 145 Hudson St., New York, N. Y.
- Ⓞ North American Philips Co., Inc., 100 E. 42nd St., New York 17, N. Y.
- Ⓞ RADIO CORP. OF AMERICA, Tube Dept., Harrison, N. J. ADV. PG. 177, Inside Back & Back Covers.
- Ⓞ Seccon Metals Corp., 228 E. 45th St., New York 17, N. Y.
- Ⓞ SYLVANIA ELECTRIC PRODUCTS, INC., 1740 Broadway, New York 19, N. Y. ADV. PG. 432-436.
- Ⓞ WESTINGHOUSE ELECTRIC CORP., 511 Wood St., P. O. Box 868, Pittsburgh 30, Pa. ADV. PG. 107-113.
- Ⓞ Wildberg Bros. Smelting & Refining Co., 742 Market St., San Francisco 2, Calif.

Getters

- Ⓞ ART WIRE & STAMPING CO., 227 High St., Newark 2, N. J. ADV. PG. 38.
- Ⓞ Kemet Co. a Division of Union Carbide & Carbon Corp., Madison Ave. & 117th St., Cleveland 1, Ohio.
- Ⓞ KING LABORATORIES INC., 127 Solar St., Syracuse 4, N. Y. ADV. PG. 395.
- Ⓞ RADIO CORP. OF AMERICA, Tube Dept., Harrison, N. J. ADV. PG. 177, Inside Back & Back Covers.
- Ⓞ SYLVANIA ELECTRIC PRODUCTS, INC., 1740 Broadway, New York 19, N. Y. ADV. PG. 432-436.

Grids and Supports

- Ⓞ AMERICAN LAVA CORP., Chattanooga 5, Tenn. ADV. PG. 143.
- Ⓞ ART WIRE & STAMPING CO., 227 High St., Newark 2, N. J. ADV. PG. 38.

- Elm Laboratories, 18 South Broadway, Dobbs Ferry, N. Y.
- Ⓞ Goat Co., Inc., Fred, 314 Dean St., Brooklyn, N. Y.
- Ⓞ HAYDU BROTHERS, Plainfield, N. J. ADV. PG. 55.
- Ⓞ HOBSON BROTHERS, 4049 W. Fullerton St., Chicago 39, Ill. ADV. PG. 322.
- Ⓞ Murex, Ltd., Rainham, Essex, England.
- Ⓞ NATIONAL CARBON CO., Division of Union Carbide & Carbon Corp., 30 E. 42nd St., New York 17, N. Y. ADV. PG. 42.
- Ⓞ PIX MFG. CO., INC., 24 Bedford St., Newark, N. J. ADV. PG. 136.
- Ⓞ RADIO CORP. OF AMERICA, Tube Dept., Harrison, N. J. ADV. PG. 177, Inside Back & Back Covers.
- Ⓞ SYLVANIA ELECTRIC PRODUCTS, INC., 1740 Broadway, New York 19, N. Y. ADV. PG. 432-436.
- Ⓞ WESTINGHOUSE ELECTRIC CORP., 511 Wood St., P. O. Box 868, Pittsburgh 30, Pa. ADV. PG. 107-113.

Grid Wire

- Ⓞ Alloy Metal Wire Co., 13th & Penna. Ave., Prospect Park, Pa.
- Ⓞ Birnback Radio Co., Inc., 145 Hudson St., New York, N. Y.
- Ⓞ DRIVER-HARRIS CO., 201 Middlesex St., Harrison N. J. ADV. PG. 131.
- Ⓞ Eitel-McCullough Inc., San Bruno, Calif.
- Ⓞ Fansteel Metallurgical Corp., 2200 Sheridan Rd., North Chicago, Ill.
- Ⓞ Kemet Co., a Division of Union Carbide & Carbon Corp., Madison Ave. & 117th St., Cleveland 1, Ohio.
- Ⓞ METAL TEXTILE CORP., 547 E. First Ave., Roselle, N. J. ADV. PG. 40.
- Ⓞ Murex, Ltd., Rainham, Essex, England.
- Ⓞ North American Philips Co., Inc., 100 E. 42nd St., New York 17, N. Y.
- Ⓞ PIX MFG. CO., INC., 24 Bedford St., Newark, N. J. ADV. PG. 136.
- Ⓞ RADIO CORP. OF AMERICA, Tube Dept., Harrison, N. J. ADV. PG. 177, Inside Back & Back Covers.
- Ⓞ Seccon Metals Corp., 228 E. 45th St., New York 17, N. Y.
- Ⓞ SYLVANIA ELECTRIC PRODUCTS, INC., 1740 Broadway, New York 19, N. Y. ADV. PG. 432-436.
- Ⓞ WESTINGHOUSE ELECTRIC CORP., 511 Wood St., P. O. Box 868, Pittsburgh 30, Pa. ADV. PG. 107-113.
- Ⓞ Wildberg Bros. Smelting & Refining Co., 742 Market St., San Francisco 2, Calif.

Heat Radiators

- Ⓞ Eitel-McCullough, Inc., San Bruno, Calif.
- Ⓞ Fansteel Metallurgical Corp., 2200 Sheridan Rd., North Chicago, Ill.
- Ⓞ FEDERAL TELEPHONE AND RADIO CORP., 88 Kingsland Rd., Clifton, N. J. ADV. PG. 161-163.
- Ⓞ PIX MFG. CO., INC., 24 Bedford St., Newark, N. J. ADV. PG. 136.
- Ⓞ RADIO CORP. OF AMERICA, Tube Dept., Harrison, N. J. ADV. PG. 177, Inside Back & Back Covers.
- Ⓞ SYLVANIA ELECTRIC PRODUCTS, INC., 1740 Broadway, New York 19, N. Y. ADV. PG. 432-436.
- Ⓞ WESTINGHOUSE ELECTRIC CORP., 511 Wood St., P. O. Box 868, Pittsburgh 30, Pa. ADV. PG. 107-113.

Metal Supports

- Ⓞ ART WIRE AND STAMPING CO., 227 High St., Newark 2, N. J. ADV. PG. 38.
- Ⓞ Bawkin Machine Co., 30 Burtis Ave., New Canaan, Conn.
- Ⓞ Electronic Mfg. Co., 20 Orange St., Newark, N. J.
- Ⓞ Elm Laboratories, 18 South Broadway, Dobbs Ferry, N. Y.
- Ⓞ Fansteel Metallurgical Corp., 2200 Sheridan Rd., North Chicago, Ill.
- Ⓞ Goat Co., Inc., Fred, 314 Dean St., Brooklyn, N. Y.
- Ⓞ Greene Mfg. Corp., G. G., Warren, Pa.
- Ⓞ HAYDU BROTHERS, Plainfield, N. J. ADV. PG. 55.
- Ⓞ JOHNSON & HOFFMAN, INC., 65 Ongley St., Rockville Center, L. I., N. Y. ADV. PG. 353.
- Ⓞ North American Philips Co., Inc., 100 E. 42nd St., New York 17, N. Y.
- Ⓞ RADIO CORP. OF AMERICA, Tube Dept., Harrison, N. J. ADV. PG. 177, Inside Back & Back Covers.
- Ⓞ STAVER CO., INC., Box 431, Bayshore, N. Y. ADV. PG. 232.
- Ⓞ SYLVANIA ELECTRIC PRODUCTS, INC., 1740 Broadway, New York 19, N. Y. ADV. PG. 432-436.
- Ⓞ WESTINGHOUSE ELECTRIC CORP., 511 Wood St., P. O. Box 868, Pittsburgh 30, Pa. ADV. PG. 107-113.

Mica Supports

- Ⓞ Asheville-Schoonmaker Mica Co., 900 Jefferson Ave., Newport News, Va.
- Ⓞ BRAND & CO., INC., WILLIAM, North & Valley Sts., Willimantic, Conn. ADV. PG. 248, 249.
- Ⓞ HAYDU BROTHERS, Plainfield, N. J. ADV. PG. 55.
- Ⓞ JOHNSON & HOFFMAN, INC., 65 Ongley St., Rockville Center, N. Y. ADV. PG. 353.
- Ⓞ Mica Fabricating Co., 53 Central Ave., Rochelle Park, N. J.

- Ⓞ Mica Insulator Co., Schenectady 1, N. Y.
- Ⓞ Micacraft Products Inc., 701 McCarter Highway, Newark 5, N. J.
- Ⓞ RADIO CORP. OF AMERICA, Tube Dept., Harrison, N. J. ADV. PG. 177, Inside Back & Back Covers.
- Ⓞ SYLVANIA ELECTRIC PRODUCTS, INC., 1740 Broadway, New York 19, N. Y. ADV. PG. 432-436.

Tube Seal Leads

- Elm Laboratories, 18 South Broadway, Dobbs Ferry, N. Y.
- Ⓞ ENGINEERING CO., 27 Wright St., Newark, N. J. ADV. PG. 370.
- Ⓞ Fansteel Metallurgical Corp., 2200 Sheridan Rd., North Chicago, Ill.
- Ⓞ HERMETIC SEAL PRODUCTS CO., 29-37 South 6th St., Newark 7, N. J. ADV. PG. 175.
- Ⓞ North American Philips Co., Inc., 100 E. 42nd St., New York 17, N. Y.
- Ⓞ PIX MFG. CO., INC., 24 Bedford St., Newark, N. J. ADV. PG. 136.
- Ⓞ SYLVANIA ELECTRIC PRODUCTS, INC., 1740 Broadway, New York 19, N. Y. ADV. PG. 432-436.
- Ⓞ WESTINGHOUSE ELECTRIC CORP., 511 Wood St., P. O. Box 868, Pittsburgh 30, Pa. ADV. PG. 107-113.

Water Jackets

- Ⓞ FEDERAL TELEPHONE AND RADIO CORP., 88 Kingsland Rd., Clifton, N. J. ADV. PG. 161-163.
- Ⓞ MACHLETT LABORATORIES, Springdale, Conn. ADV. PG. 265.
- Ⓞ RADIO CORP. OF AMERICA, Tube Dept., Harrison, N. J. ADV. PG. 177, Inside Back & Back Covers.
- Ⓞ TEFLON PRODUCTS DIVISION, U. S. GASKET CO., P. O. Box 93, Camden, N. J. ADV. PG. 176.

Wire Parts

- Ⓞ ART WIRE AND STAMPING CO., 227 High St., Newark 2, N. J. ADV. PG. 38.
- Ⓞ Electronic Mfg. Co., 20 Orange St., Newark, N. J.
- Ⓞ Goat Co., Inc., Fred, 314 Dean St., Brooklyn, N. Y.
- Ⓞ HAYDU BROTHERS, Plainfield, N. J. ADV. PG. 55.
- Ⓞ METAL TEXTILE CORP., 547 E. First Ave., Roselle, N. J. ADV. PG. 40.
- Ⓞ North American Philips Co., Inc., 100 E. 42nd St., New York 17, N. Y.
- Ⓞ PIX MFG. CO., INC., 24 Bedford St., Newark, N. J. ADV. PG. 136.
- Ⓞ RADIO CORP. OF AMERICA, Tube Dept., Harrison, N. J. ADV. PG. 177, Inside Back & Back Covers.
- Ⓞ SYLVANIA ELECTRIC PRODUCTS, INC., 1740 Broadway, New York 19, N. Y. ADV. PG. 432-436.
- Ⓞ WESTINGHOUSE ELECTRIC CORP., 511 Wood St., P. O. Box 868, Pittsburgh 30, Pa. ADV. PG. 107-113.

TUBE TESTING EQUIPMENT—Production

- Ⓞ BUCK ENGINEERING CO., INC., 37-41 Marcy St., Freehold, N. J. ADV. PG. 374.
- Ⓞ Electronic Engineering Corp., 469 Elm St., Arlington, N. J.
- Ⓞ GENERAL ELECTRIC CO., Electronics Dept., Tube Div., Schenectady 5, N. Y. ADV. PG. 1 to 22.
- Ⓞ McMurdo Silver Co., Inc., 417 Lafayette St., New York, N. Y.
- Ⓞ MacLeod & Hanopol Inc., 10 Joiner St., Charlestown 29, Mass.
- Ⓞ RADIO CORP. OF AMERICA, Tube Dept., Harrison, N. J. ADV. PG. 177, Inside Back & Back Covers.
- Ⓞ SPELLMAN TELEVISION CO., INC., 3029 Webster Ave., New York 67, N. Y. ADV. PG. 277.

TUBES—Ballast

- Ⓞ Electronic Enterprises, Inc., 65 7th Ave., Newark 4, N. J.
- Ⓞ GENERAL ELECTRIC CO., Electronics Dept., Tube Div., Schenectady 5, N. Y. ADV. PG. 1 to 22.
- Ⓞ GENERAL ELECTRONICS, INC., 101 Hazel St., Paterson, N. J. ADV. PG. 326.
- Ⓞ JFD MFG CO., 6101-23 Sixteenth Ave., Brooklyn, N. Y. ADV. PG. 407.
- Ⓞ NATIONAL UNION RADIO CORP., 350 Scotland Rd., Orange, N. J. ADV. PG. 296.
- Ⓞ Philco Corp., Tioga & C Sts., Philadelphia 34, Pa.
- Ⓞ Standard Telephones & Cables Ltd., Connaught House, Aldwych, London, W. C. 2, Enland.
- Ⓞ SYLVANIA ELECTRIC PRODUCTS, INC., 1740 Broadway, New York 19, N. Y. ADV. PG. 432-436.

TUBES—Battery Charger

- Ⓞ CONTINENTAL ELECTRIC CO., Geneva, Ill. ADV. PG. 182.
- Ⓞ ELECTRONICS, INC., 127 Sussex Ave., Newark 4, N. J. ADV. PG. 174.
- Ⓞ GENERAL ELECTRIC CO., Electronics Dept., Tube Div., Schenectady 5, N. Y. ADV. PG. 1 to 22.

Ⓢ indicates . . . IN PRODUCTION • AVAILABILITY • UNRESTRICTED FOR GENERAL USE

- Ⓢ King Electric Equipment Co., 9123 Inman Ave., Cleveland 5, Ohio.
- Ⓢ NATIONAL ELECTRONICS, INC., Geneva, Ill. ADV. PG. 218.
- Ⓢ RADIO CORP. OF AMERICA, Tube Dept., Harrison, N. J. ADV. PG. 177, Inside Back and Back Covers.
- Ⓢ Standard Arcturus Corp., 54 Clark St., Newark 4, N. J.

TUBES—Bolometer

- Aerolux Light Corp., 653 11th Ave., New York 19, N. Y.
- Ⓢ SPERRY GYROSCOPE CO., Div. of The Sperry Corp., Great Neck, N. Y. ADV. PG. 103, 104.

TUBES—Cathode Ray

- Ⓢ Arcturus Electronics, Inc., 54 Clark St., Newark, N. J.
- Ⓢ Capehart-Farnsworth Corp., Fort Wayne, Indiana.
- Ⓢ CONTINENTAL ELECTRIC CO., Geneva, Ill. ADV. PG. 182.
- Ⓢ Cossor (Canada) Ltd., 301-303 Windsor St., Halifax, N. S., Canada.
- Ⓢ Du Mont Laboratories, Inc., Allen B., Cathode-ray Tube Div., 750 Bloomfield Ave., Clifton, N. J.
- Ⓢ Electronic Engineering Corp., 469 Elm St., Arlington, N. J.
- Ⓢ ELECTRONIC TUBE CORP., 1200 E. Mermaid Ave., Philadelphia 18, Pa. ADV. PG. 335.
- Ⓢ Eureka Television & Tube Corp., 69 Fifth Ave., Hawthorne, N. J.
- Ⓢ GENERAL ELECTRIC CO., Electronics Dept., Tube Div., Schenectady 5, N. Y. ADV. PG. 1 to 22.
- Ⓢ GENERAL ELECTRONICS, INC., 101 Hazel St., Paterson, N. J. ADV. PG. 326.
- Ⓢ HAYDU BROTHERS, Plainfield, N. J. ADV. PG. 55.
- Ⓢ International Electronics Corp., 137 Hudson St., New York, N. Y.
- Ⓢ Lansdale Tube Co., Church Rd., Lansdale, Pa.
- Ⓢ NATIONAL UNION RADIO CORP., 350 Scotland Rd., Orange, N. J. ADV. PG. 296.
- Ⓢ North American Philips Co., 100 East 42nd St., New York 17, N. Y.
- Ⓢ Philco Corp., Tioga & C Sts., Philadelphia 34, Pa.
- Ⓢ RADIO CORP. OF AMERICA, Tube Dept., Harrison, N. J. ADV. PG. 177, Inside Back and Back Covers.
- Ⓢ Rauland Corp., 4245 N. Knox Ave., Chicago 41, Ill.
- Ⓢ RAYTHEON MFG. CO., Power Tube Div., Waltham 54, Mass. ADV. PG. 80, 81.
- Ⓢ Sarkes Tarzian Tube Div., 214 Central Ave., Hawthorne, N. J.
- Ⓢ Sheldon Electric Co., Div. of Allied Electric Products, Inc., 76-86 Coit St., Irvington, N. J.
- Ⓢ Standard Arcturus Corp., 54 Clark St., Newark 4, N. J.
- Ⓢ Standard Telephones & Cables Ltd., Connaught House, Aldwych, London, W. C. 2, England.
- Ⓢ SYLVANIA ELECTRIC PRODUCTS, INC., 1740 Broadway, New York 19, N. Y. ADV. PG. 432-436.
- Ⓢ TAYLOR TUBES, INC., 2312 W. Wabansia Ave., Chicago 47, Ill. ADV. PG. 260.
- Ⓢ TEL-O-TUBE CORP. OF AMERICA, Paterson, N. J. ADV. PG. 142.
- Ⓢ Thomas Electronics, Inc., 118 9th St., Passaic, N. J.
- Ⓢ Transvision, Inc., 460 North Ave., New Rochelle, N. Y.
- Ⓢ TUNG-SOL LAMP WORKS, INC., 95 Eighth Ave., Newark 4, N. J. ADV. PG. 169.
- Ⓢ Vacuum Tube Products, 302 North Clementine St., Oceanside, Calif.
- Ⓢ Zetka Television Tubes, Inc., 131-37 Getty Ave., Clifton, N. J.

TUBES—Detector

- Ⓢ GENERAL ELECTRIC CO., Electronics Dept., Tube Div., Schenectady 5, N. Y. ADV. PG. 1 to 22.
- Ⓢ HAYDU BROTHERS, Plainfield, N. J. ADV. PG. 55.
- Ⓢ Kemtron Electron Products, Inc., 23 Brown St., Salem, Mass.
- Ⓢ North American Philips Co., Inc., 100 E. 42nd St., New York 17, N. Y.
- Ⓢ RADIO CORP. OF AMERICA, Tube Dept., Harrison, N. J., ADV. PG. 177, Inside Back and Back Covers.

TUBES—Electrometer

- Ⓢ GENERAL ELECTRIC CO., Electronics Dept., Tube Div., Schenectady 5, N. Y. ADV. PG. 1 to 22.
- Ⓢ International Electronics Corp., 137 Hudson St., New York, N. Y.
- Ⓢ Sonotone Corp., P. O. Box 200, Saw Mill River Rd., Elmsford, N. Y.
- Ⓢ VICTOREEN INSTRUMENT CO., 5806 Hough Ave., Cleveland 3, Ohio. ADV. PG. 272, 273.
- Ⓢ WESTINGHOUSE ELECTRIC CORP., Electronic Tube Sales Dept., Bloomfield, N. J. ADV. PG. 114, 115.

TUBES—Geiger

- Aerolux Light Corp., 653 11th Ave., New York 19, N. Y.
- Ⓢ Amperex Electronic Corp., 25 Washington St., Brooklyn, N. Y.
- Ⓢ Anton Electronic Laboratories, Inc., 1226-1238 Flushing Ave., Brooklyn 6, N. Y.

- Ⓢ ATOMIC INSTRUMENT CO., 84 Massachusetts Ave., Cambridge 39, Mass. ADV. PG. 410.
- Ⓢ BALLANTINE LABORATORIES, INC., Boonton, N. J. ADV. PG. 125.
- Ⓢ Cyclotron Specialties Co., Moraga 8, Calif.
- Ⓢ Earnshaw-Tharp-Christensen Corp., Box 35, Verdi, Nev.
- Ⓢ Electronic Products Co., 111 E. Third St., Mt. Vernon, N. Y.
- Ⓢ EL-TRONICS, INC., 2649 N. Howard St., Philadelphia 33, Pa. ADV. PG. 299.
- Ⓢ GENERAL ELECTRIC CO., Electronics Dept., Tube Div., Schenectady 5, N. Y. ADV. PG. 1 to 22.
- Ⓢ Georator Corp., 1820 N. Nash St., Arlington, Va.
- Ⓢ Kelley-Koett Instrument Co., 962 York St., Cincinnati 14, Ohio.
- Ⓢ North American Philips Co., Inc., 100 E. 42nd St., New York 17, N. Y.
- Ⓢ Nuclear Development Lab., P. O. Box 7034, Kansas City, Mo.
- Ⓢ Nuclear Instrument & Chemical Corp., 223 W. Erie St., Chicago 10, Ill.
- Ⓢ Nuclear Research Corp., 2707 Federal St., Philadelphia 46, Pa.
- Ⓢ Nucleonic Corp. of America, The, 497 Union St., Brooklyn 31, N. Y.
- Ⓢ R-C Scientific Instrument Co., 335 Culver Blvd., Playa Del Rey, Calif.
- Ⓢ Radiation Counter Laboratories, Inc., 1844 W. 21st St., Chicago 8, Ill.
- Ⓢ RAYTHEON MFG. CO., Receiving & Special Tube Div., 55 Chapel St., Newton 58, Mass. ADV. PG. 80 81.
- Ⓢ SYLVANIA ELECTRIC PRODUCTS, INC., 1740 Broadway, New York 19, N. Y. ADV. PG. 432-436.
- Ⓢ Technical Associates, 3730 San Fernando Rd., Glendale 4, Calif.
- Ⓢ Tracerlab Inc., 130 High St., Boston 10, Mass.
- Ⓢ VICTOREEN INSTRUMENT CO., 5806 Hough Ave., Cleveland 3, Ohio. ADV. PG. 272, 273.
- Ⓢ WESTINGHOUSE ELECTRIC CORP., Electronic Tube Sales Dept., Bloomfield, N. J. ADV. PG. 114, 115.
- Ⓢ Wood Counter Laboratory, N., 5646 Harper Ave., Chicago 37, Ill.

TUBES—Germicidal

- Aerolux Light Corp., 653 11th Ave., New York 19, N. Y.
- Dallons Labs., 5066 Santa Monica Blvd., Los Angeles, Calif.
- Ⓢ GENERAL ELECTRIC CO., Lamp Dept., Nela Park, Cleveland 12, Ohio. ADV. PG. 1 to 22.
- Ⓢ Kemlite Labs., 1819 W. Grand Ave., Chicago 22, Ill.
- Ⓢ Menlo Research Laboratory, Menlo Park, Calif.
- Ⓢ Ultra-Violet Products, Inc., 145 Pasadena Ave., South Pasadena, Calif.

TUBES—Hearing Aid

- Ⓢ Amperex Electronic Corp., 25 Washington St., Brooklyn 1, N. Y.
- Precision Tube Co., Inc., 3828 Terrace St., Philadelphia 28, Pa.
- Ⓢ RAYTHEON MFG. CO., Receiving & Special Tube Div., 55 Chapel St., Newton 58, Mass. ADV. PG. 80, 81.
- Ⓢ Sarkes Tarzian Tube Div., 214 Central Ave., Hawthorne, N. J.
- Ⓢ Sonotone Corp., P. O. Box 200, Saw Mill River Rd., Elmsford, N. Y.
- Ⓢ Standard Arcturus Corp., 54 Clark St., Newark 4, N. J.
- Ⓢ Standard Telephones & Cables Ltd., Connaught House, Aldwych, London, W. C. 2, England.

TUBES—Industrial

- Ⓢ CHATHAM ELECTRONICS CORP., 475 Washington St., Newark 2, N. J. ADV. PG. 46.
- Ⓢ CONTINENTAL ELECTRIC CO., Geneva, Ill. ADV. PG. 182.
- Ⓢ ECLIPSE-PIONEER DIV., Bendix Aviation Corp., Teterboro, N. J. ADV. PG. 198, 199.
- Ⓢ Electronic Engineering Corp., 469 Elm St., Arlington, N. J.
- Ⓢ Electronic Enterprises Inc., 65-7th Ave., Newark 4, N. J.
- Ⓢ ELECTRONS, INC., 127 Sussex Ave., Newark 4, N. J. ADV. PG. 174.
- Ⓢ FEDERAL TELEPHONE AND RADIO CORP., 88 Kingsland Rd., Clifton, N. J. ADV. PG. 161-163.
- Ⓢ GENERAL ELECTRIC CO., Electronic Dept., Tube Div., Schenectady 5, N. Y. ADV. PG. 1 to 22.
- Ⓢ GENERAL ELECTRONICS, INC., 101 Hazel St., Paterson, N. J. ADV. PG. 326.
- Ⓢ HAYDU BROTHERS, Plainfield, N. J. ADV. PG. 55.
- Ⓢ HEINTZ & KAUFMAN DIV. OF THE ROBERT DOLLAR CO., 947 Broadway, Redwood City, Calif. ADV. PG. 301.
- Ⓢ International Electronics Corp., 137 Hudson St., New York, N. Y.
- Ⓢ Kuthe Laboratories, 150 Summit St., Newark 4, N. J.
- Ⓢ Lewis & Kaufman, Inc., P. O. Box 337, 90 El Rancho Ave., Los Gatos, Calif.
- Ⓢ MACHETT LABORATORIES, Springdale, Conn. ADV. PG. 265.
- Ⓢ NATIONAL ELECTRONICS, INC., Geneva, Ill. ADV. PG. 218.

- Ⓢ NATIONAL UNION RADIO CORP., 350 Scotland Rd., Orange, N. J. ADV. PG. 296.
- Ⓢ RADIO CORP. OF AMERICA, Tube Dept., Harrison, N. J. ADV. PG. 177, Inside Back and Back Covers.
- Ⓢ RAYTHEON MFG. CO., Receiving & Special Tube Div., 55 Chapel St., Newton 58, Mass. ADV. PG. 80, 81.
- Ⓢ Standard Arcturus Corp., 54 Clark St., Newark 4, N. J.
- Ⓢ Standard Telephones & Cables Ltd., Connaught House, Aldwych, London, W. C. 2, England.
- Ⓢ SYLVANIA ELECTRIC PRODUCTS, INC., 1740 Broadway, New York 19, N. Y. ADV. PG. 432-436.
- Ⓢ TAYLOR TUBES, INC., 2312 W. Wabansia Ave., Chicago 47, Ill. ADV. PG. 260.
- Ⓢ TUNG-SOL LAMP WORKS INC., 95 Eighth Ave., Newark 4, N. J. ADV. PG. 169.
- Ⓢ UNITED ELECTRONICS CO., 42 Spring St., Newark 2, N. J. ADV. PG. 139-141.
- Ⓢ WESTINGHOUSE ELECTRIC CORP., Electronic Tube Sales Dept., Bloomfield, N. J. ADV. PG. 114, 115.

TUBES—Ionization Gage

- Ⓢ Distillation Products Industries Div. of Eastman Kodak Co., 755 Ridge Rd., W., Rochester 3, N. Y.
- Ⓢ Eitel-McCullough, Inc., San Bruno, Calif.
- Ⓢ Electronic Engineering Corp., 469 Elm St., Arlington, N. J.
- Ⓢ GENERAL ELECTRIC CO., Electronics Dept., Tube Div., Schenectady 5, N. Y. ADV. PG. 1 to 22.
- Ⓢ HEINTZ & KAUFMAN DIV. OF THE ROBERT DOLLAR CO., 947 Broadway, Redwood City, Calif. ADV. PG. 301.
- Ⓢ National Research Corp., 70 Memorial Dr., Cambridge 42, Mass.
- Ⓢ NATIONAL UNION RADIO CORP., 350 Scotland Rd., Orange, N. J. ADV. PG. 296.
- Ⓢ North American Philips Co., Inc., 100 E. 42nd St., New York 17, N. Y.
- Ⓢ Nuclear Instrument & Chemical Corp., 223 W. Erie St., Chicago 10, Ill.
- Ⓢ RADIO CORP. OF AMERICA, Tube Dept., Harrison, N. J. ADV. PG. 177, Inside Back and Back Covers.
- Ⓢ Standard Telephones & Cables Ltd., Connaught House, Aldwych, London, W. C. 2, England.
- Ⓢ WESTINGHOUSE ELECTRIC CORP., Electronic Tube Sales Dept., Bloomfield, N. J. ADV. PG. 114, 115.

TUBES—Klystron

- Ⓢ ECLIPSE-PIONEER DIV., Bendix Aviation Corp., Teterboro, N. J. ADV. PG. 198, 199.
- Ⓢ Eitel-McCullough, Inc., San Bruno, Calif.
- Ⓢ FEDERAL TELEPHONE AND RADIO CORP., 88 Kingsland Rd., Clifton, N. J. ADV. PG. 161-163.
- Ⓢ GENERAL ELECTRIC CO., Electronics Dept., Tube Div., Schenectady 5, N. Y. ADV. PG. 1 to 22.
- Ⓢ GENERAL ELECTRONICS, INC., 101 Hazel St., Paterson, N. J. ADV. PG. 326.
- Ⓢ Lewis & Kaufman, Inc., P. O. Box 337, 90 El Rancho Ave., Los Gatos, Calif.
- Ⓢ RAYTHEON MFG. CO., Power Tube Div., Waltham 54, Mass. ADV. PG. 80, 81.
- Ⓢ SPERRY GYROSCOPE CO., Div. of The Sperry Corp., Great Neck, N. Y. ADV. PG. 103, 104.
- Ⓢ Standard Arcturus Corp., 54 Clark St., Newark 4, N. J.
- Ⓢ Standard Telephones & Cables Ltd., Connaught House, Aldwych, London, W. C. 2, England.
- Ⓢ SYLVANIA ELECTRIC PRODUCTS, INC., 1740 Broadway, New York 19, N. Y. ADV. PG. 432-436.
- Ⓢ Varian Associates, 99 Washington St., San Carlos, Calif.

TUBES—Magnetron

- Ⓢ Amperex Electronic Corp., 25 Washington St., Brooklyn 1, N. Y.
- Ⓢ Bomac Laboratories Inc., Salem Rd., Beverly, Mass.
- Ⓢ FEDERAL TELEPHONE AND RADIO CORP., 88 Kingsland Rd., Clifton, N. J. ADV. PG. 161-163.
- Ⓢ GENERAL ELECTRIC CO., Electronics Dept., Tube Div., Schenectady 5, N. Y. ADV. PG. 1 to 22.
- Ⓢ Litton Industries, San Carlos, Calif.
- Ⓢ RADIO CORP. OF AMERICA, Tube Dept., Harrison, N. J. ADV. PG. 177, Inside Back & Back Covers.
- Ⓢ RAYTHEON MFG. CO., Power Tube Div., Waltham 54, Mass. ADV. PG. 80, 81.
- Ⓢ Standard Arcturus Corp., 54 Clark St., Newark 4, N. J.
- Ⓢ SYLVANIA ELECTRIC PRODUCTS, INC., 1740 Broadway, New York 19, N. Y. ADV. PG. 432-436.

TUBES—Mass Spectrometer

- Ⓢ Amperex Electronic Corp., 25 Washington St., Brooklyn 1, N. Y.
- Process & Instruments, 60 Greenpoint Ave., Brooklyn 22, N. Y.

TUBES—Microwave Receiving or Transmitting

- Ⓢ Bomac Laboratories, Inc., Salem Rd., Beverly, Mass.
- Ⓢ ECLIPSE-PIONEER DIV., Bendix Aviation Corp., Teterboro, N. J. ADV. PG. 198, 199.

V indicates . . . IN PRODUCTION • AVAILABILITY • UNRESTRICTED FOR GENERAL USE

- Ⓞ **FEDERAL TELECOMMUNICATION LABS., INC.**, 500 Washington Ave., Nutley, N. J. ADV. PG. 164.
- Ⓞ **GENERAL ELECTRIC CO.**, Electronics Dept., Tube Div., Schenectady 5, N. Y. ADV. PG. 1 to 22.
- Ⓞ **GENERAL ELECTRONICS, INC.**, 101 Hazel St., Paterson, N. J. ADV. PG. 326.
- Ⓞ **Lewis & Kaufman, Inc.**, P. O. Box 337, 90 El Rancho Ave., Los Gatos, Calif.
- Ⓞ **NATIONAL UNION RADIO CORP.**, 350 Scotland Rd., Orange, N. J. ADV. PG. 296.
- Ⓞ **RADIO CORP. OF AMERICA**, Tube Dept., Harrison, N. J. ADV. PG. 177, Inside Back & Back Covers.
- Ⓞ **RAYTHEON MFG. CO.**, Receiving & Special Tube Div., 55 Chapel St., Newton 58, Mass. ADV. PG. 80, 81.
- Ⓞ **SPERRY GYROSCOPE CO.**, Div. of The Sperry Corp., Great Neck, N. Y. ADV. PG. 103, 104.
- Ⓞ **Standard Telephones & Cables Ltd.**, Connaught House, Aldwych, London, W. C. 2, England.
- Ⓞ **SYLVANIA ELECTRIC PRODUCTS, INC.**, 1740 Broadway, New York 19, N. Y. ADV. PG. 432-436.
- Ⓞ **Varian Associates**, 99 Washington St., San Carlos, Calif.

TUBES—Phototubes and Photocells

- Ⓞ **CONTINENTAL ELECTRIC CO.**, Geneva, Ill. ADV. PG. 182.
- Ⓞ **Earnshaw-Tharp-Christensen Corp.**, Box 35, Verdi, Nev.
- Ⓞ **GENERAL ELECTRIC CO.**, Schenectady 5, N. Y. ADV. PG. 1 to 22.
- Ⓞ **GENERAL ELECTRIC CO.**, Electronics Dept., Tube Div., Schenectady 5, N. Y. ADV. PG. 1 to 22.
- Ⓞ **International Electronics Corp.**, 137 Hudson St., New York, N. Y.
- Ⓞ **MacKay Laboratories**, 1946 N. Kedzie, Chicago 47, Ill.
- Ⓞ **NATIONAL UNION RADIO CORP.**, 350 Scotland Rd., Orange, N. J. ADV. PG. 296.
- Ⓞ **Photobell Company**, 116 Nassau St., New York 7, N. Y.
- Ⓞ **RADIO CORP. OF AMERICA**, Tube Dept., Harrison, N. J. ADV. PG. 177, Inside Back & Back Covers.
- Ⓞ **Standard Arcturus Corp.**, 54 Clark St., Newark 4, N. J.
- Ⓞ **SYLVANIA ELECTRIC PRODUCTS, INC.**, 1740 Broadway, New York 19, N. Y. ADV. PG. 432-436.
- Ⓞ **Tracerlab, Inc.**, 130 High St., Boston 10, Mass.
- Ⓞ **WESTINGHOUSE ELECTRIC CORP.**, Electronics Tube Sales Dept., Bloomfield, N. J. ADV. PG. 114, 115.
- Ⓞ **WESTON ELECTRICAL INSTRUMENT CORP.**, 595 Frelinghuysen Ave., Newark 5, N. J. ADV. PG. 243.

TUBES—Piran

- Ⓞ **Distillation Products Industries**, Div. of Eastman Kodak Co., 755 Ridge Rd., W. Rochester 3, N. Y.
- Ⓞ **Fredericks Co.**, Geo. E., Bethayres, Pa.
- Ⓞ **GENERAL ELECTRIC CO.**, Electronics Dept., Tube Div., Schenectady 5, N. Y. ADV. PG. 1 to 22.
- Ⓞ **RADIO CORP. OF AMERICA**, Tube Dept., Harrison, N. J. ADV. PG. 177, Inside Back & Back Covers.
- Ⓞ **SYLVANIA ELECTRIC PRODUCTS, INC.**, 1740 Broadway, New York 19, N. Y. ADV. PG. 432-436.

TUBES—Quartz (for Short Wave Medical Apparatus)

- Ⓞ **Aerolux Light Corp.**, 653 11th Ave., New York 19, N. Y.
- Ⓞ **Dallons Labs.**, 5066 Santa Monica Blvd., Los Angeles, Calif.
- Ⓞ **Kemlite Labs.**, 1819 W. Grand Ave., Chicago 22, Ill.
- Ⓞ **MacKay Laboratories**, 1946 N. Kedzie, Chicago 47, Ill.
- Ⓞ **SYNCOR PRODUCTS CO.**, Malden, Mass. ADV. PG. 405.
- Ⓞ **Thermal Syndicate Ltd.**, 12 E. 46th St., New York 17, N. Y.
- Ⓞ **Ultra-Violet Products, Inc.**, 145 Pasadena Ave., South Pasadena, Calif.

TUBES—Receiving

- Ⓞ **Arcturus Electronics, Inc.**, 54 Clark St., Newark, N. J.
- Ⓞ **ECLIPSE-PIONEER DIV.**, Bendix Aviation Corp., Teterboro, N. J. ADV. PG. 198, 199.
- Ⓞ **GENERAL ELECTRIC CO.**, Electronics Dept., Tube Div., Schenectady 5, N. Y. ADV. PG. 1 to 22.
- Ⓞ **HAYDU BROTHERS**, Plainfield, N. J. ADV. PG. 55.
- Ⓞ **Hytron Radio & Electronics Corp.**, 76 Lafayette St., Salem, Mass.
- Ⓞ **International Electronics Corp.**, 137 Hudson St., New York, N. Y.
- Ⓞ **NATIONAL UNION RADIO CORP.**, 350 Scotland Rd., Orange, N. J. ADV. PG. 296.
- Ⓞ **Philco Corp.**, Tioga & C Sts., Philadelphia 34, Pa.
- Ⓞ **RADIO CORP. OF AMERICA**, Tube Dept., Harrison, N. J. ADV. PG. 177, Inside Back & Back Covers.
- Ⓞ **RAYTHEON MFG. CO.**, Receiving & Special Tube Div., 55 Chapel St., Newton 58, Mass. ADV. PG. 80, 81.
- Ⓞ **Sarkes Tarzian Tube Div.**, 214 Central Ave., Hawthorne, N. J.
- Ⓞ **Sheldon Electric Co.**, Div. of Allied Electric Products, Inc., 76 Coit St., Irvington 11, N. J.

- Ⓞ **Sonotone Corp.**, P. O. Box 200, Saw Mill River Rd., Elmsford, N. Y.
- Ⓞ **Standard Arcturus Corp.**, 54 Clark St., Newark 4, N. J.
- Ⓞ **Standard Telephones & Cables Ltd.**, Connaught House, Aldwych, London, W. C. 2, England.
- Ⓞ **SYLVANIA ELECTRIC PRODUCTS, INC.**, 1740 Broadway, New York 19, N. Y. ADV. PG. 432-436.
- Ⓞ **Thomas Electronics, Inc.**, 118 Ninth St., Passaic, N. J.
- Ⓞ **TUNG-SOL LAMP WORKS INC.**, 95 Eighth Ave., Newark 4, N. J. ADV. PG. 169.

TUBES—Rectifying

- Ⓞ **Aerolux Light Corp.**, 653 11th Ave., New York 19, N. Y.
- Ⓞ **Amperex Electronic Corp.**, 25 Washington St., Brooklyn, N. Y.
- Ⓞ **Baldor Electric Co.**, 4353 Duncan Ave., St. Louis, Mo.
- Ⓞ **Clark Electronic Labs.**, Box 165, Palm Springs, Calif.
- Ⓞ **CONTINENTAL ELECTRIC CO.**, Geneva, Ill. ADV. PG. 182.
- Ⓞ **ECLIPSE-PIONEER DIV.**, Bendix Aviation Corp., Teterboro, N. J. ADV. PG. 198, 199.
- Ⓞ **Eitel-McCullough, Inc.**, San Bruno, Calif.
- Ⓞ **Electronic Engineering Corp.**, 469 Elm St., Arlington, N. J.
- Ⓞ **Electronic Enterprises Inc.**, 65 7th Ave., Newark 4, N. J.
- Ⓞ **ELECTRONS INC.**, 127 Sussex Ave., Newark 4, N. J. ADV. PG. 174.
- Ⓞ **FEDERAL TELEPHONE AND RADIO CORP.**, 88 Kingsland Rd., Clinton, N. J. ADV. PG. 161-163.
- Ⓞ **GENERAL ELECTRIC CO.**, Electronics Dept., Tube Div., Schenectady 5, N. Y. ADV. PG. 1 to 22.
- Ⓞ **GENERAL ELECTRONICS, INC.**, 101 Hazel St., Paterson, N. J. ADV. PG. 326.
- Ⓞ **HAYDU BROTHERS**, Plainfield, N. J. ADV. PG. 55.
- Ⓞ **HEINTZ & KAUFMAN, DIV. OF THE ROBERT DOLLAR CO.**, 947 Broadway, Redwood City, Calif. ADV. PG. 301.
- Ⓞ **Hytron Radio & Electronics Corp.**, 76 Lafayette St., Salem, Mass.
- Ⓞ **Kemtron Electron Products, Inc.**, 23 Brown St., Salem, Mass.
- Ⓞ **Kuthe Laboratories, Inc.**, 150 Summit St., Newark 4, N. J.
- Ⓞ **Lewis & Kaufman, Inc.**, P. O. Box 337, 90 El Rancho Ave., Los Gatos, Calif.
- Ⓞ **MACHLETT LABORATORIES**, Springdale, Conn. ADV. PG. 265.
- Ⓞ **Mellaphone Corp.**, Rochester 2, N. Y.
- Ⓞ **NATIONAL ELECTRONICS INC.**, Geneva, Ill. ADV. PG. 218.
- Ⓞ **NATIONAL UNION RADIO CORP.**, 350 Scotland Rd., Orange, N. J. ADV. PG. 296.
- Ⓞ **Philco Corp.**, Tioga & C Sts., Philadelphia 34, Pa.
- Ⓞ **RADIO CORP. OF AMERICA**, Tube Dept., Harrison, N. J. ADV. PG. 177, Inside Back & Back Covers.
- Ⓞ **RAYTHEON MFG. CO.**, Power Tube Div., Waltham 54, Mass. ADV. PG. 80, 81.
- Ⓞ **Ross Mfg. Co.**, 860 Washington St., Burlington, Iowa.
- Ⓞ **Sheldon Electric Co.**, Div. of Allied Electric Products, Inc., 76-86 Coit St., Irvington, N. J.
- Ⓞ **Standard Arcturus Corp.**, 54 Clark St., Newark 4, N. J.
- Ⓞ **Standard Telephones & Cables Ltd.**, Connaught House, Aldwych, London, W. C. 2, England.
- Ⓞ **SYLVANIA ELECTRIC PRODUCTS, INC.**, 1740 Broadway, New York 19, N. Y. ADV. PG. 432-436.
- Ⓞ **Takk Corp.**, Newark, Ohio.
- Ⓞ **TAYLOR TUBES, INC.**, 2312 W. Wabansia Ave., Chicago 47, Ill. ADV. PG. 260.
- Ⓞ **TUNG-SOL LAMP WORKS INC.**, 95 Eighth Ave., Newark 4, N. J. ADV. PG. 169.
- Ⓞ **UNITED ELECTRONICS CO.**, 42 Spring St., Newark 2, N. J. ADV. PG. 139-141.
- Ⓞ **Vacuum Tube Products**, 302 N. Clementine St., Ocean-side, Calif.
- Ⓞ **VICTOREEN INSTRUMENT CO.**, 5806 Hough Ave., Cleveland 3, Ohio. ADV. PG. 272, 273.
- Ⓞ **WESTINGHOUSE ELECTRIC CORP.**, Electronic Tube Sales Dept., Bloomfield, N. J. ADV. PG. 114, 115.

- Ⓞ **Hytron Radio & Electronics Corp.**, 76 Lafayette St., Salem, Mass.
- Ⓞ **Kemtron Electron Products, Inc.**, 23 Brown St., Salem, Mass.
- Ⓞ **Kuthe Laboratories, Inc.**, 150 Summit St., Newark 4, N. J.
- Ⓞ **Lewis & Kaufman, Inc.**, P. O. Box 337, 90 El Rancho Ave., Los Gatos, Calif.
- Ⓞ **MACHLETT LABORATORIES**, Springdale, Conn. ADV. PG. 265.
- Ⓞ **Mellaphone Corp.**, Rochester 2, N. Y.
- Ⓞ **NATIONAL ELECTRONICS INC.**, Geneva, Ill. ADV. PG. 218.
- Ⓞ **NATIONAL UNION RADIO CORP.**, 350 Scotland Rd., Orange, N. J. ADV. PG. 296.
- Ⓞ **Philco Corp.**, Tioga & C Sts., Philadelphia 34, Pa.
- Ⓞ **RADIO CORP. OF AMERICA**, Tube Dept., Harrison, N. J. ADV. PG. 177, Inside Back & Back Covers.
- Ⓞ **RAYTHEON MFG. CO.**, Power Tube Div., Waltham 54, Mass. ADV. PG. 80, 81.
- Ⓞ **Ross Mfg. Co.**, 860 Washington St., Burlington, Iowa.
- Ⓞ **Sheldon Electric Co.**, Div. of Allied Electric Products, Inc., 76-86 Coit St., Irvington, N. J.
- Ⓞ **Standard Arcturus Corp.**, 54 Clark St., Newark 4, N. J.
- Ⓞ **Standard Telephones & Cables Ltd.**, Connaught House, Aldwych, London, W. C. 2, England.
- Ⓞ **SYLVANIA ELECTRIC PRODUCTS, INC.**, 1740 Broadway, New York 19, N. Y. ADV. PG. 432-436.
- Ⓞ **Takk Corp.**, Newark, Ohio.
- Ⓞ **TAYLOR TUBES, INC.**, 2312 W. Wabansia Ave., Chicago 47, Ill. ADV. PG. 260.
- Ⓞ **TUNG-SOL LAMP WORKS INC.**, 95 Eighth Ave., Newark 4, N. J. ADV. PG. 169.
- Ⓞ **UNITED ELECTRONICS CO.**, 42 Spring St., Newark 2, N. J. ADV. PG. 139-141.
- Ⓞ **Vacuum Tube Products**, 302 N. Clementine St., Ocean-side, Calif.
- Ⓞ **VICTOREEN INSTRUMENT CO.**, 5806 Hough Ave., Cleveland 3, Ohio. ADV. PG. 272, 273.
- Ⓞ **WESTINGHOUSE ELECTRIC CORP.**, Electronic Tube Sales Dept., Bloomfield, N. J. ADV. PG. 114, 115.

TUBES—Strobotron

- Ⓞ **Aerolux Light Corp.**, 653 11th Ave., New York 19, N. Y.
- Ⓞ **Bomac Laboratories, Inc.**, Salem Rd., Beverly, Mass.
- Ⓞ **Kemlite Labs.**, 1819 W. Grand Ave., Chicago 22, Ill.
- Ⓞ **Standard Arcturus Corp.**, 54 Clark St., Newark 4, N. J.
- Ⓞ **SYLVANIA ELECTRIC PRODUCTS, INC.**, 1740 Broadway, New York 19, N. Y. ADV. PG. 432-436.

TUBES—Subminiature

- Ⓞ **Amperex Electronic Corp.**, 25 Washington St., Brooklyn 1, N. Y.
- Ⓞ **GENERAL ELECTRIC CO.**, Electronics Dept., Tube Div., Schenectady 5, N. Y. ADV. PG. 1 to 22.
- Ⓞ **International Electronics Corp.**, 137 Hudson St., New York, N. Y.
- Ⓞ **Kip Electronics Corp.**, 155 Waverly Pl., New York 14, N. Y.

- Ⓞ **NATIONAL UNION RADIO CORP.**, 350 Scotland Rd., Orange, N. J. ADV. PG. 296.
- Ⓞ **RADIO CORP. OF AMERICA**, Tube Dept., Harrison, N. J. ADV. PG. 177, Inside Back and Back Covers.
- Ⓞ **RAYTHEON MFG. CO.**, Receiving & Special Tube Div., 55 Chapel St., Newton 58, Mass. ADV. PG. 80, 81.
- Ⓞ **Sheldon Electric Co.**, Div. of Allied Electric Products, Inc., 76 Coit St., Irvington 11, N. J.
- Ⓞ **Sonotone Corp.**, P. O. Box 200, Saw Mill River Rd., Elmsford, N. Y.
- Ⓞ **Standard Arcturus Corp.**, 54 Clark St., Newark 4, N. J.
- Ⓞ **Standard Telephones & Cables Ltd.**, Connaught House, Aldwych London, W. C. 2, England.
- Ⓞ **SYLVANIA ELECTRIC PRODUCTS, INC.**, 1740 Broadway, New York 19, N. Y. ADV. PG. 432-436.
- Ⓞ **VICTOREEN INSTRUMENT CO.**, 5806 Hough St., Cleveland 3, Ohio. ADV. PG. 272, 273.

TUBES—Television

See Tubes, Cathode Ray

TUBES—Television Pickup

- Ⓞ **Jamaica Electronics Products Co.**, 95-26 Sutphin Blvd., Jamaica 4, N. Y.
- Ⓞ **RADIO CORP. OF AMERICA**, Tube Div., Harrison, N. J. ADV. PG. 177, Inside Back and Back Covers.
- Ⓞ **Remington Rand, Inc.**, Vericon Dept., 315 4th Ave., New York, N. Y.
- Ⓞ **Sarkes Tarzian Tube Div.**, 214 Central Ave., Hawthorne, N. J.
- Ⓞ **SYLVANIA ELECTRIC PRODUCTS, INC.**, 1740 Broadway, New York 19, N. Y. ADV. PG. 432-436.

TUBES—Television Picture

- Ⓞ **American Television, Inc.**, 523 S. Plymouth St., Chicago 6, Ill.
- Ⓞ **Arcturus Electronics, Inc.**, 54 Clark St., Newark, N. J.
- Ⓞ **CONTINENTAL ELECTRIC CO.**, Geneva, Ill. ADV. PG. 182.
- Ⓞ **Diamond Power Specialty Corp.**, Lancaster, Ohio.
- Ⓞ **DuMont Laboratories, Inc.**, Allen B., Cathode-ray Tube Div., 750 Bloomfield Ave., Clifton, N. J.
- Ⓞ **Eitel-McCullough, Inc.**, San Bruno, Calif.
- Ⓞ **Electronic Engineering Corp.**, 469 Elm St., Arlington, N. J.
- Ⓞ **FEDERAL TELEPHONE & RADIO CORP.**, 88 Kingsland Rd., Clifton, N. J. ADV. PG. 161-163.
- Ⓞ **GENERAL ELECTRIC CO.**, Electronics Dept., Tube Div., Schenectady 5, N. Y. ADV. PG. 1 to 22.
- Ⓞ **GENERAL ELECTRONICS, INC.**, 101 Hazel St., Paterson, N. J. ADV. PG. 326.
- Ⓞ **General Vacuum Tube Corp.**, 45 Elm St., Ardsley, N. Y.
- Ⓞ **Jamaica Electronic Products Co.**, 95-26 Sutphin Blvd., Jamaica 4, N. Y.
- Ⓞ **HAYDU BROTHERS**, Plainfield, N. J. ADV. PG. 55.
- Ⓞ **Hytron Radio & Electronics Corp.**, 76 Lafayette St., Salem, Mass.
- Ⓞ **NATIONAL UNION RADIO CORP.**, 350 Scotland Rd., Orange, N. J. ADV. PG. 296.
- Ⓞ **National Video Corp.**, 3019 W. 47th St., Chicago, Ill.
- Ⓞ **Philco Corp.**, Tioga & C Sts., Philadelphia 34, Pa.
- Ⓞ **RADIO CORP. OF AMERICA**, Tube Dept., Harrison, N. J. ADV. PG. 177, Inside Back and Back Covers.
- Ⓞ **RAYTHEON MFG. CO.**, Receiving & Special Tube Div., 55 Chapel St., Newton 58, Mass. ADV. PG. 80, 81.
- Ⓞ **REEVES SOUNDRAFT CORP.**, 10 E. 52nd St., New York 22, N. Y. ADV. PG. 372.
- Ⓞ **Sarkes Tarzian Tube Div.**, 214 Central Ave., Hawthorne, N. J.
- Ⓞ **Sheldon Electric Co.**, Div. of Allied Electric Products, Inc., 76-86 Coit St., Irvington, N. J.
- Ⓞ **Standard Arcturus Co.**, 54 Clark St., Newark 4, N. J.
- Ⓞ **Standard Telephones & Cables Ltd.**, Connaught House, Aldwych, London, W. C. 2, England.
- Ⓞ **TAYLOR TUBES, INC.**, 2312 W. Wabansia Ave., Chicago 47, Ill. ADV. PG. 260.
- Ⓞ **Tele-Ray Tube Co., Inc.**, 984 Saw Mill River Rd., Yonkers, N. Y.
- Ⓞ **TEL-O-TUBE CORP. OF AMERICA**, Paterson, N. J. ADV. PG. 412.
- Ⓞ **Thomas Electronics, Inc.**, 118 Ninth St., Passaic, N. J.
- Ⓞ **Transvision, Inc.**, 460 North Ave., New Rochelle, N. Y.
- Ⓞ **TUNG-SOL LAMP WORKS INC.**, 95 Eighth Ave., Newark 4, N. J. ADV. PG. 169.
- Ⓞ **Vacuum Tube Products**, 302 North Clementine St., Oceanside, Calif.

TUBES—Television Projection

- Ⓞ **GENERAL ELECTRONICS, INC.**, 101 Hazel St., Paterson, N. J. ADV. PG. 326.
- Ⓞ **Jamaica Electronic Products Co.**, 95-26 Sutphin Blvd., Jamaica 4, N. Y.
- Ⓞ **NATIONAL UNION RADIO CORP.**, 350 Scotland Rd., Orange, N. J. ADV. PG. 296.
- Ⓞ **Philco Corp.**, Tioga & C Sts., Philadelphia 34, Pa.
- Ⓞ **RADIO CORP. OF AMERICA**, Tube Dept., Harrison, N. J. ADV. PG. 177, Inside Back and Back Covers.

V indicates . . . IN PRODUCTION • AVAILABILITY • UNRESTRICTED FOR GENERAL USE

- ⊙ Standard Telephones & Cables Ltd., Connaught House, Aldwych, London, W. C. 2, England.
- ⊙ TEL-O-TUBE CORP. OF AMERICA, Paterson, N. J. ADV. PG. 142.
- ⊙ Vacuum Tube Products, 302 N. Clementine St., Ocean-side, Calif.

TUBES—Thyratron

- Aerolux Light Corp., 653 11th Ave., New York 19, N. Y.
- ⊙ Amperex Electronic Corp., 25 Washington St., Brook-lynn 1, N. Y.
- ⊙ Bomac Laboratories, Inc., Salem Rd., Beverly, Mass.
- ⊙ CHATHAM ELECTRONICS CORP., 475 Washington St., Newark 2, N. J. ADV. PG. 46.
- ⊙ CONTINENTAL ELECTRIC CO., Geneva, Ill. ADV. PG. 182.
- ⊙ DuMont Laboratories, Inc., Allen B., Cathode-ray Tube Div., 750 Bloomfield Ave., Clifton, N. J.
- ⊙ Electronic Engineering Corp., 469 Elm St., Arlington, N. J.
- ⊙ Electronic Enterprises, Inc., 65 7th Ave., Newark 4, N. J.
- ⊙ Electronic Products Co., 111 E. Third St., Mt. Ver-non, N. Y.
- ⊙ ELECTRONS INC., 127 Sussex Ave., Newark 4, N. J. ADV. PG. 174.
- ⊙ FEDERAL TELEPHONE & RADIO CORP., 88 Kings-land Rd., Clifton, N. J. ADV. PG. 161-163.
- ⊙ GENERAL ELECTRIC CO., Electronics Dept., Tube Div., Schenectady 5, N. Y. ADV. PG. 1 to 22.
- ⊙ GENERAL ELECTRONICS, INC., 101 Hazel St., Pater-son, N. J. ADV. PG. 326.
- ⊙ International Electronics Corp., 137 Hudson St., New York, N. Y.
- ⊙ Kuthe Laboratories, Inc., 150 Summit St., Newark 4, N. J.
- ⊙ NATIONAL ELECTRONICS, INC., Geneva, Ill. ADV. PG. 218.
- ⊙ NATIONAL UNION RADIO CORP., 350 Scotland Rd., Orange, N. J. ADV. PG. 296.
- ⊙ RADIO CORP. OF AMERICA, Tube Dept., Harrison, N. J. ADV. PG. 177, Inside Back & Back Covers.
- ⊙ RAYTHEON MFG. CO., Receiving & Special Tube Div., 55 Chapel St., Newton 58, Mass. ADV. PG. 80, 81.
- Ross Mfg. Co., 860 Washington St., Burlington, Iowa.
- ⊙ Standard Arcturus Corp., 54 Clark St., Newark 4, N. J.
- ⊙ Standard Telephones & Cables Ltd., Connaught House, Aldwych, London, W. C. 2, England.
- ⊙ SYLVANIA ELECTRIC PRODUCTS, INC., 1740 Broad-way, New York 19, N. Y. ADV. PG. 432-436.
- ⊙ TAYLOR TUBES, INC., 2312 Wabansia Ave., Chicago 47, Ill. ADV. PG. 260.
- ⊙ UNITED ELECTRONICS CO., 42 Spring St., Newark 2, N. J. ADV. PG. 139-141.
- ⊙ WESTINGHOUSE ELECTRIC CORP., Electronic Tube Sales Dept., Bloomfield, N. J. ADV. PG. 114, 115.

TUBES—Transmitting and Power

- ⊙ Amperex Electronic Corp., 25 Washington St., Brook-lynn, N. Y.
- ⊙ CHATHAM ELECTRONICS CORP., 475 Washington St., Newark 2, N. J. ADV. PG. 46.
- ⊙ Eitel-McCullough, Inc., San Bruno, Calif.
- ⊙ Electronic Enterprises, Inc., 65 7th Ave., Newark 4, N. J.
- ⊙ Electronic Products Co., 111 E. Third St., Mt. Vernon, N. Y.
- ⊙ FEDERAL TELEPHONE AND RADIO CORP., 88 Kings-land Rd., Clifton, N. J. ADV. PG. 161-163.
- ⊙ GENERAL ELECTRIC CO., Electronics Dept., Tube Div., Schenectady 5, N. Y. ADV. PG. 1 to 22.
- ⊙ GENERAL ELECTRONICS, INC., 101 Hazel St., Pater-son, N. J. ADV. PG. 326.
- ⊙ HAYDU BROTHERS, Plainfield, N. J. ADV. PG. 55.
- ⊙ HEINTZ & KAUFMAN DIV. OF THE ROBERT DOLLAR CO., 947 Broadway, Redwood City, Calif. ADV. PG. 301.
- ⊙ Hytron Radio & Electronics Corp., 76 Lafayette St., Salem, Mass.
- ⊙ Kuthe Laboratories, Inc., 150 Summit St., Newark 4, N. J.
- ⊙ Lewis & Kaufman, Inc., P. O. Box 337, 90 El Rancho Ave., Los Gatos, Calif.
- ⊙ MACHLETT LABORATORIES, Springdale, Conn. ADV. PG. 265.
- ⊙ NATIONAL UNION RADIO CORP., 350 Scotland Rd., Orange, N. J. ADV. PG. 296.
- ⊙ RADIO CORP. OF AMERICA, Tube Dept., Harrison, N. J. ADV. PG. 177, Inside Back & Back Covers.
- ⊙ RAYTHEON MFG. CO., Power Tube Div., Waltham 54, Mass. ADV. PG. 80, 81.
- ⊙ Standard Arcturus Corp., 54 Clark St., Newark 4, N. J.
- ⊙ Standard Telephones & Cables Ltd., Connaught House, Aldwych, London, W. C. 2, England.
- ⊙ SYLVANIA ELECTRIC PRODUCTS, INC., 1740 Broad-way, New York 19, N. Y. ADV. PG. 432-436.
- ⊙ TAYLOR TUBES, INC., 2312 W. Wabansia Ave., Chi-cago 47, Ill. ADV. PG. 260.
- ⊙ TUNG-SOL LAMP WORKS INC., 95 Eighth Ave., New-ark 4, N. J. ADV. PG. 169.
- ⊙ UNITED ELECTRONICS CO., 42 Spring St., Newark 2, N. J. ADV. PG. 139-141.
- ⊙ WESTINGHOUSE ELECTRIC CORP., Electronic Tube Sales Dept., Bloomfield, N. J. ADV. PG. 114, 115.

TUBES—TR and Anti TR

- ⊙ Bomac Laboratories, Inc., Salem Rd., Beverly, Mass.
- ⊙ ECLIPSE-PIONEER DIV., Bendix Aviation Corp., Teter-boro, N. J. ADV. PG. 198, 199.
- ⊙ GENERAL ELECTRIC CO., Electronics Dept., Tube Div., Schenectady 5, N. Y. ADV. PG. 1 to 22.
- ⊙ RAYTHEON MFG. CO., Power Tube Div., Waltham 54, Mass. ADV. PG. 80, 81.
- ⊙ Standard Arcturus Corp., 54 Clark St., Newark 4, N. J.
- ⊙ SYLVANIA ELECTRIC PRODUCTS, INC., 1740 Broad-way, New York 19, N. Y. ADV. PG. 432-436.
- ⊙ WESTINGHOUSE ELECTRIC CORP., Electronic Tube Sales Dept., Bloomfield, N. J. ADV. PG. 114, 115.

TUBES—uhf

- ⊙ Amperex Electronic Corp., 25 Washington St., Brook-lynn 1, N. Y.
- ⊙ ECLIPSE-PIONEER DIV., Bendix Aviation Corp., Teter-boro, N. J. ADV. PG. 198, 199.
- ⊙ Eitel-McCullough, Inc., San Bruno, Calif.
- ⊙ FEDERAL TELEPHONE & RADIO CORP., 88 Kings-land Rd., Clifton, N. J. ADV. PG. 161-163.
- ⊙ GENERAL ELECTRIC CO., Electronics Dept., Tube Div., Schenectady 5, N. Y. ADV. PG. 1 to 22.
- ⊙ GENERAL ELECTRONICS, INC., 101 Hazel St., Pater-son, N. J. ADV. PG. 326.
- ⊙ HEINTZ & KAUFMAN, DIV. OF THE ROBERT DOLLAR CO., 947 Broadway, Redwood City, Calif. ADV. PG. 301.
- ⊙ Hytron Radio & Electronics Corp., 76 Lafayette St., Salem, Mass.
- ⊙ International Electronics Corp., 137 Hudson St., New York, N. Y.
- ⊙ Kemtron Electron Products, Inc., 23 Brown St., Salem, Mass.
- ⊙ Lewis & Kaufman, Inc., P. O. Box 337, 90 El Rancho Ave., Los Gatos, Calif.
- ⊙ MACHLETT LABORATORIES, Springdale, Conn. ADV. PG. 265.
- ⊙ NATIONAL UNION RADIO CORP., 350 Scotland Rd., Orange, N. J. ADV. PG. 296.
- ⊙ RADIO CORP. OF AMERICA, Tube Dept., Harrison, N. J. ADV. PG. 177, Inside Back & Back Covers.
- ⊙ RAYTHEON MFG. CO., Receiving & Special Tube Div., 55 Chapel St., Newton 58, Mass. ADV. PG. 80, 81.
- ⊙ SPERRY GYROSCOPE CO., Div. of The Sperry Corp., Great Neck, N. Y. ADV. PG. 103, 104.
- ⊙ Standard Arcturus Corp., 54 Clark St., Newark 4, N. J.
- ⊙ Standard Telephones & Cables Ltd., Connaught House, Aldwych, London, W. C. 2, England.
- ⊙ SYLVANIA ELECTRIC PRODUCTS, INC., 1740 Broad-way, New York 19, N. Y. ADV. PG. 432-436.
- ⊙ TAYLOR TUBES, INC., 2312 Wabansia Ave., Chicago 47, Ill. ADV. PG. 260.
- ⊙ UNITED ELECTRONICS CO., 42 Spring St., Newark 2, N. J. ADV. PG. 139-141.
- ⊙ Varian Associates, 99 Washington St., San Carlos, Calif.
- ⊙ WESTINGHOUSE ELECTRIC CORP., Electronic Tube Sales Dept., Bloomfield, N. J. ADV. PG. 114, 115.

TUBES—Vacuum Thermocouple

- ⊙ Cossor (Canada) Ltd., 301-303 Windsor St., Halifax, N. S., Canada.
- ⊙ ECLIPSE-PIONEER DIV., Bendix Aviation Corp., Teter-boro, N. J. ADV. PG. 198, 199.
- ⊙ GENERAL ELECTRIC CO., Schenectady 5, N. Y. ADV. PG. 1 to 22.
- ⊙ HEINTZ & KAUFMAN DIV. OF THE ROBERT DOLLAR CO., 947 Broadway, Redwood City, Calif. ADV. PG. 301.
- ⊙ National Research Corp., 70 Memorial Drive, Cam-bridge 42, Mass.
- ⊙ RADIO CORP. OF AMERICA, Tube Dept., Harrison, N. J. ADV. PG. 177, Inside Back & Back Covers.
- ⊙ RAYTHEON MFG. CO., Receiving & Special Tube Div., 55 Chapel St., Newton 58, Mass. ADV. PG. 80, 81.
- ⊙ Reeder & Co., Charles M., 171 Victor Ave., Detroit 3, Mich.
- ⊙ Standard Telephones & Cables Ltd., Connaught House, Aldwych, London, W. C. 2, England.
- ⊙ Wheelco Instruments Co., 847 W. Harrison St., Chi-cago 7, Ill.

TUBES—Voltage Regulating

- Aerolux Light Corp., 653 11th Ave., New York 19, N. Y.
- ⊙ Amperex Electronic Corp., 25 Washington St., Brook-lynn 1, N. Y.
- ⊙ Anton Electronic Laboratories, Inc., 1226-1238 Flush-ing Ave., Brooklyn 6, N. Y.
- ⊙ CHATHAM ELECTRONICS CORP., 475 Washington St., Newark 2, N. J.
- ⊙ ECLIPSE-PIONEER DIV., Bendix Aviation Corp., Teter-boro, N. J. ADV. PG. 198, 199.
- ⊙ Electronic Enterprises, Inc., 65 7th Ave., Newark 4, N. J.
- ⊙ Electronic Products Co., 111 E. Third St., Mt. Vernon, N. Y.

- ⊙ GENERAL ELECTRIC CO., Electronics Dept., Tube Div., Schenectady 5, N. Y. ADV. PG. 1 to 22.
- ⊙ Hytron Radio & Electronics Corp., 76 Lafayette St., Salem, Mass.
- ⊙ Kuthe Laboratories, Inc., 150 Summit St., Newark 4, N. J.
- ⊙ NATIONAL UNION RADIO CORP., 350 Scotland Rd., Orange, N. J. ADV. PG. 296.
- ⊙ Philco Corp., Tioga & C Sts., Philadelphia 34, Pa.
- ⊙ RADIO CORP. OF AMERICA, Tube Dept., Harrison, N. J. ADV. PG. 177, Inside Back & Back Covers.
- ⊙ RAYTHEON MFG. CO., Receiving & Special Tube Div., 55 Chapel St., Newton 58, Mass. ADV. PG. 80, 81.
- ⊙ Standard Arcturus Corp., 54 Clark St., Newark 4, N. J.
- ⊙ Standard Telephones & Cables Ltd., Connaught House, Aldwych, London, W. C. 2, England.
- ⊙ SYLVANIA ELECTRIC PRODUCTS, INC., 1740 Broad-way, New York 19, N. Y. ADV. PG. 432-436.
- ⊙ WESTINGHOUSE ELECTRIC CORP., Electronic Tube Sales Dept., Bloomfield, N. J. ADV. PG. 114, 115.

TUBES—X-Ray

- ⊙ Amperex Electronic Corp., 25 Washington St., Brook-lynn 1, N. Y.
- ⊙ General Electric X-Ray Corp., 4855 Electric Ave., Milwaukee, Wis.
- ⊙ MACHLETT LABORATORIES, Springdale, Conn. ADV. PG. 265.
- ⊙ North American Philips Co., Inc., 100 East 42nd St., New York, N. Y.
- ⊙ Picker X-Ray Corp., 300 Fourth Ave., New York 10, N. Y.
- ⊙ Standard Telephones & Cables Ltd., Connaught House, Aldwych, London W. C. 2, England.
- ⊙ WESTINGHOUSE ELECTRIC CORP., Electronic Tube Sales Dept., Bloomfield, N. J. ADV. PG. 114, 115.

TUBING—Aluminum Waveguide

- ⊙ Microwave Equipment Co., Inc., North Caldwell, N. J.
- ⊙ Revere Copper & Brass, Inc., 230 Park Ave., New York 17, N. Y.
- ⊙ Standard Metals Corp., 262 Broad St., North Attle-boro, Mass.
- ⊙ SUPERIOR TUBE CO., 2504 Germantown Pike, Nor-ristown, Pa. ADV. PG. 64, 65.
- ⊙ TITFLEX, INC., 500 Frelinghuysen Ave., Newark 5, N. J. ADV. PG. 68.
- ⊙ Uniform Tubes, Shurs Lane & Laruiston St., Rox-borough, Philadelphia, Pa.

TUBING—Brass or Copper

- ⊙ AMERICAN BRASS CO., 25 Broadway, New York 4, N. Y. ADV. PG. 330.
- ⊙ Bridgeport Brass Co., 30 Grand St., Bridgeport, Conn.
- ⊙ Chase Brass & Copper Co., Inc., 236 Grand St., Wa-terbury 20, Conn.
- ⊙ Ilisco Copper Tube & Products, Inc., Marlemont Ave., Marlemont, Cincinnati 27, Ohio.
- ⊙ Phelps Dodge Copper Products Corp., 40 Wall St., New York 5, N. Y.
- ⊙ Precision Tube Co., 3828 Terrace St., Philadelphia 28, Pa.
- ⊙ Revere Copper & Brass, Inc., 230 Park Ave., New York 17, N. Y.
- ⊙ Shutter, Carl W., Rockville Centre, N. Y.
- ⊙ Standard Metals Corp., 262 Broad St., North Attle-boro, Mass.
- ⊙ Uniform Tubes, Shurs Lane & Laruiston St., Roxbor-ough, Philadelphia, Pa.

TUBING—Ceramic

- ⊙ AMERICAN LAVA CORP., Chattanooga 5, Tenn. ADV. PG. 143.
- Birnback Radio Co., Inc., 145 Hudson St., New York, N. Y.
- ⊙ CENTRAL LAB DIV. OF GLOBE-UNION, INC., 900 E. Keefe Ave., Milwaukee 1, Wis. ADV. PG. 85-88.
- ⊙ CROWLEY & CO., INC., Henry L., 1 Central Ave., West Orange, N. J. ADV. PG. 231.
- ⊙ Electrical Refractories Co., 50 Clark St., East Pales-line, Ohio.
- ⊙ Isolantite Mfg. Corp., Stirling, N. J.
- ⊙ Kirchberger & Co., Inc., M., 1425 37th St., Brooklyn 18, N. Y.
- ⊙ LOUTHAN MFG. CO., East Liverpool, Ohio. ADV. PG. 284.
- ⊙ Mykroy, Inc., Arlington Heights Airport, Arlington Heights, Ill.
- ⊙ Norton Co., 1 New Bond St., Worcester 6, Mass.
- ⊙ Star Porcelain Co., 61 Muirhead Ave., Trenton 9, N. J.
- ⊙ Steward Mfg. Co., D. M., Chattanooga 1, Tenn.
- ⊙ STUPAKOFF CERAMIC & MFG. CO., Latrobe, Pa. ADV. PG. 167.
- ⊙ THOR CERAMICS INC., 225 Belleville Ave., Bloom-field, N. J. ADV. PG. 378.
- ⊙ Western Gold & Platinum Works, 589 Bryant St., San Francisco, Calif.
- ⊙ Wisconsin Porcelain Co., Sun Prairie, Wis.

V indicates . . . IN PRODUCTION • AVAILABILITY • UNRESTRICTED FOR GENERAL USE

TUBING—Fabric

- **BRAND & CO., INC., WILLIAM**, North & Valley Sts., Willimantic, Conn. ADV. PG. 248, 249.
- **Dielectric Materials Co.**, 5315-17 N. Ravenswood Ave., Chicago 40, Ill.
- **Franklin Fibre-Lamitex Corp.**, 12th and French Sts., Wilmington, Delaware.
- **General Cement Mfg. Co.**, 919 Taylor Ave., Rockford, Ill.
- **Insulating Fabricators of New England, Inc.**, 69 Grove St., Watertown 72, Mass.
- **Insulating Tube Co.**, 26 Cottage St., P. O. Box 1, Poughkeepsie, N. Y.
- **Insuline Corp. of America**, 36-02 35th Ave., Long Island City, N. Y.
- **IRVINGTON VARNISH & INSULATOR CO.**, 6 Argyle Terrace, Irvington 11, N. J. ADV. PG. 92, 93.
- **KELLER PRODUCTS CO.**, 41 Union St., Manchester, N. H. ADV. PG. 397.
- **MITCHELL-RAND INSULATION CO., INC.**, 51 Murray St., New York 7, N. Y. ADV. PG. 219.
- **National Electric Coil Co.**, Columbus 16, Ohio.
- **NATIONAL VARNISHED PRODUCTS CORP.**, 211 Randolph Ave., Woodbridge, N. J. ADV. PG. 152.
- **Varflex Corp.**, 308 N. Jay St., Rome, N. Y.

TUBING—Fibre

- **Baer Co., N. S.**, 9 Montgomery St., Hillside, N. J.
- **Brandywine Fibre Co.**, 15th & Poplar Sts., Wilmington, Del.
- **CLEVELAND CONTAINER CO., THE**, 6201 Barberton Ave., Cleveland 2, Ohio. ADV. PG. 89.
- **CONTINENTAL-DIAMOND FABRE CO.**, Newark 100, Del. ADV. PG. 25-32.
- **Cortland Industries, Inc.**, 4545 Cortland St., Chicago 39, Ill.
- **Franklin Fibre-Lamitex Corp.**, 12th & French Sts., Wilmington, Del.
- **Insulating Fabricators of New England, Inc.**, 69 Grove St., Watertown 72, Mass.
- **Insuline Corp. of America**, 36-02 35th Ave., Long Island City, N. Y.
- **MITCHELL-RAND INSULATION CO., INC.**, 51 Murray St., New York 7, N. Y. ADV. PG. 219.
- **National Gasket & Mfg. Co., Inc.**, 124 E. 25th St., New York 10, N. Y.
- **NATIONAL VULCANIZED FIBRE CO.**, Wilmington, Del. ADV. PG. 251.
- **Penn Fibre & Specialty Co.**, 2020 E. Westmoreland St., Philadelphia 44, Pa.
- **Spaulding Fibre Co., Inc.**, 310 Wheeler St., Tonawanda, N. Y.

TUBING—Fused Quartz

- **Dallons Labs.**, 5066 Santa Monica Blvd., Los Angeles, Calif.
- **GENERAL ELECTRIC CO.**, Lamp Dept., Nela Park, Cleveland 12, Ohio. ADV. PG. 1 to 22.
- **SYNCOR PRODUCTS CO.**, Malden, Mass. ADV. PG. 405.

TUBING—Glass

- **Bache & Co., Semon**, 636 Greenwich St., New York, N. Y.
- **Brandywine Fibre Co.**, 15th & Poplar Sts., Wilmington, Del.
- **CORNING GLASS WORKS**, Corning, N. Y. ADV. PG. 373.
- **Fischer & Porter Co.**, Hatboro, Pa.
- **GENERAL ELECTRIC CO.**, Lamp Dept., Nela Park, Cleveland 12, Ohio. ADV. PG. 1 to 22.

TUBING—Glass Fibre Insulation

- **ACCURATE PAPER TUBE CO.**, 851 N. Noble St., Chicago 22, Ill. ADV. PG. 413.
- **BENTLEY-HARRIS MFG. CO.**, Conshohocken, Pa. ADV. PG. 269.
- **BRAND & CO., INC., WILLIAM**, North & Valley Sts., Willimantic, Conn. ADV. PG. 248, 249.
- **Brandywine Fibre Co.**, 15th & Poplar Sts., Wilmington, Del.
- **Dielectric Materials Co.**, 5315-17 N. Ravenswood Ave., Chicago 40, Ill.
- **Insulating Fabricators of New England, Inc.**, 69 Grove St., Watertown 72, Mass.
- **IRVINGTON VARNISH & INSULATOR CO.**, 6 Argyle Terrace, Irvington 11, N. J. ADV. PG. 92, 93.
- **KELLER PRODUCTS CO.**, 41 Union St., Manchester, N. H. ADV. PG. 397.
- **MITCHELL-RAND INSULATION CO., INC.**, 51 Murray St., New York 7, N. Y. ADV. PG. 219.
- **National Electric Coil Co.**, Columbus 16, Ohio.
- **NATIONAL VARNISHED PRODUCTS CORP.**, 211 Randolph Ave., Woodbridge, N. J. ADV. PG. 152.
- **NATIONAL VULCANIZED FIBRE CO.**, Wilmington, Del. ADV. PG. 251.
- **Penn Fibre & Specialty Co.**, 2020 E. Westmoreland St., Philadelphia 44, Pa.
- **Varflex Corp.**, 308 N. Jay St., Rome, N. Y.

TUBING—Knitted Wire

- **METAL TEXTILE CORP.**, 647 E. First Ave., Roselle, N. J. ADV. PG. 40.

TUBING—Metal and Alloy

- **Alpha Metals, Inc.**, 365 Hudson Ave., Brooklyn 1, N. Y.
- **BART LABS., CO., INC.**, 227 Main St., Belleville 9, N. J. ADV. PG. 148.
- **Bishop & Co., J.**, Platinum Works, Malvern, Pa.
- **Bridgeport Brass Co.**, 30 Grand St., Bridgeport, Conn.
- **Chase Brass & Copper Co., Inc.**, 236 Grand St., Waterbury 20, Conn.
- **Fansteel Metallurgical Corp.**, 2200 Sheridan Rd., North Chicago, Ill.
- **Haynes Stellite Co.**, Division of Union Carbide & Carbon Corp., Kokomo, Indiana.
- **IMPROVED SEAMLESS WIRE CO.**, 775 Eddy St., Providence, R. I. ADV. PG. 314.
- **International Nickel Co., Inc.**, 67 Wall St., New York 5, N. Y.
- **ONEY CO., J. M.**, 179 Elm St., Hartford, Conn. ADV. PG. 246.
- **Precision Tube Co.**, 3828 Terrace St., Philadelphia 28, Pa.
- **Production Engineering Co.**, 173 Sargeant Ave., Clifton, N. J.
- **Revere Copper & Brass, Inc.**, 230 Park Avenue, New York 17, N. Y.
- **Standard Metals Corp.**, 262 Broad St., North Attleboro, Mass.
- **Summerill Tubing Co.**, Div. Columbia Steel & Shafting Co., P. O. Box 1557, Pittsburgh 30, Pa.
- **SUPERIOR TUBE CO.**, 2504 Germantown Pike, Norristown, Pa. ADV. PG. 64, 65.
- **SYLVANIA ELECTRIC PRODUCTS, INC.**, 1740 Broadway, New York 19, N. Y. ADV. PG. 432-436.
- **Uniform Tubes, Shurs Lane & Laruiston St.**, Roxborough, Philadelphia, Pa.

TUBING—Mica

- **Asheville-Schoonmaker Mica Co.**, 900 Jefferson Ave., Newport News, Va.
- **CONTINENTAL DIAMOND FIBRE CO.**, Newark 100, Del. ADV. PG. 25-32.
- **GENERAL ELECTRIC CO.**, Chemical Dept., Pittsfield, Mass. ADV. PG. 1 to 22.
- **Mica Insulator Co.**, Schenectady 1, N. Y.

TUBING—Nickel

- **BART LABS., CO., INC.**, 227 Main St., Belleville 9, N. J. ADV. PG. 148.
- **Bishop & Co., J.**, Platinum Works, Malvern, Pa.
- **International Nickel Co., Inc.**, 67 Wall St., New York 5, N. Y.
- **Precision Tube Co.**, 3828 Terrace St., Philadelphia 28, Pa.
- **Standard Metals Corp.**, 262 Broad St., North Attleboro, Mass.
- **SUPERIOR TUBE CO.**, 2504 Germantown Pike, Norristown, Pa. ADV. PG. 64, 65.
- **SYLVANIA ELECTRIC PRODUCTS, INC.**, 1740 Broadway, New York 19, N. Y. ADV. PG. 432-436.

TUBING—Paper

- **ACCURATE PAPER TUBE CO.**, 851 N. Noble St., Chicago 22, Ill. ADV. PG. 413.
- **CLEVELAND CONTAINER CO., THE**, 6201 Barberton Ave., Cleveland 2, Ohio. ADV. PG. 89.
- **Cortland Industries, Inc.**, 4545 Cortland St., Chicago 39, Ill.
- **Franklin Fibre-Lamitex Corp.**, 12th and French Sts., Wilmington, Del.
- **PARAMOUNT PAPER TUBE CORP.**, 614 Lafayette St., Fort Wayne 4, Ind. ADV. PG. 348.
- **Penn Fibre & Specialty Co.**, 2020 E. Westmoreland St., Philadelphia 44, Pa.
- **PRECISION PAPER TUBE CO.**, 2033 W. Charleston St., Chicago 47, Ill. ADV. PG. 156.

TUBING—Plastic

- **AMERICAN MOLDED PRODUCTS CO.**, 1644 N. Honore St., Chicago 22, Ill. ADV. PG. 382.
- **B & C Insulation Products, Inc.**, Lincoln Highway, Iselin, N. J.
- **Baer Co., N. S.**, 9 Montgomery St., Hillside, N. J.
- **Birnbach Radio Co., Inc.**, 145 Hudson St., New York, N. Y.
- **BRAND & CO., INC., WILLIAM**, North & Valley Sts., Willimantic, Conn. ADV. PG. 248, 249.
- **Brandywine Fibre Co.**, 15th & Poplar Sts., Wilmington, Del.
- **CLEVELAND CONTAINER CO., THE**, 6201 Barberton Ave., Cleveland 2, Ohio. ADV. PG. 89.
- **CONTINENTAL DIAMOND FIBRE CO.**, Newark 100, Del. ADV. PG. 25-32.
- **Cortland Industries, Inc.**, 4545 Cortland St., Chicago 39, Ill.

- **Dielectric Materials Co.**, 5315-17 N. Ravenswood Ave., Chicago 40, Ill.
- **Formica Co., The**, 4640 Spring Grove Ave., Cincinnati 32, Ohio.
- **Franklin Fibre-Lamitex Corp.**, 12th & French Sts., Wilmington, Del.
- **GENERAL ELECTRIC CO.**, Chemical Dept., Pittsfield, Mass. ADV. PG. 1 to 22.
- **Gering Products, Inc.**, N. 7th St. at Monroe Ave., Kenilworth, N. J.
- **Houghton Laboratories, Inc.**, 322 Bush St., Olean, N. Y.
- **Industrial Synthetics Corp.**, 225 North Ave., Garwood, N. J.
- **Insulating Fabricators of New England, Inc.**, 69 Grove St., Watertown 72, Mass.
- **Insulating Tube Co.**, 26 Cottage St., P. O. Box 1, Poughkeepsie, N. Y.
- **Insuline Corp. of America**, 36-02 35th Ave., Long Island City, N. Y.
- **IRVINGTON VARNISH & INSULATOR CO.**, 6 Argyle Terrace, Irvington 11, N. J. ADV. PG. 92, 93.
- **KELLER PRODUCTS CO.**, 41 Union St., Manchester, N. H. ADV. PG. 397.
- **Keystone Electronics Co.**, 423 Broome St., New York 12, N. Y.
- **Mica Insulator Co.**, Schenectady 1, N. Y.
- **MITCHELL-RAND INSULATION CO., INC.**, 51 Murray St., New York 7, N. Y. ADV. PG. 219.
- **NATIONAL VARNISHED PRODUCTS CORP.**, 211 Randolph Ave., Woodbridge, N. J. ADV. PG. 152.
- **NATIONAL VULCANIZED FIBRE CO.**, Wilmington, Del. ADV. PG. 251.
- **Panelite Div., St. Regis Paper Co.**, 230 Park Ave., New York, N. Y.
- **Parkwood Corp.**, Wakefield, Mass.
- **Penn Fibre & Specialty Co.**, 2020 E. Westmoreland St., Philadelphia 44, Pa.
- **Plasticraft Products Co.**, 20 Hudson St., New York 13, N. Y.
- **Plax Corp.**, P. O. Box 1019, Hartford, Conn.
- **PRECISION PAPER TUBE CO.**, 2033 W. Charleston St., Chicago 47, Ill. ADV. PG. 156.
- **RICHARDSON CO., THE**, 2767 Lake St., Melrose Park, Ill. ADV. PG. 310.
- **Schott Co.**, Walter L., 3225 Exposition Pl., Los Angeles 18, Calif.
- **Smith, Inc., Herman H.**, 436 18th St., Brooklyn 15, N. Y.
- **Spaulding Fibre Co., Inc.**, 310 Wheeler St., Tonawanda, N. Y.
- **Surprenant Mfg. Co.**, 199 Washington St., Boston 10, Mass.
- **Synthane Corp.**, Oaks, Pa.
- **Taylor Fibre Co.**, Norristown, Pa.
- **TEFLON PRODUCTS DIVISION, U. S. GASKET CO.**, P. O. Box 93, Camden, N. J. ADV. PG. 176.
- **Transradio, Ltd.**, 138 A Cromwell Rd., London S. W. 7, England.
- **United States Rubber Co.**, 1230 Avenue of the Americas, New York 20, N. Y.
- **U. S. Stoneware Co., The**, Akron 9, Ohio.
- **Varflex Corp.**, 308 N. Jay St., Rome, N. Y.

TUBING—Precious Metal

- **AMERICAN PLATINUM WORKS**, N. J. R. R. Ave. at Oliver St., Newark 5, N. J. ADV. PG. 76.
- **BART LABS., CO., INC.**, 227 Main St., Belleville 9, N. J. ADV. PG. 148.
- **Bishop & Co., J.**, Platinum Works, Malvern, Pa.
- **BRAININ CO., C. S.**, 320 Washington St., Mount Vernon, N. Y. ADV. PG. 142.
- **MAKEPEACE CO., D. E.**, Attleboro, Mass. ADV. PG. 72.
- **ONEY CO., J. M.**, 179 Elm St., Hartford, Conn. ADV. PG. 246.
- **SAMUEL & CO., INC., J. A.**, 220 Broadway, New York 7, N. Y. ADV. PG. 413.
- **Secon Metals Corp.**, 228 E. 45th St., New York 17, N. Y.
- **Standard Metals Corp.**, 262 Broad St., North Attleboro, Mass.
- **Wildberg Bros. Smelting & Refining Co.**, 742 Market St., San Francisco 2, Calif.

TUBING—Steel

- **Armco Steel Corp.**, 703 Curtis St., Middletown, Ohio.
- **Bishop & Co., J.**, Platinum Works, Malvern, Pa.
- **Carpenter Steel Co., The**, 142 W. Bern St., Reading, Pa.
- **CRUCIBLE STEEL CO. OF AMERICA**, 405 Lexington Ave., New York 17, N. Y. ADV. PG. 225.
- **Production Engineering Co.**, 173 Sargeant Ave., Clifton, N. J.
- **Republic Steel Corp.**, Republic Bldg., Cleveland 1, Ohio.
- **Revere Copper & Brass Inc.**, 230 Park Avenue, New York 17, N. Y.
- **Summerill Tubing Co.**, Div. Columbia Steel & Shafting Co., P. O. Box 1557, Pittsburgh 30, Pa.
- **SUPERIOR TUBE CO.**, 2504 Germantown Pike, Norristown, Pa. ADV. PG. 64, 65.
- **Uniform Tubes, Shurs Lane & Laruiston St.**, Roxborough, Philadelphia, Pa.

Ⓜ indicates . . . IN PRODUCTION • AVAILABILITY • UNRESTRICTED FOR GENERAL USE

TUBING—Synthetic Resin

- Ⓜ BRAND & CO., INC., WILLIAM, North & Valley Sts., Willimantic, Conn. ADV. PG. 248, 249.
- Brandywine Fibre Co., 15th & Poplar Sts., Wilmington, Del.
- Ⓜ CLEVELAND CONTAINER CO., THE, 6201 Barberton Ave., Cleveland 2, Ohio. ADV. PG. 89.
- Ⓜ CONTINENTAL DIAMOND FIBRE CO., Newark 100, Del. ADV. PG. 25, 32.
- Ⓜ Dielectric Materials Co., 5315-17 N. Ravenswood Ave., Chicago 40, Ill.
- Ⓜ Industrial Synthetics Corp., 225 North Ave., Garwood, N. J.
- Ⓜ Insulating Tube Co., 26 Cottage St., P. O. Box 1, Poughkeepsie, N. Y.
- Ⓜ MITCHELL-RAND INSULATION CO., INC., 51 Murray St., New York 7, N. Y. ADV. PG. 219.
- Ⓜ Parkwood Corp., Wakefield, Mass.
- Ⓜ Penn Fibre & Specialty Co., 2020 E. Westmoreland St., Philadelphia 44, Pa.
- Ⓜ RICHARDSON CO., THE, 2767 Lake St., Melrose Park, Ill. ADV. PG. 310.
- Ⓜ Surprenant Mfg. Co., 199 Washington St., Boston 10, Mass.
- Ⓜ Synthane Corp., Oaks, Pa.
- Ⓜ U. S. Stoneware Co., The, Akron 9, Ohio.
- Ⓜ Varflex Corp., 308 Jay St., Rome, N. Y.
- Western Felt Works, 4029 Ogden Ave., Chicago, Ill.
- Ⓜ WESTINGHOUSE ELECTRIC CORP., 511 Wood St., P. O. Box 868, Pittsburgh 30, Pa. ADV. PG. 107-113.

TUBING—Varnished or Lacquered

- B & C Insulation Products, Inc., Lincoln Highway, Iselin, N. J.
- Ⓜ BENTLEY-HARRIS MFG. CO., Conshocken, Pa. ADV. PG. 269.
- Birnback Radio Co., Inc., 145 Hudson St. New York, N. Y.
- Ⓜ BRAND & CO., INC., WILLIAM, North & Valley Sts., Willimantic, Conn. ADV. PG. 248, 249.
- Ⓜ CLEVELAND CONTAINER CO., THE, 6201 Barberton Ave., Cleveland 2, Ohio. ADV. PG. 89.
- Ⓜ Dielectric Materials Co., 5315-17 N. Ravenswood Ave., Chicago 40, Ill.
- Ⓜ FEDERAL SCREW PRODUCTS INC., 224 W. Huron St., Chicago 10, Ill. ADV. PG. 76.
- Ⓜ General Cement Mfg. Co., 919 Taylor Ave., Rockford, Ill.
- Ⓜ Insulating Fabricators of New England, Inc., 69 Grove St., Watertown 72, Mass.
- Ⓜ IRVINGTON VARNISH & INSULATOR CO., 6 Argyle Terrace, Irvington 11, N. J. ADV. PG. 92, 93.
- Ⓜ JFD MFG. CO., 6101-23 Sixteenth Ave., Brooklyn, N. Y. ADV. PG. 407.
- Ⓜ MITCHELL-RAND INSULATION CO., INC., 51 Murray St., New York 7, N. Y. ADV. PG. 219.
- Ⓜ National Electric Coil Co., Columbus 16, Ohio.
- Ⓜ NATIONAL VARNISHED PRODUCTS CORP., 211 Randolph Ave., Woodbridge, N. J. ADV. PG. 152.
- Ⓜ Philco Corp., Tioga & C Sts., Philadelphia 34, Pa.
- Ⓜ PRECISION PAPER TUBE CO., 2033 W. Charleston St., Chicago 47, Ill. ADV. PG. 156.
- Ⓜ Schott Co., Walter L., 3225 Exposition Pl., Los Angeles 18, Calif.
- Ⓜ Varflex Corp., 308 N. Jay St., Rome, N. Y.

TUBING—Varnished Cambric Insulation

- Ⓜ BENTLEY-HARRIS MFG. CO., Conshocken, Pa. ADV. PG. 269.
- Ⓜ BRAND & CO., INC., WILLIAM, North & Valley Sts., Willimantic, Conn. ADV. PG. 248, 249.
- Ⓜ Dielectric Materials Co., 5315-17 N. Ravenswood Ave., Chicago 40, Ill.
- Ⓜ General Cement Mfg. Co., 919 Taylor Ave., Rockford, Ill.
- Ⓜ Insuline Corp. of America, 36-02 35th Ave., Long Island City, N. Y.
- Ⓜ IRVINGTON VARNISH & INSULATOR CO., 6 Argyle Terrace, Irvington 11, N. J. ADV. PG. 92, 93.
- Ⓜ MITCHELL-RAND INSULATION CO., INC., 51 Murray St., New York 7, N. Y. ADV. PG. 219.
- Ⓜ NATIONAL VARNISHED PRODUCTS CORP., 211 Randolph Ave., Woodbridge, N. J. ADV. PG. 152.
- Ⓜ Schott Co., Walter L., 3225 Exposition Pl., Los Angeles 18, Calif.
- Ⓜ Varflex Corp., 308 N. Jay St., Rome, N. Y.

TUNERS—*a-m*

- Ⓜ Altec Lansing Corp., 9356 Santa Monica Blvd., Beverly Hills, Calif.
- Ⓜ Approved Electronic Instrument Corp., 142 Liberty St., New York 6, N. Y.
- Ⓜ BARKER & WILLIAMSON, 235 Fairfield Ave., Upper Darby, Pa. ADV. PG. 292.
- Ⓜ Bogen Co., Inc., David, 663 Broadway, New York 12, N. Y.
- Ⓜ Collins Audio Products Co., P. O. Box 368, Westfield, N. J.
- Ⓜ Delco Radio Div., General Motors Corp., Kokomo, Ind.
- Ⓜ EL-TRONICS, INC., 2649 N. Howard St., Philadelphia 33, Pa. ADV. PG. 299.

- Espey Mfg. Co., Inc., 528 E. 72nd St., New York, N. Y.
- Ⓜ Grigsby-Allison Co., Inc., 407 N. Salem Ave., Arlington Heights, Ill.
- Guthman, Inc., Edwin I., 15 S. Throop St., Chicago, Ill.
- Ⓜ Magna Electronics Co., 3707-11 W. Jefferson Blvd., Los Angeles 16, Calif.
- Ⓜ McMurdo Silver Co., Inc., 417 Lafayette St., New York, N. Y.
- Ⓜ Miller Co., J. W., 5917 S. Main St., Los Angeles 3, Calif.
- Ⓜ Monarch Radio & Television Corp., 2430 Atlantic Ave., Brooklyn 33, N. Y.
- Ⓜ Newcomb Audio Products Co., 6824 Lexington Ave., Hollywood 38, Calif.
- Ⓜ Shevers, Inc., Harold, 123 W. 64th St., New York 23, N. Y.
- Sickles Co., F. W., 165 Front St., Chicopee, Mass.
- Ⓜ STANDARD COIL PRODUCTS CO., 2329 N. Pulaski Rd., Chicago 39, Ill. ADV. PG. 97.
- Ⓜ SYLVANIA ELECTRIC PRODUCTS, INC., 1740 Broadway, New York 19, N. Y. ADV. PG. 432-436.

TUNERS—*f-m*

- Ⓜ Altec Lansing Corp., 9356 Santa Monica Blvd., Beverly Hills, Calif.
- Ⓜ Approved Electronic Instrument Corp., 142 Liberty St., New York 6, N. Y.
- Ⓜ Atlas Coil Winders, Inc., Stamford, Conn.
- Ⓜ BARKER & WILLIAMSON, 235 Fairfield Ave., Upper Darby, Pa. ADV. PG. 292.
- Ⓜ BROWNING LABORATORIES, INC., 750 Main St., Winchester, Mass. ADV. PG. 257.
- Ⓜ Collins Audio Products Co., P. O. Box 368, Westfield, N. J.
- Ⓜ DuMont Laboratories, Inc., Allen B., Electronic Parts Div., 35 Market St., East Paterson, N. J.
- Guthman, Inc., Edwin I., 15 S. Throop St., Chicago, Ill.
- Ⓜ HEATH CO., Benton Harbor, Mich. ADV. PG. 264.
- Ⓜ Magna Electronics Co., 3707-11 W. Jefferson Blvd., Los Angeles 16, Calif.
- Ⓜ Mallory & Co., Inc., P. R., 3029 E. Washington St., Indianapolis 6, Ind.
- Ⓜ McMurdo Silver Co., Inc., 417 Lafayette St., New York, N. Y.
- Ⓜ Miller Co., J. W., 5917 S. Main St., Los Angeles 3, Calif.
- Ⓜ Monarch Radio & Television Corp., 2430 Atlantic Ave., Brooklyn 33, N. Y.
- Monroe Coil Co., 2839 N. Narragansett Ave., Chicago 34, Ill.
- Ⓜ Radio Engineering Labs., Inc., 36-40 37th St., Long Island City 1, N. Y.
- Ⓜ Shevers, Inc., Harold, 123 W. 64th St., New York 23, N. Y.
- Sickles Co., F. W., 165 Front St., Chicopee, Mass.
- Ⓜ STANDARD COIL PRODUCTS CO., 2329 N. Pulaski Rd., Chicago 39, Ill. ADV. PG. 97.
- Ⓜ SYLVANIA ELECTRIC PRODUCTS, INC., 1740 Broadway, New York 19, N. Y. ADV. PG. 432-436.

TUNERS—*f-m/a-m*

- Ⓜ Altec Lansing Corp., 9356 Santa Monica Blvd., Beverly Hills, Calif.
- Ⓜ Approved Electronic Instrument Corp., 142 Liberty St., New York 6, N. Y.
- Ⓜ Bogen Co., Inc., David, 663 Broadway, New York 12, N. Y.
- Ⓜ BROWNING LABORATORIES, INC., 750 Main St., Winchester, Mass. ADV. PG. 257.
- Ⓜ Collins Audio Products Co., P. O. Box 368, Westfield, N. J.
- Espey Mfg. Co., Inc., 528 E. 72nd St., New York, N. Y.
- Ⓜ Magna Electronics Co., 3707-11 W. Jefferson Blvd., Los Angeles 16, Calif.
- Ⓜ McMurdo Silver Co., Inc., 417 Lafayette St., New York, N. Y.
- Ⓜ Monarch Radio & Television Corp., 2430 Atlantic Ave., Brooklyn 33, N. Y.
- Ⓜ RADIO CORP. OF AMERICA, RCA Victor Div., General Offices, Camden, N. J. ADV. PG. 177, Inside Back and Back Covers.
- Ⓜ Radio Craftsmen, Inc., 1341 S. Michigan Ave., Chicago 5, Ill.
- Ⓜ Sargent-Raymont Co., The, 212 Ninth St., Oakland 7, Calif.
- Ⓜ Scott Radio Labs., Inc., 4451 N. Ravenswood Ave., Chicago 40, Ill.
- Ⓜ Shevers, Inc., Harold, 123 W. 64th St., New York 23, N. Y.
- Sickles Co., F. W., 165 Front St., Chicopee, Mass.
- Ⓜ STANDARD COIL PRODUCTS CO., 2329 N. Pulaski Rd., Chicago 39, Ill. ADV. PG. 97.
- Ⓜ SYLVANIA ELECTRIC PRODUCTS, INC., 1740 Broadway, New York 19, N. Y. ADV. PG. 432-436.

TUNERS—*Klystron*

- Ⓜ MARCONI INSTRUMENTS, LTD., 23 Beaver St., New York 4, N. Y. ADV. PG. 270.
- Ⓜ POLARAD ELECTRONICS CORP., 100 Metropolitan Ave., Brooklyn 11, N. Y. ADV. PG. 184, 185.
- Ⓜ POLYTECHNIC RESEARCH & DEVELOPMENT CO., INC., 202 Tillary St., Brooklyn 1, N. Y. ADV. PG. 172, 173.

- Ⓜ SPERRY GYROSCOPE CO., Div. of The Sperry Corp., Great Neck, N. Y. ADV. PG. 103, 104.
- Ⓜ Wheeler Laboratories, Inc., Great Neck, N. Y.

TUNERS—*Microwave*

- Bunnell & Co., J. H., 81 Prospect St., Brooklyn, N. Y.
- Ⓜ KINGS MICROWAVE CO., INC., 50 Marbledale Rd., Tuckahoe 7, N. Y. ADV. PG. 178, 179.
- Ⓜ MARCONI INSTRUMENTS, LTD., 23 Beaver St., New York 4, N. Y. ADV. PG. 270.
- Ⓜ POLARAD ELECTRONICS CORP., 100 Metropolitan Ave., Brooklyn 11, N. Y. ADV. PG. 184, 185.
- Ⓜ POLYTECHNIC RESEARCH & DEVELOPMENT CO., INC., 202 Tillary St., Brooklyn 1, N. Y. ADV. PG. 172, 173.
- Ⓜ SPERRY GYROSCOPE CO., Div. of The Sperry Corp., Great Neck, N. Y. ADV. PG. 103, 104.
- Ⓜ Weymouth Instrument Co., 1440 Commercial St., East Weymouth 89, Mass.
- Ⓜ Wheeler Laboratories, Inc., Great Neck, N. Y.

TUNERS—*Permeability*

- Ⓜ Aermotive Equipment Corp., 1632-8 Central St., Kansas City 10, Mo.
- Ⓜ Aero Coil, Inc., 507 26th St., Union City, N. J.
- Ⓜ Atlas Coil Winders, Inc., Stamford, Conn.
- Ⓜ BARKER & WILLIAMSON, 235 Fairfield Ave., Upper Darby, Pa. ADV. PG. 292.
- Ⓜ Collins Audio Products Co., P. O. Box 368, Westfield, N. J.
- Ⓜ CROWLEY & CO., INC., HENRY L., 1 Central Ave., West Orange, N. J. ADV. PG. 231.
- Ⓜ Delco Radio Div., General Motors Corp., Kokomo, Ind.
- Ⓜ General Instrument Corp., 829 Newark Ave., Elizabeth 3, N. J.
- Monroe Coil Co., 2839 N. Narragansett Ave., Chicago 34, Ill.
- Ⓜ Radio Condenser Co., Camden, N. J.
- Ross Mfg. Co., 860 Washington St., Burlington, Iowa.
- Sickles Co., F. W., 165 Front St., Chicopee, Mass.
- Ⓜ STANDARD COIL PRODUCTS CO., 2329 N. Pulaski Rd., Chicago 39, Ill. ADV. PG. 97.

TUNERS—*Television*

- Ⓜ Aladdin Radio Industries Inc., 501 W. 35th St., Chicago 16, Ill.
- Ⓜ BARKER & WILLIAMSON, 235 Fairfield Ave., Upper Darby, Pa. ADV. PG. 292.
- Ⓜ DX Radio Products Co., Inc., 2304 Armitage Ave., Chicago 47, Ill.
- Ⓜ DuMont Laboratories, Inc., Allen B., Electronic Parts Div., 35 Market St., East Paterson, N. J.
- Ⓜ Emerson Radio & Phonograph Corp., 111 8th Ave., New York 11, N. Y.
- Ⓜ FRANKLIN AIRLOOP CORP., 43-20 34th St., Long Island City, N. Y. ADV. PG. 45.
- Ⓜ FRANKLIN MFG. CORP., A. W., 43-20 34th St., Long Island City 1, N. Y. ADV. PG. 44.
- Ⓜ General Instrument Corp. 829 Newark Ave., Elizabeth 3, N. J.
- Guthman Inc., Edwin I., 15 S. Throop St., Chicago, Ill.
- Ⓜ Mallory & Co., Inc., P. R., 3029 E. Washington St., Indianapolis 6, Ind.
- Ⓜ Monarch Radio & Television Corp., 2430 Atlantic Ave., Brooklyn 33, N. Y.
- Monroe Coil Co., 2839 N. Narragansett Ave., Chicago 34, Ill.
- Oak Mfg. Co., 1260 N. Clybourn Ave., Chicago 10, Ill.
- Ⓜ Philco Corp., Tioga & C Sts., Philadelphia 34, Pa.
- Ross Mfg. Co., 860 Washington St., Burlington, Iowa.
- Ⓜ S. M. A. Co., 4721 N. Kedzie, Chicago, Ill.
- Ⓜ Sarks Tarzian Tube Div., 214 Central Ave., Hawthorne, N. J.
- Ⓜ Scott Radio Labs., Inc., 4451 N. Ravenswood Ave., Chicago 40, Ill.
- Sickles Co., F. W., 165 Front St., Chicopee, Mass.
- Ⓜ STANDARD COIL PRODUCTS CO., 2329 N. Pulaski Rd., Chicago 39, Ill. ADV. PG. 97.
- Ⓜ SYLVANIA ELECTRIC PRODUCTS, INC., 1740 Broadway, New York 19, N. Y. ADV. PG. 432-436.
- Variable Condenser Corp., 65 Hope St., Brooklyn, N. Y.

TUNERS—*Television rf*

- Ⓜ BARKER & WILLIAMSON, 235 Fairfield Ave., Upper Darby, Pa. ADV. PG. 292.
- Ⓜ DuMont Laboratories, Inc., Allen B., Electronic Parts Div., 35 Market St., East Paterson, N. J.
- Ⓜ FRANKLIN AIRLOOP CORP., 43-20 34th St., Long Island City, N. Y. ADV. PG. 45.
- Ⓜ FRANKLIN MFG. CORP., A. W., 43-20 34th St., Long Island City 1, N. Y. ADV. PG. 44.
- Ⓜ General Instrument Corp., 829 Newark Ave., Elizabeth 3, N. J.
- Guthman Inc., Edwin I., 15 S. Throop St., Chicago, Ill.
- Ⓜ Mallory & Co., Inc., P. R., 3029 E. Washington St., Indianapolis 6, Ind.
- Ⓜ Monarch Radio & Television Corp., 2430 Atlantic Ave., Brooklyn 33, N. Y.
- Ⓜ Radio Condenser Co., Camden, N. J.
- Ⓜ Sarks Tarzian Tube Div., 214 Central Ave., Hawthorne, N. J.

V indicates . . . IN PRODUCTION • AVAILABILITY • UNRESTRICTED FOR GENERAL USE

- OS. M. A. Corp., 4721 N. Kedzie, Chicago, Ill.
- Sickles Co., F. W., 165 Front St., Chicopee, Mass.
- STANDARD COIL PRODUCTS CO., 2329 N. Pulaski Rd., Chicago 39, Ill. ADV. PG. 97.
- SYLVANIA ELECTRIC PRODUCTS, INC., 1740 Broadway, New York 19, N. Y. ADV. PG. 432-436.

TUNERS—uhf Ring

- Approved Electronic Instrument Corp., 142 Liberty St., New York 6, N. Y.
- Guthman, Inc., Edwin I., 15 S. Throop St., Chicago, Ill.

TUNING DEVICES—Receiver Mechanical

- AIR ASSOCIATES, INC., Teterboro, N. J. ADV. PG. 211.
- Bassett, Inc., Rex, 307-311 N.W. First Ave., Fort Lauderdale, Fla.
- Bunnell & Co., J. H., 81 Prospect St., Brooklyn, N. Y.
- Delco Radio Div., General Motors Corp., Kokomo, Ind. Elm Laboratories, 18 South Broadway, Dobbs Ferry, N. Y.
- General Instrument Corp., 829 Newark Ave., Elizabeth 3, N. J.
- Grigsby-Allison Co., Inc., 407 N. Salem Ave., Arlington Heights, Ill.
- Oak Mfg. Co., 1260 N. Clybourn Ave., Chicago 10, Ill.
- REF Manufacturing Corp., Jericho Turnpike, Mineola, N. Y.
- Radio Condenser Co., Camden, N. J.

TUNING DEVICES—Transmitter Mechanical

- AIR ASSOCIATES, INC., Teterboro, N. J. ADV. PG. 211.
- Bassett, Inc., Rex, 307-311 N.W. First Ave., Fort Lauderdale, Fla.
- Bunnell & Co., J. H., 81 Prospect St., Brooklyn, N. Y.
- General Instrument Corp., 829 Newark Ave., Elizabeth 3, N. J.
- Press Wireless Mfg. Co., Inc., Cantiaque Rd., Hicksville, N. Y.
- REF Manufacturing Corp., Jericho Turnpike, Mineola, N. Y.

TURNTABLES—Recording and Transcription

- Bogen Co., Inc., David, 663 Broadway, New York 12, N. Y.
- Califone Corp., 1041 N. Sycamore Ave., Hollywood 38, Calif.
- Caltron Co., 1406 S. Hobart Blvd., Los Angeles 6, Calif.
- Fairchild Recording Equipment Co., 154th St. & 7th Ave., Whitestone, N. Y.
- FLOCK PROCESS CO., INC., 28 Fahey St., Springdale, Conn. ADV. PG. 196.
- Gates Radio Co., Quincy, Ill.
- PRESTO RECORDING CORP., Paramus, N. J. ADV. PG. 52, 53.
- Proctor Soundex Corp., 133 N. 6th Ave., Mt. Vernon, N. Y.
- Q R K Electronic Products, 445 N. Circle Drive, Fresno 4, Calif.
- RADIO CORP. OF AMERICA, RCA Victor Div., General Offices, Camden, N. J. ADV. PG. 177, Inside Back and Back Covers.
- Rek-O-Kut Co., Inc., 38-01 Queens Blvd., Long Island City, N. Y.

TWEETERS

See Loudspeakers

ULTRASONIC EQUIPMENT

Refer to any of the following:
Gages, Ultrasonic Thickness Generators, Ultrasonic Transducers, Ultrasonic

VACUUM GAGES

See Gages, Vacuum or Pirani

VACUUM INDICATING, RECORDING AND CONTROL EQUIPMENT

- BOWSER TECHNICAL REFRIGERATION DIV., BOWSER, INC., Terryville, Conn. ADV. PG. 132, 133.
- Bristol Co., The, Waterbury 20, Conn.
- CONTINENTAL ELECTRIC CO., Geneva, Ill. ADV. PG. 182.
- Distillation Products Industries, Div. of Eastman Kodak Co., 755 Ridge Rd. W., Rochester 3, N. Y.
- Esterline-Angus Co., Inc., P. O. Box 596, Indianapolis, Ind.
- Flader, Inc., Fredric, 1330 Laskey Rd., Toledo 12, Ohio.
- Fredericks Co., Geo. E., Bethayres, Pa.
- GENERAL ELECTRIC CO., Schenectady 5, N. Y. ADV. PG. 1 to 22.

- Hastings Instrument Co., Hampton 9, Va.
- Manning, Maxwell & Moore, Inc., Stratford, Conn.
- MINNEAPOLIS-HONEYWELL REGULATOR CO., INDUSTRIAL DIV., Wayne & Roberts Aves., Philadelphia 44, Pa. ADV. PG. 208, 209.
- National Research Corp., 70 Memorial Drive, Cambridge 42, Mass.
- Process & Instruments, 60 Greenpoint Ave., Brooklyn 22, N. Y.
- Research Electronics Lab., 2459 Susquehanna Rd., Roslyn, Pa.
- Skaneateles Mfg. Co., Inc., 122 Dickerson St., Syracuse 2, N. Y.
- Stokes Machine Co., F. J., 5850 Tabor Rd., Olney P. O., Philadelphia 20, Pa.
- Tagliabue Div., Weston Electrical Instrument Corp., 614 Frelinghuysen Ave., Newark 5, N. J.
- Wallace & Tiernan Products, Inc., Belleville 9, N. J.
- Winslow Co., Inc., 9 Liberty St., Newark 5, N. J.

VACUUM PUMPS

- Beach-Russ Co., 50 Church St., New York 7, N. Y.
- Central Scientific Co., 1700 Irving Park Road, Chicago 13, Ill.
- Distillation Products Industries, Div. of Eastman Kodak Co., 755 Ridge Rd. W., Rochester 3, N. Y.
- EISLER ENGINEERING CO., INC., 740 S. 13th St., Newark 3, N. J. ADV. PG. 378.
- Eitel-McCullough Inc., San Bruno, Calif.
- Fredericks Co., Geo. E., Bethayres, Pa.
- International Machine Works, 6904 Madison St., Guttenberg, N. J.
- KAHLE ENGINEERING CO., 1307 Seventh St., North Bergen, N. J. ADV. PG. 369.
- KINNEY MFG. CO., 3529 Washington St., Boston, Mass. ADV. PG. 160.
- Lear, Inc., 110 Ionia Ave., N.W., Grand Rapids 2, Mich.
- Litton Industries, San Carlos, Calif.
- National Research Corp., 70 Memorial Drive, Cambridge 42, Mass.
- Nelson Vacuum Pump Co., Geo. F., 2133 Fourth St., Berkeley 10, Calif.
- Optical Film Engineering Co., 2125 Cherry St., Philadelphia 3, Pa.
- Process & Instruments, 60 Greenpoint Ave., Brooklyn 22, N. Y.
- Stokes Machine Co., F. J., 5850 Tabor Rd., Olney P. O., Philadelphia 20, Pa.
- Welch Scientific Co., W. M., 1515 Sedgwick St., Chicago 10, Ill.

Vacuum Tube Voltmeter

See Voltmeters, Electronic

VACUUM UNITS

- BOWSER, TECHNICAL REFRIGERATION DIV., BOWSER, INC., Terryville, Conn. ADV. PG. 132, 133.
- Central Scientific Co., 1700 Irving Park Rd., Chicago 13, Ill.
- Distillation Product Industries, Div. of Eastman Kodak Co., 755 Ridge Rd. W., Rochester 3, N. Y.
- JENNINGS RADIO MFG. CO., 1098 E. William St., San Jose 12, Calif. ADV. PG. 194, 195.
- Leiman Brothers, 124 Christie St., Newark 5, N. J.
- National Research Corp., 70 Memorial Drive, Cambridge 42, Mass.
- Optical Film Engineering Co., 2125 Cherry St., Philadelphia 3, Pa.
- Process & Instruments, 60 Greenpoint Ave., Brooklyn 22, N. Y.
- Skaneateles Mfg. Co., Inc., 122 Dickerson St., Syracuse 2, N. Y.
- Stokes Machine Co., F. J., 5850 Tabor Rd., Olney P. O., Philadelphia 20, Pa.
- Vacuum-Electronic Engineering Co., 756 Third Ave., Brooklyn 32, N. Y.
- Welch Scientific Co., W. M., 1515 Sedgwick St., Chicago 10, Ill.

VALVES—Solenoid

- Adel Div. of General Metals Corp., 10777 Van Owen St., Burbank, Calif.
- AIR ASSOCIATES, INC., Teterboro, N. J. ADV. PG. 211.
- Automatic Switch Co., 391 Lakeside Ave., Orange, N. J.
- Bendix Aviation Corp., Pacific Div., 11600 Sherman Way, North Hollywood, Calif.
- Caltron Co., 1406 S. Hobart Blvd., Los Angeles 6, Calif.
- Cutler-Hammer Inc., 411 N. 12th St., Milwaukee 1, Wis.
- Distillation Product Industries, Div. of Eastman Kodak Co., 755 Ridge Rd. W., Rochester 3, N. Y.
- General Controls Co., Glendale 1, Calif.
- GENERAL ELECTRIC CO., Schenectady 5, N. Y. ADV. PG. 1 to 22.
- Hydraulic Press Mfg. Co., Mt. Gilead, Ohio.
- Skinner Electric Valve Div., The Skinner Chuck Co., 40 Belden Ave., Norwalk, Conn.
- STANDARD COIL PRODUCTS CO., 2329 N. Pulaski Rd., Chicago 39, Ill. ADV. PG. 97.

VARISTORS

- GENERAL ELECTRIC CO., Schenectady 5, N. Y. ADV. PG. 1 to 22.

VARNISH CAMBRIC COATINGS

VARNISH, INSULATING
See Insulating Compounds

VIBRATION ANALYSIS EQUIPMENT

- Aircraft Electronics Associates, Inc., 94 Silas Deane Highway, Rocky Hill, Conn.
- Avion Instrument Corp., Paramus, N. J.
- CALIDYNE CO., THE, 751 Main St., Winchester, Mass. ADV. PG. 239.
- Century Geophysical Corp., 1333 N. Utica, Tulsa 3, Okla.
- Consolidated Engineering Corp., 300 N. Sierra Madre Villa, Pasadena 8, Calif.
- Davies Laboratories, Inc., The, 4705 Queensbury Rd., Riverdale, Md.
- ELECTRO PRODUCTS LABS, INC., 4501 N. Ravenswood Ave., Chicago 40, Ill. ADV. PG. 199.
- ELECTRONIC TUBE CORP., 1200 E. Mermaid Ave., Philadelphia 18, Pa. ADV. PG. 335.
- Flader, Inc., Fredric, 1330 Laskey Rd., Toledo 12, Ohio.
- GENERAL ELECTRIC CO., Schenectady 5, N. Y. ADV. PG. 1 to 22.
- GENERAL RADIO CO., 275 Massachusetts Ave., Cambridge 39, Mass. ADV. PG. 48, 49.
- Hathaway Instrument Co., 1315 S. Clarkson St., Denver 10, Colo.
- HEILAND RESEARCH CORP., 130 East 5th Avenue, Denver 9, Colo. ADV. PG. 401.
- INDUSTRIAL ELECTRONICS, INC., 8080 Wheeler St., Detroit 10, Mich. ADV. PG. 234, 235.
- KAY ELECTRIC CO., 14 Maple Ave., Pine Brook, N. J. ADV. PG. 340.
- KROHN-HITE INSTRUMENT CO., 580 Massachusetts Ave., Cambridge 39, Mass. ADV. PG. 43.
- M B MFG. CO., 1060 State St., New Haven 11, Conn. ADV. PG. 365.
- Massa Laboratories, 3868 Carnegie St., Cleveland, Ohio.
- Midwestern Geophysical Laboratory, 3400 S. Harvard, Tulsa, Okla.
- Miller Corp., William, 325 N. Halstead St., Pasadena 18, Calif.
- PANORAMIC RADIO PRODUCTS, INC., 10 South Second Ave., Mt. Vernon, N. Y. ADV. PG. 383.
- Scott Inc., Herman Hosmer, 385 Putnam Ave., Cambridge 39, Mass.
- SHERRON ELECTRONICS CO., 1201 Flushing Ave., Brooklyn 6, N. Y. ADV. PG. 145.
- SPERRY GYROSCOPE CO., Div. of The Sperry Corp., Great Neck, N. Y. ADV. PG. 103, 104.
- Statham Laboratories, Inc., 12401 W. Olympic Blvd., Los Angeles 64, Calif.
- Telecomputing Corp., 133 E. Santa Anita Ave., Burbank, Calif.
- WESTINGHOUSE ELECTRIC CORP., 511 Wood St., P. O. Box 868, Pittsburgh 30, Pa. ADV. PG. 107-113.

VIBRATION ANALYSIS EQUIPMENT—Electronic Balancing

- Annis Co., R. B., 1101 N. Delaware St., Indianapolis, Ind.
- Century Geophysical Corp., 1333 N. Utica, Tulsa 3, Okla.
- GENERAL ELECTRIC CO., Schenectady 5, N. Y. ADV. PG. 1 to 22.
- KAY ELECTRIC CO., 14 Maple Ave., Pine Brook, N. J. ADV. PG. 340.
- M B MFG. CO., 1060 State St., New Haven 11, Conn. ADV. PG. 365.
- Midwestern Geophysical Laboratory, 3400 S. Harvard, Tulsa, Okla.
- SPERRY GYROSCOPE CO., Div. of The Sperry Corp., Great Neck, N. Y. ADV. PG. 103, 104.
- WESTINGHOUSE ELECTRIC CORP., 511 Wood St., P. O. Box 868, Pittsburgh 30, Pa. ADV. PG. 107-113.

VIBRATION ANALYSIS EQUIPMENT—High Temperature Fatigue

- Gates Radio Co., Quincy, Ill.
- GENERAL ELECTRIC CO., Schenectady 5, N. Y. ADV. PG. 1 to 22.
- Midwestern Geophysical Laboratory, 3400 S. Harvard, Tulsa, Okla.

VIBRATION ANALYSIS EQUIPMENT—Vibration Fatigue

- Baldwin-Lima-Hamilton Corp., Paschall P. O. Station, Philadelphia 42, Pa.
- CALIDYNE CO., THE, 751 Main St., Winchester, Mass. ADV. PG. 239.
- Century Geophysical Corp., 1333 N. Utica, Tulsa 3, Okla.

V indicates . . . IN PRODUCTION • AVAILABILITY • UNRESTRICTED FOR GENERAL USE

- ⊙GENERAL ELECTRIC CO., Schenectady 5, N. Y. ADV. PG. 1 to 22.
- ⊙KAY ELECTRIC CO., 14 Maple Ave., Pine Brook, N. J. ADV. PG. 340.
- ⊙L. A. B. Corp., 31 Union Place, Summit, N. J.
- ⊙M B MFG. CO., 1060 State St., New Haven 11, Conn. ADV. PG. 365.
- ⊙Midwestern Geophysical Laboratory, 3400 S. Harvard, Tulsa, Okla.
- ⊙WESTINGHOUSE ELECTRIC CORP., 511 Wood St., P. O. Box 868, Pittsburgh 30, Pa. ADV. PG. 107-113.

VIBRATION EXCITING EQUIPMENT

- ⊙KROHN-HITE INSTRUMENT CO., 580 Massachusetts Ave., Cambridge 39, Mass. ADV. PG. 43.
- ⊙L. A. B. Corp., 31 Union Place, Summit, N. J.
- ⊙M B MFG. CO., 1060 State St., New Haven 11, Conn. ADV. PG. 365.
- ⊙Massa Laboratories, 3868 Carnegie St., Cleveland, Ohio.
- ⊙Rollin Co., 2070 N. Fair Oaks Ave., Pasadena 3, Calif.
- ⊙United Control Corp., 3214 E. 47th St., Seattle 5, Wash.

VIBRATORS

- ⊙AIRPAX PRODUCTS CO., Middle River, Baltimore 20, Md. ADV. PG. 289.
- ⊙AMERICAN TELEVISION & RADIO CO., 300 E. Fourth St., St. Paul 1, Minn. ADV. PG. 266.
- ⊙CORNELL-DUBILIER ELECTRIC CORP., South Plainfield, N. J. ADV. PG. 146.
- ⊙Eltron, Inc., 407 N. Jackson St., Jackson, Mich. Ionic Electronic Equipment Co., 1705 N. Kenmore, Los Angeles 27, Calif.
- ⊙James Vibrapow Co., 4036 N. Rockwell St., Chicago 18, Ill.
- ⊙KURMAN ELECTRIC CO., INC., 35-18 37th St., Long Island City, N. Y. ADV. PG. 196.
- ⊙M B MFG. CO., 1060 State St., New Haven 11, Conn. ADV. PG. 365.
- ⊙Mallory & Co., Inc., P. R., 3029 E. Washington St., Indianapolis 6, Ind.
- ⊙Miskella Infra-Red Co., The, E. 73rd & Grand Ave., Cleveland 4, Ohio.
- ⊙Philco Corp., Tioga & C Sts., Philadelphia 34, Pa.
- ⊙Radiart Corp., The, 3571 W. 62nd St., Cleveland 2, Ohio.
- ⊙Stow Mfg. Co., 445 State St., Binghamton, N. Y.
- ⊙United Control Corp., 3214 E. 47th St., Seattle 5, Wash.
- ⊙Vokar Corp., 7300 Huron River Drive, Dexter, Mich.

VISCOSIMETERS WITH ELECTRONIC RECORDERS

- ⊙Fischer & Porter Co., Hatboro, Pa.
- ⊙Process & Instruments, 60 Greenpoint Ave., Brooklyn 22, N. Y.
- ⊙Rich-Roth Labs., East Hartford, Conn.

VOLTAGE SUPPLIES—Decade

- ⊙Clippard Instrument Laboratory, Inc., 1125 Bank St., Cincinnati 14, Ohio.
- ⊙INDUSTRIAL ELECTRONICS, INC., 8080 Wheeler St., Detroit 10, Mich. ADV. PG. 234, 235.
- ⊙KEPCO LABS., INC., 149-14 41st Ave., Flushing, N. Y. ADV. PG. 54.

VOLTMETERS

- ⊙AIRMEC LABORATORIES, LTD., 366 Madison Ave., New York 17, N. Y. ADV. PG. 336.
- ⊙Assembly Products, Inc., Chagrin Falls 6, Ohio.
- ⊙Associated Research, Inc., 3758 W. Belmont, Chicago 18, Ill.
- ⊙Beede Electrical Instrument Co., Inc., Penacook, N. H.
- ⊙Bristol Co., The, Waterbury 20, Conn.
- ⊙Burlington Instrument Co., Burlington, Iowa.
- ⊙Cole Instrument Co., 1320 S. Grand Ave., Los Angeles 15, Calif.
- ⊙DEJUR-AMSCO CORP., Northern Blvd. at 45th St., Long Island City 1, N. Y. ADV. PG. 377.
- ⊙Electric Design & Mfg. Corp., Burlington, Iowa.
- ⊙Electro-Mechanical Instrument Co., 812 Chestnut St., Perkasie, Pa.
- ⊙ELECTRONIC INSTRUMENT CO., INC., 276 Newport St., Brooklyn 12, N. Y. ADV. PG. 129.
- ⊙Esterline-Angus Co., Inc., P. O. Box 596, Indianapolis, Ind.
- ⊙GENERAL ELECTRIC CO., Schenectady 5, N. Y. ADV. PG. 1 to 22.
- ⊙GENERAL RADIO CO., 275 Massachusetts Ave., Cambridge 39, Mass. ADV. PG. 48, 49.
- ⊙Industrial Devices, Inc., 22 State Rd., Edgewater, N. J.
- ⊙Jackson Electrical Instrument Co., 16 S. Patterson Blvd., Dayton 1, Ohio.
- ⊙McMurdo Silver Co., Inc., 417 Lafayette St., New York, N. Y.

- ⊙MARION ELECTRICAL INSTRUMENT CO., Manchester, N. H. ADV. PG. 200.
- ⊙Meters, Inc., 915 Westfield Blvd., Indianapolis 20, Ind.
- ⊙Metropolitan Electronics & Instruments Co., 106 Fifth Ave., New York 11, N. Y.
- ⊙Oak Ridge Products Mfg. Div. of Video Television, Inc., 37-01 Vernon Blvd., Long Island City 1, N. Y.
- ⊙Philco Corp., Tioga & C Sts., Philadelphia 34, Pa.
- ⊙PRECISE MEASUREMENTS CO., 942 Kings Highway, Brooklyn 23, N. Y. ADV. PG. 401.
- ⊙Pyramid Instrument Corp., 49 Howard St., New York, N. Y.
- ⊙Rawson Electrical Instrument Co., 111 Potter St., Cambridge 42, Mass.
- ⊙Reliance Instrument Co., 3027 W. Van Buren St., Chicago 12, Ill.
- ⊙Roller-Smith, Bethlehem, Pa.
- ⊙Sensitive Research Instrument Corporation, 9 Elm Avenue, Mount Vernon, N. Y.
- ⊙SHURITE METERS, 35-B Hamilton St., New Haven 6, Conn. ADV. PG. 390.
- ⊙Simpson Electric Co., Div. of American Gage & Machine Co., 5218 W. Kinzie St., Chicago 44, Ill.
- ⊙Sterling Mfg. Co., 9205 Detroit Ave., Cleveland, Ohio.
- ⊙Superior Instruments Co., 227 Fulton St., New York, N. Y.
- ⊙SYLVANIA ELECTRIC PRODUCTS, INC., 1740 Broadway, New York 19, N. Y. ADV. PG. 432-436.
- ⊙TELEX, INC., Telex Park, St. Paul 1, Minn. ADV. PG. 237.
- ⊙TRAD TELEVISION CORP., 1001 First Ave., Asbury Park, N. J. ADV. PG. 355.
- ⊙Triplet Electrical Instrument Co., Harmon Rd., Bluffton, Ohio.
- ⊙Triumph Mfg. Co., 913 W. Van Buren St., Chicago 7, Ill.
- ⊙U. S. Gauge Div., American Machine & Metals, Inc., Sellersville, Pa.
- ⊙Welch Scientific Co., W. M., 1515 Sedgwick St., Chicago 10, Ill.
- ⊙WESTINGHOUSE ELECTRIC CORP., 511 Wood St., P. O. Box 868, Pittsburgh 30, Pa. ADV. PG. 107-113.
- ⊙WESTON ELECTRICAL INSTRUMENT CORP., 595 Frelinghuysen Ave., Newark 5, N. J. ADV. PG. 243.

VOLTMETERS—Crystal

- ⊙Feiler Engineering Co., 8026 Monticello Ave., Skokie, Ill.
- ⊙GENERAL RADIO CO., 275 Massachusetts Ave., Cambridge 39, Mass. ADV. PG. 48, 49.
- ⊙McMurdo Silver Co., Inc., 417 Lafayette St., New York, N. Y.

VOLTMETERS—Electronic

- ⊙ADVANCE ELECTRONICS CO., 451 Highland Ave., Passaic, N. J. ADV. PG. 224.
- ⊙AIRMEC LABORATORIES, LTD., 366 Madison Ave., New York 17, N. Y. ADV. PG. 336.
- ⊙Audio Instrument Co., 133 W. 14th St., New York 11, N. Y.
- ⊙BALLANTINE LABORATORIES, INC., Boonton, N. J. ADV. PG. 125.
- ⊙Barber Labs., Alfred W., 32-44 Francis Lewis Blvd., Flushing, N. Y.
- ⊙BETA ELECTRIC CORP., 1762 Third Ave., New York 29, N. Y. ADV. PG. 399.
- ⊙BRUSH DEVELOPMENT CO., 3405 Perkins Ave., Cleveland 14, Ohio. ADV. PG. 228, 229.
- ⊙C. G. S. LABORATORIES, INC., 391 Ludlow St., Stamford, Conn. ADV. PG. 389.
- ⊙Chicago Industrial Instrument Co., 536 W. Elm St., Chicago 10, Ill.
- ⊙Clippard Instrument Laboratory, Inc., 1125 Bank St., Cincinnati 14, Ohio.
- ⊙Cole Instrument Co., 1320 S. Grand Ave., Los Angeles 15, Calif.
- ⊙DAVEN CO., 191 Central Ave., Newark 4, N. J. ADV. PG. 157.
- ⊙Douglas Radio Labs., 176 Norfolk Ave., Boston 19, Mass.
- ⊙ELECTRONIC DESIGNS, INC., 28-30 School St., Yonkers, N. Y. ADV. PG. 332.
- ⊙Electronic Indicator Corp., 259 Green St., Brooklyn 22, N. Y.
- ⊙ELECTRONIC INSTRUMENT CO., INC., 276 Newport St., Brooklyn 12, N. Y. ADV. PG. 129.
- ⊙ELECTRONIC MEASUREMENTS COMPANY, Red Bank, N. J. ADV. PG. 312.
- ⊙Electronic Measurements Corp., 280 Lafayette St., New York 12, N. Y.
- ⊙Feiler Engineering Co., 8026 Monticello Ave., Skokie, Ill.
- ⊙FREED TRANSFORMER CO., INC., 1736 Weirfield St., Brooklyn 27, N. Y. ADV. PG. 149.
- ⊙GENERAL ELECTRIC CO., Schenectady 5, N. Y. ADV. PG. 1 to 22.
- ⊙GENERAL RADIO CO., 275 Massachusetts Ave., Cambridge 39, Mass. ADV. PG. 48, 49.
- ⊙HEATH CO., Benton Harbor, Mich. ADV. PG. 264.
- ⊙HEWLETT-PACKARD CO., 395 Page Mill Rd., Palo Alto, Calif. ADV. PG. 33-36.
- ⊙Jackson Electrical Instrument Co., 16 S. Patterson Blvd., Dayton 1, Ohio.

- ⊙KAY ELECTRIC CO., 14 Maple Ave., Pine Brook, N. J. ADV. PG. 340.
- ⊙KEITHLEY INSTRUMENTS, 1507 Warrensville Center Rd., Cleveland 21, Ohio. ADV. PG. 337.
- ⊙McMurdo Silver Co., Inc., 417 Lafayette St., New York, N. Y.
- ⊙MEASUREMENTS CORP., Boonton, N. J. ADV. PG. 99.
- ⊙Metropolitan Electronics & Instruments Co., 106 Fifth Ave., New York 11, N. Y.
- ⊙MILLIVAC INSTRUMENT CORP., Box 3027, New Haven, Conn. ADV. PG. 402.
- ⊙Philco Corp., Tioga & C Sts., Philadelphia 34, Pa.
- ⊙Precision Apparatus Co., Inc., 92-27 Horace Harding Blvd., Elmhurst, N. Y.
- ⊙Radio City Products Co., Inc., 152 W. 125th St., New York 1, N. Y.
- ⊙Roller-Smith, Bethlehem, Pa.
- ⊙SANBORN CO., 39 Osborn St., Cambridge 39, Mass. ADV. PG. 391.
- ⊙Sierra Electronic Corp., San Carlos, Calif.
- ⊙Simpson Electric Co., Div. of American Gage & Machine Co., 5218 W. Kinzie St., Chicago 44, Ill.
- ⊙Southwestern Industrial Electronics Co., 2831 Post Oak Rd., P. O. Box 13058, Houston 19, Texas.
- ⊙SYLVANIA ELECTRIC PRODUCTS, INC., 1740 Broadway, New York 19, N. Y. ADV. PG. 432-436.
- ⊙TRAD TELEVISION CORP., 1001 First Ave., Asbury Park, N. J. ADV. PG. 355.
- ⊙Transvision, Inc., 460 North Ave., New Rochelle, N. Y.
- ⊙Varo Mfg. Co., Inc., Box 638, Garland, Texas.
- ⊙Western-Electro-Acoustics Labs., 204 S. Beverly Drive, Beverly Hills, Calif.
- ⊙WESTON ELECTRICAL INSTRUMENT CORP., 595 Frelinghuysen Ave., Newark 5, N. J. ADV. PG. 243.

VOLTMETERS—Electrostatic

- ⊙FERRANTI ELECTRIC, INC., 30 Rockefeller Plaza, New York 20, N. Y. ADV. PG. 159.
- ⊙Fluke Engineering Co., John, Box 755, Springdale, Conn.
- ⊙GENERAL ELECTRIC CO., Schenectady 5, N. Y. ADV. PG. 1 to 22.
- ⊙Rawson Electrical Instrument Co., 111 Potter St., Cambridge 42, Mass.
- ⊙Sensitive Research Instrument Corporation, 9 Elm Ave., Mt. Vernon, N. Y.
- ⊙Specialties, Inc., Skunks Misery Rd., Syosset, N. Y.
- ⊙Welch Scientific Co., W. M., 1515 Sedgwick St., Chicago 10, Ill.

VOLTAGE REGULATORS & STABILIZERS

See Regulators, Voltage Regulators & Stabilizers

VOLT-OHM-MILLIAMMETERS

- ⊙Associated Research, Inc., 3758 W. Belmont, Chicago 18, Ill.
- ⊙Beede Electrical Instrument Co., Inc., Penacook, N. H.
- ⊙Douglas Radio Labs., 176 Norfolk Ave., Boston 19, Mass.
- ⊙ELECTRONIC DESIGNS INC., 28-30 School St., Yonkers, N. Y. ADV. PG. 332.
- ⊙ELECTRONIC INSTRUMENT CO., INC., 276 Newport St., Brooklyn 12, N. Y. ADV. PG. 129.
- ⊙Electronic Measurements Corp., 280 Lafayette St., New York 12, N. Y.
- ⊙HEATH CO., Benton Harbor, Mich. ADV. PG. 264.
- ⊙Instrument Laboratories, 315 W. Walton Place, Chicago 10, Ill.
- ⊙Jackson Electrical Instrument Co., 16 S. Patterson Blvd., Dayton 1, Ohio.
- ⊙McMurdo Silver Co., Inc., 417 Lafayette St., New York, N. Y.
- ⊙Meters, Inc., 915 Westfield Blvd., Indianapolis 20, Ind.
- ⊙Metropolitan Electronics & Instruments Co., 106 Fifth Ave., New York 11, N. Y.
- ⊙Oak Ridge Products Mfg. Div. of Video Television, Inc., 37-01 Vernon Blvd., Long Island City 1, N. Y.
- ⊙Philco Corp., Tioga & C Sts., Philadelphia 34, Pa.
- ⊙PRECISE MEASUREMENTS CO., 942 Kings Highway, Brooklyn 23, N. Y. ADV. PG. 401.
- ⊙Precision Apparatus Co., Inc., 92-27 Horace Harding Blvd., Elmhurst, N. Y.
- ⊙Radio City Products Co., Inc., 152 W. 25th St., New York 1, N. Y.
- ⊙Roller-Smith, Bethlehem, Pa.
- ⊙Simpson Electric Co., Div. of American Gage & Machine Co., 5218 W. Kinzie St., Chicago 44, Ill.
- ⊙Star Measurements Co., 442 East 166th St., New York 56, N. Y.
- ⊙Superior Instruments Co., 227 Fulton St., New York, N. Y.
- ⊙Supreme, Inc., Greenwood, Miss.
- ⊙SYLVANIA ELECTRIC PRODUCTS, INC., 1740 Broadway, New York 19, N. Y. ADV. PG. 432-436.
- ⊙TRAD TELEVISION CORP., 1001 First Ave., Asbury Park, N. J. ADV. PG. 355.
- ⊙Triplet Electrical Instrument Co., Harmon Rd., Bluffton, Ohio.
- ⊙Triumph Mfg. Co., 913 W. Van Buren St., Chicago 7, Ill.

Ⓢ indicates . . . IN PRODUCTION • AVAILABILITY • UNRESTRICTED FOR GENERAL USE

- Ⓢ WESTINGHOUSE ELECTRIC CORP., 511 Wood St., P. O. Box 868, Pittsburgh 30, Pa. ADV. PG. 107-113.
 Ⓢ WESTON ELECTRICAL INSTRUMENT CORP., 595 Frelinghuysen Ave., Newark 5, N. J. ADV. PG. 243.

WASHERS—Insulating

- Ⓢ AMERICAN LAVA CORP., Chattanooga 5, Tenn. ADV. PG. 143.
 Ⓢ Auburn Mfg. Co., Pease Ave. & Stack St., Middletown, Conn.
 Ⓢ Baer Co., N. S., 9 Montgomery St., Hillside, N. J.
 Ⓢ BIWAX CORP., 3445 Howard St., Skokie, Ill. ADV. PG. 380.
 Brandywine Fibre Co., 15th & Poplar Sts., Wilmington, Del.
 Ⓢ CITATION PRODUCTS CO., 233 E. 146th St., New York 51, N. Y. ADV. PG. 388.
 Ⓢ Cortland Industries, Inc., 4545 Cortland St., Chicago 39, Ill.
 Ⓢ ELECTRONIC MECHANICS, INC., 70 Clifton Blvd., Clifton, N. J. ADV. PG. 309.
 Ⓢ FEDERAL SCREW PRODUCTS INC., 224 W. Huron St., Chicago 10, Ill. ADV. PG. 76.
 Felsenthal & Sons, Inc., G., 4100 W. Grand Ave., Chicago 51, Ill.
 Ⓢ Felt Products Mfg. Co., 1504 West Carroll Ave., Chicago 7, Ill.
 Ⓢ Franklin Fibre-Lamitex Corp., 12th & French Sts., Wilmington, Del.
 Ⓢ Gasket Engineering Co., 2440 Charlotte St., Kansas City 8, Mo.
 Ⓢ General Cement Mfg. Co., 919 Taylor Ave., Rockford, Ill.
 Ⓢ Industrial Precision Products Co., 315-325 N. Hoynes Ave., Chicago 12, Ill.
 Insulating Fabricators, Inc., 150 Union Ave., East Rutherford, N. J.
 Ⓢ Insulating Manufacturers Corp., 565 W. Washington Blvd., Chicago 6, Ill.
 Ⓢ Insuline Corp. of America, 36-02 35th Ave., Long Island City, N. Y.
 Ⓢ IRVINGTON VARNISH & INSULATOR CO., 6 Argyle Terrace, Irvington 11, N. J. ADV. PG. 92, 93.
 Ⓢ Isolantite Mfg. Corp., Stirling, N. J.
 Ⓢ Keystone Electronics Co., 423 Broome St., New York 12, N. Y.
 Ⓢ Kirchberger & Co., Inc., M., 1425 37th St., Brooklyn 18, N. Y.
 Ⓢ Laconia Corp., 37 S. 6th St., Newark 7, N. J.
 Ⓢ Lavelle Rubber Co., 424 N. Wood St., Chicago 22, Ill.
 Ⓢ LOUTHAN MFG. CO., East Liverpool, Ohio. ADV. PG. 284.
 Mica Fabricating Co., 53 Central Ave., Rochelle Park, N. J.
 Ⓢ Mica Insulator Co., Schenectady 1, N. Y.
 Ⓢ Micacraft Products Inc., 701 McCarter Highway, Newark 5, N. J.
 Ⓢ Moore Co., Howard J., 108 Park Row, New York 7, N. Y.
 Ⓢ Panelite Div., St. Regis Sales Corp., 230 Park Ave., New York 17, N. Y.
 Ⓢ Parisian Novelty Co., 3510 South Western Ave., Chicago 9, Ill.
 Ⓢ Penn Fibre & Specialty Co., 2020 E. Westmoreland St., Philadelphia 34, Pa.
 Ⓢ Plasticraft Products Co., 20 Hudson St., New York 13, N. Y.
 Quadriga Mfg. Co., 213 W. Grand Ave., Chicago 11, Ill.
 Ⓢ RICHARDSON CO., THE, 2767 Lake St., Melrose Park, Ill. ADV. PG. 310.
 Ⓢ Rogers Corp., Manchester, Connecticut.
 Ⓢ Schott Co., Walter L., 3225 Exposition Pl., Los Angeles 18, Calif.
 Ⓢ Smith, Inc., Herman H., 436 18th St., Brooklyn 15, N. Y.
 Ⓢ Spaulding Fibre Co., Inc., 310 Wheeler St., Tonawanda, N. Y.
 Ⓢ Star Porcelain Co., 61 Muirhead Ave., Trenton 9, N. J.
 Ⓢ Stevens Products, Inc., 86-88 Main St., East Orange, N. J.
 Ⓢ STUPAKOFF CERAMIC & MFG. CO., Latrobe, Pa. ADV. PG. 167.
 Ⓢ SYNCOR PRODUCTS CO., Malden, Mass. ADV. PG. 405.
 Ⓢ Synthane Corp., Oaks, Pa.
 Ⓢ TEFLON PRODUCTS DIVISION, U. S. GASKET CO., P. O. Box 93, Camden, N. J. ADV. PG. 176.
 Ⓢ THOR CERAMICS INC., 225 Belleville Ave., Bloomfield, N. J. ADV. PG. 378.
 Ⓢ United States Rubber Co., 1230 Avenue of the Americas, New York 20, N. Y.
 Ⓢ Wilmington Fibre Specialty Co., P. O. Drawer 1028, Wilmington 99, Del.
 Ⓢ Wolfe Co., Inc., Franklin C., 11723 Mississippi Ave., Los Angeles 25, Calif.
 Ⓢ Wrought Washer Mfg. Co., 2264 S. Bay St., Milwaukee 7, Wis.

WASHERS—Lock

- Ⓢ Allmetal Screw Products Co., Inc., 33 Greene St., New York 13, N. Y.
 Ⓢ American Nut & Bolt Fastener Co., 2045 Doerr St., Pittsburgh 33, Pa.

- Ⓢ Chase Brass & Copper Co., Inc., 236 Grand St., Waterbury 20, Conn.
 Ⓢ Continental Screw Co., New Bedford, Mass.
 Ⓢ Fafnir Bearing Co., The, New Britain, Conn.
 Ⓢ FEDERAL SCREW PRODUCTS INC., 224 W. Huron St., Chicago 10, Ill. ADV. PG. 76.
 Ⓢ Garrett Co., Inc., G. K., D & Tioga Sts., Philadelphia 34, Pa.
 Ⓢ General Cement Mfg. Co., 919 Taylor Ave., Rockford, Ill.
 Ⓢ Harper Co., H. M., 8200 Lehigh Ave., Morton Grove, Ill.
 Ⓢ Insuline Corp. of America, 36-02 35th Ave., Long Island City, N. Y.
 Ⓢ National Lock Washer Co., 40 Hermon St., Newark 5, N. J.
 Ⓢ Penn-Union Electric Corp., 315 State Street, Erie, Pa.
 Ⓢ Positive Lock Washer Co., 181 Miller St., Newark, N. J.
 Ⓢ Schott Co., Walter L., 3225 Exposition Pl., Los Angeles 18, Calif.
 Ⓢ Shakeproof, Inc., Div. of Illinois Tool Wks., 2501 N. Keeler Ave., Chicago 39, Ill.
 Ⓢ Smith, Inc., Herman H., 436 18th St., Brooklyn 15, N. Y.
 Ⓢ Standard Locknut & Lockwasher, Inc., 510 N. Capitol Ave., Indianapolis, Ind.
 Ⓢ Stronghold Screw Products, Inc., 216-222 West Hubbard St., Chicago 10, Ill.
 Ⓢ United Screw & Bolt Corp., 2513 W. Cullerton St., Chicago 8, Ill.
 Ⓢ Waldes Kohinoor Inc., 47-16 Austel Place, Long Island City 1, N. Y.
 Ⓢ Wrought Washer Mfg. Co., 2264 S. Bay St., Milwaukee 7, Wis.

WASHERS—Metal

- Ⓢ Acklin Stamping Co., 1923 Nebraska Ave., Toledo 7, Ohio.
 Ⓢ Allmetal Screw Products Co., Inc., 33 Greene St., New York 13, N. Y.
 Ⓢ Alpha Metals, Inc., 365 Hudson Ave., Brooklyn 1, N. Y.
 Ⓢ AMERICAN BRASS CO., 25 Broadway, New York 4, N. Y. ADV. PG. 330.
 Ⓢ American Nut & Bolt Fastener Co., 2045 Doerr St., Pittsburgh 33, Pa.
 Ⓢ ANCHOR METAL CO., 87 Walker St., New York 13, N. Y. ADV. PG. 270.
 Ⓢ ART-LOYD METAL PRODUCTS CORP., 2973 Cropsey Ave., Brooklyn 14, N. Y. ADV. PG. 364.
 Ⓢ Atlas Tack Corp., Pleasant St., Fairhaven, Mass.
 Ⓢ Auburn Mfg. Co., Pease Ave. & Stack St., Middletown, Conn.
 Ⓢ Autoscrew Co., 216-222 W. 18th St., New York, N. Y.
 Ⓢ BLAKE & JOHNSON CO., THE, 1495 Thomaston Ave., Waterville 48, Conn. ADV. PG. 279.
 Ⓢ Chase Brass & Copper Co., Inc., 236 Grand St., Waterbury 20, Conn.
 Ⓢ Continental Screw Co., New Bedford, Mass.
 Ⓢ FEDERAL SCREW PRODUCTS INC., 224 W. Huron St., Chicago 10, Ill. ADV. PG. 76.
 Ⓢ Felt Products Mfg. Co., 1504 W. Carroll Ave., Chicago 7, Ill.
 Ⓢ Garrett Co., Inc., G. K., D & Tioga Sts., Philadelphia 34, Pa.
 Ⓢ Gasket Engineering Co., 2440 Charlotte St., Kansas City 8, Mo.
 Ⓢ General Cement Mfg. Co., 919 Taylor Ave., Rockford, Ill.
 Ⓢ Greene Mfg. Corp., G. G., Warren, Pa.
 Ⓢ Harper Co., H. M., 8200 Lehigh Ave., Morton Grove, Ill.
 Ⓢ Industrial Precision Products Co., 315-325 N. Hoynes Ave., Chicago 12, Ill.
 Ⓢ Insuline Corp. of America, 36-02 35th Ave., Long Island City, N. Y.
 Ⓢ Locke Incorporated, P. O. Box 57, Baltimore 3, Md.
 Ⓢ METAL TEXTILE CORP., 547 E. First Ave., Roselle, N. J. ADV. PG. 40.
 Ⓢ Penn Fibre & Specialty Co., 2020 E. Westmoreland St., Philadelphia 34, Pa.
 Ⓢ Pheoil Mfg. Co., 5700 Roosevelt Rd., Chicago 50, Ill.
 Ⓢ PIX MFG. CO., INC., 24 Bedford St., Newark, N. J. ADV. PG. 136.
 Ⓢ Plume & Atwood Mfg. Co., 220 Broadway, New York, N. Y.
 Quadriga Mfg. Co., 213 W. Grand Ave., Chicago 11, Ill.
 Ⓢ Shakeproof, Inc., Div. of Illinois Tool Works, 2501 N. Keeler Ave., Chicago 39, Ill.
 Ⓢ Schott Co., Walter L., 3225 Exposition Pl., Los Angeles 18, Calif.
 Ⓢ Scovill Mfg. Co., Industrial Fastener Div., Waterbury, Conn.
 Ⓢ Smith, Inc., Herman H., 436 18th St., Brooklyn 15, N. Y.
 Stimpson Co., Inc., Edwin B., 74 Franklin Ave., Brooklyn 5, N. Y.
 Ⓢ Stronghold Screw Products, Inc., 216-222 W. Hubbard St., Chicago 10, Ill.
 Ⓢ SYLVANIA ELECTRIC PRODUCTS, INC., 1740 Broadway, New York 19, N. Y. ADV. PG. 432-436.
 Ⓢ Tricon Mfg. Co., 8318 S. Racine Ave., Chicago, Ill.
 Ⓢ United Screw & Bolt Co., 2513 W. Cullerton St., Chicago 8, Ill.

- Ⓢ Whitehead Stamping Co., 1691 W. Lafayette Blvd., Detroit 16, Mich.
 Ⓢ Wrought Washer Mfg. Co., 2264 S. Bay St., Milwaukee 7, Wis.

WATTMETERS

- Ⓢ BIRD ELECTRONIC CORP., 1800 E. 38th St., Cleveland 14, Ohio. ADV. PG. 331.
 Ⓢ Esterline-Angus Co., Inc., P. O. Box 596, Indianapolis, Ind.
 Ⓢ Fluke Engineering Co., John, Box 755, Springdale, Conn.
 Ⓢ GENERAL ELECTRIC CO., Schenectady 5, N. Y. ADV. PG. 1 to 22.
 Ⓢ JONES ELECTRONICS CO., M. C., Bristol, Conn. ADV. PG. 384.
 Ⓢ MARCONI INSTRUMENTS, LTD., 23 Beaver St., New York 4, N. Y. ADV. PG. 270.
 Ⓢ McMurdo Silver Co., Inc., 417 Lafayette St., New York, N. Y.
 Ⓢ Network Mfg. Corp., Bayonne, N. J.
 Ⓢ Rawson Electrical Instrument Co., 111 Potter St., Cambridge 42, Mass.
 Ⓢ Reliance Instrument Co., 3027 W. Van Buren St., Chicago 12, Ill.
 Ⓢ Roller-Smith, Bethlehem, Pa.
 Ⓢ Rollin Co., 2070 N. Fair Oaks Ave., Pasadena 3, Calif.
 Ⓢ Sensitive Research Instrument Corporation, 9 Elm Ave., Mt. Vernon, N. Y.
 Ⓢ Simpson Electric Co., Div. of American Gage & Machine Co., 5218 W. Kinzie St., Chicago 44, Ill.
 Ⓢ SPERRY GYROSCOPE CO., Div. of The Sperry Corp., Great Neck, N. Y. ADV. PG. 103, 104.
 Ⓢ Triplett Electrical Instrument Co., Harmon Road, Bluffton, Ohio.
 Ⓢ Welch Scientific Co., W. M., 1515 Sedgwick St., Chicago 10, Ill.
 Ⓢ WESTINGHOUSE ELECTRIC CORP., 511 Wood St., P. O. Box 868, Pittsburgh 30, Pa. ADV. PG. 107-113.
 Ⓢ WESTON ELECTRICAL INSTRUMENT CORP., 595 Frelinghuysen Ave., Newark 5, N. J. ADV. PG. 243.

WAVEGUIDES—Combination Rigid & Flexible

- Ⓢ AIRTRON, INC., 101 E. Elizabeth Ave., Linden, N. J. ADV. PG. 317.
 Ⓢ Bunnell & Co., J. H., 81 Prospect St., Brooklyn, N. Y.
 Ⓢ Electro Precision Products Inc., 119-01 22nd Ave., College Point, N. Y.
 Ⓢ KAY ELECTRIC CO., 14 Maple Ave., Pine Brook, N. J. ADV. PG. 340.
 Ⓢ KINGS MICROWAVE CO., INC., 50 Marbledale Rd., Tuckahoe 7, N. Y. ADV. PG. 178, 179.
 Ⓢ Press Wireless Mfg. Co., Inc., Cantigue Rd., Hicksville, N. Y.
 Ⓢ Schutter, Carl W., Rockville Centre, N. Y.
 Ⓢ Selector Industries, Inc., 401 E. 138th St., New York 54, N. Y.
 Ⓢ TECHNICRAFT LABORATORIES, INC., Thomaston-Waterbury Rd., Thomaston, Conn. ADV. PG. 342.

WAVEGUIDES—Flexible

- Ⓢ AIRTRON, INC., 101 E. Elizabeth Ave., Linden, N. J. ADV. PG. 317.
 Ⓢ Bunnell & Co., J. H., 81 Prospect St., Brooklyn, N. Y.
 Ⓢ Press Wireless Mfg. Co., Inc., Cantigue Rd., Hicksville, N. Y.
 Ⓢ Selector Industries, Inc., 401 E. 138th St., New York 54, N. Y.
 Ⓢ SPERRY GYROSCOPE CO., Div. of The Sperry Corp., Great Neck, N. Y. ADV. PG. 103, 104.
 Ⓢ TECHNICRAFT LABORATORIES, INC., Thomaston-Waterbury Rd., Thomaston, Conn. ADV. PG. 342.
 Ⓢ TITIFLEX, INC., 500 Frelinghuysen Ave., Newark 5, N. J. ADV. PG. 68.

WAVEGUIDES—Rigid

- Ⓢ AIRTRON, INC., 101 E. Elizabeth Ave., Linden, N. J. ADV. PG. 317.
 Ⓢ BART LABS., CO., INC., 227 Main St., Belleville 9, N. J. ADV. PG. 148.
 Ⓢ Bone Engineering Co., 701 W. Broadway, Glendale 4, Calif.
 Ⓢ Bunnell & Co., J. H., 81 Prospect St., Brooklyn, N. Y.
 Ⓢ Elecdar Co., Portsmouth, N. H.
 Ⓢ Electro Precision Products Inc., 119-01 22nd Ave., College Point, N. Y.
 Ⓢ GENERAL PLATE DIV., Metals & Controls Corp., Attleboro, Mass. ADV. PG. 300.
 Ⓢ General R-F Fittings Co., 702 Beacon St., Boston 15, Mass.
 Ⓢ Gombos Co., Inc., John, 103 Montgomery St., Irvington 11, N. J.
 Ⓢ KAY ELECTRIC CO., 14 Maple Ave., Pine Brook, N. J. ADV. PG. 340.
 Ⓢ KINGS MICROWAVE CO., INC., 50 Marbledale Rd., Tuckahoe 7, N. Y. ADV. PG. 178, 179.

Ⓢ indicates . . . IN PRODUCTION • AVAILABILITY • UNRESTRICTED FOR GENERAL USE

- Ⓢ MAKEPEACE CO., D. E., Attleboro, Mass. ADV. PG. 72.
- Ⓢ Microwave Equipment Co., Inc., North Caldwell, N. J.
- Ⓢ Model Engineering & Mfg., Inc., Huntington, Ind.
- Ⓢ Press Wireless Mfg. Co., Inc., Cantiague Rd., Hicksville, N. Y.
- Ⓢ Revere Copper & Brass, Inc., 230 Park Ave., New York 17, N. Y.
- Ⓢ Schutter, Carl W., Rockville Centre, N. Y.
- Ⓢ Selectar Industries, Inc., 401 E. 138th St., New York 54, N. Y.
- Ⓢ TECHNICRAFT LABORATORIES, INC., Thomaston-Waterbury Rd., Thomaston, Conn. ADV. PG. 342.
- Ⓢ TITFLEX, INC., 500 Frelinghuysen Ave., Newark 5, N. J. ADV. PG. 68.
- Ⓢ Varian Associates, 99 Washington St., San Carlos, Calif.

WAX IMPREGNATING

- Ⓢ BIWAX CORP., 3445 Howard St., Skokie, Ill. ADV. PG. 380.
- Ⓢ CINCH MFG. CORP., 1026 S. Homan Ave., Chicago 24, Ill. ADV. PG. 186, 187.
- Ⓢ Glyco Products Co., Inc., 26 Court St., Brooklyn, N. Y.
- Ⓢ Halowax Products Division, Union Carbide & Carbon Corp., 30 E. 42nd St., New York 17, N. Y.
- Ⓢ HI-TEST CHEMICAL CORP., 722 64th St., Brooklyn 20, N. Y. ADV. PG. 376.
- Ⓢ MITCHELL-RAND INSULATION CO., INC., 51 Murray St., New York 7, N. Y. ADV. PG. 219.
- Ⓢ Production Engineering Co., 173 Sargeant Ave., Clifton, N. J.
- Ⓢ Stevenson Bro. & Co., 110 Race St., Philadelphia 6, Pa.
- Ⓢ Tricraft Products Co., 1535 N. Ashland Ave., Chicago 22, Ill.
- Ⓢ ZOPHAR MILLS, INC., 112-130 26th St., Brooklyn 32, N. Y. ADV. PG. 397.

WAXES

See Insulating Compounds

WEDGES—Wood Slot

- Ⓢ Insulation Manufacturers Corp., 565 W. Washington Bldg., Chicago 6, Ill.
- Ⓢ MITCHELL-RAND INSULATION CO., INC., 51 Murray St., New York 7, N. Y. ADV. PG. 219.

WELDERS—Electronic Controlled

- Eutectic Welding Alloys Corp., 40 Worth St., New York 13, N. Y.
- Ⓢ Federal Tool Engineering Co., 532 Mulberry St., Newark 5, N. J.
- Ⓢ GENERAL ELECTRIC CO., Schenectady 5, N. Y. ADV. PG. 1 to 22.
- Ⓢ Joyal Products, Inc., 56 Belmont Ave., Newark, N. J.
- Ⓢ Sclaki Bros., Inc., 4915 W. 67th St., Chicago 38, Ill.
- Ⓢ Sheffield Corp., The, Dayton 1, Ohio.
- Ⓢ Unitek Corp., Pasadena, Calif.

WINDING MACHINES, COIL

See Coil Winding Machines

WIRE—Aluminum

- Ⓢ Aluminum Co. of America, Gulf Bldg., Pittsburgh 30, Pa.
- Ⓢ Anaconda Wire & Cable Co., 25 Broadway, New York 4, N. Y.
- Ⓢ Birnbach Radio Co., Inc., 145 Hudson St., New York, N. Y.
- Ⓢ COLUMBIA WIRE & SUPPLY CO., 2850 Irving Park Rd., Chicago 18, Ill. ADV. PG. 396.
- Ⓢ HUDSON WIRE CO., Ossining, N. Y. ADV. PG. 106.
- Ⓢ Little Falls Alloys, Inc., 190 Caldwell Ave., Paterson 1, N. J.
- Ⓢ North American Philips Co., Inc., 100 E. 42nd St., New York 17, N. Y.
- Ⓢ PLASTOID CORP., 10 Mill Rd., Hamburg, N. J. ADV. PG. 117.
- Ⓢ Smith, Inc., Herman H., 436 18th St., Brooklyn 15, N. Y.
- Ⓢ Sun Copper & Wire Co., 132 Beckwith Ave., Paterson, N. J.
- Ⓢ Surprenant Mfg. Co., 199 Washington St., Boston 8, Mass.
- Ⓢ Uniform Tubes, Shurs Lane & Laruiston St., Roxborough, Philadelphia, Pa.
- Ⓢ United States Rubber Co., 1230 Avenue of the Americas, New York 20, N. Y.

WIRE—Annunciator

- Ⓢ Advance Insulated Wire & Cable Co., 115 Spring St., Morristown, N. J.
- Ⓢ American Steel & Wire Co., Rockefeller Bldg., Cleveland 13, Ohio.

- Ⓢ Anaconda Wire & Cable Co., 25 Broadway, New York 4, N. Y.
- Ⓢ Birnbach Radio Co., Inc., 145 Hudson St., New York, N. Y.
- Ⓢ CHESTER CABLE CORP., Hill St., Chester, N. Y. ADV. PG. 207.
- Ⓢ COLUMBIA WIRE & SUPPLY CO., 2850 Irving Park Rd., Chicago 18, Ill. ADV. PG. 396.
- Ⓢ Consolidated Wire & Associated Companies, 1635 S. Clinton St., Chicago 16, Ill.
- Ⓢ CORNISH WIRE CO., 50 Church St., New York 7, N. Y. ADV. PG. 71.
- Ⓢ Goldmark Wire Co., James, The, 75 Murray St., New York 7, N. Y.
- Ⓢ PLASTOID CORP., 10 Mill Rd., Hamburg, N. J. ADV. PG. 117.
- Ⓢ Rhode Island Insulated Wire Co., Inc., 50 Burnham Ave., Cranston, R. I.
- Ⓢ Television Specialty Co., Haverstraw, N. Y.
- Ⓢ United States Rubber Co., 1230 Avenue of the Americas, New York 20, N. Y.

WIRE—Antenna

- Ⓢ American Electric Cable Co., 181 Appleton St., Holyoke, Mass.
- Ⓢ Anaconda Wire & Cable Co., 25 Broadway, New York 4, N. Y.
- Ⓢ Atlantic Wire & Cable Corp., 254 Huron St., Brooklyn, N. Y.
- Ⓢ Belden Mfg. Co., 4647 W. Van Buren St., Chicago 44, Ill.
- Ⓢ Birnbach Radio Co., Inc., 145 Hudson St., New York, N. Y.
- Ⓢ CHESTER CABLE CORP., Hill St., Chester, N. Y. ADV. PG. 207.
- Ⓢ Clear Beam Television Antenna Co., 618 N. LaBrea Ave., Los Angeles 36, Calif.
- Ⓢ COLUMBIA WIRE & SUPPLY CO., 2850 Irving Park Rd., Chicago 18, Ill. ADV. PG. 396.
- Ⓢ Consolidated Wire & Associated Companies, 1635 S. Clinton St., Chicago 16, Ill.
- Ⓢ Copperweld Steel Co., Glassport, Pa.
- Ⓢ Electrovox Co., Inc., 60 Franklin St., East Orange, N. J.
- Ⓢ Essex Wire Corp., 1601 Wall St., Fort Wayne 6, Ind.
- Ⓢ FEDERAL TELEPHONE AND RADIO CORP., 88 Kingsland Rd., Clifton, N. J. ADV. PG. 161-163.
- Ⓢ Flader, Inc., Fredric, 1330 Laskey Rd., Toledo 12, Ohio.
- Ⓢ Guthman, Inc., Edwin I., 15 S. Throop St., Chicago, Ill.
- Ⓢ Insuline Corp., of America, 36-02 35th Ave., Long Island City, N. Y.
- Ⓢ JFD MFG. CO., 6101-23 Sixteenth Ave., Brooklyn, N. Y. ADV. PG. 407.
- Ⓢ Jersey Specialty Co., Little Falls, N. J.
- Ⓢ JOHNSON CO., E. F., Waseca, Minn. ADV. PG. 118, 121.
- Ⓢ Phelps Dodge Copper Products Corp., 40 Wall St., New York 5, N. Y.
- Ⓢ Plastic Wire & Cable Corp., Jewett City, Conn.
- Ⓢ PLASTOID CORP., 10 Mill Rd., Hamburg, N. J. ADV. PG. 117.
- Ⓢ STERLING CABLE CO., 350 Fifth Ave., New York 1, N. Y. ADV. PG. 412.
- Ⓢ Television Specialty Co., Haverstraw, N. Y.

WIRE—Asbestos Insulated

- Ⓢ American Steel & Wire Co., Rockefeller Bldg., Cleveland 13, Ohio.
- Ⓢ Belden Mfg. Co., 4647 W. Van Buren St., Chicago 44, Ill.
- Ⓢ CHESTER CABLE CORP., Hill St., Chester, N. Y. ADV. PG. 207.
- Ⓢ Collyer Insulated Wire Co., 249 Roosevelt Ave., Pawtucket, R. I.
- Ⓢ COLUMBIA WIRE & SUPPLY CO., 2850 Irving Park Rd., Chicago 18, Ill. ADV. PG. 396.
- Ⓢ Consolidated Wire & Associated Companies, 1635 S. Clinton St., Chicago 16, Ill.
- Ⓢ Essex Wire Corp., 1601 Wall St., Fort Wayne 6, Ind.
- Ⓢ Gordon Co., Claud S., 3000 S. Wallace St., Chicago 16, Ill.
- Ⓢ Okonite Co., Canal St., Passaic, N. J.
- Ⓢ Phelps Dodge Copper Products Corp., 40 Wall St., New York 5, N. Y.
- Ⓢ Rhode Island Insulated Wire Co., Inc., 50 Burnham Ave., Cranston, R. I.
- Ⓢ Rockbestos Products Corp., 285 Nicoll St., New Haven 4, Conn.
- Ⓢ United States Rubber Co., 1230 Avenue of the Americas, New York 20, N. Y.
- Ⓢ Western Insulated Wire Co., 2421 E. 30th St., Los Angeles, Calif.

WIRE—Ceramic Insulated

- Ⓢ Consolidated Wire & Associated Companies, 1635 S. Clinton St., Chicago 16, Ill.
- Ⓢ Phelps Dodge Copper Products Corp., 40 Wall St., New York 5, N. Y.
- Ⓢ Sprague Electric Co., North Adams, Mass.

WIRE—Copper

- Ⓢ Advance Insulated Wire & Cable Co., 115 Spring St., Morristown, N. J.
- Ⓢ Alpha Wire Corp., 430 Broadway, New York, N. Y.
- Ⓢ AMERICAN BRASS CO., 25 Broadway, New York 4, N. Y. ADV. PG. 330.
- Ⓢ American Electric Cable Co., 181 Appleton St., Holyoke, Mass.
- Ⓢ American Steel & Wire Co., Rockefeller Bldg., Cleveland 13, Ohio.
- Ⓢ Anaconda Wire & Cable Co., 25 Broadway, New York 4, N. Y.
- Ⓢ Birnbach Radio Co., Inc., 145 Hudson St., New York, N. Y.
- Ⓢ Belden Mfg. Co., 4647 W. Van Buren St., Chicago 44, Ill.
- Ⓢ Carol Cable Co., 190 Middle St., Pawtucket, R. I.
- Ⓢ Chase Brass & Copper Co., Inc., 236 Grand St., Waterbury 20, Conn.
- Ⓢ CHESTER CABLE CORP., Hill St., Chester, N. Y. ADV. PG. 207.
- Ⓢ COLUMBIA WIRE & SUPPLY CO., 2850 Irving Park Rd., Chicago 18, Ill. ADV. PG. 396.
- Ⓢ Consolidated Wire & Associated Companies, 1635 S. Clinton St., Chicago 16, Ill.
- Ⓢ Diamond Wire & Cable Co., Sycamore, Ill.
- Ⓢ Essex Wire Corp., 1601 Wall St., Fort Wayne 6, Ind.
- Ⓢ Goldmark Wire Co., James, 75 Murray St., New York 7, N. Y.
- Ⓢ Gordon Co., Claud S., 3000 S. Wallace St., Chicago 16, Ill.
- Ⓢ Guthman, Inc., Edwin I., 15 S. Throop St., Chicago, Ill.
- Ⓢ HUDSON WIRE CO., Ossining, N. Y. ADV. PG. 106.
- Ⓢ Nonotuck Mfg. Co., Holyoke, Mass.
- Ⓢ North American Philips Co., Inc., 100 E. 42nd St., New York 17, N. Y.
- Ⓢ Phelps Dodge Copper Products Corp., 40 Wall St., New York 5, N. Y.
- Ⓢ PLASTOID CORP., 10 Mill Rd., Hamburg, N. J. ADV. PG. 117.
- Ⓢ Plume & Atwood Mfg. Co., 220 Broadway, New York, N. Y.
- Ⓢ Rea Magnet Wire Co., E. Pontiac St., Fort Wayne, Ind.
- Ⓢ Roebeling's Sons Co., John A., 640 Broad St., Trenton 2, N. J.
- Ⓢ ROME CABLE CORP., 330 Ridge St., Rome, N. Y. ADV. PG. 215.
- Ⓢ Runzel Cord & Wire Co., 4723-31 W. Montrose Ave., Chicago 41, Ill.
- Ⓢ Scovill Mfg. Co., Industrial Fastener Div., Waterbury, Conn.
- Ⓢ Short Wave Plastic Forming Co., 2921 W. Alameda St., Burbank, Calif.
- Ⓢ Slepian Co., Arthur, Bridgeport, Conn.
- Ⓢ STERLING CABLE CO., 350 Fifth Ave., New York 1, N. Y. ADV. PG. 412.
- Ⓢ Sun Copper & Wire Co., 132 Beckwith Ave., Paterson, N. J.
- Ⓢ Surprenant Mfg. Co., 199 Washington St., Boston 8, Mass.
- Ⓢ SYLVANIA ELECTRIC PRODUCTS, INC., 1740 Broadway, New York 19, N. Y. ADV. PG. 432-436.
- Ⓢ United States Rubber Co., 1230 Avenue of the Americas, New York 20, N. Y.

WIRE—Copper, Insulated

- Ⓢ Acme Wire Co., New Haven 14, Conn.
- Ⓢ Advance Insulated Wire & Cable Co., 115 Spring St., Morristown, N. J.
- Ⓢ ALDEN PRODUCTS CO., 117 No. Main St., Brockton 64, Mass. ADV. PG. 327.
- Ⓢ Alpha Wire Corp., 430 Broadway, New York, N. Y.
- Ⓢ American Electric Cable Co., 181 Appleton St., Holyoke, Mass.
- Ⓢ American Steel & Wire Co., Rockefeller Bldg., Cleveland 13, Ohio.
- Ⓢ Anaconda Wire & Cable Co., 25 Broadway, New York 4, N. Y.
- Ⓢ ANSONIA ELECTRICAL CO., 63 Main St., Ansonia, Conn. ADV. PG. 124.
- Ⓢ Belden Mfg. Co., 4647 W. Van Buren St., Chicago 44, Ill.
- Ⓢ Birnbach Radio Co., Inc., 145 Hudson St., New York, N. Y.
- Ⓢ Boston Insulated Wire & Cable Co., 63 Bay St., Boston 25, Mass.
- Ⓢ BRAND & CO., INC., WM., North & Valley Sts., Willimantic, Conn. ADV. PG. 248, 249.
- Ⓢ Carol Cable Co., 190 Middle St., Pawtucket, R. I.
- Ⓢ Chase Brass & Copper Co., Inc., 236 Grand St., Waterbury 20, Conn.
- Ⓢ CHESTER CABLE CORP., Hill St., Chester, N. Y. ADV. PG. 207.
- Ⓢ Collyer Insulated Wire Co., 249 Roosevelt Ave., Pawtucket, R. I.
- Ⓢ COLUMBIA WIRE & SUPPLY CO., 2850 Irving Park Rd., Chicago 18, Ill. ADV. PG. 396.
- Ⓢ Consolidated Wire & Associated Companies, 1635 S. Clinton St., Chicago 16, Ill.
- Ⓢ CORNISH WIRE CO., 50 Church St., New York 7, N. Y. ADV. PG. 71.
- Ⓢ Diamond Wire & Cable Co., Sycamore, Ill.
- Ⓢ Dielectric Materials Co., 5315-17 N. Ravenswood Ave., Chicago 40, Ill.

Ⓜ indicates . . . IN PRODUCTION • AVAILABILITY • UNRESTRICTED FOR GENERAL USE

- Ⓜ Electro-Wire Service, 5 Beekman St., New York 7, N. Y.
- Ⓜ Essex Wire Corp., 1601 Wall St., Fort Wayne 6, Ind.
- Ⓜ FEDERAL TELEPHONE & RADIO CORP., 88 Kingsland Rd., Clifton, N. J. ADV. PG. 161-163.
- Ⓜ Flader, Inc., Fredric, 1330 Laskey Rd., Toledo 12, Ohio.
- Ⓜ General Insulated Wire Works, Inc., 69 Gordon Ave., Providence 5, R. I.
- Ⓜ Goldmark Wire Co., James, 75 Murray St., New York 7, N. Y.
- Ⓜ Gordon Co., Claud S., 3000 S. Wallace St., Chicago 16, Ill.
- Ⓜ Guthman Inc., Edwin I., 15 S. Throop St., Chicago, Ill.
- Ⓜ Hazard Insulated Wire Works Div., The Okonite Co., Wilkes-Barre, Pa.
- Ⓜ HUDSON WIRE CO., Ossining, N. Y. ADV. PG. 106.
- Ⓜ LENZ ELECTRIC MFG. CO., 1751 North Western Ave., Chicago 47, Ill. ADV. PG. 236.
- Ⓜ New England Electrical Works, Inc., Lisbon, N. H.
- Ⓜ Okonite Co., Canal St., Passaic, N. J.
- Ⓜ PHALO PLASTIC CORP., 25 Foster St., Worcester 8, Mass. ADV. PG. 282.
- Ⓜ Phelps Dodge Copper Products Corp., 40 Wall St., New York 5, N. Y.
- Ⓜ Plastic Wire & Cable Corp., Jewett City, Conn.
- Ⓜ PLASTOID CORP., 10 Mill Rd., Hamburg, N. J. ADV. PG. 117.
- Ⓜ PRODUCT DEVELOPMENT CO., INC., Arlington, N. J. ADV. PG. 362.
- Ⓜ Rea Magnetic Wire Co., E. Pontiac St., Fort Wayne, Ind.
- Ⓜ Rhode Island Insulated Wire Co., Inc., 50 Burnham Ave., Cranston, R. I.
- Ⓜ Rockbestos Products Corp., 285 Nicoll St., New Haven 4, Conn.
- Ⓜ Roebling's Sons Co., John A., 640 Broad St., Trenton 2, N. J.
- Ⓜ ROME CABLE CORP., 330 Ridge St., Rome, N. Y. ADV. PG. 215.
- Ⓜ Ross Mfg. Co., 860 Washington St., Burlington, Iowa.
- Ⓜ Runzel Cord & Wire Co., 4723-31 W. Montrose Ave., Chicago 41, Ill.
- Ⓜ Simplex Wire & Cable Co., 79 Sidney St., Cambridge 39, Mass.
- Ⓜ Slepian Co., Arthur, Bridgeport, Conn.
- Ⓜ STERLING CABLE CO., 350 Fifth Ave., New York 1, N. Y. ADV. PG. 412.
- Ⓜ Sun Copper & Wire Co., 132 Beckwith Ave., Paterson, N. J.
- Ⓜ Surprenant Mfg. Co., 199 Washington St., Boston 10, Mass.
- Ⓜ TENSOLITE INSULATED WIRE CO., 198 Main St., Tarrytown, N. Y. ADV. PG. 316.
- Ⓜ United States Rubber Co., 1230 Avenue of the Americas, New York 20, N. Y.
- Ⓜ Western Insulated Wire Co., 2421 E. 30th St., Los Angeles, Calif.
- Ⓜ Whitaker Cable Corp., Kansas City 16, Mo.
- Ⓜ Whitney Blake Co., Box K, New Haven 14, Conn.

WIRE—Cut and Stripped

- Ⓜ ALDEN PRODUCTS CO., 117 N. Main St., Brockton 64, Mass. ADV. PG. 327.
- Ⓜ American Electric Cable Co., 181 Appleton St., Holyoke, Mass.
- Ⓜ Belden Mfg. Co., 4647 W. Van Buren St., Chicago 44, Ill.
- Ⓜ BRAND & CO., INC., WM., North & Valley Sts., Willimantic, Conn. ADV. PG. 248, 249.
- Ⓜ Carol Cable Co., 190 Middle St., Pawtucket, R. I.
- Ⓜ COLUMBIA WIRE & SUPPLY CO., 2850 Irving Park Rd., Chicago 18, Ill. ADV. PG. 396.
- Ⓜ Diamond Wire & Cable Co., Sycamore, Ill.
- Ⓜ Electro-Wire Service, 5 Beekman St., New York 7, N. Y.
- Ⓜ Essex Wire Corp., 1601 Wall St., Fort Wayne 6, Ind.
- Ⓜ General Insulated Wire Works, Inc., 69 Gordon Ave., Providence 5, R. I.
- Ⓜ LENZ ELECTRIC MFG. CO., 1751 N. Western Ave., Chicago 47, Ill. ADV. PG. 236.
- Ⓜ MID-WEST COIL & TRANSFORMER CO., 1642 N. Halsted St., Chicago 14, Ill. ADV. PG. 165.
- Ⓜ Pacific Electricord Co., 3217 Exposition Place, Los Angeles 18, Calif.
- Ⓜ PHALO PLASTICS CORP., 25 Foster St., Worcester 8, Mass. ADV. PG. 282.
- Ⓜ PIX MFG. CO., INC., 24 Bedford St., Newark, N. J. ADV. PG. 136.
- Ⓜ Plastic Wire & Cable Corp., Jewett City, Conn.
- Ⓜ Rhode Island Insulated Wire Co., Inc., 50 Burnham Ave., Cranston, R. I.
- Ⓜ Rockbestos Products Corp., 285 Nicoll St., New Haven 4, Conn.
- Ⓜ Runzel Cord & Wire Co., 4723-31 W. Montrose Ave., Chicago 41, Ill.
- Ⓜ Smith, Inc., Herman H., 436 18th St., Brooklyn 15, N. Y.
- Ⓜ TENSOLITE INSULATED WIRE CO., 198 Main St., Tarrytown, N. Y. ADV. PG. 316.
- Ⓜ Tricraft Products Co., 1535 N. Ashland Ave., Chicago 22, Ill.
- Ⓜ Whitaker Cable Corp., Kansas City 16, Mo.

WIRE—Enameled

- Ⓜ Acme Wire Co., New Haven 14, Conn.
- Ⓜ Alpha Wire Corp., 430 Broadway, New York, N. Y.
- Ⓜ American Steel & Wire Co., Rockefeller Bldg., Cleveland 13, Ohio.
- Ⓜ Anaconda Wire & Cable Co., 25 Broadway, New York 4, N. Y.
- Ⓜ Belden Mfg. Co., 4647 W. Van Buren St., Chicago 44, Ill.
- Ⓜ Birnbach Radio Co., Inc., 145 Hudson St., New York, N. Y.
- Ⓜ Chase Brass & Copper Co., Inc., 236 Grand St., Waterbury 20, Conn.
- Ⓜ COHN CORP., SIGMUND, 44 Gold St., New York 7, N. Y. ADV. PG. 278.
- Ⓜ Consolidated Wire & Associated Companies, 1635 S. Clinton St., Chicago 16, Ill.
- Ⓜ DRIVER-HARRIS CO., 201 Middlesex St., Harrison, N. J. ADV. PG. 131.
- Ⓜ Essex Wire Corp., 1601 Wall St., Fort Wayne 6, Ind.
- Ⓜ Goldmark Wire Co., James, 75 Murray St., New York 7, N. Y.
- Ⓜ Gordon Co., Claud S., 3000 S. Wallace St., Chicago 16, Ill.
- Ⓜ Guthman, Inc., Edwin I., 15 S. Throop St., Chicago, Ill.
- Ⓜ HUDSON WIRE CO., Ossining, N. Y. ADV. PG. 106.
- Ⓜ Inductive Equipment Co., Gettysburg, Pa.
- Ⓜ JELLIFF MFG. CORP., C. O., 200 Pequot Ave., Southport, Conn. ADV. PG. 405.
- Ⓜ North American Philips Co., Inc., 100 E. 42nd St., New York 17, N. Y.
- Ⓜ Phelps Dodge Copper Products Corp., 40 Wall St., New York 5, N. Y.
- Ⓜ Rea Magnet Wire Co., E. Pontiac St., Fort Wayne, Ind.
- Ⓜ Roebling's Sons Co., John A., 640 Broad St., Trenton 2, N. J.
- Ⓜ Secon Metals Corp., 228 E. 45th St., New York 17, N. Y.
- Ⓜ Slepian Co., Arthur, Bridgeport, Conn.
- Ⓜ Sun Copper & Wire Co., 132 Beckwith Ave., Paterson, N. J.

WIRE—Fine Wire Specialties

- Ⓜ Accurate Spring Mfg. Co., 3811 W. Lake St., Chicago, Ill.
- Ⓜ Alloy Metal Wire Co., 13th & Penna. Ave., Prospect Park, Pa.
- Ⓜ Alpha Wire Corp., 430 Broadway, New York, N. Y.
- Ⓜ American Electric Cable Co., 181 Appleton St., Holyoke, Mass.
- Ⓜ Baker & Co., Inc., 113 Astor St., Newark 5, N. J.
- Ⓜ BRAND & CO., INC., WM., North & Valley Sts., Willimantic, Conn. ADV. PG. 248, 249.
- Ⓜ CHESTER CABLE CORP., Hill St., Chester, N. Y. ADV. PG. 207.
- Ⓜ COHN CORP., SIGMUND, 44 Gold St., New York 7, N. Y. ADV. PG. 278.
- Ⓜ DRIVER-HARRIS CO., 201 Middlesex St., Harrison, N. J. ADV. PG. 131.
- Ⓜ Dudek & Bock Spring & Mfg. Co., 2100 W. Fulton, Chicago 12, Ill.
- Ⓜ Essex Wire Corp., 1601 Wall St., Fort Wayne 6, Ind.
- Ⓜ Goldmark Wire Co., James, 75 Murray St., New York 7, N. Y.
- Ⓜ Guthman, Inc., Edwin I., 15 S. Throop St., Chicago, Ill.
- Ⓜ HUDSON WIRE CO., Ossining, N. Y. ADV. PG. 106.
- Ⓜ IMPROVED SEAMLESS WIRE CO., 775 Eddy St., Providence, R. I. ADV. PG. 314.
- Ⓜ JELLIFF MFG. CORP., C. O., 200 Pequot Ave., Southport, Conn. ADV. PG. 405.
- Ⓜ Judd Co., H. L., 87 Chambers St., New York 7, N. Y.
- Ⓜ Little Falls Alloys, Inc., 190 Caldwell Ave., Paterson 1, N. J.
- Ⓜ METAL TEXTILE CORP., 547 E. First Ave., Roselle, N. J. ADV. PG. 40.
- Ⓜ New England Electrical Works, Inc., Lisbon, N. H.
- Ⓜ NEY CO., J. M., 179 Elm St., Hartford, Conn. ADV. PG. 246.
- Ⓜ North American Philips Co., Inc., 100 E. 42nd St., New York 17, N. Y.
- Ⓜ Phelps Dodge Copper Products Corp., 40 Wall St., New York 5, N. Y.
- Ⓜ PIX MFG. CO., INC., 24 Bedford St., Newark, N. J. ADV. PG. 136.
- Ⓜ Secon Metals Corp., 228 E. 45th St., New York 17, N. Y.
- Ⓜ Sun Copper & Wire Co., 132 Beckwith Ave., Paterson, N. J.
- Ⓜ Surprenant Mfg. Co., 199 Washington St., Boston 10, Mass.
- Ⓜ SYLVANIA ELECTRIC PRODUCTS, INC., 1740 Broadway, New York 19, N. Y. ADV. PG. 432-436.
- Ⓜ TENSOLITE INSULATED WIRE CO., 198 Main St., Tarrytown, N. Y. ADV. PG. 316.
- Ⓜ YORK CO., INC., OTTO H., 69 Glenwood Place, East Orange, N. J. ADV. PG. 174.

WIRE—Glass Insulated

- Ⓜ Acme Wire Co., New Haven 14, Conn.
- Ⓜ Alpha Wire Corp., 430 Broadway, New York, N. Y.

- Ⓜ American Electric Cable Co., 181 Appleton St., Holyoke, Mass.
- Ⓜ American Steel & Wire Co., Rockefeller Bldg., Cleveland 13, Ohio.
- Ⓜ Boston Insulated Wire & Cable Co., 63 Bay St., Boston 25, Mass.
- Ⓜ BRAND & CO., INC., WM., North & Valley Sts., Willimantic, Conn. ADV. PG. 248, 249.
- Ⓜ Chase Brass & Copper Co., Inc., 236 Grand St., Waterbury 20, Conn.
- Ⓜ CHESTER CABLE CORP., Hill St., Chester, N. Y. ADV. PG. 207.
- Ⓜ COLUMBIA WIRE & SUPPLY CO., 2850 Irving Park Rd., Chicago 18, Ill. ADV. PG. 396.
- Ⓜ Consolidated Wire & Associated Companies, 1635 S. Clinton St., Chicago 16, Ill.
- Ⓜ Dielectric Materials Co., 5315-17 N. Ravenswood Ave., Chicago 40, Ill.
- Ⓜ DRIVER-HARRIS CO., 201 Middlesex St., Harrison, N. J. ADV. PG. 131.
- Ⓜ Essex Wire Corp., 1601 Wall St., Fort Wayne 6, Ind.
- Ⓜ Gordon Co., Claud S., 3000 S. Wallace St., Chicago 16, Ill.
- Ⓜ Hazard Insulated Wire Works Div., The Okonite Co., Wilkes-Barre, Pa.
- Ⓜ Inductive Equipment Co., Gettysburg, Pa.
- Ⓜ LENZ ELECTRIC MFG. CO., 1751 North Western Ave., Chicago 47, Ill. ADV. PG. 236.
- Ⓜ Okonite Co., Canal St., Passaic, N. J.
- Ⓜ Phelps Dodge Copper Products Corp., 40 Wall St., New York 5, N. Y.
- Ⓜ PLASTOID CORP., 10 Mill Rd., Hamburg, N. J. ADV. PG. 117.
- Ⓜ Rhode Island Insulated Wire Co., Inc., 50 Burnham Ave., Cranston, R. I.
- Ⓜ ROME CABLE CORP., 330 Ridge St., Rome, N. Y. ADV. PG. 215.
- Ⓜ Runzel Cord & Wire Co., 4723-31 W. Montrose Ave., Chicago 41, Ill.
- Ⓜ Slepian Co., Arthur, Bridgeport, Conn.
- Ⓜ STERLING CABLE CO., 350 Fifth Ave., New York 1, N. Y. ADV. PG. 412.
- Ⓜ Surprenant Mfg. Co., 199 Washington St., Boston 10, Mass.

WIRE—Guy

- Ⓜ Alpha Wire Corp., 430 Broadway, New York 13, N. Y.
- Ⓜ American Steel & Wire Co., Rockefeller Bldg., Cleveland 13, Ohio.
- Ⓜ Birnbach Radio Co., Inc., 145 Hudson St., New York, N. Y.
- Ⓜ COLUMBIA WIRE & SUPPLY CO., 2850 Irving Park Rd., Chicago 18, Ill. ADV. PG. 396.
- Ⓜ Copperwell Steel Co., Glassport, Pa.
- Ⓜ General Cement Mfg. Co., 919 Taylor Ave., Rockford, Ill.
- Ⓜ Insuline Corp. of America, 36-02 35th Ave., Long Island City, N. Y.
- Ⓜ JFD MFG. CO., 6101-23 Sixteenth Ave., Brooklyn, N. Y. ADV. PG. 407.
- Ⓜ Roebling's Sons Co., John A., 640 Broad St., Trenton 2, N. J.
- Ⓜ Schott Co., Walter L., 3225 Exposition Pl., Los Angeles 18, Calif.

WIRE—Hookup

- Ⓜ Advance Insulated Wire & Cable Co., 115 Spring St., Morristown, N. J.
- Ⓜ ALDEN PRODUCTS CO., 117 No. Main St., Brockton 64, Mass. ADV. PG. 327.
- Ⓜ Alpha Wire Corp., 430 Broadway, New York, N. Y.
- Ⓜ American Electric Cable Co., 181 Appleton St., Holyoke, Mass.
- Ⓜ American Steel & Wire Co., Rockefeller Bldg., Cleveland 13, Ohio.
- Ⓜ Anaconda Wire & Cable Co., 25 Broadway, New York 4, N. Y.
- Ⓜ Atlantic Wire & Cable Corp., 254 Huron St., Brooklyn, N. Y.
- Ⓜ Belden Mfg. Co., 4647 W. Van Buren St., Chicago 44, Ill.
- Ⓜ Birnbach Radio Co., Inc., 145 Hudson St., New York, N. Y.
- Ⓜ Boston Insulated Wire & Cable Co., 63 Bay St., Boston 25, Mass.
- Ⓜ BRAND & CO., INC., WM., North & Valley Sts., Willimantic, Conn. ADV. PG. 248, 249.
- Ⓜ CHESTER CABLE CORP., Hill St., Chester, N. Y. ADV. PG. 207.
- Ⓜ COLUMBIA WIRE & SUPPLY CO., 2850 Irving Park Rd., Chicago 18, Ill. ADV. PG. 391.
- Ⓜ Consolidated Wire & Associated Companies, 1635 S. Clinton St., Chicago 16, Ill.
- Ⓜ CORNISH WIRE CO., 50 Church St., New York 7, N. Y. ADV. PG. 71.
- Ⓜ Dielectric Materials Co., 5315-17 N. Ravenswood Ave., Chicago 40, Ill.
- Ⓜ Electrovox Co., Inc., 60 Franklin St., East Orange, N. J.
- Ⓜ Electro-Wire Service, 5 Beekman St., New York 7, N. Y.
- Ⓜ Essex Wire Corp., 1601 Wall St., Fort Wayne 6, Ind.
- Ⓜ HUDSON WIRE CO., Ossining, N. Y. ADV. PG. 106.
- Ⓜ JFD MFG. CO., 6101-23 Sixteenth Ave., Brooklyn, N. Y. ADV. PG. 407.

V indicates . . . IN PRODUCTION • AVAILABILITY • UNRESTRICTED FOR GENERAL USE

- Ⓞ LENZ ELECTRIC MFG. CO., 1751 N. Western Ave., Chicago 47, Ill. ADV. PG. 236.
- Ⓞ PHALO PLASTICS CORP., 25 Foster St., Worcester 8, Mass. ADV. PG. 282.
- Ⓞ Phelps Dodge Copper Products Corp., 40 Wall St., New York 5, N. Y.
- Ⓞ Philadelphia Insulated Wire Co., 220 N. 3rd St., Philadelphia, Pa.
- Ⓞ Plastic Wire & Cable Corp., Jewett City, Conn.
- Ⓞ PLASTOID CORP., 10 Mill Rd., Hamburg, N. J. ADV. PG. 117.
- Ⓞ Rhode Island Insulated Wire Co., Inc., 50 Burnham Ave., Cranston, R. I.
- Ⓞ Rockbestos Products Corp., 285 Nicoll St., New Haven 4, Conn.
- Ⓞ ROME CABLE CORP., 330 Ridge St., Rome, N. Y. ADV. PG. 215.
- Ⓞ Runzel Cord & Wire Co., 4723-31 W. Montrose Ave., Chicago 41, Ill.
- Ⓞ STERLING CABLE CO., 350 Fifth Ave., New York 1, N. Y. ADV. PG. 412.
- Ⓞ Surprenant Mfg. Co., 199 Washington St., Boston 10, Mass.
- Ⓞ Television Specialty Co., Haverstraw, N. Y.
- Ⓞ TENSOLITE INSULATED WIRE CO., 198 Main St., Tarrytown, N. Y. ADV. PG. 316.

WIRE—Litz

- Ⓞ Belden Mfg. Co., 4647 W. Van Buren St., Chicago 44, Ill.
- Ⓞ Consolidated Wire & Associated Companies, 1635 S. Clinton St., Chicago 16, Ill.
- Ⓞ Guthman, Inc., Edwin I., 15 S. Throop St., Chicago, Ill.
- Ⓞ HUDSON WIRE CO., Ossining, N. Y. ADV. PG. 106.
- Ⓞ New England Electrical Works, Inc., Lisbon, N. H.
- Ⓞ Philadelphia Insulated Wire Co., 220 N. 3rd St., Philadelphia, Pa.
- Ⓞ Ross Mfg. Co., 860 Washington St., Burlington, Iowa.
- Ⓞ Slepian Co., Arthur, Bridgeport, Conn.
- Ⓞ Sun Copper & Wire Co., 132 Beckwith Ave., Paterson, N. J.
- Ⓞ Wheeler Insulated Wire Co., Inc., 150 E. Aurora St., Waterbury 91, Conn.

WIRE—Magnet

- Ⓞ Acme Wire Co., New Haven 14, Conn.
- Ⓞ American Steel & Wire Co., Rockefeller Bldg., Cleveland 13, Ohio.
- Ⓞ Anaconda Wire & Cable Co., 25 Broadway, New York 4, N. Y.
- Ⓞ Belden Mfg. Co., 4647 W. Van Buren St., Chicago 44, Ill.
- Ⓞ Birnbach Radio Co., Inc., 145 Hudson St., New York, N. Y.
- Ⓞ Chase Brass & Copper Co., Inc., 236 Grand St., Waterbury 20, Conn.
- Ⓞ Consolidated Wire & Associated Companies, 1635 S. Clinton St., Chicago 16, Ill.
- Ⓞ Essex Wire Corp., 1601 Wall St., Fort Wayne 6, Ind.
- Ⓞ GENERAL ELECTRIC CO., Construction Materials Dept., 1285 Boston Ave., Bridgeport 2, Conn. ADV. PG. 1 to 22.
- Ⓞ Goldmark Wire Co., James, 75 Murray St., New York 7, N. Y.
- Ⓞ Guthman, Inc., Edwin I., 15 S. Throop St., Chicago, Ill.
- Ⓞ HUDSON WIRE CO., Ossining, N. Y. ADV. PG. 106.
- Ⓞ Inductive Equipment Co., Gettysburg, Pa.
- Ⓞ New England Electrical Works, Inc., Lisbon, N. H.
- Ⓞ North American Philips Co., Inc., 100 E. 42nd St., New York 17, N. Y.
- Ⓞ Phelps Dodge Copper Products Corp., 40 Wall St., New York 5, N. Y.
- Ⓞ Philadelphia Insulated Wire Co., 220 N. 3rd St., Philadelphia, Pa.
- Ⓞ Rea Magnet Wire Co., E. Pontiac St., Fort Wayne, Ind.
- Ⓞ Rockbestos Products Corp., 285 Nicoll St., New Haven 4, Conn.
- Ⓞ Roebbling's Sons Co., John A., 640 Broad St., Trenton 2, N. J.
- Ⓞ ROME CABLE CORP., 330 Ridge St., Rome, N. Y. ADV. PG. 215.
- Ⓞ Ross Mfg. Co., 860 Washington St., Burlington, Iowa.
- Ⓞ Slepian Co., Arthur, Bridgeport, Conn.
- Ⓞ Wheeler Insulated Wire Co., Inc., 150 E. Aurora St., Waterbury 91, Conn.

WIRE—Molybdenum

- Ⓞ Eastern Smelting & Refining Corp., 107-109 W. Brookline St., Boston 18, Mass.
- Ⓞ Fansteel Metallurgical Corp., 2200 Sheridan Rd., North Chicago, Ill.
- Ⓞ Murex, Ltd., Rainham, Essex, England.
- Ⓞ North American Philips Co., Inc., 100 E. 42nd St., New York 17, N. Y.
- Ⓞ SYLVANIA ELECTRIC PRODUCTS, INC., 1740 Broadway, New York 19, N. Y. ADV. PG. 432-436.
- Ⓞ WESTINGHOUSE ELECTRIC CORP., 511 Wood St., P. O. Box 868, Pittsburgh 30, Pa. ADV. PG. 107-113.

WIRE—Nickel Clad Copper

- Ⓞ Alloy Metal Wire Co., 13th & Penna. Ave., Prospect Park, Pa.
- Ⓞ Eastern Smelting & Refining Corp., 107-109 W. Brookline St., Boston 18, Mass.

- Ⓞ HUDSON WIRE CO., Ossining, N. Y. ADV. PG. 106.
- Ⓞ IMPROVED SEAMLESS WIRE CO., 775 Eddy St., Providence, R. I. ADV. PG. 314.
- Ⓞ Little Falls Alloys, Inc., 190 Caldwell Ave., Paterson 1, N. J.
- Ⓞ Standard Metals Corp., 262 Broad St., North Attleboro, Mass.
- Ⓞ Surprenant Mfg. Co., 199 Washington St., Boston 8, Mass.
- Ⓞ SYLVANIA ELECTRIC PRODUCTS, INC., 1740 Broadway, New York 19, N. Y. ADV. PG. 432-436.
- Ⓞ WESTINGHOUSE ELECTRIC CORP., 511 Wood St., P. O. Box 868, Pittsburgh 30, Pa. ADV. PG. 107-113.
- Ⓞ Wilson Co., H. A., The, 105 Chestnut St., Newark 5, N. J.

WIRE—Phosphor Bronze

- Ⓞ Alpha Wire Corp., 430 Broadway, New York, N. Y.
- Ⓞ AMERICAN BRASS CO., 25 Broadway, New York 4, N. Y. ADV. PG. 330.
- Ⓞ Anaconda Wire & Cable Co., 25 Broadway, New York 4, N. Y.
- Ⓞ Birnbach Radio Co., Inc., 145 Hudson St., New York, N. Y.
- Ⓞ Chase Brass and Copper Co., Inc., 236 Grand St., Waterbury 20, Conn.
- Ⓞ Consolidated Wire & Associated Companies, 1635 S. Clinton St., Chicago 16, Ill.
- Ⓞ General Cement Mfg. Co., 919 Taylor Ave., Rockford, Ill.
- Ⓞ HUDSON WIRE CO., Ossining, N. Y. ADV. PG. 106.
- Ⓞ Little Falls Alloys, Inc., 190 Caldwell Ave., Paterson 1, N. J.
- Ⓞ Phosphor Bronze Corp., 20 Franklin St., Seymour, Conn.
- Ⓞ Riverside Metal Co., Riverside, N. J.
- Ⓞ Roebbling's Sons Co., John A., 640 Broad St., Trenton 2, N. J.
- Ⓞ Scovill Mfg. Co., Industrial Fastener Div., Waterbury, Conn.
- Ⓞ Sun Copper & Wire Co., 132 Beckwith Ave., Paterson, N. J.
- Ⓞ Surprenant Mfg. Co., 199 Washington St., Boston 10, Mass.
- Ⓞ SYLVANIA ELECTRIC PRODUCTS, INC., 1740 Broadway, New York 19, N. Y. ADV. PG. 432-436.

WIRE—Plastic Insulated

- Ⓞ Advance Insulated Wire & Cable Co., 115 Spring St., Morristown, N. J.
- Ⓞ Alpha Wire Corp., 430 Broadway, New York, N. Y.
- Ⓞ American Electric Cable Co., 181 Appleton St., Holyoke, Mass.
- Ⓞ American Steel & Wire Co., Rockefeller Bldg., Cleveland 13, Ohio.
- Ⓞ Anaconda Wire & Cable Co., 25 Broadway, New York 4, N. Y.
- Ⓞ ANSONIA ELECTRICAL CO., 63 Main St., Ansonia, Conn. ADV. PG. 124.
- Ⓞ Belden Mfg. Co., 4647 W. Van Buren St., Chicago 44, Ill.
- Ⓞ Birnbach Radio Co., Inc., 145 Hudson St., New York, N. Y.
- Ⓞ Boston Insulated Wire & Cable Co., 63 Bay St., Boston 25, Mass.
- Ⓞ BRAND & CO., INC., WM., North & Valley Sts., Williamantic, Conn. ADV. PG. 248, 249.
- Ⓞ CHESTER CABLE CORP., Hill St., Chester, N. Y. ADV. PG. 207.
- Ⓞ Collyer Insulated Wire Co., 249 Roosevelt Ave., Pawtucket, R. I.
- Ⓞ COLUMBIA WIRE & SUPPLY CO., 2850 Irving Park Rd., Chicago 18, Ill. ADV. PG. 396.
- Ⓞ Consolidated Wire & Associated Companies, 1635 S. Clinton St., Chicago 16, Ill.
- Ⓞ Dielectric Materials Co., 5315-17 N. Ravenswood Ave., Chicago 40, Ill.
- Ⓞ Electro-Wire Service, 5 Beekman St., New York 7, N. Y.
- Ⓞ Essex Wire Corp., 1601 Wall St., Fort Wayne 6, Ind.
- Ⓞ FEDERAL TELEPHONE AND RADIO CORP., 88 Kingsland Rd., Clifton, N. J. ADV. PG. 161-163.
- Ⓞ Flader, Inc., Frederic, 1330 Laskey Rd., Toledo 12, Ohio.
- Ⓞ General Insulated Wire Works, Inc., 69 Gordon Ave., Providence 5, R. I.
- Ⓞ Gering Products, Inc., N. 7th St. at Monroe Ave., Kenilworth, N. J.
- Ⓞ Hazard Insulated Wire Works Div., The, Okonite Co., Wilkes-Barre, Pa.
- Ⓞ HUDSON WIRE CO., Ossining, N. Y. ADV. PG. 106.
- Ⓞ LENZ ELECTRIC MFG. CO., 1751 North Western Ave., Chicago 47, Ill. ADV. PG. 236.
- Ⓞ Okonite Co., Canal St., Passaic, N. J.
- Ⓞ PHALO PLASTICS CORP., 25 Foster St., Worcester 8, Mass. ADV. PG. 282.
- Ⓞ Phelps Dodge Copper Products Corp., 40 Wall St., New York 5, N. Y.
- Ⓞ Philadelphia Insulated Wire Co., 220 N. 3rd St., Philadelphia, Pa.
- Ⓞ Plastic Wire & Cable Corp., Jewett City, Conn.
- Ⓞ PLASTOID CORP., 10 Mill Rd., Hamburg, N. J. ADV. PG. 117.

- Ⓞ Rhode Island Insulated Wire Co., Inc., 50 Burnham Ave., Cranston, R. I.
- Ⓞ Rockbestos Products Corp., 285 Nicoll St., New Haven 4, Conn.
- Ⓞ Roebbling's Sons Co., John A., 640 Broad St., Trenton 2, N. J.
- Ⓞ ROME CABLE CORP., 330 Ridge St., Rome, N. Y. ADV. PG. 215.
- Ⓞ Simplex Wire & Cable Co., 79 Sidney St., Cambridge 39, Mass.
- Ⓞ STERLING CABLE CO., 350 Fifth Ave., New York 1, N. Y. ADV. PG. 412.
- Ⓞ Surprenant Mfg. Co., 199 Washington St., Boston 10, Mass.
- Ⓞ Television Specialty Co., Haverstraw, N. Y.
- Ⓞ TENSOLITE INSULATED WIRE CO., 198 Main St., Tarrytown, N. Y. ADV. PG. 316.
- Ⓞ Transradio, Ltd., 138 A Cromwell Rd., London S.W. 7, England.
- Ⓞ Whitaker Cable Corp., Kansas City 16, Mo.
- Ⓞ Whitney Blake Co., Box K, New Haven 14, Conn.

WIRE—Platinum

- Ⓞ AMERICAN PLATINUM WORKS, N. J. R. R. Ave. at Oliver St., Newark 5, N. J. ADV. PG. 76.
- Ⓞ Baker & Co., Inc., 113 Astor St., Newark 5, N. J.
- Ⓞ Bishop & Co., J., Platinum Works, Malvern, Pa.
- Ⓞ BRAININ CO., C. S., 320 Washington St., Mount Vernon, N. Y. ADV. PG. 142.
- Ⓞ COHN CORP., SIGMUND, 44 Gold St., New York 7, N. Y. ADV. PG. 278.
- Ⓞ Eastern Smelting & Refining Corp., 107-109 W. Brookline St., Boston 18, Mass.
- Ⓞ GENERAL PLATE DIVISION, Metals & Controls Corp., Attleboro, Mass. ADV. PG. 300.
- Ⓞ Goldsmith Bros. Smelting & Refining Co., 111 N. Wash Ave., Chicago 2, Ill.
- Ⓞ Gordon Co., Claud S., 3000 S. Wallace St., Chicago 16, Ill.
- Ⓞ Mallory & Co., P. R., 3029 E. Washington St., Indianapolis 6, Ind.
- Ⓞ NEY CO., J. M., 179 Elm St., Hartford, Conn. ADV. PG. 246.
- Ⓞ SAMUEL & CO., INC., J. A., 220 Broadway, New York 7, N. Y. ADV. PG. 413.
- Ⓞ Secon Metals Corp., 228 E. 45th St., New York 17, N. Y.
- Ⓞ Sun Copper & Wire Co., 132 Beckwith Ave., Paterson, N. J.
- Ⓞ Surprenant Mfg. Co., 199 Washington St., Boston 8, Mass.
- Ⓞ Western Gold & Platinum Works, 589 Bryant St., San Francisco, Calif.
- Ⓞ Wildberg Bros., Smelting & Refining Co., 742 Market St., San Francisco 2, Calif.
- Ⓞ Wilson Co., H. A., The, 105 Chestnut St., Newark 5, N. J.

WIRE—Resistance and Filament

- Ⓞ Alloy Metal Wire Co., 13th & Penna. Ave., Prospect Park, Pa.
- Ⓞ COHN CORP., SIGMUND, 44 Gold St., New York 7, N. Y. ADV. PG. 278.
- Ⓞ COLUMBIA WIRE & SUPPLY CO., 2850 Irving Park Rd., Chicago 18, Ill. ADV. PG. 396.
- Ⓞ Consolidated Wire & Associated Companies, 1635 S. Clinton St., Chicago 16, Ill.
- Ⓞ DRIVER CO., WILBUR B., 150 Riverside Ave., Newark 4, N. J. ADV. PG. 189.
- Ⓞ DRIVER-HARRIS CO., 201 Middlesex St., Harrison, N. J. ADV. PG. 131.
- Ⓞ Goldmark Wire Co., James, 75 Murray St., New York 7, N. Y.
- Ⓞ JFD MFG. CO., 6101-23 Sixteenth Ave., Brooklyn, N. Y. ADV. PG. 407.
- Ⓞ JELLIFF MFG. CORP., C. O., 200 Pequot Ave., Southport, Conn. ADV. PG. 405.
- Ⓞ NEY CO., J. M., 179 Elm St., Hartford, Conn. ADV. PG. 246.
- Ⓞ SYLVANIA ELECTRIC PRODUCTS, INC., 1740 Broadway, New York 19, N. Y. ADV. PG. 432-436.

WIRE—Shielded

- Ⓞ ALDEN PRODUCTS CO., 117 N. Main St., Brockton 64, Mass. ADV. PG. 327.
- Ⓞ Alpha Wire Corp., 430 Broadway, New York, N. Y.
- Ⓞ American Electric Cable Co., 181 Appleton St., Holyoke, Mass.
- Ⓞ American Steel & Wire Co., Rockefeller Bldg., Cleveland 13, Ohio.
- Ⓞ Anaconda Wire & Cable Co., 25 Broadway, New York 4, N. Y.
- Ⓞ ANSONIA ELECTRICAL CO., 63 Main St., Ansonia, Conn. ADV. PG. 124.
- Ⓞ Belden Mfg. Co., 4647 W. Van Buren St., Chicago 44, Ill.
- Ⓞ Birnbach Radio Co., Inc., 145 Hudson St., New York, N. Y.
- Ⓞ Bishop & Co., J., Platinum Works, Malvern, Pa.
- Ⓞ Boston Insulated Wire & Cable Co., 63 Bay St., Boston 25, Mass.
- Ⓞ BRAND & CO., INC., WM., North & Valley Sts., Williamantic, Conn. ADV. PG. 248, 249.

- Ⓞ Chase Brass & Copper Co., Inc., 236 Grand St., Waterbury 20, Conn.
- Ⓞ CHESTER CABLE CORP., Hill St., Chester, N. Y. ADV. PG. 207.
- Ⓞ Collyer Insulated Wire Co., 249 Roosevelt Ave., Pawtucket, R. I.
- Ⓞ COLUMBIA WIRE & SUPPLY CO., 2850 Irving Park Rd., Chicago 18, Ill. ADV. PG. 396.
- Ⓞ Consolidated Wire & Associated Companies, 1635 S. Clinton St., Chicago 16, Ill.
- Ⓞ Dielectric Materials Co., 5315-17 N. Ravenswood Ave., Chicago 40, Ill.
- Ⓞ Essex Wire Corp., 1601 Wall St., Fort Wayne 6, Ind.
- Ⓞ FEDERAL TELEPHONE AND RADIO CORP., 88 Kingsland Rd., Clifton, N. J. ADV. PG. 161-163.
- Ⓞ General Insulated Wire Works, Inc., 69 Gordon Ave., Providence 5, R. I.
- Ⓞ Hallett Mfg. Co., 1601 Florence Ave., Inglewood, Calif.
- Ⓞ Hazard Insulated Wire Works Div., The Okonite Co., Wilkes-Barre, Pa.
- Ⓞ LENZ ELECTRIC MFG. CO., 1751 North Western Ave., Chicago 47, Ill. ADV. PG. 236.
- Ⓞ Okonite Co., Canal St., Passaic, N. J.
- Ⓞ PHALO PLASTICS CORP., 25 Foster St., Worcester 8, Mass. ADV. PG. 282.
- Ⓞ Phelps Dodge Copper Products Corp., 40 Wall St., New York 5, N. Y.
- Philadelphia Insulated Wire Co., 220 N. 3rd St., Philadelphia, Pa.
- Ⓞ Plastic Wire & Cable Corp., Jewett City, Conn.
- Ⓞ PLASTOID CORP., 10 Mill Rd., Hamburg, N. J. ADV. PG. 117.
- Ⓞ Precision Tube Co., Inc., 3828 Terrace St., Philadelphia 28, Pa.
- Ⓞ ROME CABLE CORP., 330 Ridge St., Rome, N. Y. ADV. PG. 215.
- Ⓞ Runzel Cord & Wire Co., 4723-31 W. Montrose Ave., Chicago 41, Ill.
- Ⓞ Simplex Wire & Cable Co., 79 Sidney St., Cambridge 39, Mass.
- Ⓞ STERLING CABLE CO., 350 Fifth Ave., New York 1, N. Y. ADV. PG. 412.
- Ⓞ Surprenant Mfg. Co., 199 Washington St., Boston 10, Mass.
- Ⓞ Television Specialty Co., Haverstraw, N. Y.
- Ⓞ TENSOLITE INSULATED WIRE CO., 198 Main St., Tarrytown, N. Y. ADV. PG. 316.
- Ⓞ Transradio, Ltd., 138 A Cromwell Rd., London S. W. 7, England.
- Ⓞ Uniform Tubes, Shurs Lane and Laruiston St., Roxborough, Philadelphia, Pa.
- Ⓞ Western Insulated Wire Co., 2421 E. 30th St., Los Angeles, Calif.
- Ⓞ Whitney Blake Co., Box K, New Haven 14, Conn.

WIRE—Silver Plated

- Ⓞ CHESTER CABLE CORP., Hill St., Chester, N. Y. ADV. PG. 207.
- Ⓞ COHN CORP., SIGMUND, 44 Gold St., New York 7, N. Y. ADV. PG. 278.
- Ⓞ Eastern Smelting & Refining Corp., 107-109 W. Brookline St., Boston 18, Mass.
- Ⓞ HUDSON WIRE CO., Ossining, N. Y. ADV. PG. 106.
- Ⓞ IMPROVED SEAMLESS WIRE CO., 775 Eddy St., Providence, R. I. ADV. PG. 314.
- Ⓞ LENZ ELECTRIC MFG. CO., 1751 N. Western Ave., Chicago 47, Ill., ADV. PG. 236.
- Ⓞ Little Falls Alloys, Inc., 190 Caldwell Ave., Paterson 1, N. J.
- Ⓞ Plastic Wire & Cable Corp., Jewett City, Conn.
- Ⓞ Secon Metals Corp., 228 E. 45th St., New York 17, N. Y.
- Ⓞ Standard Metals Corp., 262 Broad St., North Attleboro, Mass.
- Ⓞ Surprenant Mfg. Co., 199 Washington St., Boston 10, Mass.
- Ⓞ SYLVANIA ELECTRIC PRODUCTS, INC., 1740 Broadway, New York 19, N. Y. ADV. PG. 432-436.
- Ⓞ Wilson Co., H. A., The, 105 Chestnut St., Newark 5, N. J.

WIRE—Stainless Steel

- Ⓞ Alloy Metal Wire Co., 13th and Penna. Ave., Prospect Park, Pa.
- Ⓞ American Steel & Wire Co., Rockefeller Bldg., Cleveland 13, Ohio.
- Ⓞ Armco Steel Corp., 703 Curtis St., Middletown, Ohio.
- Ⓞ Carpenter Steel Co., The, 142 West Bern St., Reading, Pa.
- Ⓞ DRIVER CO., WILBUR B., 150 Riverside Ave., Newark, N. J. ADV. PG. 189.
- Ⓞ DRIVER-HARRIS CO., 201 Middlesex St., Harrison, N. J. ADV. PG. 131.
- Ⓞ Fidelitone, Inc., 1616 Devon Ave., Chicago 26, Ill.
- Ⓞ HUDSON WIRE CO., Ossining, N. Y. ADV. PG. 106.
- Ⓞ Indiana Steel & Wire Co., 700 Council St., Muncie, Ind.
- Ⓞ Little Falls Alloys, Inc., 190 Caldwell Ave., Paterson 1, N. J.
- Ⓞ Republic Steel Corp., Republic Building, Cleveland 1, Ohio.
- Ⓞ Sun Copper & Wire Co., 132 Beckwith Ave., Paterson, N. J.
- Ⓞ Surprenant Mfg. Co., 199 Washington St., Boston 8, Mass.
- Ⓞ SYLVANIA ELECTRIC PRODUCTS, INC., 1740 Broadway, New York 19, N. Y. ADV. PG. 432-436.

WIRE—Tungsten

- Ⓞ Eastern Smelting & Refining Corp., 107-109 W. Brookline St., Boston 18, Mass.
- Ⓞ Fansteel Metallurgical Corp., 2200 Sheridan Rd., North Chicago, Ill.
- Ⓞ Murex Ltd., Rainham, Essex, England.
- Ⓞ North American Philips Co., 100 E. 42nd St., New York 17, N. Y.
- Ⓞ SYLVANIA ELECTRIC PRODUCTS, INC., 1740 Broadway, New York 19, N. Y. ADV. PG. 432-436.
- Ⓞ WESTINGHOUSE ELECTRIC CORP., 511 Wood St., P. O. Box 868, Pittsburgh 30, Pa. ADV. PG. 107-113.

WIRE RECORDER ASSEMBLIES

- Ⓞ BRUSH DEVELOPMENT CO., 3405 Perkins Ave., Cleveland 14, Ohio. ADV. PG. 228, 229.
- Ⓞ Crescent Industries, Inc., 4140 Belmont Ave., Chicago 41, Ill.
- Ⓞ LENZ ELECTRIC MFG. CO., 1751 N. Western Ave., Chicago 47, Ill. ADV. PG. 236.
- Ⓞ Peirce Wire Recorder Corp., 1328 Sherman Ave., Evanston, Ill.

WIRE STRIPPERS

See Machines, Wire Stripping

WOOFERS

See Loudspeakers

X-RAY EQUIPMENT—Industrial

- Ⓞ Bar-Ray Products, Inc., 209 25th St., Brooklyn 32, N. Y.
- Ⓞ BRACKE-SEIB X-RAY CO., INC., 293 Third Ave., New York, N. Y. ADV. PG. 390.
- Ⓞ General Electric X-Ray Corp., 4855 Electric Ave., Milwaukee, Wis.
- Ⓞ High Voltage Engineering Corp., 7 University Rd., Cambridge 38, Mass.
- Ⓞ Jarrell-Ash Co., 165 Newberry St., Boston 16, Mass.
- Ⓞ North American Philips Co., Inc., 100 E. 42nd St., New York 17, N. Y.
- Ⓞ Picker X-Ray Corp., 300 Fourth Ave., New York 10, N. Y.
- Ⓞ St. John X-Ray Laboratory, Califon, N. J.
- Ⓞ Standard Electronics Research Corp., 2 East End Ave., New York 21, N. Y.

- Ⓞ Triplett & Barton, Inc., 831 N. Lake St., Burbank, Calif.
- Ⓞ WESTINGHOUSE ELECTRIC CORP., 511 Wood St., P. O. Box 868, Pittsburgh 30, Pa. ADV. PG. 107-113.

X-RAY EQUIPMENT—Medical

- Ⓞ Baird Associates, 33 University Rd., Cambridge 35, Mass.
- Ⓞ Bar-Ray Products, Inc., 209 25th St., Brooklyn 32, N. Y.
- Ⓞ BRACKE-SEIB X-RAY CO., INC., 293 Third Ave., New York, N. Y. ADV. PG. 390.
- Ⓞ FAIRCHILD CAMERA & INSTRUMENT CORP., 88-06 Van Wyck Blvd., Jamaica 1, N. Y. ADV. PG. 244, 245.
- Ⓞ General Electric X-Ray Corp., 4855 Electric Ave., Milwaukee, Wis.
- Ⓞ High Voltage Engineering Corp., 7 University Rd., Cambridge 38, Mass.
- Ⓞ North American Philips Co., Inc., 100 E. 42nd St., New York 17, N. Y.
- Ⓞ Nuclear Instrument & Chemical Corp., 223 W. Erie St., Chicago 10, Ill.
- Ⓞ Picker X-Ray Corp., 300 Fourth Ave., New York 10, N. Y.
- Ⓞ WESTINGHOUSE ELECTRIC CORP., 511 Wood St., P. O. Box 868, Pittsburgh 30, Pa. ADV. PG. 107-113.

YOKES, DEFLECTION

- Ⓞ Alpha Electronics, Inc., 53-57 Bergen Turnpike, Little Ferry, N. J.
- Ⓞ BARKER & WILLIAMSON, 235 Fairfield Ave., Upper Darby, Pa. ADV. PG. 292.
- Ⓞ Cortland Industries, Inc., 4545 Cortland St., Chicago 39, Ill.
- Ⓞ Cossor (Canada), Ltd., 301-303 Windsor St., Halifax, N. S., Canada.
- Ⓞ DX Radio Products Co., Inc., 2305 Armitage Ave., Chicago 47, Ill.
- Ⓞ Davis Electric Co., Cape Girardeau, Mo.
- Ⓞ DuMont Laboratories, Inc., Allen B., Electronics Parts Div., 35 Market St., East Paterson, N. J.
- Ⓞ Electro Engineering & Mfg. Co., 627 W. Alexandrine Ave., Detroit 1, Mich.
- Ⓞ Ford Instrument Co., Inc., 31-10 Thomson Ave., Long Island City, N. Y.
- Ⓞ GUARDIAN ELECTRIC MFG. CO., 1621 W Walnut St., Chicago 12, Ill. ADV. PG. 147.
- Ⓞ Guthman Inc., Edwin I., 15 S. Throop St., Chicago, Ill.
- Ⓞ I-T-E Circuit Breaker Co., 19th & Hamilton Sts., Philadelphia 30, Pa.
- Ⓞ Merit Transformer Corp., 4427 N. Clark St., Chicago 40, Ill.
- Ⓞ Monroe Coil Co., 2839 N. Narragansett Ave., Chicago 34, Ill.
- Ⓞ Philco Corp., Tioga & C Sts., Philadelphia 34, Pa.
- Ⓞ RADIO CORP. OF AMERICA, Tube Dept., Harrison, N. J. ADV. PG. 177, Inside Back and Back Covers.
- Ⓞ Rola Co., Inc., The, 2530 Superior Ave., Cleveland 14, Ohio.
- Ⓞ Ross Mfg. Co., 860 Washington St., Burlington, Iowa.
- Ⓞ Sickles Co., F. W. 165 Front St., Chicopee, Mass.
- Ⓞ STANDARD TRANSFORMER CORP., Elston, Kedzie & Addison, Chicago 18, Ill. ADV. PG. 144.
- Ⓞ Teletran Corp., Ramsey N. Y.
- Ⓞ Teletron Co., The, 4019 Prospect Ave., Cleveland 3, Ohio.
- Ⓞ Teleradio Engineering Corp., 99 Wall St., New York, N. Y.
- Ⓞ TEL-RAD MFG. CO., INC., 7th & Madison St., Fennimore, Wis. ADV. PG. 412.
- Ⓞ Television Laboratories, Inc., 5045 W. Lake St., Chicago 44, Ill.
- Ⓞ Todd-Tran Corp., 156 Gramatan Ave., Mt. Vernon, N. Y.
- Ⓞ U. S. ELECTRONICS CORP., 276 Warren St., Lyndhurst, N. J. ADV. PG. 76.

TRADE NAME INDEX

The following list, provided by manufacturers, comprises the registered trade names of products in or related to the electronic field. It is intended for use in determining the manufacturer's name when only a trade name is known. Addresses can be obtained by referring to the Manufacturers Index on Page D-153. Only coined trade names are listed, as it was deemed unnecessary to include a company name, even though it was a registered trade name, inasmuch as the manufacturer's identity was immediately apparent.

- A-10
Surprenant Mfg. Co.
- "A" NICKEL
International Nickel Co., Inc.
- A BAR E
Amalgamated Electronics
- ABRASO
Roebbling's Sons Co., John A.
- ACA
Amplifier Corp. of America
- ACE
American Hard Rubber Co.
- ACE
Arro Expansion Bolt Co.
- ACE
Crosley Corp.
- ACME-MOLD
Acme Wire Co.
- ACOUSTICEL
Brush Development Co.
- ACRAWAX C
Glyco Products Co., Inc.
- ACROCEL
Acromark Co.
- ACROCUT
Acromark Co.
- ACROD
Acme Electric Heating Co.
- ACRO-ETCH
Acromark Co.
- ACROFLEX
Anchor Plastics Co., Inc.
- ACROGRAVE
Acromark Co.
- ACROHEX
Acromark Co.
- ACRO-INK
Acromark Co.
- ACROM
Acme Electric Heating Co.
- ACROMARKER
Acromark Co.
- ACRO PLAC
Acromark Co.
- ACROPRINTER
Acromark Co.
- ACROSNAPE
Acro Electric Co.
- ACROSOUND
Acro Products Co.
- ACROTOL
Acromark Co.
- ACROVISION
Acro Products Co.
- ACRYLOID
Rohm & Haas Co.
- ACRYWELD
American Phenolic Corp.
- ACTRON
Radionic Transformer Co.
- ADAPTORS
ABC Radio Labs.
- ADASHAFT
Centralab Div. of Globe-Union, Inc.
- ADC
Audio Development Co.
- ADJUSTOHM
Ward Leonard Electric Co.
- ADJUST-A-CONE
Quam Nichols Co.
- ADJUST-A-VOLT
Standard Electrical Products Co.
- ADLAKE
Adams & Westlake Co.
- AEC
American Electroneering Co.
- ADVANCE
Driver-Harris Co.
- AECO
American Elec. Cable Co.
- AERIOTRON
Westinghouse Electric Corp.
- AERO
Sheffield Instrument Corp.
- AEROCOM
Aeronautical Communications Equipment Co.
- AEROCON
Aerovox Corp.
- AERO-GUN
Shallcross Mfg. Co.
- AEROFLEX
Anchor Plastics Co., Inc.
- AEROLENE
Aerovox Corp.
- AEROLITE
Aerovox Corp.
- AERO-MAGNETTE
Heinemann Electric Co.
- "AERONAUT" PRODUCTS
Aeronautical Radio Mfg. Co.
- AERPOPOINT
Aero Needle Co.
- AERO SEAL
Breeze Corpn., Inc.
- AERO-THREAD
Heli-Coil Corp.
- AEROTROL
Cook Electric Co.
- AEROTRON
Aeronautical Electronics, Inc.
- AGA
American Gas Accumulator Co.
- AGASTAT
American Gas Accumulator Co.
- AGWADAG
Acheson Colloids Corp.
- AH
Arrow-Hart & Hegeman Electric Co.
- AICO
American Insulator Corp.
- AIR O FRESH
Melco Products, Inc.
- AIRACOUSTIC
Johns-Manville Sales Corp.
- AIRBOY
Mitchell Industries, Inc.
- AIR-COM
Aeromotive Equipment Corp.
- AIRCORE
Communication Products Co., Inc.
- AIRDESIGN
TeleVideo Corp.
- AIRFLEX
Transradio Ltd.
- AIR-FONE
Electronic Specialty Co.
- AIR INDUCTORS
Barker & Williamson
- AIRLOOP
Franklin Mfg. Corp., A. W.
- AIR-METER
Hastings Instrument Co., Inc.
- AIR-O-LINE
Brown Instrument Co.
- AIR-RAY
Edin Co.
- AIRSCOOT
Mitchell Industries, Inc.
- AIRSTAT
Minneapolis-Honeywell Regulator Co.
- AIRSWITCH
Minneapolis-Honeywell Regulator Co.
- AJAX-NORTHRUP
Ajax Electrothermic Corp.
- AJUST-A-VOLT
Standard Electrical Products Co.
- AKRA-OHM
Shallcross Mfg. Co.
- ALABAX
Pass & Seymour, Inc.
- ALCOA
Aluminum Company of America
- ALCROHM
Magnetic Metals Co.
- ALCUPLATE
General Plate Division, Metals & Control Corp.
- ALFERON
Driver-Harris Co.
- ALGCO
Auburn Manufacturing Co.
- ALL-HYDRAULIC
Hydraulic Press Mfg. Co.
- ALMET
Alloy Metal Wire Co.
- ALNICO
Arnold Engineering Co.
- ALNICO
Crucible Steel Co. of America
- ALNOR
Illinois Testing Labs., Inc.
- ALODINE
American Chemical Paint Co.
- ALPHATRON
Alpha Laboratories
- ALPHATRON
Canadian Radium & Uranium Corp.
- ALPHATRON
National Research Corp.
- ALPO
Standard Varnish Works.
- ALRAY
Alloy Metal Wire Co.
- ALROK
Aluminum Co. of America
- ALSCO
Automatic Switch Co.
- ALSIMAG
American Lava Corp.
- ALSIPATE
General Plate Division, Metals & Controls Corp.
- ALUMATREET
Farrelloy Co.
- ALUMAWELD
Johnson Mfg. Co., Inc.
- ALUMILITE
Aluminum Co. of America
- ALUNDUM
Norton Co.
- ALZAK
Aluminum Co. of America
- AMINCO
American Instrument Co.
- ALUMINUM OILITE
Amplex Div.
Chrysler Corp.
- ALUNDUM
Norton Co.
- AMBERLITE
Rohm & Haas Co.
- AMBEROL
Rohm & Haas Co.
- AMBERYL
Vaco Products Co.
- AMCO
American Solder & Flux Co.
- AMCON
American Condenser Co.
- AMECO
American Electronics Corp.
- AMERBESTOS
American Steel & Wire Co.,
U. S. Steel Corp., Sub.
- AMERCLAD
American Steel & Wire Co.,
U. S. Steel Corp., Sub.
- AMERFLEX
Marco Industries.
- AMERGLASS
American Steel & Wire Co.,
U. S. Steel Corp., Sub.
- AMERICAN
Manning, Maxwell & Moore, Inc.
- AMERICAN BEAUTY
American Electrical Heater Co.
- AMERICAN ELECTRIC
The Kelley-Koett Mfg. Co., Inc.
- AMERICAN-PHILLIPS
American Screw Co.
- AMERINE
American Insulator Corp.
- AMERLAC
American Electric Cable Co.
- AMERPLASTIC
American Electric Cable Co.
- AMERSTRAND
American Steel & Wire Co.,
U. S. Steel Corp., Sub.
- AMERTRAN
American Transformer Co.
- AMINCO
American Instrument Co.
- AMMOGAS
Westinghouse Electric Corp.
- AMO
General Cement Mfg. Co.
- AMOI
Distillation Products Industries Div. of
Eastman Kodak Co.
- AMPCO
Automatic Metal Products Co.
- AMPEC
Centralab Div.
Globe Union, Inc.
- AMPEX
Automatic Metal Products Co.
- AMPHENOL
American Phenolic Corporation.
- AMPLICALL
Rauland-Borg Corp.
- AMPLICORP
Amplifier Corp. of America.
- AMPLIMUSE
Crystal Research Labs., Inc.
- AMPLI-PRESS
Aircraft-Marine Products, Inc.
- AMPLISET
Bristol Co., The.
- AMPLUG
Electrodyne Co.
- AMP-O-MATIC
Aircraft-Marine Products, Inc.
- AMPROBE
Pyramid Instrument Corp.
- AMPTRON
Friez Instrument Div.
Bendix Aviation Corp.
- AMPYROL
American Steel & Wire Co.,
U. S. Steel Corp., Sub.

AMRAD
Crosley Corp.

AMRECON
American Relay & Controls, Inc.

AMVAR
American Steel & Wire Co.,
U. S. Steel Corp., Sub.

ANACONDA
American Brass Co.

ANADEL
Joseph Dixon Crucible Co.

AN-COR-LOX
Laminated Shim Co., Inc.

ANGLE-DRIVE
James Vibrapowr Co.

ANKOSEAL
Ansonia Electrical Co.

ANTELCO
Automatic Electric Co.

ANTEN-A-CATOR
Gordon Specialties Co.

ANTENNAPLEX
Radio Corp. of America.

ANTILINK
American Nut & Bolt Fastener Co.

ANYVOLT
Sorensen & Co.

APECO
American Photocopy Equipment Co

APELCO
Applied Electronics Co.

API
Assembly Products, Inc.

APW
American Platinum Works.

AQUADAG
Acheson Colloids Corps.

AQUALITE
National Vulcanized Fibre Co.

AQUALUX
Westinghouse Electric Corp.

AQUA-NIL
Standard Electrical Products Co.

AQUAPLATE
Bache & Co., Semon.

AQUATROL
Minneapolis-Honeywell Regulator Co.

AQUIFLUX
Special Chemicals Co.

ARALDITE
Ciba Company, Inc.

ARCOZON
Arco Co.

ARC-RITE
Mellaphone Corp.

ARCTURUS
Standard Arcturus Corp.

ARGOFLEX
Argus, Inc.

ARISTA
Coronet Radio & Television Corp.

ARKLESS
Economy Fuse & Mfg. Co.

A R L
Antenna Research Laboratory, Inc.

ARL
Applied Research Labs.

ARLAB
Radionic Transformer Co.

ARLAVOX
Radionic Transformer Co.

ARMATITE
Mica Insulator Co.

ARMITE
Spaulding Fibre Co., Inc.

ARRESTONE
Armstrong Cork Co.

ARVIN
Noblitt Sparks Industries

ARTIC-GLO
Canadian Radium & Uranium Corp.

ASBESTOSPAK
Felt Products Mfg. Co.

ASCO
Automatic Switch Co.

ASCOP
Applied Science Corp. of Princeton.

ASHCROFT
Manning, Maxwell & Moore, Inc.

ASTRA-SONIC
The Pentron Corp.

ATC
Automatic Temperature Control Co., Inc.

ATOM
Sprague Electric Co.

ATCOTRAN
Automatic Temperature Control Co., Inc.

ATOMER
Maico Co., Inc.

ATR
American Television & Radio Co.

ATTIC-V-BEAM
Telrex, Inc.

AUBESTON
Auburn Manufacturing Co.

AUC
Rockbestos Products Corp.

AUDAX
Audak Co.

AUDIAD
Magnecord, Inc.

AUDICLE
Sonotone Corp.

AUDIGAGE
Branson Instruments, Inc.

AUDIO-AID
Ansley Mfg. Co., Arthur.

AUDIODISCS
Audio Devices, Inc.

AUDIOFILM
Audio Devices, Inc.

AUDIOID
Cook Laboratories.

AUDIOLOG
Berlant Associates

AUDIO MIX
Pentron Corp., The.

AUDIOSCOPE
Sonotone Corp.

AUDITRON
Sonotone Corp.

AUDIO-LINE
Audio Equipment Sales.

AUDIO RULE
Audio Equipment Sales.

AUDIPOINTS
Audio Devices, Inc.

AUDIOTAPE
Audio Devices, Inc.

AUDITION
Reeves Soundcraft Corp.

AUDOGRAPH
The Gray Mfg. Co.

AURICON
Berndt-Bach, Inc.

AUTOCROMATIC
Acton Co., H. W.

AUTO-DIAL
American Phenolic Corp.

AUTO-DRYARE
Communication Products Co., Inc.

AUTODYNE
Westinghouse Electric Corp.

AUTOMANIC
Premax Products Div. Chisolm-Ryder Co., Inc.

AUTOMATIC TERMINATOR
Aircraft-Marine Products, Inc.

AUTOMIX
Westinghouse Electric Corp.

AUTOPLATER
Tracerlab, Inc.

AUTOSCALER
Tracerlab, Inc.

AUTOSET
Bristol Co., The.

AUTO-SONIC
Vendo Co.

AUTOSYN
Eclipse-Pioneer Div.
Bendix Aviation Corp.

AUTOTROL
Westinghouse Electric Corp.

AUTOTUNE
Collins Radio Co.

AUTOVALVE
Westinghouse Electric Corp.

AUTRASTAT
Ward Leonard Electric Co.

AVIGATOR
Mitchell Industries, Inc.

AVITRON
Avion Instrument Corp.

AWEBCO
Anchor Webbing Co.

AXIFLO
Westinghouse Electric Corp.

B-2
Peck & Harvey.

BCE
Berkeley Custom Electronics

BAACH—INTERNATIONAL
International Machine Works.

BABY-LISTENER
Lyman Electronic Corp.

BADGER
Reliance Automatic Lighting Co

BAKELITE
Union Carbide & Carbon Co.

BALAC
Conant Laboratories.

BALON
Belling & Lee, Ltd.

BALOWSTER
F. G. Back Video Corp.

BANDBOX
Crosley Corp.

BANTAM
Aerovox Corp.

BANTAM GT
Hytron Radio & Electronics Corp.

BANTAM JR
Hytron Radio & Electronics Corp.

BARANM
Ward Leonard Elec. Co.

BARCOL
Barber Colman Co.

BARCOMBO
Electronic Enterprises, Inc.

BAREX
King Laboratories, Inc.

BAROHM
Ward Leonard Electric Co.

BARREL-LIFT
Falstrom Co.

BARRYMOUNTS
Barry Corp., The.

BASS REFLEX
Jensen Mfg. Co.

BATTERY SCOPE
McColpin-Christie Corp.

BATRYPOWER
Radiart Corp.

BAT'S-EYE RADARECTOR
Kennedy & Co., D. S.

BEAMA JUSTER
Perfection Electric Co.

BEAVER
Cornell-Dubilier Electric Corp.

BECKAMINE
Reichhold Chemicals, Inc.

BECKMAN
National Technical Laboratories.

BECO
Brown Electro-Measurement Corp.

BECO
Westinghouse Electric Corp.

BEE
Buchanan Electrical Products Corp.

BEETLE
American Cynamid Co.

BELCO
Bogue Electric Co.

BELFONE
Bell Sound Systems, Inc.

BELFONE MESTRO
Bell Sound Systems, Inc.

BELLOWS
Boots Aircraft Nut Co.

BELL-TIME
Industrial Timer Corp.

BEN HAR
Bentley-Harris Mfg. Co.

BENELEX
Masonite Corp.

BEPCO
Buchanan Electrical Products Corp.

BERGER
Republic Steel Corp.

BERKELEY DECIMAL
Berkeley Scientific Co.

BERKSHIRE
Radio Corporation of America.

"BEST PRODUCTS"
Cossor (Canada) Ltd.

BESTO-WIRE
Rhode Island Insulated Wire Co.

BETTER LIVING
Sonotone Corp.

BH
Bentley-Harris Mfg. Co.

B.I.W.
Boston Insulated Wire & Cable Co.

BIMORPH
Brush Development Co.

BINAC
Eckert-Mauchly Computer Corp.

BI-PRENE
Bishop Mfg. Corp.

BI-SEAL
Bishop Mfg. Corp.

BI-SILON
Bishop Mfg. Corp.

BL
Browning Laboratories, Inc.

BLACK BEAUTY
Sprague Electric Co.

BLACK DIAMOND
Dunton Co., M. W.

BLACKLINE
Frederick Post Co.

BLINK-R
Airelectron, Inc.

BLUE BEAVER
Condenser Corp. of America.

BLUE STREAK
American Electric Cable Co.

BLUEBIRD
Radio Corporation of America.

BLUE JACKET
Sprague Electric Co.

B. O. ELIMINATOR
Perfection Electric Co.

BOARDMASTER
Universal Drafting Machine Corp.

BONALDY
Bonney Forge & Tool Works.

BOND
Olin Industries, Inc.

BONDEZE
Phelps Dodge Copper Products Co.

BOND-ROD
Sherman Mfg. Co., H. B.

BOVIE
Liebel-Farsheim Co.

BOW XX
Super Flow Solder Co., Inc.

BOXSEAL
Paisley Products Inc.

BRADLEY
De Jur-Amsco Corp.

BRANDES
Cannon Co., C. F.

BRANTRONIC
Branston Electric Mfg. Co., Inc.

BRAZO
Linde Air Products Co.
Unit of Union Carbide & Carbon Corp.

BRENKERT
Radio Corp. of America.

BREWSTER
Maguire Industries.

BRIDGER
Audio Instrument Co.

BRIILLIANTONE
Acton Co., H. W.

BRIMSTO
Electro Chemical Engineering Co.

BRINELCO
Brinell Co., The.

BRISTO
Bristol Co., The.

BROADBAND
Racon Electric Co.

BROADCASTER
Reeves Soundcraft Corp.

BRONCO
General Plate Division
Metals & Controls Corp.

BRONCO
Western Insulated Wire Co.

BRONCO BESTON
Western Insulated Wire Co.

BRONZOCHROME
Eutectic Welding Alloys Co.

BROWN DEVIL
Ohmite Mfg. Co.

BROWN X
Pass & Seymour, Inc.

BRYANT
Westinghouse Electric Corp.

BUDGET
Aircraft Marine Products Inc.

BUG
Vibroplex Co., Inc.

BUILT IN WATCHMAN
Westinghouse Electric Corp.

BULLGOG
Phelps Dodge Copper Products Corp.

BULLS-I-UNITS
Kirkland Co., H. R.

BULPLATE
Herlec Corp.

BULLPLATE
Sprague Electric Co.

BUNDYWELD
Bundy Tubing Co.

BUSHEND
Buchanan Electrical Products Corp.

BUSS
Bussman Mfg. Co.

BUTACITE
E. I. du Pont de Nemours Co., Inc.

BUTTON MICAS
Erie Resistor Corp.

B&W
Barker & Williamson.

BUZZ-TIME
Industrial Timer Corp.

BW COPYFLEX
Bruning Co., Inc., Charles.

C-B
Caddell-Burns Mfg. Co.

C & C
McColpin-Christie Corp.

CMSZ ALLOY
Electro Metallurgical Co.
Unit of Union Carbide & Carbon Corp.

CALI-BRIDGE
Industrial Electronics, Inc.

CALI-POWER
Industrial Electronics, Inc.

CALIVOLTER
Calidyne Co., The.

CALLMASTER
Lyman Electronic Corp.

CALTRON
Caltron Co.

CAMBIRCROID
American Electric Cable Co.

CAMCO
Camburn, Inc.

CANADIAN
Measurement Engineering, Ltd.

CANDOHMS
Muter Co.

CANNON-BALL
Cannon Co., C. F.

CAPACILOG
Wheelco Instruments Co.

CAPACITROL
Wheelco Instruments Co.

CAPEHART
Capehart-Farnsworth Corp.

CAPOHMIST
Special Products Co.

CAPRISTOR
Jeffers Electronics Co.

CARBIC
Linde Air Products Co.
Unit of Union Carbide & Carbon Corp.

CARBOFILM
Wilkor Products, Inc.

CARBOLITE
Linde Air Products Co.
Unit of Union Carbide & Carbon Corp.

CARBOMITE
Continental Carbon, Inc.

CARBONYL
Antara Products Div.,
General Dystuff Corp.

CARBON BRIMSTO
Electro Chemical Engineering Co.

CARDAX
Electro-Voice, Inc.

CARDIETTE
Sanborn Co.

CARDIOFAX
Electrofax Corp.

CARDIOSCRIBE
General Electric X-Ray Corp.

CARDIOTRON
Electro-Physical Laboratories, Inc.

CARDYNE
Electro-Voice, Inc.

CARILLON DYNAMIC
Miller Mfg. Co., M. A.

CAROD
Belling & Lee, Ltd.

CARRON-AIRE
Carron Mfg. Co.

CARTRIJ-DRY
Pyramid Electric Co.

CARTROL
Gasket Engineering Co.

CASCADE
Audio Industries.

CASCADE
Linde Air Products Co.
Unit of Union Carbide & Carbon Corp.

CASCAMITE
The Borden Co.,
Chemical Division.

CASCO
The Borden Co.,
Chemical Division.

CASCOPHEN
The Borden Co.,
Chemical Division.

CASCOREZ
The Borden Co.,
Chemical Division.

CASTORDAG
Acheson Colloids Corp.

CATABOND
Catalin Corp. of America.

CATAPAK
Catalin Corp. of America.

CATAVAR
Catalin Corp. of America.

CATHODE-RAY STETHOSCOPE
Feiler Engineering Co.

CAT'S EYE
Ess Specialty Corp.

CAVALCADE
Molded Insulation Co.
Aircraft Control Div.

CAVITRON
Short Wave Plastic Forming Co.

CCC CHICAGO
Chicago Condenser Corp.

CCO
Bliley Electric Co.

C-D SEAL
Cornell-Dubilier Electric Corp.

CECOR
Commercial Equipment Co., Inc.

CECOTITE
Cook Electric Co.

CELAB
Clark Electronic Labs.

CELASCREEN
Celanese Corp. of America.

CELCON
Celanese Corp. of America.

CELECTRAY
Weston Electrical Instrument Corp.

CELLO-BOND
Paisley Products, Inc.

CELLUFOAM
Masonite Corp.

CELLULOID
Celanese Corp. of America.

CELORON
Continental Diamond Fibre Co.

CELVACENE
Distillation Products Industries.

CENCO
Central Scientific Co.

CENTRALINE
Central Paper Co., Inc.

CENTRICORE ENERGIZED
Alpha Metals, Inc.

CERAMAG
Stackpole Carbon Co.

CERAMICON
Erie Resistor Corp.

CERAMICAPS
Muter Co.

CERA-MITE
Sprague Electric Co.

CEREX
Monsanto Chemical Co.
Plastics Div.

CERISSO
Isolanite Mfg. Corp.

CEROC
Sprague Electric Co.

CERTI-CRIMP
Aircraft-Marine Products, Inc.

CETRON
Continental Electric Co.

CHALLENGER
Rek-O-Kut Co., Inc.

CHAMPION
Crucible Steel Co. of America.

CHAMPION No. 180
Division Lead Co.

CHANALYST
Radio Corporation of America.

CHAN-L-MOUNT
Lord Mfg. Co.

CHARGALYZER
McColpin-Christie Corp.

CHARGICATOR
Hickok Electrical Instrument Co.

CHARG-O-MATIC
Hertner Electric Co.

CHASS-EZ
General Cement Mfg. Co.

CHEMACO
Koppers Co.

CHEMELEC
Teflon Products Division,
U. S. Gasket Co.

CHEMIGLAS
Technicraft Supply Co., Radiocrafters

CHEMIFLEX
Technicraft Supply Co., Radiocrafters.

CHEMIGUM
Goodyear Tire & Rubber Co.

CHERRIO
Crosley Corp.

CHEMLON
Crane Packing Co.

CHEMXORK
Electro Chemical Engineering Co.

CHIME-MATIC
Executone, Inc.

CHINALAK
Dolph Co., John C.

CHROMARFLASH
Triumph Mfg. Co.

CHROMAX
Driver-Harris Co.

CHROMEX
Pass & Seymour, Inc.

CHROMO-FLASH
Photographic Products, Inc.

CHRONOLOG
National Acme Co.

CHRONO-SPRAY
Paragon Electric Co.

CHROMOTRON
Eclipse Pioneer Div.
Bendix Aviation Corp.

CIBANITE
Ciba Company, Inc.

CIMET
Driver-Harris Co.

CINCH
National Lead Co.

CINE BALOWSTAR
Jen Products Co.

CINE-VOICE
Berndt-Bach Inc.

CIRCLATRON
Gadgets, Inc.

CIRCLE B
Bristol Motor Co.

CIRCLE ESS
Stewart Mfg. Corp., F. W.

CIRCLET
Trumbull Electric Mfg. Co.

CIRCUITMASTER
Fordham Mfg. Co.

CIRCUTROL
Kollman Instrument Corp.

"CL"
Alpha Wire Corp.

CLAM PIPE
Mueller Electric Co.

CLASSIC
Jensen Industries, Inc.

CLASSMETER
Nuclear Instrument & Chemical Corp.

CLEARSITE
Economy Fuse & Mfg. Co.

CLEARSONIC
U. S. Television Mfg. Corp.

CLETRON
Cleveland Electronics, Inc.

CLEVELITE
Cleveland Container Co.

CLIMATITE
Triad Transformer Mfg. Co.

CLIP ON
Ferranti Electric, Inc.

CLOVER-V-BEAMS
Telrex, Inc.

CMH
Chicago Metal Hose Corp.

COATINGAGE
Branson Instrument, Inc.

CO-AX
Transradio Ltd.

COAXITUBE
Precision Tube Co., Inc.

COAXWITCH
Bird Electronic Corp.

COBANIC
Driver Co., Wilbur B.

CODUR
Maas & Waldstein Co. *

COHARDITE
Connecticut Hard Rubber Co.

COHRLASTIC
Connecticut Hard Rubber Co.

COINRAD
Northeastern Engineering, Inc.

COLONIAL
Pyramid Products Co.

COLONIAL
Sylvania Electric Products, Inc.

COLORBRITE
Eberhard Faber Pencil Co.

COLOR-EYE
Instrument Development Laboratories, Inc.

COLORTOP
Trico Fuse Mfg. Co.

COMCO
Communications Co., Inc.

COMET
Driver-Harris Co.

COMMANDAIR
JFD Mfg. Co.

COMMULAC
Martindale Electric Co.

COMMUNOPHONES
Bogen Co., David.

COMMUTATOR RESURFACERS
Ideal Industries, Inc.

COMPACTUATOR
Air Associates, Inc.

COMPAR
Goodyear Tire & Rubber Co.

COMPARITOL
 Scherr Co., Inc., George
COMPA-STATION
 Motorola Inc.
COMPO
 Bound Brook Oil-Less Bearing Co.
COMPO
 Muter Co.
COMPREGNITE
 Borden Co., The, Chemical Div.
COMTONE
 Communications Co., Inc.
CONCERT
 Jensen Industries, Inc.
CONCERT GRAND
 Stewart-Warner Corp.
CONCERTONE
 Berlant Associates.
CONDENS-O-WELD
 Westinghouse Electric Corp.
CONDUCTALUTE
 Sauereisen Cements Co.
CON-FEE-PHONE
 Simpson Mfg. Co., Inc., Mark.
CONFESSIONAIRE, THE
 Audio Equipment Co., Inc.
CONFIDENCER
 Avimeter Corp.
CONICAL-V-BEAM
 Telrex Inc.
CONNSONATA
 Conn Ltd., C. G.
CONNSONETTE
 Conn Ltd., C. G.
CONPERNIK
 Westinghouse Electric Corp.
CON-TAC-TOR
 Minneapolis-Honeywell Regulator Co.
CONTRIFLEX
 Eagle Signal Corp.
CONTROLITE
 Ward Leonard Electric Co.
CONVECTRON
 Eclipse Pioneer Div.
 Bendix Aviation Corp.
CONVERS-O-CALL
 National Intercommunicating Systems.
COOKE
 R. Y. Ferner Co.
COOLER-PROOF
 Paisley Products Inc.
COOLIDGE
 General Electric X-Ray Corp.
COPOLENE
 American Phenolic Corp.
COPRENE
 Maas & Waldstein Co.
COPROX
 Bradley Labs., Inc.
CORAL DESIGNS
 Dietz Co., Henry G.
COREPROOF
 Magnetic Metals Co.
COREX
 Standard Varnish Works.
CORKOUSTIC
 Armstrong Cork Co.
CORMER
 Coronet Radio & Television Corp.
CORO-GARD
 Minnesota Mining & Mfg. Co.
CORNELL
 Video Corp. of America.
COROHON
 Wilkor Products, Inc.
CORONETTE
 Belling & Lee, Ltd.
CORONOX
 Westinghouse Electric Corp.
COROX
 Westinghouse Electric Corp.
CORRIB
 Ohmite Mfg. Co.
CORULITE
 Premax Products Div.
 Chisholm-Ryder Co., Inc.
CORWICO
 Cornish Wire Co.
COSMOLITE
 Cleveland Container Co., The.
CO-SPIRAL
 Stephens Mfg. Corp.
COTO
 Coto-Coil Co., Inc.
COTTONITE
 Acme Wire Co.
COUNTOMATIC
 Instrument Development Labs.
COUPLATE
 Centralab Div.
 Globe Union Inc.
COX
 Commercial Research Labs., Inc.
CO-X
 Boston Insulated Wire & Cable Co.
COXPROX
 Bradley Labs.
CRAFTSMEN
 Radio Craftsmen, Inc.
CRAPRO
 Indiana Steel & Wire Co.
CREME-O-WAX
 General Cement Mfg. Co.
CRESCENDON
 Crosley Corp.
CRESTRAN
 Crest Transformer Corp.
CRESTROL
 Crest Transformer Corp.

CRISE
 Acro Mfg. Co.
CROLITE
 Crowley & Co., Inc., Henry L.
CROLOY
 Crowley & Co., Inc., Henry L.
CROMALOY
 Linde Air Products Co.
 Unit of Union Carbide & Carbon Corp.
CROTHANE
 Crowley & Co., Inc., Henry L.
CRUCIBLE WELD
 Westinghouse Electric Corp.
CROWN
 Tele King Corp.
CRYSICON
 Crystal Research Labs., Inc.
CRYSTALAB
 Crystal Research Labs., Inc.
CRYSTALEAR
 Brush Development Co.
CRYSTALIGNED
 Magnetic Metals Co.
CRYSTALINER
 Monitor Products Co.
CRYSTAL-SEAL
 Gits Molding Corp.
CRYSTAL-VOX
 Laurehk Radio Mfg. Co.
CRYSTOGRAPH
 Offner Electronics, Inc.
CRYSTOLON
 Norton Co.
C S P
 Westinghouse Electric Corp.
CTS
 Chicago Telephone Supply Corp.
CUNICO
 Arnold Engineering Co.
CUNIFE
 Arnold Engineering Co.
CUNNINGHAM
 Radio Corp. of America.
CUPALOY
 Westinghouse Electric Corp.
CUPRON
 Driver Co., Wilbur B.
CUSHIONTONE
 Armstrong Cork Co.
CUSTOMODE
 Jensen Mfg. Co.
CYCLE-PROGRESS
 Automatic Temperature Control Co.
CYCELOG
 The Foxboro Co.
CYCL-FLEX
 Eagle Signal Corp.
CYCLE-FLEX
 Wilson & Co., G. C.
CYCLE-RAY
 Friez Instrument Div.
 Bendix Aviation Corp.
CYCLE-TROL
 Cyclotron Specialties Co.
CYCLOTROL
 Minneapolis-Honeywell Regulator Co.
D 54
 Mallory & Co., Inc., P. R.
"D" NICKEL
 The International Nickel Co., Inc.
DAG
 Acheson Colloids Corp.
DAKA-WARE
 Davies Molding Co., Harry
DALBAR
 Electronic Enterprises.
DALE
 Electronic Development Co.
DALMOTRON
 Dalmo Victor Co.
DAMASCENE
 Linick Chemical Co.
DAMASCITE
 Amplex Div.
 Chrysler Corp.
DANDEE
 Aerovox Corp.
DANDUX
 Daniels, Inc., G. R.
DA-NITE
 Bendix Aviation Corp.
DAVENOIL
 Daven Co.
DAVOHM
 Daven Co.
DC SILICONES
 Dow Corning Corp.
DE FOREST
 Radio Corporation of America.
DECATRAN
 Melco Products, Inc.
DECO
 Dumont Electric Co.
DECOHM
 Davis Electric Co.
DEEMINIZER
 Crystal Research Labs., Inc.
DEEMINITE
 Crystal Research Labs., Inc.
DE-FROST-IT
 Paragon Electric Co.
DEHYDRA
 Wappler, Inc.
DE-ION
 Westinghouse Electric Corp.
DEKA-XTAL
 Scientific Radio Products Co.
DELTABESTON
 General Electric Co.

DELTAMAX
 Allegheny Ludlum Steel Corp.
DELTAMAX
 Arnold Engineering Co.
DEMCO
 Dormitzer Electric Co., Inc.
DENSICHRON
 Welch Scientific Co., W. M.
DEOXIDINE
 American Chemical Paint Co.
DEOXO
 Baker & Co., Inc.
DENSITE
 West Virginia Pulp & Paper Co.
 Pulp Products Dept.
DEPTHOMETER
 Bludworth Marine Div.,
 National-Simplex-Bludworth, Inc.
DESCO
 Dietz Design & Mfg. Co.
DESPARD
 Pass & Seymour, Inc.
DETECT-A-FIRE
 Fenwal, Inc.
DETECTOMETER
 Dillon & Co., Inc., W. C.
DETERMOMM
 Ohmite Mfg. Co.
DEW POINTER
 Illinois Testing Labs., Inc.
DIABO
 Tibbetts Industries, Inc.
DIACLOR
 Sangamo Electric Co.
DIACONE
 Altec Lansing Corp.
DI-ACRO
 O'Neil Irwin Mfg. Co.
DIAL
 Nebel Lab., R. E.
DIALCO
 Dial Light Co. of America.
DIAMATROL
 Standard Electronics Research Corp.
DIAMOND
 Continental Diamond Fibre Co.
DIAMOND
 Tetrad Corp.
DIAMOND G
 Garrett Co., Inc., G. K.
DIAMOND WEAVE
 Sickles Co., F. W.
DIAMOND PRODUCTS
 Garrett Co., Inc., George K.
DIAMONTINE
 Linick Chemical Co.
DIAPHLEX
 Cook Electric Co.
DIATRON
 Consolidated Engineering Corp.
DICHROIC
 Liberty Mirror Div.,
 Libbey-Owens Ford Glass Co.
DICO
 Diamond Mfg. Co.
DIEGRAF
 Grafo Colloids Corp.
DIELITE
 Wirt Co.
DI-FAN
 Andrew Co.
DIFLEX
 Insulation Manufacturers Corp.
DI-FORMED
 Precision Papcr Tube Co.
DILECTENE
 Continental Diamond Fibre Co.
DILECTO
 Continental Diamond Fibre Co.
DIMMERETTE
 Ward Leonard Electric Co.
DIPLOIT
 Dielectric Materials Co.
DIPMASTER
 Aeroil Products Co.
DIPWITE
 Special Chemicals Co.
DIPWRAP
 Paisley Products Inc.
DIRECT-DRIVE
 Shure Brothers, Inc.
DISCALOY
 Westinghouse Electric Corp.
DISCAPS
 Radio Materials Corp.
DISCOHM
 Ward Leonard Electric Co.
DISPATCHER
 Motorola Inc.
DISPLAY KING
 Gale Dorothea Mechanisms
DIVCO
 Division Lead Co.
DIVERSE-ADAPTOR
 Decimeter, Inc.
DIVIDOHM
 Ohmite Mfg. Co.
DIXONAC
 Dixon Crucible Co., Joseph.
DOBAR
 Dobeckmun Co., The
 Industrial Products Div.
DOBR0
 Valco Mfg. Co.
DOG
 Radio Corporation of America.
DOLFLEX
 Dolph Co., John C.

DONUT
 Associated Research Inc.

DOOROD
 Belling & Lee, Ltd.

DOPLEX
 Dobeckmun Co., The
 Industrial Products Div.

DOSIMETER
 Instrument Development Labs.

DOT
 United-Carr Fastener Corp.

DOWMETAL
 Dow Chemical Co.

D. R. C.
 Dayco Radio Corp.

DRIMETER
 Fielden Electronics Inc.

DRI-N-TITE
 Horn Co., Inc., A. C.

DRIOX
 Linde Air Products Co.
 Unit of Union Carbide & Carbon Corp.

DRITHERM
 North American Electric Lamp Co.

DRUM-KARRIER
 Falstrom Co.

DU KANE
 Operadio Mfg. Co.

DU NOUY
 Central Scientific Co.

DUAL DANDEE
 Aerovox Corp.,

DUAL-DRUM
 Gorrell & Gorrell.

DUAL-HORN
 Brociner Electronics Laboratory.

DUART
 Mass & Waldstein Co.

DUBLER
 Precision Plastic Products Inc.

DUBL-VEE
 Workshop Associates, Inc.

DUBL-X
 Telrex, Inc.

DUCO
 du Pont de Nemours & Co., Inc., E. I.

DULAC
 Mass & Waldstein Co.

DULUX
 du Pont de Nemours & Co., Inc., E. I.

DUOCARB
 Driver Co., Wilbur B.

DUOCRE X
 Horn Co., Inc., A. C.

DUODIAL
 Helipot Corp.

DUODISC
 Duotone Co., Inc.

DUO-FLEX
 Dumore Co., The.

DUOLITE
 Pittsburgh Plate Glass Co.

DUO-PULSE
 Automatic Temperature Co., Inc.

DUOSCALE
 Tracerlab, Inc.

DUO-SEAL
 Welch Scientific Co., W. M.

DUOSONIC
 Sonic Industries, Inc.

DUO-SPEED
 Pentron Corp.

DUO-SPEED
 V-M Corp.

DUPLATE
 Pittsburgh Plate Glass Co.

DUPLEX
 Altec Lansing Corp.

DUPY
 Inet Inc.

DURABLE
 Seagar Carbon Co.

DURALINE
 Universal Drafting Machine Corp.

DURALON
 U. S. Stoneware Co.

DURANITE
 Aerovox Corp.

DURASHIELD
 Plastic Fabricators Co.

DURATAPE
 Rahm Instruments, Inc.

DURATIP
 Weller Mfg. Co.

DURATRON
 Hoffman Corp., C. L.

DURITE
 The Borden Co., Chemical Div.

DURO
 Rogers Corp.

DURO-BOND
 Electro Chemical Engineering Co.

DUROID
 Rogers Corp.

DURO-KOTE
 Electro Chemical Engineering Co.

DURON
 Electro Chemical Engineering Co.

DURO-PRENE
 Electro Chemical Engineering Co.

DURO XXX
 Electro Chemical Engineering Co.

DURPOINT
 Duotone Co., Inc.

DUTCH BOY
 National Lead Co.

D-XER
 JFD Mfg. Co.

DX MASTERSPEAKERS
 DX Radio Products Co., Inc.

DYEPRINT
 Times Facsimile Corp.

DYKANOL
 Cornell-Dubilier Electric Corp.

DYNACOTIL
 Crosley Corp.

DYNAGAGE
 Photocon Research Products.

DYNALOG
 Foxboro Co., The

DYNAMASTER
 Bristol Co., The.

DYNA-METER
 Industrial Electronics, Inc.

DYNAMIC
 Jackson Electrical Instrument Co.

DYNA-MIKE
 Industrial Electronics, Inc.

DYNA-TACH
 Electric Tachometer Corp.

DYNATHERM
 American Diathermy Products, Inc.

DYNATONE
 Crosley Corp.

DYNAURAL
 Scott, Inc., Hermon Hosmer.

DYNETRIC
 Gisholt Machine Co.

DYNETRIC
 Westinghouse Electric Corp.

DYNOGRAPH
 Annis Co., R. B.

DYNOGRAPH
 Offner Electronics, Inc.

DYNOID
 McQuay-Norris Mfg. Co.

E. A. D.
 Eastern Air Devices, Inc.

"E" NICKEL
 The International Nickel Co., Inc.

EAI
 Electronic Associates, Inc.

EARSET
 Telex, Inc.

EASY-FLO
 Handy & Harman

EBROK
 Richardson Co., The.

ECCO
 Triad Transformer Mfg. Co.

ECHOPHONE
 Hallcrafters Co.

ECKCO
 Eckstein Radio & Television Co.

ECO
 Economy Fuse & Mfg. Co.

ECON-OHM
 Model Engineering & Mfg. Inc.

ECONO-SLIDE
 Grant Pulley & Hardware Co.

EDGEOHM
 Ward Leonard Electric Co.

EDIPHONE-TELEDIPHONE
 Edison Inc., Thomas A.

EDIPROBE
 Electronic Designs, Inc.

EDUCATOR
 Operadio Mfg. Co.

EDUCATOR
 Wilcox-Gay Corp.

EEL
 Electronic Enterprises Inc.

EGYPTIAN TIP
 Mitchell Industries, Inc.

EICO
 Electronic Instrument Co. Inc.

E.I.E.
 Electrical Industries, Inc.

8-BALL
 Ward Products Corp., Div. of The Gabriel Co.

EIMAC
 Eitel McCullough, Inc.

EJECT-O-MATIC
 Multi-Products Tool Co.

EKOTAPE
 Webster Electric Co.

EL
 Electronics, Inc.

ELAC
 Electro Acoustic Industries, Ltd.

ELAC-GEM
 Electro Acoustic Industries, Ltd.

ELASTOBOND
 Paisley Products, Inc.

ELASTRON
 Industrial Synthetics Corp.

ELCOFONE
 Loral Electronics Corp.

ELECTONE
 Northeastern Engineering, Inc.

ELECTR O VANE
 Brown Instrument Co.

ELECTREX
 Gorrell & Gorrell.

ELECTRICORD
 Pacific Electriccord Company.

ELECTRIX
 U. S. Rubber Co.

ELECTRO-CAL
 Industrial Electronics, Inc.

ELECTROCAM
 Westinghouse Electric Corp.

ELECTROD
 Teletronics Corp.

ELECTRO-GLOW
 Industrial Devices, Inc.

ELECTRO GRAPHIC
 Precise Measurements Co.

ELECTRO-LARYNX
 Aurex Corp.

ELECTROLIMIT
 Pratt Whitney Div., Niles-Bement-Pond Co.

ELECTROMANOMETER
 Sanborn Co.

ELECTRO-MATIC
 Automatic Signal Div.,
 Eastern Industries Inc.

ELECTROMAX
 Leeds & Northrup Co.

ELECTROMET
 Electro Metallurgical Division
 Union Carbide & Carbon Corp.

ELECTRON BELL
 Riggs & Jeffreys, Inc.

ELECTRONAMIC
 Precision Apparatus Co.

ELECTRONIC DOORMAN
 John T. O'Connor & Co.

ELECTRONIC EAR
 Sonotone Corp.

ELECTRONIC FEATHER
 Westinghouse Electric Corp.

ELECTRONIC HANDYMAN
 John T. O'Connor & Co.

ELECTRONIC STETHOSCOPE
 Feiler Engineering Co.

ELECTRONIK
 Minneapolis-Honeywell Regulator Co.

ELECTROPHOT
 Adair & Rhamstine.

ELECTROPHOTOMETER
 Fisher Scientific Co.

ELECTROSCOPE
 Feiler Engineering Co.

ELECTROSE
 Insulation Mfg. Co.

ELECTROTEMP
 Westinghouse Electric Corp.

ELECTROX
 Schauer Mfg. Corp.

ELECTR-O-VANE
 Minneapolis-Honeywell Regulator Co.

ELECTRUNITE
 Republic Steel Corp.

ELECTROTUNER
 General Instrument Corp.

ELENCO
 Electronic Engineering Corp.

ELEPHANT
 Phosphor Bronze Corp.

ELIMINOISE
 Belling & Lee, Ltd.

ELINCO
 Electric Indicator Co.

ELINCOR
 Electronic Indicator Corp.

ELKALOY
 P. R. Mallory & Co., Inc.

ELKONITE
 P. R. Mallory & Co., Inc.

ELKONIUM
 P. R. Mallory & Co., Inc.

ELLANAR
 L & R Mfg. Co.

EL-MENCO
 Electro Motive Mfg. Co.

ELMET
 North American Phillips Co., Inc.

ELVANOL
 E. I. du Pont de Nemours & Co., Inc.

E-M
 Electric Machinery Mfg. Co.

EMC
 Electronic Measurements Corp.

E.M.C.
 Electric Motor Corp.

EMDECO
 Magnetic Devices Corp.

EMICO
 Electro-Mechanical Instrument Co.

EMPCO
 Electronic Mechanical Products Co.

EMPIRE
 Mica Insulator Co.

EMPIRE
 Russell, Burdall & Ward Bolt and Nut Co.

ENAMELITE
 Acme Wire Co.

ENDURO
 Republic Steel Corp.

ENDUR-PRENE
 General Insulated Wire Works, Inc.

ENE-VOLT
 Gorrell & Gorrell

ENGRAVOGRAPH
 New Hermes, Inc.

ENPO
 Piqua Machine & Mfg. Co.

ENVOY
 Ansley Mfg. Co., Arthur

EOHITE
 U. S. Rubber Co.

EOPRENE
 U. S. Rubber Co.

EPCO
 Etched Products Corp.

EPLAB
 Eppley Lab., Inc., The.

EQUALOAD
 Keystone Carbon Co., Inc.

ERSIN MULTICORE
 Multicore Sales Corp.

ESCO
 Electric Specialty Co.

ESICO
 Electric Soldering Iron Co.
ESNA
 Elastic Stop Nut Corp. of America.
ES-NAILS
 Elastic Stop Nut Corp. of America
ESTO
 Electro Chemical Engineering Co.
ETHOCEL
 Dow Chemical Co.
ETHYLON
 American Phenolic Corp.
ETCO
 Electronic Transformer Co., Inc.
EUREKA
 Morse Co., Frank W.
EUTEC-SILVER-WELD
 Eutectic Welding Alloys Corp.
EUTECHROM
 Eutectic Welding Alloys Corp.
EUTECROD
 Eutectic Welding Alloys Corp.
EUTECTOR
 Eutectic Welding Alloys Corp.
EUTECTRODE
 Eutectic Welding Alloys Corp.
EVABRITE
 Bach & Co., Semon.
EVALAST
 Bache & Co., Semon.
EVEN-BREAK
 Electric Eye Equipment Co.
EVENRAY
 Fostoria Pressed Steel Corp.
EVERLASTING
 Harper Co., The, H. M.
EVELYN
 Rubicon Co.
EVEREADY
 National Carbon Co., Div. of
 Union Carbide & Carbon Corp.
EVERLOCK
 Thompson-Bremer & Co.
EVER-LOK
 Russell & Stoll Co., Inc.
EXACT PHOTOCOPY
 General Photo Products Co.
EXCELLALL
 Frederick Post Co.
EXIDE
 Electric Storage Battery Co.
EXIDE-IRONCLAD
 Electric Storage Battery Co.
EXIDE-MANCHEX
 Electric Storage Battery Co.
EXPLAINETTE
 Operadio Mfg. Co.
EYE WITNESS
 Radio Corporation of America.
E-Z
 Pyramid Products Co.
E-Z CODE
 Western Lithograph Co.
 E-Z Code Div.
E-Z CUE
 Amplifier Corp. of America.
EZSOL
 Hudson Wire Co.
FARADON
 Cornell-Dubilier Electric Corp.
FARATRON
 Lumenite Electric Co.
FARCO
 Farrelloy Co.
FASTACK
 Paisley Products, Inc.
FASTENEERING
 Central Screw Co.
FASTICK
 Paisley Products, Inc.
FASTOP
 Lear, Inc.
FAST'S
 Koppers Co., Inc.
FATHOMETER
 Raytheon Mfg. Co.
FAXIMILE
 Hogan Laboratories, Inc.
FAXPAPER
 Hogan Laboratories, Inc.
FEATHERIDE
 Webster Electric Co.
FEDCO
 Federal Engineering Co.
FEDERAL RECORDER
 Conn Ltd., C. G.
FEL-PAK
 Felt Products Mfg. Co.
FEL-PRO
 Felt Products Mfg. Co.
FENOX
 Bakelite Corp.
FERRAMIC
 General Ceramics & Steatite Corp.
FERRET
 Coastwise Electronic Co., Inc.
FERROTUNE
 S-W Inductor Co.
FIBERGLAS
 Owens-Corning Fiberglas Corp.
FIBRACOUSTIC
 Johns-Manville Sales Corp.
FIBESTOS
 Monsanto Chemical Co., Plastics Div.
FIBRETONE
 Johns-Manville Sales Corp.
FIDELITONE
 Permo, Inc.
FIFTY-FOUR
 Cardwell Mfg. Corp., Allen D.
FILMGRAPH
 Miles Reproducer Co., Inc.
FILMSCRIBER
 Miles Reproducer Co., Inc.
FILNIC
 Driver-Harris Co.
FILPEC
 Centralab Div., Globe Union Inc.
FILTERETTE
 Deutschmann Corp., Tobe
FILTERNOYS
 Continental Carbon, Inc.
FILTEROL
 Sprague Electric Co.
FILTER POINT
 Duotone Co., Inc.
FILTERS L
 Sprague Electric Co.
FILTERVOLT
 Insuline Corp. of America.
FINNPLEX
 Finn & Co., Inc., T. R.
FIRE DEVIL
 Littelfuse, Inc.
FIREYE
 Combustion Control Corp.
FIREWALL
 Rockbestos Products Corp.
FISHERFONE
 Fisher Research Lab.
5-WAY
 Superior Electric Co., The.
FIVER
 Crosley Corp.
FLAG GRIP
 Aircraft-Marine Products, Inc.
FLAME-OTROL
 Wheelco Instrument Co.
FLAME-WARDEN
 Combustion Research Laboratories, Inc.
FLASH
 Sheldon Electric Co.
 Div. of Allied Electric Products, Inc.
FLATAK
 Paisley Products Inc.
FLATWRAP
 Paisley Products Inc.
FLEET CONTROL
 Hammarlund Mfg. Co.
FLEXAGUIDE
 Airtron Inc.
FLEX-A-POWER
 Trumbull Electric Mfg. Co.
FLEXARC
 Westinghouse Electric Corp.
FLEXFLAT
 Paisley Products Inc.
FLEXIFONE
 Operadio Mfg. Co.
FLEXILUGS
 Frankel Connector Co.
FLEXISPLICES
 Frankel Connector Co.
FLEXITIP
 Weller Mfg. Co.
FLEXI-TROL
 Wilson & Co., G. C.
FLEXITONE
 Operadio Mfg. Co.
FLEXITUBE
 Walter L. Schott Co.
FLEXLOC
 Standard Pressed Steel Co.
FLEXO
 Art Specialty Co.
FLEXO-MIKESTER
 Art Specialty Co.
FLEXOPULSE
 Eoale Signal Corp.
FLEX-SOK
 Stuppkoef Ceramic & Mfg. Co.
FLEX-STAFF
 Pfanzstiel Chemical Co.
FLEXTACK
 Paisley Products Inc.
FLIGHT COM
 Communications Co., Inc.
FLIGHTWEIGHT
 Bendix Aviation Corp.
FLIMOSEAL
 Telegraph Condenser Co., Ltd.
FLIPON
 Westinghouse Electric Corp.*
FLOATING JEWEL
 Crosley Corp.
FLOOD-FLASH
 Photobell Company
FLOSOL
 American Chemical Paint Co.
FLOTROL
 Lorain Products Corp.
FLOWRATOR
 Fischer & Porter Co.
FLUORADEX
 Westinghouse Electric Corp.
FLUORETOR
 Menlo Research Laboratory.
FLUORO-RECORD
 Fairchild Camera & Instrument Corp.
FLUOROSPOT
 Westinghouse Electric Corp.
FLUOROVUE
 Westinghouse Electric Corp.

FLUROPACK
 Telegraph Condenser Co., Ltd.
FLUSH-LITE
 Littelfuse, Inc.
FLUTED ELECTRODE
 P. R. Mallory & Co., Inc.
FLUTO
 Pass & Seymour Inc.
FLUTOLIER
 Pass & Seymour Inc.
FLUX GATE
 Eclipse-Pioneer Div., Bendix Aviation Corp.
FLUXRITE
 National Lead Co.
FLYING ARROW
 Ward Products Corp. Div. of
 The Gabriel Co.
FME
 Federal Mfg. & Engrg. Corp.
FM-G
 General Controls Co.
F. N. A.
 Paisley Products, Inc.
FOCALIZER
 Quam Nichols Co.
FOOTROL
 General Control Company.
FORDMICA
 Ford Radio & Mica Corp.
FORMEX
 General Electric Co.
FORMVAR
 Acme Wire Co.
FORTICEL
 Celanese Corp. of America.
FORTISAN
 Celanese Corp. of America.
'49' ALLOY
 Magnetic Metals Co.
FOSTERITE
 Westinghouse Electric Corp.
FOTO-FLO
 Haloid Co., The.
FOTOELECTRIC
 Worner Electronic Devices.
F. P. INDUCTUNER
 Mallory & Co., Inc., P. R.
FRAHM
 Biddle Co., James G.
FREE-CUT INVAR '36'
 Carpenter Steel Co.
FREED-EISEMANN
 Freed Radio Corp.
FREE-VANE
 Bristol Co., The.
FREQUEMATIC
 Federal Telephone & Radio Corp.
FRIGISTAT
 Minneapolis-Honeywell Regulator Co.
FROST
 Chicago Telephone Supply Corp.
FURNATRON
 Westinghouse Electric Corp.
FURZEHILL
 American British Technology, Inc.
FUSETRON
 Bussmann Mfg. Co.
FUSTATS
 Bussmann Mfg. Co.
FYBERGLASS
 Rush Wire Stripper Div.,
 Eraser Co., Inc., The.
FYBEROID
 Wilmington Fibre Specialty Co.
G-C
 General Cement Mfg. Co.
GALVANOID
 Wickwire Spencer Steel, Div. Colorado Fuel & Iron
 Corp.
GALVEX
 Wickwire Spencer Steel, Div., Colorado Fuel & Iron
 Corp.
GAMMATRON
 Heintz & Kaufman Div. of
 The Robert Dollar Co.
GAMUT
 Commodore Record Co.
GARCEAU
 Electro-Medical Lab., Inc.
GAROD
 Majestic Radio & Television Div. of
 The Wilcox-Gay Corp.
GEMCOTE
 Gemloid Corp.
GEMFLEX
 Gemloid Corp.
GEMGLEEN
 Gemloid Corp.
GEMLIKE
 Gemloid Corp.
GEMLITE
 Gemloid Corp.
GEMLOID
 Gemloid Corp.
GEMWELD
 Gemloid Corp.
GENEMOTOR
 Carter Motor Co.
GENERAL
 Commodore Record Co.
GENERAL BRAND
 General Dry Batteries, Inc.
GENERALITIES
 Fostoria Pressed Steel Corp.
GENEVALOC
 Bendix Aviation Corp., Pacific Div.
GEN-RAL
 Muter Co.

GEOFORMER
Triad Transformer Mfg. Co.

GEON
Goodrich Chemical Co., B. F.

GERON
Gering Products, Inc.

GERPAK
Gering Products, Inc.

GI
General Industries Co.

GIBSILOY
Gibson Electric Co.

GIBSON-SPRINGS
Associated Spring Corp.

GLAMORTONE
Crosley Corp.

GLASOHH
Clarostat Mfg. Co., Inc.

GLASSEAL
Pyramid Electric Co.

GLASS SEALING '42', '426', '49'.
Carpenter Steel Co.

GLASSMIKE
Condenser Products Co.

GLASTIC
Laminated Plastics, Inc.

GLENNITE
Gulton Mfg. Corp.

GLIDER
Shure Brothers.

GLOBAL
Molded Insulation Co., Aircraft Control Div.

GLOBAR
Carborundum Co.

GLOBE TROTTER
Radio Corporation of America.

GLO-N-GLO
Canadian Radium & Uranium Corp.

GLOSSTEX
Daniels, Inc., C. R.

GLO-TECH
Fischer & Porter Co.

GLYDAG
Acheson Colloids Corp.

G-MAX
Flight Research Engineering Corp.

G-METER
Schottland, Frederick D.

GOLDEN BEAM
Motorola, Inc.

GOLDEN THROAT
Radio Corporation of America.

GOLDEN VIEW
Motorola Inc.

GOLDEN VOICE
Motorola Inc.

GOLD-SEAL
Miller Co., B. F.

GOODELL
Minnesota Electronics Corp.

GOOD-RITE
Goodrich Chemical Co., B. F.

GOTHAM
Shevers Inc., Harold

GOTHARD
Johnson Co., E. F.

G-P
Erie Resistor Corp.

GRACOIL
Gramer Transformer Co.

GRAFOIL
Brush Development Co.

GRAFOLUX
Grafo Colloids Corp.

GRAFO CONCENTRATE
Grafo Colloids Corp.

GRALAB
Dimco-Gray Co.

GRANODINE
American Chemical Paint Co.

GRAPHALLOY
Graphite Metallizing Corp.

GRATRAN
Gramer Transformer Co.

GRAVIGAGE
Ess Specialty Co.

GREENBILT
Equipment and Service Co.

GREEN GEM
Rauland-Borg Corp.

GREENOHH
Clarostat Mfg. Co., Inc.

GRENZ
Westinghouse Electric Corp.

GRIDNIC
Driver-Harris Co.

GRIP-HOLD
JFD Mfg. Co.

GRIP-POINT
Vaco Products Co.

GRIP TIGHT
Paisley Products, Inc.

GRIPMASTER
Walker Co., George

GRIPPER
Scovill Mfg. Co., Industrial Fastener Div.

GRIPTITE
Stevens-Walden, Inc.

GRIP-X
Rattan Mfg. Co., The

GRIZZLY
U. S. Rubber Co.

GTC
General Transformer Co.

GUEST TELEVISION
Industrial Television, Inc.

GUITAN
Rowe Industries.

GYRO
Sperry Gyroscope Co., Div. of The Sperry Corp.

GYROPILOT
Sperry Gyroscope Co., Div. of The Sperry Corp.

GYROSYN
Sperry Gyroscope Co., Div. of The Sperry Corp.

HABIRLENE
Phelps Dodge Copper Products Corp.

HABIRSHAW
Phelps Dodge Copper Products Corp.

HAFTSON
Haft & Son, Inc.

HALLOWELL
Standard Pressed Steel Co.

HALO
Haloid Co., The

HALOBROME
Haloid Co., The

HALOWAX
Union Carbide & Carbon Corp.

HAM CRYSTALS
Nebel Lab., R. E.

HAMMERTONE
Maas & Waldstein Co.

HAMMETER
Simpson Electric Co. Div., American Gage & Machine Co.

HANDI-GLOW
Industrial Devices Inc.

HANDI-PHONE
Murdock Mfg. Co., Wm. J.

HANDIE TALKIE
Motorola, Inc.

HANDY ANDY
Rattan Mfg. Co., The

HANDY-FLUX
Handy & Harman.

HANDYVAR
Martindale Electric Co.

HAR-CAM
Harvey Radio Labs, Inc.

HARTRON
Hart & Co., Inc., Frederick.

HARVEL
Irvington Varnish & Insulator Co.

HARVEY
Harvey Wells Electronics, Inc.

HARVEY
Peck & Harvey

HASCROME
Haynes Stellite Co.,
Unit of Union Carbide & Carbon Corp.

HASTELLOY
Haynes Stellite Co.,
Division of Union Carbide & Carbon Corp.

HAYSTELLITE
Haynes Stellite Co.,
Unit of Union Carbide & Carbon Corp.

HAZACODE
Hazard Insulated Wire Works Div.,
The Okonite Co.

HAZACORD
Hazard Insulated Wire Works Div.,
The Okonite Co.

HAZAKROME
Hazard Insulated Wire Works Div.,
The Okonite Co.

HAZARDEX
Hazard Insulated Wire Works Div.,
The Okonite Co.

HAZEGAGE
Ess Specialty Corp.

HC
Nebel Lab., R. E.

HEAD
Industrial Electronics, Inc.

HEATEX
Acme Wire Co.

HEETMASTER
Aeroil Products Co.

HEETMOR
Acme Electric Heating Co.

HELIOFLASH NO. 124
MacLeod & Hanopol

HELI-O-LITES
C. F. Pease Co.

HELIOS
Keuffel & Esser Co.

HELISCOPE
Crosley Corp.

HERCULES
Acromark Co.

HERCULES
Rubicon Co.

HERCULES
Shure Brothers, Inc.

HERCULITE
Pittsburgh Plate Glass Co.

HERECROL
Heresite Chemical Co.

HERMETICIAN
Fusite Corp.

HERMICO
Hermetic Seal Products Co.

HEX-LOK
Boots Aircraft-Nut Corp.

HEXLOX
Prestol Corp.

HEX-SCRU
Stronghold Screw Products

HEYCO
Heyman Mfg. Co.

H & H
Arrow-Hart & Hegeman Electric Co.

HI-BALL
Radiart Corp.

HI BRITE
Shannon Luminous Materials Co.

HI-FARAD
Aerovox Corp.

HI-FLUX
Annis Co., R. B.

HI-G
General Controls Co.

HI-MAG
P. R. Mallory & Co., Inc.

HIGH PERMEABILITY '49'
Carpenters Steel Co.

HIGH STABILITY
Welwyn Electronic Components Co.

HI-KAPS
Centralab Div. of
Globe-Union, Inc.

HI K CERAMICONS
Erie Resistor Corp.

HINJON
Thomas & Betts Co., Inc.

HIPERCO
Westinghouse Electric Corp.

HIPERNIK
Westinghouse Electric Corp.

HIPERSIL
Westinghouse Electric Corp.

HIPOWER
Radiart Corp.

HI-Q
Electrical Reactance Corp.

HIS MASTER'S VOICE
Radio Corporation of America

HI-TEM
Electro Chemical Engineering Co.

HI-TEMP
Dielectric Materials Co.

HI-TEMP
Rome Cable Corp.

HI-TORK
Electro-Mechanical Instrument Co.

HI-VOLT
Industrial Devices, Inc.

HI-VO-KAPS
Centralab Div. of
Globe-Union, Inc.

HK
Dollar Co., Robert

HOBBY-FLEX
Dumore Co., The

HOLD-HEET
Russell Electric Co.

HOLD-TITE
U. S. Rubber Co.

HOLLYTRAN
Transformer Engineers

HOLTITE
Continental Screw Co.

HOMAC
Hose-McCann Telephone Co., Inc.

HOMEASE
Bogue Electric Mfg. Co.

HORNAC
Horn Co., Inc., A. C.

HORNET
New York Transformer Co., Inc.

HOT NAILS
House of Television, Inc.

HOTSPOT
Mitchell Industries, Inc.

HOUSE OF HEARING
Sonotone Corp.

HP
Hewlett-Packard Co.

H-Q
Hammarlund Mfg. Co.

H. R. S.
Dine and Co., Inc., F. E.

HUBBELLOCK
Hubbell, Inc., Harvey

HUDCO
Hudson Wire Co.

HUDSON
Oxford Electric Corp.

HUMIDIGRAPH
Bristol Co., The

HUMIDI-SEAL
Pyramid Electric Co.

HUMIDOLAIN
Star Porcelain Co.

HUMIDUSTAT
Minneapolis-Honeywell Regulator Co.

HURLETRON
Electric Eye Equipment Co.

HUSITE
Huse Liberty Mica Co.

HUSHATONE
Brush Development Co.

HUSKY
Price Electric Corp.

HYCAR
Goodrich Chemical Co., B. F.

HYDENT
Burdny Engineering Co.

HYDEWA
Leon J. Barrett Co.

HYDEX
Jensen Mfg. Co.

HYDRAMOTOR
General Controls Co.

HYDRAULIC
White Rodgers Electric Co.

HYDRIMET
Metal Hydrides, Inc.

HYDROCORDER
Raymond Rosen Engineering Products, Inc.

HYDROGRAF
Grafo Colloids Corp.

HYDROSEC
U. S. Rubber Co.

HY-EFF
 Taylor Mfg. Co.
HYFLEX
 Irvington Varnish & Insulator Co.
HYFLUX
 Indiana Steel Products Company
HYGRADE
 Mitchell-Rand Insulation Co., Inc.
HYGRODIAL
 Friez Instrument Div., Bendix Aviation Corp.
HYHERVAC
 Central Scientific Co.
HYLINK
 Burndy Engineering Co.
HY LOW
 Stevens Products Inc.
HYLUG
 Burndy Engineering Co.
HYMU
 Magnetic Metals Co.
HYMU "80"
 Carpenter Steel Co.
HYPASS
 Sprague Electric Co.
HYPER
 Radio Music Corp.
HYPER-MAG
 Radio-Music Corp.
HYPERSONIC
 Brush Development Co.
HYPERVAC
 Central Scientific Co.
HYPEX
 Jensen Mfg. Co.
HYPOT
 Associated Research, Inc.
HYPRESS
 Burndy Engineering Co.
HY-PUSS
 Sprague Electric Co.
HY-Q 75
 Hytron Radio & Electronics Corp.
HYSTERSET
 Ward Leonard Electric Co.
HYTEMCO
 Driver-Harris Co.
HYTOOL
 Burndy Engineering Co.
HYVAC
 Central Scientific Co.
HYVOL
 Aerovox Corp.
ICA
 Insuline Corp. of America
ICE-STIK
 Paisley Products, Inc.
ICONIC
 Altec Lansing Corp.
IDA
 Computer Corp. of America
I. D. C.
 Motorola Inc.
IDECO
 Dresser Equipment Co.
IGNITO-CHEK
 Tonic Equipment Co.
IHC
 Illinois Condenser Co.
IHT
 Illinois Condenser Co.
ILLINI-HYCAP
 Illinois Condenser Co.
ILLITRON
 Illinois Tool Works, Electronics Div.
ILLUSTRAVOX
 Electro Engineering & Mfg. Co.
IMC
 Insulation Manufacturers Corp.
IMCOR
 Insulation Manufacturers Corp.
IMMERSATHERM
 Mercoind Corp.
IMPEDOMETER
 Electrodyne Company.
IMPERIAL
 Indiana Steel & Wire Co.
IMPERIAL
 Tele-Tone Radio Corp.
IMPREGNITE
 Standard Varnish Works
INCA
 Phelps Dodge Copper Products Corp.
INCELOID
 American Products Mfg. Co.
INCO
 International Nickel Co., Inc., The
INCONEL
 Alloy Metal Wire Co.
INCONEL
 International Nickel Co., Inc., The
INCREDUCTOR
 C. G. S. Laboratories, Inc.
INCREVOLT
 Sorenson & Co.
INDALLOY
 Indiana Steel Products Company
INDCO
 Industrial Condenser Corp.
INDELCO
 Industrial Electronics Co., Inc.
INDUCTORIDS
 De Coursey Engr. Lab.
INDUCTOTHERM
 General Electric X-Ray Corp.
INDUCTUNER
 Mallory & Co., Inc., P. R.
INDUR
 Reilly Tar & Chemical Corp.

INDUSTRIAL TELECEIVERS
 Industrial Television, Inc.
INDUSTRO
 Haloid Co., The
INERTAIRE
 Westinghouse Electric Corp.
INERTEEN
 Westinghouse Electric Corp.
INET
 Industrial Electronics & Transformer Co.
INFERNOCOTE
 Wirt Co.
INLINE
 American Phenolic Corp.
INMANCO
 Insulation Manufacturers Corp.
INPUTROL
 Wheelco Instruments Co.
IN-RES-CO
 Instrument Resistors Co.
INSA-LUTE
 Sauereisen Cements Co.
INSANOL
 Westinghouse Electric Corp.
INSL
 Insl-x Co., Inc.
INSL-X
 Centro Research Laboratories, Inc.
INSTAGRAPH
 Bristol Co., The
INSTANSOLDER
 Cole Radio Works
INSTOMATIC
 Sanborn Co.
INSULAZED
 Magnetic Metals Co.
INSULCON
 Stupakoff Ceramic & Mfg. Co.
INSUROK
 Richardson Co., The
INTELIN
 Federal Telephone & Radio Corp.
INTERLINK
 Federal Telephone & Radio Corp.
INTUC
 Insulating Tube Co.
INVAR "36"
 Carpenter Steel Co.
IONOTRON
 U. S. Radium Corp.
IRC
 International Resistance Co.
IRIS
 American Scientific Co.
IRMCO
 Munston Mfg. & Service, Inc.
IRN
 Williams & Co., C. K.
IRON OILITE
 Amplex Div.
 Chrysler Corp.
IRRADIOMETERS
 Sensitive Research Instrument Co.
IRV-O-LITE
 Irvington Varnish & Insulator Co.
IRV-O-VOLT
 Irvington Varnish & Insulator Co.
ISATRON
 Consolidated Engineering Corp.
ISO-ELASTIC
 John Chatillon & Sons
ISOMODE
 M B Mfg. Co.
ISOPLANE
 Motorola, Inc.
ISO-Q
 Isolantite Mfg. Corp.
ISO-Q
 Motorola Inc.
ISO-RAMIC
 Meck Industries, John
ISOTRON
 Consolidated Engineering Corp.
ISOTRON
 Nuclear Instrument & Chemical Corp.
IT
 Illinois Condenser Co.
ITELITE
 I-T-E Circuit Breaker Co.
IVI-FLEX
 Irvington Varnish & Insulator Co.
IVORY X
 Pass & Seymour, Inc.
JACK KNIFE
 Radio Merchandise Sales
JADE POWDER
 Linick Chemical Co.
JAGABI
 Biddle Co., James G.
JAY-BEE-TEE
 J B T Instruments, Inc.
JAZZ INFORMATION
 Commodore Record Co.
JECO
 Jarvis Electronics Corp.
JERKIT
 Littelfuse Inc.
JETFLEX
 Cook Electric Co.
JETLINE
 Carboneau Industries, Inc.
JIFFY
 Minerallac Electric Co.
JK
 James Knights Co.
J. M.
 Paisley Products, Inc.

JUELITE
 Juel Corp.
JUPITER GUM
 Paisley Products, Inc.
J-W SNIFFER
 Johnson-Williams, Ltd.
K-CAP
 Automatic Mfg. Corp.
K 42 B
 Westinghouse Electric Corp.
"K" MONEL
 The International Nickel Co., Inc.
"KR" MONEL
 The International Nickel Co., Inc.
K-TRAN
 Automatic Mfg. Co.
KAL-WOOD
 Keller Products, Inc.
KANTARK
 Trico Fuse Mfg. Co.
KANTLINK
 Positive Lock Washer Co.
KANTLINK
 American Nut & Bolt Fastener Co.
KAPPA
 Wright & Sons Co., William E.
KARADIO
 Eckstein Radio & Television Co.
KARBOMET
 Driver-Harris Co.
KARMA
 Driver-Harris Co.
KARRO PAK
 Felt Products Mfg. Co.
KATHANODE
 Gould Storage Battery Corp.
KATOLIGHT
 Kato Engineering Co.
KAYGREY
 Rogers Corp.
KAYPAR
 Rogers Corp.
KAYROK
 Rogers Corp.
KEL-F
 Electronic Mechanics, Inc.
KELLERFLEX
 Pratt & Whitney Div., Niles-Bement-Pond Co.
KELLER POLYGRAPH
 Associated Research, Inc.
KELEKET
 Kelly-Koett Mfg. Co., Inc., The
KEMET
 Union Carbide & Carbon Co.
KEMGO
 Markem Machine Co.
KENEX
 Westinghouse Electric Corp.
KENITE
 Keystone Electronics Co.
KEN-RAD
 General Electric Co.
KETOS
 Crucible Steel Co. of America
KIC
 Union Carbide & Carbon Corp.
KERATYM
 Horn Co., Inc., A. C.
K-H
 Krohn-Hite Instrument Co.
KILOVOLTERR
 Caddell-Burns Mfg. Co.
KIMBLE
 American Structural Products Co.
KING
 Electric Heat Control Co., The
KING MARKWELL
 Markem Machine Co.
KITCHENAIRE
 Radio Craftsmen
KITCHENOLA
 Radio Craftsmen
KLAMP-TITE
 I-T-E Circuit Breaker Co.
KLIPOK
 Trico Fuse Mfg. Co.
KLIPSCHORN
 Klipsch & Associates
KLIPXIT
 Vaco Products Co.
KLIPZON
 United Technical Laboratories
KLIXON
 Spencer Thermostat Div., Metals & Controls Corp.
KLYDONOGRAPH
 Westinghouse Electric Corp.
KNEADED
 Eberhard Faber Pencil Co.
KNIGHT
 Allied Radio Corp.
KNOCKOMETER
 Sperry Gyroscope Co., Div. of The Sperry Corp.
KODAGRAPH
 Eastman Kodak Co.
KODAK
 Eastman Kodak Co.
KODAPAK
 Eastman Kodak Co.,
KOHINOOR
 Waldes Kohinoor, Inc.
KOILED KORD
 Kellogg Switchboard & Supply Co.
KOLORDISK
 Centralab Div., Globe Union Inc.
KONAL
 Westinghouse Electric Corp.

KON-NEC-TOR
 General Electric Co.
KOOLOHM
 Sprague Electric Co.
KOTAL
 U. S. Rubber Co.
KOTRON
 Standard Arcturus Corp.
KOVAR
 Stupakoff Ceramic & Mfg. Co.
KOVAR
 Westinghouse Electric Corp.
KOVAR-ZIP
 Waldes Kohinoor, Inc.
KRISTON
 Goodrich Chemical Co., B. F.
KROME KOAT
 General Cement Mfg. Co.
KRYSTAL KOAT
 General Cement Mfg. Co.
K-TRAN
 Automatic Mfg. Corp.
KUPEC
 Centralab Div., Globe Union, Inc.
KULGRID
 Sylvania Electric Products, Inc.
K-V-O
 Sprague Electric Co.
KWIKFLUX
 Special Chemicals Co.
KWIK-KALL
 Loge Sound Engineers, J. M.
"L" NICKEL
 The International Nickel Co., Inc.
LABCASE
 Berkshire Laboratories
LABMARKER
 Berkshire Laboratories
LABVOLT
 Electrodyne Co.
LACKON
 Sun Dial Corp.
LAMCO
 La Magna Mfg. Co., Inc.
LAMICOID
 Mica Insulator Co.
LAMICOID
 Insulating Fabricators, Inc.
LAMICORES
 Magnetic Metals Co.
LAMIFORM
 Lamicaid Fabricators
LAMINAC
 American Cyanamid Co.
LAMIPACKS
 Magnetic Metals Co.
LAMITEX
 Franklin Fibre-Lamitex Corp.
LAURETT
 Laurehk Radio Mfg. Co.
LAUXEIN
 Monsanto Chemical Co., Plastics Div.
LAUXITE
 Monsanto Chemical Co., Plastics Div.
LAVA
 Kirchberger & Co., Inc., M.
LAVITE
 Steward Mfg. Co., D. M.
LAVOLAIN
 Star Porcelain Co.
LAYTEX
 U. S. Rubber Co.
LAZY-X
 Radiart Corp.
L-C CHECKER
 Aerovox Corp.
LEAK
 British Industries Corp.
LEARADIO
 Lear, Inc.
LEARAVIAN
 Lear, Inc.
LEARMATIC
 Lear, Inc.
LEATHAFLEX
 Paisley Products, Inc.
LECITE
 Electro Chemical Engineering Co.
LECTURN
 J. M. Loge Sound Engineers
LECTROPACK
 Telegraph Condenser Co., Ltd.
LECTROVISION
 Transvision, Inc.
LEDEX
 Leland, Inc., G. H.
LEESONA
 Universal Winding Co.
L-F
 Leibel-Flarsheim Co.
LEKTRO
 Conn Ltd., C. G.
LE-LAND
 Leland Electric Co.
LEROY
 Keuffel & Esser Co.
LEVEL
 White Rodgers Elec. Co.
LEXEL
 Dobeckmun Co., The
LIFE-LIKE
 Arc Radio Corp.
LIFE-LINE
 Westinghouse Electric Corp.
LIFE-SAVER
 Cole Radio Works
LIFETIME
 Reynolds Metals Co.

LIFETONE
 Duotone Co., Inc.
LIGHT WATCHMAN
 Ripley Co., Inc.
LIGHTNING
 Vaco Products Co.
LIGHTNING BUG
 Vibroplex Co., Inc.
LIGNOTITE
 Paisley Products, Inc.
LIGNOTOX
 Paisley Products, Inc.
LIMITROL
 Wheelco Instruments Co.
LIMITRON
 Arma Corp.
LIN-DE
 Linde Air Products Co.
 Unit of Union Carbide & Carbon Corp.
LINDOX
 Linde Air Products Co.
 Unit of Union Carbide & Carbon Corp.
LINE STARTER
 Westinghouse Electric Corp.
LINE-O-LIFE
 Carter Motor Co.
LITE-GAGE
 Photocon Research Products
LITE-O-STAT
 Viewlex, Inc.
LITHOFORM
 American Chemical Paint Co.
LITTLE DEVIL
 Ohmite Mfg. Co.
LITTLEPHONE
 Doolittle Radio, Inc.
LITTLE GEM
 Sickles Co., F. W.
LITTLE GIANT
 Crucible Steel Co. of America
LOADBOND
 Catalin Corp. of America
LOAD CARRIERS
 Market Forge Co.
LOAD LIFT
 Market Forge Co.
LOAD-MOBILE
 Market Forge Co.
LOAD MOVERS
 Market Forge Co.
LOAD PAC
 Market Forge Co.
LOAD SKIDS
 Market Forge Co.
LOAD-VEYOR
 Market Forge Co.
LOADED-X
 Radiart Corp., The
LOALIN
 Catalin Corp. of America
LOCALITE
 Fostoria Pressed Steel Corp.
LOCKETITE
 Locke Incorporated
LOCKSEAM
 Superior Tube Co.
LOCK-TITE
 Continental Screw Co.
LOCK-TITE
 Thomas & Betts Co., Inc.
LOGATEN
 Kalbfell Labs., Inc.
LOGE LECTERN
 Loge Sound Engineers, J. M.
LOGGER
 Audio Instrument Co.
LOHM
 Driver-Harris Co.
LOMU
 Magnetic Metals Co.
LOOPHOM
 Ward Leonard Electric Co.
L. P.
 Hickok Electrical Instrument Co.
LOS GATOS
 Lewis & Kaufman, Inc.
L'TATRO
 Eckstein Radio & Television Co.
LUCERO
 Driver-Harris Co.
LUCITE
 du Pont de Nemours & Co., Inc., E. I.
LUG-CLIP
 Littelfuse, Inc.
LUKENWELD
 Lukens Steel Co.
LUMAPANE
 Celanese Corp. of America
LUMARITH
 Celanese Corp. of America
LUMENAR
 Heiland Research Corp.
LUMETRON
 Photovolt Corp.
LUSTERIZED
 American Electric Cable Co.
LUSTERLAC
 American Electric Cable Co.
LUSTREX
 Monsanto Chemical Co.
 Plastics Div.
LUSTROM
 Monsanto Chemical Co.
 Plastics Div.
LUXAN
 Rauland Corp.
LUXATHERM
 Branston Electric Mfg. Co.

LUXIDE
 Rauland Corp.
LUXIFLUX
 Special Chemicals Co.
LUXOMETER
 Electronic Mechanical Products Co.
LUXOR
 Ace Mfg. Corp.
LUXTAR
 Viewlex, Inc.
LUXTRON
 Bradley Labs., Inc.
LYNN
 Vaco Products Co.
LYRIC
 Rauland-Borg Corp.
LYT-L-TUNER
 S. M. A. Co.
MAESTRO
 Reeves Soundcraft Corp.
MAGATAPE
 Crestwood Recorder Corp.
MAGICORE
 Crowley & Co., Inc., Henry L.
MAGICTONE
 Radio Development & Research Co.
MAGIC WAND
 Ward Products Corp. Div. of The Gabriel Co.
MAGMOTOR
 Carter Motor Co.
MAGNAC
 Magnetic Devices, Inc.
MAGNA-STRIPE
 Reeves Soundcraft Corp.
MAGNATELE
 Electro Engineering & Mfg. Co.
MAGNATONE
 Magna Electronics Co.
MAGNEBRAKE
 Vickers Electric Div.,
 Vickers, Inc.
MAGNECLUTCH
 Vickers Electric Div.,
 Vickers, Inc.
MAGNECORDER
 Magnecord, Inc.
MAGNEMATIC
 Amplifier Corp. of America
MAGNEMUSE
 Amplifier Corp. of America
MAGNEPAINT
 Micro-Circuits Co.
MAGNERAMA
 Amplifier Corp. of America
MAGNERASER
 Amplifier Corp. of America
MAGNERIBBON
 Amplifier Corp. of America
MAGNESCOPE
 Amplifier Corp. of America
MAGNESYNY
 Eclipse-Pioneer Div.
 Bendix Aviation Corp.
MAGNETAPE
 Amplifier Corp. of America
MAGNETEX
 Califone Corp.
MAGNETONE
 Brush Development Company, The
MAGNETORQUE
 Avion Instrument Corp.
MAGNETRONIC
 Cook Electric Co.
MAGNETTE
 Heinemann Electric Co.
MAGNETWIN
 Amplifier Corp. of America
MAGNILASTIC
 Cook Electric Co.
MAGNISET
 Bristol Co., The
MAGNO
 Driver-Harris Co.
MAGNORITE
 Norton Co.
MAIL-A-VOICE
 Brush Development Co.
MALLOSIL
 P. R. Mallory & Co., Inc.
MALTESE
 Bache & Co., Semon
MARFORCO
 Market Forge Co.
MARINE ARROW
 Bludworth Marine Div.,
 National-Simplex-Bludworth, Inc.
MARI-GUIDE
 Bludworth Marine Div.,
 National-Simplex-Bludworth, Inc.
MARINERS PATHFINDER
 Raytheon Mfg. Co.
MARINE PILOT
 Bludworth Marine Div.,
 National-Simplex-Bludworth, Inc.
MARK-TIME
 Rhodes Inc., M. H.
MARR
 Rattan Mfg. Co., The
MARS-LUMOGRAPH
 Staedtler, Inc., J. S.
MASCO
 Simpson Mfg. Co., Inc., Mark
MASTERLOUIT
 Kellogg Switchboard & Supply Co.
MASTERPHONE
 Kellogg Switchboard & Supply Co.
MASTERPRO
 Rek-O-Kut Co.

MATSURF
Arkwright Finishing Co.

MAXIMAR
General Electric X-Ray Corp.

MAXISCOPE
General Electric X-Ray Corp.

MAXMIXER
Special Products Co.

M. B. C.
Ray-O-Vac Co.

MCA
Molding Corp. of America

MEASURAY
Sheffield Corp.

MEASURTEST
Marconi Instruments Ltd.

MECATORN
Torngren Co., Inc., C. W.

MECHA
Servomechanisms, Inc.

MECHANI-SEAL
Fafnir Bearing Co.

MEDIQUARTZ
Dallons Labs.

MEDISINE
Dallons Labs.

MEDITHERM
Dallons Labs.

MEFCO
Production Engrg. Co.

MEG-METER
Winslow Co., Inc., The

MEGA-MARKER
Kay Electric Co.

MEGA-MATCH
Kay Electric Co.

MEGA-NODE
Kay Electric Co.

MEGA-PIPPER
Kay Electric Co.

MEGA-PIX
Kay Electric Co.

MEGA-PULSER
Kay Electric Co.

MEGASTYRENE
Transradio Ltd.

MEGA-SWEEP
Kay Electric Co.

MEGALIGNER
Kay Electric Co.

MEGALYZER
Kay Electric Co.

MEGALYZER JR.
Kay Electric Co.

MEGATENNA
Kay Electric Co.

MEGAVAC
Central Scientific Co.

MEGA-X
Kay Electric Co.

MEGGER
Biddle Co., James G.

MEGOMER
Sticht Co., Inc., Herman H.

MEG-O-MAX
Sprague Electric Co.

MEGOTONE
Aim Industries

MEL
Measurement Engineering, Ltd.

MELMAC
American Cyanamid Co.

MELODISC
Home Recording Products Corp.

MELPAK
Melpar, Inc.

MEMCO
Maryland Electronic Mfg. Corp.

MEMOBELT
Dictaphone Corp.

MEMOSTAT
Minnesota Electronics Corp.

MERCTRON
Ebert Electronics Corp.

MERCU-TROL
Mack Electrical Devices, Inc.

MERCURY
Kemlite Labs.

MERCURY
Vulcan Electric Co.

MERCURYSTAT
Westinghouse Electric Corp.

MERITONE
Autocrat Radio Co.

MERITONE
American Laubscher Corp.

MERITUNE
Polytech Devices, Inc.

MEROLA
Crosley Corp.

MERRYMAKER
Crosley Corp.

METAL MIKE
Sperry Gyroscope Co.
Div. of the Sperry Corp.

METAL SHIELDED WIRE
Uniform Tubes

METALASTIC
Cook Electric Co.

METALBOSS
Telegraph Condenser Co., Ltd.

METALITE
Astron Corp.

METALIX
North American Philips Co., Inc.

METALMITE
Telegraph Condenser Co., Ltd.

METALPACK
Telegraph Condenser Co., Ltd.

METALSEAL
Brush Development Company, The

METAMETER
Bristol Co., The

METAPHONE
Bristol Co., The

METAPLATING
Metaplast Process, Inc.

METAVANE
Bristol Co., The

METCLAD
I-T-E Circuit Breaker Co.

METERMAX
Leeds & Northrup Co.

METEROL
Automatic Temperature Control Co.

METEX
Metal Textile Corp.

METL-CAN
Pyramid Electric Co.

MET-L-FLEX
Robinson Aviation, Inc.

METRO-LITE
Viewlex, Inc.

METRONOMA
Crystal Research Labs, Inc.

METROSCOPE
Photocon Research Products

METROTHERM
General Controls Co.

MIC
Molded Insulation Co.

MICABOND
Continental Diamond Fibre Co.

MICADISC
Telegraph Condenser Co., Ltd.

MICA-GLAS
National Electric Coil Co.

MICANITE
Mica Insulator Co.

MICARTA
Westinghouse Electric Corp.

MICO
Mica Insulator Co.

MICRO
Minneapolis-Honeywell Regulator Co.

MICRO
New Hampshire Ball Bearings

MICROACT
Bristol Co., The

MICRO CIRCLE
Precise Measurements Co.

MICRODIAL
Borg Equipment Div.
The George W. Borg Corp.

MICRODRILL
Teletronics Laboratory, Inc.

MICRODYNE
Audak Co.

MICROFLASH
General Radio Co.

MICROFLEX
Eagle Signal Corp.

MICROLINE
Sperry Gyroscope Co. Div of The Sperry Corp.,

MICROMATCH
Jones Electronics Co., M. C.

MICROMAX
Leeds & Northrup Co.

MICRO-MIKER
Kalbfell Labs., Inc.

MICROMITE
Telegraph Condenser Co., Ltd.

MICROMOTOPS
Redmond Co., Inc.

MICROPACKS
Telegraph Condenser Co., Ltd.

MICROPAINT
Micro-Circuits Co.

MICROPOSITIONER
Barber-Colman Co.

MICROPOT
Borg Equipment Div.
George W. Borg Corp.

MICRO-PULSER
Kay Electric Co.

MICROSEN
Manning, Maxwell & Moore, Inc.

MICROSIL
Magnetic Metals Co.

MICROTESTERS
Simpson Electric Co. Div.,
American Gage & Machine Co.

MICROTHERM
Barber-Colman Co.

MICROTHERM
Raytheon Mfg. Co.

MICROTORQUE
Giannini & Co., Inc.

MICRO-TROLLER
Westinghouse Electric Corp.

MICROTOMIC
Eberhard Faber Pencil Co.

MICROVAC
Stokes Machine Co., F. J.

MICROVOLT
Ferris Instrument Co.

MICRO WEAVE
Holliston Mills Inc., The

MIDGET
Sprague Electric Co.

MIDGETALK
Simpson Mfg. Co., Inc., Mark

MIDGETROL
P. R. Mallory & Co., Inc.

MIDOHM
Driver-Harris Co.

MIDWAY
Cardwell Mfg. Corp., Allen D.

MIGHTY MIDGET
Sperman Metal Specialties

MIJAKON
Fast & Co., John E.

MIKASUB
Fast & Co., John E.

MIKE
Cornell-Dubilier Electric Corp.

MILCO
Miller Mfg. Co., M. A.

MILLISEC
Stevens-Arnold, Inc.

MINALITE
Westinghouse Electric Corp.

MINATROL
Westinghouse Electric Corp.

MINERALIGHT
Ultra-Violet Products, Inc.

MINI-AMP
Industrial Devices, Inc.

MINI-CHOPPER
Servomechanisms, Inc.

MINIFUSE
Belling & Lee, Ltd.

MINIGRAPH
Westinghouse Electric Corp.

MINI MAX
National Carbon Division,
Union Carbide & Carbon Corp.

MINISCALER
Atomic Instrument Co.

MINI-SHIELD
Staver Co., Inc.

MINI-SIGNAL
Premier Crystal Labs., Inc.

MINI-SPRING
Staver Co., Inc.

MINITAPE
Stancil-Hoffman Corp.

MINI-VOLT
Industrial Devices, Inc.

MINSTREL
Crosley Corp.

MINSUA
Keuffel & Esser Co.

MINUTE MAN
Ward Products Corp.,
Div. of The Gabriel Co.

MIRACLE POINT
Gerett Corp., M. A.

MIRAGLAS
Mitchell-Rand Insulation Co., Inc.

MIRROPANE
Liberty Mirror Div.,
Libbey-Owens-Ford Glass Co.

MIRROR TONE
Meck Industries, John

MIXATRON
Patterson Co., C. J.

M. L. S.
Paisley Products Inc.

MODIFIED HILO
Driver Co., Wilbur B.

MODUFLOW
Minneapolis-Honeywell Regulator Co.

MODULITE
Berndt-Bach, Inc.

MODULINE
Sprague Electric Co.

MODUTROL
Minneapolis-Honeywell Regulator Co.

MODU-WAVE
Sciaky Bros., Inc.

MOLDARTA
Westinghouse Electric Corp.

MOLDITE
National Moldite Co.

MOLDLOCK
American Brass Co.

MOLDTEX
Racon Electric Co.

MOLD-TITE
United Conquer Corp.

MOLECULE SQUEEZER
Robinette Co., W. C.

MONEL
The International Nickel Co., Inc.

MONISEAL
Magnetic Metals Co.

MONISEAL "444"
Carpenter Steel Co.

MON-KEY
Electric Eye Equipment Co.

MONOBAR
Tibbetts Industries, Inc.

MONOBLOC
Winchester Electronics Co.

MONOCOIL
Kupfrian Mfg. Co.

MONO-DRUM
Gorrell & Gorrell

MONOMOTORS
Redmond Co., Inc.

MONO-PAC
Beltone Hearing Aid Co.

MONOPHONE
Automatic Electric Co.

MONOPLEX
Shure Brothers, Inc.

MONOSET
Bristol Co., The

MONOSET
Telex, Inc.

MONOTUBE
Tuttle & Kift

MONTE CARLO
Televista Corp. of America

MORTEX
Moore Co., Howard J.

MOTORLITE
Ward Leonard Electric Co.

MOTOR WATCHMAN
Westinghouse Electric Corp.

MOT-O-TROL
Westinghouse Electric Corp.

MOTRON
Robinette Co., W. C.

MPB
Miniature Precision Bearings, Inc.

M-SCOPE
Fisher Research Lab.

MU
Acro Mfg. Co.

MUCHROHM
Magnetic Metals Co.

MULLARD
International Electronics Corp.

MUL-TEL
Brach Mfg. Corp.

MULTI-ANALYST
Electronic Instrument Co., Inc.

MULTICARDIOTRON
Electro-Physical Labs.

MULTICORE
British Industries Corp.

MULTICOUNTER
Atomic Instrument Co.

MULTICOUPLER
Amy, Aceves & King, Inc.

MULTIFLEX
Eagle Signal Corp.

MULTI-LOW-RANGE
Dillion & Co., Inc., W. C.

MULTI-MASTER
Precision Apparatus Co.

MULTIMET
Haynes Stellite Co.
Unit of Union Carbide & Carbon Corp.

MULTIMETER
Rawson Electrical Instrument Co.

MULTIPLANE
Lord Mfg. Co.

MULTIPLE SHOT
Gits Molding Corp.

MULTIPOT
Ford Engineering Co.

MULTIPOWER
E. A. Myers & Sons

MULTI-RECTIFIER
Green Electric Co., Inc.

MULTIROD
Belling & Lee, Ltd.

MULTISCALER
Atomic Instrument Co.

MULTISCOPE
Acme Telectronix Div.
NEA Service Inc.

MULTISOURCE
Applied Research Labs.

MULTI-SWAGE PROCESS
Bead Chain Mfg. Co.

MULTITROL
Ward Leonard Electric Co.

MULTIVIDEO
Industrial Television, Inc.

MULTIVISION
Industrial Television, Inc.

MULTIVISION SCREEN
House of Television, Inc.

MULTIVOLT
Ohmite Mfg. Co.

MUSIC MASTER
M. P. Concert Installations

MUSIC MASTER
Sonic Industries, Inc.

MUSIKING
Symphony Radio & Television Corp.

MUTED-STYLUS
Shure Brothers, Inc.

MYCALEX 400
Mycalex Corp. of America

MYCALEX 410
Mycalex Corp. of America

MYCALEX K
Mycalex Corp. of America

MYKAPLAST
United Condenser Corp.

MYKROY
Electronic Mechanics, Inc.

MYSTAPHONE
Taybern Equipment Co.

MYSTERY
Taybern Equipment Co.

MYVACENE-S
Distillation Products Industries

MYVAVAX-S
Distillation Products Industries

NA-ALD
Alden Products Co.

NALCO
National Lead Co.

NALCO
North American Electric Lamp Co.

NAMCO
National Acme Co.

NARCIOL
National Research Corp.

NASAT
Westinghouse Electric Corp.

NATCO
National Tel-Tronics Corp.

NATIONAL
Valco Mfg. Co.

NATVAR
National Varnished Products Corp.

NAUGAHYDE
U. S. Rubber Co.

NEMCO
National Electronic Mfg. Co.

N. E. M. S.
National Electrical Machine Shops, Inc.

NEOLAY
U. S. Rubber Co.

NE-O-LITE
General Cement Mfg. Co.

NEPEC
Centralab Div.,
Globe Union Inc.

NEUTRASEAL
Cook Electric Co.

NEYDIUM
Ney Co., J. M.

NEY-ORO
Ney Co., J. M.

NICAD
Nickel Cadmium Battery Corp.

NICHROME
Driver-Harris Co.

NICORO
Western Gold & Platinum Works

NILSTAIN
Driver Co., Wilbur B.

NILVAR
Driver-Harris Co.

999 "PLUS"
Handy & Harman

NIREX
Driver-Harris Co.

NITE-T-LITE
Littelfuse, Inc.

NITRON
Monsanto Chemical Co.
Plastics Div.

NITRONEAL
Baker & Co., Inc.

NOARK
Federal Electric Products Co.

NOBATRON
Sorensen & Co., Inc.

NOBLELOY
Continental Carbon, Inc.

NOBLEWEST
Noble & Westbrook Mfg. Co.

NOFLAME-COR
Cornish Wire Co.

NO FOME
L & R Mfg. Co.

NOISERASER
Minnesota Electronics Corp.

NOKORODE
Dunton Co., D. W.

NOMU
Magnetic Metals Co.

NON-LINK
Positive Lock Washer Co.

NO-OX
Walter L. Schott Co.

NORBIDE
Norton Co.

NORELCO
North American Philips Co., Inc.

NORLOC
Norton Labs., Inc.

NORTHEAST
Delco Appliance Div.
General Motors Corp.

NTC
Keystone Carbon Co., Inc.

N. U.
National Union Radio Corp.

NU-BLAC
Star Porcelain Co.

NU-BLOK
United Mfg. & Service Co.

NUCAMITE
National Union Radio Corp.

NUCLEOMETER
Radiation Counter Laboratories, Inc.

NUKEMITE
Nukem Products Corp.

NU PAMITE
National Union Radio Corp.

NU TIP
P. R. Mallory & Co., Inc.

NU-WAY
Hatheway Mfg. Co.

NWL
Nothelfer Winding Labs.

NU WRINKLE CAP
P. R. Mallory & Co., Inc.

NYFORM
Acme Wire Co.

NYLEX
Boston Insulated Wire & Cable Co.

NYLOK
Production Engrg. Co.

NYLON
du Pont de Nemours & Co., Inc., E. I.

NYLONITE
Plastic Wire & Cable Corp.

NYLON-ZIP
Waldes Kohinor Inc.

OAKWOOD
Osborn Products

OCTOIL
Eastman Kodak Co.

OHIOHM
Ohio Carbon Co.

OHMAX
Driver-Harris Co.

OHMOID
Wilmington Fibre Specialty Co.

OHM-SPUN
States Co.

OILDAG
Acheson Colloids Corp.

OILITE
Amplex Division Chrysler Corp.

OKLIP
Burndy Engineering Co., Inc.

OKOBESTOS
Okonite Co.

OKOGLASS
Okonite Co.

OKOLENE
Okonite Co.

OKOLITE
Okonite Co.

OKOPRENE
Okonite Co.

OKOSEAL
Okonite Co.

OLSON
Lipps, Edwin A.

OMNI-GLOW
Industrial Devices, Inc.

1000 SPAR
Standard Varnish Works

OPTIMATIC
Minneapolis-Honeywell Regulator Co.

OPTIMIKE
Instrument Development Laboratories, Inc.

OPTO-MATIC
Trico Fuse Mfg. Co.

ORACO
Oak Ridge Antennas Div. of
Video Television Inc.

ORIENTER
Lear, Inc.

ORTHOCHROM
Rohm & Haas Co.

ORTHOFILTER
Orthon Corp., The

ORTHOLITE
Rohm & Haas Co.

ORTHONIK
Westinghouse Electric Corp.

ORTHOSONIC
Electronic Labs., Inc.

OSAGE
Linick Chemical Co.

OSISO
Westinghouse Electric Corp.

OSCILLO-RECORD
Fairchild Camera & Instrument Corp.

OUNCER
United Transformer Corp.

OXYHEMOGRAPH
Photocon Research Products.

OXWELD
Linde Air Products Co.
Unit of Union Carbide & Carbon Corp.

O-Z
Belling & Lee, Ltd.

O-Z
Zernickow Co., O.

OZALID
General Aniline & Film Corp.

PACKMASTER
Radio Specialty Mfg. Co.

PAISOL
Paisley Products, Inc.

PAISTEX
Paisley Products, Inc.

PAISTIC
Paisley Products, Inc.

PAISTICK
Paisley Products, Inc.

PALINEY
Ney Co., J. M.

PAL
Palnut Co., Inc.

PAMARCO
Paper Machinery & Research, Inc.

PANADAPTOR
Panoramic Radio Products, Inc.

PANALYZOR
Panoramic Radio Products, Inc.

PANDEX
Westinghouse Electric Corp.

PANELTONE
Ansley Radio Corp.

PANELYTE
St. Regis Sales Corp.

PANORADIO
Panoramic Radio Products, Inc.

PANORAMSCOPE
Panoramic Radio Products, Inc.

PANOSCOPE
Panoramic Radio Products, Inc.

PANTO
Preis Engraving Machine Co.

PAPERITE
Acme Wire Co.

PARACORE
U. S. Rubber Co.

PARA-FLUX
Radio Music Corp.

PARAGON
Keuffel & Esser Co.

PARAPLEX
Rohm & Haas Co.

PARISTANOID
Parisian Novelty Co.

PASSMOUR
Pass & Seymour, Inc.

PATTERSON
 du Pont de Nemours & Co., Inc., E. I.
PDCP
 Phelps Dodge Copper Products Co.
P. E. C.
 Centralab Div.
 Globe Union Inc.
P. E. C.
 Precision Electronic Components Ltd.
PECO
 Pacific Electriccord Co.
PEE-WEE
 Mueller Electric Co.
PEERLESS
 Altec Lansing Corp.
PEERLESS
 National Vulcanized Fibre Co.
PEL-X
 Holliston Mills, Inc., The
PEM
 Penn Engineering & Mfg. Corp.
PENACOLITE
 Koppers Co., Inc.
PERFECT-O-CUT
 Tablet & Ticket Co.
PERKINS
 Westinghouse Electric Corp.
PERMACEL
 Industrial Tape Corp.
PERMACELL
 U. S. Rubber Co.
PERMADINE
 American Chemical Paint Co.
PERMAKAY
 Motorola, Inc.
PERMALLOY
 Arnold Engineering Co.
PERMANITE
 Foote Mineral Co.
PERMANITE
 I-T-E Circuit Breaker Co.
PERMA-POWER
 General Transformer Corp.
PERMAZINC
 Locke Incorporated
PERMENDUR
 Arnold Engineering Co.
PERMENORM
 Arnold Engineering Co.
PERMO-MAGNETIC
 Fidelity, Inc.
PFAN-TONE
 Pfanstiehl Chemical Co.,
 Metallurgical Div.
PHANO
 Dixon Crucible Co., Joseph
PHAOSTRON
 Stolle Engineering & Mfg. Co.
PHASEFORMER
 Eastern Specialty Co.
PHENOCOTE
 Wirt Co.
PHENOFLEX
 Dielectric Materials Co.
PHENOL FIBRE
 Taylor Fibre Co.
PHENOLITE
 National Vulcanized Fibre Co.
PHILHARMONIC
 Espey Mfg. Co., Inc.
PHIL-TROL
 Phillips Control Corp.
PHONOPHRAGMS
 Magnetic Metals Co.
PHONOSTROBE
 Berkshire Laboratories.
PHOS-COPPER
 Westinghouse Electric Corp.
PHOTACT
 Keuffel & Esser Co.
PHOTELOMETER
 Central Scientific Co.
PHOTO-ARC
 Peerless Photo Products
PHOTOLUX
 Westinghouse Electric Corp.
PHOTOPHONE
 Radio Corporation of America.
PHOTO-TROLLER
 Westinghouse Electric Corp.
PHOTOTRONIC
 Weston Electrical Instrument Corp.
PHOTOX
 Westinghouse Electric Corp.
PHOTRONIC
 Weston Electrical Instrument Co.
PICOPACK
 Telegraph Condenser Co., Ltd.
PIC-SYNC
 Fairchild Recording Equipment Co.
PIEZO-RAY
 Commercial Research Labs, Inc.
PILOTONE
 Pilot Radio Corp.
PILOTROL
 Bailey Meter Co.
PINHEAD
 Sprague Electric Co.
P-K
 Parker Kalon Corp.
PLASCAP
 P. R. Mallory & Co., Inc.
PLASKON ALKYD
 Plaskon Div., Libbey-Owens-Ford Glass Co.
PLAST-CORIRON
 Plastic Metals Division
 The National Radiator Co.
PLASTACELE
 du Pont de Nemours & Co., Inc. E. I.

PLAST-CORIRON
 Plastic Metals Div.,
 National Radiator Co., The.
PLASTICLEAN
 House of Television.
PLASTICON
 Plastic Wire & Cable Corp.
PLASTICORD
 Chester Cable Corp.
PLASTICOTE
 Chester Cable Corp.
PLASTI-GRIP
 Aircraft-Marine Products, Inc.
PLASTIK-707
 United Technical Laboratories.
PLASTILOKT
 Precision Paper Tube Co.
PLASTIMOLD
 Emerson Radio & Phonograph Corp.
PLAST-IRON
 Plastic Metals Division
 National Radiator Co., The.
PLASTITE
 Whitney Blake Co.
PLAST-MAGNETITE
 Plastic Metals Division
 National Radiator Co., The.
PLAST-MANGANESE
 Plastic Metals Division
 National Radiator Co., The.
PLAST-NICKEL
 Plastic Metals Division
 National Radiator Co., The.
PLAST-O-DIP
 Aerofil Products Co.
PLASTOK
 Richardson Co., The.
PLASTO PAK
 Standard Varnish Works.
PLASTRONICS
 Malco Co., Inc.
PLAST-SILICON
 Plastic Metals Division
 National Radiator Co., The.
PLAST-SPONGE
 Plastic Metals Division
 National Radiator Co., The.
PLAST-STEEL
 Plastic Metals Division
 National Radiator Co., The.
PLATE-LOK
 Boots Aircraft Nut Co.
PLATO
 Raytheon Mfg. Co.
PLAXPAK
 Plax Corp.
PLAYBACK
 Reeves Soundcraft Corp.
PLAYBOY
 Carbonneau Industries, Inc.
PLAYBOY
 Crosley Corp.
PLAYSALL
 Carbonneau Industries, Inc.
PLAYTIME
 Crosley Corp.
PLENTI-POWER
 Westinghouse Electric Corp.
PLEXENE
 Rohm & Haas Co.
PLEXICON
 Erie Resistor Corp.
PLEXIGLAS
 Rohm & Haas Co.
PLIABOOK
 Paisley Products, Inc.
PLIASTIC
 Paisley Products, Inc.
PLIATAB
 Paisley Products, Inc.
PLIOBOND
 Goodyear Tire & Rubber Co.
PLIOGRIP
 Goodyear Tire & Rubber Co.
PLIOLITE
 Goodyear Tire & Rubber Co.
PLIOTHERM
 Goodyear Tire & Rubber Co.
PLIO-TUF
 Goodyear Tire & Rubber Co.
PLIOVIC
 Goodyear Tire & Rubber Co.
PLUG-IN
 JFD Mfg. Co.
PLUS SOUND
 Pentron Corp., The
PLYA-SEAL
 Fafnir Bearing Co.
PLYMOUTH
 Meck Industries, John.
PLYOPHEN
 Reichhold Chemicals, Inc.
PN
 Brush Development Co.
POCKETSCOPE
 Waterman Products Inc.
POINTARC
 Western Union Telegraph Co.
POLAROID
 Pioneer Scientific Corp.
POLATENNA
 Capehart-Farnsworth Corp.
POLATRON
 Capehart-Farnsworth Corp.
POLECTRON
 Antara Products Div.,
 General Dystuff Corp.

POLICARB
 Driver Co., Wilbur B.
POLIMERATOR
 Short Wave Plastic Forming Co.
POLINEAR RECORDER
 Sound Apparatus Co.
POLYCO
 Polymer Corp., The.
POLYFLEX
 Plax Corp.
POLY-METER
 Sylvania Electric Products, Inc.
POLY-PEDANCE
 Standard Transformer Corp.
POLYPHONIC SOUND
 Universal Broadcast Equipment Corp.
POLYPLASTIC
 Standard Varnish Works.
POLYRANGER
 Sensitive Research Instrument Corp.
POLYTHENE
 du Pont de Nemours & Co., Inc., E. I.
POLYTHERM
 Dielectric Materials Co.
POLY-VISO
 Sanborn Co.
POLYWELD
 American Phenolic Corp.
PORTA-FLEXER
 Miskella Infra-Red Co.
PORTAPOWER
 Cornell-Dubilier Electric Corp.
PORTAPOWER
 Electronic Labs., Inc.
PORTA-POWER
 General Transformer Corp.
PORTENTIOTROL
 Wheelco Instruments Co.
PORT-O-REEL
 Industrial Electrical Works.
PORT PILOT
 Bludworth Marine Div.,
 National-Simplex-Bludworth, Inc.
PORTRAYA
 Haloid Co., The.
PORTRONIC
 Photographic Products, Inc.
POST-LITE
 Littelfuse, Inc.
POTENTIALS
 Wheelco Instruments Co.
POWDERMET
 Powdered Metal Products Corp.
POWDIRON
 Bound Brook Oil-Less Bearing Co.
POWER BOOSTER
 McCollipin-Christie Corp.
POWEREEL
 Industrial Electrical Works.
POWERFAC
 Schweitzer, Inc., Peter J.
POWER-FLEX
 Dumore Co., The.
POWER STREAK
 American Electric Cable Co.
POWER VOICE
 Taybren Equipment Co.
POWERSTAT
 Superior Electric Co.
POWMINCO
 Powhatan Mining Co.
POWRMIKE
 University Loudspeakers, Inc.
POWR-PAKT
 Alliance Mfg. Co.
PRD
 Polytechnic Research & Development Co., Inc.
PRECEPTON
 Sonotone Corp.
PRECIPITRON
 Westinghouse Electric Corp.
PRECISIONAIRE
 Sheffield Corp.
PRECISIONER
 Malco Co., Inc.
PRECISION-GAUGED
 Precision Products Co.
PREGWOOD
 Formica Co.
PREMIER-TONE
 Premier Metal Etching Co.
PRESET
 Bristol Co., The.
PRESSMASTER
 Heiland Research Corp.
PRESSOVAC
 Central Scientific Co.
PRESSURE
 Buchanan Electrical Products Corp.
PRESSUREGRAPH
 Electro Products Labs., Inc.
PRES-SURE-SPLICE
 Buchanan Electrical Products Corp.
PRES-SURE-TOOL
 Buchanan Electrical Products Co.
PRESSURETROL
 Minneapolis-Honeywell Regulator Co.
PRESTEEL
 Worcester Pressed Steel Co.
PRESTITE
 Westinghouse Electric Corp.
PREST-O-LITE
 Linde Air Products Co.
 Unit of Union Carbide & Carbon Corp.
PREST-O-WELD
 Linde Air Products Co.
 Unit of Union Carbide & Carbon Corp.

PRESSWOOD
Masonite Corp.

PRESTROL
Gerett Corp., M. A.

PRIVATE EYE
Television Utilities Corp.

PRMCO
Ports Mfg. Co.

PRODAG
Acheson Colloids Corp.

PRODELIN
Products Development Co., Inc.

PRODUCTIMETERS
Durant Manufacturing Co.

PROFESSIONAL
Decimeter, Inc.

PROGAR
Langevin Co., Inc.

PROKAR
Sprague Electric Co.

PROJECTALL
Tressel Television Productions, Inc.

PROMATIC
General Control Company.

PROMCO
Progressive Mfg. Co.

PROPELLAIR
Robbins & Myers, Inc.

PROTECTOGL0
Minneapolis-Honeywell Regulator Co.

PROTECTORELAY
Minneapolis-Honeywell Regulator Co.

PROTECTRON
Brinnell Company, The.

PROTELGRAM
North American Philips Co., Inc.

PROVAC
Electronic Designs, Inc.

PRYSTAL
Catalin Corp. of America.

P. S.
Motorola, Inc.

P & S
Pass & Seymour, Inc.

PULSESCOPE
Waterman Products.

PURATONE
Brach Mfg. Corp.

PUREBON
Pure Carbon Co.

PURIFIL
Electric Eye Equipment Co.

PUROX
Linde Air Products Co.
Unit of Union Carbide & Carbon Corp.

PUSH-PULL
James Vibrapowr Co.

PWC
Plastic Wire & Cable Corp.

PYGMY
Vulcan Electric Co.

PYRALIN
du Pont de Nemours & Co., Inc. E. I.

PYRANOL
General Electric Co.

PYRA-SHELL
Shoe Form Co., Inc.

PYREX
Corning Glass Works.

PYROCON
Illinois Testing Labs., Inc.

PYRODYN
Skydyne, Inc.

PYROLANCE
Illinois Testing Labs., Inc.

PYROMASTER
Bristol Co., The.

PYROMATIC
Welwyn Electronic Components, Inc.

PYROTESTER
Electro-Tech Equipment Co.

PYROTRON
Bailey Meter Co.

PYROVAC
Eitel-McCullough, Inc.

Q-LACE
Guthman Inc., Edwin I.

Q-MAX
Communication Prods. Co., Inc.

QIKLUG
Burndy Engineering Co., Inc.

QIKTAP
Burndy Engineering Co., Inc.

QUAD-EX
Telrex Inc.

QUADREX
Westinghouse Electric Corp.

QUADRILINE
Radio Engineering Labs., Inc.

QUADROCONDEX
Westinghouse Electric Corp.

QUANTOMETERS
Applied Research Laboratories.

QUARTZ Q
Millen Mfg. Co., James.

QUELARC
Pyle-National Co.

QUICKLAG
Westinghouse Electric Corp.

QUICK-LOCK
Simmons Fastener Corp.

QUICK-RIG
JFD Mfg. Co.

QUIETONE
Cornell-Dubilier Electric Corp.

QUIK-CALL
Motorola, Inc.

QUIK-LABELS
Brady Co., W. H.

QUIK-MASKS
Brady Co., W. H.

QUIK-SHOT
Kemode Mfg. Co., Inc.

QUIK-SIGN
Brady Co., W. H.

QUINORGO
Johns-Manville Sales Corp.

QUINTERRA
Johns-Manville Sales Corp.

"R" MONEL
International Nickel Co., Inc., The.

RACON BROADBAND
Racon Electric Co.

RAD-A-COR
Magnetic Core Corp.

RADAIR
Bassett Inc., Rex.

RADALARM
Communications Co., Inc.

RADAMETER
Raytheon Mfg. Co.

RADARANGE
Raytheon Mfg. Co.

RADELIN
U. S. Radium Corp.

RADEX
Boston Insulated Wire & Cable Co.

RADIOCARB A
Driver Co., Wilbur B.

RADIOEAR
Myers & Sons, E. A.

RADIOFOCAL
Lord Mfg. Co.

RADIO INDUCTOGRAPH
Inductograph Lab.

RADIOHM
Driver-Harris Co.

RADIOHM
Centralab Div. of
Globe-Union, Inc.

RADIOLA
Radio Corp. of America.

RADIOMARINE
Radio Corp. of America.

RADIOPAK
Kaar Engineering Co.

RADIO-PILOT
Fisher Research Lab.

RADIOSURG
Electronic Surgical Equipment Co., Inc.

RADIOTECHNIC
Peirce Wire Recorder Corp.

RADIOTHERM
Westinghouse Electric Corp.

RADIOTRON
Radio Corp. of America.

RADOT
Press Wireless Mfg. Co., Inc.

RAILITE
Amplex Div.
Chrysler Corp.

RAKSCOPE
Waterman Products.

RANCOSTAT
Ranco, Inc.

RANGE LUGS
Frankel Connector Co.

RANGE MASTER
Bradshaw Instruments Co.

RANGER
Electronic Specialty Co.

RANGER
JFD Mfg. Co.

RANGER
Sorensen & Co., Inc.

RANGER
Westinghouse Electric Corp.

RANGERECD
Rangertone, Inc.

RANGEREORDER
Ranoertone, Inc.

RANGESPLICES
Frankel Connector Co.

RANGETAPS
Frankel Connector Co.

RATOSIGHTS
Fisher & Porter Co.

RATOSLEEVEES
Fisher & Porter Co.

RATOTRONIC
Fisher & Porter Co.

RAUTOMATIC
American Scientific Co.

RAYCHRONIX
Radioactive Products, Inc.

RAYCHRONOMETER
Radioactive Products, Inc.

RAY-DEC
Flader, Inc., Fredric.

RAYDIST
Hastings Instrument Co.

RAYFUSER
Radioactive Products, Inc.

RAYMERSON
Trumbull Electric Mfg. Co.

RAYOFLEX
Schott Co., Walter L.

RAYONIC
Waterman Products Co., Inc.

RAYPHOTO
Times Facsimile Corp.

RAYSONDE
Friez Instrument Div.
Bendix Aviation Corp.

RAYTHEON-BELMONT
Belmont Radio Co., Div. Raytheon Mfg. Co.

RAYTHERM
Raytheon Mfg. Co.

RAY-X
Raytheon Mfg. Co.

R B & W
Russell, Burdsall & Ward Bolt and Nut Co.

R/C
Radio Condenser Co.

RCA
Radio Corp. of America.

RCA VICTOR
Radio Corp. of America.

REAC
Reeves Instrument Corp.

REACTRON
United Condenser Corp.

READO
Crosley Corp.

REBEL
Klipsch & Associates.

RECEPTRON
Howard Mfg. Corp.

RE-CIRK-IT
Heinemann Electric Co.

RECITALIST
Rek-O-Kut Co.

RECO
Rectifier Engineering Co.

RECO
Reynolds Electric Co.

RECORDALL
Miles Reproducer Co., Inc.

RECORDIO
Wilcox-Gay Corp.

RECORDION
Wilcox-Gay Corp.

RECORDIOPOINT
Wilcox-Gay Corp.

RECORDISES
Recordisc Corp.

RECORD-LIFE
Minnesota Electronics Corp.

RECORDO
Wilcox-Gay Corp.

RE-CORD-O-FONE
Bell Sound Systems, Inc.

RECTICHARGER
Raytheon Mfg. Co.

RECTIFIER
Raytheon Mfg. Co.

RECTIGON
Westinghouse Electric Corp.

RECTIGRAPH
Haloid Co., The.

RECTOMATIC
Westinghouse Electric Corp.

RECTOPLATER
Mallory & Co., Inc., P. R.

RECTOPOWER
Mallory & Co., P. R.

RECTOSTARTER
McColpin-Christie Corp.

RECTOSTARTER
Mallory & Co., P. R.

RECTOTRUCK CHARGER
Mallory & Co., P. R.

RECTOX
Westinghouse Electric Corp.

RED FLASH
Enthoven & Sons, Ltd., H. J.

REDFLASH
Vaco Products Co.

RED HEAD
Blaco Manufacturing Co.

RED HEAD
Girdler Corp.

RED LETTER
Ruby Chemical Co.

RED SEAL
Radio Corporation of America.

RED STREAK
Brown-Bridge Mills, Inc.

REEVELEC
Reeve Electronics, Inc.

REFLECTAR
Back Video Corp., F. G.

REFLECTOGAGE
Sperry Products, Inc.

REFLECTOSCOPE
Sperry Products, Inc.

REFRACTAL0Y
Westinghouse Electric Corp.

REGENCY
I.D.E.A.

REGENT
Duotone Co., Inc.

REGOHM
Electric Regulator Corp.

REGULITE
Ward Leonard Electric Co.

REKORDER
Gorrell & Gorrell.

REL
Radio Engineering Labs., Inc.

RELATROL
Automatic Temperature Control Co.

RELAYMATIC
Kellogg Switchboard & Supply Co.

RELIO
U. S. Rubber Co.

REMACO
Clarkstan Corp.

REMAILLOY
Arnold Engineering Co.

REMBRANDT
Remington Radio Corp.

REMOTE-O-CABLE
 JFD Mfg. Co.
REN
 Nebel Lab., R. E.
REPEATER
 Kemlite Labs.
REPUBLIC
 Commodore Record Co.
RESIGUM
 Paisley Products Inc.
RESIMENE
 Monsanto Chemical Co.
 Plastics Div.
RESIN-FIVE
 Kester Solder Co.
RESINITE
 Precision Paper Tube Co.
RESINOX
 Monsanto Chemical Co.
 Plastics Div.
RESI-RAP
 Paisley Products Inc.
RESISTOL
 Collyer Insulated Wire Co.
RETRAX
 Roanwell Corp.
REVERSIT
 Rattan Mfg. Co., The.
REX
 Crucible Steel Co. of America.
REX
 Shure Brothers, Inc.
REXFLEX
 Chicago Metal Hose Corp.
REXON
 Hamilton Kent Mfg. Co.
REXTUBE
 Chicago Metal Hose Corp.
REXVANE
 Westinghouse Electric Corp.
REXWELD
 Chicago Metal Hose Corp.
REZISTAL
 Crucible Steel Co. of America.
RHEOTROL
 Wheelco Instruments Co.
RHINOBESTOS
 Westinghouse Electric Corp.
RHOMAX
 Magnetic Metals Co.
RHOMU
 Magnetic Metals Co.
RHONITE
 Rohm & Haas Co.
RHYTHMASTER
 Rek-O-Kut Co.
RIBFLEX
 Ward Leonard Electric Co.
RIBOHM
 Ward Leonard Electric Co.
RICHELAIN
 Richardson Co., The.
RIG-FAST
 Oak Ridge Products Mfg. Div. of Video
 Television, Inc.
RINKOLIN
 Standard Varnish Works.
R. I. P.
 Westinghouse Electric Corp.
RITEOHM
 Ohmite Mfg. Co.
R & M
 Robbins & Myers, Inc.
R M B
 Landis & Gyr, Inc.
RMC
 Radio Materials Corp.
RME
 Radio Mfg. Engineers, Inc.
RMS
 Radio Merchandise Sales, Inc.
ROBOLITES
 Universal Microphone Co.
ROBOTROL
 Reliance Automatic Lighting Co.
ROEBX
 Roebing's Sons Co., John A.
ROECLAD
 Roebing's Sons Co., John A.
ROEGLAS
 Roebing's Sons Co., John A.
ROEPLASTIC
 Roebing's Sons Co., John A.
ROEPRENE
 Roebing's Sons Co., John A.
ROGER
 Roanwell Corp.
ROL-TOP
 Boots Aircraft Nut Corp.
ROLLPINS
 Elastic Stop Nut Corp.
ROTABRAKE
 Lear, Inc.
ROTALYZER
 Kay Electric Co.
ROTA-TOWER
 Easy-Up Tower Co.
ROTO-BEAM
 Gordon Specialties Co.
ROTO BEAM
 Kings Electronics Corp.
ROTO-COUNT
 Automatic Temperature Control Co., Inc.
ROTO-DISPLAY KING
 Gale Dorothea Mechanisms
ROTO FORMER
 Westinghouse Electric Corp.
ROTO-LOCK
 Simmons Fastener Corp.

ROTMATIC
 Johnson Co., E. F.
ROTOMOUNT
 Premax Products Div.
 Chisholm-Ryder, Inc.
ROTOTROL
 Westinghouse Electric Corp.
ROTO-VISION
 Illinois Wood Products Corp.
RO-TRAN
 Rome Cable Corp.
ROYAL
 General Lead Batteries Co.
ROYAL
 U. S. Rubber Co.
ROYAL CORD
 U. S. Rubber Co.
ROYAL GOLD
 U. S. Rubber Co.
ROYAL JEWEL
 Jensen Industries, Inc.
ROYAL MASTER
 U. S. Rubber Co.
ROYALITE
 U. S. Rubber Co.
R P C
 Resistance Products Co.
R S M C
 Radio Specialty Mfg. Co.
R T L
 Peirce Wire Recorder Corp.
RUBALT
 Hague & Co., Alfred.
RUBCORD
 U. S. Rubber Co.
RUB-EROK
 Richardson Co., The.
RUBSEC
 U. S. Rubber Co.
RUB-TEX
 Richardson Co.
RUBYFLUID
 Ruby Chemical Co.
RUCCO
 Ruby Chemical Co.
RUF KOAT
 General Cement Mfg. Co.
RUSH
 Eraser Co., Inc.
R V
 Clarkstan Corp.
RYERTEX
 Ryerson & Son, Inc., Joseph T.
SAFE-T-GLOW
 Brach Mfg. Corp.
SAFE-T-PLUG
 Industrial Devices, Inc.
SAFE-T-PLUG
 Littelfuse Inc.
SAFE-T-SPARKY
 Littelfuse Inc.
SAFE-T-VOICE
 Z & W Machine Products, Inc.
SAFLEX
 Square D Co.
SAFLEX
 Monsanto Chemical Co.
SAL BRICK
 American Solder & Flux Co.
SANACOUSTIC
 Johns-Manville Sales Corp.
SANFORD-BENNET
 Rubicon Co.
SANITEX
 Daniels, Inc., C. R.
SARAN
 Dow Chemical Co.
SAUTER
 Cramer Co., Inc., R. W.
SAV-A-SHAFT
 National Union Radio Corp.
S/B
 Vaco Products Co.
SCALE-O-MATIC
 Technical Associates.
SCHENCK
 Ferner Co., R. Y.
SCPOLUG
 Burndy Engineering Co., Inc.
SCOTCH
 Minnesota Mining & Mfg. Co.
SCOTTIE
 Pemler Co., Ltd.
SEALDOHM
 Daven Co.
SEALEX
 General Ceramics & Steatite Corp.
SEALNUT
 Radio Frequency Labs., Inc.
SEAL-O-FLANGE
 Communication Prods. Co., Inc.
SEALSTIX
 Central Scientific Co.
SELECTO-CALL
 Federal Telephone & Radio Corp.
SELECTO-PHONE
 Kelloco Switchboard & Supply Co.
SELECTOVISION
 Communication Measurements Lab. Inc.
SELECTRO-PLATERS
 Green Electric Co., Inc.
SELETRON
 Radio Receptor Co.
SELFLUBE
 Keystone Carbon Co., Inc.
SEL-REX
 Bart-Messing Corp.
SEMCO
 Stolle Engineering & Mfg. Co.

SEMS
 Lamson & Sessions Co.
SENSATHERM
 Mercoid Corp.
SENSICON
 Motorola Inc.
SENSITROL
 Weston Electrical Instrument Corp.
SENSITRON
 Weston Electrical Instrument Corp.
SENTINEL
 Photobell Company.
SENTINEL
 Westinghouse Electric Corp.
SENTRY-LITE
 Hobby & Brown Mfg. Corp.
SEPIATONE
 Frederick Post Co.
SERRASOID
 Radio Engineering Labs., Inc.
SERVATRON
 Raytheon Mfg. Co.
SERVICE-MIKE
 Cornell-Dubilier Electric Corp.
SERVIT
 Burndy Engineering Co., Inc.
SERVOBOARD
 Servo Corp. of America.
SERVOFLIGHT
 Servo Corp. of America.
SERVOGRAPH
 Fielden Electronics Inc.
SERVOGRAPH
 Servo-Tek Products Co.
SERVOSCOPE
 Servo Corp. of America.
SERVOSYNC
 Servo Corp. of America.
SERVOSYNTH
 Servo Corp. of America.
SERVOTHERM
 Servo Corp. of America.
SERV-RITE
 Gordon Co., Claud S.
SESCO
 Sessions Clock Co.
SETKO
 Set Screw & Mfg. Co.
SEVEN LEAGUES AHEAD
 Thermador Electric Mfg. Co.
SHADOWCONTROL
 Autotron Co., The.
SHADOWCOUNT
 Autotron Co., The.
SHADOWMASTER
 Autotron Co., The.
SHAKEPROOF
 Illinois Tool Works.
SHANNON GLOW
 Shannon Luminous Materials Co.
SHAVEX
 Electronic Specialty Co.
SHELDON
 Jackson Industries, Inc.
SHIELD BRAND
 Mitchell-Rand Insulation Co., Inc.
SHURFLO
 Anchor Metal Co.
SHUR GRIP
 Parker-Kalon Corp.
SHURITE
 J. B. T. Instruments Inc.
SHURLOCK
 Pass & Seymour, Inc.
S. I. E. CO.
 Sherman Industrial Electronics Co.
SIGHT METER
 Weston Electrical Instrument Co.
SIGNA-FLO
 Buffalo Electronics Corp.
SIGNALINER
 Feiler Engineering Co.
SILANEAL
 Dow Corning Corp.
SILASTIC
 Dow Corning Corp.
SILCAZ
 Electro Metallurgical Co.
 Unit of Union Carbide & Carbon Corp.
SILENTBLOC
 General Tire & Rubber Co., The.
 Silentbloc Div.
SILENT SENTINEL
 Westinghouse Electric Corp.
SILFLEX
 Varflex Corp.
SIL-FOS
 Handy & Harman.
SILKENITE
 Acme Wire Co.
SILVALOY
 American Platinum Works.
SILVALOY
 Linde Air Products Co.
 Unit of Union Carbide & Carbon Corp.
SILVERCEL
 Yardney Electric Corp.
SILVERCOTE
 Little Falls Alloys, Inc.
SILVER LINE
 Speedway Mfg. Co.
SILVERMIKE
 Condenser Corp. of America.
SILVER-Q
 Decimeter, Inc.
SILVERSTAT
 Westinghouse Electric Corp.
SILVERTONE
 Colonial Radio Corp.

SIMPAC
Westinghouse Electric Corp.

SIMPLI-FLEX
Radiart Corp., The.

SIMPLYROL
Assembly Prods., Inc.

SIXTY
Shure Brothers.

SKAN
G-M Laboratories.

SKANASCOPE
Skaneateles Mfg. Co., Inc.

SKL
Spencer-Kennedy Labs., Inc.

SKORESIN
Skoning Corp.

S. K. S.
Paisley Products, Inc.

SKYFONE
Hallicrafters Co.

SKYGUIDE
Philco Corp.

SKY-KING
J. F. D. Mfg. Co.

SKYPLY
Skydyne, Inc.

SKYROD
Belling & Lee, Ltd.

SKYTOWER
Belling & Lee, Ltd.

SKY-WEIGHT
Continental Electronics, Ltd.

SLIDEOHM
Aerovox Corp.

SLIPSTICK
Decimeter, Inc.

SLIPSYN
Westinghouse Electric Corp.

SLO-BLO
Littelfuse, Inc.

SMALL UNIDYNE
Shure Brothers, Inc.

SMITH-NATHANIEL BALDWIN
Consolidated Radio Products Co.

SMOKGAGE
Ess Specialty Corp.

SMUTBATH
Special Chemicals Co.

SMZ
Electro Metallurgical Co.
Unit of Union Carbide & Carbon Corp.

SNAP-LOCK
National Acme Co.

SNAP-LOCK
Oak Ridge Products Mfg. Div. of
Video Television, Inc.

SNIFFER
Nuclear Instrument & Chemical Corp.

SODEREZE
Phelps Dodge Copper Products Co.

SOLDALLOY
Mallory & Co., Inc., P. R.

SOLDERALL
Brach Mfg. Corp.

SOLDER MASTER
Hexacon Electric Co.

SOLDERLITE
Weller Mfg. Co.

SOLISTRAND
Aircraft-Marine Products Inc.

SOLOTRON
Modern Hearing Aids Laboratory, The.

SOLU-BRIDGE
Industrial Instruments, Inc.

SONACTOR
Kay Electric Co.

SONA-GRAPH
Kay Electric Co.

SONALATOR
Kay Electric Co.

SONARMETER
Raytheon Mfg. Co.

SONIC EAR
Taybern Equipment Co.

SONOCLE
Sonotone Corp.

SONODYNE
Shure Brothers, Inc.

SONO-PROBE
Aircraft Electronics Associates, Inc.

SONOWEAR
Sonotone Corp.

SOS
Chaslyn Co.

SOUNDCASTER
Operadio Mfg. Co.

SOUNDEX
Proctor Soundex Corp.

SOUND CELL
Brush Development Co.

SOUND ISOLATION BLANKET
Johns-Manville Sales Corp.

SOUNDMIRROR
Brush Development Co.

SOUNDREEL
Simpson Mfg. Co., Inc., Mark.

SOUNDTRAP
Miles Reproducer Co., Inc.

SOUNDVIEW
Tech-Master Products Co.

SOUND-ZORBER
Finn & Co., Inc., T. R.

SPARKFLASH
Triumph Mfg. Co.

SPARX
McMurdo Silver Co., Inc.

SPALDITE
Spaulding Fibre Co., Inc.

SPAULDO
Spaulding Fibre Co., Inc.

SPEAK-E-Z
Airlectron, Inc.

SPECO
Pfanstiehl Chemical Co.

SPECO
Special Products Co.

SPECORAK
Special Chemicals Co.

SPECPLATER
Special Chemicals Co.

SPEC-POWER
National Spectrographic Labs., Inc.

SPECTABLE
Special Chemicals Co.

SPECTRIFIER
Special Chemicals Co.

SPECTROPHOTOMETER
Central Scientific Co.

SPEECH MASTER
Jensen Mfg. Co.

SPEED CLAMPS
Tinnerman Products Inc.

SPEED CLIPS
Tinnerman Products Inc.

SPEE-DEE
Peck & Harvey.

SPEDEX
General Cement Mfg. Co.

SPEED IRON
Weller Mfg. Co.

SPEED NUTS
Tinnerman Products Inc.

SPEEDOMAX
Leeds & Northrup Co.

SPEEDSORT
Associated Research, Inc.

SPEED TOOLS
Speedway Mfg. Co.

SPEED-X
Johnson Co., E. F.

SPEKALUMINITE
Special Chemicals Co.

SPEKLEEN
Special Chemicals Co.

SPEKWITE
Special Chemicals Co.

SPEKYELLO
Special Chemicals Co.

SPENCER
American Optical Co.

SPERRY DUPLEX
Sperry Gyroscope Co.
Div. of The Sperry Corp.

SPERRY REFLECTOGAGE
Sperry Products, Inc.

SPERRY REFLECTSCOPE
Sperry Products, Inc.

SPIN-HEX
Vaco Products Co.

SPINLAB
Special Instruments Laboratories Inc.

SPINTITE
Stevens-Walden Inc.

SPIRALENE
Surprenant Mfg. Co.

SPIRALOCK
Production Engrg. Co.

SPIRALON
Surprenant Mfg. Co.

SPIRAMEG
Sprague Electric Co.

SPIRASHIELD
Muter Co.

SPLICE CAP
Buchanan Electrical Products Corp.

SPOTTING SCOPE
Argus, Inc.

SPRAY
Paisley Products Inc.

SPRING-ACTION
Sheldon Electric Co.
Div. of Allied Electric Products, Inc.

SPRING-KING
Gorrell & Gorrell.

SPRING-LIFE
Cook Electric Co.

SPRING-LOCK
Simmons Fastener Corp.

SPRING-LOCK ANTENNA
Oak Ridge Products Mfg. Div. of
Video Television, Inc.

SQUEEZ-GRIP
C-O Two Fire Equipment Co.

SQUEEZE-LOCK
Buchanan Electrical Products Corp.

SR-4
Baldwin-Lima-Hamilton Corp.

SRHT
Boston Insulated Wire & Cable Co.

STABILFLO
Foxboro Co.

STABILINE
Superior Electric Co.

STABILOG
Foxboro Co.

STACO
Standard Electrical Products Co.

STA-KON
Thomas & Betts Co., Inc.

STANCOR
Standard Transformer Corp.

STANDARD
New York Solder Co.

STANDARD
Shure Bros, Inc.

STANDARD ARROW
Bludworth Marine Div.,
National-Simplex-Bludworth, Inc.

STANDARD BINNACLE
Bludworth Marine Div.,
National-Simplex-Bloodworth, Inc.

STANDARD SIX
Bludworth Marine Div.,
National-Simplex-Bludworth, Inc.

STANDATROL
Bailey Meter Co.

STANDLAC
Standard Varnish Works.

STANDO
Sticht Co., Herman H.

STANELCO
Standard Telephones & Cables Ltd.

STANTEL
Standard Telephones & Cables Ltd.

STANTOX
Standard Varnish Works.

STAN-TRAN
Stanwyck Winding Co.

STAR
Duotone Co., Inc.

STAR J
Haynes Stellite Co.
Unit of Union Carbide & Carbon Corp.

STARKLINE
Stark Sound Engr. Corp.

STATISCOPE
Minerallac Electric Co.

STATOMIC
Motorola Inc.

STA-TRAN
Stanwyck Winding Co.

STEEL-SET
Paisley Products, Inc.

STENO
Crescent Industries, Inc.

STERILAIRE
Ultra-Violet Products Inc.

STERILAMP
Westinghouse Electric Corp.

STERILZONE
Dallons Labs.

STERLINE
Cossor (Canada), Ltd.

STERLING CABLES
Cossor (Canada) Ltd.

STETHERTRON
Maico Co., Inc.

STETHOSCOPE
Feiler Engineering Co.

STEVENS
Leupold & Stevens Instruments, Inc.

STEWOVOX
Berlant Associates.

STIKON
Ruge-de Forest, Inc.

STILBEST
Linick Chemical Co.

STOKATIMER
Mercoind Corp.

STONEHART
Titeflex, Inc.

STRAINALYZER
Electronic Tube Corp.

STRATOGRAPH
Panoramic Radio Products, Inc.

STRATOLLNET
Shure Brothers

STRATOPAX
Cook Electric Co.

STRATOSCOPE
Panoramic Radio Products, Inc.

STRATOVISION
Westinghouse Electric Corp.

STRESSITE
Amplex Div. Chrysler Corp.

STRING-A-LITE
Joy Mfg. Co.

STRIPMASTER
Ideal Industries, Inc.

STRIPOHM
Ward Leonard Electric Co.

STRIPSOL
Paisley Products, Inc.

STROBOCONN
Conn. Ltd., C. G.

STROBDYNE
Sperry Gyroscope Co. Div. of The Sperry Corp.

STROBOFLASH
General Radio Co.

STROBOLUX
General Radio Co.

STROBOTAC
General Radio Co.

STROWDER
Automatic Electric Co.

STRUX
du Pont de Nemours & Co., Inc., E. I., Plastics Dept.

STUPALITH
Stupakoff Ceramic & Mfg. Co.

STURTEVANT
Westinghouse Electric Corp.

STYRALOY
Dow Chemical Co.

STYRAMIC
Monsanto Chemical Co.

STYROFOAM
Dow Chemical Co.

STYROL AC
Standard Varnish Works.

STYRON
Dow Chemical Co.

SUB-CYCLE
Lorain Products Corp.

SUNFLASH
Kemlite Labs.

SUNSWITCH
Ripley Co., Inc.

SUPER-BEAM
JFD Mfg. Co.

SUPER DAVOHM
Daven Co.

SUPER EX.
Telrex Inc.

SUPERFLAKE
Superior Flake Graphite Co.

SUPERIOR
Radiart Corp.

SUPERMALLOY
Arnold Engineering Co.

SUPER-OILITE
Amplex Div. Chrysler Corp.

SUPER PRO
Hammarlund Mfg. Co.

SUPER Q
Guthman, Inc., Edwin I.

SUPERSEC
U. S. Rubber Co.

SUPERSONIC
Dzus Fastener Co., Inc.

SUPER SONIC
Sonic Industries, Inc.

SUPERSONIC REFLECTOSCOPE
Sperry Products Inc.

SUPER SPEED
Enthoven & Sons, Ltd., H. J.,

SUPER TRACER
Precision Electronics.

SUPERVAC
Central Scientific Co.

SUPER-VIEW
Brach Mfg. Corp., L. S.

SUPERWIRE
Audar Inc.

SUPER-X
Camburn, Inc.

SUPER-X
Telrex, Inc.

SUPER VEE
Radiart Corp., The

SUPREME
Aim Industries.

SUPREME
Grant Pulley & Hardware Co.

SUPRO
Valco Mfg. Co.

SURCO
Surprenant Mfg. Co.

SURFLENE
Surprenant Mfg. Co.

SURFLON
Surprenant Mfg. Co.

SURE FLUX
New York Solder Co.

SURFACE-ANALYZER
Brush Development Co.

SURFEX
Pass & Seymour, Inc.

SURFLEX
Surprenant Mfg. Co.

SURGYTHERM, JR.
Wappler, Inc.

SWEATLESS
Paisley Products Inc.

SWEET
Jensen Industries, Inc.

SWELTERPROOF
Roanwell Corp.

SWING-WA
Trumbull Electric Mfg. Co.

SWITCH-LITE
Littelfuse, Inc.

SWITCH-O-LITE
Hoffman Engrng. Corp.

SYLPHON
Fulton Sylphon Div., Robertshaw-Fulton Controls Co.

SYLVALOY
Driver Co., Wilbur B.

SYMPHONY MASTER
Monitor Products Co.

SYNCHRO-CHEK
Ionic Electronic Equipment Co.

SYNCHRO-METER
Bailey Meter Co.

SYNCHRO-SPECIAL
Heiland Research Corp.

SYNCHRON
Hansen Mfg. Co.

SYNCHRONIZED
Self Winding Clock Co.

SYNCHRONODE
Crosley Corp.

SYNCHROTROL
Westinghouse Electric Corp.

SYNCHRO-VALVE
Bristol Co., The

SYNCRGEGARS
U. S. Electrical Motors, Inc.

SYNCROLL
Fairchild Recording Equipment Co.

SYNCRONMARKER
Electro Products Labs.

SYNCHRO-SWEEP
Oak Ridge Products Mfg. Div. of
Video Television, Inc.

SYNCTRON
Dormitzer Electric Co., Inc.

SYNITE
Arco Co.

SYNKOTE
Plastoid Corp.

SYNRUB
U. S. Rubber Co.

SYNTHINOL
Rome Cable Corp.

SYNTHITE
Dolph Co., John C.

SYNTHO
Electro Chemical Engineering Co.

SYNTHOGRAPHIC
Synthane Corp.

SYNTHOLVAR
Variflex Corp.

SYNVAREN
Synvar Corp.

SYNVARITE
Synvar Corp.

SYNVAROL
Synvar Corp.

SYROCWOOD
Syracuse Ornamental Co., Inc.

20th CENTURY
Electronic Devices Co.

T 9
Edison Electronic Co.

TABBY
Division Lead Co.

TACO
Technical Appliance Corp.

TAG
Weston Electrical Instrument Corp.

TAKK-TRON
Takk Corp.

TAP
Continental Screw Co.

TAPE-O-GRAPH
Audio Industries

TAPE RECORDER
Ampex Electric Corp.

TAPER-TONE
Acton Co., H. W.

TAPE TITE
Paisley Products Inc.

TAPETONE
Broadcasting Program Service

TAPMASTER
Sheldon Electric Co. Div. of Allied Electric Products,
Inc.

TARRYTRON
Cook Electric Co.

TATTELITE
Littelfuse, Inc.

T.C.C.
Telegraph Condenser Co., Ltd.

TEC
Television Equipment Corp.

TECO
Telesradio Engineering Corp.

TEFLEX
Boston Insulated Wire & Cable Co.

TEFLON
Electronic Mechanics, Inc.

TEFLON
du Pont de Nemours & Co., Inc., E. I.

TEFSILON
Boston Insulated Wire & Cable Co.

TEKTOR
Fielden Electronics Inc.

TEL-A-COR
Magnetic Core Corp.

TELAMP
Miles Reproducer Co., Inc.

TELANTUNE
Crystal Devices Co., Inc.

TELCOARC
Western Union Telegraph Co.

TELEBOOSTER
Television Equipment Corp.

TELECAP
Sprague Electric Co.

TELECENE
Enthoven & Sons, Ltd., H. J.,

TELECLEAR
House of Television Inc.

TELECOMMAND
Flader, Inc., Fredric

TELECODER
Telecomputing Corp.

TELECOUPLER
Television Equipment Corp.

TELEDELTA
Western Union Telegraph Co.

TELEDIPHONE
Edison, Inc., Thomas A.

TELEDYNE
Flader, Inc., Fredric

TELEFAX
Western Union Telegraph Co.

TELEFILTER
House of Television, Inc.

TELEFLIGHT
Flader, Inc., Fredric

TELEGLAS
Pittsburgh Plate Glass Co.

TELEHOME
Webster Electric Co.

TELEKRYPTON
Western Union Telegraph Co.

TELEMARK
Leupold & Stevens Instruments

TELEMETROSCOPE
Deutschmann Corp., Tobe

TELEMIKE
Miles Reproducer Co., Inc.

TELEMIRROR
House of Television Inc.

TELEPAGE
Webster Electric Co.

TELEPHOTO
Acme Teletronix Div. of NEA Service, Inc.

TELEPLATE
Whitney Blake Co.

TELEPRENE
Whitney Blake Co.

TELEREADER
Telecomputing Corp.

TELE-ROTOR
Radiart Corp.

TELESET
Telex, Inc.

TELESONIC
U. S. Television Mfg. Corp.

TELESPATCH
Webster Electric Co.

TELESPEAKER
Telex, Inc.

TELESYMPHONIC
U. S. Television Mfg. Corp.

TELESYN
Ford Instrument Co., Inc.

TELETALK
Webster Electric Co.

TELETHERM
Westinghouse Electric Corp.

TELETORQUE
Kollsman Instrument Corp.

TELETRAP
Crystal Devices Co., Inc.

TELETUNER
Mallory & Co., P. R.

TELEVAC
Fredericks Co., Geo. E.

TELEVERTER
James Vibrapowr Co.

TELEVOICRITER
Edison Inc., Thomas A.

TELEVOX
Westinghouse Electric Corp.

TELE-ZOOM
Garod Majestic Corp.

TEL-OHMIKE
Sprague Electric Co.

TELOP
Gray Research & Development Co.

TELOPTICAN
Gray Mfg. Co.

TEL-TENNA
Precision Plastic Products Inc.

TEL-TENNA
Television Laboratories, Inc.

TELVAR
Audar, Inc.

TELVUER
Television Projects, Inc.

TEMCO
Transmitter Equipment Mfg. Co., Inc.

TEMFLEX
Irvington Varnish & Insulator Co.

TEMP COP
Micro Switch

TEMPOOF
Lord Mfg. Co.

TEMSTART
Synchro Start Products, Inc.

TENITE
Tennessee Eastman Co.

TENITE I
Tennessee Eastman Co.

TENITE II
Tennessee Eastman Co.

TENNA-CLAMP
Mueller Electric Co.

TENNA-ROTOR
Alliance Mfg. Co.

TENNASTUB
Crystal Devices Co., Inc.

TENSIOMETER
Saxl Instrument Co.

TENSITE
Driver Co., Wilbur B.

TENS-O-TROL
Dillon & Co., Inc., W. C.

TERMALINE
Bird Electronic Corp.

TERMEND
Buchanan Electrical Products Corp.

TERMIN O SEAL
Wolfe Co., Inc., Franklin C.

TERROMETER
Engineering Research Corp.

TESCO
Eastern Specialty Co.

TESTLITE-FUSPUL
Dante Electric Mfg. Co.

TEST-MIKE
Cornell-Dubilier Electric Corp.

TEST-O-LITES
Brach Mfg. Corp.

TEST-MASTER
Precision Apparatus Co.

TETCO
Electric Tachometer Co.

TEXTOLITE
General Electric Co.

THERACOUPLER
Marconi Instruments Ltd.

THERA-RAY
Edin Co., Inc.

THERATHERM
Marconi Instruments Ltd.

THERMALARM
Eastern Specialty Co.

THERMALL
LaRose & Associates, Inc., W. T.

THERM-A-NEERING
Westinghouse Electric Corp.

THERMATRON
Radio Receptor Co.
THERMEX
Girdler Corp.
THERMITE
Thermionic Engrg. Corp.
THERMOCAP
Niagara Electron Laboratories
THERMOCONTAX
Rahm Instruments, Inc.
THERMO-GRIP
Ideal Industries, Inc.
THERMOGUARD
Westinghouse Electric Corp.
THERMO-HUMIDIGRAPH
Bristol Co., The
THERMOIL-GRANODINE
American Chemical Paint Co.
THERMOLAIN
Star Porcelain Co.
THERMOLAST
Elematic Eqpt. Corp.
THERMO-LO
Farrelloy Co.
THERMOMETAL
Wilson Co., The, H. A.
THER-MONIC
Induction Heating Corp.
THERMOPLAX
Cutler-Hammer, Inc.
THERMOSEN
Sorensen & Co.
THERMO-SNAP
Spencer Thermostat Co.
THERMOSWITCH
Fenwal, Inc.
THERM-OTROLS
Wheelco Instruments Co.
THERMOVERTER
Bristol Co., The
THERMU-TROL
Mu Switch Co.
THESAURUS
Radio Corp. of America
THINEX
Dixon Crucible Co., Joseph
THRED-LOCK
Continental Screw Co.
THREDMOUNT
National Union Radio Corp.
THREE-PHASE
Sciaky Bros., Inc.
THROTTLEROLS
Wheelco Instruments Co.
THRURAY
Sperry Products, Inc.
THYRITE
General Electric Co.
THYR-X
Liebel-Flarsheim Co.
TICONDEROGA
Dixon Crucible Co., Joseph
TIDLETRIK
American Lava Corp.
TI-MATIC
Westinghouse Electric Corp.
TIME AID
Paragon Electric Co.
TIMEFAX
Times Facsimile Corp.
TIMELY
Commodore Record Co.
TIME-MASTER
Dictaphone Corp.
TIME-O-GRAF
Gibbs Div.
George W. Borg Corp.
TIME-O-LITE
Industrial Timer Corp.
TIME-O-SWITCH
Minneapolis-Honeywell Regulator Co.
TIM-O-LUX
Sidward Mfg. Co., Inc.
TIM-U-LATOR
Gorrell & Gorrell
TINOL
American Solder & Flux Co.
TINY-GLOW
Industrial Devices, Inc.
TINYMIKE
Cornell-Dubilier Electric Corp.
TINY TIM
Shure Brothers
TIREX
Simplex Wire & Cable Co.
TITAN
General Lead Batteries Co.
TITAN
Sonotone Corp.
TITE-BIND
Thomas & Betts Co., Inc.
TITE-BITE
Thomas & Betts Co., Inc.
TITEGRIP
Dante Electric Mfg. Co.
TITONE
Sonotone Corp.
TITRILOG
Consolidated Engineering Corp.
TITRIMETER
Fisher Scientific Co.
TITROMETER
Precision Scientific Co.
TOCCO
Ohio Crankshaft Co.
T. W.
Paisley Products Inc.

TOCCOTRON
Ohio Crankshaft Co., Tocco Div.
TOK FONE
Regal Electronics Corp.
TOKAVOX
Cooper Electronic Products Co.
TOM THUMB
Automatic Radio Mfg. Co., Inc.
TONG TEST
Columbia Electric Mfg. Co.
TONG TEST
Martindale Electric Co.
TOP HAT
Times Facsimile Corp.
TOPHET
Driver Mfg. Co., Wilbur B.
TORKOTHERM
Tork Clock Co.
TORQUE DRIVE
Electro-Voice, Inc.
TORKMASTER
Tork Clock Co., Inc.
TORRIDAL
Capacitron Co.
TORSIOGRAPH
Commercial Research Labs., Inc.
TORSIOMETER
Commercial Research Labs., Inc.
TOUCH-TIMER
Kay Electric Co.
TRADIO
Trad Television Corp.
TRADIOVISION
Trad Television Corp.
TRADITION-CHROMA
Staedtler, Inc., J. S.
TRAFF-O-MATIC
Automatic Signal Div.,
Eastern Industries, Inc.
TRAIL BLAZER
Meck Industries, John
TRANCORS
Lenkurt Electric Co., Inc.
TRANSALOID
Haloid Co., The
TRANSFAX
Eastman Kodak Co.
TRANSFILTER
Brush Development Co.
TRANSFLEX
Irvington Varnish & Insulator Co.
TRANSITE
Johns-Manville Sales Corp.
TRANSISTONE
Philco Corp.
TRANSKOTE
Panco Mirrors, Inc.
TRANS-METER
Electronic Specialty Co.
TRANS-O-METER
Westinghouse Electric Corp.
TRANSVERTER
Hertner Electric Co.
TRAVERTONE
Armstrong Cork Co.
TRENTWELD
Crucible Steel Co. of America
TRIANGLE T
Amalgamated Electronics
TRICENE
Enthoven & Sons, Ltd., H. J.
TRI-CORE
Alpha Metals, Inc.
TRIG
Rostan Corp.
TRI-LOK
Boots Aircraft Nut Corp.
TRIMAIR
Caldwell Mfg. Corp. Alan D.
TRIMTHERM
General Controls Co.
TRI-O-MATIC
V-M Corp.
TRIONODE
Walkirt Co.
TRI-O-SPEED
V-M Corp.
TRIONIC
Clarkstan Corp.
TRI-SOL
DuBois Co., Ltd.
TRONEX
Wheaton Co., T. C., Industrial Div.
TRUARC
Waldes Kohinoor Inc.
TRUCOPYPHOTE
General Photo Products Co.
TRUE-BRAND
Carbonneau Industries, Inc.
TRU FIDELITY
Thordarson-Meissner Mfg. Divs.
TRUFLEX
General Plate Division, Metals & Control Corp.
TRU-FLEX
Peerless Photo Products.
TRU-GRAF
Peerless Photo Products.
TRULUME
Reeves Soundcraft Corp.
TRU-OHM
Model Engrng. & Mfg. Co.
TRUSCON
Republic Steel Corp.
TRU-SONIC
Stephens Mfg. Corp.
TRU-VAC
Continental Electric Co.

TRYLON
Wind Turbine Co., Tower & Antenna Div
TUBE-MASTER
Precision Apparatus Co.
TUBE-U-LAR
Pyramid Electric Co.
TUBE VISE
Precision Plastic Products, Inc.
TUFFERNELL
Westinghouse Electric Corp.
TUFFY
Insulation Manufacturers Corp.
TUFLEC
Laminated Plastics Inc.
TUF-ON
Brooklyn Varnish Mfg Co.
TURBO
Brand & Co., Wm.
TURBO PRENE
Brand & Co., Wm.
TURBOTHERM
Brand & Co., Wm.
TURQUOISE
Eagle Pencil Co.
TWEEZER-WELD
Federal Tool Engineering Co.
TWIN FAST
Blake & Johnson Co.
TWINTACTS
Weston Electrical Instrument Co.
TWIN-TRAX
Amplifier Corp. of America
TWINKORD
Ansonia Electrical Co.
TWINROD
Belling & Lee, Ltd.
TWINSET
Telex, Inc.
TWINSULATION
U. S. Rubber Co.
TWIN-VISO
Sanborn Co.
TWISTAB
National Union Radio Corp.
TWISTAGUIDE
Airtron, Inc.
TWIST-LOCK
Hubbell, Inc., Harvey
TWIST-LOK
Sprague Electric Co.
TWIST-MOUNT
Pyramid Electric Co.
TWIST-TITE
Hubbell, Inc., Harvey
TY-DOWN
Air Associates, Inc.
TYGON
U. S. Stoneware Co.
TY-LOK
Air Associates, Inc.
TYLOX
Hamilton Kent Mfg. Co., Inc.
TYNISWITCH
Sessions Clock Co.
TYMIT
Tork Clock Co.
TYNEE-DRY
Pyramid Electric Co.
TYPE-O-WRITER
Kellogg Switchboard & Supply Co.
TYPHONITE ELDORADO
Dixon Crucible Co., Joseph
TY-PLY
Marbon Corp.
TZUCOPY PHOTO
General Photo Products Co., Inc.
UBABOND
Union Bay State Chemicals Co.
UBAGRIP
Union Bay State Chemical Co.
UBAPOL
Union Bay State Chemical Co.
UBATEX
Union Bay State Chemical Co.
U-GRIP
Aircraft-Marine Products, Inc.
U.H.C.A.
Commodore Record Co.
ULTRACOMPACT
United Transformer Co.
ULTRASCALER
Nuclear Instrument & Chemical Corp.
ULTRASONORATOR
Crystal Research Labs., Inc.
ULTRATONE
Audio Industries
ULTRON
Monsanto Chemical Co., Plastics Div.
UMP
Illinois Condenser Co.
UNBRAKO
Standard Pressed Steel Co.
UNDARK
U. S. Radium Corp.
UNIBALLASTS
National Union Radio Corp.
UNI-BRIDGE
Industrial Electronics, Inc.
UNICLOSED
U. S. Electrical Motors, Inc.
UNICON
United Condenser Corp.
UNI-CRIMP
Sherman Mfg. Co., H. B.
UNIDYNE
Shure Brothers, Inc.
UNI-FLEX
Dumore Co., The

UNIFLEX
Miskella Infra-Red Co.
UNI-FLO
Barber-Colman Co.
UNILINE
Pass & Seymour, Inc.
UNI-MATIC
Calbest Engineering & Electronics Co.
UNIMAX
Maxson Corp., W. L.
UNIONMELT
Linde Air Products Co., Unit of
Union Carbide & Carbon Corp.
UNIPLEX
Shure Brothers, Inc.
UNIPOINT
Shure Brothers, Inc.
UNIPOLE
Andrew Co.
UNI-SHAFT
Mallory & Co., P. R.
UNITACT
Bristol Co., The
UNITED
Jackson Industries, Inc.
UNITORS
Belling & Lee, Ltd.
UNITRAD
Crosley Corp.
UNIVAC
Eckert-Mauchly Computer Corp.
UNIVERSAL
Mueller Electric Co.
UNIVERSAL
Davis & Murphy
UNIVIBES
National Union Radio Corp.
UNLIMITET
Northern-Zaleski, Ltd.
UPSON
Republic Steel Corp.
URAC
American Cyanamid Co., Plastics Div.
URELITE
J-T-E Circuit Breaker Co.
U. S. E.
U. S. Electronics Corp.
UST
U. S. Television Mfg. Corp.
USALITE
Stupakoff Ceramic & Mfg. Co.
USECO
U. S. Engineering Co.
USEMENT
U. S. Rubber Co.
USEX
U. S. Rubber Co.
USEX ABBOSEALED
U. S. Rubber Co.
USKORONA
U. S. Rubber Co.
USPRENE
U. S. Rubber Co.
USRUB
U. S. Rubber Co.
U.S.S.
United States Steel Corp.
U.S.S. AMERICAN
American Steel & Wire Co.
UTC
United Transformer Corp.
UTILASTIC
Paisley Products, Inc.
UTILIPHONE
National Electronic Labs., Inc.
UTILISCOPE
Diamond Power Specialty Corp.
V-HEAT
Electric Eye Equipment Co.
V-KING
Schott Co., Walter L.
VACOMBO
Vaco Products Co.
VACOPAK
Vacolite Co.
VACTITE
Locke Incorporated
VACTU-PAK
Allen-Howe Electronics Corp.
VACTU-PHONE
Allen-Howe Electronics Corp.
VALVRATORS
Fischer & Porter Co.
VALVSEAL
Richardson Co., The
VAN de GRAAFF
High Voltage Engineering Corp.
VAPO
Post Co., Frederick
VAREC
Vapor Recovery Systems Co.
VARGLAS
Varflex Corp.
VARIAC
General Radio Co.
VARIATEN
Shallcross Mfg. Co.
VARICELL
Superior Electric Co., The
VARIDRIVES
U. S. Electrical Motors, Inc.
VARIFILE
Photographic Products, Inc.
VARIMATCH
United Transformer Corp.
VARI PLOTTER
Electronic Associates, Inc.
VARIPOWER
United Transformer Corp.
VARITONE
Flader, Inc., Fredric
VARITRAN
United Transformer Corp.
VARITRON
Photographic Products, Inc.
VARITRONIC
Electron Equipment Corp.
VARTYMER
Gale Dorothea Mechanisms
VART-VOLT
Halldorson Co., The
VARSLOT
New Jersey Wood Finishing Co.
VASCO
Mitchell Industries, Inc.
VARTEX
New Jersey Wood Finishing Co.
VAW
Fluke Engineering Co., John
VECTORLYZER
Advance Electronics Co.
VEECO
Vacuum Electronic Engineering Co.
VEE-D-X
LaPointe-Plascomold Corp.
VEEROD
Belling & Lee, Ltd.
VEGETOL
Cornell-Dubilier Electric Corp.
VEGIMAL
Paisley Products, Inc.
VELOMETER
Illinois Testing Labs., Inc.
VELOUR BLACK
Sheldon Electric Co. Div. of
Allied Electric Products, Inc.
VENDLITES
Drake Mfg. Co.
VERICON
Remington Rand, Inc.
VERITHIN
Eagle Pencil Co.
VERNIER-SET
Automatic Temperature Control Co., Inc.
VERSAGONE
Radio Merchandise Sales.
VERSALINER
Peck & Harvey
VERSALITE
U. S. Rubber Co.
VERSATEX
Shure Brothers
VIBESTON
U. S. Rubber Co.
VIBRALOC
Topping Mfg. Co.
VIBRA-SEALED
Topping Mfg. Co.
VIBRAPAK
Mallory & Co., Inc., P. R.
VIBRASENDER
Motorola Inc.
VIBRASHOCK
Robinson Aviation, Inc.
VIBRASPONDER
Motorola Inc.
VIBRATAB
Telecomputing Corp.
VIBROGROUND
Associated Research Inc.
VIBROMETER
Televivo Products, Inc.
VIBROMIKE
Brush Development Co.
VIBROTEST
Associated Research, Inc.
VICALLOY
Arnold Engineering Co.
VICTOR
Radio Corp. of America
VICTROLA
Radio Corp of America
VICTRON
Victor Electric Products, Inc.
VIDEO BEAM
Camburn, Inc.
VIDEOCOUPLER
Mallory & Co., Inc., P. R.
VIDEOFILM
General Precision Laboratory, Inc.
VIDEOGAM
General Precision Laboratory, Inc.
VIDEOLA
Tech-Master Products Co.
VIDEOLUX
Video Corp. of America
VIDEOMETER
Hickok Electrical Instrument Co.
VIDEON
Tele-Video Corp.
VIDEOSET
Video Corp. of America
VIDEOTRON
National Union Radio Corp.
VIDI MASTER
Communication Measurements Lab., Inc.
VIEWLITE
Viewlex Inc.
VIEWROD
Belling & Lee, Ltd.
VIEWMATIC
Viewlex Inc.
VIEWTALK
Viewlex Inc.

VIKANE
Cornell-Dubilier Electric Corp.
VIMLITE
Celanese Corp. of America
VINYL
Alpha Wire Corp.
VINYLLITE
Bakelite Corp.
VINYLSEAL
Bakelite Corp.
VINYON
Bakelite Corp.
VIPOWER
Cornell-Dubilier Electric Corp.
VIPOWER
Radiart Corp.
VISABLE PROOF
Electric Heat Control Co., The
VISAFLAME
Mercoid Corp.
VISCONOL-CATHODRAY
Telegraph Condenser Co., Ltd.
VISCOR
Weston Electrical Instrument Co.
VISICODE
Westinghouse Electric Corp.
VISITRON
Rauland Corp.
VISO-CARDIETTE
Sanborn Co.
VISUAL GAGE
Sheffield Co.
VITAMIN Q
Sprague Electric Co.
VITATRON
Sheldon Electric Co. Div. of
Allied Electric Products, Inc.
VITAVOX
Radiomic Transformer Co.
VITROHM
Ward Leonard Electric Co.
VITROLAIN
Star Porcelain Co.
VIZ
Molded Insulation Co.
VOCAL-AIRE
Dilks Co., The
VOICE OF THEATRE
Altec Lansing Corp.
VOICEWRITER
Edison Inc., Thomas A.
VOLSTAT
Industrial Transformer Corp.
VOLTALAC
Standard Varnish Works
VOLT-AMP
Industrial Devices, Inc.
VOLTASCOPE
Polarad Electronics Corp.
VOLTBOX A-C
Superior Electric Co.
VOLTOHMYST
Radio Corporation of America
VOLTROL
Acme Electric Corp.
VOLTRON
Industrial Synthetics Corp.
VOMAX
McMurdo Silver Co., Inc.
VOYCALL
Lake Mfg. Co.
VUELITE
Monsanto Chemical Co., Plastics Div.
VUEPAK
Monsanto Chemical Co., Plastics Div.
VUE-SCOPE
Celomat Corp.
VULCATEX
Horn Co., Inc., A. C.
VULCOID
Continental Diamond Fibre Co.
VYCOR
Corning Glass Works
WABLQUIST
Nilsson Electrical Laboratory, Inc.
WAHLQUIST
Nilsson Electrical Laboratory, Inc.
WALCO
Electrovox Co., Inc.
WALDES TRUARC
Waldes Kohinoor, Inc.
WALKIE-RECORDALL
Miles Reproducer Co., Inc.
WALSCO
Schott Co., Walter L.
WATCH MASTER
American Time Products, Inc.
WATERWITE
Bache & Co., Semon
WAVEFLEX
Titellex, Inc.
WAVELINE
Microwave Equipment Co., Inc.
WAXMASTER
Aeroil Products Co.
WAX S 1167
Glyco Products Co., Inc.
W. D. C.
Paisley Products Inc.
WEDGE-GRIP
Sherman Mfg. Co., H. B.
WEDGE-ON
Thomas & Betts Co., Inc.
WEDGIE
Insulation Manufacturers Corp.
WEIGER-WEED
Fansteel Metallurgical Corp.

WEILCO
 Weil & Co., J. H.
WEILETTE
 Weil & Co., J. H.
WEILINE
 Weil & Co., J. H.
WELDRAWN
 Superior Tube Co.
WELDOMATIC
 Westinghouse Electric Corp.
WELD-O-TIMER
 Westinghouse Electric Corp.
WELD-O-TROL
 Westinghouse Electric Corp.
WELDPPOWER
 Raytheon Mfg. Co.
WEMCALLOY
 Westinghouse Electric Corp.
WEPCO
 Peek, Inc., Walter E.
WESGO
 Western Gold & Platinum Works
WESTACH
 Westberg Mfg. Co.
WHARFEDALE
 British Industries Corp.
WHC
 Waltham Horological Corp.
WHEELLOCK
 Signal Engineering & Mfg. Co.
WHITE FLASH
 Enthoven & Sons., Ltd., H. J.
WINCHESTER
 Olin Industries, Inc.
WILCO
 Wilson Co., The, H. A.
WINCO
 Hudson Wire Co.
WINCO
 Wincharger Corp.
WINROD
 Belling & Lee, Ltd.
WIPERMALLOY
 United Transformer Corp.

WIREMASTER
 Precision Audio Prods., Inc.
WIRE-NUTS
 Ideal Industries, Inc.
WIREFPHONE
 Molded Insulation Co., Aircraft Control Div.
WIRETONE
 Molded Insulation Co., Aircraft Control Div.
WIREWATT
 Ohmite Mfg. Co.
WISSCO
 Wickwire Spencer Steel Div.,
 The Colorado Fuel & Iron Corp.
WOOD GLU
 Paisley Products Inc.
WOODITE
 Syracuse Ornamental Co., Inc.
WOOD-RAY
 Woodwelding, Inc.
WOODWELDER
 Short Wave Plastic Forming Co.
WOODWELDER
 Woodwelding, Inc.
WOODWIN
 Wood Electric Co., Inc., C. D.
WRIGHTFLOR
 Taylor Mfg. Co.
WRINCO
 New Wrinkle, Inc.
WRINTEX
 New Wrinkle, Inc.
WYD-ANGLE
 Ess Specialty Corp.

XACTEMP
 Gordon Co., Claud S.
XACTLINE
 Gordon Co., Claud S.
XCELITE
 Park Metalware Co.
XENOFFLASH
 Triumph Mfg. Co.
XEROX
 Haloid Co., The
X-PRESS
 Cook Electric Co.

XRD
 General Electric X-Ray Corp.
XTE
 Irvington Varnish & Insulator Co.
X-THERMOTROL
 Gasket Engineering Co.
X-VAR
 Fidelity Chemical Products Corp.
X-WASHERS
 Standard Locknut & Lockwashers, Inc.

YANKEE
 Stanley Tools Div., Stanley Works
YORKMESH
 York Co., Inc., Otto H.

Z ANGLE
 Technology Instrument Corp.
“Z” NICKEL
 International Nickel Co., Inc., The
ZAHODIAKIN
 Scovill Mfg. Co.
ZENEL
 Bonney Forge & Tool Works
ZENO-KOTE
 Zenith Optical Lab.
ZERO READER
 Sperry Gyroscope Co. Div. of The Sperry Corp.
ZIPCORD
 U. S. Rubber Co.
ZIP-GRIP
 Set Screw & Mfg. Co.
ZIPHMS
 Muter Co.
ZIP-IN
 American Phenolic Corp.
ZIRCONARC
 Fish-Schurman Corp.
ZIRMET
 Foote Mineral Co.
ZOOMAR
 Television Zoomar Corp.
ZYROX
 Halowax Products Division,
 Union Carbide & Carbon Corp.

1951-1952 ELECTRONICS BUYERS' GUIDE

MANUFACTURERS INDEX

A listing of the companies engaged in the manufacture of all types of electronic components and complete electronic equipment. They are alphabetically arranged for convenient use and quick reference.

- A B C Radio Laboratories, 3334 N. New Jersey St., Indianapolis 5, Ind.
- A. P. W. Co., 72 W. Main St., Rockaway, N. J.
- Abalon Precision Mfg. Corp., 540 Casanova St., Bronx 59, N. Y.
- Accurate Mfg. Co., 44 Hepworth Place, Garfield, N. J.
- Accurate Paper Tube Co., 851 N. Noble St., Chicago 22, Ill.
- Accurate Spring Mfg. Co., 3811 W. Lake St., Chicago, Ill.
- Ace Engineering & Machine Co., 3642 N. Lawrence St., Philadelphia 40, Pa.
- Ace Mfg. Corp., Chalfont, Pa.
- Ace Spring Mfg. Co., 77 W. Houston St., New York 12, N. Y.
- Acheson Colloids Corp., Port Huron, Mich.
- Ackerman-Johnson Co., 625 W. Jackson Blvd., Chicago 6, Ill.
- Acklin Stamping Co., 1923 Nebraska Ave., Toledo 7, Ohio.
- Acme Battery Co., 59 Pearl St., Brooklyn, N. Y.
- Acme Electric Corp., 31 Water St., Cuba, N. Y.
- Acme Electric Heating Co., 1217 Washington St., Boston, Mass.
- Acme Electronics, Inc., 300 N. Lake Ave., Pasadena 4, Calif.
- Acme Folding Box Co., Inc., 141 E. 25th St., New York 10, N. Y.
- Acme Electronics Div. of NEA Service, Inc., West Third & Lakeside, Cleveland 13, Ohio.
- Acme Wire Co., New Haven 14, Conn.
- Acro Mfg. Co., Columbus 16, Ohio.
- Acro Products Co., 215 Arch St., Philadelphia 6, Pa.
- Acro Transformer Mfg. Corp., 26-02 4th St., Astoria 2, N. Y.
- Acromark Co., The, 442 Morrell St., Elizabeth 4, N. J.
- Acton Co., Inc., H. W., 370 7th Ave., New York 1, N. Y.
- Adams & Westlake Co., Michigan St., Elkhart, Ind.
- Adel Div. of General Metals Corp., 10777 Van Owen St., Burbank, Calif.
- Admiral Corp., 3800 Cortland St., Chicago 47, Ill.
- Advance Electric & Relay Co., 2435 Naomi St., Burbank, Calif.
- Advance Electronics Co., 451 Highland Ave., Passaic, N. J.
- Advance Insulated Wire & Cable Co., 115 Spring St., Morristown, N. J.
- Advance Recording Products Co., 36-12 34th St., Long Island City, N. Y.
- Aermotive Equipment Corp., 1632-8 Central St., Kansas City 10, Mo.
- Aero Coil Co., 507-26th St., Union City, N. J.
- Aero Instrument Co., 11423 Vanowen St., North Hollywood, Calif.
- Aero Needle Co., 619 N. Michigan Ave., Chicago 11, Ill.
- Aerolite Electronic Hardware Corp., 507-26th St., Union City, N. J.
- Aerolux Light Corp., 653 11th Ave., New York 19, N. Y.
- Aeronautical Communications Equipment, Inc., 3090 Douglas Rd., Miami 33, Fla.
- Aeronautical Electronics Inc., Raleigh-Durham Airport, P. O. Box 6043, Raleigh, N. C.
- Aerovox Corp., 740 Belleville Ave., New Bedford, Mass.
- Air Associates, Inc., Teterboro, N. J.
- Air-King Products Co., Inc., 170 53rd St., Brooklyn, N. Y.
- Air-Marine Motors, Inc., 2183 Jackson Ave., Seaford, N. Y.
- Airborne Electronics Co., Metropolitan Airport Hangar No. 3, Van Nuys, Calif.
- Airborne Instruments Lab., Inc., 160 Old Country Rd., Mineola, N. Y.
- Aircraft Electronics Associates, Inc., 94 Silas Deane Highway, Rocky Hill, Conn.
- Aircraft Marine Products, Inc., 2100 Paxton St., Harrisburg 10, Pa.
- Aircraft Radio Corp., Boonton, N. J.
- Airdesign, Inc., 241 Fairfield Ave., Upper Darby, Pa.
- Airlectron, Inc., P. O. Box 151, Caldwell, N. J.
- Airmec Laboratories Ltd., 366 Madison Ave., New York 17, N. Y.
- Airpax Products Co., Middle River, Baltimore 20, Maryland.
- Airplane & Marine Instruments, Inc., Clearfield, Pa.
- Airtron, Inc., 101 E. Elizabeth Ave., Linden, N. J.
- Airtronics Mfg. Co., 5145 W. San Fernando Rd., Los Angeles 39, Calif.
- Ajax Electrothermic Corp., Ajax Park, Trenton 5, N. J.
- Akron Porcelain Co., Akron 14, Ohio.
- Aladdin Radio Industries, Inc., 501 W. 35th St., Chicago 16, Ill.
- Alden Products Co., 117 N. Main St., Brockton 64, Mass.
- Alfax Paper & Engineering Co., Washington St., P. O. Box 125, Westboro, Mass.
- Allegheny Ludlum Steel Corp., H. W. Oliver Bldg., Pittsburgh 22, Pa.
- Allen Co., L. B., Inc., 6751 Bryn Mawr Ave., Chicago 31, Ill.
- Allen-Bradley Co., 136 W. Greenfield Ave., Milwaukee 4, Wis.
- Allen Mfg. Co., Hartford, Conn.
- Alliance Mfg. Co., Lake Park Blvd., Alliance, Ohio.
- Allied Control Co., Inc., 2 East End Ave., New York 21, N. Y.
- Allied Radio Corp., 833 W. Jackson Blvd., Chicago 7, Ill.
- Allied Recording Products Co., 21-09 43rd Ave., Long Island City 1, N. Y.
- Allis-Chalmers Mfg. Co., 935 South 70th St., Milwaukee 1, Wis.
- Allis Co., Louis, 427 E. Stewart St., Milwaukee 7, Wis.
- Allison Radar Corp., 11 W. 42nd St., New York 18, N. Y.
- Allmetal Screw Products Co., Inc., 33 Greene St., New York 13, N. Y.
- Alloy Metal Wire Co., 13th & Penna. Ave., Prospect Park, Pa.
- Alpha Electronics, Inc., 53-57 Bergen Turnpike, Little Ferry, N. J.
- Alpha Metals, Inc., 365 Hudson Ave., Brooklyn 1, N. Y.
- Alpha Wire Corp., 430 Broadway, New York, N. Y.
- Altec Lansing Corp., 9356 Santa Monica Blvd., Beverly Hills, Calif.
- Aluminum Co. of America, Gulf Bldg., Pittsburgh 30, Pa.
- Amalgamated Electronics, Electronics Road, Clinton Corners, N. Y.
- Ambroid Co., 305 Franklin St., Boston 10, Mass.
- American Brass Co., 25 Broadway, New York 4, N. Y.
- American British Technology Inc., 57 Park Ave., New York 16, N. Y.
- American Chemical Paint Co., Ambler, Pa.
- American Chronoscope Corp., 316 W. First St., Mt. Vernon, N. Y.
- American Cladmetals Co., P. O. Box 544, Carnegie, Pa.
- American Condenser Co., 4410 Ravenswood Ave., Chicago 40, Ill.
- American Cyanamid Co., 38 Rockefeller Plaza, New York 20, N. Y.
- American Diathermy Products, Inc., 11858 Mississippi Ave., Los Angeles 25, Calif.
- American Electric Cable Co., 181 Appleton St., Holyoke, Mass.
- American Electric Motors, Inc., 4811 Telegraph Rd., Los Angeles, Calif.
- American Electrical Heater Co., 6110 Cass Ave., Detroit 2, Mich.
- American Electronering Co., 5025-19 W. Jefferson Blvd., Los Angeles 16, Calif.
- American Electronics Corp., 157 Marion Blvd., Columbus, Ohio.
- American Gas Accumulator Co., 1029 Newark Ave., Elizabeth 3, N. J.
- American Hard Rubber Co., 11 Mercer St., New York 13, N. Y.
- American Instrument Co., 8030 Georgia Ave., Silver Spring, Md.
- American Insulator Corp., New Freedom, Pa.
- American Laubscher Corp., 333 W. 52nd St., New York 19, N. Y.
- American Lava Corp., Chattanooga 5, Tennessee.
- American Microphone Co., 370 So. Fair Oaks Ave., Pasadena 1, Calif.
- American Molded Products Co., 1644 N. Honore St., Chicago 22, Ill.
- American Nut & Bolt Fastener Co., 2045 Doerr St., Pittsburgh 33, Pa.
- American Optical Co., Box A, Buffalo 15, N. Y.
- American Phenolic Corporation, 1830 S. 54th Ave., Chicago 50, Ill.
- American Photocopy Equipment Co., 2849 N. Clark St., Chicago, Ill.
- American Platinum Works, N.J.R.R. Ave. at Oliver St., Newark 5, N. J.
- American Products Mfg. Co., Oleander & Dublin Sts., New Orleans 18, La.
- American Radionics Co., 33 Flatbush Ave., Brooklyn, N. Y.
- American Radio Hardware Co., 152 MacQuesten Pkwy, South Mount Vernon, N. Y.
- American Relay & Controls Inc., 4901 W. Flournoy St., Chicago 44, Ill.
- American Scientific Co., P. O. Box 11, High Bridge Station, New York 52, N. Y.
- American Screw Co., Willimantic, Conn.
- American Solder & Flux Co., 2152 E. Norris St., Philadelphia 25, Pa.
- American Steel & Wire Co., Rockefeller Bldg., Cleveland 13, Ohio.
- American Structural Products Co., P. O. Box 1035-6, Toledo 1, Ohio.
- American Television, Inc., 523 S. Plymouth St., Chicago 6, Ill.
- American Television & Radio Co., 300 E. 4th St., St. Paul 1, Minn.
- American Thermo Electric Co., 67 E. 8th St., New York 3, N. Y.
- American Time Products, Inc., 580 Fifth Ave., New York 19, N. Y.
- Amglo Corp., 4234 Lincoln Ave., Chicago 18, Ill.
- Amol Precision Corp., Dumont, N. J.
- Amperex Electronic Corp., 25 Washington St., Brooklyn 1, N. Y.
- Amperite Co., 561 Broadway, New York 12, N. Y.
- Ampex Electric Corp., 1155 Howard Ave., San Carlos, Calif.
- Ampflex Division, Chrysler Corp., Detroit 31, Mich.
- Amplifier Corp. of America, 398 Broadway, New York 13, N. Y.
- Ampro Corp., 2835 North Western Ave., Chicago 18, Ill.
- Amy, Aceves & King Inc., 11 W. 42nd St., New York 18, N. Y.
- Anaconda Wire & Cable Co., 25 Broadway, New York 4, N. Y.
- Anchor Industrial Co., 533-541 Canal St., New York 13, N. Y.
- Anchor Metal Co., 87 Walker St., New York 13, N. Y.
- Anchor Plastics Co., Inc., 533-541 Canal St., New York 13, N. Y.
- Andersen Laboratories, Inc., 39 Talcott Rd., West Hartford, Conn.
- Anderson, Arthur R., 110 Woodbury Ave., Springdale, Conn.
- Andrea Radio Corp., 27-01 Bridge Plaza North, Long Island City 1, N. Y.
- Andrew Corp., 363 E. 75th St., Chicago 19, Ill.
- Anemostat Corp. of America, 10 E. 39th St., New York 16, N. Y.
- Annis Co., R. B., 1101 N. Delaware St., Indianapolis, Ind.
- Ansley Mfg. Co., Arthur, Doylestown, Pa.
- Ansonia Electrical Co., 63 Main St., Ansonia, Conn.
- Antara Products Division, General Dyestuff Corp., 435 Hudson St., New York 14, N. Y.
- Antenna Research Lab., Inc., 797 Thomas Lane, Columbus 14, Ohio.
- Anti-Corrosive Metal Products Co., Castleton-on-Hudson, N. Y.
- Anton Electronic Laboratories, Inc., 1226-1238 Flushing Ave., Brooklyn 6, N. Y.
- Applied Electronics Co., 1246 Folsom St., San Francisco 3, Calif.
- Applied Physics Corp., 362 W. Colorado St., Pasadena 1, Calif.
- Applied Research Labs., 4336 San Fernando Rd., Glendale 4, Calif.
- Applied Science Corp. of Princeton, The, P. O. Box 44, Princeton, N. J.
- Approved Electronic Instrument Corp., 142 Liberty St., New York 6, N. Y.
- Arco Co., 7301 Bessemer Ave., Cleveland 27, Ohio.
- Arco Electronics Inc., 103 Lafayette St., New York 13, N. Y.
- Arco Transformer & Electric Corp., 1602 S. Hanna St., Fort Wayne, Ind.
- Arcturus Electronics, Inc., 54 Clark St., Newark, N. J.
- Ark-Les Switch Corp., 55 Water St., Watertown 72, Mass.
- Arlington Electric Products Inc., 500 W. 52nd St., New York 19, N. Y.
- Arma Corp., 254 36th St., Brooklyn 32, N. Y.
- Armco Steel Corp., 703 Curtis St., Middletown, Ohio.
- Armstrong Cork Co., Lancaster, Pa.
- Arnold Engineering Co., Marengo, Ill.
- Arro Expansion Bolt Co., Boone Ave., Marlon, Ohio.
- Arrow-Hart & Hegeman Electric Co., 100 Hawthorn St., Hartford 6, Conn.
- Art-Lloyd Metal Products Corp., 2973 Cropsey Ave., Brooklyn 14, N. Y.
- Art Roll Leaf Stamping Co., 3610 Palisade Ave., Union City, N. J.
- Art Specialty Co., 3245 W. Lake St., Chicago, Ill.
- Art Wire & Stamping Co., 227 High St., Newark 2, N. J.
- Artos Engineering Co., 2737 S. 28th St., Milwaukee, Wis.
- Arvin Industries Inc., Radio & Television Div., Columbus, Ind.
- Asheville-Schoonmaker Mica Co., 900 Jefferson Ave., Newport News, Va.
- Askania Regulator Co., 240 E. Ontario St., Chicago 11, Ill.
- Assembly Products, Inc., Chagrin Falls 6, Ohio.
- Associated Production Co., 162 N. Clinton St., Chicago 6, Ill.
- Associated Research, Inc., 3758 W. Belmont, Chicago 18, Ill.

Astatic Corp., The, Conneaut, Ohio.
Astron Corp., 255 Grant Ave., East Newark, N. J.
Atlantic Electronics, 4 Manhasset Ave., Manhasset, N. Y.
Atlantic Wire & Cable Corp., 254 Huron St., Brooklyn, N. Y.
Atlantic India Rubber Works, Inc., 571 Polk St., Chicago 7, Ill.
Atlas Coil Winders, Inc., Stamford, Conn.
Atlas Electric Products Co., P. O. Box 1591, Erie, Pa.
Atlas Metal Stamping Co., Castor & Kensington Aves., Philadelphia 24, Pa.
Atlas Resistor Co., 423 Broome St., New York 13, N. Y.
Atlas Sound Corp., 1443 39th St., Brooklyn 18, N. Y.
Atlas Tack Corp., Pleasant St., Fairhaven, Mass.
Atomic Instrument Co., 84 Massachusetts Ave., Cambridge 39, Mass.
Auburn Mfg. Co., Pease Ave. & Stack St., Middletown, Conn.
Audak Co., 500 Fifth Ave., New York, N. Y.
Audio Development Co., 2833 13th Ave., S., Minneapolis 7, Minn.
Audio Devices, Inc., 444 Madison Ave., New York 22, N. Y.
Audio Equipment Co., 80-20 45th Ave., Elmhurst, N. Y.
Audio Equipment Sales, 153 W. 33rd St., New York 1, N. Y.
Audio Industries, Michigan City, Ind.
Audio Instrument Co., 133 W. 14th St., New York 11, N. Y.
Audio-Master Corp., 341 Madison Ave., New York 17, N. Y.
Audio & Video Products Co., 1650 Broadway, New York, N. Y.
Aurex Corp., Chicago 10, Ill.
Austin Co., O., 335 Throop Ave., Brooklyn 21, N. Y.
Auto Engraver Co., Ridgefield, Conn.
Autocall Co., The, Shelby, Ohio.
Autocrat Radio Co., 5024 Elm St., Skokie, Ill.
Automatic Electric Sales Corp., 1033 W. Van Buren St., Chicago 7, Ill.
Automatic Mfg. Corp., 65 Gouverneur St., Newark 4, N. J.
Automatic Metal Products Co., 315 Barry St., Brooklyn 11, N. Y.
Automatic Radio Mfg. Co., Inc., 122 Brookline Ave., Boston, Mass.
Automatic Signal Div., Eastern Industries, Inc., 100 Regent St., East Norwalk, Conn.
Automatic Switch Co., 391 Lakeside Ave., Orange, N. J.
Automatic Temperature Control Co., Inc., 5212 Pulaski Ave., Philadelphia 44, Pa.
Autoscrew Co., 216-222 W. 18th Street, New York, N. Y.
Autotron Co., The, Danville, Ill.
Avion Instrument Corp., Paramus, N. J.

B & C Insulation Products, Inc., Lincoln Highway, Iselin, N. J.
Bache & Co., Semon, 636 Greenwich St., New York 14, N. Y.
Baer Co., N. S., 9 Montgomery St., Hillside, N. J.
Bailey Meter Co., 1044 Ivanhoe Road, Cleveland 10, Ohio.
Baird Associates, Inc., 33 University Rd., Cambridge 38, Mass.
Bakelite Co., A Div. of Union Carbide & Carbon Corp., 30 East 42nd St., New York 17, N. Y.
Baker & Co., Inc., 113 Astor St., Newark 5, N. J.
Baker Chemical Co., J. T., Phillipsburg, N. J.
Baldor Electric Co., 4353 Duncan Ave., St. Louis, Mo.
Baldwin-Lima-Hamilton Corp., Paschall P. O. Station, Philadelphia 42, Pa.
Ballantine Laboratories, Inc., Boonton, N. J.
Barber Colman Co., Rockford, Ill.
Barber Labs., Alfred W., 34-04 Francis Lewis Blvd., Flushing, N. Y.
Barclay Instruments Div., The Patent Button Co., Waterbury 88, Conn.
Bar-Ray Products, Inc., 209 25th St., Brooklyn 32, N. Y.
Bardwell & McAllister Inc., 2950 Ontario, Burbank, Calif.
Barker & Williamson, 235 Fairfield Ave., Upper Darby, Pa.
Barreca Products Co., Inc., 84 Bowery, New York 13, N. Y.
Barrett Bindery Co., 1332 W. Monroe St., Chicago 7, Ill.
Barrett Co., Leon J., P. O. Box 378, Worcester 1, Mass.
Barrett Varnish Co., 1532 S. 50th Court, Cicero 50, Ill.
Barry Corp., The, 700 Pleasant St., Watertown, Mass.
Bart Labs. Co., Inc., 227 Main St., Belleville 9, N. J.
Bart-Messing Corp., 227 Main St., Belleville 9, N. J.
Bassett Inc., Rex, 307-11 N. W. 1st Ave., Fort Lauderdale, Fla.
Bauer & Black, 222 W. Adams St., Chicago, Ill.
Bausch & Lomb Optical Co., 635 St. Paul St., Rochester 2, N. Y.
Bawkin Machine Co. 30 Burtis Ave. New Canaan, Conn.
Beach-Russ Co., 50 Church St., New York 7, N. Y.
Bead Chain Manufacturing Co., The, 110 Mountain Grove St., Bridgeport 5, Conn.
Beam Instruments Corp., 350 Fifth Ave., New York 1, N. Y.
Beaver Gear Works, Inc., 1034 Parmele St., Rockford, Ill.
Beckman Instruments, Inc., 820 Mission St., South Pasadena, Calif.
Beede Electrical Instrument Co., Inc., Penacook, N. H.
Behr-Manning Corp. Div. of Norton Co., Troy, N. Y.
Bel Fuse Inc., 311 Mountain Road, Union City, N. J.
Belden Mfg. Co., 4647 W. Van Buren St., Chicago 44, Ill.
Bell Sound Systems, Inc., 555 Marlon Rd., Columbus 7, Ohio.
Belling & Lee Ltd., 366 Madison Ave., New York 17, N. Y.
Belmont Radio Co., Div. Raytheon Mfg. Co., 5921 W. Dickens Ave., Chicago 39, Ill.

Belock Instrument Corp. 111th St. & 14th Ave. College Point, N. Y.
Beltone Hearing Aid Co., Beltone Bldg., 1450 W. 19th St., Chicago 8, Ill.
Benchmaster Mfg. Co., 2952 W. Pico Blvd., Los Angeles 6, Calif.
Bendix Aviation Corp., Pacific Division, 11600 Sherman Way, North Hollywood, Calif.
Bendix Radio Division, Bendix Aviation Corp., Baltimore 4, Md.
Bentley-Harris Mfg. Co., Conshohocken, Pa.
Berkeley Custom Electronics, 2571 Shattuck Ave., Berkeley, Calif.
Berkeley Scientific Corp., 2200 Wright Ave., Richmond, Calif.
Berkshire Laboratories 580 Lexington Rd., Concord, Mass.
Berlant Associates, 4917 W. Jefferson Blvd., Los Angeles 16, Calif.
Berndt-Bach, Inc., 7373 Beverly Blvd., Los Angeles 36, Calif.
Beryllium Corp., The, Reading, Pa.
Best Manufacturing Co., Inc., 1200 Grove St., Irvington 11, N. J.
Best Products Co., 350 Fifth Ave., New York 1, N. Y.

Bestcraft Products, 626 Broadway, New York, N. Y.
Beta Electric Corp., 333 E. 103rd St., New York 29, N. Y.
Biddle Co., James G., 1316 Arch St., Philadelphia 7, Pa.
Bird Co., Richard H., 1 Spruce St., Waltham, Mass.
Bird Electronic Corp., 1800 E. 38th St., Cleveland 14, Ohio.
Birnbach Radio Co., Inc., 145 Hudson St., New York, N. Y.
Bircher Corp., 5087 Huntington Drive, Los Angeles 32, Calif.
Bishop & Co., J., Platinum Works, Malvern, Pa.
Bishop Mfg. Corp., 254 W. 31st St., New York 1, N. Y.
Biwax Corp., 3445 Howard St., Skokie, Ill.
Blake Co., Whitney, Box K, New Haven 14, Conn.
Blake & Johnson Co., 1495 Thomaston Ave., Waterville 48, Conn.
Blaw-Knox Div. of Blaw-Knox Co., Farmers Bank Bldg., Pittsburgh 22, Pa.
Bliley Electric Co., Union Station Bldg., Erie, Pa.
Bludworth Marine Div., National-Simplex-Bludworth, Inc., 92 Gold St., New York 38, N. Y.
Bodine Electric Co., Ohio St. & Oakley Blvd., Chicago 12, Ill.
Boehme Inc., H. O., 915 Broadway, New York 10, N. Y.
Boesch Mfg. Corp., Danbury, Conn.
Bogen Co., Inc., David, 663 Broadway, New York 12, N. Y.
Boque Electric Mfg. Co., 52 Iowa Ave., Paterson 3, N. J.
Bomac Laboratories, Salem Rd., Beverly, Mass.
Bond Electric Corp., Div. of Oilin Industries Inc., New Haven 4, Conn.
Bond Electronics Corp., 88 Franklin Place, Summit, N. J.
Bone Engineering Co., 701 W. Broadway, Glendale 4, Calif.
Boom Electric & Amplifier Co., 1227 W. Washington Blvd., Chicago 7, Ill.
Boonton Molding Co., Boonton, N. J.
Boonton Radio Corp., Boonton, N. J.
Booth Co., Arthur E., 4124 Beverly Blvd., Los Angeles 4, Calif.
Boots Aircraft Nut Corp., 50 John St., Stamford, Conn.
Borg Equipment Division, The George W. Borg Corp., Delavan, Wis.
Borden Co., The, Chemical Div., 350 Madison Ave., New York 17, N. Y.
Borthig Co., Inc., George C., P. O. Box 115, East Rutherford, N. J.
Boston Insulated Wire & Cable Co., 63 Bay St., Boston 25, Mass.
Boulin Instrument Corp., 65 Madison Avenue, New York 16, N. Y.
Bowers Battery & Spark Plug Co., Reading, Pa.
Bowser Technical Refrigeration Div., Bowser, Inc., Terryville, Conn.
Bozak Co., R. T., 90 Montrose Ave., Buffalo 14, N. Y.
Brach Mfg. Corp., 200 Central Ave., Newark 4, N. J.
Bracke-Seib X-Ray Co., Inc., 293 3rd Ave., New York, N. Y.
Bradley Labs., Inc., 82 Meadow St., New Haven 10, Conn.
Brady Co., W. H., 1612 E. Spring St., Chipewea Falls, Wis.
Brainin Co., C. S., 320 Washington St., Mt. Vernon, N. Y.
Brand & Co., Inc., Wm., North & Valley Sts., Williamantic, Conn.
Brandywine Fibre Co., 15th & Poplar Sts., Wilmington, Del.
Branson Instrument, Inc., 438 Fairfield Ave., Stamford, Conn.
Branstetter Electric Mfg. Co., Inc., 62 Gill Pl., Buffalo 22, N. Y.
Breeze Corpn., Inc., 41 S. Sixth St., Newark 7, N. J.
Breco Electronics Corp., 55 Vandam St., New York 13, N. Y.
Breon Laboratories, 1520 Evergreen Rd., Williamsport, Pa.
Brew & Co., Inc., Richard D., 106 Concord Ave., Belmont 78, Mass.
Bridgeport Brass Co., 30 Grand St., Bridgeport, Conn.
Bridgeport Hardware Mfg. Corp., Iranistan Ave., Bridgeport, Conn.
Bright Star Battery Co., 200 Crooks Ave., Clifton, N. J.
Brilmayer Labs., Inc., E. W., 86 Fulton St., New York 38, N. Y.
Brinnell Company, The, Granby, Conn.
Bristol Co., The, Waterbury 20, Conn.
Bristol Motor Co., Old Saybrook, Conn.
British Industries Corp., 164 Duane St., New York 13, N. Y.

Brociner Electronics Laboratory, 1546 Second Ave., New York 28, N. Y.
Brook Electronics, Inc., Box 491, Elizabeth, N. J.
Brooklyn Varnish Mfg. Co., 50 Jay St., Brooklyn, N. Y.
Brown-Bridge Mills, Inc., Troy, Ohio.
Brown Electro-Measurement Corp., 4637 SE Hawthorne Blvd., Portland 15, Ore.
Browning Laboratories, Inc., 750 Main St., Winchester, Mass.
Brujac Electronic Corp., 103 Lafayette St., New York 13, N. Y.
Bruning Co., Inc., Charles, 102 Reade St., New York, N. Y.
Brush Beryllium Co., The, 4301 Perkins Ave., Cleveland 3, Ohio.
Brush Development Company, The, 3405 Perkins Ave., Cleveland 14, Ohio.
Buchanan Electrical Products Corp., 223 Route 29, Hillside, N. J.
Buck Engineering Co., 37-41 Marcy St., Freehold, N. J.
Bud Radio, Inc., 2118 E. 55th St., Cleveland 3, Ohio.
Buda Co., The, Harvey, Ill.
Buffalo Electronics Corp., Buffalo, N. Y.
Buggie & Co., H. H., 726 Stanton St., Toledo, Ohio.
Buhl Optical Co., 1009 Beech Ave., Pittsburgh 12, Pa.
Bunnell and Co., J. H., 81 Prospect St., Brooklyn, N. Y.
Burgess Battery Co., Battery Div., Freeport, Ill.
Burke Electric Co., 12th & Cranberry Sts., Erie, Pa.
Burling Instrument Co., 5 Vose Ave., South Orange, N. J.
Burdett Mfg. Co., 3420 W. Madison St., Chicago 24, Ill.
Burlington Instrument Co., Burlington, Iowa.
Burndy Engineering Co., Inc., 107 Bruckner Blvd., New York 54, N. Y.
Burnell & Co., 45 Warburton Ave., Yonkers 2, N. Y.
Burnley Battery & Mfg. Co., Clay St., North East, Pa.
Bussman Mfg. Co., St. Louis 7, Mo.
Butler Mfg. Co., Inc., B. B., 3432 N. Avondale Ave., Chicago 18, Ill.

C.G.S. Laboratories, Inc., 391 Ludlow St., Stamford, Conn.
C-O-Two Fire Equipment Co., P. O. Box 390, U. S. Highway 1, Newark 1, N. J.
Cable Electric Products Co., Providence, R. I.
Caddell-Burns Mfg. Co., 40 E. Second St., Mineola, N. Y.
Calbest Engineering & Electronics Co., 628 N. Highland Ave., Hollywood 38, Calif.
Calidyne Co., The, 751 Main St., Winchester, Mass.
Califone Corp., 1041 N. Sycamore Ave., Hollywood 38, Calif.
Caltron Co., 1406 So. Hobart Blvd., Los Angeles 6, Calif.
Cambridge Thermionic Corp., 445 Concord Ave., Cambridge 38, Mass.
Camburn, Inc., 32-40 57th St., Woodside, N. Y.
Camera Equipment Co., 1600 Broadway, New York, N. Y.
Camloc Fastener Corp., 420 Lexington Ave., New York 17, N. Y.
Campbell Industries, Inc., Chattanooga, Tenn.
Canadian Radium & Uranium Corp., 630 Fifth Ave., New York 20, N. Y.
Cannon Co., C. F., Springwater, N. Y.
Cannon Electric Development Co., 3209 Humboldt St., Los Angeles 31, Calif.
Capehart-Farnsworth Corp., Fort Wayne, Indiana.
Capps & Co., Inc., Frank L., 244 W. 49th St., New York 19, N. Y.
Carboloy Company Inc., 11139 E. Eight Mile Blvd., Detroit 32, Mich.
Carboneau Industries, Inc., Grand Raids, Mich.
Cardwell Mfg. Corp., Allen D., 97 Whiting St., Plainville, Conn.
Carling Electric, Inc., 505 New Park Ave., West Hartford 10, Conn.
Carol Cable Co., 190 Middle St., Pawtucket, R. I.
Carpenter Steel Co., Union, N. J.
Carpenter Steel Co., The, 142 West Bern St., Reading, Pa.
Carron Mfg. Co., 415 S. Aberdeen St., Chicago, Ill.
Carson Micrometer Corp., 2 E. Main St., Little Falls, N. J.
Carter Motor Co., 2646 N. Maplewood Ave., Chicago 47, Ill.
Carter Parts Co., 213 Institute Place, Chicago 10, Ill.
Cascade Television Co., 179 South St., Newark, N. J.
Catalin Corp. of America, 1 Park Ave., New York 16, N. Y.
Celanese Corp. of America, 180 Madison Ave., New York 16, N. Y.
Cellusuede Products, Inc., Rockford, Ill.
Central Paper Co., Inc., 2400 Lakeshore Drive, Muskegon, Michigan.
Central Scientific Co., 1700 Irving Park Rd., Chicago 13, Ill.
Central Screw Co., 3501 Shields Ave., Chicago 9, Ill.
Central Stamping & Mfg. Co., Polo, Ill.
Centralab, Div. of Globe Union Inc., 900 E. Keefe Ave., Milwaukee 1, Wis.
Centronics Co., 5065 Broadway, New York, N. Y.
Century Electric Co., 1806 Pine St., St. Louis 3, Mo.
Century Geophysical Corp., 1333 North Utica, Tulsa, Oklahoma.
Century Lighting, Inc., 521 W. 43rd St., New York 18, N. Y.
Cerro de Pasco Copper Corp., 40 Wall St., New York 5, N. Y.
Chandler Products Co., 1491 Chardon Rd., Cleveland, Ohio.
Channel Master Co., Ellenville, N. Y.
Chase Brass & Copper Co., Inc., 236 Grand St., Waterbury 20, Conn.
Chatham Electronics Corp., 475 Washington St., Newark 2, N. J.
Chatillon & Sons, John, 93 Cliff St., New York 38, N. Y.

Cherry Rivet Co., A Div. of Townsend Co., 231 Winston Street, Los Angeles 13, Calif.

Chester Cable Corp., Hill St., Chester, N. Y.

Chicago Condenser Corp., 3255 W. Armitage Ave., Chicago 47, Ill.

Chicago Dial Co., Chicago, Ill.

Chicago Die Mold Mfg. Co., 4001 Wrightwood Ave., Chicago 39, Ill.

Chicago Expansion Bolt Co., 1338 W. Concord Pl., Chicago 22, Ill.

Chicago Industrial Instrument Co., 536 W. Elm St., Chicago 10, Ill.

Chicago Metal Hose Corp., 1315 S. Third Ave., Maywood, Ill.

Chicago Rivet & Machine Co., 9600 W. Jackson Blvd., Chicago, Ill.

Chicago Telephone Supply Corp., 1142 W. Beardsley Ave., Elkhart, Ind.

Chicago Transformer Div., Essex Wire Corp., 3501 W. Addison St., Chicago 18, Ill.

Churchill Corp., 7 North Ave., Wakefield, Mass.

Ciba Co., Inc., 627 Greenwich St., New York 14, N. Y.

Cima Corp., 91 Boylston St., Jamaica Plains 30, Mass.

Cinaudagraph Speakers, 7334 N. Clark St., Chicago 26, Ill.

Cinch Mfg. Corp., 1026 S. Homan Ave., Chicago 24, Ill.

Cinema Engineering Co., 1510 W. Verdugo Ave., Burbank, Calif.

Citation Products Co., 233 E. 146th St., New York 51, N. Y.

Clare & Co., C. P., 4719 Sunnyside Ave., Chicago 30, Ill.

Clarendon Glass Blowing Co., 772 Second St., Secaucus, N. J.

Clark Controller Co., 1146 E. 152nd St., Cleveland, 10, Ohio.

Clark Crystal Co., 2 Farm Rd., Marlboro, Mass.

Clark Electronic Labs., Box 165, Palm Springs, Calif.

Clarke Instrument Div., National Electrical Machine Shops, Inc., 919 Jesup-Blair Drive, Silver Spring, Md.

Clarkstan Corp., 11921 SW. Pico Blvd., Los Angeles 64, Calif.

Clarostat Mfg. Co., Inc., Dover, N. H.

Clear Beam Television Antenna Co., 618 N. La Brea Ave., Los Angeles 36, Calif.

Clearprint Paper Co., 677 Folsom St., San Francisco, Calif.

Cleveland Container Co., The, 6201 Barberton Ave., Cleveland 2, Ohio.

Cleveland Electronics, Inc., 6611 Euclid Ave., Cleveland, Ohio.

Clippard Instrument Laboratory, Inc., 1125 Bank St., Cincinnati 14, Ohio.

Clough Brengle Co., 6014 N. Broadway, Chicago, Illinois.

Cohan-Epner Co., Inc., 142 W. 14th St., New York 11, N. Y.

Cohn Corp., Sigmund, 44 Gold St., New York 7, N. Y.

Coil Winders Inc., 61 Bergen St., Brooklyn 2, N. Y.

Coil Winding Equipment Co., 37 W. Main St., Oyster Bay, N. Y.

Coilcraft, Inc., 3716 N. Cicero Ave., Chicago 41, Ill.

Cole Instrument Co., 1320 S. Grand Ave., Los Angeles 15, Calif.

Cole Radio Works, 86 Westville Ave., Caldwell, N. J.

Cole Steel Equipment Co., 285 Madison Ave., New York 17, N. Y.

Coleman Instruments, Inc., 318 Madison St., Maywood, Illinois.

Colgate Mfg. Corp., Lindenhurst, N. Y.

Collins Audio Products Co., P. O. Box 368, Westfield, N. J.

Collins Radio Co., Cedar Rapids, Iowa.

Collyer Insulated Wire Co., 249 Roosevelt Ave., Pawtucket, R. I.

Columbia Electric Mfg. Co., 4519 Hamilton Ave., N. E., Cleveland 14, Ohio.

Columbia Metal Box Co., 260 E. 143rd St., New York, N. Y.

Columbia Wire & Supply Co., 2850 Irving Park Rd., Chicago 18, Ill.

Comar Electric Co., 3349 W. Addison St., Chicago 18, Ill.

Combustion Control Corp., 77 Broadway, Cambridge 42, Mass.

Combustion Research Laboratories, Inc., 104-16 Metropolitan Ave., Forest Hills, N. Y.

Commercial Equipment Co., Inc., Box 168, Lawrence, Kansas.

Commercial Radio Sound Corp., 575 Lexington Ave., New York 22, N. Y.

Commodore Record Co., 289 Nepperhan Ave., Yonkers 2, N. Y.

Communication Accessories Co., Box 345, 110th St., & Hillcrest Rd., Hickman Hills, Mo.

Communication Measurements Lab. Inc., 120 Greenwich St., New York 6, N. Y.

Communication Products Co., Inc., Marlboro, N. J.

Communications Co., Inc., 300 Greco Ave., Coral Gables 34, Fla.

Computer Corp. of America, 149 Church St., New York, N. Y.

Conant Labs., 6500 O St., Lincoln 5, Nebraska.

Condenser Products Co., 7517 N. Clark St., Chicago 26, Ill.

Condor Radio Mfg. Co., 631 Whipple, Prescott, Ariz.

Conn Ltd., C. G., Electronics Div., 1001 Beardsley Ave., Elkhart, Ind.

Connecticut Hard Rubber Co., 407 East St., New Haven 9, Conn.

Connecticut Telephone & Electric Corp., 70 Britannia St., Meriden, Conn.

Conrac, Inc., Glendora, Calif.

Consolidated Engineering Corp., 300 N. Sierra Madre Villa, Pasadena 8, Calif.

Consolidated Molded Products Corp., Scranton 2, Pa.

Consolidated Radio Products Co., 350 W. Erie St., Chicago 10, Ill.

Consolidated Wire & Associated Companies, 1635 S. Clinton St., Chicago 16, Illinois.

Continental Can Co., Inc., 100 E. 42nd St., New York 17, N. Y.

Continental Carbon, Inc., 13900 Lorain Ave., Cleveland 11, Ohio.

Continental Diamond Fibre Co., Newark 100, Delaware.

Continental Electric Co., Geneva, Ill.

Continental Electric Co., Inc., 334 Ferry St., Newark 5, N. J.

Continental Electronics Mfg. Co., 4212-20 S. Buckner Blvd., Dallas 10, Texas.

Continental Screw Co., New Bedford, Mass.

Control Corp., 718 Central Ave., Minneapolis 14, Minn.

Control Engineering Corp., 863 Washington St., Canton, Mass.

Cook Ceramic Mfg. Co., 501 Prospect St., Trenton 1, N. J.

Cook Electric Co., 2700 Southport Ave., Chicago 14, Ill.

Cook Laboratories, 139 Gordon Blvd., Floral Park, N. Y.

Cooper Electronic Products Co., 4500 Melrose St., Philadelphia 24, Pa.

Copperweld Steel Co., Glassport, Pa.

Coral Designs Div. of Henry G. Dietz Co., 12-16 Astoria Blvd., Long Island City 2, N. Y.

Cornell Dubilier Electric Corp., South Plainfield, N. J.

Corning Glass Works, Corning, N. Y.

Cornish Wire Co., 50 Church St., New York 7, N. Y.

Corona Engineering Service, 94-32 Corona Ave., Elmhurst, N. Y.

Coronet Radio & Television Corp., 500 W. 52nd St., New York 19, N. Y.

Corry-Jamestown Mfg. Co., Corry, Pa.

Corson Electric Mfg. Corp., 540 39th St., Union City, N. J.

Cortland Industries, Inc., 4545 Cortland St., Chicago 39, Ill.

Cosa Corp., 405 Lexington Ave., New York 17, N. Y.

Cosmic Radio Corp., 953 Whittier St., New York 59, N. Y.

Cossor (Canada) Ltd., 301-303 Windsor St., Halifax, N. S., Canada.

Cosor Ltd., A. C., 350 Fifth Ave., New York 1, N. Y.

Cotto-Coil Co., Inc., 65 Pavilion Ave., Providence 5, R. I.

Coulter Electronics, 3123 Fulton St., Chicago 12, Ill.

Craft Mfg. Co., 3949 W. Schubert St., Chicago, Ill.

Cramer Co., Inc., R. W., Box 13, Centerbrook, Conn.

Crane Packing Co., 1800 Cuyler Ave., Chicago 13, Ill.

Crescent Industries, Inc., 4140 Belmont Ave., Chicago 41, Ill.

Crest Transformer Corp., 1834-36 W. North Ave., Chicago 22, Ill.

Crestwood Recorder Corp., 221 N. LaSalle, Chicago 1, Ill.

Croname, Inc., 3701 Ravenswood Ave., Chicago, Ill.

Crosby Labs., Inc., 126 Herricks Rd., Mineola, N. Y.

Crosby Div., Avco Mfg. Corp., Cincinnati 25, Ohio.

Cross Co., H., 15 Beekman St., New York, N. Y.

Crowley & Co., Inc., Henry L., 1 Central Ave., West Orange, N. J.

Crown Controls Co., Inc., New Bremen, Ohio.

Crucible Steel Co. of America, 405 Lexington Ave., New York 17, N. Y.

Crystal Research Labs. Inc., 29 Allyn St., Hartford, Conn.

Curtis Development and Mfg. Co., 4524 W. Madison St., Chicago 24, Ill.

Custom Craft Mfg. Co., 256 E. 98th St., Brooklyn, N. Y.

Cutler Metal Products Co., 1025 Line St., Camden, N. J.

Cutler-Hammer, Inc., 411 No. 12th St., Milwaukee 1, Wis.

Cyclohm Motor Corp. Div., Howard Industries, Inc., Racine, Wis.

Cyclotron Specialties Co., Moraga 8, Calif.

DX Radio Products Co., Inc., 2304 Armitage Ave., Chicago 47, Ill.

Dage Electric Co., 4007 E. Michigan Ave., Indianapolis 1, Ind.

Dahlstrom Metallic Door Co., Jamestown, N. Y.

Dale Products, Inc., Columbus, Neb.

Dallons Labs., 5066 Santa Monica Blvd., Los Angeles, Calif.

Dalmo Victor Co., 1414 El Camino Real, San Carlos, Calif.

Dalmator Co., 1375 Clay St., Santa Clara, Calif.

Daniels, Inc., C. R., Daniels P. O., Baltimore, Md.

Dano Electric Co., Main St., Winsted, Conn.

Dante Electric Mfg. Co., Bantam, Conn.

Daven Co., 191 Central Ave., Newark 4, N. J.

Davies Laboratories, Inc., 4705 Queensbury Rd., Riverdale, Md.

Davies Molding Co., Harry, 1428 N. Wells St., Chicago 10, Ill.

Davis & Co., Dean W., 3418 N. Milwaukee Ave., Chicago, Ill.

Davis Electric Co., Cape Girardeau, Mo.

Dayco Radio Corp., 915 Valley St., Dayton 4, Ohio.

Daystrom Electric Corp., 837 Main St., Poughkeepsie, N. Y.

Decca Records, Inc., 50 W. 57th St., New York 19, N. Y.

Decimeter Inc., 1430 Market St., Denver 2, Colorado.

De Coursey Engineering Lab., P. O. Box 235, Los Angeles 25, Calif.

Dee Electric Co., 1101 N. Paulina St., Chicago 22, Ill.

Deitz Co., S. J., Box 65, W. Englewood, N. J.

Deitz Miracle Lens Co., 141 President St., Passaic, N. J.

DeJur-Amsco Corp., Northern Blvd. at 45th St., Long Island City 1, N. Y.

Delco Appliance Div., General Motors Corp., 391 Lyell Ave., Rochester, N. Y.

Delco Radio Div., General Motors Corp., Kokomo, Ind.

Delmhorst Instrument Co., 601 Cedar St., Boonton, N. J.

De-Tec-Tronic Laboratories, Inc., 1711 Terra Cotta Pl., Chicago 14, Ill.

Deutschmann Corp., Tobe, 921 Providence Highway, Norwood, Mass.

DeWald Radio Mfg. Corp., 35-15 37th Ave., Long Island City, N. Y.

Dial Light Co. of America, Inc., 900 Broadway, New York 3, N. Y.

Diamond Drill Carbon Co., 53-63 Park Row, New York 7, N. Y.

Diamond Mfg. Co., Wakefield, Mass.

Diamond Power Specialty Corp., Lancaster, Ohio.

Diamond Wire & Cable Co., Sycamore, Ill.

Dice Co., J. W., Englewood, N. J.

Dictaphone Corp., 420 Lexington Ave., New York 17, N. Y.

Diehl Manufacturing Co., 1129 Finnerne Ave., Somerville, N. J.

Dielectric Materials Co., 5315-17 N. Ravenswood Ave., Chicago 40, Ill.

Dielectric Products Co., Inc., 125 Virginia Ave., Jersey City 5, N. J.

Dietz Design & Mfg. Co., Grandview 6, Mo.

Dietsgen Co., Eugene, 2425 Sheffield Ave., Chicago, Ill.

Dilks Co., The, Seymour, Conn.

Dillon & Co., Inc., W. C., 1421 S. Circle Ave., Forest Park, Ill.

Dimco-Gray Co., 207 E. Sixth St., Dayton, Ohio.

Distillation Products Div. of Eastman Kodak Co., 755 Ridge Rd. W., Rochester 3, N. Y.

Division Lead Co., 836 W. Kinzie St., Chicago 22, Ill.

Dixon Crucible Co., Joseph, Jersey City 3, N. J.

Do All Co., 254 N. Laurel Ave., Des Plaines, Ill.

Doelcam Corp., 56 Elmwood St., Newton 58, Mass.

Dolph Co., John C., Monmouth Junction, N. J.

Dongan Electric Mfg. Co., 2987 Franklin St., Detroit, Mich.

Donnelly Electric & Mfg. Co., 3050 Washington St., Boston, Mass.

Doolittle Radio, Inc., 7421 S. Loomis Blvd., Chicago 36, Ill.

Dormitzer Electric & Mfg. Co., Inc., 89 Brighton Ave., Boston 34, Mass.

Douglas Radio Labs., 176 Norfolk Ave., Boston 19, Mass.

Douglas-Randall, Inc., 102 High St., Westerly, R. I.

Dow Chemical Co., Midland, Mich.

Dow Corning Corp., Midland, Mich.

Drake Electric Works, 3656 Lincoln Ave., Chicago 13, Ill.

Drake Mfg. Co., 1713 Hubbard St., Chicago, Ill.

Dresser Electric Co., 942 E. Larned St., Detroit 7, Mich.

Dresser Equipment Co., Ideco Div., 875 Michigan Ave., Columbus 8, Ohio.

Driver Co., Wilbur B., 150 Riverside Ave., Newark 4, N. J.

Driver-Harris Co., 201 Middlesex St., Harrison, N. J.

DuBois Co., Ltd., 366 Madison Ave., New York 17, N. Y.

Dudek & Bock Spring & Mfg. Co., 2100 W. Fulton, Chicago 12, Ill.

Dumont Electric Co., 308 Dyckman St., New York, N. Y.

DuMont Laboratories, Inc., Allen B., Electronic Parts Div., 35 Market St., East Paterson, N. J.

DuMont Laboratories, Inc., Allen B., Instrument Div., 1000 Main Ave., Clifton, N. J.

DuMont Laboratories, Inc., Allen B., Television Receiver Div., 35 Market St., East Paterson, N. J.

DuMont Laboratories, Inc., Allen B., Television Transmitter Div., 1000 Main Ave., Clifton, N. J.

DuMont Laboratories, Inc., Allen B., Cathode-ray Tube Div., 750 Bloomfield Ave., Clifton, N. J.

Dumore Co., The, 1300 Seventeenth St., Racine, Wis.

Duotone Co., Inc., Keyport, N. J.

du Pont de Nemours & Co., Inc., E. I., Wilmington, Del.

Durakool, Inc., 1010 N. Main St., Elkhart, Ind.

Durant Mfg. Co., 1912 N. Buffum St., Milwaukee 1, Wis.

Durez Plastics & Chemicals, Inc., 1921 Walck Rd., North Tonawanda, N. Y.

Dynamic Air Engineering Inc., 1619 S. Alameda St., Los Angeles, Calif.

Dynamic Resistor Corp., 6 Cutter Mill Rd., Great Neck, N. Y.

Dzus Fastener Co., Inc., Box 785, Babylon, N. Y.

Eagle Electric Mfg. Co., Inc., 23-10 Bridge Plaza S., Long Island City, N. Y.

Eagle Pencil Co., 703 E. 13th St., New York, N. Y.

Eagle Signal Corp., Moline, Ill.

Earnshaw-Tharp-Christensen Corp., Box 35, Verdi, Nev.

Eastern Air Devices Inc., 585 Dean St., Brooklyn 17, N. Y.

Eastern Heat Treating & Brazing Corp., 250 W. 54th St., New York 19, N. Y.

Eastern Metals Industries, Inc., 250 W. 54th St., New York 19, N. Y.

Eastern Mike-Stand Co., 56 Christopher Ave., Brooklyn 12, N. Y.

Eastern Smelting & Refining Corp., 107-109 W. Brookline St., Boston 18, Mass.

Eastern Specialty Co., Philadelphia 40, Pa.

Eastman Kodak Co., Industrial Photographic Div., 343 State St., Rochester 4, N. Y.

Easy-Up Tower Co., 427 Romyne Ave., Racine, Wis.

Eberhard Faber Pencil Co., 37 Greenpoint Ave., Brooklyn 22, N. Y.

Ebert Electronics Corp., 185-09 Jamaica Ave., Hollis 7, N. Y.

Eby, Inc., Hugh H., 4700 Stenton Ave., Philadelphia 44, Pa.

Ecco High Frequency Corp., 7020 Hudson Blvd., North Bergen, N. J.

Eckert-Mauchly Computer Corp., 3747 Ridge Ave., Philadelphia 32, Pa.

Eckstein Radio & Television Co., 3400 E. 42nd St., Minneapolis 6, Minn.

Eclipse Pioneer Div., Bendix Aviation Corp., Teterboro, N. J.

Economy Fuse & Mfg. Co., 2717 Greenview Ave., Chicago 14, Ill.

Edgerton, Germeshausen & Grier, Inc., 160 Brookline Ave., Boston, Mass.

Edin Co., Inc., 207 Main St., Worcester, Mass.

Edison, Inc., Thomas A., Ediphone Div., 51 Lakeside Ave., West Orange, N. J.

Edison, Inc., Thomas A., Instrument Div., West Orange, N. J.

Edo Corp., College Point, N. Y.

Edwards Co., Inc., 86 Boston Post Rd., Norwalk, Conn.

Egyptian Lacquer Mfg. Co., Lafayette, Ind.

Elcor, Inc., 1501 W. Congress St., Chicago 7, Ill.

Eldon Electronic Co., 1802 N. Third St., Temple, Texas.

Eisler Engineering Co., Inc., 740 S. 13th St., Newark 3, N. J.

Eitel-McCullough, Inc., San Bruno, Calif.

Elastic Stop Nut Corp., 2330 Vauxhall Rd., Union, N. J.

Elco Corp., 190 W. Glenwood Ave., Philadelphia 40, Pa.

Electrad Co., Portsmouth, N. H.

Electra Mfg. Co., Resistor Div., 2537 Madison Ave., Kansas City, Mo.

Electran Mfg. Co., 1901 Clybourn, Chicago 3, Ill.

Electric Design & Mfg. Corp., Burlington, Iowa.

Electric Eye Equipment Co., 16 W. Fairchild St., Danville, Ill.

Electric Indicator Co., 21 Parker Ave., Stamford, Conn.

Electric Machinery Mfg. Co., 1331 N.E. Tyler St., Minneapolis 13, Minn.

Electric Motor Corp. Div., Howard Industries, Inc., Racine, Wis.

Electric Regulator Corp., 1938 Park Ave., New York 35, N. Y.

Electric Soldering Iron Co., W. Elm St., Deep River, Conn.

Electric Storage Battery Co., Allegheny Ave. & 19th St., Philadelphia 32, Pa.

Electric Tachometer Corp., 2218 Vine St., Philadelphia 3, Pa.

Electrical Industries, Inc., 44 Summer Ave., Newark 4, N. J.

Electrical Reactance Corp., Seneca Ave., Olean, N. Y.

Electrical Refractories Co., 50 Clark St., East Palestine, Ohio.

Electrical Windings, Inc., 2015 N. Kolmar Ave., Chicago 39, Ill.

Electricoil Transformer Co., Westerly Rd., Ossining, N. Y.

Electro Acoustic Industries Ltd., 366 Madison Ave., New York 17, N. Y.

Electro Chemical Engineering Co., 750 Broad St., Emmaus, Pa.

Electro Craft, Inc., 52 Davenport St., Stamford, Conn.

Electro Development Corp., 6014 W. Washington Blvd., Culver City, Calif.

Electro Engineering & Mfg. Co., 627 W. Alexandrine, Detroit 1, Mich.

Electro Engineering Works, 6021 College Ave., Oakland 18, Calif.

Electro-Mechanical Instrument Co., 812 Chestnut St., Perkasie, Pa.

Electro-Mechanical Research, Inc., Ridgefield, Conn.

Electro-Mec Laboratory, 225 Broadway, New York 7, N. Y.

Electro-Medical Lab., Inc., South Woodstock, Vt.

Electro Metallurgical Division, Union Carbide and Carbon Corp., 30 E. 42nd St., New York 17, N. Y.

Electro Motive Mfg. Co., South Park & John St., Williamstown, Conn.

Electro-Nite Carbon Co., 1133 E. Columbia Ave., Philadelphia 25, Pa.

Electro-Physical Laboratories, Harvard Ave., Stamford, Conn.

Electro Precision Products, Inc., 119-01 22nd Ave., College Point, N. Y.

Electro Products Labs., 4501 N. Ravenswood Ave., Chicago 40, Ill.

Electro-Seal Corp., 946 Lee St., Des Plaines, Ill.

Electro Tec Corp., South Hackensack, N. J.

Electro-Technical Products Div of Sun Chemical Corp., 113 E. Centre St., Nutley 10, N. J.

Electro-Voice, Inc., Buchanan, Mich.

Electro-Wire Service, 5 Beekman St., New York 7, N. Y.

Electrochemical Industries, Inc., Jacques St., Worcester, Mass.

Electrodyn Company, 32 Oliver St., Boston, Mass.

Electrofax Corp., 30 Burtis Ave., New Canaan, Conn.

Electron Equipment Corp., 917 Meridian Ave., South Pasadena, Calif.

Electrona Corp., 1068 Clinton Ave., Irvington, N. J.

Electronic Apparatus Co., Elkhart, Ind.

Electronic Associates, Inc., Long Branch, N. J.

Electronic Batteries Inc., Bush Terminal Bldg No. 4, 28-34 35th St., Brooklyn 32, N. Y.

Electronic Brazing Co., 140 Glenridge Ave., Montclair, N. J.

Electronic Coils, Inc., P. O. Box 1641, 44 Taylor St., Springfield, Mass.

Electronic Computer Corp., 265 Butler St., Brooklyn 17, N. Y.

Electronic Control Co., 3124 Avenue L, Brooklyn 10, N. Y.

Electronic Control Corp., 1573 E. Forest St., Detroit, Mich.

Electronic Designs, Inc., 28-30 School St., Yonkers, N. Y.

Electronic Development Laboratory, 43-07 23rd Ave., Long Island City 5, N. Y.

Electronic Engineering Associates, Ltd., 1048 Brittan Ave., San Carlos, Calif.

Electronic Engineering Corp., 469 Elm St., Arlington, N. J.

Electronic Enterprises, Inc., 65 7th Ave., Newark 4, N. J.

Electronic Indicator Corp., 259 Green St., Brooklyn 22, N. Y.

Electronic Instrument Co., Inc., 276 Newport St., Brooklyn 12, N. Y.

Electronic Mfg. Co., 20 Orange St., Newark, N. J.

Electronic Measurements Company, Red Bank, N. J.

Electronic Measurements Corp., 280 Lafayette St., New York 12, N. Y.

Electronic Mechanics, Inc., 70 Clifton Blvd., Clifton, N. J.

Electronic Processes Corp., 260 N. First St., San Jose 18, Calif.

Electronic Products Co., 111 E. Third St., Mt. Vernon, N. Y.

Electronic Products Div., Epco Products, Inc., 2430 Atlantic Ave., Brooklyn 33, N. Y.

Electronic Specialty Co., 3456 Glendale Blvd., Los Angeles 39, Calif.

Electronic Surgical Equipment Co., Inc., N. E. Cor. 23 & Arch Sts., Philadelphia 3, Pa.

Electronic Transformer Co., Inc., 215 W. 25th St., New York, N. Y.

Electronic Tube Corp., 1200 E. Mermald Ave., Philadelphia 18, Pa.

Electrons, Inc., 127 Sussex Ave., Newark 4, N. J.

Electrovox Co., Inc., 60 Franklin St., East Orange, N. J.

Electryme Motor Products Corp., 565 W. Washington Blvd., Chicago 6, Ill.

Ellis Associates, Box 77, Pelham 65, N. Y.

Elm Laboratories, 18 South Broadway, Dobbs Ferry, N. Y.

Elpar Co., 539 Market St., Camden 2, N. J.

Eltron Inc., 407 N. Jackson St., Jackson, Mich.

El-Tronics, Inc., 2649 No. Howard St., Philadelphia 33, Pa.

Embassy Engineering Corp., 224 E. 204th St., New York 58, N. Y.

Emeloid Co., Inc., The, 1239 Central Ave., Hillside 5, N. J.

Emerson & Cuming Co., 126 Massachusetts Ave., Boston 15, Mass.

Emerson Radio & Phonograph Corp., 111 8th Ave., New York, N. Y.

Empire Coil Co., Inc., Beechwood Ave. & Second St., New Rochelle, N. Y.

Empire Devices, Inc., 38-25 Bell Blvd., Bayside, N. Y.

Engineering Co., 27 Wright St., Newark, N. J.

Engineering Lab., Inc., 602 E. 4th St., Tulsa 3, Okla.

Engineering Research Associates, Inc., 1902 W. Minnehaha Ave., St. Paul 4, Minn.

Engineering Research Corp., Shreveport, La.

Englewood Electrical Supply Co., 5801 S. Halsted St., Chicago, Ill.

Ensign Coil Co., 2516 S. Pulaski Rd., Chicago, Ill.

Enthoven & Sons Ltd., H. J., London, England-Sls. Agt. Maurice H. Esser, Dept. A, 113 N. Water St., Rochester 4, N. Y.

Eppley Lab., Inc., The, Newport, R. I.

Equipment & Service Co., 6815 Oriole Drive, Dallas 9, Texas.

Erco Radio Labs., Inc., East Stewart Ave., Gardon City, N. Y.

Erie Resistor Corp., 644 W. 12th St., Erie, Pa.

Espey Mfg. Co., Inc., 528 E. 72nd St., New York, N. Y.

Ess Specialty Corp., 96 So. Washington Ave., Bergenfield, N. J.

Essex Electronics, Berkeley Heights, N. J.

Essex Wire Corp., 1601 Wall St., Fort Wayne 6, Ind.

Esterline-Angus Co., P. O. Box 596, Indianapolis 6, Ind.

Etched Products Corp., 39-01 Queens Blvd., Long Island City, N. Y.

Etraco Mfg. Co., Inc., Woods Church Rd., Flemington, N. J.

Eureka Television & Tube Corp., 69 Fifth Ave., Hawthorne, N. J.

Eutectic Welding Alloys Corp., 40 Worth St., New York 13, N. Y.

Ewald Cabinet Co., 2559 W. 21st St., Chicago 8, Ill.

Executone, Inc., 415 Lexington Ave., New York 17, N. Y.

Eyelet Tool Co., 188 Dorchester Ave., Boston, Mass.

Fada Radio & Electric Co., Inc., 525 Main St., Belleville, N. J.

Fairchild Bearing Co., New Britain, Conn.

Fairchild Camera & Instrument Corp., 88-06 Van Wyck Blvd., Jamaica 1, N. Y.

Fairchild Recording Equipment Corp., 154th St. & 7th Ave., Whitestone, N. Y.

Falstrom Co., 44 Falstrom Court, Passaic, N. J.

Fansteel Metallurgical Corp., 2200 Sheridan Rd., North Chicago, Ill.

Farmer Electric Co., 21 Mossfield Rd., Waban 68, Mass.

Farrand Optical Co., Inc., Bronx Blvd. at 238th St., New York 70, N. Y.

Farrelloy Co., 1245 N. 26th St., Philadelphia 21, Pa.

Fasco Industries, Inc., Rochester 2, N. Y.

Fast & Co., John E., 3101 N. Pulaski Rd., Chicago 41, Ill.

Federal Electric Products Co., 50 Paris St., Newark 5, N. J.

Federal Instrument Corp., 14-02 Broadway, Long Island City 6, N. Y.

Federal Mfg. & Engr. Corp., 211 Steuben St., Brooklyn 5, N. Y.

Federal Screw Products Inc., 224 W. Huron St., Chicago 10, Ill.

Federal Telecommunication Labs., Inc., 500 Washington Ave., Nutley 10, N. J.

Federal Telephone and Radio Corp., 88 Kingsland Rd., Clifton, N. J.

Federal Tool Engineering Co., 532 Mulberry St., Newark 5, N. J.

Federal Tool & Mfg. Co., 3600 Alabama Ave., St. Louis Park, Minneapolis 16, Minn.

Federated Metals Div., American Smelting & Refining Co., 120 Broadway, New York 5, N. Y.

Feiler Engineering Co., 8026 Monticello Ave., Skokie, Ill.

Felker Mfg. Co., 128 Border Ave., Torrance, Calif.

Felsenthal & Sons, Inc., G., 4100 W. Grand Ave., Chicago 51, Ill.

Felt Products Mfg. Co., 1504 W. Carroll Ave., Chicago 7, Ill.

Felters Co., 210 South St., Boston, Mass.

Fenwal, Inc., 43 Pleasant St., Ashland, Mass.

Ferranti Electric, Inc., 30 Rockefeller Plaza, New York 20, N. Y.

Ferraro Radio & Television Corp., 55 W. 26th St., New York 10, N. Y.

Ferricore, Inc., 15 School St., Yonkers 2, N. Y.

Ferris Instrument Co., 110 Cornelia St., Bonton, N. J.

Ferroxcube Corp. of America, 50 E. 41st St., New York, N. Y.

Fidelitone, Inc., 1616 Devon Ave., Chicago 26, Ill.

Fidelity Amplifier Co., 703 Willow St., Chicago 14, Ill.

Field Electrical Instrument Co., 8 N. Manheim Blvd., New Paltz, N. Y.

Fielden Instrument Corp., 2920 N. 4th St., Philadelphia 33, Pa.

Filtron Co., Inc., 131-05 Fowler Ave., Flushing, N. Y.

Finch Telecommunications, Inc., Passaic, N. J.

Finn & Co., Inc., T. R., 333 Jackson Ave., New York 54, N. Y.

Fischer & Porter Co., Hatboro, Pa.

Fisher-Pierce Co., 170 Pearl St., S. Braintree (Boston 85), Mass.

Fisher Radio Corp., 41 East 47th Street, New York, N. Y.

Fisher Research Lab., 1961 University Ave., Palo Alto, Calif.

Fisher Scientific Co., 717 Forbes St., Pittsburgh 19, Pa.

Flader Inc., Fredric, 1330 Laskey Rd., Toledo 12, Ohio.

Flight Research Engineering Corp., P. O. Box 1-F, Richmond 1, Va.

Flock Process Co., Inc., 28 Fahey St., Springdale, Conn.

Fluke Engineering Co., John, Box 755, Springdale, Conn.

Flush Wall Radio Co., 31 Clinton St., Newark 2, N. J.

Footo Brothers Gear & Machine Corp., 4545 S. Western Blvd., Chicago 9, Ill.

Footo Mineral Co., 18 W. Chelton Ave., Philadelphia 44, Pa.

Ford Engineering Co., 134 N. Second Ave., Upland, Calif.

Ford Instrument Co., Inc., 31-10 Thomson Ave., Long Island City, N. Y.

Ford Radio & Mica Corp., 536 63rd St., Brooklyn, N. Y.

Fordham Mfg. Co., 2220 Pearsall Ave., New York 67, N. Y.

Foredom Electric Co., 27 Park Place, New York 7, N. Y.

Formica Co., The, 4640 Spring Grove Ave., Cincinnati 32, Ohio.

Forty Niner Co., 5245 Grand River, Detroit 8, Mich.

Foster Transformer Co., Inc., 3820 Colerain Ave., Cincinnati 23, Ohio.

Fostoria Pressed Steel Corp., Fostoria, Ohio.

Fox Valley Instrument Co., Ingleside, Ill.

Foxboro Co., The, Foxboro, Mass.

Frankel Connector Co., 177 Hudson St., New York, N. Y.

Franklin Airloop Corp., 43-20 34th St., Long Island City, N. Y.

Franklin Fibre-Lamitex Corp., 12th and French Sts., Wilmington, Delaware.

Franklin Mfg. Corp., A. W., 43-20 34th St., Long Island City 1, N. Y.

Fredericks Co., Geo. E., Bethayres, Pa.

Freed Radio Corp., 200 Hudson St., New York, N. Y.

Freed Transformer Co., Inc., 1736 Weirfield St., Brooklyn 27, N. Y.

Frequency Standards Corp., Box 66, Eatontown, N. J.

Friez Instrument Div., Bendix Aviation Corp., Baltimore 4, Md.

Fryling Mfg. Co., 639 W. 12th St., Erie, Pa.

Fugle-Miller Laboratories, 399 Main St., Metuchen, N. J.

Fulton Sylphon Div., Robertshaw-Fulton Controls Co., Knoxville 4, Tenn.

Furst Electronics, 10 S. Jefferson St., Chicago 6, Ill.

Fusite Corp., Carthage at Hannaford, Cincinnati 12, Ohio.

G-M Laboratories, Inc., 4313 N. Knox Ave., Chicago, Ill.

G-V Controls, Inc., 28 Hollywood Plaza, East Orange, N. J.

Gadgets Inc., 3629 N. Dixie Drive, Dayton 4, Ohio.

Gaertner Scientific Corp., 1201 Wrightwood Ave., Chicago 14, Ill.

Gai Tronics, 412 Washington St., Reading, Pa.

Galbraith & Sons, Inc., C. C., 450-54 Sixth Ave., New York 11, N. Y.

Gale Dorothea Mechanisms, 37-61 85th St., Jackson Heights, L. I., N. Y.

Camwell Co., The, Newton Upper Falls 64, Mass.

Garde Mfg. Co., 588 Eddy St., Providence, R. I.

Gardner Electric Mfg. Co., 4227 Hollis St., Emeryville 8, Calif.

Garlock Packing Co., Palmyra, N. Y.

Garrard Sales Corp., 164 Duane St., New York 13, N. Y.

Garrett Co., Inc., George K., D & Tioga Sts., Philadelphia 34, Pa.

Gasket Engineering Co., 2440 Charlotte St., Kansas City 8, Mo.

Gates Radio Co., Quincy, Ill.

Gatti, Inc., Aurele M., 524 E. Washington St., Trenton, N. J.

Gaveco Labs., Inc., 2 East End Ave., New York 21, N. Y.

Gear Specialties, 2635 W. Medill Ave., Chicago 47, Ill.

Gemloid Corp., 79-10 Albion Ave., Elmhurst, N. Y.

General Accessories Co., Ltd., 366 Madison Ave., New York 17, N. Y.

General Cable Corp., 420 Lexington Ave., New York 17, N. Y.

General Cement Mfg. Co., 919 Taylor Ave., Rockford, Ill.

General Ceramics & Steatite Corp., Keasbey, N. J.

General Chemical Div. Allied Chemical & Dye Corp., 40 Rector St., New York 6, N. Y.

General Communication Co., 530 Commonwealth Ave., Boston 15, Mass.

General Control Company, 1200 Soldiers Field Rd., Boston 34, Mass.

General Controls Co., Glendale 1, Calif.

General Electric Co., Schenectady 5, N. Y.

General Electric Co., Chemical Dept., Pittsfield, Mass.

General Electric Co., Construction Materials Dept., 1285 Boston Ave., Bridgeport 2, Conn.

General Electric Co., Electronics Dept., Electronics Park, Syracuse, N. Y.

General Electric Co., Electronics Dept., Tube Div., Schenectady 5, N. Y.

General Electric Co., Lamp Dept., Nela Park, Cleveland 12, Ohio.

General Electric X-Ray Corp., 4855 Electric Ave., Milwaukee, Wis.

General Electronics, Inc., 101 Hazel St., Paterson, N. J.

General Industries Co., Taylor and Olive Sts., Elyria, Ohio.

General Instrument Corp., 829 Newark Ave., Elizabeth 3, N. J.

General Insulated Wire Works, Inc., 69 Gordon Ave., Providence 5, R. I.

General Lead Batteries Co., 196 W. Railway Ave., Paterson, N. J.

General Magnetic Corp., 10001 Erwin Ave., Detroit 5, Mich.

General Photo Products Co., Inc., 15 Summit Ave., Chatham, N. J.

General Plate Division, Metals & Controls Corp., Attleboro, Mass.

General Precision Lab., Inc., Pleasantville, N. Y.

General R-F Fittings Co., 702 Beacon St., Boston 15, Mass.

General Radio Co., 275 Massachusetts Ave., Cambridge 39, Mass.

General Tire & Rubber Co., The, Silentbloc Division, Wabash, Ind.

General Transformer Co., 18240 Harwood Ave., Homewood, Ill.

General Vacuum Tube Corp., 45 Elm St., Ardsley, N. Y.

Georator Corp., 1820 N. Nash St., Arlington, Va.

Geotronic Labs., Inc., Dallas 8, Texas.

Gerett Corp., M. A., 724 W. Winnebago St., Milwaukee 5, Wis.

Gering Products Inc., N. 7th at Monroe Ave., Kenilworth, N. J.

Gertsch Products, Inc., 11846 Mississippi Ave., Los Angeles 25, Calif.

Giannini & Co., Inc., 285 W. Colorado St., Pasadena 1, Calif.

Gibson Electric Co., 8361 Frankstown Ave., Pittsburgh 21, Pa.

Gilfilan Bros., Inc., 1815 Venice Blvd., Los Angeles 6, Calif.

Girard-Hopkins, 1000 40th Ave., Oakland 1, Calif.

Girdler Corp., 224 E. Broadway, Louisville 1, Ky.

Gisholt Machine Co., 1245 E. Washington Ave., Madison 3, Wis.

Gits Molding Corp., 4600 W. Huron St., Chicago 44, Ill.

Glaser Lead Co., Inc., 31 Wyckoff Ave., Brooklyn, N. Y.

Glaser-Steers Corp., 2 Main St., Belleville 9, N. J.

Glenco Corp., Metuchen, N. J.

Globar Division, Carborundum Co., Niagara Falls, N. Y.

Globe Phone Mfg. Co., 2 Linden St., Reading, Mass.

Glyco Products Co., Inc., 26 Court St., Brooklyn, N. Y.

Goat Co., Inc., Fred, 314 Dean St., Brooklyn, N. Y.

Godfrey Mfg. Co., 171 S. 2nd St., Milwaukee 4, Wis.

Goldmark Wire Co., James, The, 75 Murray St., New York 7, N. Y.

Goldsmith Bros. Smelting & Refining Co., 111 N. Wabash Ave., Chicago 2, Ill.

Gombos Co., Inc., John, 103-109 Montgomery Ave., Irvington 11, N. J.

Gonset Co., 72 E. Tujunga Ave., Burbank, Calif.

Good-All Electric Mfg. Co., 112 W. First St., Ogallala, Neb.

Goodmans Industries, Ltd., Lancelot Rd., Wembley, Middlesex, England.

Goodrich Chemical Co., B. F., Rose Bldg., Cleveland 15, Ohio.

Goodyear Tire & Rubber Co., Inc., Chemical Div., 1144 E. Market St., Akron 16, Ohio.

Gordon Co., Claud S., 3000 S. Wallace St., Chicago 16, Ill.

Gordon Specialties Co., 59 E. Madison St., Chicago 3, Ill.

Gorrell & Gorrell, Haworth, N. J.

Goslin Electric and Manufacturing Co., 2921 W. Olive St., Burbank, Calif.

Gothard Mfg. Co., 2110 Clear Lake Ave., Springfield, Ill.

Gould-National Batteries, Inc., 35 Neoga St., Depew, N. Y.

Gov-Mac Instrument Co., 22 Lawrence St., Newark 5, N. J.

Grafo Colloids Corp., Sharon, Pa.

Gramer Transformer Co., The, 2734 N. Pulaski Rd., Chicago 39, Ill.

Grant Pulley & Hardware Co., 31-85 Whitestone Pkwy., Flushing, N. Y.

Graphite Metallizing Corp., 1041 Nepperhan Ave., Yonkers 3, N. Y.

Grass Instrument Co., 101 Old Colony Ave., Quincy, Mass.

Gray Mfg. Co., The, 16 Arbor St., Hartford, Conn.

Gray Radio Co., 501 Forest Hill Blvd., W. Palm Beach, Fla.

Gray Research & Development Co., Inc., 16 Arbor St., Hartford 1, Conn.

Grayburne Corp., 20 South Broadway, Yonkers, N. Y.

Grayhill, 4524 W. Madison St., Chicago 24, Ill.

Great Lakes Electric Mfg. Co., 17 S. Desplaines St., Chicago 6, Ill.

Green Electric Co., W., 130 Cedar St., New York, N. Y.

Green Instrument Co., 385 Putnam Ave., Cambridge, Mass.

Greene Mfg. Corp., G. G., Warren, Pa.

Greenhut Insulation Co., 31 W. 21st St., New York 10, N. Y.

Greenlee Tool Co., 2136 12th St., Rockford, Ill.

Griess Reproducer Corp., 100 Willow Ave., New York 54, N. Y.

Grieve-Hendry Co., 1101 N. Paulina St., Chicago 22, Ill.

Grigsby-Allison Co., Inc., 407 N. Salem Ave., Arlington Heights, Ill.

Guardian Electric Mfg. Co., 1621 W. Walnut St., Chicago 12, Ill.

Gulton Mfg. Corp., Metuchen, N. J.

Guthman, Inc., Edwin I., 15 S. Throop St., Chicago, Ill.

H. M. R. Electronics Inc., Grove St., New Canaan, Conn.

Hagen Mfg. Co., Inc., Baraboo, Wis.

Hague & Co., Alfred, 227 34th St., Brooklyn 32, N. Y.

Hallidorsen Co., The, 4500 Ravenswood Ave., Chicago 40, Ill.

Hallett Mfg. Co., 1601 Florence Ave., Inglewood, Calif.

Hallcrafters Co., 4401 W. Fifth Ave., Chicago 24, Ill.

Haloid Co., The, 6 Haloid St., Rochester, N. Y.

Halowax Products Division, Union Carbide & Carbon Corp., 30 E. 42nd St., New York 17, N. Y.

Hamilton Kent Mfg. Co., Kent, Ohio.

Hammarlund Mfg. Co., 460 W. 34th St., New York 1, N. Y.

Handy & Harman, 82 Fulton St., New York 38, N. Y.

Hanover Developments, 401 E. 74th St., New York 21, N. Y.

Hanovia Chemical & Mfg. Co., 233 N. J. R.R. Ave., Newark, N. J.

Hansell, Inc., U., Westerly, R. I.

Hansen Mfg. Co., Inc., Princeton, Ind.

Hardwick, Hindle, Inc., 40 Hermon St., Newark 5, N. J.

Harnett Electric Corp., 138 Haven Ave., Port Washington, L. I., N. Y.

Harper Co., The, H. M., 8200 Lehigh Ave., Morton Grove, Ill.

Harrington & King Perforating Co., 5655 Fillmore St., Chicago 44, Ill.

Hart Associates, 8430 Grand River, Detroit 4, Mich.

Hartley Co., Ltd., H. A., 152 Hammersmith Rd., London W. 6, England.

Harvey-Wellis Electronics, Inc., North St., Southbridge, Mass.

Hassall, Inc., John, Clay and Oakland Sts., Brooklyn 22, N. Y.

Hastings Instrument Co., Inc., Hampton 9, Va.

Hathaway Instrument Co., 1315 S. Clarkson St., Denver 10, Colo.

Hatheway Mfg. Co., 1500 Railroad Ave., Bridgeport, Conn.

Hawley Products Co., St. Charles, Ill.

Haydon Co., A. W., The, 232 N. Elm St., Waterbury 20, Conn.

Haydon Mfg. Co., Inc., 584 E. Elm St., Torrington, Conn.

Haydu Brothers, Plainfield, N. J.

Haynes Stellite Co., Division of Union Carbide & Carbon Corp., Kokomo, Ind.

Hazard Insulated Wire Works Div., The Okonite Co., Wilkes Barre, Pa.

Heath Co., Benton Harbor, Mich.

Heiland Research Corp., 130 E. 5th Ave., Denver 9, Colo.

Heinemann Electric Co., 97 Plum St., Trenton 2, N. J.

Heintz & Kaufman Div. of The Robert Dollar Co., 947 Broadway, Redwood City, Calif.

Heintz & Kaufman Equipment Div. of The Robert Dollar Co., 50 Drumm St., San Francisco 11, Calif.

Heinze Electric Co., 685 Lawrence St., Lowell, Mass.

Heldor Mfg. Co., Div. of Heldor Bushing & Terminal Inc., 225 Belleville Ave., Bloomfield, N. J.

Heli-Coil Corp., 47-23 35th St., Long Island City 1, N. Y.

Helipot Corp., 916 Meridian Ave., So. Pasadena, Calif.

Heller Co., Gerald K., 1542 Ridgely St., Baltimore 30, Md.

Helwig Co., 2544 N. 30th St., Milwaukee 10, Wis.

Heminway & Bartlett Mfg. Co., 500 Fifth Ave., New York 18, N. Y.

Heppner Mfg. Co., P. O. Box 612, Round Lake, Ill.

Hercules Powder Co., Inc., 900 Market St., Wilmington 99, Del.

Herlec Corp., The, 422 N. Fifth St., Milwaukee 3, Wis.

Hermaseal Co., The, Riverside Drive, Elkhart, Ind.

Hermetic Seal Products Co., 29-37 South 6th St., Newark 7, N. J.

Hertner Electric Co., 12690 Elmwood Ave., Cleveland 11, Ohio.

Herzog Miniature Lamp Works, Inc., 12-23 Jackson Ave., Long Island City 1, N. Y.

Hetherington, Inc., Sharon Hill, Pa.

Hewlett-Packard Co., 395 Page Mill Rd., Palo Alto, Calif.

Hexacon Electric Co., 130 W. Clay Ave., Roselle Park, N. J.

Heyman Mfg. Co., 300 Michigan Ave., Kenilworth, N. J.

Hickok Electrical Instrument Co., 10514 Dupont Ave., Cleveland 8, Ohio.

Hillburn Electronic Products Co., 55 Nassau Ave., Brooklyn 22, N. Y.

High Frequency Heating Co., 143 Glen Park Ave., Gary, Indiana.

High Voltage Engineering Corp., 7 University Rd., Cambridge 38, Mass.

Highland Engineering Co., Main St. & Urban Ave., Westbury, N. Y.

Hillside Spinning & Stamping Co., Inc., 1429 Chestnut Ave., Hillside, N. J.

Hingham Ordnance Co., Hingham Industrial Centre, Hingham, Mass.

Hi-Tech Chemical Corp., 722 64th St., Brooklyn 20, N. Y.

Hobby & Brown Mfg. Corp., 55 Front St., Rockville Center, N. Y.

Hobson Brothers, 4049 W. Fullerton St., Chicago 39, Ill.

Hoffman Engineering Corp., Anoka, Minn.

Hoffman Radio Corp., 3716 S. Hill Street, Los Angeles 7, Calif.

Hofmann Corp., C. L., 436 Blvd. of the Allies, Pittsburgh 19, Pa.

Hogan Laboratories, Inc., 155 Perry St., New York 14, N. Y.

Holl Audio Industries, 9215 Venice Blvd., Los Angeles 34, Calif.

Holliston Mills, Inc., Norwood, Mass.

Holtzer-Cabot, Div. of National Pneumatic Co., Inc., 130 Amory St., Boston 19, Mass.

Home Recording Products Corp., Freeport, L. I., N. Y.

Homelite Corp., Port Chester, N. Y.

Hopp Press, Inc., 460 W. 34th St., New York, N. Y.

Horn Co., Inc., A. C., 10th St. & 44th Ave., Long Island City 1, N. Y.

Horton Machine Products Co., Horton & Rockaway Aves., Valley Stream, N. Y.

Hose-McCann Telephone Co., 25th St. & 3rd Ave., Brooklyn 32, N. Y.

Houghton Laboratories, Inc., 322 Bush St., Olean, N. Y.

Houlihan Company, T. J., 2508-14 W. Lawrence Avenue, Chicago 25, Illinois.

House of Television, 40 W. 4th St., New York 12, N. Y.

Hovis Screwlock Co., 8100 E. Nine Mile Rd., Van Dyke, Mich.

Howard Co., The, 934 Argyle Rd., Drexel Hill, Pa.

Howard Mfg. Corp., 1401 S. Main, Council Bluffs, Iowa.

Hubbard Spring Co., M. D., Central Ave., Pontiac, Mich.

Hubbell, Inc., Harvey, Bridgeport 2, Conn.

Hudson Wire Co., Ossining, N. Y.

Huggins Laboratories, 734 Hamilton Ave., Menlo Park, Calif.

Hunt Corp., The, 455 Lincoln St., Carlisle, Pa.

Hunter Photo Cypoint Co., 566 Spencer St., Syracuse, N. Y.

Hunter Spring Co., Lansdale, Pa.

Hunton Plastics Co., 178 S. Van Brunt St., Englewood, N. J.

Huppert Co., K. H., 6830 Cottage Grove Ave., Chicago 37, Ill.

Huse Liberty Mica Co., 171 Camden St., Boston, Mass.

Hycor Mfg. Co., 2961 E. Colorado St., Pasadena, Calif.

Hycor Co., Inc., 11423 Vanowen St., North Hollywood, Calif.

Hydraulic Press Mfg. Co., Mt. Gilead, Ohio.

Hy-Lite Antennae, Inc., 242 E. 137th St., New York 51, N. Y.

Hytron Radio & Electronics Corp., 76 Lafayette St., Salem, Mass.

I. D. E. A., 55 N. New Jersey, Indianapolis, Ind.

I-T-E Circuit Breaker Co., 19th & Hamilton Sts., Philadelphia 30, Pa.

Ideal Industries, Inc., Park & Borden Avenues, Sycamore, Ill.

Ilg Electric Ventilating Co., 2850 N. Crawford Ave., Chicago 41, Ill.

Illinois Condenser Co., 1616 N. Throop St., Chicago 22, Ill.

Illinois Electric Porcelain Co., Macomb, Ill.

Illinois Testing Labs., Inc., 420 N. La Salle Street, Chicago 10, Ill.

Illinois Wood Products Corp., 1656 No. Besly Court, Chicago 22, Ill.

Ilco Copper Tube & Products, Inc., Mariemont Ave., Mariemont, Cincinnati 27, Ohio.

Improved Seamless Wire Co., 775 Eddy St., Providence, R. I.

Indiana Steel Products Company, The, Valparaiso, Indiana.

Indiana Steel & Wire Co., 700 S. Council St., Muncie, Ind.

Induction Heating Corp., 181 Wythe Ave., Brooklyn 11, N. Y.

Inductive Equipment Co., Gettysburg, Pa.

Inductograph Laboratory, Box 76, Brookfield, Conn.

Inductograph Products, 236 W. 55th St., New York, N. Y.

Industrial Condenser Corp., 3243 N. California Ave., Chicago 18, Ill.

Industrial Control Co., Straight Path & Arlington Ave., Wyandanch, N. Y.

Industrial Devices Inc., 22 State Rd., Edgewater, N. J.

Industrial Electrical Works, 1509 Chicago St., Omaha 2, Nebraska.

Industrial Electronics Co., Inc., Hanover, Mass.

Industrial Electronics, Inc., 8080 Wheeler St., Detroit 10, Mich.

Industrial Hardware Mfg. Co., Inc., 109 Prince St., New York, N. Y.

Industrial Instruments Inc., 17 Pollack Ave., Jersey City 5, N. J.

Industrial Mica Corp., 947 61st St., Brooklyn, N. Y.

Industrial Precision Products Co., 315-325 N. Hoyle Ave., Chicago 12, Ill.

Industrial Synthetics Corp., 225 North Ave., Garwood, N. J.

Industrial Tape Corp., Route 25, New Brunswick, N. J.

Industrial Television, Inc., 359 Lexington Ave., Clifton, N. J.

Industrial Timer Corp., 115 Edison Pl., Newark 5, N. J.

Inet, Inc., 8655 S. Main St., Los Angeles 3, Calif.

Ingraham Co., E., Bristol, Conn.

Insl-X Co., Inc., The, Water St., Ossining, N. Y.

Instron Engineering Corp., 2 Hancock St., Quincy 71, Mass.

Instrument Development Laboratories, Inc., 163 Highland Ave., Needham Heights, Mass.

Instrument Laboratories, 315 W. Walton Place, Chicago 10, Ill.

Instrument Parts Corp., P. O. Box 150, Ossining, N. Y.
Instrument Resistors Co., 1036 Commerce Ave., Union, N. J.
Instrument Specialties Co., Inc., 254 Bergen Blvd., Little Falls, N. J.
Insulatin Co., 1 Broadway, New York, N. Y.
Insulating Fabricators, Inc., 150 Union Ave., East Rutherford, N. J.
Insulating Fabricators of New England, Inc., 69 Grove St., Watertown 72, Mass.
Insulating Tube Co., 26 Cottage St., P. O. Box 1, Poughkeepsie, N. Y.
Insulation Mfg. Co., 11 New York Ave., Brooklyn, New York.
Insulation Manufacturers Corp., 565 W. Washington Blvd., Chicago 6, Ill.
Insuline Corp., of America, 36-02 35th Avenue, Long Island City, N. Y.
International Electronics Corp., 137 Hudson St., New York, N. Y.
International Instruments, Inc., 331 East St., New Haven 11, Conn.
International Machine Works, 6904 Madison St., Guttenberg, N. J.
International Nickel Co., Inc., 67 Wall St., New York 5, N. Y.
International Rectifier Corp., 6809 S. Victoria Ave., Los Angeles 43, Calif.
International Resistance Co., 401 N. Broad St., Philadelphia 8, Pa.
Intervox Corp., 2701 California Ave., Seattle 6, Wash.
Ionic Electronic Equipment Co., 1705 N. Kenmore Ave., Los Angeles 27, Calif.
Irvington Varnish & Insulator Co., 6 Argyle Terrace, Irvington 11, N. J.
Isolantite Mfg. Corp., Stirling, N. J.
J-B-L Instrument Co., Sycamore & Mill Rds., Clifton Heights, Pa.
J B T Instruments Inc., 431-B Chapel St., New Haven 8, Conn.
J F D Mfg. Co., 6101-23 Sixteenth Ave., Brooklyn, N. Y.
Jackson Electrical Instrument Co., 16 S. Patterson Blvd., Dayton 1, Ohio.
Jackson Industries, Inc., 58 E. Cullerton St., Chicago 16, Ill.
Jamaica Electronic Products Co., 95-26 Sutphin Blvd., Jamaica 4, N. Y.
James Vibrapowr Co., 4036 Rockwell St., Chicago 18, Ill.
Janette Mfg. Co., 556 W. Monroe St., Chicago 6, Illinois.
Jarrel-Ash Co., 165 Newbury St., Boston 16, Mass.
Javex, 921 State, Garland, Texas.
Jarvis Electronics Corp., 6058 W. Fullerton Ave., Chicago 39, Ill.
Jeffers Electronics, Inc., DuBois, Pa.
Jefferson Electric Co., Bellwood, Ill.
Jefferson, Inc., Ray, 40 E. Merrick Rd., Freeport, L. I., N. Y.
Jelliff Mfg. Corp., C. O., 200 Pequot Ave., Southport, Conn.
Jennings Radio Mfg. Co., 1098 E. William St., San Jose 12, Calif.
Jensen Industries Inc., 329 S. Wood St., Chicago, Ill.
Jensen Mfg. Co., 6601 S. Laramie Ave., Chicago 38, Ill.
Jersey Specialty Co., Little Falls, N. J.
Jiffy Clip Mfg. Co., 128 Clinton Ave., Huntington, N. Y.
Johanson Mfg. Co., Boonton, N. J.
Johns-Manville, 22 E. 40th St., New York 16, N. Y.
Johnson Co., E. F., Waseca, Minn.
Johnson Mfg. Co., Inc., Mt. Vernon, Iowa.
Johnson & Hoffman Inc., 65 Ongley St., Rockville Center, N. Y.
Johnson-Williams, Ltd., Palo Alto, Calif.
Johnston Foil Mfg. Co., 6100 S. Broadway, St. Louis 11, Mo.
Jones Electronics Co., M. C., Bristol, Conn.
Jones Div., Howard B., Cinch Mfg. Corp., 1026 S. Homan Ave., Chicago 24, Ill.
Jones Optical Works, A. D., Cambridge, Mass.
Jones Spring Co., W. B., 124 E. 7th St., Cincinnati, Ohio.
Joy Mfg. Co., Mines Equipment Div., Oliver Bldg., Pittsburgh 22, Pa.
Joyal Products, Inc., 56 Belmont Ave., Newark, N. J.
Judd Co., H. L., 87 Chambers St., New York 7, N. Y.
Juel Corp., Arcadia, Calif.
K. F. Development Co., 820 Woodside Way, San Mateo, Calif.
K-V Transformer Corp., 4414 Park Ave., New York 57, N. Y.
Kaar Engineering Co., 2995 Middlefield Road, P. O. Box 1320, Palo Alto, Calif.
Kahle Engineering Co., 1307 Seventh St., North Bergen, N. J.
Kaiser Aluminum & Chemical Sales, Inc., 1924 Broadway, Oakland 12, Calif.
Kalbfell Labs., Inc., 1076 Morena Blvd., San Diego 10, Calif.
Kamm Co., L. J., 40 W. 96th St., New York 25, N. Y.
Karp Metal Products Co., Inc., 215 63rd St., Brooklyn 20, N. Y.
Kartron, Drawer 472, Huntington Beach, Calif.
Kato Engineering Co., 1415 First Ave., Mankato, Minn.
Kay Electric Co., 14 Maple Ave., Pine Brook, N. J.
Kaye-Halbert Corp., 3555 Hayden Ave., Culver City, Calif.
Keasbey & Mattison, Ambler, Pa.
Keithley Instruments, 1507 Warrensville Center Rd., Cleveland 21, Ohio.
Keller Products Co., 41 Union St., Manchester, N. H.
Kelley-Koett Instrument Co., 962 York St., Cincinnati 14, Ohio.
Kellogg Co., M. W., P. O. Box 469, Jersey City 3, N. J.
Kellogg Switchboard & Supply Co., 6650 S. Cicero Ave., Chicago 38, Ill.
Kelnor Mfg. Corp., 215 Kearney St., San Francisco 8, Calif.
Kemet Division, Union-Carbide & Carbon Corp., Madison Ave. and 117th St., Cleveland 1, Ohio.
Kemlite Labs., 1819 W. Grand Ave., Chicago 22, Ill.
Kemode Mfg. Co., 161 W. 18th St., New York 11, N. Y.
Kemtron Electron Products, Inc., 23 Brown St., Salem, Mass.
Kennedy & Co., D. S., Cohasset, Mass.
Kenyon Transformer Co., Inc., 840 Barry St., New York 59, N. Y.
Kepco Labs. Inc., 149-14 41st Ave., Flushing, N. Y.
Kester Solder Co., 4212 Wrightwood Ave, Chicago 39, Ill.
Ketay Mfg. Corp., 555 Broadway, New York, N. Y.
Keuffel & Esser Co., Hoboken, N. J.
Keystone Carbon Co., Inc., Saint Marys, Pa.
Keystone Electronics Corp., 423 Broome St., New York 12, N. Y.
King Electric Equipment Co., 9123 Inman Ave., Cleveland 5, Ohio.
King Laboratories Inc., 127 Solar St., Syracuse 4, N. Y.
Kings Electronics, 40 Marbledale Rd., Tuckaheo, N. Y.
Kings Microwave Co., Inc., 50 Marbledale Rd., Tuckaheo 7, N. Y.
Kinney Mfg. Co., 3529 Washington St., Boston, Mass.
Kip Electronics Corp., 155 Waverly Place, New York 14, N. Y.
Kirchberger & Co., Inc., M., 1425 Thirty Seventh St., Brooklyn 18, N. Y.
Kirkland Co., H. R., 8 King St., Morristown, N. J.
Kling Metal Spinning Co., 174 Centre Street, New York 13, N. Y.
Klipsch & Associates, Hope, Ark.
Knights Co., James, 131 S. Wells St., Sandwich, Ill.
Koby Tool Co., 1535 N. Dayton Ave., Chicago 22, Ill.
Koh-I-Noor Pencil Co., Bloomsbury, N. J.
Koiled Kords, Inc., Box K, New Haven 14, Conn.
Kollsman Instrument Corp., 80-08 45th Ave., Elmhurst, N. Y.
Kolton Electric Mfg. Co., 123 New Jersey Railroad Ave., Newark 5, N. J.
Kopp Glass, Inc., 1 E. 42nd St., New York 17, N. Y.
Koppers Co., Inc., Chemical Div., Koppers Bldg., Pittsburgh 19, Pa.
Kotron Rectifier Corp., A Standard Arcturus Affiliate, 54 Clark St., Newark 4, N. J.
Krieg Co., Charles W., 52 Dickerson St., Newark, N. J.
Krohn-Hite Instrument Co., 580 Massachusetts Ave., Cambridge 39, Mass.
Kuhn & Jacob Molding & Tool Co., 1200 Southard St., Trenton, N. J.
Kulka Electric Mfg. Co., Inc., 30 South St., Mount Vernon, N. Y.
Kupfrian Mfg. Co., 218 Prospect Ave., Binghamton, N. Y.
Kurman Electric Co., Inc., 35-18 37th St., Long Island City 1, N. Y.
Kurz-Kasch, Inc., 1415 S. Broadway, Dayton 1, Ohio.
Kuthe Laboratories, Inc., 150 Summit St., Newark 4, N. J.
Kwikheat Mfg. Co., 3732 San Fernando Rd., Glendale 4, Calif.
L. A. B. Corporation, 31 Union Place, Summit, N. J.
Laconia Corp., 37 S. 6th St., Newark 7, N. J.
Lake Mfg. Co., 2323 Chestnut St., Oakland 7, Calif.
La Magna Mfg. Co., Inc., East Rutherford, N. J.
Lambda Electronics Corp., 103-02 Northern Blvd., Corona, N. Y.
La Motte Chemical Products Co., Towson 4, Baltimore, Md.
Laminated Plastics, Inc., 1823 E. 40th St., Cleveland 3, Ohio.
Laminated Shim Co., Inc., 56 Union St., Glenbrook, Conn.
Lampkin Laboratories, Inc., Bradenton, Fla.
Lamson & Sessions Co., 1971 W. 85th St., Cleveland, Ohio.
Landis & Gyr, Inc., 104 Fifth Ave., New York 11, N. Y.
Langevin Mfg. Corp., 37 W. 65th St., New York 23, N. Y.
Lansdale Tube Co., Church Rd., Lansdale, Pa.
Lansing Sound Inc., James B., 2439 Fletcher Drive, Los Angeles 26, Calif.
LaPointe-Plascomold Corp., Windsor Locks, Conn.
Lapp Insulator Co., Inc., Radio Specialties Div., 31 Gilbert St., LeRoy, N. Y.
La Rose & Associates, Inc., W. T., 646 Second Ave., Troy, N. Y.
Laughlin Co., Thomas, 199 Fore, Portland, Me.
Laurehk Radio Mfg. Co., 3931 Monroe Ave., Wayne, Mich.
Lavelle Rubber Co., 424 N. Wood St., Chicago 22, Ill.
Lavoie Laboratories, Morganville, N. J.
Leach Relay Co., 5915 Avalon Blvd., Los Angeles 3, Calif.
Lear, Inc., 110 Ionia Ave., N.W., Grand Rapids 2, Mich.
Lectrohm, Inc., 5939 Archer Ave., Chicago 38, Ill.
Lectronic Research Labs., 1021 Callowhill St., Philadelphia 23, Pa.
Leeds & Northrup Co., 4970 Stenton Ave., Philadelphia 44, Pa.
Lehigh Structural Steel Co., 17 Battery Pl., New York 4, N. Y.
Lee Mechanical Labs. Div. of Lee Spring Co., Inc., 30 Main St., Brooklyn 1, N. Y.
Leiman Brothers, 114 Christie St., Newark 5, N. J.
Lektra Laboratories, 154-11th Ave., New York 3, N. Y.
Leland, Inc., G. H., 123 Webster St., Dayton 2, Ohio.
Leland Electric Co., 1501 Webster St., Dayton 1, Ohio.
Lenk Mfg. Co., The, 30 Cummings St., Boston 15, Mass.
Lenkurt Electric Co., Inc., San Carlos, Calif.
Lenz Electric Mfg. Co., 1751 North Western Ave., Chicago 47, Ill.
Leonard Electric Products Co., Inc., 1562 61st St., Brooklyn, N. Y.
Lepel High Frequency Labs., Inc., 39 West 60th St., New York 23, N. Y.
Leru Laboratories, Inc., 360 Bleecker St., New York 14, N. Y.
Lewis & Kaufman, Inc., P. O. Box 337, 90 El Rancho Ave., Los Gatos, Calif.
Lewis Spring & Mfg. Corp., 2646 W. North Ave., Chicago 47, Ill.
Lewyt Corp., 60 Broadway, Brooklyn, N. Y.
Liberty Mirror Div., Libbey-Owens-Ford Glass Co., Tarentum, Pa.
Liebel-Flarsheim Co., 303 W. Third St., Cincinnati 2, Ohio.
Light Electric Corp., 214 Lackawanna Ave., Newark 4, N. J.
Lincrophone Co., Inc., 226 Lansing St., Utica, N. Y.
Linde Air Products Co., Division of Union Carbide and Carbon Corp., 30 E. 42nd St., New York 17, N. Y.
Lindsay Structure, Inc., 5000 W. Dempster St., Skokie, Ill.
Lingo & Son, Inc., John E., 28th St. and Buren, Camden, N. J.
Linick Chemical Co., 29 E. Madison St., Chicago 2, Ill.
Link Radio Corp., 125 W. 17th St., New York, N. Y.
Lipps, Edwin A., 1781 Rimpau Blvd., Los Angeles 6, Calif.
Liston-Folb Instrument Co., Inc., 20 Beckley Ave., Stamford, Conn.
Littelfuse Inc., 4757 Ravenswood Ave., Chicago 40, Ill.
Little Falls Alloys, Inc., 190 Caldwell Ave., Paterson 1, N. J.
Litton Industries, San Carlos, Calif.
Locke Incorporated, P. O. Box 57, Baltimore 3, Md.
Loge Sound Engineers, J. M., 2171 W. Washington Blvd., Los Angeles 7, Calif.
Lojack Precision Corp., 32-60 62nd St., Woodside, N. Y.
Loral Electronics Corp., 794 E. 140th St., New York 54, N. Y.
Lord Mfg. Co., 1635 W. 12th St., Erie, Pa.
Lorentzen Inc., Leveler, 391 W. Broadway, New York, N. Y.
Loudon Instruments, Inc., 5644 Lake Park Ave., Chicago 37, Ill.
Louis Bros., 3543 E. 16th St., Los Angeles 23, Calif.
Louthan Mfg. Co., East Liverpool, Ohio.
Lukens Steel Co. & Divisions, By-Products Steel Co., Lukenfeld, 447 Lukens Bldg., Coatesville, Pa.
Luma-Electric Equipment Co., P. O. Box 132, Toledo 1, Ohio.
Lumenite Electric Co., 407 S. Dearborn St., Chicago 5, Ill.
Lundey Associates, 694 Main St., Waltham 54, Mass.
Luzerne Rubber Co., Muirhead Ave., Trenton, N. J.
Lyman Electronic Corp., 12 Cass St., Springfield, Mass.
Lynch Co., F. W., 96 Jessie St., San Francisco, Calif.
Lynmar Engineers, Inc., 1721 Delancey St., Philadelphia 3, Pa.
McColpin-Christie Corp., 3410 W. 67th St., Los Angeles 43, Calif.
McElroy Mfg. Corp., Littleton, Mass.
McIntosh Engineering Laboratory, Inc., 320 Water St., Binghamton, N. Y.
McMurdo Silver Co., Inc., 417 Lafayette St., New York, N. Y.
McQuay-Norris Mfg. Co., 2320 Marconi Ave., St. Louis 10, Mo.
MB Mfg. Co., 1060 State St., New Haven 11, Conn.
M. P. Concert Installations, Fairfield 10, Conn.
Maas & Waldstein Co., 438 Riverside Ave., Newark 4, N. J.
Macdonald & Co., Inc., W. S., 33 University Rd., Cambridge 38, Mass.
Machlett Laboratories, Springdale, Conn.
Mack Electrical Devices Inc., 43 Glenside Ave., Wyncote, Pa.
Mack Molding Co., Wayne, N. J.
MacKay Laboratories, 1946 N. Kedzie, Chicago 47, Ill.
MacLeod & Hanopol, Inc., 10 Joiner St., Charlestown 29, Mass.
Magna Electronics Co., 3707-11 W. Jefferson Blvd., Los Angeles 16, Calif.
Magnavox Co., The, Components Div., Fort Wayne 4, Ind.
Magnatran Incorporated, Kearney, N. J.
Magnecord, Inc., 360 N. Michigan Ave., Chicago 1, Ill.
Magnetic Amplifiers, Inc., 1154 44th Drive, Long Island City 1, N. Y.
Magnetic Analysis Corp., 42-44 Twelfth St., Long Island City 1, N. Y.
Magnetic Core Corp., 142-144 S. Highland Ave., Ossining, N. Y.
Magnetic Devices Corp., 103 S. Van Brunt St., Englewood, N. J.
Magnetic Devices, Inc., 712 East St., Frederick, Md.
Magnetic Instrument Co., 82 W. Main St., West Orange, N. J.
Magnetic Metals Co., Hayes Ave. and 21st St., Camden, N. J.
Magnetic Recorders Co., 7120 Melrose St., Los Angeles, Calif.
Magnetic Windings Div., Essex Wire Corp., Freemansburg Ave. and Hobson Blvd., Easton, Pa.
Magnetics Inc., 135 Bloomfield Ave., Bloomfield, N. J.
Magnetics, Inc., P. O. Box 761, Butler, Pa.
Maico Co. Inc., 21 North 3rd St., Minneapolis, Minn.

Maida Development Co., 12 E. Howard St., Phoebus, Va.
Majestic Radio & Television Div. of the Wilcox-Gay Corp., 70 Washington St., Brooklyn 1, N. Y.
Makepeace Co., D. E., Attleboro, Mass.
Malco Tool & Mfg. Co., 4025 W. Lake St., Chicago 24, Ill.
Mallinckrodt Chemical Works, Second and Mallinckrodt Sts., St. Louis 7, Mo.
Mallory & Co., Inc., P. R., 3029 E. Washington St., Indianapolis 6, Ind.
Manning, Maxwell & Moore, Inc., Stratford, Conn.
Manross & Sons, F. N., Div. of Associated Spring Corp., Bristol, Conn.
Manson Laboratories, 76 Stage St., Stamford, Conn.
Manufacturers Battery Co., Sub. of Ray-O-Vac Co., Madison, Wis.
Manufacturers Engineering & Equipment Corp., Willow Grove, Pa.
Manufacturers Thread Grinding Inc., P. O. Box 66, Eatontown, N. J.
Marathon Battery Co., Wausau, Wis.
Marathon Electric Mfg. Corp., Randolph & Cherry Sts., Wausau, Wis.
Marblette Corp., 37-21 30th St., Long Island City, N. Y.
Marbon Corp., Gary, Ind.
Marco Industries, 210 South Clementine, Anaheim, Calif.
Marco Industries, Inc., 788 Terrace Blvd., Depew, N. Y.
Marconi Instruments, Ltd., 23 Beaver St., New York 4, N. Y.
Marion Electrical Instrument Co., Manchester, N. H.
Markem Machine Co., Keene, N. H.
Market Forge Co., 25 Garvey St., Everett 49, Mass.
Marma Electronic Co., 703 Willow St., Cleveland 14, Ill.
Marsh Stencil Machine Co., 46 Marsh Bldg., Belleville, Ill.
Maryland Electronic Mfg. Corp., 5009 Calvert Rd., College Park, Md.
Masonite Corp., 111 W. Washington St., Chicago 2, Ill.
Massa Laboratories, 3868 Carnegie St., Cleveland, Ohio.
Master Appliance Mfg. Co., Fourth & Ontario Sts., Racine, Wis.
Matthews & Co., J. H., 470 Atlantic Ave., Boston 10, Mass.
Mattison Television & Radio Corp., 893 Broadway, New York 3, N. Y.
Maurer Inc., J. A., 37-01 31st St., Long Island City, N. Y.
Mayfair Molded Products Corp., 4440 N. Elston Ave., Chicago 30, Ill.
Measurement Engineering, Ltd., Arnprior, Ontario, Canada.
Measurements Corp., Boonton, N. J.
Meck Industries, John, Liberty at Pennsylvania, Plymouth, Ind.
Melco Products, Inc., 22 E. Hennepin Ave., Minneapolis 1, Minn.
Mellaphone Corp., Rochester 2, N. Y.
Melpar, Inc., 552 Swann Ave., Alexandria, Va.
Menlo Research Laboratory, Menlo Park, Calif.
Mepco, Inc., 35-37 Abnett Ave., Morristown, N. J.
Merck & Co., Inc., Rahway, N. J.
Mercoid Corp., The, 4201 Belmont Ave., Chicago 41, Ill.
Merit Transformer Corp., 4427 N. Clark St., Chicago 40, Ill.
Metal Hydrides Inc., Beverly, Mass.
Metal Textile Corp., 547 E. First Ave., Roselle, N. J.
Metaplast Process Inc., 9-17 37th Ave., Long Island City 1, N. Y.
Meters, Inc., 915 Westfield Blvd., Indianapolis 20, Ind.
Methode Mfg. Corp., 2265 W. St. Paul Ave., Chicago 47, Ill.
Metron Instrument Co., 432 Lincoln St., Denver 9, Colorado.
Metropolitan Electronics & Instruments Co., 106 Fifth Ave., New York 11, N. Y.
Mica Fabricating Co., 53 Central Ave., Rochelle Park, N. J.
Mica Insulator Co., Schenectady 1, N. Y.
Miccraft Products Inc., 701 McCarter Highway, Newark 5, N. J.
Micamold Radio Corp., 1087 Flushing Ave., Brooklyn 6, N. Y.
Micarta Fabricators, Inc., 5324 Ravenswood Avenue, Chicago 40, Illinois.
Mico Instrument Co., 76 Trowbridge St., Cambridge 38, Mass.
Micro-Circuits Co., New Buffalo, Mich.
Microlab, 301 S. Ridgewood Rd., South Orange, N. J.
Micro Switch Division of Minneapolis-Honeywell Regulator Co., 7 W. Spring St., Freeport, Ill.
Microtone Co., Ford Parkway on the Mississippi, St. Paul 5, Minn.
Microwave Equipment Co., Inc., North Caldwell, N. J.
Midco Mfg. & Distributing Co., 607 N. 8th St., Sheboygan, Wis.
Midland Paint & Varnish Co., 9115 Reno Ave., Cleveland 5, Ohio.
Mid-West Coil & Transformer Co., 1642 N. Halsted St., Chicago 14, Ill.
Midwest Radio & Television Corp., 909 Broadway, Cincinnati 2, Ohio.
Midwestern Geophysical Laboratory, 3400 S. Harvard, Tulsa, Okla.
Miles Reproducer Co., Inc., 812 Broadway, New York 3, N. Y.
Milford Rivet & Machine Co., 1602 NBC Bldg., Cleveland 14, Ohio.
Millen Mfg. Co., James, 150 Exchange St., Malden, Mass.
Miller August E., 9226 Hudson Blvd., North Bergen, N. J.
Miller Co., J. W., 5917 S. Main St., Los Angeles 3, Calif.
Miller Corp., William, 325 N. Halstead St., Pasadena 8, Calif.
Miller Mfg. Co., M. A., 1169 E. 43rd St., Chicago 15, Ill.
Millivac Instruments Corp., P. O. Box 3027, New Haven, Conn.
Milwaukee Resistor Co., 700 W. Virginia Street, Milwaukee 4, Wisconsin.
Milwaukee Stamping Co., 800 S. 72nd St., Milwaukee, Wis.
Miniature Precision Bearings, Inc., Keene, New Hampshire.
Minneapolis-Honeywell Regulator Co., 2753 Fourth Avenue S., Minneapolis, Minn.
Minneapolis-Honeywell Regulator Co., Industrial Div., Wayne & Roberts Aves., Philadelphia 44, Pa.
Minnesota Electronics Corp., 47 W. Water St., St. Paul 1, Minn.
Minnesota Mining & Mfg. Co., 900 Fauquier Ave., St. Paul, Minn.
Minute Man Products, Inc., 430 E. 102nd St., New York, N. Y.
Mirror Record Corp., 4025-206 St., Bayside, N. Y.
Miskella Infra-Red Co., The, E. 73rd & Grand Ave., Cleveland 4, Ohio.
Mission Electric Mfg. Co., 132 W. Colorado Blvd., Pasadena, Calif.
Mitchell Industries, Inc., Camp Wolters, Mineral Wells, Texas.
Mitchell Rand Insulation Co., Inc., 51 Murray Street, New York 7, N. Y.
Model Engineering & Mfg. Inc., Huntington, Indiana.
Modelectric Products Corp., 1500 Bangs Ave., Asbury Park, N. J.
Modern Hearing Aids Laboratory, The, 6805 Fraser St., Vancouver, B. C., Canada.
Molded Insulation Co., 335 E. Price St., Philadelphia, Pa.
Molding Corp. of America, 40 Church St., Pawtucket, R. I.
Monarch Radio & Television Corp., 2430 Atlantic Ave., Brooklyn 33, N. Y.
Monitor Products Co., 815 Fremont Ave., So. Pasadena, Calif.
Monroe Coil Co., 2839 N. Narragansett Ave., Chicago 34, Ill.
Monsanto Chemical Co., Plastics Div., Springfield, Mass.
Montgomery Mfg. Co., 204 S. Main St., Owensville, Ind.
Mooradian High Frequency Labs, 13 E. Fort Lee Rd., Bogota, N. J.
Moore Co., Howard J., 108 Park Row, New York 7, N. Y.
Moore Inc., George W., 100 Beaver St., Waltham, Mass.
Morris Co., J. I., 394 Elm St., Southbridge, Mass.
Morse Co., Frank W., 1300 Soldiers Field Rd., Boston 35, Mass.
Mosher Electronic Controls, 25 Boston Post Rd., Larchmont, N. Y.
Mosinee Paper Mills Co., Mosinee, Wisconsin.
Motorsearch Co., 1600 Junction Ave., Pacific, Wis.
Motorola Inc., 4545 Augusta Blvd., Chicago 51, Ill.
Moulic Specialties Co., 1005-1007 W. Washington St., Bloomington, Ill.
Moyen, C. P., 908 Chicago Ave., Chicago, Ill.
Muckle Mfg. Co., Owatonna 55, Minn.
Mucon Corp., 9 St. Francis St., Newark 5, N. J.
Mueller Electric Co., 1583 E. 31st St., Cleveland 14, Ohio.
Muirhead & Co., Ltd., Beckenham-Kent-England.
Multicore Sales Corp., 164 Duane St., New York 13, N. Y.
Multicore Solders Ltd., Mellier House, Albermarle St., London, W. 1, England.
Multi Metal Co., 1350 Garrison Ave., New York 59, N. Y.
Multi-Products Tool Co., 123 Sussex Ave., Newark 4, N. J.
Multiple Television Mfg. Co., 987 Hegeman Ave., Brooklyn 8, N. Y.
Munston Mfg. & Service, Inc., Beech St., Islip, N. Y.
Murex Ltd., Rainham-Essex-England.
Murray American Corp., 95 Summit Ave., Summit, N. J.
Mur Switch Div., Acro Switch Co., 38 Pequit St., Canton 31, Mass.
Muter Co., 1255 S. Michigan Ave., Chicago, Ill.
Mycalex Corp. of America, 60 Clifton Blvd., Clifton, N. J.
Mycalex Tube Socket Corp., 60 Clifton Blvd., Clifton, N. J.
Myers & Sons, E. A., Radioear Bldg., Beverly Rd., Pittsburgh 16, Pa.
Mykroy, Inc., Arlington Heights Airport, Arlington Heights, Ill.
National Capacitor Co., 1828 Westminster St., Providence 8, R. I.
National Carbon Co., Division of United Carbide & Carbon Corp., 30 E. 42nd Street, New York 17, N. Y.
National Ceramic Co., 400 Southard St., Trenton 2, N. J.
National Company, Inc., 61 Sherman Street, Malden 48, Mass.
National Electric Coil Co., Columbus 16, Ohio.
National Electric Controller Co., 5307 Ravenswood Avenue, Chicago, Illinois.
National Electronic Mfg. Corp., 4202 Vernon Blvd., Long Island City, N. Y.
National Electronics, Inc., Geneva, Ill.
National Electronics Labs., Inc., 1713 Kalorama Rd., N. W., Washington 9, D. C.
National Intercommunicating Systems, 1130 N. Milwaukee Ave., Chicago 26, Illinois.
National Lead Co., 111 Broadway, New York 6, N. Y.
National Lock Washer Co., 40 Hermon St., Newark 5, N. J.
National Moldite Co., 1410 Chestnut Ave., Hillside 5, N. J.
National Research Corp., 70 Memorial Drive, Cambridge 42, Mass.
National Screw & Mfg. Co., The, Cleveland 4, Ohio.
National Spectrographic Laboratories, Inc., 6300 Euclid Ave., Cleveland 3, Ohio.
National Tel-Tronics Corp., 35 St. Casparys Ave., Yonkers, N. Y.
National Union Radio Corp., 350 Scotland Rd., Orange, N. J.
National Varnished Products Corp., 211 Randolph Ave., Woodbridge, N. J.
National Video Corp., 3019 W. 47th St., Chicago, Ill.
National Vulcanized Fibre Co., Wilmington, Del.
Nebel Lab., R. E., 1104 Lincoln Place, Brooklyn 13, N. Y.
Nelson Vacuum Pump Co., George F., 2133 Fourth Street, Berkeley 10, Calif.
Neomatic Inc., 879 Wellesley Ave., Los Angeles 49, Calif.
Neo-Sil Corp., 26 Cornelison Ave., Jersey City 4, N. J.
Network Mfg. Corp., Bayonne, N. J.
New England Electrical Works Inc., Lisbon, N. H.
New Hampshire Ball Bearings, 5 Main St., Peterborough, N. H.
New Hermes, Inc., 13-19 University Place, New York 3, N. Y.
New Jersey Wood Finishing Co., Amboy Ave., Woodbridge, N. J.
New Jersey Zinc Co., 160 Front St., New York 7, N. Y.
New London Instrument Co., Box 189, New London, Conn.
New Wrinkle, Inc., 1819 Bankers Bldg., 105 W. Adams Ave., Chicago 3, Ill.
New York Solder Co., 684 E. 133rd St., New York 54, N. Y.
New York Transformer Co., Inc., Third Ave., Alpha, N. J.
Newark Spinning & Stamping Co., 472 Bloy St., Hillside 5, N. J.
Newcomb Audio Products Co., 6824 Lexington Ave., Hollywood 38, Calif.
Ney Co., J. M., 179 Elm St., Hartford, Conn.
Niagara Electron Laboratories, Andover, New York.
Nickel Cadmium Battery Corp., Easthampton, Mass.
Nilsson Electrical Laboratory, Inc., 103 Lafayette St., New York 13, N. Y.
Noble & Westbrook Mfg. Co., 27 Westbrook St., East Hartford 8, Conn.
Nonotuck Mfg. Co., Holyoke, Mass.
Norrmann Laboratories, Ernst, Williams Bay, Wis.
North American Electric Lamp Co., 1014 Tyler St., St. Louis 6, Mo.
North American Philips Co., Inc., 100 East 42nd St., New York 17, N. Y.
North Electric Mfg. Co., 501 S. Market St., Galion, Ohio.
Northeastern Engineering, Inc., Manchester, N. H.
Northern Industrial Chemical Co., 7-11 Elkins St., South Boston 27, Mass.
Northern Radio Co., Inc., 143-145 W. 22nd St., New York 11, N. Y.
Northern-Zaleski, Ltd., Pratt Oval, Glen Cove, N. Y.
Norton Co., 1 New Bond Street, Worcester 6, Mass.
Nothelfer Winding Labs., 9 Albermarle Ave., Trenton 3, N. J.
Nuclear Development Lab., P. O. Box 7034, Kansas City, Mo.
Nuclear Instrument & Chemical Corp., 223 W. Erie St., Chicago 10, Ill.
Nuclear Measurements Corp., 3339 Central Ave., Indianapolis 5, Ind.
Nuclear Research Corp., 2707 Federal St., Philadelphia 46, Pa.
Nucleonic Corp. of America, The, 497 Union St., Brooklyn 31, N. Y.
Nukem Products Corp., 111 Colgate Ave., Buffalo 20, N. Y.
Numberall Stamp & Tool Co., Huguenot Park, Staten Island 12, N. Y.
Oak Mfg. Co., 1260 N. Clybourn Ave., Chicago 10, Ill.
Oak Ridge Products Mfg. Div. of Video Television, Inc., 37-01 Vernon Blvd., Long Island City 1, N. Y.
Offner Electronics Inc., 5320 N. Kedzie Ave., Chicago 25, Ill.
Ohio Carbon Co., 12508 Berea Rd., Cleveland 11, Ohio.
Ohmite Mfg. Co., 4835 W. Flournoy St., Chicago 44, Ill.
Ohmweve Co., 43 Darcy St., West Hartford 6, Conn.
Okonite Co., The, Canal Street, Passaic, N. J.
Olesen Co., Otto K., 1534 Cauhenga, Hollywood 28, Calif.
Olin Industries Inc., Electrical Division, New Haven 4, Conn.
Olympic Metal Products Co., Inc., Phillipsburg, N. J.
Olympic Radio & Television Inc., 34-01 38th Ave., Long Island City, N. Y.
Onan & Sons Inc., D. W., 3264 University Ave. SE, Minneapolis 14, Minn.
O'Neil-Irwin Mfg. Co., 316 8th Ave., Lake City, Minn.
Opad-Green Co., 71-5 Warren St., New York 7, N. Y.
Operadio Mfg. Co., 135th & Indiana Sts., St. Charles, Ill.
Optical Film Engineering Co., 2125 Cherry St., Philadelphia 3, Pa.
Organic Specialties Co., Paterson, N. J.
Oregon Electronic Mfg. Co., 206 S. W. Washington St., Portland 4, Ore.
Orthon Corp., The, 196 Albion Ave., Paterson 2, N. J.
Osborn Products, Glen Ellyn, Ill.
Oster Mfg. Co., John, 1 Main St., Racine, Wis.
Owen Laboratories, 412 Woodward Blvd., Pasadena 10, Calif.
Owens-Corning Fiberglas Corp., 16 E. 56th St., New York 22, N. Y.
Owens-Illinois Glass Co., Toledo, Ohio.
Oxford Electric Corp., 3911 S. Michigan Avenue, Chicago 15, Ill.
Ozalid Div. of Gen. Aniline & Film Corp., 770 Anso Rd., Johnson City, N. Y.
Pacific Electriccord Company, 3217 Exposition Place, Los Angeles 18, Calif.

Paillard Products Inc., 265 Madison Ave., New York 16, N. Y.

Painton & Co., Ltd., 366 Madison Ave., New York 17, N. Y.

Paisley Products Inc., 1770 Canalport Ave., Chicago 16, Ill.

Palnut Co., Inc., 77 Cordier St., Irvington 11, N. J.

Pan American Trade Development Corp., 40 Wall St., New York 5, N. Y.

Panelyte Div., St. Regis Sales Co., 230 Park Ave., New York 17, N. Y.

Panco Mirrors Inc., 2958 Los Feliz Blvd., Los Angeles 39, Calif.

Panoramic Radio Products, Inc., 10 South Second Ave., Mt. Vernon, N. Y.

Paper Machinery & Research, Inc., 1014 Oak St., Roselle, N. J.

Parmeko Ltd., 366 Madison Ave., New York 17, N. Y.

Par-Metal Products Corp., 32-62 49th Street, Long Island City 3, N. Y.

Paragon Electric Co., Two Rivers, Wisconsin.

Paramount Paper Tube Co., 614 Lafayette St., Fort Wayne, Ind.

Paravox, Inc., 2056 E. 4th St., Cleveland 15, Ohio.

Parisian Novelty Co., 3510 South Western Ave., Chicago 9, Ill.

Park Metalware Co., 28 Bank St., Orchard Park, N. Y.

Parker-Kalon Corp., 200 Varick St., New York 14, N. Y.

Parkwood Corp., Wakefield, Mass.

Pass & Seymour, Inc., Solway Station, Syracuse, N. Y.

Patent Button Co. of Tennessee, 2005 Century St., Knoxville, Tenn.

Patton-MacGyuer Co., 17 Virginia Avenue, Providence 5, R. I.

Paul & Beekman, Inc., 1801 Cortland St., Philadelphia 40, Pa.

Pease Co., C. F., 2601 W. Irving Park Rd., Chicago, Ill.

Peck & Harvey, 5736-38 N. Western Ave., Chicago 45, Ill.

Peek, Inc., Walter E., 132 E. 44th St., Indianapolis, Ind.

Peerless Instrument Co., 90-15 Corona Ave., Elmhurst, N. Y.

Peerless Photo Products, Shoreham, L. I., N. Y.

Peirce Wire Recorder Corp., 1328 Sherman Avenue, Evanston, Illinois.

Penn Engineering & Mfg. Corp., Box 311, Doylestown, Pa.

Penn Fibre & Specialty Co., 2020 E. Westmoreland St., Philadelphia 34, Pa.

Penn-Union Electric Corp., 315 State St., Erie, Pa.

Pennsylvania Testing Laboratory, Doylestown, Pa.

Pentron Corp., The, 221 E. Cullerton St., Chicago 16, Ill.

Perfection Electric Co., 2635 S. Wabash Ave., Chicago 16, Ill.

Perkin-Elmer Corp., Main Ave., Norwalk, Conn.

Permo Inc., 6415 Ravenswood Ave., Chicago 26, Ill.

Permoflux Corp., 4900 W. Grand Ave., Chicago 39, Ill.

Peschel Electronics, Inc., 13 Garden St., New Rochelle, N. Y.

Pfanstiehl Chemical Co., Metallurgical Div., 104 Lake View Ave., Waukegan, Ill.

Phalo Plastics Corp., 25 Foster St., Worcester 8, Mass.

Phaestron Co., South Pasadena, Calif.

Phelps Dodge Copper Products Corp., 40 Wall St., New York, N. Y.

Pheoil Mfg. Co., 5700 Roosevelt Rd., Chicago 50, Ill.

Philadelphia Insulated Wire Co., 220 N. 3rd St., Philadelphia, Pa.

Philadelphia Quartz Co., Public Ledger Bldg., Philadelphia 6, Pa.

Philadelphia Thermometer Co., 4401 N. Sixth St., Philadelphia, Pa.

Philamon Laboratories, 5717 Third Ave., Brooklyn 20, N. Y.

Philbrick Researches, Inc., George A., 230 Congress St., Boston 10, Mass.

Philo Corp., Tioga & C Streets, Philadelphia 34, Pa.

Phillips Control Corp., 84 W. Jefferson St., Joliet, Illinois.

Phillips Petroleum Co., Market Development Div., Bartlesville, Okla.

Philmore Mfg. Co., Inc., 113 University Place, New York 3, N. Y.

Philson Mfg. Co., Inc., 60-66 Sackett St., Brooklyn 31, N. Y.

Phoenix Electronics Inc., Lawrence, Mass.

Phosphor Bronze Corp., 20 Franklin St., Seymour, Conn.

Photobell Company, 116 Nassau St., New York 7, N. Y.

Photocircuits Corp., Glen Cove, N. Y.

Photocon Research Products, 1062 N. Allen Ave., Pasadena 7, Calif.

Photographic Products, Inc., 6916 Romaine St., Hollywood 38, Calif.

Photoswitch, Inc., 77 Broadway, Cambridge 42, Mass.

Photovolt Corp., 95 Madison Ave., New York 16, N. Y.

Photon Instrument Co., 6516 Detroit Ave., Cleveland 2, Ohio.

Picker X-Ray Corp., 300 Fourth Ave., New York 10, N. Y.

Pickering & Co., 309 Woods Ave., Oceanside, New York.

Pierce Template Corp., 2646 N. Coral Street, Philadelphia 25, Pa.

Piezo Mfg. Corp., 110 E. 42nd Street, New York 17, N. Y.

Piezo Products Co., Whitney St., Framingham, Mass.

Pilgrim Mfg. Co., 259 Dexter St., Providence, R. I.

Pilot Chemicals, Inc., 47 Felton St., Waltham 54, Mass.

Pilot Radio Corp., 37-06 36th St., Long Island City, N. Y.

Pioneer Electric Co., 3700 East Olympic Blvd., Los Angeles 23, Calif.

Pioneer Scientific Corp., 295 Lafayette St., New York 12, N. Y.

Pittsburgh Plate Glass Co., 200 Grant Bldg., Pittsburgh 20, Pa.

Pix Mfg. Co., Inc., 24 Bedford St., Newark, N. J.

Planet Mfg. Corp., 225 Belleville Ave., Bloomfield, N. J.

Plaskon Division, Libbey-Owens-Ford Glass Co., 2112-24 Sylvan Avenue, Toledo 6, Ohio.

Plastic Accessories, Inc., 93 Mercer St., New York 12, N. Y.

Plastic Fabricators Co., 440 Sansome Street, San Francisco 11, Calif.

Plastic Metals Division, The National Radiator Co., 169 Bridge Street, Johnstown, Pa.

Plastic Wire & Cable Corp., Jewett City, Conn.

Plastics & Electronics Co., Inc., P. O. Box 38, Station J, Buffalo 8, N. Y.

Plasticraft Products Co., 20 Hudson St., New York 13, N. Y.

Plastoid Corp., 10 Mill Rd., Hamburg, N. J.

Plax Corp., P. O. Box 1019, Hartford 5, Conn.

Plume & Atwood Mfg. Co., 220 Broadway, New York, N. Y.

Poinsettia Co., Inc., 95 Cedar Ave., Pitman, N. J.

Polk Electronics, 119 Bleeker St., New York 12, N. Y.

Polarad Electronics Corp., 100 Metropolitan Ave., Brooklyn 11, N. Y.

Polymer Corp., The, Reading, Pa.

Polytech Devices, Inc., 1180 E. Grand St., Elizabeth, N. J.

Polytechnic Research & Development Co., Inc., 202 Tillary St., Brooklyn 1, N. Y.

Polytron Corp., 133 Martine Ave., White Plains, N. Y.

Ports Mfg. Co., 3265 E. Belmont Ave., Fresno 2, Calif.

Post Co., Frederick, 3650 N. Avondale Ave., P. O. Box 803, Chicago 90, Ill.

Positive Lock Washer Co., 181 Miller St., Newark 5, N. J.

Potter & Brumfield, Princeton, Indiana.

Potter Co., 1850 Sheridan Rd., North Chicago, Ill.

Potter Instrument Co., 115 Cutter Mill Rd., Great Neck, N. Y.

Powered Metal Products Corp., Franklin Park, Ill.

Power Equipment Co., 55 Antoinette St., Detroit 2, Mich.

Powhatan Mining Co., Baltimore 7, Md.

Pratt & Whitney Div., Niles-Bement-Pond Co., West Hartford 1, Conn.

Precise Measurements Co., 942 Kings Highway, Brooklyn 23, N. Y.

Precision Apparatus Co., Inc., 92-27 Horace Harding Blvd., Elmhurst, N. Y.

Precision Devices, Inc., 147-149 Cedar St., New York 6, N. Y.

Precision Electronic Components Ltd., P. O. Box 264, Granby, Quebec, Canada.

Precision Electronics, Inc., 643 Milwaukee Ave., Chicago 22, Ill.

Precision Metal Products Co. of Malden, 41 Elm St., Stoneham 80, Mass.

Precision Paper Tube Co., 2033 W. Charleston St., Chicago 47, Ill.

Precision Piezo Service, 427 Mayflower St., Baton Rouge, La.

Precision Plastic Products Inc., 628-30 W. Lake St., Chicago 6, Ill.

Precision Radiation Instruments, Inc., 4113 W. Jefferson Blvd., Los Angeles 16, Calif.

Precision Rectifier Corp., 193 Grand St., Brooklyn 11, N. Y.

Precision Resistor Co., 334 Badger Avenue, Newark 8, N. J.

Precision Tube Co., Inc., 3828 Terrace St., Philadelphia 28, Pa.

Preis Engraving Machine Co., 649 Highway No. 29, Hillside, N. J.

Premax Products Div., Chisholm-Ryder Co., Inc., Niagara Falls 2, N. Y.

Premier Metal Etching Co., 21-03 44th Ave., Long Island City, N. Y.

Press Wireless Mfg. Co., Inc., Cantiague Rd., Hicksville, N. Y.

Presto Electric Co., Inc., 4513 New York Ave., Union City, N. J.

Presto Recordings Corp., Paramus, N. J.

Preston-Eidson Electronics Co., 2760 Whittier Blvd., Los Angeles 23, Calif.

Price Electric Corp., Frederick, Md.

Printloid Inc., 95 Mercer St., New York, N. Y.

Process & Instruments, 60 Greenpoint Ave., Brooklyn 22, N. Y.

Product Development Co., Inc., Arlington, N. J.

Production Engineering Co., 173 Sargeant Ave., Clifton, N. J.

Production Instrument Co., 710 W. Jackson Blvd., Chicago 6, Ill.

Progressive Mfg. Co., 50 Norwood St., Torrington, Conn.

Pruden Pedio & Sound Co., 5687 College Ave., Oakland 18, Calif.

Pure Carbon Co., St. Marys, Pa.

Pyramid Electric Co., 1445 Hudson Blvd., North Bergen, N. J.

Pyramid Instrument Corp., 49 Howard St., New York, N. Y.

Pyroferic Co., 621 E. 216th St., New York 67, N. Y.

QRK Electronic Products, 445 N. Circle Drive., Fresno 4, Calif.

Q.V.S. INC., 15 S. Essex St., Orange, N. J.

Quadruga Mfg. Co., 213 W. Grand Ave., Chicago 11, Ill.

Quaker City Gear Works, 1908-32 N. Front St., Philadelphia, Pa.

Quality Components, Inc., St. Marys, Pa.

Quam Nichols Co., 526 E. 33rd Pl., Chicago 16, Ill.

R. B. M. Division, Essex Wire Corp., Logansport, Ind.

R-C Scientific Instrument Co., 335 Culver Blvd., Playa Del Rey, Calif.

Racon Electric Co., 52 E. 19th St., New York 3, N. Y.

Radar Engineers, 110 University St., Seattle 1, Wash.

Radelco Mfg. Co., 7580 Garfield Blvd., Cleveland 25, Ohio.

Radex Corp., 2076 N. Elston Avenue, Chicago 14, Ill.

Radiart Corp., The, 3571 W. 62nd St., Cleveland, Ohio.

Radiation Counter Laboratories, Inc., 1844 West 21st St., Chicago 8, Ill.

Radio City Products, 152 W. 25th St., New York 1, N. Y.

Radio Condenser Co., Camden, N. J.

Radio Cores, Inc., 9540 Tully Ave., Oak Lawn, Ill.

Radio Corp. of America, Electron Tubes & Components Dept., Harrison, N. J.

Radio Corp. of America, RCA Victor Div., General Offices, Camden, N. J.

Radio Corp. of America, RCA Victor Div., Home Instrument Dept., Camden, N. J.

Radio Corp. of America, Test Equipment, Harrison, N. J.

Radiocrafters, 1156 Commonwealth Ave., Boston 34, Mass.

Radio Craftsmen, Inc., 1341 S. Michigan Ave., Chicago 5, Ill.

Radio Design Co., 1353 Sterling Place, Brooklyn, N. Y.

Radio Engineering Labs., Inc., 36-40 37th St., Long Island City 1, N. Y.

Radio Frequency Labs., Inc., Boonton 2, N. J.

Radio Mfg. Engineers Inc., 300-302 First Ave., Peoria 6, Ill.

Radio Materials Corp., 1708 Belmont Ave., Chicago 13, Ill.

Radio Merchandise Sales, Inc., 1165 Southern Blvd., New York 59, N. Y.

Radio-Music Corp., Port Chester, N. Y.

Radio Receptor Co., 251 W. 19th St., New York 11, N. Y.

Radio Specialty Mfg. Co., 2023 S. E. Sixth Ave., Portland 14, Ore.

Radio Transceiver Laboratories, 116-23 Jamaica Ave., Richmond Hill 18, N. Y.

Radioactive Products Inc., 443 W. Congress St., Detroit 26, Mich.

Radiomarine Corp. of America, 75 Varick St., New York 13, N. Y.

Radionic Transformer Co., 411 S. Sangamon St., Chicago 7, Ill.

Rae Motor Corp., Box 291, Racine, Wis.

Rahm Instruments, Inc., 12 West Broadway, New York 7, N. Y.

Ranco, Inc., 601 W. Fifth Ave., Columbus, Ohio.

Rangertone, Inc., 73 Winthrop St., Newark 4, N. J.

Rapid Specialties Co., 325 W. Huron Street, Chicago 10, Ill.

Rattray & Co., Inc., George, 92-32 Union Hall St., Jamaica 5, N. Y.

Rauland Corp., 4545 N. Knox Ave., Chicago 41, Ill.

Rauland-Borg Corp., 3523 W. Addison St., Chicago 18, Ill.

Rawson Electrical Instrument Co., 111 Potter St., Cambridge 42, Mass.

Raymond Mfg. Co., Div. of Associated Spring Corp., 226 S. Center St., Corry, Pa.

Ray-O-Vac Co., Madison, Wisconsin.

Raypar, Inc., 7800 W. Addison St., Chicago, Ill.

Raytheon Mfg. Co., Equipment Sales Div., Waltham 54, Mass.

Raytheon Mfg. Co., Power Tube Division, Waltham 54, Mass.

Raytheon Mfg. Co., Receiving & Special Tube Div., 55 Chapel St., Newton 58, Mass.

Rea Magnet Wire Co., E. Pontiac St., Fort Wayne, Ind.

Ready Power Co., The, Power Plant Div., 11231 Freud Ave., Detroit 14, Mich.

Recordisc Corp., 395 Broadway, New York, N. Y.

Reconon Corp., 251 Fourth Ave., New York 10, N. Y.

Red Arrow Electric Corp., 100 Colt St., Irvington 11, N. J.

Red Bank Division, Bendix Aviation Corp., Red Bank, N. J.

Redmond Co., Inc., Owosso, Mich.

Reeder & Co., Charles M., 171 Victor Ave., Detroit 3, Mich.

Reeve Electronics, Inc., 609 W. Lake St., Chicago 6, Ill.

Reeves-Hoffman Corp., 321 Cherry St., Carlisle, Pa.

Reeves Instrument Corp., 215 E. 91st St., New York, N. Y.

Reeves Soundcraft Corp., 10 E. 52nd St., New York 22, N. Y.

REF Mfg. Corp., Jericho Turnpike, Mineola, N. Y.

Reichhold Chemicals Inc., 601-707 Woodward Heights Blvd., Ferndale Sta., Detroit 20, Mich.

Reilly Tar and Chemical Corp., 1615 Merchants Bank Bldg., 11 S. Meridan St., Indianapolis, Ind.

Reiner Electronics Co., 152 W. 25th St., New York, N. Y.

Rek-O-Kut Co., Inc., 38-01 Queens Blvd., Long Island City, N. Y.

Reliable Spring and Wire Forms Co., Fulton Rd. and Paris Ave., Cleveland 9, Ohio.

Reliance Automatic Lighting Co., 1919 Mead St., Racine, Wis.

Reliance Instrument Co., 3027 W. Van Buren St., Chicago 12, Ill.

Remington Rand, Inc., Vericon Dept., 315 4th Ave., New York, N. Y.

Remler Co., Ltd., 2101 Bryant St., San Francisco 10, Calif.

Repath Co., Paul R., 641 E. 61st St., Los Angeles 1, Calif.

Republic Foil & Metal Mills, Inc., 55 Triangle St., Danbury, Conn.

Republic Steel Corp., Republic Bldg., Cleveland 1, Ohio.

Research Electronics Lab., 2459 Susquehanna Rd., Roslyn, Pa.

Resistance Products Co., 714 Race St., Harrisburg, Pa.
 Resistor Corp. of Nevada, Box 35, Verdi, Nev.
 Resistors, Inc., 5226 W. 26th St., Chicago 50, Ill.
 Revere Camera Co., 320 E. 21st St., Chicago 16, Ill.
 Revere Copper & Brass Inc., 230 Park Ave., New York 17, N. Y.
 Rex Rheostat Co., 3 Foxhurst Rd., Baldwin, N. Y.
 Rhode Island Insulated Wire Co., Inc., 50 Burnham Ave., Cranston, R. I.
 Rhodes Inc., M. H., 30 Bartholomew Ave., Hartford, Conn.
 Richards Co., Inc., Arklay S., 78 Winchester St., Newtown Highlands 61, Mass.
 Richardson Allen Corp., 116-15 15th Ave., College Point, N. Y.
 Richardson Company, The, 2767 Lake St., Melrose Park, Illinois.
 Richmond Engineering Co., Inc., 48 Water St., South Norwalk, Conn.
 Rich-Roth Labs., East Hartford, Conn.
 Ripley Co., Inc., Middletown, Conn.
 Riverbank Laboratories, Dept. of Engineering, Geneva, Ill.
 Riverside Electrical Mfg. Co., 10221 Michigan Ave., Dearborn, Mich.
 Riverside Metal Co., Riverside, N. J.
 Rixtron Co., 1501 County Rd., Belmont, Calif.
 Roanwell Corp., 662 Pacific St., Brooklyn 17, N. Y.
 Robbins & Myers, Inc., 1345 Lagonda Ave., Springfield 99, Ohio.
 Robinette, Co., W. C., 802 Fair Oaks Ave., South Pasadena, Calif.
 Robinson Aviation, Inc., Teterboro, N. J.
 Robinson Inc., Edward E., 95 Park Ave., Nutley 10, N. J.
 Robotron Corp., 5570 W. Chicago Blvd., Detroit 4, Mich.
 Rochester Acoustical Laboratories, Inc., Rochester, Minn.
 Rockbestos Products Corp., 285 Nicolli St., New Haven 4, Conn.
 Roebling's Sons Co., John A., 640 Broad St., Trenton 2, N. J.
 Rogan Bros., 2500 W. Irving Park, Chicago 18, Ill.
 Rogers Corp., Manchester, Conn.
 Rohden Manufacturing Company, 4739 Montrose Ave., Chicago 41, Ill.
 Rohm & Haas Co., Washington Square, Philadelphia 5, Pa.
 Rola Co., Inc., The, 2530 Superior Ave., Cleveland 14, Ohio.
 Rollan Electrical Co., 8020 S. South Park, Chicago, Ill.
 Roller-Smith, Bethlehem, Pa.
 Rollin Co., 2070 N. Fair Oaks Ave., Pasadena 3, Calif.
 Rollins Corp., Moore Bldg., Rehoboth, Del.
 Romac Products Co., 112 Blecker St., New York 12, N. Y.
 Rome Cable Corp., 330 Ridge St., Rome, N. Y.
 Rosen Engineering Products, Inc., Raymond, 32nd & Walnut Sts., Philadelphia 4, Pa.
 Ross Mfg. Co., 860 Washington St., Burlington, Iowa.
 Rostan Corp., 202 East 44th St., New York 17, N. Y.
 Rotron Mfg. Co., Inc., 7-9 Schoonmaker Lane, Woodstock, N. Y.
 Roylyn Inc., 718 W. Wilson Ave., Glendale 3, Calif.
 Rubicon Co., 3761 Ridge Ave., Philadelphia 29, Pa.
 Ruby Chemical Co., 68 McDowell St., Columbus, Ohio.
 Ruge-de Forest, Inc., 84 Massachusetts Ave., Cambridge 39, Mass.
 Runzel Cord & Wire Co., 4723-31 W. Montrose Ave., Chicago 41, Ill.
 Rupp's Assembling & Mfg. Works, 2341 N. Seminary Ave., Chicago 14, Ill.
 Rush Wire Stripper Division, The Eraser Co., Inc., 104 S. State St., Syracuse 2, N. Y.
 Russell Electric Co., 4501 South Western Blvd., Chicago 9, Ill.
 Russell & Stoll Co., Inc., 125 Barclay St., New York 7, N. Y.

"S" Corrugated Quenched Gap Co., Scientific Electric Div., 105-119 Monroe St., Garfield, N. J.
 S. M. A. Co., 4721 N. Kedzie, Chicago, Ill.
 S. N. C. Mfg. Co., Inc., Box 277, Oshkosh, Wis.
 Sag Harbor Industries, Inc., Bay St., Sag Harbor, N. Y.
 St. John X-Ray Laboratory, California, N. J.
 St. Mary's Carbon Co., State Rd., St. Marys, Pa.
 Samuel & Co., Inc., J. A., 220 Broadway, New York 7, N. Y.
 Sanborn Co., 39 Osborn St., Cambridge 39, Mass.
 Sangamo Electric Co., Springfield, Illinois.
 Sargent-Raymont Co., 212 Ninth St., Oakland, Calif.
 Sarkes Tarzian Tube Div., 214 Central Ave., Hawthorne, N. J.
 Sauereisen Cements Co., Sauereisen Bldg., Pittsburgh 15, Pa.
 Saxl Instrument Co., Harvard, Mass.
 Schaevitz Engineering, Crescent Blvd. at Drexel Ave., Pennsauken Township, Camden 11, N. J.
 Schauer Mfg. Corp., 2119 Reading Rd., Cincinnati 2, Ohio.
 Schenectady Varnish Co., Schenectady, N. Y.
 Scherr Co., Inc., George, 200 Lafayette St., New York 12, N. Y.
 Schott Co., Walter L., 3225 Exposition Pl., Los Angeles 18, Calif.
 Schulmerich Electronics, Inc., Sellersville, Pa.
 Schutter Co., Carl W., 80 E. Montauk Pkwy., Lindenhurst, N. Y.
 Schuttig & Co., Inc., 9th & Kearney Sts. N. E., Washington 17, D. C.
 Schweitzer Inc., Peter J., 405 Lexington Ave., New York 17, N. Y.
 Sciaky Bros., Inc., 4915 W. 67th St., Chicago 38, Ill.
 Scientific Radio Service, 4301 Sheridan St., University Park, Md.
 Scintilla Magneto Div., Bendix Aviation Corp., Sidney, N. Y.
 Scott Inc., Herman Hosmer, 385 Putnam Ave., Cambridge 39, Mass.

Scott Radio Labs., Inc., 4451 N. Ravenswood Ave., Chicago 40, Ill.
 Scovill Mfg. Co., Industrial Fastener Div., Waterbury, Conn.
 Scully Machine Co., 62 Walter St., Bridgeport, Conn.
 Seager Carbon Co., 289 Church St., New York 13, N. Y.
 Sears Co., M. J., 52 Clark St., Brooklyn 2, N. Y.
 Secon Metals Corp., 228 E. 45th St., New York 17, N. Y.
 Segal, Edward, 72 Spring St., New York 12, N. Y.
 Seifert, Inc., E. R., 202-204 S. Beech St., Syracuse 10, N. Y.
 Selector Industries, Inc., 401 East 138th St., New York 54, N. Y.
 Sensitive Research Instrument Corp., 9 Elm Ave., Mt. Vernon, N. Y.
 Sentinel Radio Corp., 2100 Dempster St., Evanston, Ill.
 Serdex, Inc., 91 Cambridge St., Boston, Mass.
 Servo Corp. of America, 20-20 Jericho Turnpike, New Hyde Park, N. J.
 Servo-Tek Products Co., 4 Godwin Ave., Paterson, N. J.
 Servomechanisms, Inc., Whaleneck Rd. & Stewart Ave., Westbury, L. I., N. Y.
 Servel Products Co., 270 Lafayette St., New York, N. Y.
 Sessions Clock Co., Timer Div., Forestville, Conn.
 Set Screw & Mfg. Co., 470 Main St., Bartlett, Ill.
 Shakeproof Inc., Div. of Illinois Tool Wks., 2501 N. Keeler Ave., Chicago 39, Ill.
 Shallcross Mfg. Co., 10 Jackson Ave., Collingdale, Pa.
 Shannon Luminous Materials Co., 7356 Santa Monica Blvd., Hollywood 46, Calif.
 Shaw Insulator Co., 160 Coit St., Irvington 11, N. J.
 Sheffield Corp., Dayton 1, Ohio.
 Sheldon Electric Co., Div. of Allied Electric Products, Inc., 76 Coit St., Irvington 11, N. J.
 Sherman Industrial Electronics Co., Inc., 505 Washington Ave., Belleville 9, N. J.
 Sherman Mfg. Co., H. B., 22 Barney St., Battle Creek, Mich.
 Sherron Electronics Co., 1201 Flushing Ave., Brooklyn 6, N. Y.
 Shevers Inc., Harold, 123 W. 64th St., New York 23, N. Y.
 Shoe Form Co., Inc., Auburn, N. Y.
 Short Wave Plastic Forming Co., 2921 W. Alameda St., Burbank, Calif.
 Shure Brothers, Inc., 225 W. Huron St., Chicago 10, Ill.
 Shurite Meters, 35-B Hamilton St., New Haven 8, Conn.
 Sickles Co., F. W., 165 Front St., Chicopee, Mass.
 Sierra Electronic Corp., San Carlos, Calif.
 Sigma Instruments, Inc., 180 Pearl St., South Braintree 85, Mass.
 Signal Engineering & Mfg. Co., 154-6 W. 14th St., New York, N. Y.
 Sig-Trans Inc., Amesbury, Mass.
 Sillocks-Miller Co., 10 Parker Ave., West, So. Orange, N. J.
 Simmonds Saw & Steel Co., Lockport, N. Y.
 Simmons Fastener Corp., North Broadway, Albany 1, N. Y.
 Simplex Wire & Cable Co., 79 Sidney St., Cambridge 39, Mass.
 Simpson Electric Co., Div. of American Gage & Machine Co., 5218 W. Kinzie St., Chicago 44, Ill.
 Simpson Mfg. Co., Inc., Mark, 32-28 49th St., Long Island City 3, N. Y.
 Sisakraft Co., 205 W. Wacker Drive, Chicago 6, Ill.
 Sittler Corp., 18 N. Ada St., Chicago 7, Ill.
 Skaneateles Mfg. Co., Inc., 122 Dickerson St., Syracuse 2, N. Y.
 Skinner Electric Valve Div., The Skinner Chuck Co., 40 Belden Ave., Norwalk, Conn.
 Skydyne Inc., River Rd., Port Jervis, N. Y.
 Slepian Co., Arthur, Bridgeport, Conn.
 Small Motors, Inc., 2076 Elston Ave., Chicago 14, Ill.
 Smith, Inc., Herman H., 436 18th St., Brooklyn 15, N. Y.
 Sola Electric Co., 4633 W. 16th St., Chicago 50, Ill.
 Soldering Specialties Co., Summit, N. J.
 Sommer & Maca Glass Machine Co., 3600 Oakley Ave., Chicago 9, Ill.
 Sonar Radio Corp., 59 Myrtle Ave., Brooklyn 1, N. Y.
 Sonic Industries Inc., 221 W. 17th St., New York 11, N. Y.
 Sonic Recording Products, Inc., 58 Mill Rd., Freeport, N. Y.
 Sonotone Corp., P. O. Box 200, Saw Mill R'ver Road, Elmsford, N. Y.
 Sorensen & Co., Inc., 375 Fairfield Ave., Stamford, Conn.
 Sorgel Electric Co., 838 W. National Ave., Milwaukee 4, Wis.
 SOS Cinema Supply Corp., 602 W. 52nd St., New York 19, N. Y.
 Sound Apparatus Co., Stirling, N. J.
 Soundscriber Corp., 146 Munson St., New Haven 4, Conn.
 South River Metal-Products Co., South River, N. J.
 Southwestern Industrial Electronics Co., 2831 Post Oak Rd., P. O. Box 13058, Houston 19, Texas.
 Spaulding Fibre Co., Inc., 310 Wheeler St., Tonawanda, N. Y.
 Speak-O-Phone Recording & Equipment Co., 23 W. 60th St., New York, N. Y.
 Special Chemicals Corp., 30 Irving Place, New York 3, N. Y.
 Sreial Instruments Laboratory, Inc., 1003 Highland Ave., Knoxville, Tenn.
 Special Products Co., Silver Spring, Md.
 Specialties, Inc., Skunks Misery Rd., Syosset, N. Y.
 Specialty Battery Co., Madison 4, Wisconsin.
 Spectrum Mfg. Co., P. O. Box 189, New London, Conn.
 Speedway Mfg. Co., 1834 S. 52nd Ave., Cicero 50, Ill.
 Speer Carbon Co., Lincoln Ave., St. Marys, Pa.
 Speer Resistor Corp., St. Marys, Pa.
 Spellman Television Co., Inc., 3029 Webster Ave., New York 67, N. Y.

Spencer-Kennedy Labs., Inc., 186 Massachusetts Ave., Cambridge 39, Mass.
 Spencer Thermostat Div. Metals & Controls Corp., 34 Forest St., Attleboro, Mass.
 Sperry Gyroscope Co., Div. of The Sperry Corp., Great Neck, N. Y.
 Sperry Products, Inc., Danbury, Conn.
 Sperti, Inc., Norwood Station, Cincinnati 12, Ohio.
 Spincraft, Inc., 4143 W. State St., Milwaukee 8, Wis.
 Sprague Electric Co., North Adams, Mass.
 Sta-Warm Electric Co., Ravenna, Ohio.
 Stackpole Carbon Co., St. Marys, Pa.
 Staedtler Inc., J. S., 55 Worth St., New York, N. Y.
 Stainless, Inc., Third St., North Wales, Pa.
 Stamford Metal Specialty Co., 429 W. Broadway, New York 12, N. Y.
 Stancil-Hoffman Corp., 1016 N. Highland Ave., Hollywood 38, Calif.
 Standard Artcurus Corp., 54 Clark St., Newark 4, N. J.
 Standard Coil Products Co., 2329 N. Pulaski Rd., Chicago 39, Ill.
 Standard Crystal Co., 400 Armstrong Ave., Kansas City 1, Kans.
 Standard Electric Time Co., The, 89 Logan St., Springfield, Mass.
 Standard Electronics Corp., 25 W. 43rd St., New York 18, N. Y.
 Standard Electronics Research Corp., 2 East End Ave., New York 21, N. Y.
 Standard Locknut & Lockwasher Inc., 510 N. Capitol Ave., Indianapolis 4, Ind.
 Standard Metals Corp., 262 Broad St., North Attleboro, Mass.
 Standard Piezo Co., 127 Cedar St., Carlisle, Pa.
 Standard Pressed Steel Co., Box 775, Jenkintown 10, Pa.
 Standard Telephones & Cables Ltd., Connaught House, Aldwych, London, W. C. 2, England.
 Standard Transformer Corp., Elston, Kedzie & Addison Sts., Chicago 18, Ill.
 Standard Varnish Works, 2600 Richmond Terrace, Staten Island 3, N. Y.
 Standard Winding Corp., 44-62 Johns St., Newburgh, N. Y.
 Stanley Tools Div., Stanley Works, Elm St., New Britain, Conn.
 Stanwyck Winding Co., 137 Walsh Ave., Newburgh, N. Y.
 Star Expansion Bolt Co., 147-149 Cedar St., New York 6, N. Y.
 Star Expansion Products Co., 147-149 Cedar St., New York 6, N. Y.
 Star-Kimble Motor Div. of Miehle Prntg. Press & Mfg. Co., 200 Bloomfield Ave., Bloomfield, N. J.
 Star Measurements Co., 442 East 166th St., New York 56, N. Y.
 Star Porcelain Co., 61 Muirhead Ave., Trenton 9, N. J.
 Starrett Television Mfg. Corp., 601 W. 26th St., New York, N. Y.
 States Co., 19 New Park Ave., Hartford 6, Conn.
 Statham Laboratories, Inc., 12401 W. Olympic Blvd., Los Angeles 64, Calif.
 Staver Co., Inc., Box 431, Bayshore, N. Y.
 Steel Co., Herman D., Lafayette Bldg., Philadelphia 6, Pa.
 Steger Furniture Mfg. Co., Steger, Ill.
 Steinen Mfg. Co., Wm., 43 Bruen St., Newark 5, N. J.
 Steiner-Ives Co., 16 Avenue L, Newark 5, N. J.
 Stephens Mfg. Corp., 8538 Warner Drive, Culver City, Calif.
 Sterling Cable Co., 350 Fifth Ave., New York 1, N. Y.
 Sterling Mfg. Co., 9205 Detroit Ave., Cleveland 2, Ohio.
 Sterling Television Inc., 15 W. Lake St., Chicago 1, Ill.
 Stevens-Arnold Inc., 22 Elkins St., South Boston, Mass.
 Stevens Mfg. Co., Inc., 69 S. Walnut St., Mansfield, Ohio.
 Stevens Mfg. Co., Inc., Geo., 6022 N. Rogers Ave., Pulaski & Peterson, Chicago 30, Ill.
 Stevens Products Inc., 86-88 Mail St., East Orange, N. J.
 Stevens-Walden, Inc., 475 Shrewbury St., Worcester 4, Mass.
 Stevenson Bro. & Co., 110 Race St., Philadelphia 6, Pa.
 Steward Mfg. Co., D. M., 3600 Jerome Ave., Chattanooga, Tenn.
 Stewart Mfg. Corp., F. W., 4311 Ravenswood Ave., Chicago 13, Ill.
 Stewart Stamping Co., 630 Central Park Ave., Yonkers 4, N. Y.
 Stewart-Warner Electric Div., Stewart-Warner Corp., 1826 Diversey Parkway, Chicago 14, Illinois.
 Sticht Co., Inc., Herman H., 27 Park Place, New York 7, N. Y.
 Stimpson Co., Inc., Edwin B., 74 Franklin Ave., Brooklyn 5, N. Y.
 Stoddard Aircraft Radio Co., 6644 Santa Monica Blvd., Hollywood 38, Calif.
 Stokes Machine Co., F. J., 5850 Tabor Road, Olney Post Office, Philadelphia 20, Pa.
 Stover Lock Nut & Machinery Corp., Hilton & Holly Sts., Easton, Pa.
 Stow Manufacturing Co., 445 State St., Binghamton, N. Y.
 Streeter-Amet Corp., 4101 N. Ravenswood Ave., Chicago 13, Ill.
 Stromberg-Carlson Co., Rochester 3, N. Y.
 Stronghold Screw Products, Inc., 216-222 West Hubbard St., Chicago 10, Ill.
 Struthers-Dunn, Inc., 150 N. 13th Street, Philadelphia 7, Pa.
 Stupakoff Ceramic & Mfg. Co., Latrobe, Pa.
 Summerill Tubing Co., Div. Columbia Steel & Shafting Co., P. O. Box 1557, Pittsburgh 30, Pa.
 Summit Coil Co., 67 Union Pl., Summit, N. J.
 Sun Copper & Wire Co., 132 Beckwith Ave., Paterson, N. J.
 Sun Electric Corp., 6323 Avondale Ave., Chicago 31, Ill.

- Super Electric Products Corp., 46 Oliver St., Newark, N. J.
- Super Flow Solder Co., Inc., 90 State St., Albany, N. Y.
- Superior Electric Co., The, 4000 Church St., Bristol, Conn.
- Superior Flake Graphite Co., 33 S. Clark St., Chicago 3, Ill.
- Superior Instruments Co., 227 Fulton St., New York 7, N. Y.
- Superior Tube Co., 2504 Germantown Pike, Norristown, Pa.
- Supreme, Inc., Greenwood, Miss.
- Suprenant Mfg. Co., 199 Washington St., Boston 10, Mass.
- Swiss Jewel Co., Lafayette Bldg., Philadelphia 6, Pa.
- Switchcraft, Inc., 1328-30 N. Halsted St., Chicago 22, Ill.
- Sylvania Electric Products, Inc., 1740 Broadway, New York 19, N. Y.
- Sylvania Electric Products, Inc., Radio & Television Div., 254 Rano St., Buffalo 7, N. Y.
- Symphony Radio & Television Corp., 721 N. Martel Ave., Los Angeles 15, Calif.
- Symphonic Radio & Electronic Corp., 292-298 Main St., Cambridge 42, Mass.
- Synchro Start Products, Inc., 1046 W. Fullerton Ave., Chicago 14, Ill.
- Synco Products Co., Malden, Mass.
- Synthane Corp., Oaks, Pa.
- Syntron Co., 243 Lexington, Homer City, Pa.
- Synvar Corp., 415 E. Front St., Wilmington, Del.
- Syracuse Ornamental Co., Inc., 581 S. Clinton St., Syracuse, N. Y.
- Tablet & Ticket Co., 1021 W. Adams St., Chicago 7, Ill.
- Tagliabue Div., Weston Electrical Instrument Corp., 614 Frelinghuysen Ave., Newark 5, N. J.
- Takk Corp., Newark, Ohio.
- Talk-A-Phone Co., 1512 S. Pulaski Rd., Chicago 23, Ill.
- Tannoy, 350 Fifth Ave., New York 1, N. Y.
- Tartak-Stolle Electronics, Inc., 3970 S. Grand Ave., Los Angeles 37, Calif.
- Taybern Equipment Co., Inc., 120 Greenwich St., New York 6, N. Y.
- Taylor Fibre Co., Norristown, Pa.
- Taylor Tubes, Inc., 2312 Wabansia Ave., Chicago 47, Ill.
- Tech Laboratories, Inc., Bergen & Edsall Bldvs., Palisades Park, N. J.
- Tech-Master Products Co., 443-445 Broadway, New York 13, N. Y.
- Technical Appliance Corp., Sherburne, N. Y.
- Technical Associates, 3730 San Fernando Rd., Glendale 4, Calif.
- Technical Materiel Corp., The, P. O. Box 142, 121 Spencer Place, Mamaroneck, N. Y.
- Technicraft Laboratories, Inc., Thomaston-Waterbury Rd., Thomaston, Conn.
- Technifax Corp., 276 High St., Holyoke, Mass.
- Technitrol Engineering Co., 3211 Woodland Ave., Philadelphia 4, Pa.
- Technology Instrument Corp., 531 Main St., Acton, Mass.
- Teflon Products Division, United States Gasket Co., P. O. Box 93, Camden, N. J.
- Teiner Co., Inc., Roland, 134 Tremont St., Everett 49, Mass.
- Teiner Engineering Corp., 115 Madison St., Malden 48, Mass.
- Tektronix, Inc., 712 S. E. Hawthorne Blvd., Portland 14, Ore.
- Teletograph Corp., 16 W. 61st St., New York 23, N. Y.
- Tele King Corp., 601 W. 26th St., New York 1, N. Y.
- Tele-Tone Radio Corp., 540 W. 58th St., New York 19, N. Y.
- Teletone, Inc., 88 Merrick Rd., Amityville, N. Y.
- Teletron Inc., Homer Ave., Ashland, Mass.
- Telectro Industries Corp., 35-18 37th St., Long Island City 1, N. Y.
- Telectron Co., The, 4019 Prospect St., Cleveland 3, Ohio.
- Telemcomputing Corp., 133 E. Santa Anita Ave., Burbank, Calif.
- Telegraph Condenser Co., Ltd., Wales Farm Rd., Acton, London, W. 3, England.
- Telemark Electronics Corp., 150 Broadway, New York, N. Y.
- Telemark, Inc., 100 Greyrock Pl., Stamford, Conn.
- Telemetering Associates, P. O. Box 6, Silver Spring, Md.
- Telephonics Corp., Park Ave., Huntington, N. Y.
- Telegrip Radio Co., 2559 W. 21st St., Chicago 8, Ill.
- Teleradio Engineering Corp., 99 Wall St., New York 5, N. Y.
- Tele-Ray Tube Co., Inc., 984 Saw Mill River Rd., Yonkers, N. Y.
- Teletan Corp., Ramsey, N. J.
- Teletronics Laboratory, Inc., 352 Maple Ave., Westbury, N. Y.
- Television Associates, Inc., E. Michigan St., Michigan City, Ind.
- Television Equipment Corp., 238 William St., New York, N. Y.
- Television Specialty Co., Haverstraw, N. Y.
- Television Utilities Corp., 1261 Broadway, New York 1, N. Y.
- Television Zoomar Corp., Room 2223, 500 Fifth Avenue, New York, N. Y.
- Telex Inc., Telex Park St. Paul 1, Minn.
- Tel-Instrument Co., Inc., 50 Patterson Ave., E. Rutherford, N. J.
- Tel-O-Tube Corp. of America, Paterson, N. J.
- Tel-Rad Mfg. Co., Inc., 7th & Madison St., Fennimore, Wis.
- Telrex, Inc., Rutherford & Neptune Highway, Asbury Park, N. J.
- Television Laboratories, Inc., 5045 W. Lake St., Chicago 44, Ill.
- Tempo Record Co. of America, 8540 Sunset Blvd., Hollywood 46, Calif.
- Tempo T-V Products Co., 2450 Ramona Blvd., Los Angeles 33, Calif.
- Tennessee Eastman Co., Kingsport, Tenn.
- Tenney Engineering Inc., 26 Avenue B., Newark 5, N. J.
- Tensolite Insulated Wire Co., 198 Main St., Tarrytown, N. Y.
- Terpening Co., L. H., 16 W. 61st St., New York, N. Y.
- Tetrad Co., 4921 Exposition Blvd., Los Angeles 16, Calif.
- Tetrad Corp., 62 St. Mary St., Yonkers, N. Y.
- Thall Plastic Engineering Co., 155 Chambers St., New York, N. Y.
- Ther Electric & Machine Works, 15 South Jefferson St., Chicago, Ill.
- Thermador Electric Mfg. Co., 5119 District Blvd., Los Angeles 22, Calif.
- Thermal Syndicate Ltd., 12 E. 46th St., New York 17, N. Y.
- Thermo Instruments Co., Box 336, Belmont, Calif.
- Thomas & Betts Co., Inc., 40 Butler Street, Elizabeth 1, N. J.
- Thomas & Skinner Steel Products Co., 1122 E. 23rd St., Indianapolis, Ind.
- Thomas Electronics, Inc., 118 9th St., Passaic, N. J.
- Thompson Corp., The, George S., South Pasadena, Calif.
- Thompson & Associates, John E., 7210 S. Yates Ave., Chicago 49, Ill.
- Thompson Products, Inc., Electronics Div., 2196 Clarkwood Rd., Cleveland 3, Ohio.
- Thor Ceramics, Inc., 225 Belleville Ave., Bloomfield, N. J.
- Thordarson-Meissner Mfg. Divisions, 500 W. Huron St., Chicago 10, Ill.
- Thwing-Albert Instrument Co., 5351 Pulaski Avenue, Philadelphia 44, Pa.
- Tibbetts Industries, Inc., Camden, Maine.
- Times Facsimile Corp., 540 W. 58th St., New York 19, N. Y.
- Tinnerman Products Inc., P. O. Box 6688, Dept. No. 16, Cleveland 1, Ohio.
- Titan Metal Mfg. Co., Bellefonte, Pa.
- Titeflex, Inc., 500 Frelinghuysen Ave., Newark 5, N. J.
- Tocco Division, Ohio Crankshaft Co., 3800 Harvard Ave., Cleveland 1, Ohio.
- Todd-Tran Corp., 156 Gramatan Ave., Mt. Vernon, N. Y.
- Toman & Co., E., 2621 W. 21st Place, Chicago 8, Ill.
- Ton-Tex Corp., 247 Pearl St. N. W., Grand Rapids 2, Mich.
- Topflight Tape Co., 116 E. Market St., York, Pa.
- Topping Mfg. Co., 75 Pueblo St., San Francisco 4, Calif.
- Torit Mfg. Co., Walnut & Exchange Sts., St. Paul 2, Minn.
- Tork Clock Co., Inc., 1 Grove St., Mt. Vernon, N. Y.
- Torgren Co., Inc., C. W., 236 Pearl St., Somerville 45, Mass.
- Torocoi Co., 1002 Blendon Ave., Richmond Heights, Mo.
- Tracerlab Inc., 130 High St., Boston 10, Mass.
- Trad Television Corp., 1001 First Ave., Asbury Park, N. J.
- Transformer Engineers, 389 South Arroyo Parkway, Pasadena, Calif.
- Transcoil Corp., 107 Grand St., New York, N. Y.
- Transmira Products Corp., 1650 Broadway, New York 19, N. Y.
- Transmitter Equipment Mfg. Co., Inc., 345 Hudson St., New York 14, N. Y.
- Transradio, Ltd., 138A Cromwell Rd., London SW 7, England.
- Trans-Sonics, Inc., Bedford Airport, Bedford, Mass.
- Transvision Inc., 460 North Ave., New Rochelle, N. Y.
- Trav-Ler Radio Corp., 571 W. Jackson Blvd., Chicago, Ill.
- Trenton Transformer Corp., P. O. Box 568, Trenton, N. J.
- Triad Portable Case Corp., 310-14 W. Lincoln Ave., Mount Vernon, N. Y.
- Triad Transformer Mfg. Co., 2254 Sepulveda Blvd., Los Angeles 64, Calif.
- Trico Fuse Mfg. Co., 2948 N. Fifth, Milwaukee 12, Wis.
- Tricon Mfg. Co., 8318 S. Racine Ave., Chicago, Ill.
- Tricraft Products Co., 1535 N. Ashland Ave., Chicago 22, Ill.
- Trimm Inc., 400 W. Lake St., Libertyville, Ill.
- Trion, Inc., 1000 Island Ave., McKees Rocks, Pa.
- Triplet & Barton Inc., 831 N. Lake St., Burbank, Calif.
- Triplet Electrical Instrument Co., Harmon Road, Bluffton, Ohio.
- Trix Electrical Mfg. Co., Ltd., 366 Madison Ave., New York 17, N. Y.
- Triumph Mfg. Co., 913 W. Van Buren St., Chicago 7, Ill.
- Trumbull Electric Mfg. Co., Plainville, Conn.
- Truscon Steel Co., Youngstown, Ohio.
- Tubular Rivet & Stud Co., Linden St., Quincy, Mass.
- Tung-Sol Lamp Works Inc., 95 Eighth Ave., Newark 4, N. J.
- Turner Co., The, 909 17th St., N. E., Cedar Rapids, Iowa.
- Tuttle & Kift, 1823 N. Monitor St., Chicago 39, Ill.
- Tyniswitch Division, Sessions Clock Co., Forestville, Conn.
- U.H.F. Resonator Corp., 224 Seventh St., Racine, Wis.
- Ucinite Co. Division, United-Carr Fastener Corp., 459 Watertown St., Newtonville, Mass.
- Ulanet Co., George, 413 Market St., Newark 5, N. J.
- Ultraadyne Electronics, Oswego, Oregon.
- Ultra-Violet Products, Inc., 145 Pasadena Ave., S. Pasadena, Calif.
- Ungar Electric Tools Inc., 615 Ducommun St., Los Angeles 54, Calif.
- Uniform Tubes, Shurs Lane & Laruiston St., Roxborough, Philadelphia 28, Pa.
- Unimax Switch Div. of W. L. Maxon Corp., 460 W. 34th St., New York 1, N. Y.
- Union Bay State Chemical Co., Cambridge, Mass.
- Union Electric Products Co., 24 Edison Place, Newark 2, N. J.
- United Carr Fastener Corp., Cambridge 42, Mass.
- United Condenser Corp., 337 E. 139th St., New York 54, N. Y.
- United Electronics Co., 42 Spring St., Newark 2, N. J.
- United Mfg. & Service Co., 405 S. Sixth St., Milwaukee 4, Wis.
- United Pressed Products Co., 741 W. Harrison St., Chicago 7, Ill.
- United Screw & Bolt Corp., 2513 W. Cullerton St., Chicago, Ill.
- United Shoe Machinery Corp., 140 Federal St., Boston, Mass.
- Unitex Corp., Pasadena, Calif.
- U. S. Electrical Motors, Inc., 200 E. Slauson Ave., Los Angeles, Calif.
- U. S. Electronic Co., 262 Canner St., New Haven 11, Conn.
- U. S. Electronics Corp., 276 Warren St., Lyndhurst, N. J.
- U. S. Engineering Co., 521 Commercial St., Glendale 3, Calif.
- U. S. Gauge Div., American Machine and Metals, Inc., Sellersville, Pa.
- U. S. Instrument Corp., 409 Broad St., Summit, N. J.
- U. S. Radium Corp., 535 Pearl St., New York 7, N. Y.
- U. S. Rubber Co., 1230 Avenue of the Americas, New York 20, N. Y.
- U. S. Steel Co. (U. S. Steel Corp. Sub.), 525 Wm. Penn Place Bldg., Pittsburgh 30, Pa.
- U. S. Stoneware Co., The, Akron 9, Ohio.
- U. S. Television Mfg. Corp., 3 W. 61st St., New York 23, N. Y.
- United Technical Labs., Box 425-W, Morristown, N. J.
- United Transformer Co., 150 Varrick Street, New York 13, N. Y.
- Universal Audio Equipment, Inc., 6035 Northwest Highway, Chicago 31, Ill.
- Universal Drafting Machine Corp., 7960 Lorain Ave., Cleveland 2, Ohio.
- Universal Electric Co., 300 E. Main St., Owosso, Mich.
- Universal Mfg. Co., Inc., 410 Hillside Ave., Hillside, N. J.
- Universal Winding Co., P. O. Box 1605, Providence 1, R. I.
- University Loudspeakers, Inc., 80 S. Kensico Ave., White Plains, N. Y.
- Utah Radio Products, Inc., E. Franklin St., Huntington, Indiana.
- V-M Corp., Benton Harbor, Mich.
- Vaco Products Co., 317 E. Ontario St., Chicago 11, Illinois.
- Vacuum Electronic Engineering Co., 756 Third Ave., Brooklyn 32, N. Y.
- Vacuum Tube Products, 302 North Clementine St., Oceanside, Calif.
- Valco Mfg. Co., 4700 W. Walton St., Chicago 51, Ill.
- Vallorbs Jewel Co., Lancaster, Pa.
- Valpey Crystals, Highland St., Holliston, Mass.
- Vapor Recovery Systems Co., 2820 N. Alameda, Compton, Calif.
- Varflex Corp., 308 N. Jay St., Rome, N. Y.
- Variable Condenser Corp., 65 Hope St., Brooklyn, N. Y.
- Varian Associates, 99 Washington St., San Carlos, Calif.
- Varo Mfg. Co., Inc., Box 638, Garland, Texas.
- Vector Electronic Co., 1101 Riverside Drive, Los Angeles 31, Calif.
- Vectron, Inc., 235 High St., Waltham, Mass.
- Veeder-Root, Inc., Hartford 2, Conn.
- Vendo Co., 7400 E. 12th St., Kansas City 8, Mo.
- Vibracolor Corporation, 425 Bush St., San Francisco 8, Calif.
- Vibroplex Co., Inc., 833 Broadway, New York, N. Y.
- Vickers Electric Div., Vickers Inc., 1815 Locust St., St. Louis 3, Mo.
- Victoreen Instrument Co., 5806 Hough Ave., Cleveland 3, Ohio.
- Victory Engineering Corp., 744 Broad St., Newark, N. J.
- Video Corp. of America, 229 W. 28th St., New York 1, N. Y.
- Viewlex Inc., 35-01 Queens Blvd., Long Island City 1, N. Y.
- Visionette Co., 521 Fifth Ave., New York 17, N. Y.
- Vitamite Company, The, 227 W. 64th St., New York 23, N. Y.
- Vitramon, Inc., Stepany, Conn.
- Vokar Corp., 7300 Huron River Drive, Dexter, Mich.
- Volkert Metal Stampings, Inc., John, 222-34 96th Ave., Queens Village 8, N. Y.
- Vulcan Electric Co., 88 Holten St., Danvers, Mass.
- Waage Electric Inc., 54 Park Place, New York 7, N. Y.
- Wade Electric Products Co., 211 Jacob St., Sturgis, Mich.
- Wagner Electric Corp., 6400 Plymouth Avenue, St. Louis, Missouri.
- Waldes Kohinor Inc., 47-16 Austel Place, Long Island City 1, N. Y.
- Walker Co., George, 118 Amsterdam Ave., Passaic, N. J.
- Walker-Turner Div., Kearney & Trecker Corp., 639 South Ave., Plainfield, N. J.
- Walkirt Co., 5808 Marilyn Ave., Culver City, Calif.
- Wallace & Tiernan Products, Inc., Belleville 9, N. J.
- Waiser Automatic Timer Corp., Graybar Bldg., New York, N. Y.
- Walter Co., Inc., S., 1400 Atlantic Ave., Brooklyn 16, N. Y.

Waltham Horological Corp., Waltham, Mass.
Waltham Screw Co., 77 Rumford Ave., Waltham, Mass.
Wappler, Inc., 27 W. 24th St., New York 10, N. Y.
Ward Leonard Electric Co., 31 South St., Mt. Vernon, N. Y.
Ward Products Corp., Div. of the Gabriel Co., 1523 E. 45th St., Cleveland 3, Ohio.
Warren Mfg. Co., Inc., 250 East St., New Haven, Conn.
Warrick Co., Charles F., 16251 Hamilton Ave., Detroit 3, Mich.
Warrick, Frederick P., 1960 Graefield Rd., Birmingham, Mich.
Waterman Products, 2445-63 Emerald St., Philadelphia 25, Pa.
Waters, Inc., Robert A., 4 Gordon St., Waltham 54, Mass.
Waveforms, Inc., 333 Sixth Ave., New York 14, N. Y.
Webster-Chicago Corp., 5622 Bloomingdale Ave., Chicago 39, Ill.
Webster Electric Co., 1900 Clark St., Racine, Wis.
Webster Spring Corp., 176-182 Johnson St., Brooklyn 1, N. Y.
Weinschel Engineering Co., 123 William St., New York 7, N. Y.
Weksler Thermometer Corp., 52 W. Houston St., New York 12, N. Y.
Welch Scientific Co., W. M., 1515 Sedgwick St., Chicago 10, Ill.
Weller Electric Corp., 846 Packer St., Easton, Pa.
Wells-Gardner & Co., 2701 N. Kildare Ave., Chicago 39, Ill.
Welltronic Co., 19500 West 8 Mile Rd., Detroit 19, Mich.
Welwyn Electronic Components, Inc., 234 E. 46th St., New York 17, N. Y.
West Coast Electronics Co., 1601 S. Burlington Ave., Los Angeles 6, Calif.
West Virginia Pulp & Paper Co., Pulp Products Dept., 230 Park Ave., New York 17, N. Y.
Westberg Mfg. Co., 6535 N. Olmstead Ave., Chicago 31, Ill.
Western Electro-Acoustic Labs., 204 S. Beverly Drive, Beverly Hills, Calif.
Western Felt Works, 4029 Ogden Ave., Chicago, Ill.
Western Gold & Platinum Works, 589 Bryant St., San Francisco, Calif.
Western Insulated Wire Co., 2421 E. 30th St., Los Angeles, Calif.
Western Lithograph Co., E-Z Code Division, 600 East Second St., Los Angeles 54, Calif.
Western Sound & Electric Labs., Inc., 805 S. Fifth St., Milwaukee 4, Wis.
Western Union Telegraph Co., 60 Hudson St., New York 13, N. Y.
Westinghouse Electric Corp., 511 Wood St., P. O. Box 868, Pittsburgh 30, Pa.
Westinghouse Electric Corp., Electronic Tube Sales Dept., Bloomfield, N. J.
Westline Electronics Co., 11656 Olympic Blvd., Los Angeles 25, Calif.
Weston Electrical Instruments Corp., 595 Frelinghuysen Ave., Newark 5, N. J.
Weymouth Instrument Co., 1440 Commercial St., East Weymouth 89, Mass.
Wheaton Co., T. C., Industrial Div., 220 G St., Millville, N. J.
Wheelco Instruments Company, 847 W. Harrison Street, Chicago 7, Ill.
Wheeler Insulated Wire Co., Inc., 150 E. Aurora St., Waterbury 91, Conn.
Wheeler Laboratories, Inc., Great Neck, N. Y.
Whistler & Sons, Inc., S. B., 752 Military Rd., Buffalo 17, N. Y.
Whitaker Cable Corp., Kansas City 16, Mo.
White Dental Mfg. Co., S. S., Industrial Div., 10 E. 40th St., New York, N. Y.
Whitehead Stamping Co., 1691 W. Lafayette Blvd., Detroit 16, Mich.
Whitney Metal Tool Co., 150 Forbes St., Rockford, Ill.
Wiedemann Machine Co., 4272 Wissahickon Ave., Philadelphia 32, Pa.
Wilcox Electric Co., 1400 Chestnut St., Kansas City, Mo.
Wildberg Bros. Smelting & Refining Co., 742 Market St., San Francisco 2, Calif.
Wildner Mfg. Co., Inc., 411 Lexington Ave., Brooklyn 16, N. Y.
Wilkor Products Inc., 3835 W. 150th St., Cleveland 11, Ohio.
Willard Storage Battery Co., 246 E. 131st St., Cleveland 1, Ohio.
Williams & Co., C. K., 2001 Lynch Ave., East St. Louis, Ill.
Wilmington Fibre Specialty Co., P. O. Drawer 1028, Wilmington 99, Del.
Wilmore Inc., Raymond M., 1469 Church St. N. W., Washington 5, D. C.
Wilson & Co., G. C., 2 N. Passaic Ave., Chatham, N. J.
Wilson Co., H. A., The, 105 Chestnut St., Newark 5, N. J.
Wincharger Corp., E. 7th & Division Sts., Sioux City, Iowa.
Winchester Electronics, Incorporated, Glenbrook, Conn.
Winchester Repeating Arms Co., Div. of Olin Industries, Inc., New Haven, Conn.
Wind Turbine Co., Tower & Antenna Div., E. Market St. & Penna. R. R., West Chester, Pa.
Winslow Co., Inc., 9 Liberty St., Newark 5, N. J.
Wirt Co., 5221 Greene St., Philadelphia 44, Pa.
Wisconsin Porcelain Co., Sun Prairie, Wis.
Wolfe Co., Inc., Franklin C., 11723 Mississippi Ave., Los Angeles 25, Calif.
Wood Counter Laboratory, N., 5646 Harper Ave., Chicago 37, Ill.
Woodwelding, Inc., 3000 W. Olive Ave., Burbank, Calif.
Worcester Pressed Aluminum Corp., 13-15 Hope Ave., Worcester 3, Mass.
Workshop Associates Inc., The, 66 Needham St., Newton Highlands 61, Mass.
Worner Electronic Devices, Rankin, Ill.
Wright & Sons Co., William E., West Warren, Mass.
Wrought Washer Mfg. Co., 2264 S. Bay St., Milwaukee 7, Wis.
Wurlitzer Co., Rudolph, The, North Tonawanda, N. Y.
Yardney Electric Corp., 105 Chambers St., New York 7, N. Y.
York Co., Inc., Otto, 69 Glenwood Place, East Orange, N. J.
Young Brothers Co., 1829 Columbus Rd., Cleveland, Ohio.
Z & W Machine Products Inc., 5151 St. Clair Ave., Cleveland 3, Ohio.
Zell Products Corp., 276-280 Main St., P. O. Box 590, Norwalk, Conn.
Zenith Electric Co., 152 W. Walton St., Chicago 10, Ill.
Zenith Optical Co., Div. of Polan Industries, Huntington 19, West Virginia.
Zenith Optical Lab., 1940 Great Neck Rd., Copiague, N. Y.
Zenith Radio Corp., 6001 Dickens Ave., Chicago 39, Ill.
Zephyr Products Co., 160 E. 116th St., New York 29, N. Y.
Zernickow Co., O., 15 Park Row, New York 7, N. Y.
Zetka Television Tubes Inc., 131-37 Getty Ave., Clifton, N. J.
Zierick Mfg. Corp., Beechwood & Rockdale Aves., New Rochelle, N. Y.
Zophar Mills Inc., 112-130 26th St., Brooklyn 32, N. Y.

Distributors of **ELECTRONIC COMPONENTS AND EQUIPMENT**

The following is a list of distributors who are selling and stocking, for immediate delivery, electronic components, instruments, audio equipment, associated apparatus and allied products. These distributors perform a valuable service to manufacturers and users by providing quick delivery to meet the urgent requirements of designers and purchasing agents. This list is provided for the convenience of our subscribers and comprises the leading electronic distributors in the United States. Distributors who are advertisers in this issue have their names boldfaced and page number reference made to their advertisements. For further information regarding the services of these distributors, kindly refer to their advertisements.

ALABAMA

Ack Radio Supply Co., 2205 3rd Ave., N., Birmingham 3.
Allen & Jemison Co., Tuscaloosa.
Auto Service Co., 1916 S. 4th Avenue, Birmingham.
Bessemer Radio Supply Co., 116-118 N. 20th, Bessemer.
Clary, Co., James W., 2024 Fourth Ave., Birmingham.
Forbes Distributing Co., 2600 Third Avenue, S., Birmingham 5.
Hand Wholesale Radio, 231 South St., Dothan.
Harris Supply Co., Inc., 10 N. Water St., Mobile 6.
McDavid, & Co., Inc., R. P., 1630 Second Ave., Birmingham.
McGowin-Lyons Hardware & Supply Co., 113-125 N. Water St., P. O. Box 1209, Mobile.
Nelson Radio & Supply Co., 451 St. Louis St., Mobile 10.
Nolin-McInnis, Inc., 205 Commerce St., Montgomery 3.
Reid Distributing Co., 1724 Fifth Ave., N., Birmingham.
Signal Radio Supply Co., 243 E. Troy St., Dothan.
Southeastern Radio Parts Co., 210 Court St., Montgomery.
Teague Hardware Co., 204 Commerce St., Montgomery.

ALASKA

Alaska Radio Supply, Inc., Box 84-318 8th Ave., Anchorage.

ARIZONA

Dalis Brothers, 528 W. Jefferson St., Phoenix.
Electrical Equipment Co. of Arizona, P. O. Box 2630, Phoenix.
Midland Specialty Co., 233 S. 11th Avenue, Phoenix.
Radio Parts of Arizona, 36 W. Madison St., Phoenix.
Radio Specialties & Appl. Corp., 401 W. Jackson, P. O. Box 2229, Phoenix.
Standard Radio Parts, 551 N. 4th Ave., Tucson.

ARKANSAS

Blytheville Radio Supply, 112 S. First St., Blytheville.
Carlton Wholesale Radio, Inc., 109 W. 9th St., Little Rock.
Martin Wholesale Radio Supply, 1207 W. Kingshighway, Paragould.
Southern Radio Supply, 1419 Main St., Little Rock.
White Radio Supply Co., David, P. O. Box 408, 1222 Main St., Little Rock.
Wise Radio Supply, 1001 Towson Ave., Fort Smith.

CALIFORNIA

Altshuler Co., Cass, 6038 Telegraph Ave., Oakland.
Arbuckle, Jack C., 523 E. 19th Street, Bakersfield.
Arbuckle, Jack C., 2330 Kern St., Fresno.
Associated Radio Distributors, 1251-3 Folsom St., San Francisco.
Barrett, Kaemper, Dealers Supply Co., 1850 Mission St., San Francisco.
Braun-Knecht-Heimann Co., 1400 16th St., San Francisco.
Brill & Co., W. D., 198 10th St., Oakland.
Brill Co., W. D., 96 Camino Encinas, Orinda.
Brown Co., C. C., 61 Ninth St., San Francisco 3.
California Electronic Supply, 11801 W. Pico Blvd., Los Angeles 34.
Capitol Records, Inc., Sunset & Vine, Hollywood 28.
Channel Radio Supply Co., 434 State St., Santa Barbara.
Coast Electric Co., 744 G St., San Diego 12.
Coast Electronic Supply Co., 527 W. Main St., Alhambra.
Dean Co., Fred S., 969 American Ave., Long Beach 13.
DeJarnett Radio Supply, 1260 Van Ness St., Fresno.
Dow Radio Supply Co., 1759 E. Colorado St., Pasadena 4.
Dunlap Wholesale Radio Co., 2001 "O" St., Sacramento.
Dunlap Wholesale Radio Co., Carter W., 12 N. Aurora St., Stockton 8.
Electric Supply Co., 149 12th St., Oakland.
Electronic Equipment Distributors, 1228 Second Ave., San Diego.
Electronic Supply Co., 150 W. Green St., Pasadena.
Empire Electronic Supply, Inc., 37 E. Union St., Pasadena.
FEDERATED PURCHASER, INC., 911 South Grand Ave., Los Angeles 15. ADV. PG. 183.

Figart's Radio Supply Co., 6320 Commodore Sloat Dr., Los Angeles 36.
Gough Industries, Inc., 827 E. First St., Los Angeles.
Haggerty Radio Supply, 6826 San Fernando Rd., Glendale.
Henry Radio Shop, 11240 W. Olympic Blvd., Los Angeles.
Hollywood Radio Supply Inc., 5606 Hollywood Blvd., Hollywood 28.
Inland Electronic Supply, 863 Colton Ave., San Bernardino.
Kaemper-Barrett Dealers Supply Co., 1940 Ashby Ave., Berkeley.
Kaemper-Barrett Dealers Supply Co., 1850 Mission St., San Francisco.
Kemp Co., E. M., 1115 R Street, Sacramento.
Kierulff & Co., 725 L St., Fresno.
Kierulff & Co., 820-830 W. Olympic Blvd., Los Angeles.
Lynde Radio Supply, Larry, 853 Pine Ave., Long Beach.
Mac's Radio Supply, 8320 Long Beach Blvd., South Gate.
Martin Distributing Co., 2303 S. Union Ave., Los Angeles 7.
Meyberg Co., Inc., Leo J., 2027 S. Figueroa St., Los Angeles 15.
Meyberg Co., Leo, 33 Gough St., San Francisco.

Millers Radio & Television, 336 E. 8th St., Oakland.
Nelson Brothers Co., 630 N. Alvarado, Los Angeles.
Pacific Radio Exchange, 1407 Cahuenga Blvd., Los Angeles.
Pacific Wholesale Co., 116 N. 9th St., San Francisco.
Papal Bros., 2639 E. Fourth St., Los Angeles.
Pasadena Radio Supply, 6110 Santa Monica Blvd., Hollywood 38.
Quement Inc., Frank, 161 W. San Fernando St., San Jose.
Radio Doc, 721 S. Main St., Los Angeles.
Radio Equipment Distributors, 312 W. Pico Blvd., Los Angeles 15.
Radio Parts Co., Inc., 1045 11th Ave., San Diego.
Radio Parts Sales, 5222 S. Vermont Ave., Los Angeles.
Radio Products Sales, Inc., 1501 S. Hill St., Los Angeles 15.
Radio Specialties Co., 1956 S. Figueroa St., Los Angeles 7.
Radio & Television Equipment, 709 Cherry Ave., Long Beach.
Radio & Television Equipment, 207 Oak St., Santa Ana.
Radio Television Supply Co., 341 W. 18th St., Los Angeles 18.
Pavenscroft, Inc., A. E., 2320 S. Hill St., Los Angeles.
Sacramento Electric Supply Co., 1219 S St., Sacramento.
San Francisco Radio & Supply Co., 1282-84 Market St., San Francisco.
Scott Radio Supply, 266 Alamitos Ave., Long Beach 2.
Shanks & Wright, 2045 Kettner Blvd., San Diego 1.
Shelley Radio Co., 2008 Westwood Blvd., Los Angeles 25.
Smith & Crawford, 345 Mission St., San Francisco 3.
Thompson & Holmes, Ltd., 650 Second St., San Francisco.

United Radio & Electronics Co., 1356 S. Flower St., Los Angeles.
Universal Radio Supply Co., 1729 So. Los Angeles St., Los Angeles.
Valley Electronic Supply Co., 1302 N. Magnolia Blvd., Burbank.
Valley Radio Supply, 716 Baker St., Station A, Bakersfield.
Weatherford Co., R. V., 6919 San Fernando Rd., Glendale 1.
Wenner Co., E. C., 1450 Harrison St., Oakland.
Western Electronic Supply Corp., 7007 Melrose Ave., Los Angeles 38.
Western Radio & Television Supply Co., 1415 India St., San Diego 1.
Western Theatrical Equipment Co., 337 Golden Gate Ave., San Francisco 2.
Wholesale Radio & Electric Supply Co., 140 Ninth St., San Francisco.
Wresco, 140 Ninth St., San Francisco.
Yale Radio Electric, 6616 Sunset Blvd., Los Angeles.
Zach Radio Supply Co., 1426 Market St., San Francisco.

COLORADO

Henrie & Boltheff Co., 1635-17th St., P. O. Box 5110, Terminal Sta., Denver 17.
Interstate Radio & Supply Co., 1639 Tremont Place, Denver.

Niles Phonograph & Radio, 505-07 14th St., Denver.
Radio & Electronic Supply Co., 540 Ute Ave., Grand Junction.
Radio Products Supply Co., 1237 16th St., Denver 12.
Walker Radio Co., L. B., 218 W. Eighth St., Pueblo.

CONNECTICUT

Bond Radio Supply, The, 439 W. Main St., Waterbury 23.
Brown Co., Thomas H., 15-25 Whiting St., New Haven 10.
Congress Radio Co., 207 Congress Avenue, New Haven.
Hatry & Young, Inc., 1700 Main St., Bridgeport.
Hatry & Young, Inc., 203 Ann St., Hartford 3.
Hatry & Young, Inc., 77 Broadway, New Haven.
Hatry & Young, Inc., 525 Main St., Stamford.
Hatry & Young, Inc., 89 Cherry St., Waterbury.
Hatry & Young of New London, Inc., 428 Bank St., New London.
Moses Radio Electronics Co., 54 Flower St., Hartford 5.
Sceli & Co., R. G., 317 Asylum St., Hartford 3.
Stamford Radio Supplies, 562 Atlantic Ave., Stamford.
United Radio Supply, 47-53 E. Main St., New Britain.
Universal Radio Co., Inc., 61 E. Main St., New Britain.

DELAWARE

Radio Electric Service Co. of Pa., Inc., 4th & Tatnall Sts., Wilmington.
Wilmington Electrical Spec. Co., 405 Delaware Ave., Wilmington.

DISTRICT OF COLUMBIA

American Amplifier & Telev. Corp., 1111 19th St., N. W., Washington.
Capitol Radio Wholesalers, 2120 14th St., N. W., Washington.
Electronic Wholesalers, Inc., 2010 14th St., N. W., Washington 9.
Kenyon Radio Supply Co., 2214 14th St., N. W., Washington 9.
Rucker Radio Wholesalers, 1312 14th St., N. W., Washington.
Silberne Radio & Elec. Co., 3308-10 Eleventh St., N. W., Washington 10.
Southern Wholesalers, Inc., 707 Edgewood St., N. E., Washington 17.

FLORIDA

Cooper Radio Co., 648 Second Ave., S., St. Petersburg.
East Coast Radio & Television Co., 914 N. Miami Avenue, Miami.
Electric Supply Co., Inc., 106 S. Franklin St., Tampa 1.
Electronic Supply Co., 61 N. E. 9th St., Miami.
Flagler Radio Co., 1068 W. Flagler St., Miami.
Goddard Distributors, Inc., 1309 N. Dixie, W. Palm Beach.
Grice Radio & Electronic Supplies, 358 E. Wright St., Pensacola.
Gulf Electric & Hardware Co., 115 E. Gregory St., Pensacola.
Hammond-Morgan, Inc., 9 S. Terry St., Orlando.
Herman Radio Supply Co., 1745 N. E. Second Ave., Miami 36.
Kinkade Radio Supply Co., 1402-04 Laura Street, Jacksonville.
Kinkade Radio Supply Co., 402 W. Fortune St., Tampa.
Morley Radio Co., 944 Main St., Sarasota.
Radio Accessories Co., 1054 S. Florida Ave., Lakeland.
Radio Accessories Co., 62 E. Pine St., Orlando.
Radio Parts Co., 712 Main St., Jacksonville.
Sea Coast Appliance Distrib., Inc., 36 NE 21st St., Miami.
Southeast Audio Co., 112 W. Union St., Jacksonville.
Southern Hardware & Bicycle Co., 2336 Liberty St., Jacksonville.
Thurrow Distributors, Inc., 15-17 E. Church St., Jacksonville.
Thurrow Distributors, Inc., 420 S. W. 8th Avenue, Miami.

Thurrow Distributors, Inc., 131 S. Court St., Orlando.
Thurrow Distributors, Inc., 213 E. Tennessee St., Tallahassee.
Thurrow Distributors, Inc., 134-136 S. Tampa St., Tampa.
Thurrow Distributors, Inc., Box 3002, West Palm Beach.
Walder Radio & Appliance, 1809 N. E. Second Avenue, Miami 36.
Welch Radio Supply, 408 Ninth St., S., St. Petersburg.

GEORGIA

Atlanta Phonograph Co., 27 Pryor St., NW., Atlanta.
Concord Radio Corp., 265 Peachtree St., Atlanta 3.
Economy Auto Stores, Inc., 1130 Bankhead Highway, PO Box 5078, Atlanta.
Electronic Distributing Co., 754 Ponce de Leon Place, N. E., Atlanta 5.
Garvin Electric Co., 69 Fourth St., N. W., Atlanta 5.
Guy White Radio Co., 654 Mulberry St., Macon.
Hatcher Co., A. S., 596-98 Third St., Macon.
Prestwood Electronics Co., 708 Reynolds St., Augusta.
Radio Sales & Service Co., 1326 First Ave., Columbus.
Southeastern Radio Parts Co., 442 W. Peachtree St., Atlanta.
Southeastern Radio Parts Co., Montgomery St., Savannah.
Specialty Distributing Co., 104 Pine Ave., Albany.
Specialty Distributing Co., 425 Peachtree St., NE., Atlanta.
Specialty Distributing Co., Inc., 539 Arch St., PO Box 815, Macon.
Specialty Dist. Co., 233 E. Broughton St., Savannah.
Yancey Co., Inc., 340 W. Peachtree St., NW., Atlanta 3.

IDAHO

Craddock's Radio Supply, 1522 State St., Boise.
Kopke Electronics Co., 119 Peasley St., Boise.

ILLINOIS

ALLIED RADIO CORP., 833 W. Jackson Blvd., Chicago 7. ADV. PG. 238.
Alverson Sales Co., 208 E. Front St., Bloomington.
Bowman & Co., J. G., 513 E. 75th Street, Chicago 19.
Central Scientific Co., 1700 Irving Park Rd., Chicago.
Chauncey's Inc., 4737 W. Chicago Avenue, Chicago 51.
Chicago Apparatus Corp., 1735 N. Ashland Avenue, Chicago.
Concord Radio, 901 Jackson Blvd., W., Chicago.
Cooper Supply Co., 935 Main Street, Quincy.
Fox Electric Supply Co., 67-69 N. State Street, Elgin.
Gates Radio Co., 123 Hampshire, Quincy.
Herberger Radio Supply, P. O. Box 1197, Peoria 1.
Hyland Electrical Supply Co., 700 W. Jackson Blvd., Chicago.
Illinois Appliance Co., 407 W. First Street, Dixon.
Klaus Radio & Electric Co., 707 Main Street, Peoria 2.
Lampley Radio Supply, 802 N. McLeansboro St., Benton.
Lofgren Distributing Co., 1202 4th Avenue, Moline.
Loughane & Company, 804 N. Water Street, Decatur.
LUKKO SALES CORP., 5024 Irving Park Rd., Chicago. ADV. PG. 409.
Lurtz Electric Co., 210 N. Illinois St., Belleville.
Montgomery Ward & Co., W. Chicago Ave. & Larrabee St., Chicago.
NEWARK ELECTRIC CO., INC., 323 W. Madison Street, Chicago 6. ADV. PG. 411.
Pilgrim Distributing Co., 910 W. Jackson Blvd., Chicago.
Radio Parts Co., 612 W. Randolph St., Chicago 6.
Radio Parts Outlet, Inc., 4305 Lincoln Avenue, Chicago 18.
Radolek Co., 601 W. Randolph St., Chicago 6.
Spiegel, Inc., 1061 W. 35th St., Chicago 9.
Triangle Industries Corp., 600 W. Adams Street, Chicago.
Tri-City Radio Supply, 1919 Fourth Avenue, Rock Island.
Walker-Jimieson, Inc., 311 S. Western Avenue, Chicago 12.
Wilson Supply Co., 108 W. Jefferson Street, Springfield.
York Radio Supply Corp., 801-805 N. Broadway, Decatur.

INDIANA

Archer & Evinger, 1348 Wabash Avenue, Terre Haute.
Associated Distributors, Inc., 210-214 S. Meridian Street, Indianapolis 4.
Bowman & Co., J. G., 103 Lafayette Street, Valparaiso.
Commercial Sound & Radio Co., 528 E. Colfax Avenue, South Bend.
Graham Co., Inc., Phillip E., 2606 W. Michigan Street, Indianapolis 22.
Hub Distributors, 106 N. Main Street, Crown Point.
Lafayette Radio Supply, Inc., 408 E. North Street, Lafayette.
Meunier Radio Supply Company, 524 N. Illinois Street, Indianapolis.
Pemberton Laboratories, 919 Broadway, Fort Wayne 2.
Radio Distributing Co., 1013 N. Capitol Avenue, Indianapolis.
Radio Distributing Co., 432 S. Carroll Street, South Bend.
Radio Electronic Supply Co., 1419 Cameron Street, Lafayette.
Seybert's Radio Supply Co., 1331 Main Street, Anderson.
Van Sickle Radio Supply Co., 102 S. Pennsylvania St., Indianapolis.
Warren Radio Co., 720 S. Clinton, Fort Wayne.

IOWA

Boe Distributing Co., 498 N. Grandview Avenue, Dubuque.
Duke's Radio Company, 209 Sixth Street, Sioux City.
Farnsworth Radio & Television Co., 623 Jefferson, Waterloo.
Gifford-Brown, Inc., 106 1st Street. SW, Cedar Rapids.
Gifford-Brown, Inc., 1216 Grand Avenue, Des Moines 9.

Iowa Radio Corporation, 1212 Grand Avenue, Des Moines 9.
Ken-Elis Radio Supply Co., 810 N. 9th, Fort Dodge.
Midwest-Timmermann Co., 114 Western Avenue, Davenport.
Onthank Co., G. W., 10th and Mulberry, Des Moines.
Radio Trade Supply Co., 1224 Grand Avenue, Des Moines 9.
Radio Trade Supply Corp., 115 W. Second, Ottumwa.
Ray-Mac Supply Co., 613 Water Street, Waterloo.
RCA Victor Distributing Corp., 1235 W. 5th Street, Davenport.
Siddles Co., 912 Locust Street, Des Moines.
Sioux City Radio & Appliance Co., 210 W. 7th Street, Sioux City 16.
Union Supply Co., 4th & Washington, Burlington.
World Radio Laboratories, Inc., 740-744 W. Broadway, Council Bluffs.

KANSAS

Acme Radio Supply, 516 Quincy Street, Topeka.
Amateur Radio Equipment Co., Inc., 1215 E. Douglas Street, Wichita.
Costelow Co., Inc., John A., 125 Kansas Avenue, Topeka.
Excel Distributors, 118 W. 2nd Street, Wichita 2.
Four-State Radio & Supply Co., 227 Santa Fe, Salina.
Interstate Distributors Inc., 1236 E. Douglas, Wichita 7.
Overton Electric Co., Inc., 522 Jackson Street, Topeka.
Pittsburg Radio Supply Co., 212 S. Broadway, Pittsburg.
Radio Supply Co., 1125-27 E. Douglas, Wichita.
RCA Victor Distributing Corp., 351 N. Water, Wichita.
Western Distributors, 227 N. Santa Fe, Salina.

KENTUCKY

Burks & Co., P. I., 911 W. Broadway, Louisville 3.
Central Electronic Supply Co., Inc., 600 W. Third St., Owensboro.
Ewald Distributing Co., 309 S. 9th Street, Louisville 3.
Miller, Barney, 239 E. Main Street, Lexington.
Peerless Electronic Equipment Co., 912-914 S. 2nd Street, Louisville 3.
Radio Equipment Co., 480 Skain Avenue, Lexington 34.
Universal Radio Supply Co., 533 S. Seventh St., Louisville 3.
West Kentucky Electronic Supply Co., 1205 Broadway, Paducah.

LOUISIANA

Allen Supply Co., Wm. B., 1601 Orleans St., New Orleans 16.
Autiotronics Supply Co., 2100 Benefit St., New Orleans 22.
Bell Radio Supply Co., 826 N. Broad St., New Orleans.
Central Radio Supply, 509 Monroe St., Alexandria 1.
Columbia Radio & Supply Co., 3940 3rd St., New Orleans 13.
Crescent Radio & Supply Co., 1428 Baronne St., New Orleans.
Electrical Supply Co., 21 Magazine St., New Orleans.
Electronic Supply Co., 1753 N. 21st St., Baton Rouge.
Hale & McNeil, Cor. N. 3rd & Pine Sts., Monroe.
Kochemay Sales Co., 220 Crockett St., Shreveport.
Lynch & Co., Inc., S. H., 832 Baronne St., New Orleans.
Ole Miss Supply, 91 Carondelet St., New Orleans.
Radio Electronic Supply, 1419-21 Cameron St., Lafayette.
Radio Parts, Inc., 807 Howard St., New Orleans.
Schneider & Sons, Inc., F. H. 215 Lake St., Lake Providence.
Schuler Supply Co., 415 Dryades St., New Orleans.
Southern Radio Supply, 1900 Tulane Ave., New Orleans 19.
Walther Bros. Co., Inc., 714 Howard Ave., New Orleans.

MAINE

Cressey & Allen, 35 Commercial Street, Portland 6.
Maine Electronic Supply Corp., 13 Deer Street, Portland.
Radio Service Laboratory, 76 Exchange Street, Bangor.
Radio Service Laboratory, 45A Free Street, Portland 3.
Radio Supply Co., Inc., 28 Cross Street, Auburn.

MARYLAND

D & H Distributing Co., 25 S. Liberty Street, Baltimore.
Kann-Ellert Electronics Inc., 9 South Howard Street, Baltimore 1.
Radio Electric Service Co., 3 N. Howard St., Baltimore 1.
Rucker Radio Wholesalers, 8049 13th St., Silver Spring.
Wholesale Radio Parts Co., Inc., 311 W. Baltimore St., Baltimore 1.
Zimmerman Wholesalers, 32 Bedford St., Cumberland.
Zimmerman Wholesalers, 110 E. Washington St., Hagerstown.

MASSACHUSETTS

Beckman & Co., C. E., 11-35 Commercial St., New Bedford.
Burke Co., J. H., 37-39 Brighton Ave., Boston.
Cushing, T. F., 349 Worthington St., Springfield 3.
Dean & Co., David B., 85 Cohannet St., Taunton.
DeMambro Radio Supply Co., 1111 Commonwealth Ave., Boston 15.
DeMambro Radio Supply, Inc., 222 Summer St., Worcester.
Eastern Co., 620 Memorial Dr., Cambridge.
Electrical Supply Corp., 1739 Massachusetts Ave., Cambridge 40.
Flint Radio Co., 73 Troy St., Fall River.
Gerber Radio Supply Co., 1900 Columbus Ave., Roxbury 19.
Hatry & Young of Mass., Inc., 42-44 Cornhill St., Boston.
Hatry & Young of Mass., 262 Lowell St., Lawrence.

Hatry & Young of Springfield, 169 Spring St., Springfield.

Herman Co., Louis M., 885 Boylston St., Boston.
Mayer Co., A. W., 895 Boylston St., Boston 15.
Melrose Sales Co., 407 Franklin St., Melrose 77.
Pittsfield Radio Co., 44 West St., Pittsfield.
Radio Electronic Sales Co., 46 Chandler St., Worcester 2.
Radio Maintenance Supply Co., 19-25 Central St., Worcester.

RADIO SHACK CORP., 167 Washington St., Boston. ADV. PG. 404.

Radio Wire Television, Inc., 110 Federal St., Boston.
Sager Electrical Supply Co., 201 Congress St., Boston.
Springfield Radio Co., Inc., 405 Dwight St., Springfield.
Springfield Sound Co., 147 Dwight St., Springfield.
Tarbell Watters Co., West St. & Clapp Ave., Pittsfield.

Tarbell Watters Co., 144 Chestnut St., Springfield.
Ware Radio Supply Co., 913 Centre St., Brockton 11.
Willett Radio Supply Inc., 11 Court St., Natick.

MICHIGAN

Duffy & Co., M. N., 2040 Grand River Ave., Detroit 26.
Earle Appliance Distributors, Inc., 814 First Ave., North Escanaba.
Electric Products Sales Co., 427 E. Michigan Ave., Lansing 29.
Electronic Supply Corp., 187 W. Michigan Ave., Battle Creek.
Electronic Supply Corp., 248 E. Pike St., Pontiac.
Ferguson Radio Supply Co., 622 W. Baltimore, Detroit 2.
Fitzpatrick Electric Supply Co., Inc., 444 Irwin St., Muskegon.
Fulton Radio Supply Co., 265 W. Cortland St., Jackson.
General Motors Corp., United Motors Service Div., 3044 W. Grand Ave., Detroit.
Industrial Electric Supply Co., 1839 Peck St., Muskegon.
K-L-A Laboratories, Inc., 7422 Woodward Ave., Detroit 2.
Lifsey Distributing Co., 726-30 N. Saginaw, Flint 3.
Morley Brothers, 5943 Second Ave., Detroit 2.
Morley Brothers, 25 Ottawa Ave., W. Grand Rapids.
Morley Brothers, 115-129 N. Washington Ave., Saginaw.
Northwest Radio of Michigan, 435 Tamarack St., Laurium.
Offenhauer Company, 227 W. Washtenaw, Lansing.
Orem Distributing Co., 801 E. Genesee, Saginaw 11.
Radio Electronics Supply Co., 1112 W. Warren, Detroit 1.
Radio Electronic Supply Co., 505 Jefferson Ave. S. E., Grand Rapids 3.
Radio Parts Co., Water & Millard Sts., Saginaw.
Radio Specialties, 456 Charlotte St., Detroit 1.
Radio Supply & Engineering Co., Inc., 85 Selden Ave., Detroit 1.
Radio Tube Merchandising Co., 508 Clifford St., Flint 3.
Ralston Co., Ralph M., 201 N. Park St., S., Kalamazoo.
RCA Victor Distributing Corp., 7400 Intervale Ave., Detroit.
Shand Radio Specialties, 203 W. Kearsley, Flint 3.
Stevens Radio Parts, 713 Portage St., Kalamazoo.
Straits Distributors, Inc., 200 S. Main St., Sheboygan.
Wedemeyer Electronics Supply Co., 213-217 N. Fourth Ave., Ann Arbor.
Wedemeyer Electronic Supply Co., 2005 E. Michigan Ave., Lansing.
West Side Radio Supply, 6724 Michigan Ave., Detroit 10.
Wholesale Radio Co., 317 S. Division St., Grand Rapids.

MINNESOTA

Bauman Co., 3033-35 Lyndale Ave. S., Minneapolis 8.
Bonn Co., Lew, 228 E. Superior St., Duluth.
Bonn Co., Lew, 1211 LaSalle Ave., Minneapolis 4.
Bonn Co., Lew, 141-147 W. 7th St., St. Paul 2.
Electronic Distributing Co., 856 Raymond Ave., St. Paul 4.
Hall Electric Co., 386 Minnesota St., St. Paul 1.
Hayer Co., E. C., 300 Washington Ave., N., Minneapolis.
Northwest Radio, 109 E. First St., Duluth 2.
Northwest Radio & Electronic Supply Co., 52 S. 12th St., Minneapolis 4.
Northwest Radio & Electronic Supply Co., 194 W. 4th St., St. Paul 2.
Radio Electric Supply Co., 2451 Nicollet Ave., Minneapolis.
Radio Maintenance Co., 3016 1/2 27th St., S., Minneapolis 6.
S. M. Supply Co., 321 First Ave., SW, Rochester.
Stark Radio Supply Co., 71 S. 12th St., Minneapolis 4.

MISSISSIPPI

Cabell Electric Co., 422-24 S. Farish St., Jackson 110.
Goyer Supply Co. (Home Appliance Div.), 805 Alexander, Greenville.
Industrial Suppliers, Inc., Radio Div., Highway 80, Jackson.
Radio Supply Co., 909 24th Ave., Meridian.
Ryan Supply Co., 508-514 E. Pascaquola St., Jackson.
Ryan Supply Co., 814 21st, NE, Meridian.
Southern Distributors, Inc., 330 W. Caioit St., Jackson.
Swann Distributing Co., Inc., 717 W. Monument, Jackson.

MISSOURI

Acme Radio Supply, 110 N. 9th St., St. Joseph.
Ashe Radio Co., Walter, 1125 Pine St., St. Louis.
Brotherson, M., 515 N. Beyers St., Joplin.
Brown Radio Co., Tom, 3924 Washington Ave., St. Louis.
Burstin-Applebee, 1012 McGee St., Kansas City.
Central Missouri Distributing Co., 324 Capital St., Jefferson City.
Ebinger Radio & Supply Co., 2211 Gravois Ave., St. Louis 4.
Four State Radio & Supply Co., 201 Main, Joplin.

Gordon, Co., J. C., 1118 Pine St., St. Louis 9.
 Henry Radio Co., 211-215 N. Main St., Butler.
 Henshaw Radio Supply, 3619 Troost Ave., Kansas City.
 Hollander & Co., Inc., 3900 W. Pine St., St. Louis.
 Interstate Supply Co., 10th & Walnut Sts., St. Louis.
 Manhattan Radio & Equipment, Inc., 1732 Grand Ave., Kansas City 8.
 McGee Radio Co., 1422 Grand Ave., Kansas City.
 Potter Radio Co., 1312 McGee St., Kansas City 6.
 Radiolab, 1612 Grand Ave., Kansas City 8.
 Radonics, 5040 Easton Ave., St. Louis.
 Radonics, 2218 S. Jefferson, St., St. Louis.
 RCA Victor Distributing Corp., 2113-2115 Broadway, Kansas City.
 Reed Radio & Supply, Harry, Main P. O. Box, Springfield.
 St. Joseph Radio & Supply Co., 922-24 Francis St., St. Joseph.
 Suedekum Electronic Supply Co., 902 S. Sprigg St., P. O. Box 221, Cape Girardeau.
 Tri-State Radio & Supply Co., 136 Bartlet St., Poplar Bluff.
 Van Sickle Radio Co., 1113 Pine St., St. Louis 1.

MONTANA

Electronic Supply Co., 214 Eleventh St., Billings.
 Lindgren Co., 109 Central Ave., Great Falls.
 Northwestern Auto Supply Co., 420 N. Broadway, Billings.
 Smitty's Electronics, 126 W. Broadway, Butte.
 Valley Motor Supply Co., 512-514 First Ave., S., Great Falls.

NEBRASKA

Hicks Radio Co., 1422 "O" St., Lincoln 8.
 J B Distributing Co., 2855-57 Farnam St., Omaha 2.
 Joachim Radio Supply, 1913 Broadway, Scottsbluff.
 Leuck Radio Supply Co., 243 S. 11th St., Lincoln.
 Noll Co., H. C., 2226 Harney St., Omaha.
 Omaha Appliance Co., 17 St. Mary's St., Omaha.
 Radio Equipment Co., 282-22 Farnam St., Omaha.
 Sidles Co., 508 S. 19th St., Omaha.

NEW JERSEY

Allen & Hurlley, 25 S. Warren St., Trenton 10.
 All State Distributors, 30 Warren Place, Newark.
 Apollo Distributing Co., 15 Shipment St., Newark 2.
 Continental Sales Co., 195-201 Central Ave., Newark.
 Dale-New Jersey, Inc., 79 Lock St., Newark.
 Electronic Marketers, Inc., 415 Halsey St., Newark 2.
FEDERATED PURCHASER, INC., 114 Hudson St., Newark. ADV. PG. 183.
 General Radio Co., 207 N. Broadway, Camden.
 International Distributing Co., 821 S. Orange Ave., East Orange.
 Jersey Electronic Dist. Co., 301 Grand St., Paterson 1.
 Joe's Radio Shop, 67-69 S. Pearl St., Bridgeton.
 Kearns, Inc., Harrisburg & Atlantic Aves., Atlantic City.
 Krich-Radisco, Inc., 422-432 Elizabeth Ave., Newark 8.
 Lippman & Co., Aaron, 246 Central Ave., Newark 4.
 M & H Sporting Goods Co., 1832 Atlantic Ave., Atlantic City.
 Nidisco-Jersey City, Inc., 713 Newark Ave., Jersey City 6.
 Nidisco Passaic, Inc., 294 Passaic, Passaic.
 Nidisco-Trenton, Inc., 126 S. Warren St., Trenton.
 O'Loughlin & Co., Inc., T. A., 90 Washington St., Newark.
 Radio Electric Service Co. of Pa., Inc., 406 Albany Ave., N. Atlantic City.
 Radio Elect. Serv. Co. of Pa., 513-515 Cooper St., Camden.
 Radio Wire Telev. Inc., 24 Central Ave., Newark.
 Teldisco, Inc., 444 William St., E. Orange.
 Williams Co., Carl B., 154 S. Main St., Phillipsburg.

NEW MEXICO

Walker Radio Co., Inc., 114 W. Granite, P. O. Box 921, Albuquerque.

NEW YORK

Adirondack Radio Supply, 32 Guy Park Avenue, Amsterdam.
 Arace Electronic Distributors, 25-27 Henry St., Kingston.
 Arrow Electronics, Inc., 82 Cortlandt St., New York 1.
 Barclay-New York, Inc., 139 Cedar St., New York.
 Barker Roses' Kimball, Inc., 511 Baldwin St., Elmira.
 Beacon Electronics, Inc., 14 Catherine St., Utica.
 Beacon Electronic Distb., 108 Lincoln Bldg., Watertown.
 Benray Distributing Co., 506 Coney Island Ave., Brooklyn.
 Berndt, W. E., 653-55 S. Warren St., Syracuse.
 Bickford Bros. Co., 1209 Broadway, Buffalo.
 Bickford Bros. Co., 208 St. Paul St., Rochester 4.
 Brahan Electrical Supply Co., John, 304 W. 55th St., New York.
 Brujac Electronic Corp., 103 Lafayette St., New York.
 Bruno-New York, Inc., 460 W. 34th St., New York 1.
 Buchman Radio Co., 492 Atlantic Ave., Brooklyn 17.
 Calvert Electronics, Inc., 1947 Broadway, New York 23.
 Certified Radio Supply, 45 Cottage St., Middletown.
 Chanroese Radio Stores, Inc., 170-16 Jamaica Ave., Jamaica 3.
 Chief Electronics, 104 Main St., Poughkeepsie.
 Consolidated Radio Sales Corp., 768 Amsterdam Ave., New York 25.
 Dale Distributing Co., Inc., 40 E. 32nd St., New York.
DALIS, INC., H. L., 175 Varick St., New York 14. ADV. PG. 122.
 Dare's Radio Service, 22 E. Genesee St., Auburn.
 Davis Electronics Corp., 204 Main St., Hemstead.
 Davis Radio Distributing Co., 66 E. 3rd St., Mt. Vernon.
 Dymac, Inc., 2329 Main St., Buffalo 14.

Electric City Radio Supply, 1566 State St., Schenectady.
 Electronic Laboratories & Supply Co., 915 Lincoln Ave., Utica 4.
 Electro-Tech Equipment Co., Inc., 117 Lafayette St., New York 13.
 Electronic Equipment Co., 2912 Atlantic Ave., Brooklyn.
 Federal Radio Supply Co., 188 State St., Binghamton.
FEDERATED PURCHASER, INC., 66 Dey St., New York 7. ADV. PG. 183.
 Fischer Distributing Co., Inc., 118 Duane St., New York 7.
 Fordham Radio Supply, 5669 Broadway, New York 63.
 Fort Orange Radio Distributing Co., 642-44 Broadway, Albany.
 Fulton County Distr. Co., 14 Bleeker St., Gloversville.
 Genesee Radio & Parts Co., 205 Genesee St., Buffalo 3.
 Gershoff Elect. Sup. Corp., 220 W. 83rd St., New York.
 Goler Elect. Sup. Corp., 225 S. Broadway, Yonkers.
 Graybar Electric Co., 420 Lexington Ave., New York.
 General Offices—branches in 105 principal cities.
 Green Radio Distributors, 482 Sutter Ave., Brooklyn 7.
 Harrison, Fred C., 108 W. Church St., Elmira.
HARRISON RADIO CORP., 172-31 Hillside Ave., Jamaica, L. I. ADV. PG. 247.
HARRISON RADIO CORP., 12 W. Broadway, New York 7. ADV. PG. 247.
HARVEY RADIO CO., 103 W. 43rd St., New York 18. ADV. PG. 339.
 Hornbeam Distributing Co., 67-15 Fresh Pond Rd., Brooklyn.
 Hornbeam Distributing Co., 1630 Bedford Ave., Brooklyn.
 Hornbeam Distributing Co., 4117 Ft. Hamilton Pkwy., Brooklyn 19.
 Hornbeam Distributing Co., 61-01 16th Ave., Brooklyn.
 Hudson Radio & Television Corp., 212 Fulton St., New York.
 Island Radio Distributors, 412 Fulton Ave., Hempstead, L. I.
 Johnson Radio & Elect. Equip. Co., 45 Harrison St., Jamestown.
 L & S Radio Sales Co., 132-134 North St., Middletown.
 Leonard Radio, Inc., 69 Cortlandt St., New York 7.
LUST, HENRY B., 310 W. 85th St., New York. ADV. PG. 418.
 Masline Radio Parts, 192-196 Clinton Ave., Rochester 4.
 Melville Radio Corp., 160-13 Northern Blvd., Flushing.
MILO RADIO & ELECTRONICS CORP., 200 Greenwich St., New York. ADV. PG. 74.
 Morris Distributing Co., Inc., 195 Water St., Binghamton.
 Morris Distributing Co., 412 S. Clinton St., Syracuse.
 National Radio Distributors, 1348 Southern Blvd., New York 59.
 National Radio Parts Dist. Co., 611 New York Ave., Brooklyn 3.
 Newark Electric Co., Inc., 242 W. 55th St., New York.
 Niagara Radio & Parts Co., 1518 Main St., Niagara Falls.
 Norman Radio Distributors, Inc., 94-29 Merrick Rd., Jamaica 5.
 O & W Radio Co., 141 Cedar St., New York.
 Peerless Electronic Distributors Corp., 76 Willoughby St., Brooklyn.
 Peerless Radio Distributors, Inc., 92-32 Merrick Rd., Jamaica, L. I.
 Powell Radio Supply, 142 W. 169th St., New York 52.
 R. T. A. Distributors, Inc., 36 Broadway, Menands, Albany 7.
 Radio Equipment Corp., Inc., 145-151 Genesee St., Buffalo 3.
 Radio Supply Co., 200 Walton St., Syracuse.
 Radio Wire Television, Inc., 542 E. Fordham Rd., Bronx.
 Radio Wire Television, Inc., 100 Sixth Ave., New York 13.
 Radionic Equipment Co., 170 Nassau St., New York.
 Ray Distributing Co., 188 Glen St., Glens Falls.
 Roberts & O'Brien, 714-716 Park Ave., Syracuse 4.
 Rochester Radio Supply Co., 114 St. Paul St., Rochester 4.
 Sanford Electronics Corp., 157 Chambers St., New York.
 Slate & Co., 2755 Webster Ave., New York 58.
 Smith, Inc., Stewart, 325 E. Water St., Syracuse.
 Soncraft Corp., 115 West 45th St., New York 19.
 Stallman of Ithaca, 123-131 S. Tioga St., Ithaca.
 Stan-Burn Radio & Electronics Co., 558 Coney Island Ave., Brooklyn 18.
 Stan-Burn Radio & Electronics Co., 1697 Broadway, New York 19.
 Standard Electronics Co., 1497 Main St., Buffalo 8.
 Standard Parts Corp., 235 Main St., Hempstead, L. I.
 Strong Television Corp., 286 Main St., Farmingdale.
SUN RADIO & ELECTRONICS CO., INC., 122-124 Duane St., New York 7. ADV. PG. 293.
 Sylvan-Wellington Co., 269 Canal St., New York 13.
 Taylor Co., E. E., 465 Central Ave., Albany 5.
TERMINAL RADIO CORP., 85 Cortlandt St., New York City. ADV. PG. 271.
 Trojan Radio Co., Inc., 426 River St., Troy.
 United Radio & Electric Co., 47 W. 63rd St., New York 23.
 Vaeth Electric Co., 35 Genesee St., Utica.
 Vermont Hardware Co., Inc., 40 E. Main St., Malone.
 Westchester Electronic Supply Co., 420 Mamaroneck Ave., White Plains.
 Wilco Radio Distributors, 383 E. 138th St., New York.

NEVADA

Metcalf's Radio Supply, 207 N. Third St., Las Vegas.

NEW HAMPSHIRE

American Radio Corp., 510 Central Ave., Dover.
 DeMambo Radio Supply Inc., 1308 Elm St., Manchester.
 Evans Radio, 10 Hills Ave., Concord.
 Radio Service Laboratory, 670 Chestnut St., Manchester.

NORTH CAROLINA

Carolina Radio Equipment Co., Inc., 105-107 E. Martin St., Raleigh.
 Dalton-Hege Radio Supply Co., 340 Brookstown Ave., Winston-Salem.
 Dixie Radio Supply Co., 715 W. Moorehead St., Charlotte.
 Freck Radio & Supply Co., Inc., 38 Biltmore Ave., Asheville.
 Glasgow Supply Co., 224 S. Cedar St., P. O. Box 1997, Charlotte 1.
 Johannesen Electric Co., Inc., 312-314 N. Eugene St., Greensboro.
 Lambeth Electric Supply Co., 100 Burke St., Winston-Salem.
 Long's Distributing Co., 68 N. Market St., Asheville.
 Noland Co., Inc., 636 W. Fourth St., Winston-Salem.
 Radio Amateur Center, Hillsboro St., Raleigh.
 Radiotronic Distributors Inc., 208 N. College St., Charlotte.
 Signal Radio Supply, Goldsboro.
 Southeastern Radio Supply Co., 416 Market St., Greensboro.
 Southeastern Radio Supply Co., 411-15 Hillsboro St., Raleigh.
 Southern Radio Corp., 1625 W. Morehead St., P. O. Box 2356, Charlotte 1.

NORTH DAKOTA

Bristol Distributing Co., 2121 Front St., Fargo.
 Dakota Electric Supply Co., 1017-23 Fourth Ave., N., Fargo.
 Hayer Co., F. C., 814 First Ave., North P. O. Box 1657, Fargo.
 McFall Radio Co., 5B N. Main St., Box 1055, Minot.
 Quanrud, Brink & Riebold, 122 First St., Bismarck.
 Radio Equipment Co., 624 Second Ave., N., Fargo.

OHIO

Armstrong Radio Supply, 216 Second St., SE, Canton 2.
 Burroughs Radio Co., 711 Second St., NW, Canton 3.
 Burroughs Radio Co., 218 E. Second St., Mansfield.
 Chambers Electronic Supply Co., Inc., 1667-71 Central Parkway, Cincinnati.
 D & R Radio Supply Co., Inc., 156 S. 3rd St., Steubenville.
 Eberle's Radio Supply, 522 W. Main St., Springfield.
 El-A-Co., 121 Lodi St., Elyria.
 Electronic Supply Corp., 134 E. Long St., Columbus 15.
 Goldamer, Inc., 2239 E. 14th St., Cleveland.
 Hamburg Brothers, 320 E. Federal St., Youngstown.
 Hausfeld Radio Supply, 116 N. 3d St., Steubenville.
 Herrlinger Distributing Co., 1436 Vine St., Cincinnati 10.
 Howard's Electronic Supply, 135 17th St., Toledo 2.
 Hughes-Peters, Inc., 1128 Sycamore St., Cincinnati.
 Hughes-Peters, Inc., 111 E. Long St., Columbus 15.
 Hughes-Peters, Inc., 300 W. 5th St., Dayton.
 Hutch & Son, 125 S. Elizabeth St., Lima.
 Jantzen Radio Specialties, 136 Pine Ave. S. E., Warren.
 Lima Radio Parts Co., 641-43 N. Main St., Lima.
 Main Line Cleveland, Inc., 5005 Euclid Ave., Cleveland 3.
 Mainline Distributors, Inc., 374-384 S. Erie St., Toledo 2.
 Martin Co., M. H., 50 Charles Ave., SE, Massillon.
 Morrison's Radio Supply, 331 Center St., Ashtabula.
 Northern Ohio Laboratories, 2073 W. 85th St., Cleveland.
 Northwestern Radio Co., 116 W. Spring St., Lima.
 Ohio Appliances, Inc., Daylight Bldg., E. Court & 6th St., Cincinnati.
 Ohio Appliances, Inc., 430 Leo St., Dayton 4.
 Oliver Theatre Supply Co., Inc., 1701 E. 23rd St., Cleveland.
 Olson Radio Warehouse, Inc., 73 E. Mill St., Akron 8.
 Olson Radio Warehouse, 2020 Euclid Ave., Cleveland.
 Pioneer Radio Supply Co., 2115 Prospect Ave., Cleveland 15.
 Progress Radio Supply Co., 413-415 Huron Rd., Cleveland.
 Radio & Electronics Parts Corp., 3235 Prospect Ave., Cleveland 15.
 Radio Parts Co., 309-11 W. Commerce St., Youngstown.
 Radio & Refrigeration Supply Co., 1220 Jackson St., Cincinnati.
 Ross Radio Co., 325 W. Federal St., Youngstown 3.
 Schuster Electric Co., The, 321 Sycamore St., Cincinnati.
 Srepro, Inc., 135 E. 2nd St., Dayton 2.
 Steinberg's Inc., 633 Walnut St., Cincinnati 2.
 Stotts Friedman Co., 620-22 S. Main St., Dayton 2.
 Sun Radio Co., The, 110 E. Market St., Akron 8.
 Thompson Radio Supplies, 182 E. Long St., Columbus 15.
 Thompson Radio Supplies, 135 S. 6th St., Zanesville.
 Toledo Radio Specialties, 1215 Jackson St., Toledo 2.
 United Radio, Inc., 1314 Vine St., Cincinnati.
 Warren Radio Co., 479 S. Main St., Akron.
 Warren Radio Co., 222 S. Elizabeth, Lima.
 Warren Radio Co., 1320 Madison St., Toledo 2.
 Whitehead Radio Co., 124 E. Long St., Columbus 5.
 Winteradio, Inc., 1468 W. 25th St., Cleveland 13.

OKLAHOMA

Electronic Supply Co., 212 NW Tenth St., Oklahoma City 3.
 Miller Co., Jackson, 111-119 E. California, Oklahoma City.
 Muskogee Electronic Supply Company, 231 Court St., Muskogee.
 Patterson Radio Supply Co., 211 E. 13th St., Tulsa.
 Radio, Inc., 1000 S. Main St., Tulsa 3.
 Radio Supply Inc., 724 N. Hudson St., Oklahoma City.
 S & S Radio Supply, 721 S. Detroit, Tulsa.

OREGON

Appliance Wholesalers, 600 NW 14th St., Portland 9.
Bargelt Supply, 1131-35 SW Washington St., Portland 5.
Carlson, Hatton & Hay, Inc., 96 E. Tenth Ave., Eugene.
Central Distributors, 1131-33 S. W. Washington, Portland 5.
Cressey & Allen, 35 Commercial St., Portland 6.
Harper-Meggee, Inc., 1506 NW Irving, Portland.
Johnson Co., Lou, 422 NW Eighth Ave., Portland.
Northwest Radio Supply Co., Inc., 1717 SW Akeny St., Portland.
Portland Radio Supply Co., 1300 W. Burnside, Portland 9.
Radio Electronics Co., 9th & Commercial, Astoria.
Stubbs Electric Co., 33 NW Park Ave., Portland 9.
Tracey & Co., Inc., 937 NW Glisan, Portland 9.
United Radio Supply Inc., 179 W. 8th St., Eugene.
United Radio Supply, Inc., 22 NW 9th Ave., Portland 9.
Walker Co., Verl G., 305 W. Jackson, Medford.

PENNSYLVANIA

A. C. Radio Supply Co., 1539 W. Passyunk Ave., Philadelphia 45.
A. G. Radio Parts Co., 3515 N. 17th St., Philadelphia 40.
A. G. Radio Parts Co., 628 Schuylkill Ave., Reading.
Allied Electric Appliance Parts Inc., 3640 Elder St., Philadelphia 40.
Almo Radio Co., 412 N. 6th St., Philadelphia 23.
B & R Electric Co., St. Mary's.
Baker Radio Electric, 111 Johns St., Johnstown.
Barbey Co., Geo. D., 29 E. Vine St., Lancaster.
Barbey Co., Geo. D., 111 N. Washington St., Pottstown.
Barbey Co., Geo. D., 2nd & Penn Sts., Reading.
Barnett Bros. Radio Co., 117 N. 7th St., Philadelphia.
Buss Radio Electric Supply, 61-63 E. Broad St., Bethlehem.
Cambria Equipment Co., 12 Iron St., Johnstown.
Cameradio Co., 963 Liberty Ave., Pittsburgh 22.
Capitol Records Inc., Scranton.
Consolidated Radio Co., 612 Arch St., Philadelphia 6.
D & H Distributing Co., 311 S. Cameron St., Harrisburg.
D & H Distributing Co., 251 S. Main St., Wilkes-Barre.
Duncombe Co., J. V., 1011 W. 8th St., Erie.
Emerson Radio of Pa., Inc., 223-225 N. Broad St., Philadelphia 7.
FEDERATED PURCHASER, INC., 115 Hamilton St., Allentown. ADV. PG. 183.
FEDERATED PURCHASER, INC., 701 North Hampton St., Easton. ADV. PG. 183.
Fisher Scientific Co., 711-723 Forbes St., Pittsburgh 19.
General Radio & Electronics, 287 S. Main St., Wilkes-Barre.
Graybar Electric Co., 910 Cherry St., Philadelphia.
Hamburg Bros., 305 Penn Ave., Pittsburgh 22.
Herbach & Rademan, Inc., 1204 Arch St., Philadelphia 7.
Hollenback's Radio Supply, 2221 Eighth Ave., Altoona.
J. R. S. Distributors, 646 W. Market St., York.
Jordan Electronic Co., 1130 German St., Erie.
Kennedy's Radio Supply, 1500 Seventh Ave., Altoona.
Lazar Radio Co., Nat., 4241 Lancaster Ave., Philadelphia 4.
Luckenback & Johnson, Inc., 1034 Chestnut St., Allentown.
M & H Sporting Goods Co., 512 Market St., Philadelphia 6.
Mansfield Co., M. V., 937 Liberty Ave., Pittsburgh.
Marshall Co., John, 201 Anderson St., Pittsburgh.
Moyer Electronic Supply Co., Inc., 330 E. Norwegian St., Pottsville.
Penn Electronics Parts Co., 5303 Frankford Ave., Philadelphia.
Purse, Fred P., 548-550 Wyoming Ave., Scranton 3.
Radio Distributing Co., 915 S. 13 St., Harrisburg.
Radio Electric Serv. Co. of Pa., Inc., 1042 Hamilton St., Allentown.
Radio Electric Service Co. of Pa., Inc., 916 Northampton St., Easton.
Radio Electric Service Co. of Pa., Inc., 3412 Germantown Ave., Philadelphia.
Radio Electric Service Co. of Pa., Inc., 5930 Market St., Philadelphia 43.
Radio Electric Service Co. of Pa., Inc., NW Cor. 7th & Arch Sts., Philadelphia.
Radio Parts Co., 929 Liberty Ave., Pittsburgh.
Radio Parts Co., 47 N. Gallatin Ave., Uniontown.
Radio Service Co., 346 S. Main St., Wilkes-Barre.
Rosen & Co., Raymond, 32nd & Walnut Sts., Philadelphia.
Rumsey Electric Co., 1007 Arch St., Philadelphia.
Scranton Radio & Television Supply Co., 519-521 Mulberry St., Scranton 2.
Scott Co., Charles B., 119 Franklin Ave., Scranton.
Steinberg & Co., Albert, 2520 N. Broad St., Philadelphia 32.
Superior Distributing Co., 5124 Liberty Ave., Pittsburgh 24.
Test Equipment Sales Co., Inc., 1505 Race St., Philadelphia.
Tydings Co., 5800 Baum Blvd., Pittsburgh 6.
Warren Radio, Inc., 1125 State St., Erie.
Wile, R. H., 218 S. 11th St., Philadelphia.
Williamsport Radio Supply, 518 W. Third St., Williamsport 28.
York Radio & Refrigeration Parts, 265 W. Market St., York.
Young Bros. Electronics Inc., 1909-15 Peach St., Erie.
Zimmerman Wholesalers, 55 Morgantown St., Uniontown.

RHODE ISLAND

Dandreta Co., Wm., 129 Regent St., Providence.
DeMambro Radio Supply, Inc., 90 Broadway, Providence.

Eddy & Co., Inc., 43 Hospital St., Providence.
Edwards Co., W. H., 94 Broadway, Providence 3.

SOUTH CAROLINA

Carolina Radio Supply Co., Inc., 227 W. Washington St., Greenville.
Dixie Radio Supply Co., 1700 Laurel St., Columbia.
Dixie Radio Supply Co., 22 Richardson St., Greenville.
Noland Co., Inc., 162 Morgan Ave., Spartanburg.
Radio Laboratories, 215 King St., Charleston.

SOUTH DAKOTA

Burghardt Radio Supply, 12 N. Broadway, NW, Watertown.
Power City Radio Co., 209 S. First Ave., Sioux Falls.
Warren Radio Supply, 115 S. Indiana Ave., Sioux Falls.

TENNESSEE

Bluff City Distributing Co., Inc., 905-7 Union St., Memphis 3.
Bomar Appliance Co., Inc., 520 Western Ave., Knoxville.
Boyd Electronic Supply, 1153 Union Ave., Memphis.
Braid Electric Co., 109 Eleventh Ave., South, Nashville.
Chemcity Radio & Electric Co., 12 Emory Park, Knoxville 17.
Curle Radio Supply, 825 Cherry St., Chattanooga.
Electra Distributing Co., 1914 West End Ave., Nashville 4.
Keith-Simmons Co., Inc., Cummins Station, Nashville.
Lavender Radio Supply Co., Inc., 1012 Union Ave., Memphis.
Lynch & Co., Inc., S. H., 1049 Union, Memphis.
McClung & Co., Inc., C. M., 501 W. Jackson St., Knoxville 7.
McGregor's Inc., 1071 Union Ave., Memphis 3.
Mills-Morris Co., 171-175 S. Ludley St., Memphis 1.
Radio & Appliance Corp., 4 Cummins Station, Nashville 3.
Radio & Appliance Dist., Inc., Corner Main & Broad Sts., Chattanooga.
Radio Electric Supply Co., 210 Cherokee St., Kingsport.
Randolph & Cole Inc., 1516 Church St., Nashville.
Roden Electrical Supply Co., 808 N. Central Ave., Knoxville.
Rush Co., L. K., 206 E. Baltimore St., Jackson.
Specialty Distributing Co., Inc., 709 Chestnut St., Chattanooga.
W & W Distributing Co., 677 Madison Ave., Memphis.

TEXAS

Adleta Co., 1914 Cedar Springs at Akard, Dallas.
All-State Distributing Co., 2407 Ross Ave., Dallas 1.
Amateur Headquarters & Supply Co., PO Box 5086, Beacon Hill Sta., San Antonio.
Automatic Sales Co., 325 M & M Bldg., Houston 2.
Beyer & Co., A. R., 1318 Polk Ave., Houston 2.
Busacker Electronic Equip. Co., 1721 Waugh Drive, Houston.
Clark & Gose Radio Supply, 1204-B Ohio Ave., Wichita Falls.
Crabtree's Wholesale Radio, 2608 Ross Ave., Dallas 1.
Dallas Electric Supply Co., 1800 Magnolia St., Dallas 2.
Denison Radio Supply, 310 W. Woodward, Denison.
Electronic Equipment Co., 301 E. 5th St., Fort Worth.
Electronic Equipment & Engineering Co., 12th & Madison Sts., Brownsville.
Electronic Equipment & Eng. Co., 1310 S. Staples St., Corpus Christi.
Fort Worth Radio Supply Co., 1201 Commerce St., Fort Worth.
Geophysical Supply Co., PO Box 2214, Houston 1.
Hall, Inc., R. C. & L. F., 1219 Caroline Ave., Houston.
Hargis Co., Box 716, Austin.
Hargis Co., Inc., 1205 Washington Ave., Waco.
Harrison Equipment Co., 1422 San Jacinto, Houston.
Houston Radio Supply Co., Inc., Clay at La Branch, Houston.
Lavender Radio Supply Co., 520 E. 4th St., Texarkana.
Lavender Radio Supply Co., 110 Swann St., Tyler.
Lynch & Co., Inc., S. H., 2201-3 Pacific Ave., Dallas.
Lynch & Co., Inc., S. H., 910 Calhoun St., Houston.
Lynch & Co., Inc., S. H., 241 Broadway, San Antonio.
Mission Radio Inc., 814 S. Presa St., PO Box 2487, San Antonio.
Montague Radio Distributing Co., 220 Willow Ave., PO Box 3045, Beaumont.
Mooney Radio Supply Co., 1104 Grace St., Wichita Falls.
R & R Electronic Co., 802-804 N. Walnut, Abilene.
R & R Electronic Co., 416-18 W. Tenth, Amarillo 1.
R & R Supply Co., Inc., 706 Main St., Lubbock.
Radio Parts Co., 902 Crawford, Houston 3.
Ra-Tel, Inc., 2409 Ross Ave., Dallas 1.
Radio & Television Parts Co., 118-120 7th St., San Antonio 2.
Reeves Radio Supply, 720 N. Stanton St., El Paso.
Rio Supply Co., PO Box 168, McAllen.
"Scooter's" Radio Supply, 509-11 Commerce St., Fort Worth.
Shield Co., Inc., 1010 Macon St., Fort Worth.
South Texas Radio Supply, 307 S. Presa St., San Antonio.
Southwest Radio Supply, 1820 N. Harwood St., Dallas.
Standard Radio Supply Inc., 309 Lavaca St., Austin.
Sterling Radio Products Co., 1602 McKinney St., Houston.
Straus-Frank Co., 4000 Leeland, Houston.
Straus-Frank Co., 301 S. Flores St., San Antonio.
Sutton's Wholesale Electronics, Bill, 601 Commerce St., Fort Worth 2.
Wanslow & Co., 912 N. Peak St., Dallas.

West Texas Radio Supply, 1026 West Sixth, Amarillo.
Wicks-DeVilbiss Co., 513-15 S. Staples St., Corpus Christi.
Wilkinson Brothers, 2406 Ross Ave., Dallas.

UTAH

Flint Distributing Co., 316 Second South, PO Box 1470, Salt Lake City 11.
Standard Supply Co., Box 2105, Salt Lake City.

VERMONT

Vermont Hardware Co., Inc., 180 Flynn Ave., Burlington.
Vermont Hardware Co., Main & Bridge Sts., White River Junction.

VIRGINIA

Ashman Distributing Co., 24th & Monticello Ave., Norfolk.
Baker Sales Co., Inc., H. C. 19 Franklin Road, Roanoke.
Bristol Radio Supply Corp., 31 Moore St., Bristol.
Eastern Electric Co., 920 Commerce St., PO Box 943, Lynchburg.
Hartley & Co., M. A., 327 N. Central Ave., Staunton.
J & J Appliance Co., 211 William St., Fredericksburg.
Johnston-Gasser Co., 3023 W. Marshall St., Richmond 21.
Leonard Electronic Supply Co., 131 Center Ave., NW, Roanoke.
Lynchburg Battery & Ignition, 406 Fifth St., Lynchburg.
Noland Co., Inc., 27th St., & Virginia Ave., Newport News.
R & M Radio Co., 2701 Wilson Blvd., Arlington.
Radio Equipment Co., 821 W. 21st St., Norfolk 10.
Radio Parts Distributing Co., 128 W. Olney Rd., Norfolk 10.
Radio Supply, 711 Granby St., Norfolk 10.
Radio Supply Co., 3302 W. Broad St., Richmond 21.
Rucker Radio Wholesalers, 1906 N. Moore St., Arlington.
Winfree Supply Co., 800 W. Cary St., Richmond 21.
Womack Electric & Supply Co., 502-504 Craghead St., Danville.
Wyatt-Cornick Distributors, Inc., 951 W. 21st St., Norfolk.
Wyatt-Cornick Inc., 14th & Grace Sts., Richmond 19.

WASHINGTON

Associated Industries, 1752 Rainier Ave., Seattle 44.
Columbia Electric & Mfg. Co., South 1233 Wall St., Spokane 8.
C & G Radio Supply, 2502 Jefferson Ave., Tacoma 2.
Garrison Radio Supply, Second & Bell Sts., Seattle.
General Radio Inc., 100 Wall St., Seattle 1.
Harper-Meggee, Inc., 960 Republican, Seattle 9.
Harper-Meggee, Inc., 734 N. Division St., Spokane.
Kar Radio & Electric Co., PO Box 676, Walla Walla.
Lay & Nord, 112 S. Second St., Yakima.
Modern Theatre Supply, Inc., 2400 Third Ave., Seattle 1.
Pringle Radio Wholesale Co., 2516 Colby Ave., Everett.
Radio-Electric Supply Co., 2722 Second Ave., Seattle 1.
Radio Products Sales Co., 1214 First Ave., Seattle.
Seattle Radio Supply Inc., 2117 2nd Ave., Seattle 1.
Standard Sales Co., 1219 W. First Ave., Spokane 8.
Stewart Co., A. T., 743 Broadway, Tacoma.
Waitkus Supply Co., 110 Grand Ave., Bellingham.
Washington Distributors, 115 Madison Ave., Seattle.
Western Electronic Supply Co., 2609 First Ave., Seattle 1.
Wible Radio Supply Co., 907 S. Tacoma Ave., Tacoma 3.
Yakima Wholesale Radio Co., 206 S. 8th Ave., Yakima.
Zobrist Co., Herb E., 2125 Westlake Ave., Seattle 1.

WEST VIRGINIA

Chemcity Radio & Elec. Co., PO Box 2066, Charleston.
Electronic Supply Co., 422 11th St., Huntington 1.
King & Irwin, Inc., 314 Eleventh St., Huntington.
Randle & Hornbrook, 536 7th St., Parkersburg.
TV Supply Co., 1226 Third Ave., Huntington 1.
Whithead Radio Co., Inc., 813 Bluefield Ave., Bluefield.

WISCONSIN

Acme Radio Supply Corp., 510 W. State St., Milwaukee 3.
Appleton Radio Supply Co., 1217 N. Richmond St., Appleton.
Central Radio Parts Co., 1723 W. Fond du Lac Ave., Milwaukee 5.
Electro-Pliance Distributors, Inc., 2458 W. Lisbon Ave., Milwaukee 5.
Harris Radio Corp., 115 N. Tenth St., Manitowoc.
Marsh Radio Supply Co., 526 W. State St., Milwaukee 3.
Nesio Electronic Distributors, 308 N. Chestnut St., Green Bay.
Northern Electrical Distributors, 708 S. Broadway Green Bay.
Popkey Co., G. M., Main at Ninth St., Marinette.
Radio Distributors, 701 E. Johnson St., Madison 3.
Radio Parts Co., Inc., 538 W. State St., Milwaukee 3.
Radio Service & Supply Co., Inc., 615 Third St., Wausau.
S. M. Supply Co., 409-11 S. Barstow St., Eau Claire.
Satterfield Radio Supply, 326 W. Gorham St., Madison.
Standard Radio Parts Co., 1244 State St., Racine.
Taylor Electric Co., 112 N. Broadway, Milwaukee 2.
Valley Radio Distributors, 518 N. Appleton St., Appleton.

WYOMING

Casper Supply Co., 444-448 S. Center St., Casper.
Houge Radio & Supply, 2008 Carey Ave., Cheyenne.

KEEP POSTED

on

Electron Tubes



A



B



C



D



E

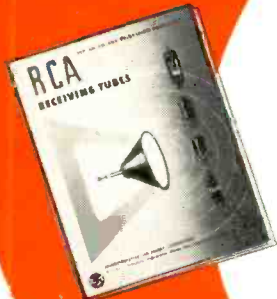

F



G

with the most authoritative technical literature in the field

A Tube Handbook—All Types HB-3 (7 $\frac{3}{8}$ " x 5") The "bible" of the industry—contains over 2500 pages of loose-leaf data and curves on all RCA receiving tubes, power tubes, cathode-ray tubes, phototubes, and special tubes. Three de luxe 4-prong binders imprinted in gold. Available on subscription basis. Price, \$10.00 including service for first year. Write to Commercial Engineering for descriptive folder and order form.

B Receiving Tube Manual—RC-16 (8 $\frac{3}{8}$ " x 5 $\frac{1}{2}$ ")—300 pages. New, completely up-to-date. Covers technical information on more than 460 RCA receiving tubes and kinescopes. Includes an expanded circuit section, enlarged section on resistance-coupled amplifiers, new data on cathode-follower design, and completely revised tube classification charts, including miniature types and their GT equivalents. Features lie-flat binding. Price, 50 cents.

C Radiotron Designer's Handbook—(9" x 6")—356 pages. Edited by F. Langford Smith of Amalgamated Wireless Valve Company Pty. Ltd. in Australia. Of value to anyone interested in fundamental principles of practical circuit design. Copiously illustrated. Price, \$1.25.

D Power and Gas Tubes for Radio and Industry—Bulletin PG-101-A (11" x 8 $\frac{1}{2}$ ")—20 pages. Contains basic data on more than 150 air-and-water-cooled transmitting tubes,

rectifier tubes, thyratrons, ignitrons, and voltage regulators. Features brief descriptions, applications, terminal connection diagrams, and photos of representative types. Price, 15 cents.

E Phototubes, Cathode-Ray and Special Types—Bulletin CRPS-102A (11" x 8 $\frac{1}{2}$ ")—20 pages. Contains basic data on more than 150 single-unit, twin-unit, and multiplier phototubes, cathode-ray tubes, camera tubes, monoscopes and types for special applications. Includes brief descriptions, applications, terminal connections, and photos of many types. Spectral response curves are given for all phototubes. Price, 15 cents.

F Receiving Tubes for AM, FM, and Television Broadcast—Bulletin 1275-E—24 pages. Completely revised and brought up to date. Contains characteristics on more than 450 RCA receiving tubes including kinescopes and a classification chart which lists all types according to function, and groups types having similar characteristics and same cathode voltage. Socket connection diagrams arranged for quick and easy reference. Price, 10 cents.

G Instruction Booklets—Complete authorized information on individual RCA transmitting tubes and other tubes for communications and industry. Be sure to mention tube-type booklet desired. Single copy on any type free on request.

Use this convenient coupon for obtaining the RCA tube literature you need.

RCA, Commercial Engineering
Section 43FX, Harrison, N. J.
Send me the RCA publications checked below. I am enclosing \$..... to cover cost of the books for which there is a charge.

Name _____

Address _____

City _____ Zone _____ State _____

- HB-3 Tube Handbook (\$10)* (A)
- RC-16 Receiving Tube Manual (50 cents) (B)
- Radiotron Designer's Handbook (\$1.25)* (C)
- Power and Gas Tubes for Radio and Industry (15 cents) (D)
- Phototubes, Cathode-Ray and Special Types (15 cents) (E)
- Receiving Tubes for AM, FM, and TV (10 cents) (F)
- Instruction Booklet on tube types.....(Free) (G)

*Prices apply to U.S. and possessions only



RADIO CORPORATION of AMERICA
ELECTRON TUBES

HARRISON, N. J.



L. S. THEES
General Sales Manager



W. L. ROTHENBERGER
Manager,
Sales Operations



M. J. CARROLL
Manager,
Equipment Sales



R. H. SIEMENS
Manager, Receiving
Tube & Kinescope Sales



C. E. BURNETT
Manager,
Industrial Tube Sales



F. B. WILSON
Manager, Electronic
Components Sales



C. W. TAYLOR
Manager, Tube Parts
& Machinery Sales



M. S. GWYNNE
Ass't to
General Sales Manager



D. R. OZSVATH
Ass't to Manager,
Equipment Sales



R. L. KELLY
Manager, Field Appli-
cation Engineering



G. R. RIVERS
Manager,
Government Sales



G. H. MYERS
Manager,
Customer Relations

Headquarters Group

A nation-wide sales and engineering service to solve your tube and component problems

Sales & Engineering Field Force

CENTRAL



L. D. KIMMEL
Field Sales



W. HIEATT
Field Sales



D. R. YODER
Field Sales



J. W. KIRSCHNER
Field Sales



M. E. MARKELL
Field Sales



W. L. HOPKINS
Field Sales



J. F. COOPER
Field Sales



J. T. WILSON
Application
Engineering



T. B. PERKINS
Application
Engineering



T. R. HAYS
Field Sales



H. HAFKER
Application
Engineering



W. POND
Application
Engineering



W. H. WARREN
Application
Engineering



N. F. MACKENZIE
Application
Engineering



G. D. HANCHETT
Application
Engineering



G. W. DUCKWORTH
Application
Engineering



C. P. VOGEL
Application
Engineering



J. H. HALGREN
Application
Engineering

WESTERN



C. R. KLINGER
Field Sales



B. WALLEY
Application
Engineering



W. ROBINSON
Application
Engineering

At your service — *when* and *where* you want them — these seasoned experts devote their time exclusively to the problems of equipment manufacturers and government agencies.

In addition, the service of three completely equipped application engineering laboratories, in Harrison, N. J., Lancaster, Pa., and Chicago, Ill., are at the disposal of all RCA tube and component customers. Through these laboratory facilities, equipment manufacturers can avail themselves of RCA's extensive engineering skills and tube and component experience.

RCA maintains conveniently located district offices in Harrison, Chicago, and Los Angeles. To put RCA's sales and engineering organization to work for you, phone the nearest office* . . . or write RCA, Commercial Engineering, Section 43FR, Harrison, New Jersey.

* (EAST) Harrison 6-8000, 415 S. 5th St., Harrison, N. J. (MIDWEST) Whitehall 4-2900, 589 E. Illinois St., Chicago, Ill. (WEST) Trinity 5641, 420 S. San Pedro St., Los Angeles, Calif.

Special Field Sales & Engineering Force



J. H. MOSHER
Field Sales



R. F. DUNN
Application
Engineering



M. COPAN
Field Sales



J. WACHTEL
Application
Engineering



L. T. WEAGLE
Tube Parts &
Machinery Sales



R. E. NELSON
Field Sales, Gov't



W. D. LEAHY
Field Sales, Gov't



M. SPIVACK
Field Sales, Gov't



RADIO CORPORATION of AMERICA
ELECTRON TUBES
HARRISON, N. J.